

ALESIS QSR

Reference Manual

Introduction

Thank you for purchasing the Alesis QSR 64 Voice Expandable Synthesizer Module. To take full advantage of the QSR's functions, and to enjoy long and trouble-free use, please read this user's manual carefully.

How To Use This Manual

This manual is divided into the following sections describing the various modes of the QSR. To get the most out of your QSR, read the entire manual once, then use the table of contents and index to reference specific functions while using the instrument.

Chapter 1: Setting Up. Deals with the necessary preparation before playing, including connections to external devices.

Chapter 2: Your First Session. This section provides a brief tour of the QSR, shows you how to audition the various sounds of the QSR, and points out the various performance features.

Chapter 3: Connections. Details rear panel connections (like MIDI, footpedals and the serial interface), proper hook-up procedures, plus application examples.

Chapter 4: Overview. Covers the structure of sound sources within the QSR, how to read and navigate through the LCD display pages, how to edit parameters, and how to store edited Programs and Mixes.

Chapter 5: Editing Mixes. Explains how to create and edit Mixes.

Chapter 6: Editing Programs. How to create and edit Programs.

Chapter 7: Editing Effects. How to create and edit Effects Patches.

Chapter 8: Global Settings. Describes all global functions, such as Master Tuning and Program Change Mode.

Chapter 9: MIDI Transfer and Storage Operations. Discusses MIDI functions and how to store sounds either to a MIDI device or to a RAM card.

Appendices. MIDI basics, trouble-shooting, maintenance and service information, MIDI Implementation Chart and an Index.

Conventions

The buttons, knobs, and rear panel connectors and switches are referred to in this manual just as their names appear on the QSR, using all capital letters and in brackets (*Example:* [PROG] button, [◀ CURSOR] and [CURSOR ▶] buttons, [VALUE] knob, etc.).



When something important appears in the manual, an icon (like the one on the left) will appear in the left margin. This symbol indicates that this information is vital when operating the QSR.

Mac™, MacOS™ and Macintosh™ are registered trademarks of Apple Corporation.

CONTENTS

1: Setting Up	7
Unpacking and Inspection	7
AC Power	7
Line Conditioners and Protectors	7
Basic Audio Hookup	8
About Audio Cables.....	9
2: Your First Session	11
Powering Up	11
Playing the Demo Sequences.....	11
What's a Program?.....	11
What's a Mix?	12
What's a Bank?.....	12
About Sound Groups	13
Playing the QSR.....	13
Program Mode and Mix Mode.....	13
Auditioning Internal Programs.....	14
Selecting Program Banks.....	14
Selecting the MIDI Channel in Program Mode.....	14
Realtime Performance Functions	15
Auditioning Mix Play Mode	16
Selecting Mix Banks.....	16
Choosing Programs in a Mix	17
Storing an Edited Mix	18
Enabling General MIDI Mode	18
Using the PCMCIA Expansion Card Slots	19
A Word About the QS CD-ROM.....	20
Sound Bridge™	20
3: Connections	21
Basic MIDI Hookup	21
Using an External Sequencer	22
Using a Computer.....	23
IBM® PCs and compatibles.....	24
Macintosh™	24
Digital Audio/Optical Hookup	25
Recording Digital Audio	25
48 KHz In.....	26
4: Overview	27
Basic Architecture	27
QS Polyphony.....	27
Modes.....	28
Program Play Mode.....	28
Mix Play Mode	28
Program Edit Mode	28
Mix Edit Mode.....	29
Effects Edit Mode.....	29
Global Edit Mode.....	29
Store Mode	29
Compare Mode.....	29
The User Interface: Display, Functions, Pages and Parameters.....	30
About the Display.....	30

MIDI CH Buttons	32
Editing Values	32
Parameter Editing Overview	32
Comparing Edited and Stored Versions.....	33
Preset Memory and User Memory	33
Storing.....	34
Store a Program or Mix.....	34
To Audition Programs Before Storing	35
Copying Sounds Between Programs.....	37
Copying Effects Between Programs.....	37
Initializing the Program/Mix Buffers	38
Initializing Sounds.....	38
5: Editing Mixes	39
What is a Mix?	39
Program Assign for each MIDI Channel	39
Mix Edit Mode.....	39
Understanding the Edit Buffers	40
Level Setting for Each Program.....	41
Pitch.....	42
Effect.....	42
Keyboard/MIDI.....	42
Controllers.....	43
Transmitting MIDI Volume and Panning	43
Setting the Range and MIDI Switches.....	44
Naming a Mix.....	44
Polyphony in Mix Play Mode.....	45
Playing a Group of Channels in a Mix.....	45
6: Editing Programs	47
Overview	47
The "Normalized" Synth Voice.....	47
How the QSR Generates Sound	48
Program Sound Layers	48
QSR Signal Flow.....	49
The Four Sounds of a Program.....	49
Voice.....	50
Lowpass Filter	50
Amp.....	51
About Modulation	51
LFO (Low Frequency Oscillator).....	52
Envelopes	52
About Signal Processing.....	52
Drum Mode.....	53
Program Edit Functions.....	54
Voice	54
Level	57
Pitch.....	58
Filter.....	60
Amp/Range.....	62
Pitch Envelope.....	65
Filter Envelope.....	68
Amp Envelope.....	70
Name	72
Mod 1 - Mod 6	73
Pitch LFO.....	76
Filter LFO.....	78
Amp LFO.....	79
Tracking Generator.....	80

Programming Drum Sounds	82
Voice	82
Level	83
Pitch	83
Filter	83
Amp/Range	84
Amp Envelope	84
Copying Sounds	85
Copying Effects	85
7: Editing Effects	87
About Signal Processing	87
Selecting an Effects Patch in Mix Mode	88
Setting Effects Send Levels	88
Clip	89
Editing Effects	89
Navigating	89
Storing Effect Patches In Program Mode	90
Storing Effect Patches in Mix Mode	90
Copying Effect Patches	90
Configurations	91
EQ	98
Mod	98
Lezlie	100
Mod	101
Delay	105
Reverb	106
Overdrive	110
Mix	111
8: Global Settings	113
Editing Global Parameters	113
Master Pitch	113
Master Tune	113
General MIDI	113
Enabling General MIDI Mode via MIDI	114
Controllers A – D Assignment	114
Pedals 1 and 2 Assignment	114
Using a Pedal to Control Volume or Modulation	114
MIDI Program Select	115
Receiving/Transmitting Bank Change Messages	115
Input/Output Mode	116
MIDI Out	117
MIDI Group Channel	117
Clock	118

9: MIDI Transfer And Storage Operations.....	119
Using PCMCIA Expansion Cards.....	119
Saving the User Bank to a PCMCIA Card.....	119
Loading a Bank from an External Card.....	120
Storing an Individual Program or Mix.....	120
Loading an Individual Program or Mix.....	121
Card Storage RAMifications.....	121
Saving Programs via MIDI Sys Ex.....	122
Appendix A: Trouble-Shooting	125
Trouble-Shooting Index.....	125
Re-initializing.....	125
Checking Software Version.....	126
Maintenance/Service.....	126
Cleaning.....	126
Obtaining Repair Service.....	126
Appendix B: MIDI Supplement.....	129
MIDI Basics.....	129
MIDI Hardware.....	129
MIDI Message Basics.....	130
Channel Messages: Mode Messages.....	130
Channel Messages: Voice Messages.....	130
System Common Messages.....	132
General MIDI.....	132
Appendix C: MIDI IMPLEMENTATION CHART	134
Appendix D: Parameters Index.....	135
Program Edit Parameters.....	135
Mix Edit Parameters.....	137
INDEX.....	138

CHAPTER 1

SETTING UP

UNPACKING AND INSPECTION

Your QSR synthesizer module was packed carefully at the factory. The shipping carton was designed to protect the unit during shipping. Please retain this container in the highly unlikely event that you need to return the QSR for servicing.

The shipping carton should contain the following items:

- QSR with the same serial number as shown on shipping carton
- AC Power Supply
- Computer CD-ROM containing software
- This instruction manual, plus lists of Mixes and Programs, and Quick Start guide
- Alesis warranty card



It is important to register your purchase; if you have not already filled out your warranty card and mailed it back to Alesis, please take the time to do so now.

AC POWER HOOKUP

The QSR works with the voltage of the country it is shipped to (either 110 or 220V, 50 or 60 Hz), and comes with a line cord or power supply suitable for the destination to which the keyboard is shipped. With the QSR off, plug the small end of the power adapter cord into the QSR's [POWER] socket and the male (plug) end into a source of AC power. It's good practice to not turn the QSR on until all other cables are hooked up.



Alesis cannot be responsible for problems caused by using the QSR or any associated equipment with improper AC wiring.

LINE CONDITIONERS AND PROTECTORS

Although the QSR is designed to tolerate typical voltage variations, in today's world the voltage coming from the AC line may contain spikes or transients that can possibly stress your gear and, over time, cause a failure. There are three main ways to protect against this, listed in ascending order of cost and complexity:

- Line spike/surge protectors. Relatively inexpensive, these are designed to protect against strong surges and spikes, acting somewhat like fuses in that they need to be replaced if they've been hit by an extremely strong spike.
- Line filters. These generally combine spike/surge protection with filters that remove some line noise (dimmer hash, transients from other appliances, etc.).
- Uninterruptible power supply (UPS). This is the most sophisticated option. A UPS provides power even if the AC power line fails completely. Intended for computer applications, a UPS allows you to complete an orderly shutdown of a computer system in the event of a power outage, and the isolation it provides from the power line minimizes all forms of interference—spikes, noise, etc.

BASIC AUDIO HOOKUP



When connecting audio cables and/or turning power on and off, make sure that all devices in your system are turned off and the volume controls are turned down.

Because the QSR includes extensive signal processing as well as a full complement of sounds, you can make great sounds with nothing more than an amplifier or a set of headphones. The QSR has two Main outputs, two Aux outputs, plus a stereo headphones output. These can provide an amplification system or mixer with several hookup options:

- **Mono.** Connect a mono cord from either MAIN output jack to a mono amplification system or individual mixer input.
- **Stereo.** Connect two mono cords from the [L] and [R] MAIN output jacks to a stereo amplification system or two mixer inputs.
- **Dual Stereo/Four Individual Outs.** Connect two mono cords from the [L] and [R] MAIN output jacks and two mono cords from the [L] and [R] AUX output jacks to a dual stereo amplification system, or four mixer inputs.
- **Stereo Headphones.** Plug a set of high-quality stereo headphones into the headphones [PHONES] jack on the front panel.

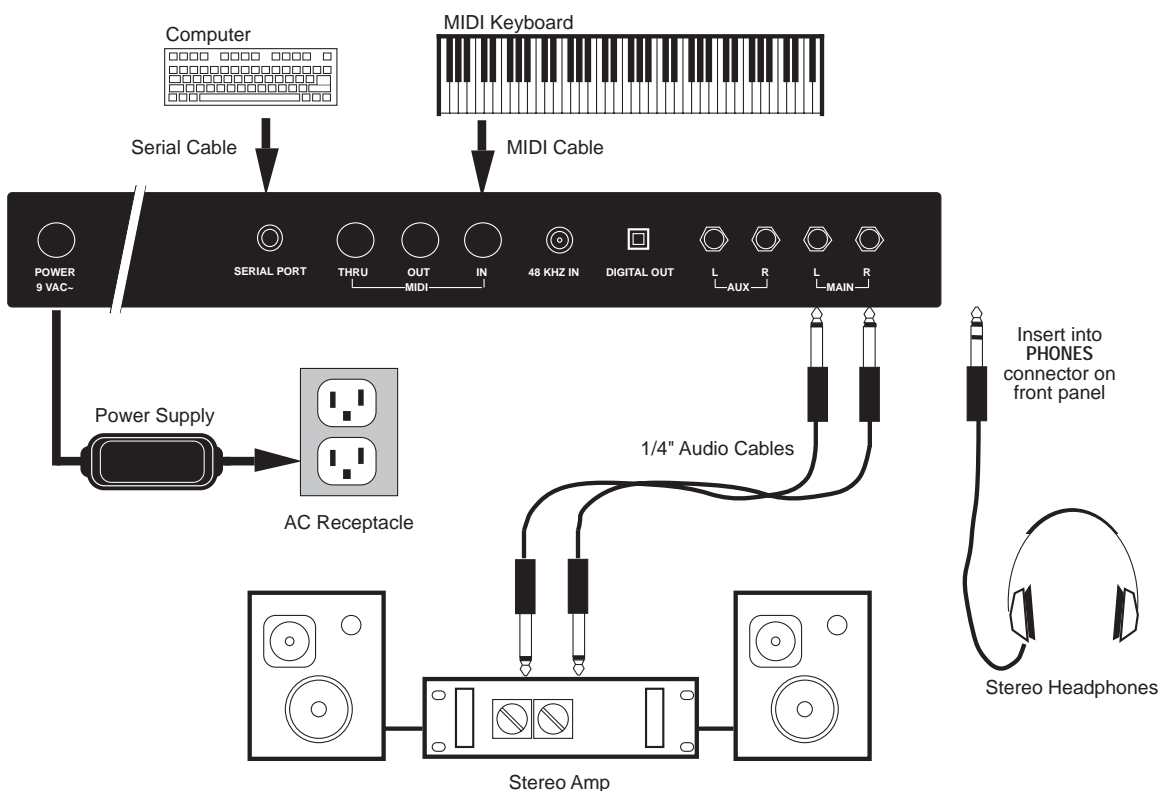

ABOUT AUDIO CABLES

The connections between the QSR and your studio are your music's lifeline, so use only high quality cables. These should be low-capacitance shielded cables with a stranded (not solid) internal conductor and a low-resistance shield. Although quality cables cost more, they do make a difference. Route cables to the QSR correctly by observing the following precautions:

- Do not bundle audio cables with AC power cords.
- Avoid running audio cables near sources of electromagnetic interference such as transformers (such as the QSR's Power Supply), monitors, computers, etc.
- Do not place cables where they can be stepped on. Stepping on a cable may not cause immediate damage, but it can compress the insulation between the center conductor and shield (degrading performance) or reduce the cable's reliability.
- Avoid twisting the cable or having it make sharp, right angle turns.
- Never unplug a cable by pulling on the wire itself. Always unplug by firmly grasping the body of the plug and pulling directly outward.

CHAPTER 2

YOUR FIRST SESSION

POWERING UP

After making your connections, turn on the system's power using this procedure:

- ① Before turning on the QSR's power, check the following items:
 - Have all connections been made correctly?
 - Are the volume controls of the amplifier or mixer turned down?
 - Is the volume of the QSR turned down?
- ② Turn on the [POWER] switch on the QSR front panel.
Upon power-up, the QSR will display the last selected Program or Mix. If this Program/Mix has been edited, the display will indicate this by showing an "⌘" to the left of the name of the Program or Mix.
- ③ Press [PROG] to select Program Play Mode.
The display should look something like this:

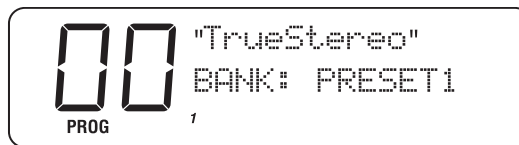

- ④ Raise the QSR's master [VOLUME] knob to maximum.
The best signal-to-noise ratio is achieved when [VOLUME] is set to maximum.
- ⑤ Turn on the power of the amplifier/mixer, and adjust the volume.

PLAYING THE DEMO SEQUENCES

The QSR has built-in demo sequences which demonstrate the wide variety of sounds this amazing instrument is capable of generating. To get the full effect, connect both the [LEFT] and [RIGHT] outputs to your sound system, or listen on headphones.

To play the demo sequence:

- ① Hold the [MIX] button, and press BANK SELECT [UP].
The display will read: Play Autodemo 1 <STORE>
- ② Turn the [VALUE] knob to select one of the built-in demo songs.
- ③ Press [STORE] to start the demo.
- ④ Press [MIX] to stop the demo.
There will be no MIDI out messages during the demo.

WHAT'S A PROGRAM?

A *Program* is a stored configuration of parameters which emulates the sound of an instrument or sound effect, such as a piano or synthesizer or drum set. A QSR Program is made up of hundreds of parameters which, when set to specific values, create a specific type of sound. This setup of parameters can be stored so that you can

get back to it instantly at the touch of a button. When you select a Program, all of its parameter settings are recalled to recreate the original sound.

The QSR provides 640 internal Programs, divided into 5 Banks of 128 Programs each. More Programs can be added by inserting a Sound Card into the Sound Card slot on the front panel of the QSR. Each Bank is broken down into 12 Sound Groups of 10 Programs each, plus a 13th Sound Group with 8 Programs. These group together similar sounding Programs, such as pianos, guitars, bass and drums.

A Program may have from 1 to 4 different sounds which can be combined in a variety of ways to create the overall sound of the instrument the Program is intended to emulate. These four sounds can be layered on top of one another, or split up into different sections of the keyboard. You can even have different sounds played depending on how hard you play the keyboard (this is known as velocity).

WHAT'S A MIX?

A *Mix* is a combination of 1 to 16 Programs. These Programs can be combined in many ways. The most common is *multi-timbral* when connected to a MIDI sequencer, which means that for each MIDI channel the QSR receives (up to 16), a different Program may be selected, thus creating anything from a small pop/rock ensemble to a complete orchestra. Another way of using a Mix is by layering two or more Programs together, so that they play simultaneously from your MIDI controller. You can also create a *split*, where one Program is in the lower half of your keyboard, while another is at the top half; and these programs can even overlap in the middle.

WHAT'S A BANK?

A Bank is a collection of 128 Programs and 100 Mixes. There are five internal banks available at any time, with more if a card is in the Sound Card slot. The current bank is shown on the top line of the display, and will cycle in the following order:

USER	PRESET1	PRESET3	PRESET2	GenMIDI
...and optionally ...		CARD A-1	CARD A-2, etc.	

Each bank contains its own unique Programs and Mixes. Program 10 in Preset Bank 1 is different from Program 10 in Preset Bank 3, although they can be (and are usually) related sounds. A Mix may contain Programs from any bank.

The BANK SELECT [UP] and [DOWN] buttons change the current bank from the front panel, and MIDI Bank Select commands may also be used to select any of the 640 Programs on board, or additional card programs.

Preset and General MIDI banks are permanently "burned in" at the factory. User banks, and Card banks from an SRAM card, may be changed by the user. If you edit a Preset Program or Mix, it can be saved to a User or SRAM card bank only.

ABOUT SOUND GROUPS

Preset Banks 1-3 and the User bank are organized into 13 Groups of 10 Sounds each (Programs 00-09 are pianos, 50-59 are basses, and so on). The GenMIDI bank, however, does not follow this arrangement; it follows the Program list of the General MIDI standard. Programs on some sound cards may not follow that arrangement either, depending on the card type.

PLAYING THE QSR

The QSR is shipped from the factory with 5 Banks of 128 Preset Programs (sounds) each. Additionally, there are 100 Mixes in each of the 5 Banks.

PROGRAM MODE AND MIX MODE

The QSR is always in one of two modes: *Program Mode* or *Mix Mode*. When you are auditioning Programs, you will be in Program Play Mode. When you are auditioning Mixes, you will be in Mix Play Mode.



If you ever get lost, press either [PROG] or [MIX] to get back to their respective Play Mode.

- Press the [PROG] button to select Program Play Mode.
In Program Play Mode, the QSR plays a single Program. The display looks like this:

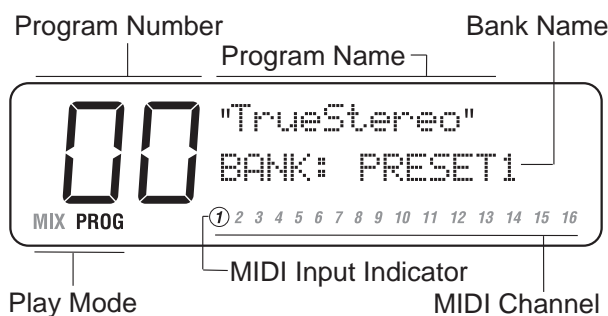

The current mode (PROG) is displayed in the bottom-left corner. The current Program number (00) is directly above. To its right can be found the Program's name (TrueStereo) and the currently selected Bank name (PRESET1). The current MIDI channel appears below the Bank name.

- Press the [MIX] button to select Mix Play Mode.
In Mix Play Mode, the QSR can combine up to 16 Programs for stacking sounds together, splitting the keyboard into different regions, or working with a MIDI sequencer. The display will look something like this:



The current mode (MIX) is displayed in the bottom-left corner. The current Mix number (01) is directly above. To its right can be found the Mix's name (Grandesign) and the currently selected Bank name (PRESET1). The Active MIDI Channels (1, 2 and 3) are shown at the bottom. In a Mix that uses all 16 MIDI channels (such as the Mixes found in the General MIDI Bank), the display would light up all 16 MIDI channel indicators.

AUDITIONING INTERNAL PROGRAMS

- ① Press the [PROG] button to select Program Play Mode.
The [PROG] button and the PROG indicator in the display will light. You can now play the QSR from an external MIDI keyboard; the Program will be whatever was selected when last in Program mode (Program number 00 –127).
- ② Select a Program using the [VALUE] knob.
The large number in the upper-left section of the display will indicate the currently selected Program number. When you scroll past 127, the counter will “roll-over” to Program 00 of the following Bank. Likewise, if you scroll back before 00, it will roll back to Program 127 of the preceding Bank.



SELECTING PROGRAM BANKS

The QSR provides five internal Banks containing 128 Programs in each (and 100 Mixes each, but we'll get to Mixes in a moment). The currently selected Bank will be shown in the upper line of the display, just above the currently selected Program's name.

- Use the BANK SELECT [DOWN] and [UP] buttons to select a Bank (User, Preset 1 – 3, GenMIDI or any Card Banks, if present).
User and Preset Banks are described in detail in Chapter 4.

SELECTING THE MIDI CHANNEL IN PROGRAM MODE

While in Program Play Mode (press [PROG]), the QSR can receive information on any single MIDI channel of the 16 available channels. The currently selected channel appears in the bottom-right section of the display (take a look at the first display example on the previous page).

- ① Use the [ MIDI CH ] buttons to select a MIDI channel from 1 – 16.
The display will change to indicate the currently selected MIDI channel.

REALTIME PERFORMANCE FUNCTIONS

The QSR provides various ways to control the sound as you are playing. Try out some of these functions while playing your MIDI keyboard. The sound of the effects can also change by using these controllers. The effect of these realtime controllers varies from Program to Program; in some they may not be active, and in others they may have a dramatic effect.

- **Velocity.** The volume and tonal quality of the sound will change according to how hard you play the keyboard.
- **Aftertouch.** The action of pressing a key down after playing it is called “aftertouch” (it is also sometimes referred to as “Pressure” since it corresponds to the amount of pressure being applied to the keyboard). Pitch, tone and volume (among other things) can be changed using aftertouch.
- **Pitch Bend Wheel.** While playing a note, you can move the PITCH BEND WHEEL of your keyboard up to raise the pitch, or down to lower the pitch. The amount of pitch bend available can be different for each Program.
- **Modulation Wheel.** By raising the MODULATION WHEEL of your keyboard, you can add expressive modulation effects (such as vibrato or tremolo) while you play. The type of modulation effect can be different for each Program.
- **Controllers A–D.** The QSR provides four global controllers, called Controllers A through D, which allow control over various parameters of a Program. These Controllers are defined in Global Edit Mode (Pages 4 through 7) to respond to specific MIDI controller messages. Many of the QSR’s internal Programs use Controllers A–D to provide control over their tonal aspects. When auditioning Programs, move the CONTROLLER [A]–[D] sliders up and down to find out what effect each has; they will be different from Program to Program.

Further expressive control is available with a pedal switch or expression pedal. By using a sustain pedal connected to your master MIDI keyboard, you can have the sound sustain even after you release the keys. By connecting an expression pedal to your master MIDI keyboard,, you can use the pedal to change the volume or tone (or some other quality such as reverb depth or vibrato speed) of the sound, if the Program is edited to use the pedal(s).

AUDITIONING MIX PLAY MODE

Mix Play Mode allows you to assign a Program to each of the 16 MIDI channels. This makes it easy to create multitimbral setups for use with an external MIDI sequencer. Additionally, a MIX can be used to “layer” sounds together, or “split” your keyboard in a number of ways, or any combination of these. There are many different ways to program a Mix. For more about Mix Play Mode, refer to Chapter 5. For more about connecting the QSR to a MIDI sequencer, see Chapter 3.

- ① Press the [MIX] button.
The [MIX] button and the MIX indicator in the display will light. The Mix will be whatever was selected when last in Mix mode (Mix number 00 – 99).
- ② Select a Mix using the [VALUE] knob.
The large number in the upper-left section of the display will indicate the currently selected Mix number. When you scroll past 99, the counter will “roll-over” to Mix 00 of the following Bank. Likewise, if you scroll back before 00, it will roll back to Mix 99 of the preceding Bank.

SELECTING MIX BANKS

The QSR provides five internal Banks containing 100 Mixes in each. The currently selected Bank will be shown in the display just below the name of the currently selected Mix’s name.

- Use the BANK SELECT [DOWN] and [UP] buttons to select a Bank (User, Preset 1 – 3, GenMIDI or any Card Banks, if present).
User and Preset Banks are described in detail in Chapter 4.

CHOOSING PROGRAMS IN A MIX

In this section, we will choose Programs for the 16 channels in a Mix, for playing back tracks from a MIDI sequencer. There are many other aspects of a Mix we may wish to edit, however. Refer to Chapter 5 for more information about Mix editing.

You do not have to access Mix Edit Mode to select Programs for a Mix (i.e. you don't have to press the [EDIT SELECT] button). Instead, you simply use a two step process:

- A) Use the [◀ MIDI ▶] buttons to select one of the 16 channels in the Mix.
- B) Use the [VALUE] knob to choose a Program for the selected channel.

Here's the process broken down into simpler steps:

- ① Press [MIX] and select **Mix 01** from the **Preset 1** Bank using the method described on page 16.
- ② Press [◀ MIDI ▶].
The display will look like this:

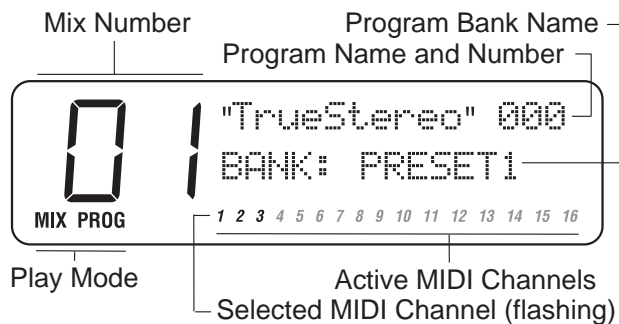

The [◀ MIDI ▶] buttons are used to select one of the 16 channels in the Mix. The actual channel number will be whatever channel was last selected. In the illustration above, channel 1 is shown flashing. If the channel 1 number in your display is not flashing, Use the [◀ MIDI ▶] buttons to select channel 1.

- ③ Use the BANK SELECT [UP] and [DOWN] buttons to select a Program Bank.
- ④ Use the [VALUE] knob to select a Program.
- ⑤ Press [MIDI ▶] to select to the next channel up.
If channel 1 had been selected, pressing [MIDI ▶] will select channel 2. The channel 2 number will flash in the display.
- ⑥ Repeat steps ③ – ⑤ as needed to select Programs for the remaining channels.



Changes you make to a Mix are temporary and will be lost if another Mix is selected. To make changes permanent, you must store the Mix into the User bank (see next page).

STORING AN EDITED MIX

Once you have made changes to a Mix, you will need to store the Mix into the User Bank; that is, if you want to keep the changes you have made. The User Bank is designed to hold up to 100 (00 – 99) of your custom-made Mixes. Whenever you store an edited Mix, the User Bank is automatically selected. All you have to do is select a Program location (00 – 127) within the User Bank to store the edited Mix into. However, if an SRAM Sound Card is inserted into the Sound Card Slot on the rear panel of the QSR, you may select any of the available Banks on the Sound Card to save the edited Mix into.

- ① Press [STORE].

This selects Store Mode. The [STORE] button will flash, and the display will look like this:

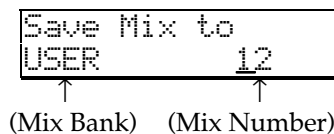

The Mix Number will be identical to the last Mix number selected.

- ② *Optional:* If a Sound Card is inserted, Use the BANK SELECT [UP] button to select a Bank on the Sound Card.
- ③ Use the [VALUE] knob to select a Mix location (00 – 99) within the selected Bank.
- ④ Press [STORE] to save the Mix into the selected location.
The Mix has now been stored, and the display will revert back to whatever was shown before [STORE] was pressed the first time.

NOTE: Pressing [MIX] before pressing [STORE] the second time (step ④) will cause the QSR to exit Store mode without saving changes to the edited Mix.

ENABLING GENERAL MIDI MODE

If you are using a General MIDI sequencer, and/or playing a sequence that is programmed to take advantage of General MIDI, turn the “General MIDI” function in the QSR on.

- ① Press [EDIT], then press BANK SELECT [UP] (also labeled as [GLOBAL]).
The display will now be in Global Edit Mode.
- ② Turn the [VALUE] knob to select page 3 (the page number appears in the upper-right corner of the display).
- ③ Press the [CURSOR ] button.
This selects the General MIDI parameter in the display.
- ④ Turn the [VALUE] knob clockwise.
This turns on General MIDI mode, and automatically puts you into Mix Play Mode with Mix 00 of Preset Bank 4 selected.

For more information about General MIDI, refer to the MIDI Supplement in Appendix B.

USING THE PCMCIA EXPANSION CARD SLOTS

Your QSR is an expandable system using the two PCMCIA EXPANSION CARD slots on the front panel. There are three different kinds of Sound Cards available through your Alesis dealer or directly from Alesis:

- **SRAM cards:** The Alesis Virtual Composer card provides an additional four banks of Program/Mix memory. All banks can be stored to by the user, and it comes with additional Programs and Mixes pre-stored.
- **QCards:** These read-only memory cards provide actual samples, plus the Programs and Mixes that use them in a single card bank. Available QCards include a Stereo Grand Piano card, a Sanctuary card that includes high-quality voice, bell, and organ sounds, a World/Ethnic card, Rap/Techno/Dance cards, Vintage Keyboards, and many more.
- **Flash RAM cards:** If you want to burn your own custom sample cards, Flash RAM cards are available in 2 MB, 4 MB, and 8MB sizes. Alesis Sound Bridge software (see next section) will translate from Sample Cell, AIFF, WAV and other formats to Alesis QSR Composite Synthesis format, and then you can write your own custom Programs and Mixes that use these samples.

To use a sound card with the QSR:

- ① Hold the card with the front label facing up and insert the exposed contact end gently into either of the QSR's PCMCIA EXPANSION CARD slots, [A] or [B].
- ② Push the card in until you the slot's eject button extends outward, and the card will not go any further.
- ③ To remove the card, press the eject button adjacent to the card slot and gently slide the card out of the slot.

The QSR's two PCMCIA EXPANSION CARD slots can accommodate any combination of these three card types. You can combine QCards and Flash RAM cards that store up to 8 MB of samples each, giving you a total of 16 Mb of sound ROM expansion and effectively doubling the internal 16 MB of sound ROM for a total of 32MB!!

When storing Mix and Program Banks to external cards, the maximum number of accessible card banks is 11. This is because the QSR's grand total of banks possible is 16, and 5 of them are already built into the QSR. The 11 card banks can be split among the two PCMCIA EXPANSION CARD slots. Under normal situations, this will not be a limitation (remember, each bank has 128 Programs and 100 Mixes; 11 banks gives you 1408 additional Programs and 1100 additional Mixes).

In other words, if you have two SRAM cards (256k each, capable of storing up to 4 banks), you will have 4 banks available on each card for a total of 8 banks; well below the maximum. However, since it is possible to purchase third-party 512k PCMCIA cards and burn these yourself using Sound Bridge software, it is possible to physically insert two 8 bank cards which combine for a total of 16 banks. In this situation, only the first 11 banks will be accessible beginning with slot [A]; i.e. you'll be able to access all 8 banks from the card in slot [A] and the first 3 banks from the card in slot [B].



If an internal Program uses one or more Sounds that reside on a sound card, the sound card must be inserted into the same PCMCIA EXPANSION CARD slot, [A] or [B], as when the Program was stored. In other words, if a Program uses a Sound found on the card currently inserted in slot [A], then the same card must be inserted into slot [A] for that sound to be used when this Program is recalled. Although the card can physically be used in either slot, once a Program is stored using a Sound on a card it expects to find that card in the identical slot it was in when the Program was stored. The same is true when a Program residing on the card in slot [A] uses a Sound stored on card [B], or vice-versa.



If an internal Mix uses one or more Programs that reside on a sound card, the sound card must be inserted into the same PCMCIA EXPANSION CARD slot, [A] or [B], as when the Mix was stored. The same is true when a Mix residing on the card in slot [A] uses a Program stored on card [B], or vice-versa.

A WORD ABOUT THE QSR CD-ROM

Included with the QSR is a CD-ROM containing various useful software programs to use with your QSR. These include various Alesis and third-party programs, QSR sounds and samples, sequences stored in the MIDI Song File (SMF) format, plus demonstration software we thought you would find interesting. Most of these programs are provided in both Macintosh™ and IBM® PC formats.

SOUND BRIDGE™

Among the files contained on the CD-ROM is a software program called Sound Bridge™. Sound Bridge is a sound development utility which compiles custom samples from a variety of sources into the QS Synthesis Voice format, and downloads the compiled data to an Alesis PCMCIA Flash RAM Sound Card via MIDI Sysex to a QSR, QS8, QS7 or QS6. Sound Bridge allows individuals and sound developers to make their own Sound Cards, using whatever samples they want. Sound Bridge makes this possible without having a PCMCIA card burner attached to your computer. All you need is at least one QS-series synth (such as the QSR, QS7 or QS8).

Sound Bridge creates a QS Voice (multi-sample) by loading Digidesign Sample Cell I or Sample Cell™ II format Instrument files. Using this format, Sound Bridge is able to determine key group and velocity group split points, root notes, sample playback rates, tunings, start points, loop points, and loop tunings. Sound Bridge can also create QS Voices without Sample Cell Instruments by loading single AIFF, Sound Designer™ and Sound Designer II files, MacOS™ System Sounds and PC WAV files.

Sound Bridge does NOT require Sample Cell hardware. The Sample Cell Instrument file, or sample file, may be loaded directly into Sound Bridge from any disk (i.e. CD-ROM, floppy disk, hard disk, etc.). For example, a user may load data from a Sample Cell CD-ROM, and send this data to the QuadraSynth PCMCIA Card, without ever using Sample Cell!

The Sound Bridge folder on the CD-ROM contains the Sound Bridge application, and an electronic manual which will give you all the information you need to know to run Sound Bridge.

CHAPTER 3

CONNECTIONS

BASIC MIDI HOOKUP

MIDI is an internationally-accepted protocol that allows musical-related data to be conveyed from one device to another. See the MIDI Supplement in Appendix B if you are not familiar with how MIDI works.

The QSR has three MIDI connectors which provide the following functions:

- **MIDI IN** This port is for receiving MIDI information (notes, program changes, etc.) from a source such as another QSR, MIDI keyboard, controller, or computer.
- **MIDI OUT** This port is for transmitting MIDI SYSEX information to another MIDI keyboard, sound module, or computer.
- **MIDI THRU** This port is for passing on (echoing) MIDI information received by the MIDI IN port. In simple MIDI setups, the THRU port is used to connect additional devices that will all be “listening” to the same source.

To play the QSR from a MIDI control device (keyboard, drum pad, guitar or bass controller, sequencer, etc.), connect the control device’s MIDI OUT to the QSR’s [MIDI IN]. The illustration below depicts a master QSR connected to a slave QSR. When both are set to a common MIDI channel (see page 14), you can hear both when playing the master keyboard.

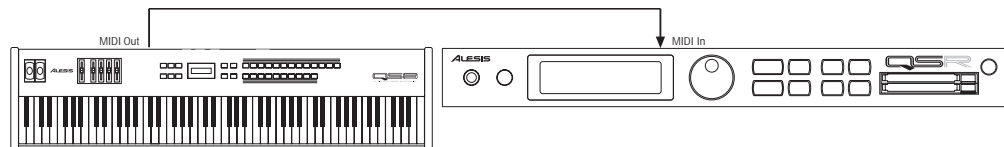

If you are using the QSR in the middle of the MIDI chain (example: as the second unit of a three device chain), connect the QSR’s [MIDI THRU] to the third device’s MIDI IN connector in order to route the first device’s MIDI out information to the third device.

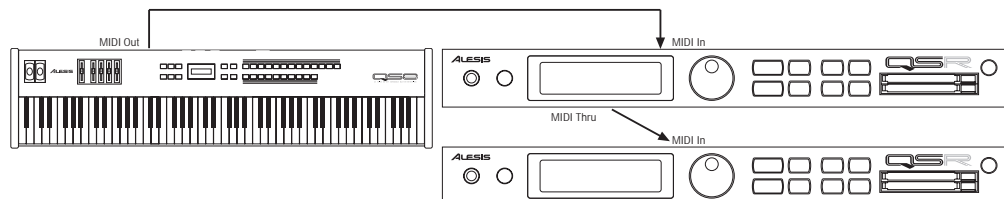

The QSR’s [MIDI OUT] connector sends *System Exclusive* data (see the MIDI supplement) to a storage device for later recall, or to another QSR. When the [MIDI OUT] connector’s mode is switched to “Thru” (Global Edit mode, page 12), it can function as a second [MIDI THRU] connector and resend MIDI data received on the [MIDI IN] from the controller to other MIDI devices.

USING AN EXTERNAL SEQUENCER

The MIDI keyboard or controller (such as the QS7 or QS8) can generate MIDI signals that are recorded by a sequencer. On playback, the sequencer sends this data to the QSR, which then serves as a multitimbral sound module (in Mix Mode). The sequencer can generate data over several channels; in Mix Mode, the QSR can be programmed so that individual Programs play sequenced data on specific channels. *Example:* If the sequencer transmits a piano part over channel 1, a bass part over channel 2, and a drum part over channel 10, you could set up a QSR Mix so that a piano sound plays only the MIDI data assigned to channel 1, a bass sound plays only the MIDI data assigned to channel 2, and drums play only the MIDI data assigned to channel 10. The QSR can store up to 100 User Mixes.

Connect your master keyboard's MIDI Out to the sequencer's MIDI In (if using a computer-based sequencer, connect to the computer's MIDI interface's MIDI In). Connect the sequencer's MIDI Out to your keyboard's MIDI In. Finally, connect your keyboard's MIDI Thru to the QSR's [MIDI IN] (the Thru signal carries a replica of what appears at the keyboard's MIDI In, which is the same as the sequencer's MIDI Out). Note that the I/O parameter (Global, page 11) must be set to MIDI.

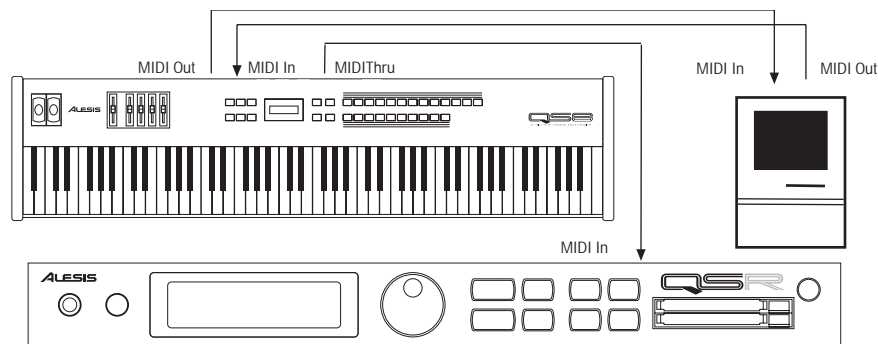

If you are driving other MIDI gear (such as an expander module or MIDI-responsive signal processor), you'll usually drive these from the sequencer if it has additional MIDI outputs. However, you can also use the QSR's [MIDI THRU] connector to drive other modules since the Thru carries a replica of what appears at the QSR's [MIDI IN], which is the same as the sequencer's MIDI OUT.

Note: For most sequencer applications, the QSR's "Mix Group Channel" parameter (on page 13 in Global Edit mode) should be set to OFF. See page 112 for more information.

USING A COMPUTER

The QSR can communicate directly with a computer via its [SERIAL PORT] connector. This eliminates the need for an additional computer-MIDI interface, as well as the MIDI cables to connect to it. The [SERIAL PORT] can be set to one of three modes, depending on the computer you are using. The mode is selected from Global Edit mode, page 11 (I/O Mode).

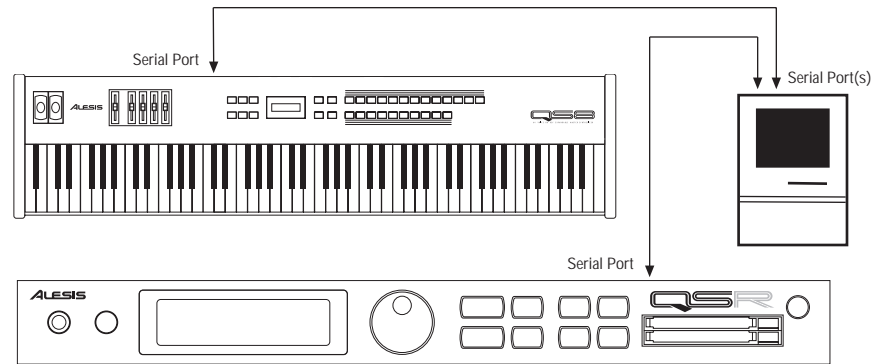

To set to QSR's I/O Mode:

- ① Press [EDIT], then press BANK SELECT [UP] (also labeled as [GLOBAL]).
The display will now be in Global Edit Mode.
- ② Turn the [VALUE] knob to select page 11 (the page number appears in the upper-right corner of the display).
- ③ Press the [CURSOR ] button.
This selects the I/O Mode parameter in the display.
- ④ Turn the [VALUE] knob to set the I/O Mode.

Set the I/O Mode to...	If using...
MIDI	...the QSR's MIDI Input and Output
PC 38.4Kbd	...the QSR's Serial Port connected to an IBM [®] PC or compatible computer with a 38.4 kbaud serial interface
PC31.25Kbd	...the QSR's Serial Port connected to an IBM [®] PC or compatible computer with a 31.25 kbaud serial interface
MAC 1MHz	...the QSR's Serial Port connected to a Macintosh [™] computer with a 1 MHz serial interface

If you already have a MIDI interface for your computer, then you can use the QSR's MIDI connectors to connect the QSR to your computer interface's MIDI IN and OUT connectors using the method described in the previous section. *Note:* If you are already using the QSR's [SERIAL PORT] to connect to your computer, it is not necessary to connect the MIDI ports to the computer as well.

IBM® PCs AND COMPATIBLES

This connection will require a special cable with a DIN8 connector on one end and either a DB9 or DB25 connector on the other end, depending on the type of connector you are using on the PC. You can purchase this cable in most computer retailers or through Alesis Product Support (DIN8-to-DB9 cable: part number 15-00-0009; DIN8-to-DB25 cable: part number 15-00-0025). Some PCs will have both connectors available, so you'll have to identify which connector is currently not in use.

Connect the DIN8 end of the cable to the QSR's [SERIAL PORT] connector and the other end to the serial port of your computer. If your computer has more than one serial port, refer to the setup of your MIDI software to determine which port it is using.

Alesis provides a MIDI serial driver that works with Windows 3.1, Windows NT and Windows 95. This can be found on the QSR CD-ROM disk that came with your QSR package (located in the \ALESIS\ASDWIN\ directory). If you don't have a CD-ROM drive connected to your computer, you can call Alesis Product Support and order the Windows MIDI driver on a 3-1/2 inch floppy disk. This driver is used to send and receive MIDI data from your QSR and the computer via a serial port connection. Once the MIDI driver has been successfully installed, you need to indicate to the driver which connector port the QSR is using.

WINDOWS 3.1: From your Windows 3.1 Control Panel, open the "Drivers" applet. Add an Unlisted or Updated driver and select or browse to the appropriate path for Windows to find the "ASDWIN" OEM setup info. Follow the instructions given by windows to install the driver.

SETUP FOR WINDOWS 95: Open Control Panels. Select "Add New Hardware". Select "NO" to NOT have windows auto-detect hardware. Select "Sound, Video, Game controllers" as hardware type. When prompted for device, select "Have Disk". Navigate to the OEM setup in the "ASDWIN" directory. Follow the Win95 instructions from there.

Please refer to the "READ_ME" file which accompanies the Alesis MIDI driver.

MACINTOSH™

Connect one end of a DIN-8 cable to the QSR's [SERIAL PORT] connector and the other end to either the MODEM serial port or the PRINTER serial port, depending on which one you are using for sequencing.

MIDI sequencing software for the Macintosh typically defaults to using the MODEM port, but in actuality can be set to use either the MODEM or the PRINTER port, or both. If you have a printer connected, you will want to use the MODEM port; conversely, if you have a modem connected but do not have a printer, you will want to connect to the PRINTER port. If, however, both a printer and modem are connected, you will need to either temporarily disconnect one of them (preferably the modem; especially if the printer uses AppleTalk, since AppleTalk must be disabled to use the PRINTER port for MIDI) or purchase a multiple serial port box that will allow you to switch between the modem and the QSR.

DIGITAL AUDIO/OPTICAL HOOKUP

The QSR can output digital audio directly into an Alesis ADAT or ADAT-compatible multitrack digital recorder via fiber optic cable.

The digital connector follows a proprietary Alesis format that carries all four audio outputs of the QSR (Main and Aux, Left and Right) on a single fiber optic cable. Either pair of outputs can be converted into standard AES/EBU or S/PDIF stereo digital audio format by using the Alesis AI-1 interface. Fiber optic cables of various lengths are available from your Alesis dealer. However, the shorter the cable, the better. The model OC cable is 5 meters long and is the maximum length recommended.

To hook up the optical cable between the QSR and an ADAT or AI-1:

- ① Remove the two pieces of clear plastic, tubular sleeving (if present) that protect the tips of the optical cable plug.
- ② Insert one cable end into the QSR [DIGITAL OUT] and the other end into the ADAT or AI-1 DIGITAL IN.

To test the cable and QSR digital output, plug one cable end into the QSR. The other end should emit a soft red light (it is not dangerous to look directly at this light).

RECORDING DIGITAL AUDIO

Once the fiber optic connection is made between the QSR and ADAT or an AI-1, the QSR will output audio on the first four channels of the digital bus (the bus is capable of handling eight channels of digital audio). The MAIN [L] and [R] outputs are routed to channels 1 and 2, while the AUX [L] and [R] outputs are routed to channels 3 and 4. Note that the [VOLUME] knob controls the level of all analog output channels only, and does not control digital output levels. If your digital output is overloading, try reducing the sound level in Program Edit Mode or the Program volume in Mix Edit Mode.

When recording to ADAT (or some other digital audio recorder), it will be slaving to the digital clock accompanying the digital audio emanating from the QSR. This clock can be set to either 48kHz or 44.1kHz, as determined by the Clock function (found in Global Edit Mode). The Clock function has four settings: `Int48kHz`, `Int44.1k`, `Ext48kHz` and `Ext44.1k`. The default setting is `Int48kHz`, which is suitable when the digital recorder is using the 48kHz sample rate. However, if the recorder is using the 44.1kHz sample rate, the Clock function should be set to `Int44.1k`. This ensures that the QSR will be in tune with previously recorded material. See page 118 in Chapter 8 for more information on the Clock parameter.

48 KHz In

If your ADAT system has an Alesis BRC Remote Controller, the QSR's digital clock must be synchronized to the clock coming from the BRC. This requires that a connection be made providing the clock signal to the QSR and that the QSR's Clock function be set to either one of its two external settings (Ext.48kHz or Ext.44.1k).

Connect a BNC-to-BNC cable (such as the Alesis BN cable) between the BRC's 48 kHz CLOCK OUT and the QSR's [48 KHZ IN]. Set the Clock function to either Ext.48kHz if the BRC is set to 48kHz, or Ext.44.1k if the BRC is set to 44.1kHz. For more information about the Clock function, see page 118 in Chapter 8.

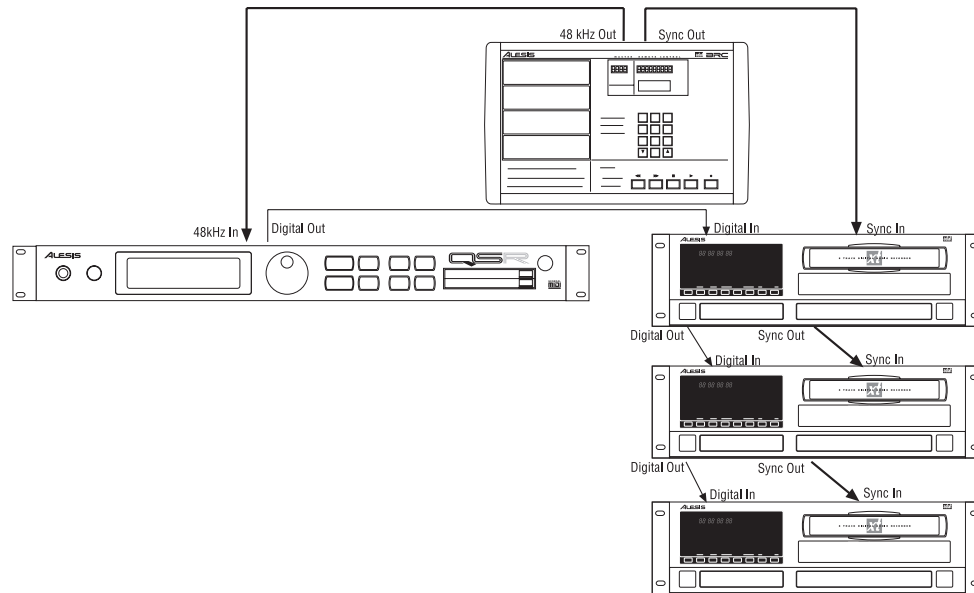

Tip: With this type of connection, the ADAT tracks will remain in tune with the QSR even when the BRC's pitch value is adjusted.

Note: When using only one or more ADATs without the BRC, it is not necessary to connect the 48 kHz Clock.

CHAPTER 4

OVERVIEW

BASIC ARCHITECTURE

The QSR contains 16 megabytes of Sound ROM which provide digitized acoustic and electronic **samples**. These samples are organized into 17 **sample groups** of different types. The groups are:

Piano	String	Noise	Sound FX
Chromatic	Brass	Voice	Rhythm
Organ	Woodwind	Ethnic	
Guitar	Synth	Drums	
Bass	Wave	Percussion	

Several functions (filter, amplitude envelope, pitch envelope, LFO, multiple modulation sources, signal processors, etc.) can be used to process a sample. A **Sound** is the combination of a sample with its associated processing.

A **Program** consists of up to four sounds. These sounds can be layered, split over specific keyboard ranges, or selectively overlapped. The QSR has a User Bank of 128 Programs that you can modify, plus 4 Preset Banks of 512 Preset Programs that are permanently installed in the QSR at the factory (although the Preset Programs can be edited, they must be stored into the User bank to permanently retain your changes). Each Program is linked to its own Effects Patch.

Preset Banks 1-3 and the User bank are organized into 13 **Sound Groups** of 10 Sounds each, and are spread out among the top-right row of buttons on the front panel (programs 00-09 are pianos, 50-59 are basses, and so on). The GenMIDI bank, however, does not follow this arrangement; it follows the program list of the General MIDI standard.

A **Mix** consists of up to 16 Programs, each assigned to a specific MIDI channel and one Effect Patch. The QSR has 100 Mixes in the User Bank, plus 4 Preset Banks of 400 Preset Mixes. This is extremely useful for multitimbral setups where the QSR plays back different sounds on different MIDI channels. Because of its 64 voices and built-in effects, the QSR is often the only sound generator needed.

QSR POLYPHONY

The QSR provides 64-voice **polyphony** (i.e., how many notes can play at once). If a program uses one sound, up to 64 notes can play at once. Layering two sounds allows for 32-note polyphony and layering four sounds, 16-note polyphony.

Layering is a powerful technique that allows you to build up complex timbres. This is crucial because acoustic instruments have extremely complex, evolving sounds and by comparison, many synths sound static. Being able to layer up to four sounds allows for creating large ensembles (e.g., brass section consisting of alto & tenor sax, trumpet, and trombone) or extremely realistic versions of single instruments. When creating layered Programs, keep polyphony in mind. If all Programs in a Mix use all four available sounds, the QSR will quickly run out of voices.

MODES

The QSR is always in one of two main modes: Program Play Mode or Mix Play Mode. Pressing [PROG] selects Program Play Mode, while pressing [MIX] selects Mix Play Mode. While in Program Play Mode, you can press [EDIT] to access Program Edit Mode and Effects Edit Mode. While in Mix Play Mode, pressing [EDIT] alternates between Mix Edit Mode, Program Edit Mode and Effects Edit Mode. Once [EDIT] has been pressed (the lower-left corner of the display reads “EDIT”), pressing BANK SELECT [DOWN] accesses Compare Mode (if the Program/Mix has been edited, and pressing BANK SELECT [UP] accesses Global Edit Mode. Pressing [STORE] accesses Store Mode. Here are descriptions of these modes:

PROGRAM PLAY MODE

Program Play Mode lets you play the QSR’s various Programs one at a time. The QSR contains 512 Preset and 128 User *Programs* (i.e., the sounds of various instruments, effects, ensembles, etc.) that show off just how cool this instrument really is. Initially, the 4 Preset Banks and the User Bank contain data loaded in at the factory. The User Programs can be edited or replaced with your own Programs. However, you cannot replace the Preset Programs, because these are stored in ROM (permanent memory). In Program Play Mode, the QSR responds to or generates messages on a single MIDI channel.

MIX PLAY MODE

Mix Play Mode lets you audition the QSR’s various Mixes. The QSR contains 400 Preset Mixes and 100 User Mixes. A Mix can combine up to 16 different Programs, controlled by 16 channels of MIDI data at once. Therefore, much thicker and richly textured sounds can be created. In Mix Play Mode, the QSR can be used in a wide range of applications. It can be used for live performance, where sounds are layered or assigned to sections of the controller keyboard. It can also be used as a multitimbral sound source for desktop music and home studio applications. A Mix uses the Effects Patch associated with one of its Programs. Although there may be 16 Programs in a Mix, there can only be one Effects Patch per Mix. In Mix Mode, the QSR can respond to messages on up to 16 MIDI channels simultaneously; different channels are available depending on which Mix is selected.

PROGRAM EDIT MODE

In Program Edit Mode, you can change the various settings which determine the sound of an individual Program, or create an entirely new Program from scratch. Each Program is made up of four Sound layers, which you can edit individually, or simultaneously. In Program Edit mode you can:

- select which sample waveform from the 16 megabytes of onboard sample ROM will be used, in each of the 4 sounds;
- change the tone, level, attack and decay characteristics, modulation inputs, and pitch of each layer;
- set modulation routings whereby any parameter can be controlled via MIDI;
- set the effect level for each Sound layer, and set which of the four effect sends each Sound layer will use for signal processing (such as reverb, delay, and chorus—or any combination of these).

MIX EDIT MODE

Mix Edit Mode lets you change the parameters of an existing Mix. Up to 16 Programs can be active in each Mix, and Mix Edit mode sets up how each will be played. Mix Edit Mode allows you to:

- set the output level, effects level, and pan of each Program in the Mix;
- select which Program's Effects Patch will be used by the Mix.

Note that you can select which Programs will be played by the different MIDI channels and by the keyboard in multiple layers or splits without entering Mix mode.

EFFECTS EDIT MODE

Effects Edit Mode is used for setting up the Digital Signal Processing effects. Each Effect Patch has 4 effect bus inputs, and an internal configuration of multiple effects such as reverb, delay, and pitch-related effects (chorus, flange, etc.). You can determine what kinds of effects are used on each bus (called a "Configuration"), change each effect's parameters (such as reverb decay time or chorus speed), set modulation routings (such as having the modulation wheel change the decay time), and set the effects mix (how much reverb, delay and chorus on the output of each effect bus).

GLOBAL EDIT MODE

Use Global Edit Mode to set various parameters which effect the entire instrument, such as overall master tuning, display contrast, MIDI controller settings, and how the unit will respond to messages in Mix Mode.

STORE MODE

Store Mode is used for storing changes of Programs and/or Mixes into the User Bank or onto a QCard PCMCIA memory card accessory. It is also used for transmitting the QSR's parameters over MIDI for data storage purposes, copying sounds or effects from one Program to another, and for transferring entire Banks to or from a Sound Card.

COMPARE MODE

Once a Program has been edited in Program Edit Mode, or a Mix has been edited in Mix Edit Mode, the symbol "⌘" will appear in the display to the left of the Mix's/Program's name while in either Mix Play Mode or Program Play Mode. If BANK SELECT [DOWN] (also labeled [COMPARE]) is pressed while in an Edit Mode, both the [EDIT] button and the word "EDIT" in the lower-right part of the display will begin to flash on and off, and you will temporarily be hearing (and seeing) the original version of the Mix/Program. If you are editing a Mix and press [COMPARE], the original unedited Mix is temporarily recalled. Likewise, if you are editing a Program or its Effects Patch and press [COMPARE], the original Program will be temporarily recalled. Pressing [COMPARE] again switches back to the edited version, and the both [EDIT] button and the word "EDIT" in the the display stop flashing.

THE USER INTERFACE: DISPLAY, FUNCTIONS, PAGES AND PARAMETERS

The key to the QSR user interface is the combination of the Display, the [VALUE] knob and the [◀ CURSOR ▶] buttons. The Display constantly informs you of the QSR's status. The [◀ CURSOR ▶] buttons let you select a value in the display (such as a parameter, a Sound, a page, etc.), and the [VALUE] knob lets you adjust the selection.

ABOUT THE DISPLAY

The display has two modes: Play Mode and Edit Mode. When either [MIX] or [PROG] is pressed, their respective Play Mode is selected and the display will look something like this:

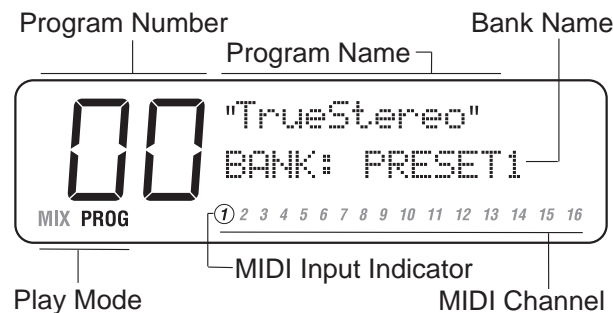

- **Mode.** The lower-left corner of the display will indicate whether you are in Program Play Mode (**PROG**) or Mix Play Mode (**MIX**). In the example above, Program Play Mode is selected. If the selected Program or Mix has been edited, the word **EDIT** will appear to the right of the displayed Mode. In the example above, the Program has not been edited.
- **Number.** The upper-left section of the display will indicate which Program or Mix number is currently selected (00-127 in Program Mode, 00-99 in Mix Mode). In the example above, Program 00 is selected.
- **Name.** The upper-right section of the display will indicate the name of the Program or Mix which is currently selected. In the example above, TrueStereo is selected.
- **Bank.** The middle-right section of the display, directly below the Program's or Mix's name, will indicate which Bank is currently selected (PRESET1 - PRESET3, GenMIDI, or USER; if a card is inserted, CARD1 - CARD8). In the example above, Preset 1 Bank is selected.
- **Channel (1-16).** In Program Play Mode, the QSR will transmit and receive on a single MIDI channel, which will be indicated in the lower-right section of the display. The MIDI channel is selected by using the [◀ MIDI CH ▶] buttons. In Mix Play Mode, the QSR can transmit and receive on up to 16 MIDI channels. The "active" channels will be shown in the display. When a channel is played (from messages received via MIDI), a circle will appear around the channel number in the display. In the example above, MIDI channel 1 is selected, and MIDI information is being received.

When [EDIT] is pressed, the display enters Edit Mode (which Edit Mode you are in depends on whether you were already in Program Mode or Mix Mode). When in an Edit Mode, the display will look something like this:

```

SND1:VOICE  P1
Snd Enable:ON

```

- **Edit Mode.** The bottom-left section of the display will indicate the Edit Mode which is currently selected (**MIX EDIT** = Mix Edit Mode, **PROG EDIT** = Program Edit Mode). The Edit Mode is selected using the [EDIT] button. In the example above, Program Edit Mode is selected.
- **Function.** The upper-middle section of the display indicates what you are editing. This information will change depending on the Edit Mode you have selected. In Mix Mode you can simply scroll through the available Functions using the [VALUE] knob (while the underline cursor appears in the upper section of the display). While in Program Mode, you also have the Sound (1 through 4) to choose from, in addition to the Function you wish to edit. *Example:* If you are in Program Edit Mode, you can choose which of the Program's 4 sounds you wish to edit by turning the [VALUE] knob while the Sound parameter is selected; the display will indicate the selected Sound like this: SND1. The Sound is then followed by a colon and the selected Function. In the example above, Sound 1 is selected for editing, and the Voice function is selected.
- **Parameter/Page.** In many cases when a Function is selected for editing, there will be more than one parameter associated with it. Each parameter is divided into "pages". The upper-right corner of the display will indicate the currently selected page number (P1 - P10). The number of pages available depends on the Function you have selected to edit. When the parameter is selected (underline cursor appears in the lower-left line) you can turn the [VALUE] knob to scroll through the selected Function's parameters/pages. In the example above, the Sound Enable parameter on page 1 of the Voice function is currently selected.
- **Setting.** The lower-right section will display the setting of the parameter which is currently selected. You can adjust the parameter's setting by using the [◀ CURSOR ▶] buttons to move the underline cursor in the display to the parameter's value and turning the [VALUE] knob. In the example above, the Sound Enable parameter is turned on.

MIDI CH BUTTONS

The [◀ MIDI CH ▶] buttons serve two purposes. In Program Play Mode and Mix Play Mode, they are used to select a MIDI channel from 1 to 16. In Program Play Mode, they are used to select the basic MIDI channel the QSR will receive and transmit MIDI messages on. In Mix Play Mode, they are used to select one of the 16 possible Channels for viewing and editing. For more information on MIDI and its uses, see Chapters 8 and 9, and Appendix B.

EDITING VALUES

Once an Edit Mode is selected, a parameter is displayed and that parameter's value is selected by using the [◀ CURSOR ▶] buttons, that parameter's setting can be adjusted by turning the [VALUE] knob. Whenever either the [◀ CURSOR ▶] button is pressed, the cursor (an underline) will move to either the next or previous parameter in the display.

PARAMETER EDITING OVERVIEW

All parameter editing involves the same general procedure, with minor variations:

- ① Select an Edit Mode with the [EDIT] button.
Example: If [PROG] was lit, the [EDIT] button switches between two Edit Modes—one for editing the Program's Sound layers (Program Edit Mode), and the other for editing the Effects (Effects Edit Mode). If [MIX] was lit, the [EDIT] button switches between three Edit Modes—one for editing the Mix's parameters (Mix Edit Mode), one for editing the Programs themselves (Program Edit Mode), and the last for editing the Effects (Effects Edit Mode).
- ② If in Program Edit mode, select a **sound** (1 through 4) by turning the [VALUE] knob. If in Effects Edit mode, select a **send** (1 through 4) by turning the [VALUE] knob. If in Mix Edit mode, use the [◀ MIDI CH ▶] buttons to select a **channel** (1 through 16); the selected channel will flash on and off in the lower section of the display.
- ③ Select a **function** (voice, level, pitch, etc.), by first pressing the [CURSOR ▶] button to advance the cursor in the display to the function field (if in Program Edit or Effects Edit mode; in Mix Edit mode, the function field is automatically selected upon pressing [EDIT]), and then turning the [VALUE] knob to select the function.
- ④ Select the appropriate **page** for the **parameter** you want to edit by first pressing the [CURSOR ▶] button to advance the cursor in the display to the parameter field (in the middle of the display), and then turning the [VALUE] knob to select the parameter.
The upper-right section of the display will indicate the currently selected page number. Each page provides a different parameter. The parameter's name will appear in the middle section of the display.
- ⑤ Change the parameter **value** by first pressing the [CURSOR ▶] button to advance the cursor in the display to the value field (in the middle-right section of the display), and then turning the [VALUE] knob to select the value.

COMPARING EDITED AND STORED VERSIONS

When you edit a Program or Mix, you are actually editing a copy which is in a temporary edit buffer. Therefore, to retain the results of your edit, you must save it to a particular memory location (see the next section on Storing). If you change memory locations before saving, the buffer will be replaced and your edits lost.

Because the original Program/Mix remains undisturbed, you can compare the edited version to the original by using the Compare function. You can only select Compare mode when either Mix Edit, Program Edit or Effects Edit is selected, and the word “**EDITED**” appears in the lower-left section of the display (next to the Mix or Program Mode indicator).

- ① While in an Edit Mode (the word “**EDITED**” should appear in the lower-left section of the display), press [COMPARE].
*Both the [EDIT] button and the word “**EDIT**” in the display will flash.*
- ② Press [COMPARE] again to exit Compare mode and return to the edited version.
*Both the [EDIT] button and the word “**EDIT**” in the display will stop flashing. Pressing [MIX], [PROG], [GLOBAL], or [STORE] will also exit Compare mode. However, to return to Compare mode after pressing one of these buttons, you must first press [EDIT] and then press [COMPARE].*



While Compare mode is selected, you can move around to view the various functions and parameters, but you will not be able to edit anything. This is because you are seeing what is in memory, not what is in the edit buffer.

PRESET MEMORY AND USER MEMORY

The QSR has three types of memory banks for Mixes and Programs: Preset, User and Card. The Preset banks, of which there are four, are stored in ROM (Read Only Memory), and therefore cannot be altered. However, the User bank, of which there is 1, is stored in RAM (Random Access Memory). Card banks can be either ROM or RAM. Anytime you want to keep an edited version of a Mix or Program, you will store it into the User bank or onto a RAM Card. If you want to permanently change a Mix or Program that is in the Preset bank, you can store the edited version into the User bank (in either the same number location or a different number location). However, this requires that you “store over” an existing Program or Mix, losing whatever was previously in that location. If you don’t want to lose any of the sounds in the User bank, you should back-up the entire bank to either an external SRAM or FlashRAM PCMCIA card, or (via MIDI System Exclusive) into a data storage device or a MIDI sequencer. See Chapter 9 for more information on external storage operations.

STORING

The [STORE] button selects Store mode. Store mode has several pages which you can scroll through by using the [◀ CURSOR ▶] buttons. Each page in Store mode provides a different type of storage, copy or data transfer function. When storing edited Mixes or Programs into the User Bank or a RAM Card Bank, you will use the first page of Store mode (for more information about the other pages of Store mode, see Chapter 9). If you press [STORE], the display will look something like this:

```
Save Program to
USER      000
```

Each edit mode type requires its own store operation. For example, if while making a new Mix you also make changes within one of the Programs (such as lowering the filter level), you must use the Store command separately (from Mix Edit, and Program Edit or Effect Edit) in order to save your work. *Note:* When using the Store command from Effect Edit Mode, the associated Program is stored. This is because Effects are stored within their respective Programs.

If you select a different Mix while in Mix Edit mode, or a different Program in Program Edit mode, you will lose all changes you have made, unless you perform a store first.



You can only store Mixes and Programs into their respective User banks. The Preset banks are permanently stored in ROM and cannot be saved over.

STORE A PROGRAM OR MIX

- ① While in either Program Mode or Mix mode, after making your edits press the [STORE] button.
The [STORE] button will begin to flash.
- ② *Optional:* Select the memory Bank in which you want to store the Program or Mix into by first pressing the [◀ CURSOR] button, and then using the [VALUE] knob to select a Bank. Once a Bank has been selected, press [CURSOR ▶] to move the cursor back to the Program/Mix Number field.
If no RAM Card is inserted, you will only be able to select the User Bank.
- ③ Use the [VALUE] knob to select the Program/Mix location (00 – 127) in which you want to store the Program or Mix into.
- ④ Press [STORE] again to complete the operation.
Or, Press any other button to cancel out of the Store operation without storing.



Storing a Mix only stores the Mix parameters, not the individual Programs or Effect Patch used in the Mix. If you have edited any of the Programs in the Mix or the Effects Patch, you must store them separately.

TO AUDITION PROGRAMS BEFORE STORING

To look for available memory locations to permanently store your Program into, you can move between Program Mode and Mix Mode without losing your changes. This is because Program Mode uses a Program edit buffer, and Mix Mode uses its own Mix edit buffer along with 16 additional Program edit buffers. These buffers are retained when moving between Program Mode and Mix Mode, making it easy to search for a suitable location to store your newly created Program. *Example:* While in Program Edit mode, go to Mix Mode and scroll through the Program list on one of the Channels; while editing a Program from Mix Mode, go to Program Mode to scroll through the Program list.

The way to tell the difference between a program edited in Program Mode and one edited from Mix Mode is by looking at the lower-left corner of the display: in Program Edit Mode, the words “**PROG EDITED**” appear, while in Mix Edit Mode, the words “**MIX PROG EDITED**” appear.



You will lose your changes if you remain in the same mode and recall a different Mix/Program by turning the [VALUE] knob.

To audition Programs before overwriting them with STORE

...when editing a Program in Program Mode:

- ① While in Program Edit mode, press [MIX].
This selects Mix Play Mode, retaining your edits to the Program in an edit buffer.
- ② Use the BANK SELECT [DOWN] and [UP] buttons select Preset Bank 1; then use the [VALUE] knob to select Mix 99.
- ③ Press both [◀ MIDI CH ▶] buttons simultaneously to select Channel 1.
- ④ Use the BANK SELECT [DOWN] and [UP] buttons select the User Bank.
- ⑤ Use the [VALUE] knob to go through the Programs in the User Bank until you find one you wish to overwrite with the new edited Program. Take a note of the number.
- ⑥ Press [PROG] to enter Program Play Mode.
This recalls the edit buffer in Program Mode, which is your edited Program.
- ⑦ Press [STORE].
The upper section of the display will read “Save Program to USER xxx” where XXX is a User Program number from 000 – 127.
- ⑧ Use the [VALUE] knob to select the Program Number you noted in step 5.
- ⑨ Press [STORE] again.
The Program is now stored.

To audition Programs before overwriting them with STORE

...when editing a Program in Mix Play Mode:

- ① While in Mix Program Edit mode, press [PROG].
This selects Program Play Mode, retaining your edits to the Program in Mix Edit.
- ② Use the BANK SELECT [DOWN] and [UP] buttons to select the User Bank. If a RAM card is inserted, use the BANK SELECT [DOWN] and [UP] buttons to select a Card Bank.
- ③ Use the [VALUE] knob to scroll through the Programs until you find one you wish to overwrite with the new edited Program. Take note of the number.
- ④ Press [MIX].
This recalls the edit buffer in Mix Mode, which contains your edited Program.
- ⑤ Press [EDIT] twice, until “**PROG EDIT**” appears under the MIX number in the display.
- ⑥ Press [STORE].
The top line of the display will read “Save Program to USER xxx” where XXX is a User Program number from 000—127. Optional: If the location you noted was on a RAM card, use BANK SELECT [UP] to select the Card Bank.
- ⑦ Use the [VALUE] knob to select the Program Number you noted in step 5.
- ⑧ Press [STORE] again.
The Program is now stored.

At this point your edited Program is stored, however the Mix your were auditioning before storing the Program still has the old Program number assigned (if the edited Program was saved to a different Program number location). Therefore, you need to store the Mix as well.

- ⑨ Press [MIX].
This selects Mix Play Mode.
- ⑩ Press [STORE] twice.
The Mix is now stored.

COPYING SOUNDS BETWEEN PROGRAMS

Follow the steps below to copy one of the four Sound layers from one Program to another Program in the User Bank. When copying Sounds between Programs, the “new” Sound will replace the same numbered Sound in the destination Program, i.e., Sound 3 will replace Sound 3.

- ① Press [PROG] to select Program Play Mode, then use the [VALUE] knob to select the Program Number that uses the Sound you want to copy. If necessary, use the BANK SELECT [DOWN] and [UP] buttons to select a different Bank.
- ② Press [STORE].
The [STORE] button will begin to flash.
- ③ Press [CURSOR ] once to advance to Page 2.
The upper section of the display will read:

```
COPY SOUND 1 TO  
SOUND 2 (STR)
```

- ④ Use the [VALUE] knob to select which of the four Sounds (1–4) you wish to copy from the currently select Program, or to select the Program Number in the User Bank you wish to copy the Sound from (000–127).
- ⑤ Press [CURSOR ] once to advance the cursor to the Program number value in the lower section of the display.
- ⑥ Use the [VALUE] knob to select which of the four Sounds (1–4) you wish to copy to in the currently select Program, or to select the Program Number in the User Bank you wish to copy the Sound to (000–127). .
- ⑦ Press [STORE] to complete the copy function.

COPYING EFFECTS BETWEEN PROGRAMS

Follow the steps below to copy the Effects Patch from one Program to another Program in the User Bank.

- ① Press [PROG] to select Program Play Mode, then use the [VALUE] knob to select the Program Number that uses the Effects you want to copy. If necessary, use the BANK SELECT [DOWN] and [UP] buttons to select a different Bank.
- ② Press [STORE].
The [STORE] button will begin to flash.
- ③ Press [CURSOR ] three times to advance to Page 3.
The upper section of the display will read:

```
COPY EFFECT    TO  
PROG 000 (STR)
```

- ④ Use the [VALUE] knob to select the Effects Patch of the currently selected Program, or any Program (000 - 127) in the User Bank to copy from.

- ⑤ Press [CURSOR ] once to advance the cursor to the Program number value in the lower section of the display.
- ⑥ Turn the [VALUE] knob to select the Program Number in the User Bank you wish to copy the Effects to (000–127), or the EFFECT of the currently selected Program.
- ⑦ Press [STORE] to complete the copy function.

INITIALIZING THE PROGRAM/MIX BUFFERS

If you want to start programming from “scratch”, you can easily reset all parameters to their default settings by re-initializing the Program/Mix Buffers. Make sure your mod wheel is all the way down before re-initializing, otherwise the “zero” position of the mod wheel will be incorrect.

To re-initialize the Program/Mix Buffers:

- ① Turn the power off.
- ② While holding down both [ CURSOR ] buttons, turn on the power.

Depending on the last selected Play mode, the QSR will power up showing either Mix 00 or Program 00 of Preset Bank 1, with the word “**EDITED**” appearing in the lower-left corner of the display. All edit buffers have all now been initialized (i.e., all Mix and Program parameters are reset to the default settings).

Re-initializing will also reset all Global parameters to their default settings. However, none of the Programs or Mixes are changed when re-initializing the unit. You can proceed to edit, then [STORE] at any Program location you like.

INITIALIZING SOUNDS

You can also initialize the individual Sounds of a Program on a per Sound basis. This resets the parameters of only one Sound at a time for the selected Program, without changing the remaining Sounds.

To re-initialize the an individual Sound in the currently selected Program:

- ① Press [STORE].
The [STORE] button will begin to flash.
- ③ Press [CURSOR ] five times to advance to Page 4.
The upper section of the display will read:

```

INITIALIZE
SOUND 1 (STR)
```

- ④ Use the [VALUE] knob to select which of the four Sounds (1–4) you wish to initialize.
- ⑤ Press [STORE] to complete the initializing function.

CHAPTER 5

EDITING MIXES

WHAT IS A MIX?

Mix Mode is one of the most powerful features of the QSR. Although in Program Mode you can play only one Program at a time, in Mix Mode you can play up to 16 Programs at once, either from the keyboard (as layers or splits) or from an external sequencer (via 16 MIDI channels) or a combination of both.

With Mix Mode, you can do the following:

- Combine (“stack” or “layer”) different Programs so they can be played simultaneously from your keyboard. For example, stack a piano on top of a brass sound and a string sound, adjusting the volume of each for a desirable mix. (Note that the stacking of Programs in Mix Play Mode is in addition to any sounds that may be stacked in the four sound layers of each Program.)
- Split your controller into different zones—for example, the classic bass guitar on the left-hand side of the keyboard, and synth or piano on the right. You can split the QSR into as many as 16 zones, which may overlap.
- Receive up to 16 MIDI channels from an external sequencer, with each channel representing a different instrument—piano on Ch. 1, bass on Ch. 2, drums on Ch. 10, trumpet on Ch. 16. Mix Play Mode is the multitimbral mode of the QSR.
- Set the level, panning, transpositions and effect send of each MIDI channel.

PROGRAM ASSIGN FOR EACH MIDI CHANNEL

Once a Mix is recalled, you may want to choose different Programs than the ones the Mix has stored with it. *This does not require that you be in Mix Edit Mode.* Assigning Programs to the 16 channels of a Mix is done by first using the [◀ MIDI CH ▶] buttons to select a channel and then using the [VALUE] knob to select a Program. If desired, you can use the BANK SELECT [DOWN] and [UP] buttons to select a Program from any of the internal or card banks.

MIX EDIT MODE

Editing a Mix begins with using the [◀ MIDI CH ▶] buttons to select the MIDI channel you want, and selecting a Program number for each of the channels you want to use (as described above). Beyond Program selection, you may control many other aspects of a Mix by accessing Mix Edit Mode. This is done by pressing the [EDIT] button while Mix Play Mode; “MIX EDIT” should appear in the bottom left section of the display:

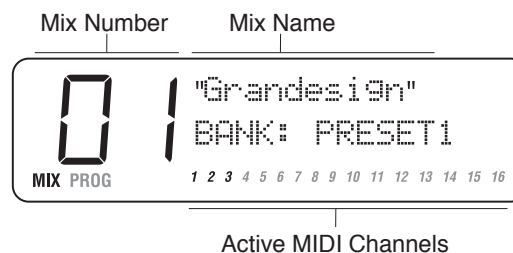

Once in Mix Edit Mode, use the [◀ MIDI CH ▶] buttons to select a MIDI channel to edit (1 – 16). Use the [VALUE] knob to select a Function Group (Level, Pitch,

Effect, etc.) If a Function Group has more than one parameter, press the [CURSOR ] button to advance the cursor in the display, and then turn the [VALUE] knob to locate a specific parameter.

Each channel of a Mix may be enabled or disabled, without changing any of its parameter settings. When a channel is disabled, its number (1 - 16) will not appear in the bottom right section of the display. You can set levels, effect levels and bus assignments, pitch transposition, keyboard ranges (if making a split or layer), and MIDI parameters for each individual channel. A Mix also uses the Effect Patch associated with one of its 16 Programs.

Here is a simplified diagram of the signal path in Mix mode.

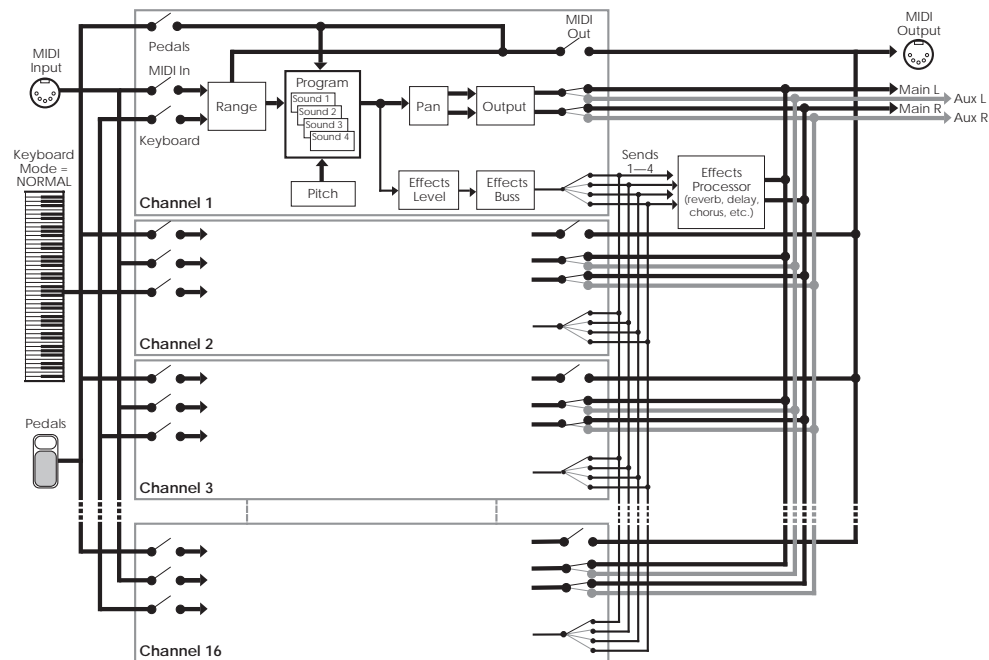

UNDERSTANDING THE EDIT BUFFERS

In Mix mode, there are 16 edit buffers (one for each channel), plus another buffer for the Mix parameters (Level, Pitch, Range, etc.), and yet another buffer for the Effects Processor. When you select a Mix from memory, it is copied into the Mix Edit buffer, the 16 Programs of that Mix are copied into the 16 edit buffers, and the Effect from one of the 16 Programs is copied into the Effects buffer. If you make changes to the Mix, they are only temporarily kept in the edit buffer until a new Mix is selected from memory. Therefore, you **MUST** store your edited Mix if you want to keep it.

If in the course of making a Mix, you enter Program Edit mode (by pressing [EDIT]) and edit one or more Programs in the Mix, the edits you make are entered into a separate buffer for each Program in the Mix. Note, however, that you **DO** have to *store* each edited Program into the User bank (in the same or different Program number location) before selecting a different Mix, or your changes will be lost. The same goes for editing the Effects, which will be stored along with its associated Program into the User Bank. If you select another Mix before storing, your changes will be lost.

LEVEL SETTING FOR EACH PROGRAM

The Level function of Mix Edit is used to control several parameters that deal with the audio output of the selected channel. Parameters in the Level Function's group include: Volume, Pan, Output, Effects Send Level, Effects Bus and Program Enable.

Program Enable (On or Off) Page 1

This determines whether the selected channel is enabled or disabled. When disabled, no sound will be heard. The Channel indicator in the display for a disabled channel will not appear.



Even if a channel is enabled, it will not play unless the proper settings in the RANGE (LOW/HIGH) and MIDI/KEYBOARD functions are made (see pages 42 & 44).

Program Volume (00 to 99) Page 2

This sets the overall volume for a channel. Higher numbers give higher levels.

Program Pan (<3 to 3>, or PROG) Page 3

This determines the pan position of the selected channel. When set to PROG, the Pan setting will be that stored with the Program assigned to the selected channel. However, you can override this setting by selecting a different value, thereby assigning the channel's panning between the left and right outputs.

Output (Main, Aux, Off, or PROG) Page 4

This determines the audio output assignment for the selected channel. When set to PROG, the channel will use the Output assignment of the Program. However, you can override this assignment by setting this parameter to something different. To send the sound's output to the Main outputs, select Main. To send the sound's output to the Aux outputs, select Aux. When set to OFF, the channel will not be sent to the outputs (but can still feed an effect bus).

TIP: To send a sound to an individual output, use Output in conjunction with Pan.
Example: Panning a sound full left and selecting the Aux outputs means that the sound will appear at only the left Aux output.

Effect Level (00 to 99, or PROG) Page 5

This determines the amount of signal from the selected channel that will be sent to the effects, using one of the four effects buses as determined by the Effect Bus parameter (see below). When set to PROG, the effect level will be that stored by the channel's Program.

Effect Bus (1, 2, 3, 4, or PROG) Page 6

This determines which effect bus the selected channel will be routed to. When set to PROG, the effect bus assignment will be that stored by the channel's Program. 1, 2, 3 or 4 overrides the Program's bus assignment, sending all sound layers of the Program to the chosen bus.

PITCH

The Pitch function lets you transpose a channel's Program in either semitone or octave increments.

Tune Octave (-2 to +2 octaves) Page 1

This transposes the Program's pitch in octave (12 semitones) steps from -2 (transposed down 2 octaves) to +2 (transposed up two octaves).

Semitone (-12 to +12 semitones) Page 2

This transposes the Program's pitch in semitone steps, from -12 (transposed down one octave) to +12 (transposed up one octave).

EFFECT

The Effect function is where you select what Effect Patch will be used by the Mix. In Mix Mode, you can have only one Effect Patch per Mix, which will be the Effects Patch associated with one of the Programs used in the Mix.

FX Program Change (On or Off) Page 1

This determines whether the Effects settings will change along with its Program, if a MIDI program change is received on the Effect Channel (see next section). If ON, and a MIDI program change is received, a new Program will be recalled along with its associated Effect Patch. This, however, can change the way the other Programs in the Mix sound, since they all share the same Effects Patch. If you want to recall Programs via MIDI program changes, but also want to continue using the same Effects Patch, leave this parameter turned OFF.

FX MIDI Channel (1 to 16) Page 2

The Effect Channel determines which channel's Program's Effect Patch will be used for the entire Mix. In other words, when the Effect Channel is set to 3, the Mix will use the Effect Patch used by the Program assigned to channel 3.

KEYBOARD/MIDI

The Keyboard/MIDI Function allows you to turn on and off the MIDI and Keyboard switches for the selected MIDI channel.

MIDI In (On or Off) Page 1

This determines whether the selected channel will respond to MIDI messages.

MIDI Out (On or Off) Page 2

In the QS7 and QS8, this determines whether or not the selected channel will transmit MIDI messages. However, in the QSR, this parameter has no effect (it will be shown in lowercase letters in the display).

MIDI Group Channel (On or Off) Page 3

This determines whether or not the selected channel will respond to MIDI information that is received on the Group Mix Channel. The Group Mix Channel is set globally for all Mixes, and can be found in Global Edit Mode, Page 13. For more information, see page 117.

CONTROLLERS

The Controllers function lets you turn on and off the various MIDI controllers that can effect the selected MIDI channel. The following four parameters determine whether or not specific types of MIDI information will be received or transmitted, and are set separately for each Channel in the Mix. These, however, are dependent on how each Channel has its MIDI parameters set (see page 38).

Pitch-bend and Modulation Wheels (On or Off) Page 1

This determines whether or not the selected channel will receive pitch-bend and modulation (controller 1) MIDI information.

Aftertouch (On or Off) Page 2

This determines whether or not the selected channel will receive aftertouch MIDI information.

Sustain Pedals (On or Off) Page 3

This determines whether or not the selected channel will receive sustain pedal (controller 64) MIDI information.

Controllers (On or Off) Page 4

This determines whether or not the selected channel will receive MIDI controller information which the Controllers A–D and Pedals 1 & 2 are assigned to (these are assigned to MIDI controllers in Global Mode, Page 3 and 5).

TRANSMITTING MIDI VOLUME AND PANNING

Each Channel in a Mix can transmit its volume and panning settings via MIDI, if the “MIDI Program Select” parameter is set to ON (Global Edit Mode, Page 10). Volume level is sent as MIDI controller #7, and panning is sent as controller #10. If the “MIDI Program Select” Global parameter is set to ON:

- whenever a Mix is recalled (via the front panel or via MIDI), volume and panning information will be transmitted;
- whenever a Channel’s “Level” parameter is edited, volume information will be transmitted as controller #7 on that Channel;
- whenever a Channel’s “Pan” parameter is edited, panning information will be transmitted as controller #10 on that Channel (except when set to “PROG”).

Note: Panning information will not be transmitted if the Channel’s “Pan” parameter is set to PROG (using the selected Program’s stored Pan setting).

SETTING THE RANGE AND MIDI SWITCHES

The Range function allows you to restrict each MIDI channel to a specific range of the keyboard. This is ideal for creating splits (e.g., bass in the lower octave and a half, piano in the middle three octaves, and strings in the upper octave). In order to hear anything on a particular channel, turn the MIDI In parameter on (KBD/MIDI function) set the Range so that the low note and high note values are set beyond where you want to play. Look at the bottom section of the display. A circle will appear around any active MIDI channels as you play notes or send notes to the QSR from a sequencer on those channels.

Lower Limit (MIDI note 000 to 127/ C-2 to G8)

Page 1

Specifies the lowest note of the sound's keyboard range. While the Lower Limit parameter's value is selected in the display (the cursor appears beneath it), you can set the lower limit by tapping the key on the keyboard you want to set as the lowest note in the range.

High Limit (MIDI note 000 to 127/ C-2 to G8)

Page 2

Specifies the highest note of the sound's keyboard range. While the High Limit parameter's value is selected in the display (the cursor appears beneath it), you can set the lower limit by tapping the key on the keyboard you want to set as the highest note in the range.



If the low limit is set above the high limit, you will be able to play this program layer at the lower and upper ends of the keyboard, but not in the middle between the two limit settings.

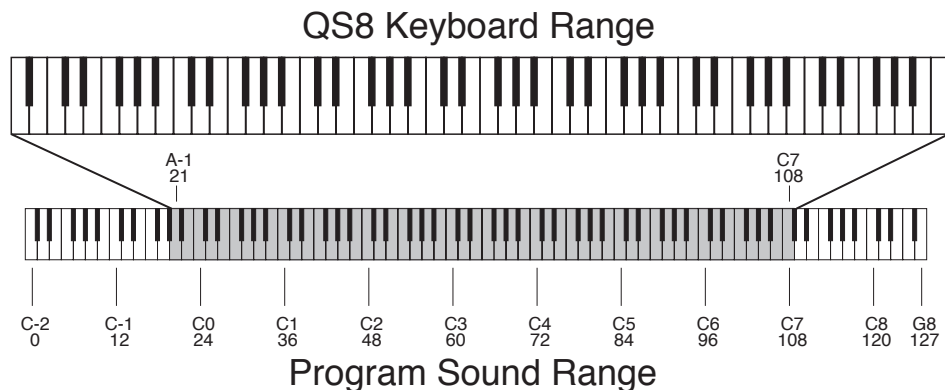

NAMING A MIX



The Name function allows you to change the name of the Mix. The Mix name can be up to 10 characters long. Use the [◀ CURSOR ▶] buttons to position the cursor and the [VALUE] knob to select the character. Here is a chart of available characters:

	!	"	#	\$	%	&	'	()	*	+	,	-	.	/	0	1	2	3
4	5	6	7	8	9	:	;	<	=	>	?	@	A	B	C	D	E	F	G
H	I	J	K	L	M	N	O	P	Q	R	S	T	U	V	W	X	Y	Z	[
¥]	^	_	`	a	b	c	d	e	f	g	h	i	j	k	l	m	n	o
p	q	r	s	t	u	v	w	x	y	z	{		}	→	←				

POLYPHONY IN MIX PLAY MODE

The QSR has 64-note polyphony. In Mix Play Mode, if you have all 16 MIDI channels assigned to the same keyboard range, and each channel's Program has only one active Program Sound, you'll have 4-note polyphony as you play the keyboard (but a really thick layer...). This is extreme, of course, but should tell you what you can expect when you really pile on the layers from the keyboard.

PLAYING A GROUP OF CHANNELS IN A MIX

In Program Play Mode, you can use the [ MIDI CH ] buttons to set the MIDI IN channel for the whole instrument. But when using the QSR in Mix Play Mode, you may need to be able to transmit on several MIDI channels from your MIDI keyboard, in order to play the different channels within a Mix. However, there is a way to "group" any number of channels in a Mix to all play simultaneously from a single MIDI channel (in addition to responding to MIDI information on their individual channels). This can be done by combining the Group parameter (found in Mix Edit Mode, Keyboard/MIDI Function, Page 3) and the Mix Group Channel function (found in Global Edit Mode, Page 13).

- ① From Mix Play Mode, press [EDIT] followed by BANK SELECT [UP] (also labeled [GLOBAL]).
- ② Turn the [VALUE] knob to get to Page 13.
You will see "MixGroupCh# " in the middle of the display.
- ③ Press the [CURSOR ] button once to advance the cursor in the display, and turn the [VALUE] knob to set the Mix Group Channel between 1 and 16, or Off.

1-16. When the Group Mix Channel parameter is set between 1 and 16, the number it is set to determines the single MIDI channel which, when MIDI information is received on it, will play the channels in the selected Mix which have their Group parameter turned on.

OFF. In this mode, the individual channels used by the selected Mix will only be triggered by MIDI information received on its designated MIDI channel (*Example: the sound on channel 1 will only respond to information received on MIDI channel 1, the sound on channel 2 will only respond to information received on MIDI channel 2, etc.*), regardless of whether each channel's Group parameter has been turned on or off. However, the MIDI In parameter for each channel must be turned on in order for that channel to respond to incoming MIDI information on its own channel.

To turn on the Group function for a channel in a Mix:

- ① From Mix Play Mode, press [EDIT].
- ② If necessary, use the [◀ MIDI CH ▶] buttons to move the cursor to the upper line of the display. Then turn the [VALUE] knob until the Keyboard/MIDI function is displayed.
- ③ Press the [CURSOR ▶] button to advance the cursor to the lower line and turn the [VALUE] knob until Page 3 is selected.
You will see "MIDI GROUP:" in the middle of the display.
- ④ Use the [◀ MIDI CH ▶] buttons to select a channel in the Mix.
- ⑤ Press the [CURSOR ▶] button to advance the cursor and turn the [VALUE] knob clockwise to turn on the Group parameter.

CHAPTER 6**EDITING PROGRAMS****OVERVIEW**

Synthesizer programming is the art and science of shaping sounds in a particular way by altering the parameters of various modules. Like music itself, learning synth programming is an ongoing process. Although this manual presents information about synthesizer programming, no manual can offer a complete course in programming (at least for a price that customers would be willing to pay!).

If you're new to synthesizer programming, the best way to learn is to adjust different parameters as you play to discover how different parameter values affect the sound. Also, become familiar with the signal and modulation flow within the QSR (as shown in the various block diagrams included in this manual) so that you can understand the many ways in which you can process a signal as it works its way from oscillator to output.

THE "NORMALIZED" SYNTH VOICE

The first synthesizers were comprised of various hardware modules, some of which generated signals, and some of which processed those signals. These were designed to be general-purpose devices since nobody was quite sure how they would be applied; some engineers used them as signal processors, while keyboard players treated them as musical instruments. Therefore, *patch cords* connected the inputs and outputs of the various signal generating and processing modules (which is why particular synth sounds were called *patches*). Changing a patch involved manually repositioning patch cords and adjusting knobs and switches; recreating a patch required writing down all the patch settings on paper so they could be duplicated later. Even then, due to the imprecision of analog electronics, the patch might not sound exactly the same.

Over the years, certain combinations of modules seemed to work better than others, and since patch cords were troublesome to deal with, eventually these modules were wired together in a "normalized" configuration. Synthesizers such as the MiniMoog™, Prophet-5™, and others eliminated the need for patch cords by containing a normalized collection of sound modules (including oscillators, filter, envelopes, LFOs, etc.).

The QSR offers the best of both worlds. The most commonly-used, normalized configurations are built-in to every program for ease of programming. In addition, the QSR Modulation Matrix gives back much of the flexibility of a modular synthesizer, allowing you to map various modulation sources to multiple destinations for special needs. If you're a beginner, all of the normalized pathways are easy to find; as you gain experience you can explore more advanced features.

HOW THE QSR GENERATES SOUND

The QSR uses custom integrated circuits, developed by the Alesis engineering team specifically for the QSR. These resemble the types of chips used in computers and other digital devices. In fact, you can think of the QSR as a special-purpose computer designed to generate and process audio. Although the user interface maintains the metaphor of “modules,” in fact all sounds are simply a set of numbers reflecting how you’ve programmed the various sound parameters. For example, when you change the filter cutoff frequency, you’re not actually messing with a filter; you’re telling the computer to simulate the effect of messing with a filter.

Each “module” is represented by parameters that appear on one or more display pages. The [VALUE] knob lets you change these parameters. All “patching” is done via software, so the only patch cords you need are those that go to your mixer or amplifier.

You can take a “snapshot” of the QSR’s parameters and save this in memory as a *program*. The QSR comes with 512 factory preset programs, and 128 user-editable programs.

PROGRAM SOUND LAYERS

The simplest method of programming is to take one voice, process it through the filter and amp sections, and (if desired) add some effect to it. However, more elaborate Programs usually consist of 2 to 4 layers, with each layer making its own distinct contribution to the sound, for example:

- An organ program with Program Sound 1 set to a sustained organ waveform, and Program Sound 2 set to a percussion waveform with a fast decay.
- A piano program with one layer tuned normally, and a second layer tuned an octave higher.
- A synthesizer program with one layer set to a sharp attack waveform, a second layer set to an acoustic waveform, and a third layer with a slow-attack string waveform.

This may remind you of Mix Play Mode, where playing the keyboard can sound up to 16 different Programs at once. There are many similarities. In Mix Play Mode, you can make the same kind of layered Mix as you can with the four sounds of a Program. But there are differences:

Use Program Layers:

- If you want multiple sounds to respond to a single MIDI channel. For example, if you need to play a layered synthesizer sound that was assembled in Mix Play Mode instead of Program Play Mode, you must send 3 Note On messages from your sequencer (one for each channel) for every note; a layered program would need only one Note On message.
- When layers of a Program are designed to be used together, and the individual layers by themselves wouldn't be used alone (for example, the percussion layer of the organ sound).

Use Mix Play Mode:

- When you want to layer more than four voices. In Mix Play Mode, it is possible (though not advisable) to stack all 64 voices onto a single key.
- When each sound is likely to be used by itself by other setups. For example, if you are programming three different keyboard splits, each of which uses the same left-hand bass patch, it makes sense to use Mix Play Mode.
- When you want different sounds to respond to different MIDI channels.

QSR SIGNAL FLOW

THE FOUR SOUNDS OF A PROGRAM

Each Program is made up of at least one to four sounds. A sound is made up of several components including a voice (the original sound material) which passes through a low-pass filter and an amplifier. The voice, filter and amp modules each have direct modifiers (Pitch LFO, Filter LFO, Amp Envelope) which affect how each will function in the Program. You can layer these sounds together, or divide them into regions of the keyboard, or a combination of these things.

The following diagram illustrates the signal flow within each QSR Program.

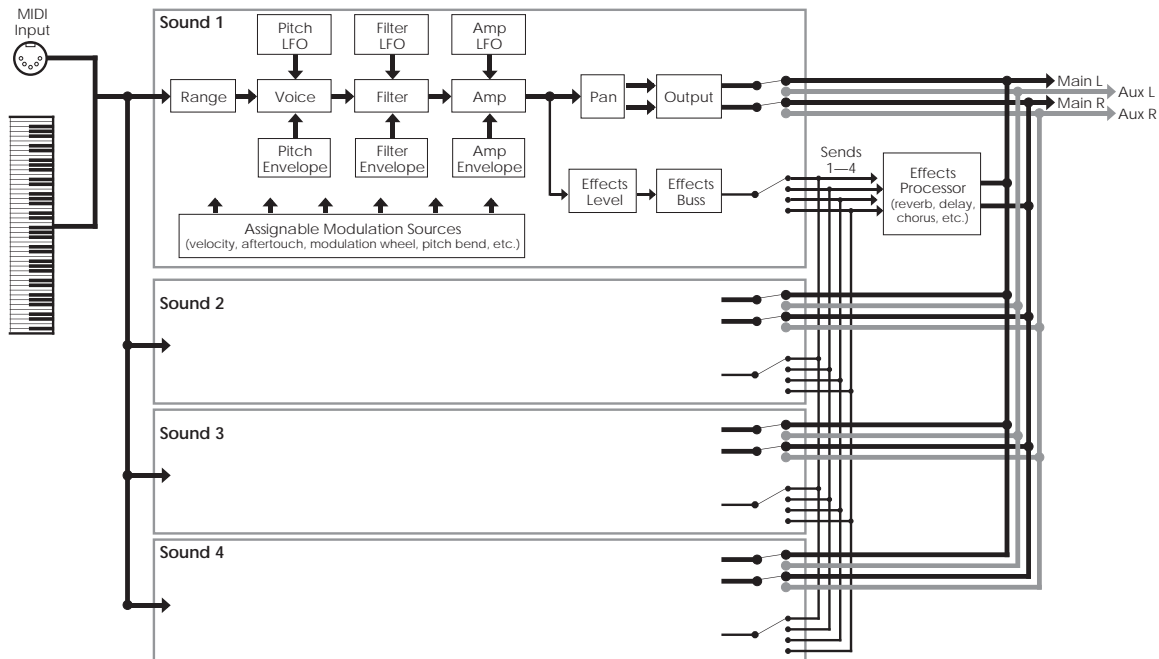

When editing a Program, check the upper-middle section of the display (END) to determine which sound layer you are editing.

Let's look at each module's function in detail.

VOICE

This digitally-based oscillator provides the actual raw sounds from the 16 megabyte library of on-board samples. The oscillator's pitch can be tuned to a fixed frequency or *modulated*. Modulation is the process of varying a parameter dynamically over time; the oscillator pitch can be modulated by envelope, keyboard, pressure, pedal, LFO, and other control sources (described later).

Note that the waveforms in the QSR are different from those found in samplers or many sample-playback units. Because the QSR has its own filter module and amplitude module for each voice, the pure waveforms are relatively bright--as bright as the original instrument can be--and have a constant sustaining amplitude, like an organ. So if you listen to a piano voice without setting the filter or amp to the correct settings, it won't decay after it is hit, as you might expect. This gives you the freedom to create the timbre and dynamics you want, instead of being chained to the parameters of the original sample.

LOWPASS FILTER

A lowpass filter varies a signal's harmonic content by progressively increasing attenuation above a specified *cutoff frequency*. The higher frequencies are filtered, while the lower frequencies are allowed to "pass-thru." When the cutoff frequency is set high, the sound becomes brighter; when set low, the sound becomes bassier since fewer harmonics are present.

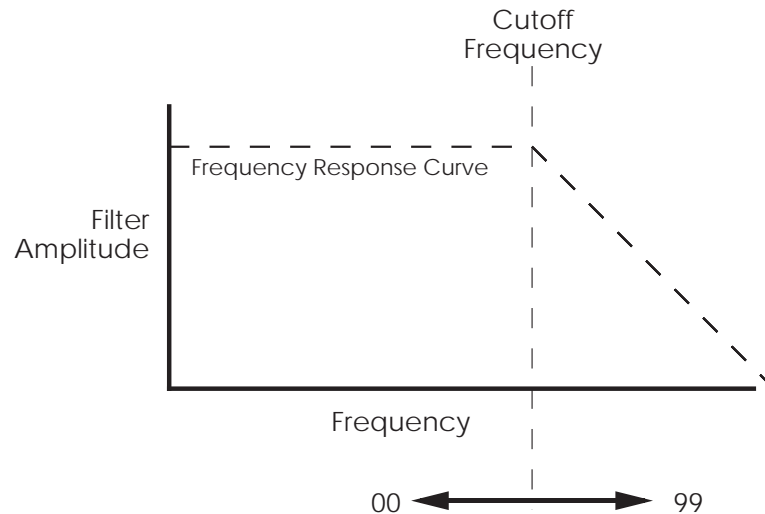

The cutoff parameter changes the frequency at which the high-frequency response starts to roll off. Lower values give a lower cutoff frequency. A value of 00 will cut all sound off.

Static (non-changing) filter settings can be useful, but varying the filter cutoff dynamically over time often produces more interesting effects. Modulating with velocity produces brighter sounds with louder dynamics, which produces a more accurate acoustic instrument simulation. Modulating with an envelope can create a pre-defined change in harmonic structure, such as having a brighter attack and bassier decay.

AMP

Each voice/filter combination is followed by an amplifier whose level can be controlled by a variety of modulation sources. This allows for creating sounds with percussive or slow attacks, particular types of decays, tremolo, etc.

Filter and amp settings can interact. If the filter cutoff is extremely low, then no signal will get through, no matter how the amp is set. Similarly, setting the amp for a short decay won't let you hear any filtering set for a longer decay. This is because the volume will reach zero before the filter decay finishes.

ABOUT MODULATION

Modulation modifies some aspect of a sound over time. Since oscillators make static sounds (unlike acoustic instruments, whose timbre and dynamics change—often radically—over the duration of a note), modulation is the key to making rich and expressive sounds. The vibrato of a flute, the expression pedal of an organ, a wah-wah pedal on a guitar—all of these are examples of modulation. You're probably familiar with the mod wheel of a synthesizer, which typically adds vibrato to a Program as it is raised. But in synthesizer programming, modulation is used to control even the basic characteristics of a voice: its attack, decay, and release times, for example. Every box in the signal diagram on page 49 pointing towards the Voice, Filter, or Amp boxes is a *modulation source*. The amount of modulation, the time it takes place, and what controls (such as key velocity, footpedals, aftertouch, mod wheel etc.) affect it are important parameters in every Program. The QSR provides the modulation flexibility of patch cord-based instruments, but with the convenience and ease of use of digital technology.

With some parameters, the modulation amount can be positive or negative. A positive control signal increases the value of the parameter being controlled. A negative control signal *decreases* the value of the parameter being controlled. Setting modulation to 00 turns off the modulation source. *Example:* Keyboard velocity can either make a sound brighter the harder you play, or make it less bright, or have no effect on the Filter at all. You have the freedom to set modulation any way you want, even in ways that are the opposite of what they would be on an acoustic instrument.

If a "baseline" setting exists for a parameter, modulation amounts add or subtract values from the existing setting. However, modulation cannot force a value beyond its maximum range. For example, if the Amp is already at its minimum value (lowest level), you could apply positive modulation to raise the level. But applying negative modulation will not affect the Amp level, since it's already at its lowest value and cannot go any lower.

The QSR lets you assign several modulation sources to one modulation "target" parameter, which allows for interaction between two modulation signals. *Example:* If the Amp parameter responds to both the envelope generator and a pedal, the parameter will follow the general envelope shape but will also be influenced by the pedal.

LFO (LOW FREQUENCY OSCILLATOR)

The pitch, filter, and amp modules each have a dedicated LFO module for modulation. The term LFO stands for low frequency oscillator, and comes from how modulation was created in the early synth days (an oscillator set to a low frequency could modulate some aspect of the sound; routing the LFO to the pitch, for example, would create vibrato). The LFO creates a cyclic (periodic) modulation; this amount can be constant and/or varied with a variety of modulation sources (mod wheel is one of the most popular). Each LFO has a waveform shape and speed, along with other controls.

ENVELOPES

Envelope generators provide a modulation signal that varies over time, from the time you strike the key until after you let go. There are three independent envelope generators (for pitch, filter, and amp) in each Program Sound. An envelope generator has different effects on different modules. *Example:* The Amp Envelope creates level changes. Amplitude that decays over time creates percussive effects (plucked strings, drums, etc.). Amplitude that increases over time gives the effect of brass, woodwind, and some bowed instruments.

Each envelope generator has the standard attack, decay, sustain, and release parameters found on most synthesizers, along with delay, sustain decay, and different triggering options.

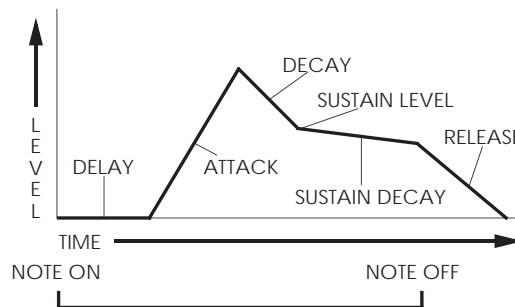

ABOUT SIGNAL PROCESSING

The QSR features a signal processing section based on the Alesis QuadraVerb 2. It is a complete digital signal processing unit with four input buses, simultaneous multiple effects, and flexible signal routing.

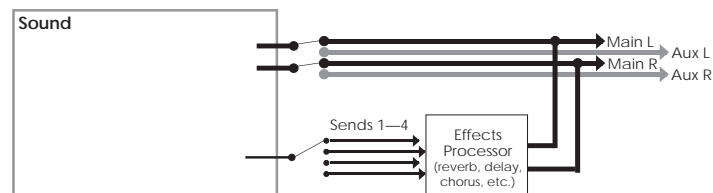

Effects parameters are edited separately from either the Program or the Mix, using Effects Edit Mode (more in Chapter 6). In Program Edit Mode, each of the four sounds in the Program has its own Effect Level control and can be assigned to any one of the four effect buses. Effects settings, Effect Level and Bus information are saved with the Program when you store it back into memory.

DRUM MODE

Any one or all of the four sounds in a Program can be put into Drum Mode. The Drum Mode parameter is found in the Voice Function. Note that Drum Mode isn't the only way to hear drums or percussion from a Program. In Keyboard mode, if you select a kit (such as "Rock Kit 1") as the voice of a Program sound, an entire arrangement of preset, pre-mapped drum sounds will be assigned across the keyboard. If you select a single drum (such as "Timpani") as the voice, that single drum sound will sound across the keyboard range, with a different pitch on each note (the original sample pitch will appear on C3).

However, Drum Mode changes the nature of the VOICE function, allowing you to make up your own drum kit from a selection of over 340 different samples: 21 kicks, 26 snares, 33 toms, 43 cymbals, 75 percussion, 83 percussion effects and 63 synth waves. Plus, there are 90 rhythm beats to choose from (pre-sequenced drum grooves). You can map any of these samples to any note on the keyboard that does not already have a drum assigned to it in that sound. When a sound is in Drum Mode, you can assign 10 different drum sounds to 10 different keys in that layer. If all four sounds in a Program are placed in Drum Mode, you could assemble 40 drum sounds. In Drum mode, individual drums cannot be "stretched" across the entire range of the keyboard -- each occupies a maximum of four keys.

Each of the 10 drum sounds has its own set of parameters in each of the functions in the display (Pitch, Filter, Range, Effects Level, etc.). When editing a Sound in Drum Mode, check the upper-middle section of the display (SID¹) to determine which Drum Sound layer you are editing.

Here is a block diagram of a sound in Drum Mode.

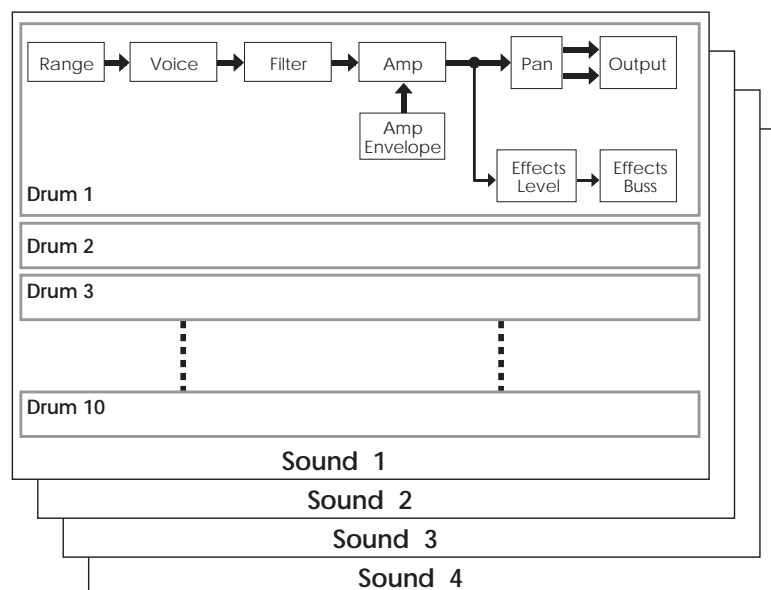

When Drum Mode is enabled, the sound will have fewer parameters for editing. Consequently, not all Function buttons will respond when pressed as when Drum Mode is turned off. Specifically, the LFOs and all Envelopes (with the exception of the Amp Envelope) are unavailable. In addition, the parameters in most other functions will differ. See page 82 for more information about Drum Mode.

PROGRAM EDIT FUNCTIONS

To edit a Program you must select Program Edit mode. This is done by pressing the [EDIT] once from Program Play Mode (each time you press [EDIT] in Program Mode, the display cycles between Program Edit and Effects Edit Modes). When editing a Program in Program Mode, the letters **"PROG EDIT"** will appear in the display's edit status section (bottom-left corner).

A Program may also be edited from within a Mix. This requires that you press the [EDIT SELECT] button twice from Mix Play Mode (each time you press [EDIT SELECT] in Mix Mode, the display cycles between Mix Edit, Program Edit and Effects Edit Modes). When editing a Program in Mix Mode, the letters **"MIX PROG EDIT"** will appear in the display's edit status section (upper-left corner), with the channel number that is being edited immediately following.

VOICE

The Voice function is the most fundamental part of Program editing. It is where you choose the particular sample that forms the basis of a sound. To avoid scrolling through long lists of samples (remember, there are 8 megabytes of sounds in here!), sounds are divided into groups. After selecting the group, you then select the sound within the group.

Sound Enable

Page 1

This is the master on/off switch for the selected sound (1–4) of the current Program.

To avoid using up polyphony unnecessarily, set Sound Enable to OFF for any sounds that will not be used in a Program. Turning sounds off is also a convenient way to isolate a particular sound you are editing. When the sound being edited is disabled, the upper display will show the word "END" in lowercase letters. When the sound being edited is enabled, the word "END" will appear in uppercase letters. When editing a Program's Sound that is in Drum Mode, a single letter will appear as "E" when a sound is enabled, and "e" when disabled.

Sound Type

Page 2

This determines whether a Sound layer is going to be in Keyboard Mode or Drum Mode. Drum Mode allows you to assign individual drum sounds to individual keys. To Program a sound in Drum Mode, refer to the next section "Programming Drum Sounds" on page 78.

Sound Group (17 options)

Choose from among 16 different sample groups (see chart below).

Sound

Selects one of the available samples by name from the selected group, or OFF (no sample selected). Each group has a variety of samples from which you can choose, although some groups (such as waves) have more samples than others.

Below and on the following page, you'll find a chart listing the various samples in their respective groups.

Group	Voice
Piano	GrndPianoL, GrndPianoR, DarkPno1 L, DarkPno1 R, DarkPno2 L, DarkPno2 R, DarkPno3 L, DarkPno3 R, BritePno1L, BritePno1R, BritePno2L, BritePno2R, BritePno3L, BritePno3R, 4::VibesWave, NoHammer R, SoftPianoL, SoftPianoR, VeloPianoL, VeloPianoR, TapPiano L, TapPiano R, E Spinet 1, E Spinet 2, Toy Pno L, Toy Pno R, KeyTrack1, KeyTrack2, Stretch L, Stretch R, PianoWaveL, PianoWaveR, BriteRoads, Dark Roads, Soft Roads, VeloRoads1, VeloRoads2, VeloRoads3, Wurly, VeloWurly1, VeloWurly2, FM Piano, FM Tines, Soft Tines, VelAtkTine, Vel FM Pno, BrtRdsWave, DrkRdsWave, SttRdsWave, Wurly Wave
Chromatic	Clavinet, VelAtkClav, ClavntWave, Harpsicord, VAtkHarpsi, HarpsiWave, Glock, Xylophone, Marimba Hd, Marimba Sf, MarimbaVel, Vibraphone, VibesWave, Ice Block, Brake Drum, TubulrWave, TubWv/Null, FMTblrBell, FMTublrSft, FMTublrVel, FMTub/Null
Organ	Rock Organ, Perc Organ, FullDrwbr1, FullDrwbr2, 3 Drawbars, 4 Drawbars, UpprDrwbrs, 16'Drawbar, 5 1/3' bar, 8' Drawbar, 4' Drawbar, 2 2/3' bar, 2' Drawbar, 1 3/5' bar, 1 1/3' bar, 1' Drawbar, Percus 2nd, Percus 3rd, Percus Wav, HollowWave, 60's Combo, RotarySpkr, ChurchOrgn, Principale, Positive
Guitar	SteelStrng, NylonGuitr, Nylon/Harm, Nylon/Harp, JazzGuitar, SingleCoil, Sngle/Mute, DoubleCoil, DCoil/Harm, DCoil/Jazz, D/S Coil, MicroGuitr, PwrH/MGtr1, PwrH/MGtr2, MuteGuitar, Mute Velo, Metal Mute, MGtr/MtlMt, MtlMut/Hrm, Fuzz Wave, ClsHarmncs, ElecHarmnc, Pwr Harm 1, Pwr Harm 2, Pwr Harm 3, PwrHrmVel1, PwrHrmVel2, PwrHrmVel3
Bass	StudioBass, Studio&Hrm, Studio/Hrm, Slp/Studio, Slap Bass, Slap&Harm, Slap/Harm, Slap/Pop, Pop/Slap, Bass Pop, Pop/Harm, Harm/Pop, JazzFingrd, Fingr&Harm, JazzPicked, Pickd&Harm, Jazz Velo, Muted Bass, Stik Bass, Stik&Harm, Stik/Harm, Harm/Stik, Fretless, Frtls&Harm, AcousBass1, AcoBs1&Hrm, AcousBass2, AcoBs2&Hrm, VelAcoBass, 3-VelBass1, 3-VelBass2, 3-VelBass3, 3-VelBass4, BassHarmnc
String	StringEnsm, TapeStrngs, SoloString, SoloViolin, Solo Viola, Solo Cello, Contrabass, Pizz Sectn, Pizz Split, Pizz/Strng, Strng/Pizz, StringAttk, Harp, Hi Bow, Low Bow
Brass	Pop Brass, ClasclBras, AttakBrass, Trumpet, HarmonMute, Trombone, FrenchHorn, Bari Horn, Tuba
Wdwind	Bassoon, Oboe, EnglishHrn, Clarinet, Bari Sax, BrthyTenor, Alto Sax, SopranoSax, Velo Sax, Flute, Flute Wave, Shakuhachi, PanPipe Hd, PanPipe Md, PanPipe Sf, PanPipeVel, Pan Wave, BottleBlow, BottleWave
Synth	J Pad, M Pad, X Pad, Velo Pad 1, Velo Pad 2, Velo Pad 3, AcidSweep1, AcidSweep2, AcidSweep3, AcidSweep4, AcidSweep5, VeloAcid 1, VeloAcid 2, VeloAcid 3, VeloAcid 4, Chirp Rez1, Chirp Rez2, Chirp RezV, Quack Rez1, Quack Rez2, Quack Rez3, Quack Rez4, QuackRezV1, QuackRezV2, QuackRezV3, Uni Rez 1, Uni Rez 2, Uni Rez 3, Uni Rez V, AnalogSqr1, AnalogSqr2, AnalogSqrV, SyncLead 1, SyncLead 2, SyncLead V, Seq Bass, Seq BassV1, Seq BassV2, FatSynBass, TranceBas1, TranceBas2, VeloTrance, FunkSynBs1, FunkSynBs2, FunkSynBs3, FunkSynBsV, FilterBass, FM Bass, FM/FiltVel, Soft Chirp, Soft Rez
Wave	Pure Sine, 10% Pulse, 20% Pulse, 50% Pulse, Velo Pulse, Mini Saw, Saw Fltr 1, Saw Fltr 2, Saw Fltr 3, Saw Fltr 4, Saw Fltr 5, Saw Fltr 6, Saw Fltr 7, RezSaw UK, RezSaw USA, Acid Saw, Velo Saw 1, Velo Saw 2, Velo Saw 3, Velo Saw 4, Velo Saw 5, Velo Saw 6, AcidRezSqr, VelAcidWav, MiniSquare, Sqr Fltr 1, Sqr Fltr 2, VeloSquare, Mini Tri, Tri Filter, Velo Tri, Rectanglar, Hard Sync, HSync/Rect, BrightSync, Rez Sync, Ring Mod, RingMod V1, RingMod V2, OctaveLock, Diet Saw, Band Saw, Notch Saw, HiPassSaw1, HiPassSaw2, HiPassSaw3, HiPassSaw4, HiPassVel1, HiPassVel2, HiPassVel3, HiPassVel4, HiPassVel5, HiPassVel6, Cognitive, Additive 1, Additive 2, VeloAdditv, Digital 1, Digital 2, Digital 3, Digital 4, Science 1, Science 2, Science 3, Science 4, VelScience, Metal Wave, Inharmonic1, Inharmonic2

Noise	WhiteNoise, Spectral, Crickets, Rain Noise, FiltrNoise, ShapeNoise, VeloNoise1, VeloNoise2, VeloNoise3, NoiseLoop1, NoiseLoop2, NoiseLoop3, NoiseLoop4, NoiseLoop5
Voice	VocalAhhs, Soft Ahhs, Ahhs Wave, VocalOohs, Soft Oohs, Oohs/Ahhs, Ahhs/Oohs, Whistle, Phonic
Ethnic	Sitar, Sitar Wave, Shamisen, Koto, DulcimerHd, DulcimerMd, DulcimerSf, DulcimrVel, DulcmrWave, MandlnTrem, Accordion, Harmonica, Banjo, Kalimba, Steel Drum, Tuned Pipe
Drums	Stndrd Kit, Rock Kit 1, Rock Kit 2, Dance Kit, Brush Kit, ElctricKit, Tek Kit, Rap Kit, Street Kit, MetalliKit, HvyMtlKit, VeloMtlKit, Trip Kit 1, Trip Kit 2, Trip Kit 3, Wild Kit, Octave Kit, OrchstraKt, Raga Kit, FloppyKick, PillowKick, MasterKick, Metal Kick, Smoke Kick, GrooveKik1, GrooveKik2, Sharp Kick, Tek Kick, AnalogKick, Rap Kick, FatWoodSnr, HR Snare, Master Snr, PiccoloSnr, Electrnic1, Electrnic2, Rap Snare1, Rap Snare2, Tek Snare, Brush Snr, Crosstick, Hi Tom, Mid Tom, Low Tom, Cannon Tom, Hex Tom, Rap Tom, Closed Hat, HalfOpnHat, Open Hat, Foot Hat, TekHatClsd, TekHatOpen, RapHatClsd, RapHatOpen, CricketCHH, CricketTIK, CricketsOHH, FltrNoisCH, FltrNoisOH, Ride Cym, Ride Bell, Crash Cym, Null/Crash, Splash Cym, China Cym, Rap Cymbal, RapCymWave, StndrdKtDM, RockKit1DM, RockKit2DM, DanceKitDM, BrushKitDM, ElctrckTDM, Tek Kit DM, Rap Kit DM, StreetKtDM, TripKit1DM, TripKit2DM, TripKit3DM, OctavKitDM, OrchstraDM
Percus	Agogo, Bongo, Cabasa, Castanet, Chimes 1, Chimes 2, Chimes 3, Clap Rap, Clap Tek, Clave 1, Clave 2, Conga Hit1, Conga Hit2, CongaSlap1, CongaSlap2, Rap Conga, Rap Rim, Cowbell, RapCowbell, Cuica, Djembe Hi, Djembe Low, Drumstix, FingerSnap, GuiroLong1, GuiroLong2, GuiroShort, Maracas, SmbaWhstl1, SmbaWhstl2, ShortWhstl, Shaker Hi, Shaker Low, Sleighbel1, Sleighbel2, Tabla Ga, Tabla Ka, Tabla Ka 2, Tabla Na, Tabla Te, Tabla Te 2, Tabla Tin, Taiko Drum, Taiko Rim, Talk Down, Talk Up, Tambourine, Timbale, Timpani, Null/Timp, Triangle 1, Triangle 2, TrianglSf1, TrianglSf2, Udu Hi, Udu Mid, Udu Low, Udu Slap, Vibrasmak1, Vibrasmak2, Wood Block
SndFX	Rain 1, Rain 2, Bird Tweet, Bird Loop, Telephone, Jungle 1, Jungle 2, Jungle 3, Jungle 4, GoatsNails, ScrtchPul1, ScrtchPul2, ScrtchPsh1, ScrtchPsh2, ScratchLp1, ScratchLp2, ScrtchPLp1, ScrtchPLp2, ScrtchPLp3, ScrtchPLp4, Orch Hit, Null/Orch, Dance Hit, Null/Dance, Rez Zip, RezAttack1, RezAttack2, RezAttkVel, Zap Attk 1, Zap Attk 2, Zap Attk 3, Fret Noise, Sci Loop 1, Sci Loop 2, Sci Loop 3, Bit Field1, Bit Field2, Bit Field3, Bit Field4, Bit Field5, Bit Field6, WavLoop1.0, WavLoop1.1, WavLoop1.2, WavLoop1.3, WavLoop1.4, WavLoop1.5, WavLoop1.6, WavLoop1.7, WavLoop1.8, WavLoop2.0, WavLoop2.1, WavLoop2.2, WavLoop2.3, WavLoop2.4, WavLoop2.5, WavLoop2.6, WavLoop2.7, WavLoop2.8, WavLoop3.0, WavLoop3.1, WavLoop3.2, WavLoop3.3, WavLoop3.4, WavLoop3.5, WavLoop4.0, WavLoop4.1, WavLoop4.2, WavLoop4.3, WavLoop4.4, WavLoop4.5, D-Scrape, D-ScrapeLp
Rhythm	Psi Beat 1, Psi Beat 2, Psi Beat 3, Psi Beat 4, Psi Beat 5, Psi Beat 6, Psi Beat 7, Psi Beat 8, Psi Beat 9, Psi Beat10, Psi Beat11, Psi Beat12, Kick Loop1, Kick Loop2, Kick Loop3, Kick Loop4, Kick Loop5, Kick Loop6, Kick Loop7, Kick Loop8, Kick Loop9, KickLoop10, KickLoop11, Snare Lp 1, Snare Lp 2, Snare Lp 3, Snare Lp 4, Snare Lp 5, Snare Lp 6, Snare Lp 7, Snare Lp 8, Snare Lp 9, SnareBeat1, SnareBeat2, SnareBeat3, SnareBeat4, SnareBeat5, Back Beat1, Back Beat2, Back Beat3, Back Beat4, Hat1 Clsd1, Hat1 Clsd2, Hat1 Foot, Hat1 Open1, Hat1 Open2, Hat2 Clsd1, Hat2 Clsd2, Hat2 Foot, Hat2 Open1, Hat2 Open2, Hat3 Clsd1, Hat3 Clsd2, Hat3 Open1, Hat3 Open2, Hat Beat 1, Hat Beat 2, Hat Beat 3, Hat Beat 4, Hat Beat 5, Hat Beat 6, Hat Beat 7, Hat Beat 8, Hat Beat 9, Hat Beat10, Agogo Loop, Bongo Loop, CabasaLoop, CastanetLp, CongaLoop1, Shaker Lp1, Shaker Lp2, SleighLoop, Tabla Ga Lp, Tabla Ka Lp, Tabla Na Lp, Tabla Te Lp, TablaTin Lp, Taiko Loop, PercBeat1, PercBeat2, PercBeat3, PercBeat4, VoiceLoop1, VoiceLoop2, PhonicLoop, SpinalLoop, Tr Loop 1, Tri Loop 2, Orch Loop

LEVEL

The Level function allows you to control the volume, pan position, output assignment and effects send level for each sound layer. With up to four sounds per program, this allows for a wide variety of stereo effects and level balances between the sounds.

Sound Volume (00 to 99) Page 1

This sets the overall volume for a sound. Higher numbers give higher levels.

Sound Pan (<3 to 3>) Page 2

There are 7 available pan locations in the stereo (two-channel) field: Far left (-3), mid left, near left, center (0), near right, mid right, and far right (+3). The pan value is maintained, even if the Output value is changed (see below).

Sound Output (Main, Aux, or Off) Page 3

The Output parameter has three settings: Main, Aux, or Off. To send the sound's output to the Main outputs, select Main. To send the sound's output to the Aux outputs, select Aux. To turn off the sound's output, set this parameter to Off. (Note, however, that the sound may still feed an Effect Send).

TIP: To send a sound to an individual output, use Output in conjunction with Pan.
Example: Panning a sound full left and selecting the Aux outputs means that the sound will appear at only the left Aux output.

Effect Level (00 to 99) Page 4

The QSR isn't just a synthesizer; it also has a built-in effects system and mixer, with four effect buses and sends. This section lets you feed the sound to one of the effect buses for processing (see Chapter 7 for more information on editing Effects). The Effect Level parameter determines how much of the sound feeds the chosen effect bus (see below). Higher values mean that the sound will be more effected.

Effect Bus (1 to 4) Page 5

Selects which of the four buses the sound will feed, thereby determining which effect(s) will process the sound. Each Program has its own unique arrangement of effects. *Example:* In Program #12, bus 1 may be a Chorus/Delay/Reverb, while in Program #27, bus 1 may just be a Flanger.

PITCH

The Pitch function lets you control the pitch aspects of each sound layer.

Semitone (-24 to +24 semitones) Page 1

Sets the oscillator pitch in semitone steps, from -24 (transposed down two octaves) to +24 (transposed up two octaves).

Detune (-99 to +99 cents) Page 2

Sets the oscillator pitch in cents, from -99 (transposed down 99/100 of a semitone) to +99 (transposed up 99/100 of a semitone).

Detune Type (Normal or Equal) Page 3

With Normal selected, the *percentage* of detuning remains the same over the entire range of the keyboard, so the effects of detuning sound the same no matter which key you play. With Equal selected, the *absolute amount* of detuning remains the same over the entire keyboard, so any detuning seems less pronounced as you play higher up on the keyboard.

Pitch Wheel Range (0 to 12 semitones) Page 4

Determines the maximum amount of pitch bend when your MIDI keyboard's pitch bend wheel is full forward. *Example:* When set to 12, the pitch wheel will bend ± 1 octave (12 semitones).

Aftertouch Depth (-99 to +99) Page 5

At +00, aftertouch has no effect on pitch. Applying aftertouch (by pressing harder on the keyboard, or via MIDI messages) with this parameter set to a positive value raises the pitch; conversely, applying aftertouch through a negative value lowers the pitch. The higher the number (either positive or negative), the greater the amount of pitch change for a given amount of aftertouch.

Pitch LFO Depth (-99 to +99) Page 6

At +00, the pitch LFO has no effect. Higher positive values increase the amount of Pitch LFO modulation. Negative values give the same apparent effect, but with reversed LFO phase (i.e., if the pitch would normally be increasing with depth set to a positive number, the pitch would instead be decreasing at that same moment had the depth been set to a negative number). Pitch LFO parameters (such as speed and wave shape) are programmed within the Pitch LFO Function (see page 72).

Pitch Envelope Depth (-99 to +99) Page 7

At +00, the Pitch Envelope has no effect. Positive values raise the pitch from the baseline according to the envelope shape, while negative values similarly lower the pitch (see illustration below). The higher the number (negative or positive), the greater the effect. Pitch Envelope parameters (such as attack and decay time) are programmed within the Pitch Envelope Function (see page 61).

Portamento (Exponential, Linear, 1 Speed)**Page 8**

This provides the sweep's "curve."

- With an exponential curve, the pitch change seems to happen more rapidly at first, then slows down as it approaches the ending pitch.
- A linear curve produces a constant pitch change throughout the glide.
- Normally, the greater the interval (the pitch difference between the two notes), the longer the glide. For example, a glide between two notes a whole step apart would take much less time than a glide between two notes an octave apart. The 1 Speed curve maintains a constant glide rate regardless of the pitch difference between notes.

About portamento: When you play a key and then a second key, normally the sound jumps instantly from one pitch to another. Portamento provides a sweeping glide from one note to another over a variable amount of time. A good example of this type of sound is a steel guitar, where a note slides from one pitch to another.

Portamento Rate (0 to 99)**Page 9**

Sets the glide duration. Higher numbers give longer glide times. The Rate value is affected by the Portamento value (see above).

Keyboard Mode (Mono, Poly, 1-Pitch or 1-PMono)**Page 10**

In Mono mode, you can play only one note at a time—just like vintage monophonic synthesizers or wind instruments. Poly mode allows you to play polyphonically. Note that portamento behavior is more predictable in mono mode.

TIP: With a feedback guitar patch that uses one sound for the guitar and one sound for the feedback, setting the feedback sound to Mono Keyboard Mode insures that your feedback "whistle" will be monophonic, which more accurately mimics what happens when you play lead guitar.

Use 1-PITCH mode when you want a program sound layer to play a single pitch polyphonically throughout the entire keyboard range. In 1-PITCH mode, the QSR will play the sample used for note C3 for all notes in the range. 1-PITCH mode is often used for layering a noise or drum sound behind another sound that is pitched, for example, to fatten up a bass guitar sound with a hint of kick drum, or to have the same cymbal hit every time any note is played. Alternatively, 1-PMONO mode is a monophonic version of 1-PITCH.

Sometimes when playing a monophonic instrument, you will not want the envelopes to retrigger when playing legato, as this would sound realistic. Imagine a flute-player beginning each note in a phrase with a sharp, breathy attack. In reality, the player would only attack the first note in the phrase this way. Therefore, if the Keyboard Mode is set to "Mono", the three envelopes (Pitch Envelope, Filter Envelope and Amp Envelope) will only retrigger when playing legato if the envelope's Trigger Mode is set to either "Reset" or "Reset-Freerun".

FILTER

The Filter function lets you control the tone of each sound layer.

Filter Frequency (00 to 99)

Page 1

This sets the filter's initial cutoff frequency. Lower values give a duller sound since this removes more harmonics; higher values let through more harmonics, which gives a brighter sound.

TIP: Signals with complex harmonic structures are most affected by the filter. *Examples:* A sine wave has virtually no harmonics so you will not hear any significant changes as long as the filter cutoff is higher than the note pitch. If the filter cutoff is lower than the note pitch, you will either not hear the note, or it will be very soft. A harmonically-rich sample (such as brass or white noise) will be greatly affected by the filter.

If the Filter Frequency is set to maximum, in most cases all other variables in the Filter function will have no effect. Most other filter functions raise the filter frequency, and it can't be greater than 99. So if you want to use filter effects, proper setting of this initial cutoff frequency is crucial. This is the "baseline" from which all other filter parameters will raise or lower (open or close) the filter.

If the Filter Frequency is set to 00, and no other parameters are set to raise it dynamically, no sound will pass through the filter at all--there will be silence. If the Amp settings are wide open and you can't hear anything, check the Filter Frequency setting.

Since the waveforms in ROM are recorded at the brightest possible setting, in many cases dynamic filtering is crucial to making a program sound natural.

Keyboard Track (On or Off)

Page 2

When off, the filter cutoff remains constant across the keyboard. Higher notes will be more affected than lower notes, since the filter cutoff is comparatively lower for higher notes than lower ones.

When on, the filter frequency tracks the keyboard pitch. Therefore, if using the filter creates a particular harmonic structure when you play one key, playing a different key will shift the filter frequency to maintain the same harmonic structure.

Velocity (-99 to +99)

Page 3

At +00, velocity has no effect on the filter cutoff. With positive values, playing harder increases the filter cutoff. More positive values drive the cutoff frequency higher for a given amount of velocity. More negative values drive the cutoff frequency lower for a given amount of velocity.

TIP: Many acoustic instruments, such as acoustic guitars, sound brighter when you play them more forcefully. Adding a little positive velocity control over the filter can simulate more realistic acoustic sounds.

Modulation Wheel Depth (-99 to +99)**Page 4**

Determines how moving your controller's modulation wheel affects the filter cutoff frequency. *Example:* With positive settings, moving a modulation wheel up raises the filter cutoff frequency and moving it down lowers the filter cutoff frequency. With negative settings, moving the modulation wheel up lowers the filter cutoff frequency and moving it down raises the filter cutoff frequency .

Aftertouch Depth (-99 to +99)**Page 5**

At +00, aftertouch has no effect on the filter cutoff frequency. Applying aftertouch with this parameter set to a positive value raises the filter cutoff frequency; conversely, applying aftertouch with a negative value lowers the filter cutoff frequency. The higher the number (either positive or negative), the greater the effect for a given amount of aftertouch.

TIP: Many acoustic instruments sound brighter as you play them more forcefully; in particular, brass gets brighter as you blow harder. Using aftertouch to increase a sound's brightness can give more control and realism with acoustic instruments.

Filter LFO Depth (-99 to +99)**Page 6**

At +00, the filter LFO has no effect. Higher positive values increase the amount of filter LFO modulation. Negative values give the same apparent effect, but with reversed LFO phase (i.e., if the filter cutoff frequency would normally be increasing with depth set to a positive number, the cutoff would instead be decreasing at that same moment had the depth been set to a negative number). Filter LFO parameters (such as speed and wave shape) are programmed from within the FLFO Function (see page 74).

TIP: Filter LFO is good for giving wah-wah effects at slower LFO speeds, and for adding "shimmering" with higher LFO speeds.

Filter Envelope Depth (-99 to +99)**Page 7**

The Filter Envelope is one of the most important settings in making a program. Many programs will use the Filter Envelope to determine the tonal character of the sound over time (attack, decay, sustain, and release). At +00, the filter envelope has no effect. Positive values raise the filter from the baseline cutoff frequency according to the envelope shape, and negative values similarly lower the cutoff frequency. The higher the number (negative or positive), the greater the effect. Filter Envelope parameters (such as attack and decay time) are programmed within the Filter Envelope Function (see page 64).

AMP/RANGE

The Amp/Range function lets you control the velocity and keyboard range of each sound layer.

Velocity Curve (13 choices)

Page 1

This selects how the sound will respond to the dynamics of your playing the keyboard. A LINEAR curve is the norm, whereby the increase in level is equal to the increase in velocity; the velocity values increase as you play harder. Many of the Velocity Curves make up sets to be used by 2, 3 or 4 sounds in order to facilitate velocity crossfading, whereby a different sound is played depending on how hard or soft the keyboard is played.

As explained earlier, many of the samples to choose from when assigning voices are already velocity switching. These samples usually have the word "Velo" or the letter "V" in their names, indicating that there is actually more than one sample per note which can be selected by how hard or soft each note is played. However, the velocity point at which these sounds change is fixed and cannot be altered. If you want to create your own velocity crossfading Program, assign the single-sample versions of the same samples ("MarimbaVelo" is made up of "Marimba Hd" and "Marimba Sf") to two or more sounds, then use the appropriate velocity curves for each sound (in a three-way velocity split, sound 1 would use curve "1 of 3," sound 2 would use curve "2 of 3" while sound 3 would use "3 of 3").

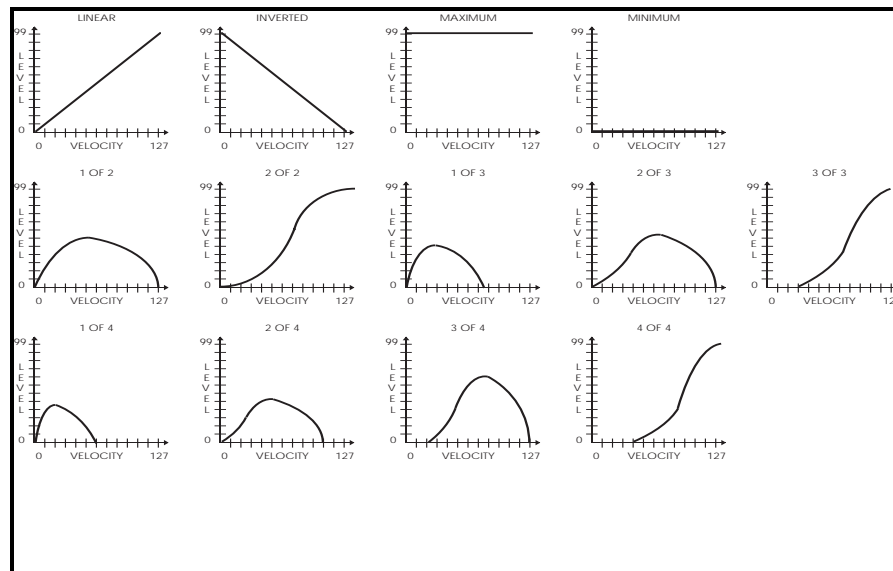

Aftertouch Depth (-99 to +99)

Page 2

At +00, aftertouch has no effect on the amplitude. Applying aftertouch with this parameter set to a positive value raises the amplitude; conversely, applying aftertouch with a negative value will make the sound softer the harder you press. The higher the number (either positive or negative), the greater the effect for a given amount of aftertouch.

TIP: Use aftertouch to "swell" the amplitude of brass and horn parts.

Amp LFO Depth (-99 to +99)**Page 3**

At +00, the Amp LFO has no effect. Higher positive values increase the amount of LFO modulation. Negative values give the same apparent effect, but with reversed LFO phase (i.e., if the amplitude would normally be increasing with depth set to a positive number, the amplitude would instead be decreasing at that same moment had the depth been set to a negative number). Amp LFO parameters (such as speed and wave shape) are programmed within the Amp LFO Function (see page 75).

TIP: Amp LFO set to a triangle wave gives tremolo effects.

Lower Limit (MIDI note 000 to 127/ C-2 to G8)**Page 4**

Each sound can be restricted to a specific range of the keyboard. This is ideal for creating splits (e.g., bass in the lower octave and a half, piano in the middle three octaves, and strings in the upper octave).

The Lower Limit specifies the lowest note of the sound's keyboard range. You can set the lower limit by holding [80] and tapping the key on the keyboard you want to set as the lowest note in the range.

High Limit (MIDI note 000 to 127/ C-2 to G8)**Page 5**

Specifies the highest note of the sound's keyboard range. You can set the high limit by holding [80] and tapping the key on the keyboard you want to set as the highest note in the range.

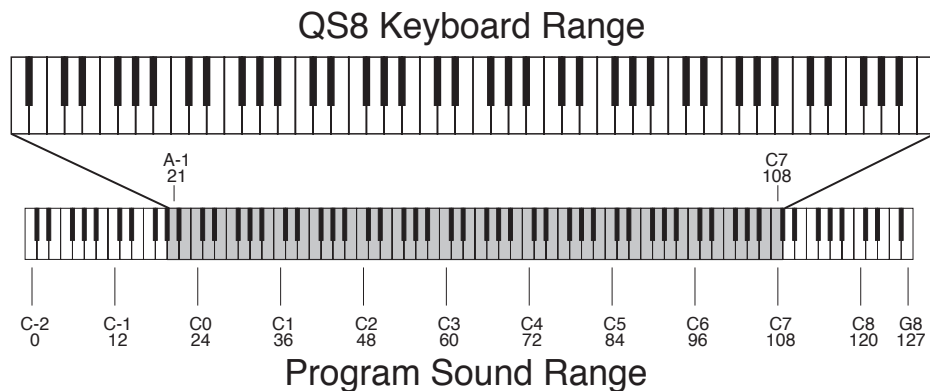

TIP: By setting the lower limit above the high limit, you can create a “hole in the middle” effect. This makes the sound appear to have two zones. All notes from the bottom of the keyboard to the high limit note will play, and all notes from the lower limit to the top of the keyboard will play, but the notes between the high limit and the lower limit will not play. This can be further enhanced in Mix Mode by using the Range function in Mix Edit Mode to cap-off the lower and high limits.

Sound Overlap (00 to 99)

Page 6

This determines how many voices can overlap on the same pitch. *Example:* If you hold the sustain pedal down and play the same note over and over, Sound Overlap determines how many voices are available for that note, and thus how many voices will overlap (play simultaneously).

In the old days, different brands of synthesizers offered different voice allocation schemes. One brand used a method called “rotate mode” in which each time a note was struck, a new voice was used. Another brand used a different method called “reassign mode” whereby if a note is played and then played again, the same voice is used both times. In other words, a new voice is used each time a new note of a different pitch is played.

The Sound Overlap value lets you choose a comfortable setting between rotate mode and reassign mode. When the value equals 99, you are always in rotate mode, using up polyphony; if the value is 00, you are always in reassign mode, conserving voices. Set the value anywhere between 00 and 99 and you will get a combination of both, with partiality toward whichever mode the value is closest to.

A piano sound requires some Sound Overlap, but not a lot; it isn't natural to hear too many voices on the same note. On the other hand, having only one voice per pitch isn't natural either; let's say you played a loud note with the sustain pedal held, followed by a soft note—the second note would abruptly cut-off the first. On a real piano, the string would still be resonating from the first (loud) note when the second (soft) note was played; thus the two notes would overlap.



It is important to note that Sound Overlap can have a negative effect on polyphony.

If you have Sound Overlap set to 99, hold the sustain pedal and play a series of notes, you will run through all 64 voices in no time. By adjusting the Sound Overlap to a lower value, you decrease the number of voices used by each new note, and thereby ensure there are voices available to play other sounds, if necessary.

PITCH ENVELOPE

The Pitch Envelope function can lead to dramatic effects, since it can cause the pitch of a single key to change drastically over time. It's typically used in special-effect synthesizer programs, but it may also be used more subtly in an acoustic program to simulate the characteristic of some instruments to go sharp on the initial attack, especially when played hard.



The following Pitch Envelope variables will have an effect only if the PITCH ENVELOPE DEPTH (on Page 7 of the PITCH function) is set to a value other than 0, or, if Pitch Envelope is a source in the MOD function.

Attack (00 to 99)

Page 1

This is the amount of time the envelope will take until it reaches its maximum output level. Setting the Attack to 0 will make the pitch go to maximum immediately on hitting the key (if the Delay is also set to 0 in Pitch Envelope, Page 5 -- see next page); a setting of 99 will result in a much slower attack, taking many seconds before the envelope gets to maximum.

Decay & Sustain (00 to 99)

Pages 2 & 3

As soon as the attack portion of the envelope finishes (when the level reaches maximum), the envelope will decay (decrease in level). The level it reaches is set by the Sustain control; how long it takes to get there is set by the Decay control. In the special case where the Sustain level is all the way up (99), then there is no decrease and the Decay time segment is bypassed. Whatever level the sustain is set to is the level that the decay section of the envelope will head for. Depending on the setting of the Sustain Decay control (see below), the envelope will either hold at the sustain level until you release the note on the keyboard, or decay to 0 at the Sustain Decay rate (which is on page 2 of the envelope). You can create a long "plateau" at the start of a note by setting the Sustain to 98 and the Decay to 99. This will cause the envelope to take the maximum amount of time to get from peak level to a level of 98, before the Sustain Release portion of the envelope begins.

Release (00 to 99, Hold)

Page 4

Eventually, you will let go of the note that you've been holding (either by releasing the note on the keyboard, or releasing the sustain pedal if it was pressed). It is at this point that the Release portion of the envelope takes effect. The Release is the time that the envelope takes to get from its current level back down to nothing. Setting the Release time to 99 will take the envelope a very long time to reach zero level.

The Pitch Envelope is unique from the other two envelopes in that its Release time can be set above 99. When this is done, the value in the display will read "Hold". This indicates that the Pitch Envelope will remain where it is even after the note is released. This is important when you want the pitch effect to continue even after releasing the key. *Example:* If the Pitch Envelope is bending a note up, and you don't want the pitch to fall when you release the key, set the Release parameter to "Hold".

Delay (00 to 99, Hold)**Page 5**

This is the amount of time that the envelope will wait before doing anything; very useful if you want to affect one element of a sound sometime after the sound starts. When the Delay is set to 0, the envelope attacks right away, without any delay. Play some notes while turning up the delay and see that the time between playing the note and hearing the effect of the Pitch Envelope gets progressively longer as the Delay control is turned up.

If the Delay is set above 99, the display will read "Hold". This indicates that the Delay stage of the envelope will wait indefinitely until the key is released before continuing on to the remaining envelope stages (Attack, Decay, etc.). This requires that the Pitch Envelope's Trigger parameter (see next page) is set to "Freerun". However, when the Delay is set to "Hold", "Freerun" mode is forced on regardless of the Trigger parameter's setting.

Sustain Decay (00 to 99)**Page 6**

This is the amount of time that the envelope will take during the sustain stage to bring the level down to 0. If this is set to 99, the envelope will remain at the Sustain level until the note is released. When set to 0, the envelope's level will immediately jump down to 0 upon reaching the sustain stage.

Trigger (Normal, Freerun, Reset, Reset-Freerun)**Page 7**

The Trigger mode determines how the envelope will function. You may select either Freerun or Reset, or both (Reset-Freerun) or neither (Normal). When set to Normal, the envelope will always start at its current level (i.e., if another note had been played which triggered the envelope's cycle, playing another note in the middle would not interrupt the cycle). Also in Normal mode, the envelope will immediately advance to its release stage upon releasing the note. When set to Freerun, the envelope will complete its entire cycle, even if the note is released in the middle. When set to Reset, the envelope starts at the beginning whenever a new note is played. When set to Reset-Freerun, the envelope will start at the beginning whenever a new note is played and will complete its entire cycle, even if the note is released in the middle.

If a sound layer's Keyboard Mode parameter (found in the Pitch Function, Page 10) is set to "Mono", the Pitch Envelope will only retrigger when playing legato if the Trigger Mode is set to either "Reset" or "Reset-Freerun".

Time Tracking (On or Off)**Page 8**

This determines whether or not keyboard position will affect the cycle speed of the envelope. When turned on, playing toward the higher end of the keyboard will result in a faster envelope cycle; playing toward the lower end of the keyboard will result in a slower envelope cycle. However, this does not effect the attack time, but only the decay, sustain decay and release segments. This feature will result in only a subtle change. The envelope's timing doubles or halves over a range of two octaves.

Sustain Pedal (On or Off)**Page 9**

This determines whether or not a Sustain Pedal will have an effect on the envelope. When turned on, holding down the Sustain Pedal while playing short notes is virtually the equivalent to holding down those notes on the keyboard with some subtle but important differences. If the Delay and Attack are set to 0 and either the Decay is 0 or the Sustain is 99, the envelope will immediately jump to the sustain decay stage (if not already there) when the note is released and the sustain pedal is held down. If a long attack is set, and the envelope does not reach the end of the attack segment when the note is released, it will be skipped and the envelope will jump immediately to the release segment. If a long delay is set, and the envelope has not reached the attack segment before the note is released, the envelope will remain at 0. However, if Freerun is turned on, the envelope will continue through the delay, attack, decay and sustain segments and remain at the sustain decay segment. This is exactly the same as holding down the note on the keyboard. When the Sustain Pedal parameter is turned off, a Sustain Pedal will have no effect on the envelope.

Level (00 to 99)**Page 10**

This is the overall output level of the envelope. If this is set to 00, the Pitch Envelope will have no output and will have no effect, while at 99 it will have a maximum effect on whatever it is being routed to.

TIP: When selecting Pitch Envelope Level as a modulation destination, set the Pitch Envelope level to 00 if the Modulation Level is above 0 (or, set the Pitch Envelope level to 99 if the Modulation Amount is below 0).

Velocity Modulation (00 to 99)**Page 11**

This determines how keyboard dynamics will affect the envelope level. When set to 99, note velocity controls the envelope's output; notes played hard will deliver a higher envelope output than notes played soft. When set to 0, note velocity will have no effect on the envelope's output level.

FILTER ENVELOPE

The Filter Envelope function is crucial whenever you want the tonal quality of a note to change over time, differently from its overall level. *Example:* When you want the initial attack of a note to be bright, but want the sustaining part to be filtered.



The following Filter Envelope variables will have effect only if the FILTER ENVELOPE DEPTH (on Page 7 of the FILTER function) is set to a value other than 0, or, Filter Envelope is a source in the MOD function.

Also note that the Filter Envelope may have no effect if some other modulation source, or the basic setting of the filter, has already pushed the filter cutoff frequency to its maximum.

Attack (00 to 99)

Page 1

This is the amount of time the envelope will take until it reaches its maximum output level. Setting the Attack to 0 will give a sharp edge to the sound (if the Delay is also set to 0 in Filter Envelope Page 5 -- see next page); a setting of 99 will result in a much slower attack, taking many seconds before the envelope gets to maximum.

Decay & Sustain (00 to 99)

Pages 2 & 3

As soon as the attack portion of the envelope finishes (when the level reaches maximum), the envelope will decay (decrease in level). The level it reaches is set by the Sustain control; how long it takes to get there is set by the Decay control. In the special case where the Sustain level is all the way up (99), then there is no decrease and the Decay time segment is bypassed. Whatever level the sustain is set to is the level that the decay section of the envelope will head for. Depending on the setting of the Sustain Decay control (see below), the envelope will either hold at the sustain level until you release the note on the keyboard, or decay to 0 at the Sustain Decay rate (which is on page 2 of the envelope). You can create a long "plateau" at the start of a note by setting the Sustain to 98 and the Decay to 99. This will cause the envelope to take the maximum amount of time to get from peak level to a level of 98, before the Sustain Release portion of the envelope begins.

Release (00 to 99)

Page 4

Eventually, you will let go of the note that you've been holding (either by releasing the note on the keyboard, or releasing the sustain pedal if it was pressed). It is at this point that the Release portion of the envelope takes effect. The Release is the time that the envelope takes to get from the sustain level back down to nothing. Setting the Release time to 0 is good for playing those short funky riffs that you hear on a clavinet. Setting the Release time to 99 will take the envelope a very long time to reach zero level.

Delay (00 to 99)**Page 5**

This is the amount of time that the envelope will wait before doing anything; very useful if you want to affect one element of a sound sometime after the sound starts. When the Delay is set to 0, the envelope attacks right away, without any delay. Play some notes while turning up the delay and see that the time between playing the note and hearing the effect of the Filter Envelope gets progressively longer as the Delay control is turned up.

If the Delay is set above 99, the display will read "Hold". This indicates that the Delay stage of the envelope will wait indefinitely until the key is released before continuing on to the remaining envelope stages (Attack, Decay, etc.). This requires that the Filter Envelope's Trigger parameter (see next page) is set to "Freerun". However, when the Delay is set to "Hold", "Freerun" mode is forced on regardless of the Trigger parameter's setting.

Sustain Decay (00 to 99)**Page 6**

This is the amount of time that the envelope will take during the sustain stage to bring the level down to 0. If this is set to 99, the envelope will remain at the Sustain level until the note is released. This is the normal setting for organ-type sounds. When set to 0, the envelope's level will immediately jump down to 0 upon reaching the sustain stage.

Trigger (Normal, Freerun, Reset, Reset-Freerun)**Page 7**

The Trigger mode determines how the envelope will function. You may select either Freerun or Reset, or both (Reset-Freerun) or neither (Normal). When set to Normal, the envelope will always start at its current level (i.e., if another note had been played which triggered the envelope's cycle, playing another note in the middle would not interrupt the cycle). Also in Normal mode, the envelope will immediately advance to its release stage upon releasing the note. When set to Freerun, the envelope will complete its entire cycle, even if the note is released in the middle. When set to Reset, the envelope starts at the beginning whenever a new note is played. When set to Reset-Freerun, the envelope will start at the beginning whenever a new note is played and will complete its entire cycle, even if the note is released in the middle.

If a sound layer's Keyboard Mode parameter (found in the Pitch Function, Page 10) is set to "Mono", the Filter Envelope will only retrigger when playing legato if the Trigger Mode is set to either "Reset" or "Reset-Freerun".

Time Tracking (On or Off)**Page 8**

This determines whether or not keyboard position will affect the cycle speed of the envelope. When turned on, playing toward the higher end of the keyboard will result in a faster envelope cycle; playing toward the lower end of the keyboard will result in a slower envelope cycle. However, this does not effect the attack time, but only the decay, sustain, sustain decay and release segments. This feature will result in only a subtle change. The envelope's timing doubles or halves over a range of two octaves.

Sustain Pedal (On or Off)**Page 9**

This determines whether or not the Sustain Pedal will have an effect on the envelope. When turned on, holding down the Sustain Pedal while playing short notes is virtually the equivalent to holding down those notes on the keyboard with some

subtle but important differences. If the Delay and Attack are set to 0 and either the Decay is 0 or the Sustain is 99, the envelope will immediately jump to the release stage (if not already there) when the note is released and the sustain pedal is held down. If a long attack is set, and the envelope does not reach the end of the attack segment when the note is released, it will be skipped and the envelope will jump immediately to the sustain decay segment. If a long delay is set, and the envelope has not reached the attack segment before the note is released, the envelope will remain at 0. However, if Freerun is turned on, the envelope will continue through the delay, attack, decay and sustain segments and remain at the sustain decay segment. This is exactly the same as holding down the note on the keyboard. When the Sustain Pedal parameter is turned off, the Sustain Pedal will have no effect on the envelope.

Level (00 to 99)

Page 10

This is the overall output level of the envelope. If this is set to 00, the Filter Envelope will have no output and will have no effect, while at 99 it will have a maximum effect on whatever it is being routed to.

TIP: When selecting Filter Envelope Level as a modulation destination, set the Filter Envelope level to 00 if the Modulation Level is above 0 (or, set the Filter Envelope level to 99 if the Modulation Amount is below 0).

Velocity Modulation (00 to 99)

Page 11

This determines how keyboard dynamics will affect the envelope level. When set to 99, note velocity controls the envelope's output; notes played hard will deliver a higher envelope output than notes played soft. When set to 0, note velocity will have no effect on the envelope's output level.

AMP ENVELOPE

The Amp Envelope function is crucial for all sounds because it sets the basic characteristics of the note--whether it attacks quickly or slowly, sustains or decays. Some Programs may leave the Amp Envelope in a sustaining mode, and provide attack and decay using the Filter Envelope; the effect is slightly different. Unlike the Pitch and Filter Envelopes, the Amp Envelope is always fully active (there is no parameter in the Amp/Range function adjusting how much envelope is applied to the Amp).

Attack (00 to 99)

Page 1

This is the amount of time the envelope will take until it reaches its maximum output level. Setting the Attack to 0 will give a sharp edge to the sound (if the Delay is also set to 0 in Amp Envelope Page 5 -- see below); a setting of 99 will result in a much slower attack, taking many seconds before the envelope gets to maximum.

Decay & Sustain (00 to 99)

Pages 2 & 3

As soon as the attack portion of the envelope finishes (when the level reaches maximum), the envelope will decay (decrease in level). The level it reaches is set by the Sustain control; how long it takes to get there is set by the Decay control. In the special case where the Sustain level is all the way up (99), then there is no decrease and the Decay time segment is bypassed. Whatever level the sustain is set to is the level that the decay section of the envelope will head for. Depending on the setting of

the Sustain Decay control (see below), the envelope will either hold at the sustain level until you release the note on the keyboard, or decay to 0 at the Sustain Decay rate (which is on page 2 of the envelope). You can create a long "plateau" at the start of a note by setting the Sustain to 98 and the Decay to 99. This will cause the envelope to take the maximum amount of time to get from peak level to a level of 98, before the Sustain Release portion of the envelope begins.

Release (00 to 99)

Page 4

Eventually, you will let go of the note that you've been holding (either by releasing the note on the keyboard, or releasing the sustain pedal if it was pressed). It is at this point that the Release portion of the envelope takes effect. The Release is the time that the envelope takes to get from the sustain level back down to nothing. Setting the Release time to 0 is good for playing those short funky riffs that you hear on a clavinet. Setting the Release time to 99 will take the envelope a very long time to reach zero level.

Delay (00 to 99)

Page 5

This is the amount of time that the envelope will wait before doing anything; very useful if you want to affect one element of a sound sometime after the sound starts. When the Delay is set to 0, the envelope attacks right away, without any delay. Play some notes while turning up the delay and see that the time between playing the note and hearing the effect of the Amp Envelope gets progressively longer as the Delay control is turned up.

If the Delay is set above 99, the display will read "Hold". This indicates that the Delay stage of the envelope will wait indefinitely until the key is released before continuing on to the remaining envelope stages (Attack, Decay, etc.). This requires that the Amp Envelope's Trigger parameter (see next page) is set to "Freerun". However, when the Delay is set to "Hold", "Freerun" mode is forced on regardless of the Trigger parameter's setting.

Sustain Decay (00 to 99)

Page 6

This is the amount of time that the envelope will take during the sustain stage to bring the level down to 0. If this is set to 99, the envelope will remain at the Sustain level until the note is released. When set to 0, the envelope's level will immediately jump down to 0 upon reaching the sustain stage.

Trigger (Normal, Freerun, Reset, Reset-Freerun)

Page 7

The Trigger mode determines how the envelope will function. You may select either Freerun or Reset, or both (Reset-Freerun) or neither (Normal). When set to Normal, the envelope will always start at its current level (i.e., if another note had been played which triggered the envelope's cycle, playing another note in the middle would not interrupt the cycle). Also in Normal mode, the envelope will immediately advance to its release stage upon releasing the note. When set to Freerun, the envelope will complete its entire cycle, even if the note is released in the middle. When set to Reset, the envelope starts at the beginning whenever a new note is played. When set to Reset-Freerun, the envelope will start at the beginning whenever a new note is played and will complete its entire cycle, even if the note is released in the middle.

If a sound layer's Keyboard Mode parameter (found in the Pitch Function, Page 10,) is set to "Mono", the Amp Envelope will only retrigger when playing legato if the Trigger Mode is set to either "Reset" or "Reset-Freerun".

Time Tracking (On or Off) Page 8

This determines whether or not keyboard position will affect the cycle speed of the envelope. When turned on, playing toward the higher end of the keyboard will result in a faster envelope cycle; playing toward the lower end of the keyboard will result in a slower envelope cycle. However, this does not effect the attack time, but only the decay, sustain, sustain decay and release segments. This feature will result in only a subtle change. The envelope's timing doubles or halves over a range of two octaves.

Sustain Pedal (On or Off) Page 9

This determines whether or not the Sustain Pedal will have an effect on the envelope. When turned on, holding down the Sustain Pedal while playing short notes is virtually the equivalent to holding down those notes on the keyboard with some subtle but important differences. If the Delay and Attack are set to 0 and either the Decay is 0 or the Sustain is 99, the envelope will immediately jump to the release stage (if not already there) when the note is released and the sustain pedal is held down. If a long attack is set, and the envelope does not reach the end of the attack segment when the note is released, it will be skipped and the envelope will jump immediately to the sustain decay segment. If a long delay is set, and the envelope has not reached the attack segment before the note is released, the envelope will remain at 0. However, if Freerun is turned on, the envelope will continue through the delay, attack, decay and sustain segments and remain at the sustain decay segment. This is exactly the same as holding down the note on the keyboard. When the Sustain Pedal parameter is turned off, the Sustain Pedal will have no effect on the envelope.

Level (00 to 99) Page 10

This is the overall output level of the envelope. If this is set to 00, the Amp Envelope will have no output and will have no effect, while at 99 it will have a maximum effect on whatever it is being routed to.

TIP: When selecting Amp Envelope Level as a modulation destination, set the Amp Envelope level to 00 if the Modulation Level is above 0 (or, set the Amp Envelope level to 99 if the Modulation Amount is below 0).

NAME

The Name Function allows you to change the Program's name. The Program name can be up to 10 characters long. Use the [◀ CURSOR ▶] buttons to position the cursor. The [VALUE] knob lets you change the character. Here is a chart of available characters:

	!	"	#	\$	%	&	'	()	*	+	,	-	.	/	0	1	2	3
4	5	6	7	8	9	:	;	<	=	>	?	@	A	B	C	D	E	F	G
H	I	J	K	L	M	N	O	P	Q	R	S	T	U	V	W	X	Y	Z	[
¥]	^	_	`	a	b	c	d	e	f	g	h	i	j	k	l	m	n	o
p	q	r	s	t	u	v	w	x	y	z	{		}	→	←				

Mod 1 – Mod 6

About General Purpose Modulation

Although there are several dedicated modulators in the QSR (e.g., the pitch can always be modulated by the pitch LFO and Pitch Envelope), sophisticated synthesizer programming demands the ability to use as many modulation sources as possible to modulate as many modulation destinations as desired.

The QSR arranges its modulation source outputs and modulation destination inputs into a “matrix” so that any selected source can connect to any of several destinations.

There are six general purpose matrix modulators, which allows you to control up to six parameters with any of several control sources.

Use the MOD functions to setup your own customized control of a program, such as:

- Using the PEDAL 1 input or the Controller A Slider to control volume, brightness (filter cutoff), effect level, LFO speed, etc.
- Using velocity to increase or decrease the attack speed of an envelope, so playing softly makes the sound fade in, while playing hard causes an immediate attack.
- Using release velocity to increase/decrease the release time of an envelope, so quick releases of the keys cut off the end of the sound, while slow key releases allow the sound to fade away gradually.

The MOD functions give you the freedom to go beyond the standard modulation sources built-in to other functions.

Selecting the Modulator (1 to 6)

With the cursor located beneath the Function field in the upper display, use the [VALUE] knob to select one of the six modulators the same way you would select any other Program Edit Function. All modulators work in the same way, so only the pages of one will be described here.

Modulation Source

Page 1

Select from the following modulation sources:

- **Note #** provides a modulation signal that corresponds to the note played on your keyboard controller (higher keys give higher values). Example: Use this modulation source to obtain a different chorus sound in the upper and lower keyboard ranges.
- **Velocity** relates to how fast a key goes from the key up (note off) to the key down (note on) position, and therefore represents the dynamics of your playing.
- **Release velocity** relates to how fast a key goes from the key down (note on) to the key up (note off) position. Example: Use this to affect the rate of a sound’s release based on how fast you remove your fingers from the keys.

- **Aftertouch** Pressing on the keys after they're down generates this control signal. Aftertouch is also called channel pressure, and represents an average of all keys being pressed. This affects any keys that are held down. The harder you press on the keys, the greater the degree of modulation.
- **Polyphonic Pressure** This is similar to aftertouch, but each key can respond to individual pressure messages. *Example:* Assign poly pressure to the sound's amplitude in a string ensemble patch. You can then increase the level of selected notes of a held chord to "pull" some notes out of the chord.
- **Modulation Wheel** The Modulation wheel is traditionally assigned to LFO amount (level) so that rotating the wheel away from you introduces vibrato. However it is also well-suited to controlling timbre, vibrato speed, and many other parameters.
- **Pitch Wheel** Pitch wheel messages always control the oscillator pitch but can be tied to other parameters as well.
- **MIDI Volume** MIDI can produce a variety of controller messages (see the MIDI supplement in the back of this manual). Of these, controller #7, which controls channel volume, is one of the most frequently used. *Example:* Assign the filter cutoff as the destination, and you can have the signal become less bright as it becomes lower in volume.
- **Sustain Pedal** Sustain pedal messages (MIDI controller 64) provide this modulation signal.
- **Pedal 1** Pedal 1 can be assigned to any MIDI controller from Global Edit Mode, page 8.
- **Pedal 2** Pedal 2 can be assigned to any MIDI controller from Global Edit Mode, page 9.
- **Pitch LFO** This is the same modulation signal provided by the Pitch LFO. The **Frequency LFO** and **Amplitude LFO** can also be selected as modulation sources.
- **Pitch Envelope** This is the same modulation signal provided by the Pitch Envelope. The **Frequency Envelope** and **Amplitude Envelope** can also be selected as modulation sources.
- **Random** This provides a different modulation value every time you hit a key. *Example:* With vintage analog synth patches, use pitch as the destination and apply a very slight amount of random modulation. Each note will have a slightly different pitch, which simulates the natural tuning instability of analog circuits.
- **Trigrate** This is a Trigger Rate Follower, which monitors how fast notes are being played on the keyboard. For example, if routed to the Effect send of a Program, you could automatically have more effect when playing slowly, and less effect when playing quickly.

- **Controllers (A, B, C, D)** Four incoming MIDI controllers can be recognized by the QSR and used as modulation sources. These controllers are assigned as A–D in Global Mode (see Chapter 8).
- **Tracking Generator** This accepts the output of a signal processed by the Tracking Generator module (see page 81).
- **Stepped Tracking Generator** This accepts the output of a signal processed by the Tracking Generator module in stepped mode (see page 81).

Modulation Destination

Page 2

Select from the following modulation destinations. You can find out more about these parameters and how they affect the sound in their respective sections (to learn how Pitch Envelope Attack affects the sound, see page 74 on Pitch Envelopes).

- | | | |
|-------------------------|---------------------------------|---------------------------|
| • Pitch | • Filter Cutoff | • Amplitude |
| • Effect Send | • Pitch LFO Speed | • Pitch LFO Amp |
| • Pitch LFO Delay | • Pitch Envelope Delay | • Pitch Envelope Attack |
| • Pitch Envelope Decay | • Pitch Envelope Sustain Decay | • Pitch Envelope Release |
| • Pitch Envelope Amp | • Filter LFO Speed | • Filter LFO Amp |
| • Filter LFO Delay | • Filter Envelope Delay | • Filter Envelope Attack |
| • Filter Envelope Decay | • Filter Envelope Sustain Decay | • Filter Envelope Release |
| • Filter Envelope Amp | • Amp LFO Speed | • Amp LFO Amp |
| • Amp LFO Delay | • Amp Envelope Delay | • Amp Envelope Attack |
| • Amp Envelope Decay | • Amp Envelope Sustain Decay | • Amp Envelope Release |
| • Amp Envelope Amp | • Portamento Rate | |

Modulation Level (-99 to +99)

Page 3

At +00, the modulation source has no effect on the destination. Higher positive values increase the amount of modulation. Negative values also increase the amount of modulation, but with negative phase (i.e., if the modulation would normally be increasing with depth set to a positive number, the modulation would instead be decreasing at that same moment had the depth been set to a negative number).

Gate Mode (Off or On)

Page 4 (Mods 1 - 3 Only)

The Gate Mode function is available only on modulation routings 1 through 3. When Gate Mode is on, the Modulator will only be routed while notes are being played. In other words, you can gate the effect of the Modulator so that it stops when you are not playing any notes. This can be used on sounds with medium to long release times, where an interesting effect (like tremolo) is intended to be active while holding notes down, but deactivated as the sound is fading away after being released.

Quantize Mode (Off or On)

Page 4 (Mods 4 - 6 Only)

The Quantize Mode function is only available in modulation routings 4 through 6. When Quantize Mode is on, the modulation effect will be stepped. When off, the effect will be smooth, or linear. *Example:* If you were to route the Modulation Wheel to Pitch with an amplitude of +99, moving the Mod Wheel while the Quantize parameter was off would cause the pitch of a held note to slide up, much the same way it does when the Pitch Bend Wheel is used. However, moving the Mod Wheel while the Quantize parameter was on would cause the pitch of a held note to rise in half-step increments.

PITCH LFO

The Pitch LFO function is most often used to apply vibrato to a sound.



The following Pitch LFO variables will make a difference in the sound only if the PITCH LFO DEPTH (on Page 6 of the PITCH function) is set to a value other than 0, or, if the Pitch LFO is a source in the MOD function.

Shape (8 choices)

Page 1

The waveform shape determines the shape of the LFO. Select either Sine, Triangle, Square, Up Saw, Down Saw, Random+-, Noise or Random+. Note that the two Sawtooth waves and the Random+ wave are unipolar and the rest are bipolar:

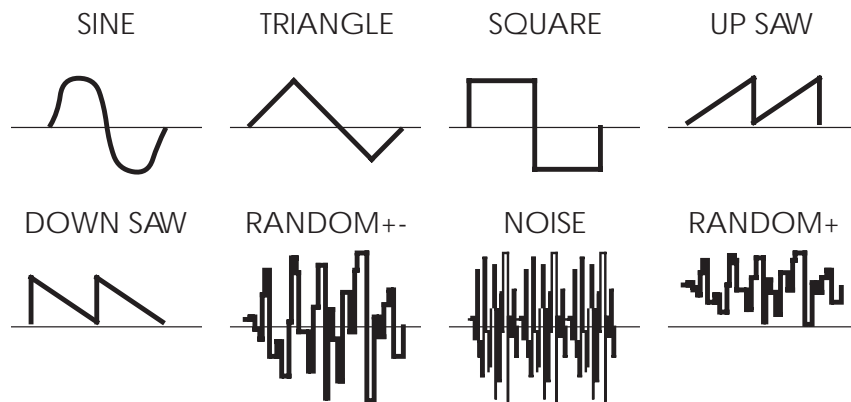

Speed (00 to 99)

Page 2

Controls the speed or rate of the LFO. For fast modulation, increase this value. For slower modulation, decrease this value.

Delay (00 to 99)

Page 3

This is the amount of time that is to occur before the LFO fades in. Sometimes, it is desirable to have modulation come in a moment or two after a note has been played, rather than starting instantly. The higher the value, the slower the LFO fades in.

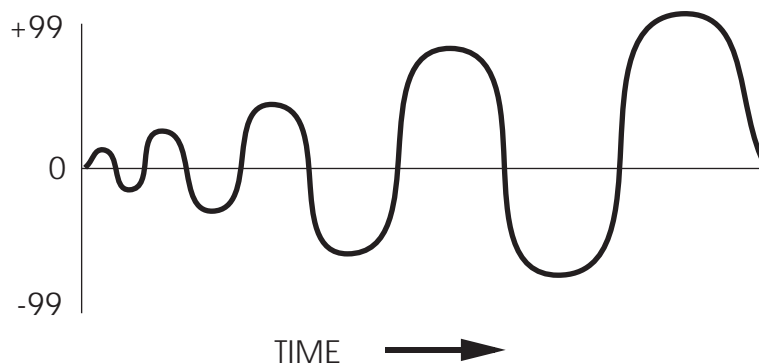

Trigger (Mono, Poly, Key Mono, or Key Poly)**Page 4**

The Trigger parameter determines how the LFO should be triggered, or started. There are four possible settings: Mono, Poly, Key Mono and Key Poly. When playing multiple voices in a single sound, each voice has its own LFO. However, the LFO Trigger parameter determines whether or not they should be in sync, and whether or not they can be retriggered independent from one another.

Mono. All voices' LFOs are in sync with each other. If you hold a chord and then play new notes on top of the chord, all voices' LFOs will be moving in the same direction and at the same speed. Because of this, modulating the LFO Speed using a voice-specific source (such as velocity or one of the envelopes, for example) will have no effect (you will be allowed to do this, but you won't hear any difference). This is because these modulation sources are meant for polyphonic purposes. These include: Note Number, Velocity, Release Velocity, Pitch/Filter/Amp LFO, Pitch/Filter/Amp Envelope, Random, Trig Rate and Tracking Generator. However, modulation sources which are not voice-specific will still have an effect while the LFO Trigger is set to MONO. These include: Aftertouch, Mod Wheel, Pitch Wheel, MIDI Volume, Sustain Pedal, Pedal 1, Pedal 2, and Controllers A-D.

Poly. Each voice's LFO is independent. If you hold a chord, some voices' LFOs will be moving in one direction while others move in the other direction. If the LFO Speed is being modulated (by one of the envelopes, for example), the LFO's of each voice may be running at different speeds.

Key Mono. This is identical to MONO, but whenever a new note is played, the LFO is retriggered, instead of continuing from wherever it may be in its cycle.

Key Poly. This is almost identical to POLY, but whenever a new note is played, the LFO is retriggered, instead of continuing from wherever it may be in its cycle.

Level (00 to 99)**Page 5**

This is the base output level of the Pitch LFO. If you want to have a constant value of vibrato, even without using the Mod Wheel or Aftertouch, set LEVEL above 00. The Mod Wheel and Aftertouch will add or subtract from this base level. *Example:* If Level is set to 10 and the Mod Wheel parameter is set to 10, there will always be some vibrato, and raising the Mod Wheel will add more vibrato. On the other hand, if the Mod Wheel parameter is set to -10, raising the Mod Wheel to the top will cancel out all vibrato.

Mod Wheel Depth (-99 to 99)**Page 6**

This is the modulation amount of the Mod Wheel over the Pitch LFO's Level. A positive value raises the level when the Mod Wheel is moved up, and lowers the level when moved down. Negative settings of this parameter will decrease the output level of the Pitch LFO as the Mod Wheel is raised. Since the output level of the Pitch LFO cannot be less than zero, a negative setting of the Mod Wheel parameter will have no effect unless either the Aftertouch or the Level is set to raise the Pitch LFO output. If both the Level and Aftertouch are set to 00, and the Mod Wheel parameter is set to -99, the Mod Wheel will have no effect on the vibrato from the Pitch LFO.

Aftertouch Depth (-99 to 99)**Page 7**

This is the modulation amount of Aftertouch over the Pitch LFO's Level. A positive value raises the level as more Aftertouch is applied. A negative value will lower the amount of Pitch LFO level as more Aftertouch is applied.

FILTER LFO

The Filter LFO function is most often used to apply tremolo-like or "wah-wah" effects to a sound.



The following Filter LFO variables will affect the sound only if the FILTER LFO DEPTH (on Page 6 of the FILTER function) is set to a value other than 0, or, if Filter LFO is a source in the MOD function.

Also note that the Filter LFO may have no effect if some other modulation source or setting has already pushed the filter cutoff frequency to its maximum.

Wave (8 choices)**Page 1**

The waveform determines the shape of the LFO. Select either Sine, Triangle, Square, Up Sawtooth, Down Sawtooth, Random+-, Noise or Random+. For a graphic representation of these waveforms, see the diagram in the Wave section of the Pitch LFO description on page 76.

Speed (00 to 99)**Page 2**

Controls the speed or rate of the LFO. For fast modulation, increase this value. For slower modulation, decrease this value.

Delay (00 to 99)**Page 3**

This is the amount of time that is to occur before the LFO fades in. Sometimes, it is desirable to have modulation come in a moment or two after a note has been played, rather than starting instantly. The higher the value, the slower the LFO fades in.

Trigger (Mono, Poly, Key Mono, or Key Poly)**Page 4**

The Trigger parameter determines how the LFO should be triggered, or started. There are four possible settings: Mono, Poly, Key Mono and Key Poly. A description of these settings is found in the Trigger section of the Pitch LFO description on page 77.

Level (00 to 99)**Page 5**

This is the base output level of the Filter LFO. If you want to have a constant value of tremolo to the filter, even without using the Mod Wheel or Aftertouch, set LEVEL above 00. The Mod Wheel and Aftertouch will add or subtract from this base level. *Example:* If Level is set to 10 and the Mod Wheel parameter is set to 10, there will always be some filter tremolo, and raising the Mod Wheel will add more tremolo. On the other hand, if the Mod Wheel parameter is set to -10, raising the Mod Wheel to the top will cancel out all tremolo.

Mod Wheel Depth (-99 to 99)**Page 6**

This parameter sets how much the Mod Wheel will increase or decrease the Filter LFO's Level. A positive value raises the level when the Mod Wheel is moved up, and lowers the level when moved down. Negative settings of this parameter will decrease the output level of the Filter LFO as the Mod Wheel is raised. Since the output level of the Filter LFO cannot be less than zero, a negative setting of the Mod Wheel parameter will have no effect unless either the Aftertouch or the Level is set to raise the Filter LFO output. If both the Level and Aftertouch are set to 00, and the Mod Wheel parameter is set to -99, the Mod Wheel will have no effect on the tremolo from the Filter LFO.

Aftertouch Depth (-99 to 99)**Page 7**

This is the modulation amount of Aftertouch over the Filter LFO's Level. A positive value raises the level as more Aftertouch is applied. A negative value will lower the amount of Filter LFO level as more Aftertouch is applied.

AMP LFO

The Amp LFO function is usually used to add tremolo to a sound.



The Amp LFO variables will have an effect only if the AMP LFO DEPTH (in the AMP function, page 3) is set to a value other than 0, or, if Amp LFO is a source in the MOD function.

Wave (8 choices)**Page 1**

The waveform determines the shape of the LFO. Select either Sine, Triangle, Square, Up Sawtooth, Down Sawtooth, Random+-, Noise or Random+. See the diagram in the Wave section of the Pitch LFO description on page 76.

Speed (00 to 99)**Page 2**

Controls the speed or rate of the LFO. For fast modulation, increase this value. For slower modulation, decrease this value.

Delay (00 to 99)**Page 3**

This is the amount of time that is to occur before the LFO fades in. Sometimes, it is desirable to have modulation come in a moment or two after a note has been played, rather than starting instantly. The higher the value, the slower the LFO fades in.

Trigger (Mono, Poly, Key Mono, Key Poly)**Page 4**

The Trigger parameter determines how the LFO should be triggered, or started. There are four possible settings: Mono, Poly, Key Mono and Key Poly. A description of these settings is found in the Trigger section of the Pitch LFO description on page 77.

Level (00 to 99)**Page 5**

This is the base output level of the Amp LFO. If you want to have a constant value of tremolo, even without using the Mod Wheel or Aftertouch, set Level above 00. The Mod Wheel and Aftertouch will add or subtract from this base level. *Example:* If Level is set to 10 and the Mod Wheel parameter is set to 10, there will always be some tremolo, and raising the Mod Wheel will add more tremolo. On the other hand, if the Mod Wheel parameter is set to -10, raising the Mod Wheel to the top will cancel out all tremolo.

Mod Wheel Depth (-99 to 99)**Page 6**

This is the modulation amount of the Mod Wheel over the Amp LFO's Level. A positive value raises the level when the Mod Wheel is moved up, and lowers the level when moved down. Negative settings of this parameter will decrease the output level of the Amp LFO as the Mod Wheel is raised. Since the output level of the Amp LFO cannot be less than zero. A negative setting of the Mod Wheel parameter will have no effect unless either the Aftertouch or the Level is set to raise the Amp LFO output. If both the Level and Aftertouch are set to 00, and the Mod Wheel parameter is set to -99, the Mod Wheel will have no effect on the tremolo from the Amp LFO.

Aftertouch Depth (-99 to 99)**Page 7**

This is the modulation amount of Aftertouch over the Amp LFO's Level. A positive value raises the level as more Aftertouch is applied. A negative value will lower the amount of Amp LFO level as more Aftertouch is applied.

TRACKING GENERATOR

The Tracking Generator function is used to scale a modulation source. For example, normally you could modulate the Amp (volume) of a sound using velocity; the harder you play, the louder the sound gets. The amount of change in volume is equal to the change in velocity; this is called linear control. If instead, however, you set the Tracking Generator's input to "velocity", and then routed the Tracking Generator to the Amp (using the Mod function), you can make your own customized "map" of the control velocity has over the sound's level.

The Tracking Generator divides the range of the input into 11 points (0-10), each of which can be set between 0 and 100. If you boost the value of one of the lower points, you make the input more sensitive in its lower register. By creating a non-linear curve using the velocity example above, you can scale the velocity's control over the sound's volume just the way you want.

When selecting the Tracking Generator as a modulation source in the Mod Function, these two choices will be available. When "TRACKGEN" is selected as the modulation source, the Tracking Generator functions normally, scaling its input as determined by its parameter settings.

When "STEPTRACK" is selected as a modulation source, the Tracking Generator's output will be stepped, or interpolated. This means that instead of scaling the input linearly from point to point, the input is kept at each point's value setting until it goes beyond the following point's value setting, at which point it jumps to that setting. This feature is very useful in creating "mini-sequences" if the modulation

destination is set to “Pitch” and the Tracking Generator’s input is an LFO using an “Up Sawtooth” as its waveform.

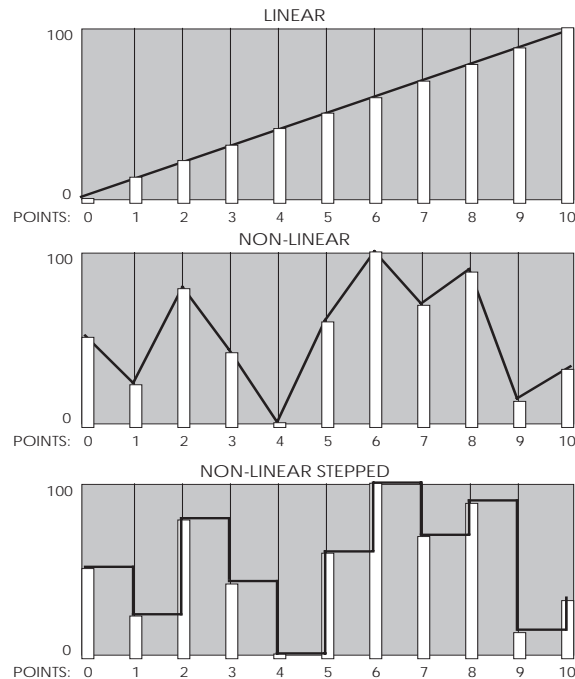

TIP: The Tracking Generator can be used to turn a variable control, such as the Mod Wheel or velocity, into a switch by setting all of the points to 0 except for point 10. Only near the maximum input will anything other than 0 come out of the Tracking generator. You can patch the Mod Wheel somewhere else in addition to the Tracking Generator, giving you gradual control of one function with the full range of the Mod Wheel, while switching on a second function only at the top of the wheel.

However, the Tracking Generator interpolates between steps; this is sort of like playing “connect the dots.” In other words, the Tracking Generator does not step directly from one point to the next, but ramps from point to point.

Tracking Input

Page 1

Select the input of the Tracking Generator from the following sources:

- Note Number
- Poly Pressure
- Sustain Pedal
- Filter LFO
- Amp Envelope
- Velocity
- Mod Wheel
- Pedal 1
- Amp LFO
- Random
- Release Velocity
- Pitch Wheel
- Pedal 2
- Pitch Envelope
- Trig Rate
- Aftertouch
- MIDI Volume
- Pitch LFO
- Filter Envelope
- Controllers A–D

For detailed descriptions of each of these sources, see the section “Modulation Source” in the Mod section on pages 73–75.

Tracking Points 0 – 10 (00–100)

Pages 2–12

The remaining pages of the TRACK function control the levels of points 0–10.

PROGRAMMING DRUM SOUNDS

To program a sound in Drum Mode, you must first set the Sound Type to “Drum” for that particular sound in the Voice Function, page 2 (see previous section). When editing a Sound in Drum Mode, check the upper-middle section of the display (SID¹ through SID⁴) to determine which Drum Sound layer you are editing, regardless of which Function or Page is selected (except Effect, Name and Misc.). For an explanation of the basics of Drum Mode, see page 53.

VOICE

The Voice function is where you choose the particular sample for the selected Drum (1–10). Similar to the normal Assign Voice function, sounds are divided into groups. After selecting the group (on page 3), you then select the sample within the group (on page 4). Here is a chart listing the various drum samples in their respective groups.

Group	Voice
Kick	FloppyKik1, FloppyKik2, FloppyKikV, MasterKik1, MasterKik2, MasterKikV, MetalKick1, MetalKick2, MetalKickV, GrooveKik1, GrooveKik2, GrooveKikV, Sharp Kick, Tek Kick 1, Tek Kick 2, Tek Kick V, AnalogKik1, AnalogKik2, AnalogKik3, AnalogKikV, Rap Kick
Snare	Fat Wood 1, Fat Wood 2, Fat Wood V, HR Snare 1, HR Snare 2, HR Snare V, MasterSnr1, MasterSnr2, MasterSnrV, Piccolo 1, Piccolo 2, Piccolo V, Electronc1, Electronc2, ElectroncV, Rap Snare1, Rap Snare2, Tek Snare1, Tek Snare2, Tek SnareV, Brush Hit1, Brush Hit2, Brush HitV, Crosstick1, Crosstick2, CrosstickV
Toms	HiRackTom1, HiRackTom2, HiRackTomV, MdRackTom1, MdRackTom2, MdRackTomV, LoRackTom1, LoRackTom2, LoRackTomV, HiFlrTom 1, HiFlrTom 2, HiFlrTom V, MidFlrTom 1, MidFlrTom 2, MidFlrTom V, LowFlrTom1, LowFlrTom2, LowFlrTomV, CanonTomH1, CanonTomH2, CanonTomHV, CanonTomM2, CanonTomMV, CanonTomL1, CanonTomL2, CanonTomLV, Hex Tom Hi, Hex Tom Md, Hex Tom Lo, RapTomHi, RapTomMid, RapTomLow
Cymbal	ClosedHat1, ClosedHat2, ClosedHatV, Tight Hat, Loose Hat, Slosh Hat, Foot Hat 1, Foot Hat 2, Velo Hat 1, Velo Hat 2, Velo Hat 3, TekHatClsd, TekHatOpen, RapHatClsd, RapHatHalf, RapHatOpen, CricktHat1, CricktHat2, FilterHat1, FilterHat2, FilterHat3, Ride Cym, Ride Cym 2, RideCym V1, RideCym V2, RideBell 1, RideBell 2, RideBell V, Crash Cym1, Crash Cym2, SplashCym1, SplashCym2, SplashCym3, China Cym1, China Cym2, RapCymbal1, RapCymbal2, RapCymWave, Open Hat 1 , Open Hat 2 , Open Hat 3 , Open Hat V , RideCym V3
Percus	Agogo Hi, Agogo Low, Bongo Hi, Bongo Low, Brake Drum, Cabasa, Castanet, Chimes 1, Chimes 2, Clap Rap, Clap Tek, Clave, Conga Hi, Conga Low, Conga Slap, RapCongaHi, RapCongaMd, RapCongaLo, Rap Rim, Rap Tone, Cowbell, RapCowbell, Cuica, Djembe Hi, Djembe Low, Drumstix, FingerSnap, Guiro Long, Guiro Med, GuiroShort, Ice Block, Kalimba Hi, KalimbaLow, Maracas, SambaWhstl, SambaShort, Shaker1 Hi, Shaker1Low, Shaker2 Hi, Shaker2Low, Sleighb1 1, Sleighb1 2, SteelDrmHi, SteelDrmLo, TablaGa Hi, TablaGaLow, Tabla Ka, TablaNa Hi, TablaNaLow, Tabla Te, TablaTinHi, TablaTinLo, Taiko Hi, Taiko Low, Taiko Rim, Talk Up Hi, Talk Up Lo, TalkDownHi, TalkDownLo, Tambourin1, Tambourin2, Timbale Hi, TimbaleLow, Timpani Hi, TimpaniMid, TimpaniLow, Triangle, TriangleSf, Udu Hi, Udu Mid, Udu Low, Udu Slap, Vibrasmack, WoodBlokHi, WoodBlokLo

Snd FX	Bird Tweet, Bird Chirp, Bird Loop, Fret Noise, Fret Wipe, Orch Hit, Dance Hit, Jungle 1, Jungle 2, Applause, GoatsNails, Brook, Hi Bow, Low Bow, ShapeNzHi, ShapeNzMid, ShapeNzLow, ScrtchPull, ScrtchPush, ScrtchLoop, ScrtchPILp, ScrtcPshLp, RezAttkHi, RezAttkMid, RezAttkLow, RezZipHi, RezZipMid, RezZipLow, Zap 1 Hi, Zap 1 Mid, Zap 1 Low, Zap 2 Hi, Zap 2 Mid, Zap 2 Low, Zap 3 Hi, Zap 3 Mid, Zap 3 Low, FltrNzLoop, Romscape, Rain, Telephone, Sci Loop 1, Sci Loop 2, Sci Loop 3, Bit Field1, Bit Field2, Bit Field3, Bit Field4, Bit Field5, Bit Field6, WavLoop1.0, WavLoop1.1, WavLoop1.2, WavLoop1.3, WavLoop1.4, WavLoop1.5, WavLoop1.6, WavLoop1.7, WavLoop1.8, WavLoop2.0, WavLoop2.1, WavLoop2.2, WavLoop2.3, WavLoop2.4, WavLoop2.5, WavLoop2.6, WavLoop2.7, WavLoop2.8, WavLoop3.0, WavLoop3.1, WavLoop3.2, WavLoop3.3, WavLoop3.4, WavLoop3.5, WavLoop4.0, WavLoop4.1, WavLoop4.2, WavLoop4.3, WavLoop4.4, WavLoop4.5, D-Scrape, D-ScrapeLp
Wave	High Sine, Mid Sine, Low Sine, HiWhitNoiz, MidWhtNoiz, LowWhtNoiz, HiSpectral, LoSpectral, HiCrickets, LoCrickets, Inharm 1, Inharm 2, High Saw, Low Saw, High Pulse, Low Pulse, Hi AcidRez, LowAcidRez, Metal Wave, HiMetlMute, LoMetlMute, Hi DistGtr, LowDistGtr, Hi PwrHarm, LowPwrHarm, Hi FunkGtr, LowFunkGtr, Hi MuteGtr, LowMuteGtr, HiElecHarm, LoElecHarm, ClsclHarm, HiBassHarm, MidBassHrm, LowBassHrm, HiSlpBass, LoSlpBass, Hi BassPop, LowBassPop, Muted Bass, Stik Bass, StudioBass, JazzFingrd, JazzPic, Fretless, AcousBass, 60's Combo, Hi Piano, Mid Piano, Low Piano, High Sync, Low Sync, Hi Synth, LowSynth, Ahhs High, Ahhs Mid, Ahhs Low, Oohs High, Oohs Mid, Oohs Low, TunePipeHi, TunePipeMd, TunePipeLo
Rhythm	Psi Beat 1, Psi Beat 2, Psi Beat 3, Psi Beat 4, Psi Beat 5, Psi Beat 6, Psi Beat 7, Psi Beat 8, Psi Beat 9, Psi Beat10, Psi Beat11, Psi Beat12, Kick Loop1, Kick Loop2, Kick Loop3, Kick Loop4, Kick Loop5, Kick Loop6, Kick Loop7, Kick Loop8, Kick Loop9, KickLoop10, KickLoop11, Snare Lp 1, Snare Lp 2, Snare Lp 3, Snare Lp 4, Snare Lp 5, Snare Lp 6, Snare Lp 7, Snare Lp 8, Snare Lp 9, SnareBeat1, SnareBeat2, SnareBeat3, SnareBeat4, SnareBeat5, Back Beat1, Back Beat2, Back Beat3, Back Beat4, Hat1 Clsd1, Hat1 Clsd2, Hat1 Foot, Hat1 Open1, Hat1 Open2, Hat2 Clsd1, Hat2 Clsd2, Hat2 Foot, Hat2 Open1, Hat2 Open2, Hat3 Clsd1, Hat3 Clsd2, Hat3 Open1, Hat3 Open2, Hat Beat 1, Hat Beat 2, Hat Beat 3, Hat Beat 4, Hat Beat 5, Hat Beat 6, Hat Beat 7, Hat Beat 8, Hat Beat 9, Hat Beat10, Agogo, Bongo Loop, CabasaLoop, CastanetLp, CongaLoop1, Shaker Lp1, Shaker Lp2, SleighLoop, Tabla Ga Lp, Tabla Ka Lp, Tabla Na Lp, Tabla Te Lp, TablaTin Lp, Taiko Loop, PercBeat1, PercBeat2, PercBeat3, PercBeat4, VoiceLoop1, VoiceLoop2, Phonic Loop, SpinalLoop, Tri Loop, Tri Loop 2, Orch Loop

LEVEL

Each of the 10 drums in a sound can have its own level, pan position, and output assignment. The Level function provides these controls. Use page 1 to adjust the selected drum's level (00 to 99), page 2 to adjust pan position (<3 to 3>), page 3 to select the Output assignment (Main, Aux or Off). Page 4 lets you adjust the Effect Send level (00 to 99), and page 5 lets you select the Effects Bus (1, 2, 3 or 4).

TIP: To send a drum to an individual output, use Output in conjunction with Pan.
Example: Panning a drum full left and selecting the Aux outputs means that the drum will appear at only the left Aux output.

PITCH

The Pitch function lets you transpose the selected drum up or down one octave in micro-step (1/4th of a half step) increments, and lets you modulate the drum's pitch with velocity.

Tune (-12.00 to +12.00)

Page 1

Determines the tuning of the selected drum (±12.00).

Velocity>Pitch (0 to 7)

Page 2

Selects how much velocity will affect the selected drum's tuning (0-7). When this value is set to 7, the drum will be played sharp when the associated note is played hard; when played soft, the drum's tuning will be unaltered.

FILTER

Velocity>Filter (0 to 3)

Page 1

The Filter function lets you control the "brightness" of the selected drum by modulating the filter frequency with velocity. When set to 3, playing the associated note will result in a brighter sound (more high frequencies), while playing softer will result in a duller sound (less high frequencies). When this parameter is set to 0, velocity will have no affect on the filter.

AMP/RANGE

Velocity Curve (13 choices)

Page 1

Page 1 of the Amp/Range function lets you select one of 13 velocity curves. This determines how the drum will respond to the dynamics of your playing the keyboard. A LINEAR curve is the norm, whereby the increase in level is equal to the increase in velocity; the velocity values increase as you play harder. Many of the Velocity Curves make up sets to be used by 2, 3 or 4 drums in order to facilitate velocity crossfading, whereby a different drum is played depending on how hard or soft the keyboard is played. However, each drum must be in a different sound layer of the Program in order to be stacked on the same note.

If you want to create your own velocity crossfading Program, assign the related versions of the same drum samples ("Conga High" and "Conga Lo") the same key in different Program Sound layers, then use the appropriate velocity curves for each drum (in a three-way velocity split, drum 1 would use curve "1 of 3," drum 2 would use curve "2 of 3" while drum 3 would use "3 of 3"). For more details about the 13 velocity curves, see the illustration on page 62.

Note # (000 to 127/C-2 to G8)

Page 2

Each drum can be assigned to a single note which will trigger the drum sound when played. While the Lower Limit parameter's value is selected in the display (the cursor appears beneath it), you can set the note assignment by tapping the key on the keyboard you want to set as the note for the drum.



Only one drum can be assigned to a single note within a single Program sound. If more than one drum in a sound is assigned to the same note, only the higher number drum will sound.

Note # Range (0 to +3)

Page 3

Each drum can be assigned a range of notes (up to 3) above the root note which will trigger the drum sound when played. This parameter specifies the note range of the selected drum (0 to +3).

AMP ENVELOPE

Decay (0 to 99, Gate00 to Gate99)

Page 1

Page 1 in the Amp Envelope Function lets you adjust the Decay time of the selected drum (00 to 99, Gate00 to Gate99). If this is set to 0, only the very beginning of the drum sample is played; setting this to 99 will cause the entire drum sample to play. When set above 99, the Decay uses a gated mode. The Decay can still be set between 0 and 99, but in 5-step increments (e.g., Gate00 = Decay setting of 0 with gating, Gate05 = Decay setting of 5 with gating, etc.). Gating means that the drum sound will continue to be played as long as the key is held. This is useful for longer sounds, like cymbals, when you wish to hear a short crash by playing a short note but can still hear a longer crash by keeping the note held down.

Mute Group (Off, 1, 2, or 3)**Page 2**

This is an important feature when using multiple sounds of the same instrument. Mute Groups allow multiple drums to share a single voice. For example, if you have assigned a Closed Hat and an Open Hat to two different notes, playing either note should cut-off the other (if it had recently been played). This creates a more realistic sound, since an actual Hi Hat is only capable of making one sound at a time.

In the Amp Envelope function, Page 2 is used to assign the selected drum to one of the three Mute Groups. In our example above, both Hi Hat drums would be assigned to the same Mute Group. The additional Mute Groups can be used by other sounds that you wish to cut-off each other, but do not want to interfere with the Hi Hat sounds.

COPYING SOUNDS

While editing a Program, it is helpful to be able to copy a sound to another sound in either the same Program or a different Program, especially if you are building a split or layered Program. This can be done very easily from within the Store function. To copy a Sound to another sound in the same Program, or to the same sound in a different Program.

Follow the steps below to copy one of the four Sound layers from one Program to another Program in the User Bank. When copying Sounds between Programs, the “new” Sound will replace the same numbered Sound in the destination Program, i.e., Sound 3 will replace Sound 3.

- ① Press [PROG] to select Program Play Mode, then use the [VALUE] knob to select the Program Number that uses the Sound you want to copy. If necessary, use the BANK SELECT [DOWN] and [UP] buttons to select a different Bank.
- ② Press [STORE].
The [STORE] button will begin to flash.
- ③ Press [CURSOR ] once to advance to Page 2.
The upper section of the display will read:

```
COPY SOUND 1 TO  
SOUND 2 (STR)
```

- ④ Use the [VALUE] knob to select which of the four Sounds (1–4) you wish to copy from the currently select Program, or to select the Program Number in the User Bank you wish to copy the Sound from (000–127).
- ⑤ Press [CURSOR ] once to advance the cursor to the Program number value in the lower section of the display.
- ⑥ Use the [VALUE] knob to select which of the four Sounds (1–4) you wish to copy to in the currently select Program, or to select the Program Number in the User Bank you wish to copy the Sound to (000–127). .)
- ⑦ Press [STORE] to complete the copy function.

COPYING EFFECTS

While editing a Program, it is helpful to be able to copy the Effects Patch from a different Program. This can be done very easily from within the Store function.



Be sure to save your changes to the current edited Program before going to a new Program. Otherwise, all your changes will be lost.

To copy the Effects Patch from a Program to another Program:

- ① Press [PROG] to select Program Play Mode, then use the [VALUE] knob to select the Program Number that uses the Effects you want to copy. If necessary, use the BANK SELECT [DOWN] and [UP] buttons to select a different Bank.
- ② Press [STORE].
The [STORE] button will begin to flash.
- ③ Press [CURSOR *The upper section of the display will read:*

```

COPY EFFECT    TO
PROG 000 (STR)

```

- ④ Use the [VALUE] knob to select the Effects Patch of the currently selected Program, or any Program (000 - 127) in the User Bank to copy from.
- ⑤ Press [CURSOR - ⑥ Turn the [VALUE] knob to select the Program Number in the User Bank you wish to copy the Effects to (000-127), or the EFFECT of the currently selected Program.
- ⑦ Press [STORE] to complete the copy function.

CHAPTER 7

EDITING EFFECTS

ABOUT SIGNAL PROCESSING

The built-in effects processor of the QSR is similar to that of the Alesis QuadraVerb 2, capable of generating multiple, fully digital effects simultaneously. The QSR effects processor has four inputs, called effect sends. You might think of these as the typical post-fader sends found on a mixing console. In a Program, each of the four Sounds can be assigned to one of the four effect sends. In a Mix, each Program can use its own effects level and bus routing or you may override these by assigning the entire Program (all 4 of its sounds) to one of the four effect sends and all at the same level. Once you assign a Sound (in Program Edit Mode) or a Program (in Mix Edit Mode) to an effect send, you can adjust the Sound's/Program's Effect Send Level.

TIP: To route a Sound/Program only to an effect send, and not the Main or Aux outputs, assign the Output parameter of the Sound/Program to "OFF," assign its Effect Bus to one of the four effect sends, and adjust its Effects Level.

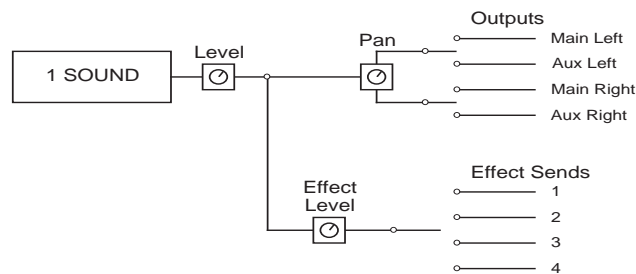

The Effect Patch's *Configuration* determines the arrangement of effect functions of each effect send. Imagine a Configuration as an arrangement of multiple effects processors patched together at the end of each effect send.

Example: In one configuration, effect send 3 has its own separate reverb, while in another configuration it has its own delay and a level control feeding a reverb shared with send 1. When you're programming effects, you will need to refer to the charts on pages 88–93 for the effect configuration you're using, so you will know how the paths from different effect functions interact.

The Effect functions consist of: Pitch, Delay, Reverb and in some cases Misc. (which provides access to special effects such as EQ and Overdrive). Each function has several types to choose from. For example, the Pitch effect can be either a chorus, a flange, a resonator, etc. The Reverb can be a large hall, plate, gated, etc. The effect types available for each effect function depends on the Configuration you are using. The parameters available for an effect function depend on the selected effect type. Some effect types have very few parameters, while others have many. For example, the stereo delay effect has about twice as many parameters as the mono delay effect (since the stereo delay has two adjustments—left and right—for several parameters). Consequently, the more parameters an effect has, additional pages become available for that function. Each effect has stereo outputs, which may be routed to the MAIN [LEFT] and [RIGHT] outputs using the Mix function (this is not the same as a *Mix*, but rather a function that mixes the effects' outputs together).

SELECTING AN EFFECTS PATCH IN MIX MODE

Each Program has its own Effects Patch that is recalled when you select a Program in Program Mode. However, since a Mix can have up to 16 Programs (one on each Channel), you need to select which Channel's Program you wish to use the Effects Patch from. To select an Effects Patch, you must be in Mix Edit Mode, by pressing the [EDIT] button once so that the display directly below the Mix Number reads either: "MIX EDIT" or "MIX EDITED".

- ① With the cursor in the upper display, use the [VALUE] knob to select the Effect function, then press [CURSOR ] to advance the cursor and turn the [VALUE] knob to select page 2.

The display should look like this:

```
EFFECT          P2
MIDI Chan:    01
```

- ② Press [CURSOR ] to advance the cursor; now you can select the Effect Channel by turning the [VALUE] knob.

This parameter lets you select which Channel (1–16) of the Mix whose Effects Patch you wish to use. If you set the Effect Channel to 1, the Mix will use the Effects Patch used by the Program on Channel 1. The Effect Channel is also used to determine what MIDI channel the Effects Patch will be set to for receiving MIDI controller information for the Modulators (see the Mod section later in this chapter for more on real-time MIDI control of effect parameters).

- ③ Press [ CURSOR] once and turn the [VALUE] knob counterclockwise.

The display will look like this:

```
EFFECT          P1
Prog Change:  ON
```

- ④ Press [CURSOR ] to advance the cursor; now you can turn the Effect Program Change function on and off by turning the [VALUE] knob.

The Effect Program Change parameter determines whether or not a MIDI Program Change message received on the Effects Channel should only recall a new Program ("Off") or if the Effects of the newly selected Program should be recalled as well ("On"). Usually you would want this off, so that the Effects in a Mix do not change even though you may select different Programs for the Effects Channel.

SETTING EFFECTS SEND LEVELS

The effect send levels and effect bus assignments are saved as part of a Program (from Program Edit Mode), or as part of each Channel in a Mix (from Mix Edit Mode). Keep in mind that these are separate from any changes that will be made to the Effects Patch itself. If you are in Mix Mode and change the settings in both Mix Edit and Effects Edit modes, you will have to STORE not only the Program that is on the Effect Channel (thus storing its Effects Patch) but the selected Mix as well, in order to have your changes remembered and heard the same way in the future. The actual arrangement of depth of reverb, delay time, etc., is saved as part of the Effects Patch when a Program is stored. It is possible for different Mixes to share the same

Effects Patch. So keep in mind that when you edit an Effects Patch, it may affect the sound of any other Mixes that also use it.

CLIP

If the input to the effects becomes overloaded, the “!” symbol will temporarily appear in the upper display (directly after the Mix/Program name) when in either Mix Play or Program Play Modes. If this should occur, try reducing the Input Levels for each of the effects devices in the current configuration, and (if necessary) reduce the Effects Levels in the Mix and/or Program.

EDITING EFFECTS

The Effects Patches themselves are not edited in Program Edit Mode or Mix Edit Mode, but (could you guess it?) Effects Edit Mode. You can enter Effects Edit Mode from Program Mode by pressing the [EDIT] button twice, or until the display looks something like this:

```
Send1: CONFIG P1
1 REVERB
```

In Program Mode, each time the [EDIT] button is pressed the display will alternate between Program Edit and Effects Edit Modes.

You can enter Effects Edit Mode from Mix Mode by pressing the [EDIT] button three times. In Mix Mode, each time the [EDIT] button is pressed the display will cycle between Mix Edit, Program Edit and Effects Edit Modes.

NAVIGATING

The basic method of navigating through the displays in Effects Edit mode is similar to that in Program Edit Mode and Mix Edit Mode.

- When the cursor appears near the word “Send” in the upper-left line of the display, the [VALUE] knob is used to select one of the four effects buses (1-4).
- When the cursor appears to the right of the word “#” in the upper line of the display, the [VALUE] knob is used to select an Effect Function (Configuration, EQ, Mod, Lezlie, Pitch, Delay, Reverb, Overdrive and Mix).
- Similar to Function Groups in Program Edit or Mix Edit modes, most Effect Functions consist of more than one page/parameter. When the cursor appears in the lower line of the display, the [VALUE] knob is used to scroll through a Function’s parameters.

The important thing to understand is the hierarchy of the displays. Think of it as a three dimensional game of Chess, where you can move among three different axes. Each function has 1 or more pages. But, the number of pages a function has available will differ when another effect send is selected (Send1 through Send4). For example, if you are using Configuration #1 and trying to edit the Reverb parameters, you would need to have effect send 1 selected, because that’s where the Reverb is located. So, you not only have to be aware of how to select a function and a page, but how to select the effect send as well.

Not all effects are available in each Configuration. For example, if you were to select the Pitch function on effect send 4 in Configuration #1, the display would read,

“<NOT IN CONFIG>.” This is because a Pitch module is available on sends 1, 2 and 3 in Configuration #1, but not on send 4—as you can see in the chart on page 92.

STORING EFFECT PATCHES IN PROGRAM MODE

Effects are an extension of a Program. So, when you store a Program, you store its Effects Patch along with it. Once a Program's Effect Patch has been altered, the display will show the word **"EDITED"** next to the Program/Mix Mode indicator in the lower-left corner of the display (if in Program Mode, the display will read **"PROG EDITED"** will appear; if in Mix Mode, the display will read **"MIX PROG EDITED"** will appear). The **"EDITED"** indicates that the current Effect Patch in the edit buffer is different from what is stored in memory for the selected Program.

While in Effects Edit mode, press [STORE] at any time to go to Store mode. Store mode has several pages, but the main storing function is found in the first page.



To store the edited Program along with its Effect Patch into the same location it was recalled from, simply press [STORE] again, and it will be stored. To store the edited Program into a different location, use the [VALUE] knob to select a Program number (000 – 127) in the User Bank. If a RAM Sound Card is inserted, use the BANK SELECT [DOWN] and [UP] buttons to select a different Bank. When you're ready, press [STORE] to save your Program.

STORING EFFECT PATCHES IN MIX MODE

When in Mix Play Mode or Mix Edit Mode, the Effect Program number shown in the display is the Program number selected as the Effect Channel. Storing the Mix will save this number, but will not store any changes you may have made to the Effect Patch itself.

- If [STORE] is pressed twice while editing a Program that is on the Effect Channel, both the Program and its Effects will be stored.
- If [STORE] is pressed twice while editing a Program that is on a Channel other than the Effect Channel, the edited Program will be stored without altering its previous Effects settings.
- If [STORE] is pressed twice while editing a Mix (Mix Edit Mode), only the Mix parameters will be stored, not the individual Programs or the Effects Patch.

COPYING EFFECT PATCHES

When you want a Program to use the Effects from a different Program, you must copy that other Program's Effects into the Program you are working on. This is done within Store Mode using the "Copy Effect" function. First, select the Program which contains the Effects you wish to copy. And, of course, you can only copy Effects to Programs that are in the User Bank or on a RAM Sound Card Bank.

For more about copying effects, see page 37.

CONFIGURATIONS

A Configuration is essentially the starting point of any Effects Patch. You must select the Configuration you are going to use before making any other edits, since all routings and parameters change to their default settings each time you change the configuration. Each Configuration is a unique arrangement of multiple effect blocks, distributed across the four effect sends. Some effect sends may have three different effects (pitch, delay and reverb) on them. Configurations also determine where the signal to a block comes from, and where the output of each block goes to -- the main outputs, the next effect in line, or even to an effect block belonging to another effect send. The Configuration diagrams on the next six pages provide a crucial "road map" you'll need to guide you through the many paths that are possible in each configuration. Refer to them as you program the effect.

The five Effect Configurations are:

- Configuration #1: 1 Reverb
- Configuration #2: 2 Reverbs
- Configuration #3: Lezlie and Reverb
- Configuration #4: Reverb and EQ
- Configuration #5: Overdrive and Lezlie

The Configuration function is used to select the Configuration for the Effects Patch you are editing. While in Effects Edit Mode, move the cursor to the Function field in the upper section of the display and turn the [VALUE] knob counterclockwise to select the Configuration function. The display should look like this (from Mix Edit Mode):

```
Send1: CONFIG  F1
1 REVERB
```

Press the [CURSOR ] button to advance the cursor to the lower line of the display, and turn the [VALUE] knob to select the Configuration. As you scroll through the various Configurations, each one's name will appear in the lower right section of the display.

The following is a run-down of the various Configurations:

CONFIGURATION #1: 1 REVERB

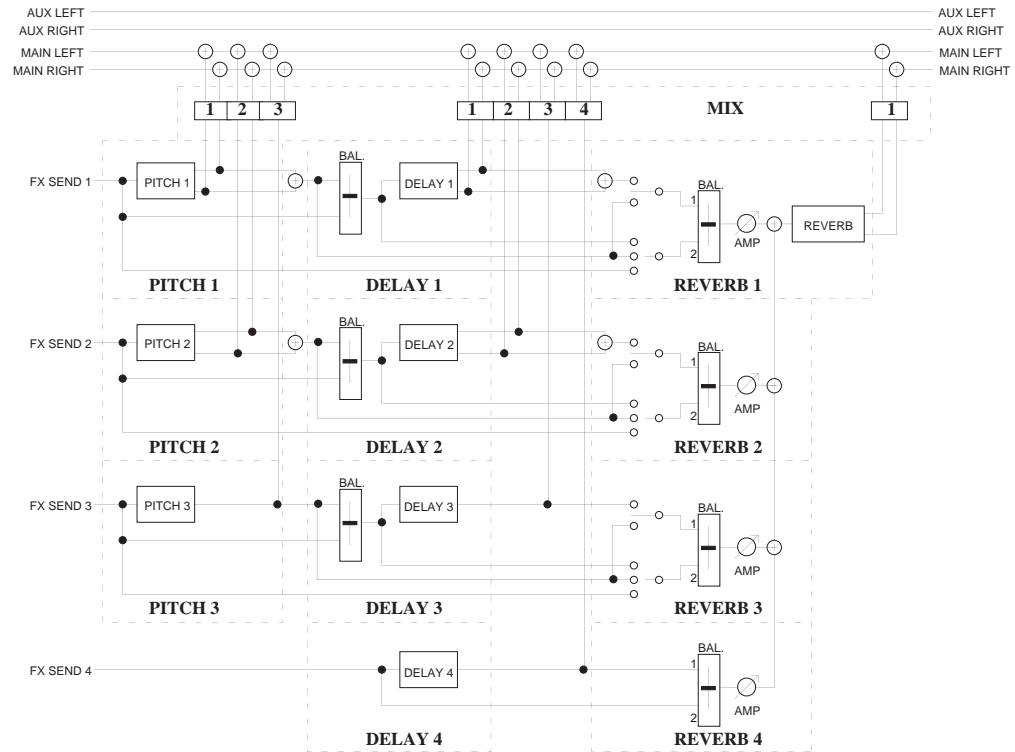

Pitch 1	Delay 1	Reverb 1
Mono chorus	Mono delay	Plate 1
Stereo chorus	Stereo delay	Plate 2
Mono flange	Ping-pong delay	Room
Stereo flange		Hall
Pitch detune		Large
Resonator		Gate
		Reverse

Pitch 2	Delay 2	Reverb 2
Mono chorus	Mono delay	Balance and level to Reverb 1
Stereo chorus	Stereo delay	
Mono flange	Ping-pong delay	
Stereo flange		
Pitch detune		
Resonator		

Pitch 3	Delay 3	Reverb 3
Resonator	Mono delay	Balance and level to Reverb 1

Delay 4	Reverb 4
Mono delay	Send/delay mix and level to
Reverb 1	

Think of the diagram as a “road map” showing all possible paths from the starting points (FX SEND 1 through 4) to the ultimate destinations (LEFT and RIGHT outputs at the top of the page). The dotted lines indicate the divisions between different functional blocks, and the solid lines indicate signal paths between the blocks and controls. The diagram is similar to a block diagram for a mixer, with signal moving generally from the left to the right. The number next to each function name represents one of the four effect sends. For example, Delay 2 refers to the Delay effect on effect send 2.

This Configuration #1 provides three Pitch effects, four Delay effects and one Reverb effect. The Pitch effects are found on effect sends 1, 2 and 3, but while the Pitch effects on sends 1 and 2 are stereo and their types are selectable (Mono Chorus, Mono Flange or Resonator), the Pitch effect on send 3 is mono and can only be used as a Resonator. Effect send 4 has no Pitch effect.

Each of the four sends has its own Delay effect, but while the Delay effects on sends 1 and 2 are stereo, the Delay effects on sends 3 and 4 are mono.

Each effect send can be routed through the Reverb. Since there is only one Reverb effect, it is found in the first effect send (see next section on Reverb). Reverb parameters that set the sound of the reverb itself (such as high and low decay, reverb type, predelay, etc.) are found only when “Send1” is selected. However, each of the 4 effect sends has controls for how much dry signal and how much effected signal are sent to the Reverb effect.

Example: The Reverb 2 block allows you to send signal to the reverb from four different points in the second effects chain: a) the send input itself, b) the output of Pitch 2, c) the input of Delay 2, or d) the output of Delay 2. You can even send a combination of these to the reverb. But to change any other reverb parameters, you must return to editing Reverb 1.

Each Pitch, Delay and Reverb module has its own independent Mix output level (i.e., how much of their output is routed directly to the Main Left and Right outputs). The Mix function is where you determine how the effects will actually be heard.

Mix 1, for example, is where you can control the outputs of Pitch 1, Delay 1, and Reverb 1 to the main outputs. The Mix parameter controls how much an effect block feeds directly to the main outputs, but doesn't control how much it feeds to any other blocks that may follow it. For example, when Pitch 1's Mix control is set to 0, it is still available as an input to Delay 1 and Reverb 1.

Think of the Mix function in the QSR's effects section as being similar to the effect return control on a mixing console. For example, if Effect Send 1's Mix Reverb Output parameter is set to 0, you won't be able to hear reverb regardless of how much input you feed it from any of the effect buses.

CONFIGURATION #2: 2 REVERBS

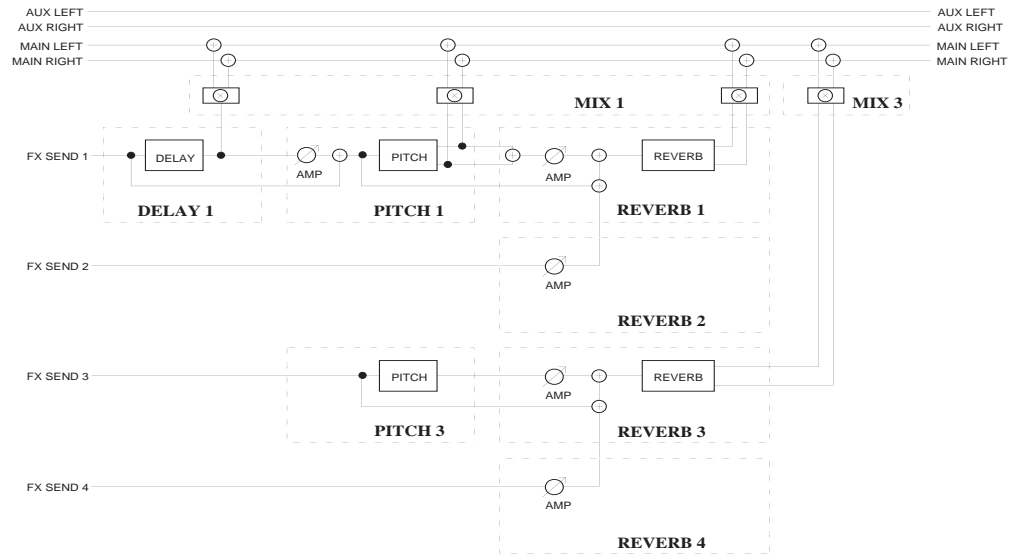

Delay 1	Pitch 1	Reverb 1
Mono delay	Mono chorus Stereo chorus	Plate 1 Plate 2 Room Hall Large Gate Reverse
		Reverb 2 Level to Reverb 1
	Pitch 3 Mono chorus	Reverb 3 Plate 1 Plate 2 Room Hall Large Gate Reverse
		Reverb 4 Reverb 4 Level to Reverb 3

This Configuration differs from Configuration #1 in many ways. In this Configuration, there is only one Delay effect, two Pitch effects and two Reverb effects. Effect send 1 is routed through the mono Delay, then a stereo Pitch effect, and finally a stereo Reverb effect. Send 2 has no effects of its own, but can be routed to the same Reverb effect as send 1. Send 3 is routed through a mono Pitch effect, and then a stereo Reverb effect. Send 4 has no effects of its own, but can be routed to the same Reverb effect as send 3.

Effect send 1's Delay, Pitch, and Reverb can feed the Mix output directly. Unlike the first configuration, however, Pitch 3 can be routed to the Mix only after passing through Reverb 3.

CONFIGURATION #3: LEZLIE AND REVERB

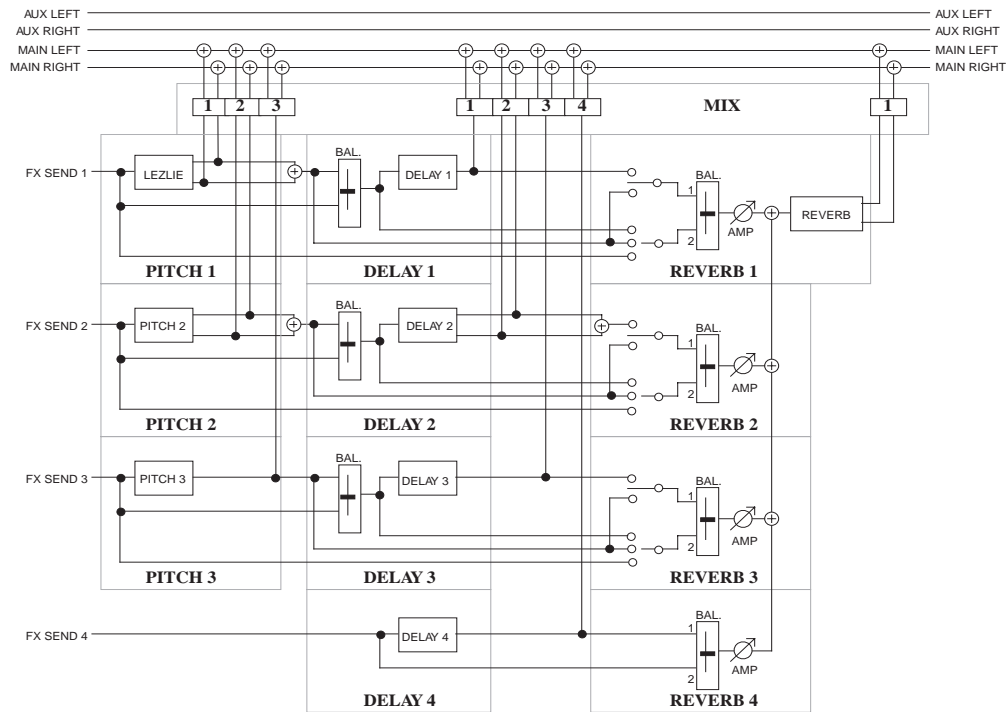

Pitch 1	Delay 1	Reverb 1
---------	---------	----------

Lezlie	Mono delay	Plate 1 Plate 2 Hall Room Hall Large Gate Reverse
--------	------------	--

Pitch 2	Delay 2	Reverb 2
---------	---------	----------

Mono chorus	Mono delay	Balance and level to Reverb 1
Stereo chorus	Stereo delay	
Mono flange	Ping-pong delay	
Stereo flange		
Pitch detune		
Resonator		

Pitch 3	Delay 3	Reverb 3
---------	---------	----------

Resonator	Mono delay	Balance and level to Reverb 1
-----------	------------	-------------------------------

Delay 4	Reverb 4
---------	----------

Mono delay	Mix and level to Reverb 1
------------	---------------------------

This Configuration is similar to Configuration 1, except it provides a stereo “Lezlie” effect on send 1, which emulates a rotating speaker effect commonly heard with organ sounds. This is followed by a Delay effect before going to the single stereo Reverb effect. Sends 2 and 3 have Pitch modules preceding Delay modules, which are then routed to Reverb 1. Send 4 has only a Mono Delay effect, which may also be routed to Reverb 1.

CONFIGURATION #4: REVERB AND EQ

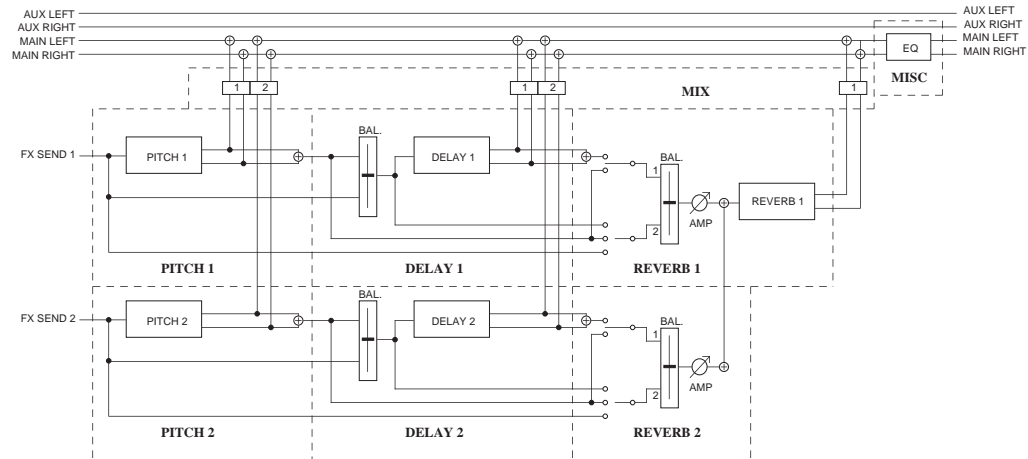

Pitch 1	Delay 1	Reverb 1
Mono chorus	Mono delay	Plate 1
Stereo chorus	Stereo delay	Plate 2
Mono flange	Ping-Pong delay	Room
Stereo flange		Hall
Pitch detune		Large
Resonator		Gate
		Reverse

Pitch 2	Delay 2	Reverb 2
Mono chorus	Mono delay	Balance and level to Reverb 1
Stereo chorus	Stereo delay	
Mono flange	Ping-Pong delay	
Stereo flange		
Pitch detune		
Resonator		

In this Configuration, note that Sends 1 and 2 are identical to that of Configuration #1. However, Sends 3 and 4 have been removed. In their place, we have added a shelving EQ module to the main outputs. This means you have bass and treble boost controls for all sounds coming out of the main outputs (not just the sounds routed to the Effects Sends).



If you are using Configuration #4, routing any of the Program's Sounds to Sends 3 or 4 will have no effect. In other words, it's as if you routed channels of your mixing console to effects sends that aren't connected to anything.

CONFIGURATION #5: OVERDRIVE AND LEZLIE

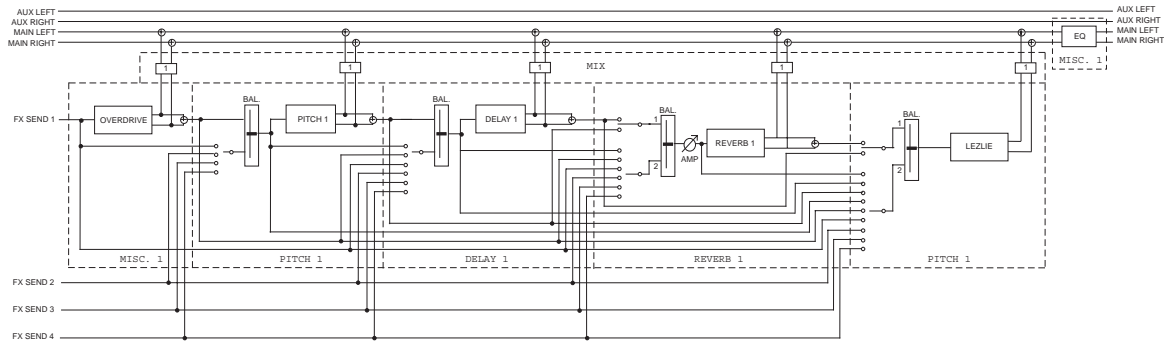

Pitch 1	Delay 1	Reverb 1
Mono chorus	Mono delay	Plate 1
Mono flange	Stereo delay	Plate 2
Resonator	Ping-Pong delay	Room
		Hall
		Large
		Gate
		Reverse

This is an “all-for-one” Configuration. You get six effects all at once, and they are all found in the Send 1 section. Send 1 feeds the Overdrive effect which provides classic distortion. The Overdrive output then feeds the Pitch effect. The Pitch effect has a second input which can come from either Sends 1, 2, 3 or 4. These two inputs can be mixed together.

The Delay effect has two inputs which can be mixed together. The first input comes from the Pitch effect’s output. The second input can come from either Sends 1, 2, 3 or 4, or the Overdrive effect’s output, or Pitch effects input.

The Reverb effect has two inputs which can be mixed together. The first input can come from the Pitch effect’s output or the Delay effect’s output. The second input can come from either Sends 1, 2, 3 or 4, or the Overdrive effect’s output, or the Delay effect’s input.

The Lezlie effect has two inputs which can be mixed together. The first input can come from the Delay effect’s output or the Reverb effect’s output. The second input can come from either Sends 1, 2, 3 or 4, or the Overdrive effect’s output, or the Pitch effect’s input or output, or the Delay effect’s input, or the Reverb effect’s input.

The outputs of all these effects are routed back to the Outputs, and sent through the shelving EQ effect.

EQ

The shelving EQ is only available in Configuration #s 4 and 5. It provides bass and treble boost, and effects the entire Main Output (not just the Effects Sends). Four EQ parameters are included: Low Frequency (range: 30Hz to 180Hz), Low Frequency Gain (0dB to +12dB), High Frequency (3kHz to 10kHz), High Frequency Boost (0dB to +9dB).

Lo EQ Frequency (30Hz to 180Hz) Page 1

This allows you to adjust the cutoff frequency of the Lo EQ. It can be set between 30Hz and 180Hz. If the Lo EQ Gain parameter is set above 0dB, all frequencies below and including the one selected by the Lo EQ Frequency parameter will be affected.

Lo EQ Gain (0dB to +12dB) Page 2

This controls how much boost will be applied to frequencies below and including the one selected by the Lo EQ Frequency. It can be set between 0dB and +12dB.

Hi EQ Frequency (3kHz to 10kHz) Page 3

This allows you to adjust the cutoff frequency of the Hi EQ. It can be set between 3kHz and 10kHz. If the Hi EQ Gain parameter is set above 0dB, all frequencies above and including the one selected by the Hi EQ Frequency parameter will be affected.

Hi EQ Gain (0dB to +9dB) Page 4

This controls how much boost will be applied to frequencies above and including the one selected by the Hi EQ Frequency. It can be set between 0dB and +9dB.

Mod

The Mod Function lets you control various effects parameters from the various controls on the QSR (keyboard, after-touch, pitch-bender, etc.) or from the MIDI input. This is extremely useful when dynamic or real-time control is required in a live playing situation. It is possible to control up to 2 parameters simultaneously. The Modulation assignments are saved with the Effects Patch.

Don't confuse this Mod Function with the Mod Function used by the Programs; they are independent destinations, though they can come from the same source.

Note: Modulating any effect parameter (with the exception of chorus speed) while audio is passing through it can result in audio artifacts or noises due to discontinuities in the modulation source.

SELECTING THE MODULATOR

There are two Modulators. Page 1 through 3 display the parameters of Modulator #1, while pages 4 through 6 display the parameters for Modulator #2.

Mod Source**Page 1 (Mod 1) & Page 4 (Mod 2)**

The Mod Source parameter selects the MIDI controller which will remotely cause a change (modulate) in one or two of the parameters in the effects processor. Nearly every MIDI controller can become a Mod Source (using controllers A-D, set in Global mode, page 3), with the most common controllers appearing as a direct option in the display. Pages 1 and 4 let you select the Mod Source for Mod 1 and 2, respectively. The options for the Mod Source are:

- Aftertouch
- Sustain Pedal
- Mod Wheel
- Pedal 1
- Pitch Wheel
- Pedal 2
- MIDI Volume
- Controllers A-D

Mod Destination**Page 2 (Mod 1) & Page 5 (Mod 2)**

The Mod Destination is the parameter that will be controlled by the selected Mod Source. Pages 2 and 5 let you select the Mod Destination for Mod 1 and 2, respectively. The possible Destination parameters are:

- Pitch Speed
- Pitch Balance
- Delay Level
- Reverb Decay
- Reverb Diffusion
- Overdrive Bright
- Lezlie Balance
- Lezlie Motor
- Pitch Depth
- Delay Time
- Reverb Balance
- Reverb Low Decay
- Reverb Level
- Overdrive Balance
- Lezlie Level
- Pitch Level
- Delay Feedback
- Reverb Input
- Reverb High Decay
- Overdrive Threshold
- Overdrive Level
- Lezlie Speed

If the selected Configuration has a particular effect on more than one effect send (for example, Config. #1 has a delay on each send), then some Mod Destination parameters will be listed more than once. For example, the Delay Time parameter will appear four times (“D1 Time,” “D2 Time,” “D3 Time,” and “D4 Time”). In the case of Pitch, where you can choose from various pitch effects, different parameters are available depending on the effect chosen. However, the Mod Destinations retain their names. *Example:* If the Resonator is the Pitch effect, the Pitch Speed Modulation Destination controls the first parameter in the Resonator (Tuning).

Mod Level**Page 3 (Mod 1) & Page 6 (Mod 2)**

The Mod Level is the amount that the Destination parameter will be affected by the Mod Source. Pages 3 and 6 let you adjust the Level parameter by a positive or negative amount. *Example:* If the Reverb Decay was selected as the Destination with the mod wheel as the Source, the mod wheel could be programmed to cause the Reverb to increase the decay (positive) or decrease the decay (negative).

LEZLIE

The Lezlie function is only available in Configuration #s 3 and 5. The Lezlie parameters found in Configuration 3 include: Motor (on/off), Speed (fast/slow), and Horn Level (-6 to +6 db). In addition to these, the Lezlie found in Configuration #6 also provides 3 additional parameters: Input 1, Input 2 and Input 1 & 2 Balance. The Lezlie in Configuration #3 takes its input from the Send 1 signal. In Configuration 5, the Lezlie can receive a combination of two inputs, which can be assigned to a variety of sources.

Motor (On/Off) Page 1 (Config. 3) or Page 4 (Config. 5)

This determines whether the Lezlie is operating or not. When turned on, the rotating speaker effect slowly starts up. When turned off, the effect slowly dies down until a complete stop. When using this parameter as a Mod Destination (see above), be sure to set it opposite of the Mod Level. *Example:* If the Mod Source is a footswitch and the level is at +100, set the Motor to "OFF" so that the footswitch turns on the motor when pressed and turns off the motor when released.

Speed (Slow/Fast) Page 2 (Config. 3) or Page 5 (Config. 5)

This determines the speed the rotating effect "spins".

Horn Level (-6 to +6 dB) Page 3 (Config. 3) or Page 6 (Config. 5)

This allows you to cut or boost the high frequency signal from the Lezlie effect from -6 to +6 dB, in 1 dB increments.

Input 1 & 2 Pages 1 & 2 (Config. 5 only)

Pages 1 and 2 of the Lezlie effect found in Configuration #5 lets you select from two possible input sources. Input 1 sources include: Reverb Output and Delay Output. Input 2 sources include: Send 1 – 4, Overdrive Output, Pitch Input, Pitch Output, Delay Input and Reverb Input.

Input Balance (<99 to <0> to 99>) Page 3 (Config. 5 only)

This parameter controls the Balance between the Input 1 and Input 2 signals going into the Lezlie effect. When set to "<99", only the signal coming from Input 1 is routed to the Lezlie. When set to "99>", only the signal coming from Input 2 is routed to the Lezlie. When set to "<0>", an even mix of both Input 1 and Input 2 are fed to the Lezlie.

PITCH

The Pitch function is used to edit Pitch parameters.

Pitch Type

Page 1

The Pitch Type function allows access to 6 pitch altering modes. The Pitch types available are: Mono Chorus, Stereo Chorus, Mono Flange, Stereo Flange, Pitch Detune and Resonator. Although some of these effects can sound similar to one another depending on the parameter settings, each is achieved differently and can be quite dramatic under the right circumstances. Pitch effects are achieved by splitting the signal into two parts, effecting the pitch of one of the parts, then mixing them back together. This eventual mixing is essential since the overall sound of the effect is achieved by the actual difference between the normal, unaffected signal and the effected signal.

```
Send1:PITCH P1
Type: MN CHORUS
```

So that you can better understand the differences between the Pitch type effects, and therefore better apply them to your music, here is a brief explanation of each.

Mono Chorus. The Chorus effect is achieved by taking part of the signal, slightly delaying it, and then slightly detuning it as well. The detuning is further effected by being modulated by an LFO which causes the detuning to vary. Many variables are available in this scheme. The LFO depth can be varied, the LFO speed can be varied, and a portion of the detuned signal can be fed back to the input to increase the effect. Finally, the waveform shape of the LFO can be changed from a smooth triangle to a more abrupt squarewave to make the pitch detuning more pronounced.

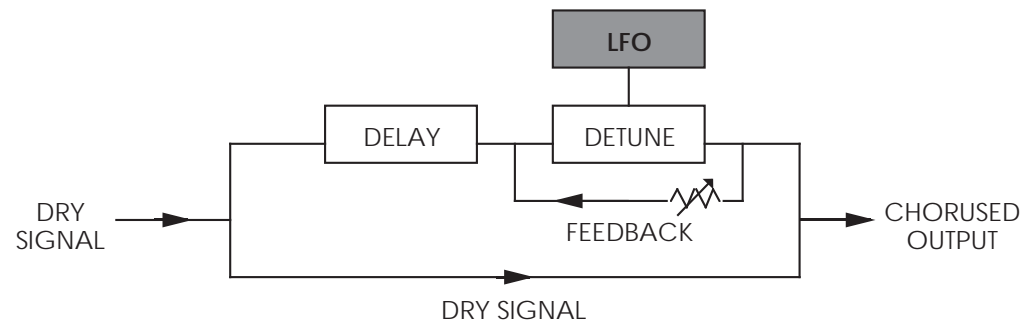

Stereo Chorus. In the case of a Stereo Chorus, the signal is split into three parts with a dry signal and a separate Detuning section for both left and right channels. When the left channel is detuned sharp, the right is detuned flat, and vice versa. Once again, this causes the effect to become more pronounced and dramatic.

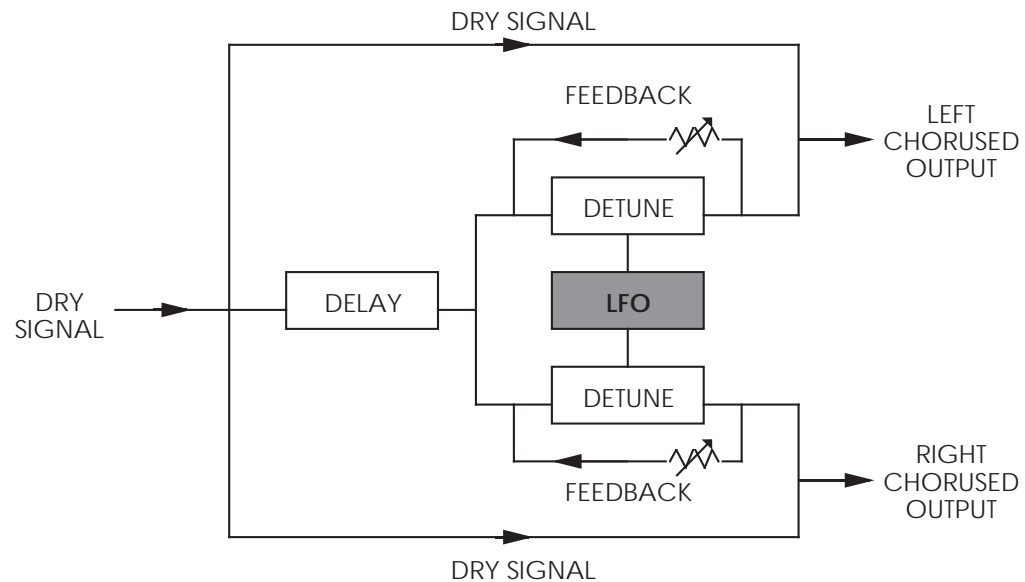

Mono Flange. First used in the 1960s, “Flanging” was achieved by the use of two tape recorders that would record and play back the same program in synchronization. By alternately slowing down one tape machine, and then the other, different phase cancellations would occur. Since the slowing down of the tape machines was done by hand pressure against the flanges of the tape supply reels, the term “Flanging” came into being.

The effect of Flanging is achieved by splitting and slightly delaying one part of the signal, then varying the time delay, again with an LFO. The delayed signal is then mixed back with the original sound to produce the “swishing” or “tunneling” sound.

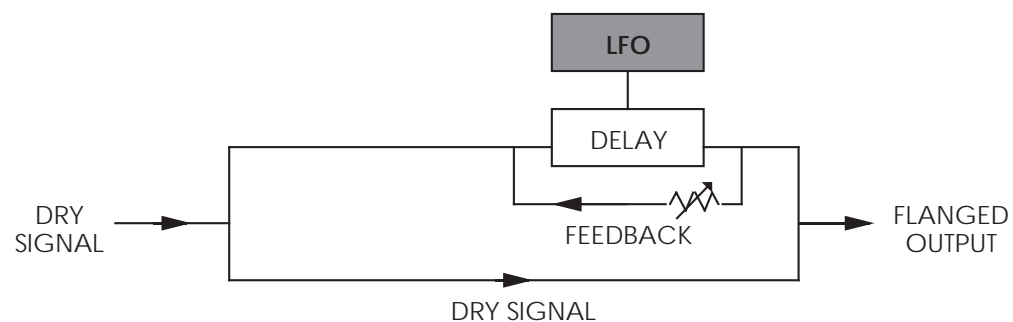

Many variables are available, from varying the speed and depth of the LFO to feeding back part of the signal to make the effect stronger. The Flanger’s feedback can be either “Normal” or “Inverted”. Use the “Inverted” setting for a more dramatic flange effect.

Stereo Flange. In the case of the Stereo Flange, the signal is split into three parts with a dry signal and a separate Delay section for both left and right channels with one channel flanging up while the other channel flanges down. Once again, this causes the effect to become more pronounced and dramatic.

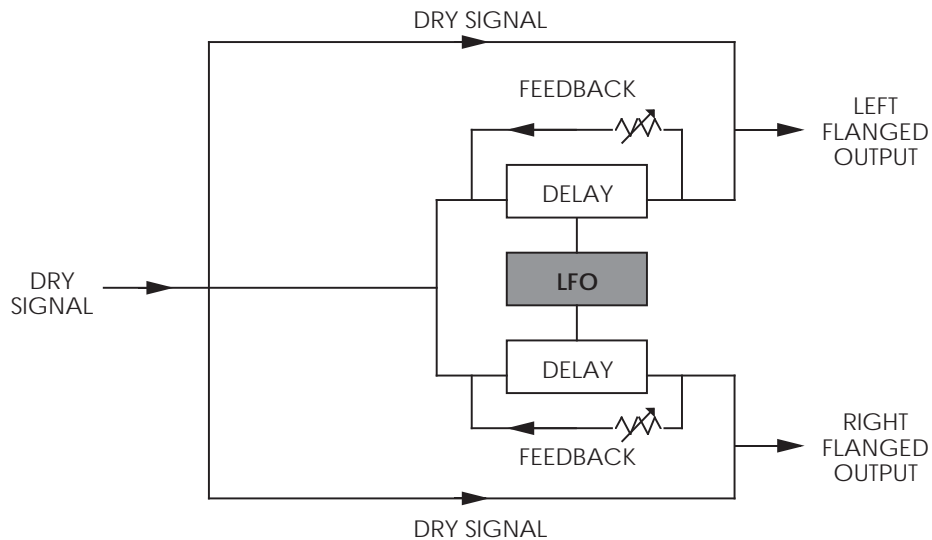

Pitch Detune. As the name implies, Pitch Detune takes a part of the signal and detunes it either sharp or flat. When mixed back with the original dry signal, the popular “12 string guitar” effect is produced.

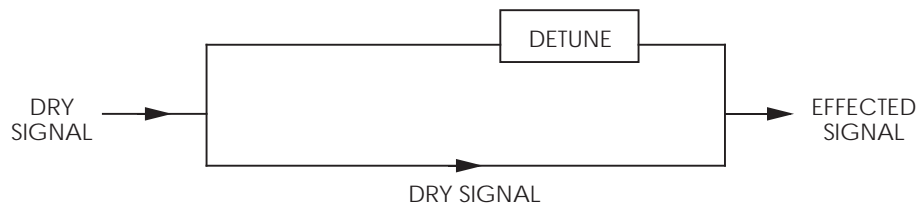

Resonator. This can be thought of as a highly resonant filter, or a filter that is tuned to a specific frequency with a lot of emphasis, which will cause the frequency that the resonator is set at to be highly accentuated.

Delay Input (<99 to <0> to 99>)

Page 2 (Config. 2 Only)

This parameter adjusts the level of the signal coming from the Delay output going into the Pitch Input. The Delay Input parameter is only available when editing a effects bus which has the Delay effect ahead of the Pitch effect in the selected Configuration (*Example: Configuration #2, effect send 1*).

If the Pitch type is Mono Chorus, Stereo Chorus, Mono Flange or Stereo Flange, page 2 through 5 of the Pitch function contain the following four parameters:

Waveform Shape (Sine or Square) Page 2

This determines the LFO's waveform shape. This parameter only appears when the Mono or Stereo Chorus or Flange are selected. The Waveform Shape of the LFO can be changed from a sine waveform, which provides a smoother, more even sound, to a square waveform, which makes the Chorus or flange effect more pronounced.

Speed (00 to 99) Page 3

This parameter adjusts the LFO Speed of all Pitch types, with the exception of Pitch Detune and Resonator.

Depth (00 to 99) Page 4

This parameter adjusts the LFO Depth of all Pitch types, with the exception of Pitch Detune and Resonator. The LFO Depth, which is the amount of pitch alteration, can be adjusted to produce the desired effect.

Feedback (00 to 99) Page 5

This parameter adjusts the LFO Feedback of all Pitch types, with the exception of Pitch Detune and Resonator. A portion of the output of the Pitch section can be "fed back" into the input in order to make the effect more tonal or pronounced.

The following three parameters only appear if the Pitch type is set to Pitch Detune or Resonator, respectively.

Detune (-99 to +99) Page 2 (Pitch Detune only)

If the Pitch type is Pitch Detune, page 2 will have only this parameter. This adjusts the tuning of the Pitch Detune effect. This can be set between -99 and +99, in 1 cent increments.

Resonator Tuning (00 to 60) Page 2 (Resonator only)

If the Pitch type is Resonator, page 2 of the Pitch function will let you adjust the Resonator tuning. This can be tuned from 00 to 60.

Resonator Decay (00 to 99) Page 3 (Resonator only)

If the Pitch type is Resonator, page 3 will let you adjust the Resonator Decay. This can be set 00 to 99, whereby 00 is a very fast decay and 99 is a very slow decay.

DELAY

The Delay function is used to edit Delay parameters. The QSR's effects processor has three different Delay types available.

Note: Some Configurations only feature a mono Delay, and therefore the Delay Type parameter will be unavailable. Instead the parameters normally found on page 2 of the Delay function are shown in page 1, and there are no other pages (please refer to next section for a description of those parameters).

Delay Type (3 types)

Page 1

Ping-Pong. This is called a "Ping Pong Delay" because the output bounces from side to side (left to right) in stereo with the speed determined by the delay time. The maximum delay time is 399 milliseconds.

Stereo Delay. The Stereo Delay is actually two separate delays, which can be individually varied. The maximum delay time for each delay is 399 ms.

Mono. The Mono Delay has the advantage of twice the available delay time, or 799 ms in Configuration #1, 1199 ms in Configuration #2.

In Pages 2 through 5 of the Delay Function you will find the remaining parameters for the Delay function. If the Stereo Delay type is selected and the cursor is beneath the parameter field in the lower line of the display, you can use [VALUE] knob to advance through pages 6 – 8. This is because the Stereo Delay type has parameters for both the Left and Right channels.

Input (<99 to <0> to 99>)

Page 2

This parameter is used to balance the Delay Input between the signal coming from the Pitch effect output (if applicable in the selected Configuration) and the dry effect send.

Time (0 to 799ms total)

Pages 3 & 4 (and 6 & 7 in Stereo Delay)

This is the actual Delay time, which determines the amount of time the input signal will be delayed. The Stereo and Ping Pong Delay types can have a delay time of up to 399ms. However, the Mono Delay can have up to 799ms per channel. Use Page 3 to adjust the delay time in 10 ms intervals; use page 4 to adjust the delay time in 1 ms intervals. When using the Stereo Delay, pages 3 & 4 let you adjust the delay time of the left channel, while pages 6 & 7 let you adjust the same for the right channel.

Feedback (00 to 99)

Page 5 (and Page 8 in Stereo Delay)

This adjusts the Delay Feedback, which is a portion of the delay signal output being "fed back" into the input. This results in the delay repeating itself. The more feedback, the more repeats. When using the Stereo Delay, page 5 lets you adjust the feedback level of the left channel, while page 8 lets you adjust the same for the right channel.

REVERB

Reverb can be thought of as a great number of distinct echoes, called reflections, that occur so fast that our ear hears them blurred together as one. In nature, different sized spaces give distinctly different sounding reverbs, depending on the size and shape of the space, and the texture of surfaces that the reflections bounce off of. The various parameters in the effects processor make it possible to simulate nearly any natural reverberant space that can be imagined, and a few artificial ones as well.

```
Send1: REVERB P1
In1:  PITCHout
```

The Reverb function is used to edit Reverb input levels and other parameters. In all configurations, page 1 of the Reverb function selects what the reverb is “hearing” (i.e., where the input of the reverb is coming from). The source can come directly from the Effect bus, the output of other effects in the chain before it, or a mix of several of them. *Example:* In Configuration #1, page 1 of the Reverb function (shown above) allows you to select the first of two sources to be routed to the reverb’s input. You can choose from the Delay output or the Pitch output. In page 2, you can choose the second input for the reverb to process, which can be the dry, send 1 signal, the Delay output or the Pitch output. You can then adjust a balance between these on page 3 and set an overall input level on page 4.

INPUT LEVELS

Input 1

Page 1 (Config 1, 3, 4 and 5)

In Configurations 1 and 3, there are two inputs to the Reverb. Both Inputs 1 and 2 can select a signal from several locations in the signal chain. You can select either the Pitch output or the Delay output as Input 1. If the signal is taken from the Pitch output, the Reverb will be chorused, flanged, detuned or resonating, depending upon which Pitch type is selected. (Note that the delay signal may already have passed through the Pitch module, depending on the Input settings of the Delay module.)

Input 2

Page 2 (Config 1, 3, 4 and 5)

Input 2 can have as its source either the Pitch output, the Delay output, or the dry effect send signal. If the signal is taken from the Delay output, the Reverb will be delayed by the amount of delay time set for the Delay. If the signal is taken from the Pitch output, the Reverb will be chorused, flanged, detuned or resonating, depending upon which Pitch type is selected. If the signal is taken from the effect send, the Reverb will receive direct, unaffected signal.

Input Balance (<99 to <0> to 99>)

Page 3 (Config 1, 3, 4 and 5)

This allows you to control the balance between Reverb Inputs 1 and 2 and therefore control the blend between the various input sources. This makes it possible to have the signal from the Pitch or Delay sections, or the direct effect send in any combination or amount.

Input level (00 to 99)

Page 4 (Config 1 and 3)

This controls the overall Input Level going into the Reverb.

Chorus Input Level (00 to 99)**Page 1 (Config 2 Only)**

If Configuration #2 is selected (refer to block diagram of Configuration #2, earlier in this chapter), the first page of the Reverb function will look like this:

```
Send1: REVERB P1
Chrs In Lev: 03
```

The Configuration has two Reverbs, one on send 1 (which send 2 can share), the other on send 3 (which send 4 can share). There is only one parameter in this page: Chorus Input Level. This lets you adjust the level of the signal coming from the Pitch output going into the Reverb, otherwise the signal comes purely from the Pitch input.

The other parameters and pages in the Reverb function are identical, regardless of which Configuration is being used. Only page 1 is different, because of the fewer input choices the Reverb has in this Configuration.

Send Input Levels (<99 to <0> to 99>)**Page 1 (Sends 2 through 4)**

If Configuration #1 is selected and you select effect send 2, the display will now show you the parameters that represent the signal levels on send 2 going into the Reverb. Note that there is now only 1 page available, since the other reverb parameters are found back on effect send 1.

Select send 3, and the display will still look the same, but now the parameters adjust the signal levels on send 3 going into the Reverb. If you select send 4, the display will look like this:

```
Send4: REVERB P1
+Rvb: SN430>DEL
```

There are only two parameters: Balance and Input Level. This is because in Configuration #1, effect send 4 only has a Delay effect, and not a Pitch effect like the other effect sends do. Page 1 controls the Balance between the Delay output and the dry effect send signal, while page 2 controls the overall input level to the Reverb.

If Configuration #2 is selected and you select effect send 2 while the Reverb function is selected, the display will look like this:

```
Send2: REVERB P1
RvbIn Send2: 50
```

This lets you adjust the level of the signal coming from effect send 2 going into the Reverb. Send 2 in this Configuration has no effects of its own. Therefore, there are no input or input mix controls in this page, since there is only one possible signal choice. Send 2 is intended to be used for signals that you want to send to Reverb 1, but bypass Delay and Pitch 1. In Configuration #2, send 4 is similar to send 2, in that it has no effects of its own but serves as a bypass going directly to Reverb 3.

REVERB PARAMETERS

Use the [CURSOR ] button to move the cursor to the lower line of the display, and turn the [VALUE] knob to advance the display through the remaining pages of the Reverb function. However, you must have the correct effect send selected (1–4) in order to get at the Reverb parameters (in Config. #1, the Reverb parameters are found only on effect send 1; in Config. #2, they are found on sends 1 and 3 since there are two separate Reverbs). Here you will find parameters for selecting the Reverb type, adjusting Pre-Delay Time and Pre-Delay Mix.

Reverb Type (7 types)

Page 5

The QSR has seven different reverb types, all stereo, each of which simulates a different space or produce a different ambient effect. The different Reverb types are:

Plate 1 & 2. The two Plate reverb types simulate an artificial device known as a Plate. In the early days of recording, Plates were extremely popular because they were almost the only way to provide any sort of artificial ambiance to a recording. The sound of a well-tuned Plate has become quite popular over the years especially when used on vocal or drum sounds. The two Plate reverbs differ in subtle tonal characteristic changes such as those found in different manufacturers' plate reverbs.

Room. The Room reverb type simulates not only rooms of different sizes, but rooms with different surface materials. A room with soft surfaces such as carpet will produce a reverberant sound with much less high end (treble) than a room with hard surfaces. This reverb type can easily simulate both examples and many, many more.

Hall. Much larger than a room, Halls are characterized by their high ceilings, irregular shapes, and generally uniform density of reflections.

Large. Much larger than a hall, this reverb type emulates large ambient spaces such as amphitheatres, gymnasiums, etc.

Gate. Gated Reverb is a very popular effect on drums first found on English records in the early 1980s. This reverb type can simulate applying a noise gate (a device that automatically decreases the volume once the signal falls below a certain level) across the output of the reverb thereby causing the initial attack of the reverb to sound very big, but the tail of the reverb to be cut off very quickly. Although this effect is not found in nature, it works great for modern drums, percussion, and any quickly repeated, transient source.

Reverse. The Reverse Reverb type is an inverted reverb in which the volume envelope is reversed. This means that the signal begins softly but grows louder until it is cut off, rather than loud to soft as normal.

Pre-Delay Time (0 to 299ms)

Pages 6 & 7

Pre-Delay is the slight delaying of the Reverb itself so that the dry signal more easily stands out from the Reverb. A bit of Pre-Delay can sometimes make certain instruments (such as snare drums) sound bigger. Use page 6 to adjust the Pre-Delay Time in 10ms intervals, and/or use page 7 to adjust the Pre-Delay Time in 1ms intervals. This Pre-Delay is part of the Reverb itself; don't confuse it with the separate Delay modules available under the Delay function.

Pre-Delay Mix (<99 to <0> to 99>)**Page 8**

This allows you to mix the amount of Pre-Delay into the Reverb signal path. This gives you the ability to hear a bit of the Reverb before the loudest part of the Reverb (the Pre-Delayed Reverb) sounds. This makes for bigger and smoother sounding Reverb settings.

Input Filter (00 to 99)**Page 9**

This adjusts the frequency of the low-pass filter which comes before the Reverb input. Lower the Input Filter value to remove high frequencies from the input signal before they go into the Reverb.

Decay (00 to 99)**Page 10**

The Reverb Decay determines how long the Reverb will sound before it dies away. When using the Reverse Reverb type, Reverb Decay controls the Reverse Time.

Low Decay and High Decay (00 to -99)**Pages 11 & 12**

These two parameters allow the Decay Time to be set separately for both the low and high frequencies of the Reverb. This means that you have control over the tonal shape of the Reverb itself, being able to make the high frequencies die faster if the effect is too bright, and being able to make the lows die faster if the effect is too boomy. This allows you to simulate different surfaces of a room or hall, with softer surfaces absorbing more high frequencies and smaller rooms having faster low frequency decay. If the selected Reverb type is Gate, the Low Decay parameter is unavailable.

Density (00 to 99)**Page 13 (Page 12 if Gated or Reverse type)**

Density controls how the first reflection of the reverb effect will appear. When set to 0, the first reflection is heard alone without any other reflections. When set to 99, the first reflection appears to “fade-in” and then “fade-out”. This is because a number of reflections will occur just before and just after the first reflection, in addition to the remaining reflections heard after the first reflection; the reverb sounds more “dense”. If the select Reverb type is Large, the Density parameter is unavailable.

Diffusion (00 to 99)**Page 14 (Page 13 if Gated or Reverse type)**

Diffusion determines the “thickness” of the reverb sound by adding more reflections to the reverb’s decay. With lower diffusion settings, you may be able to actually hear the individual echoes that make up the overall reverb sound. With higher diffusion settings, the echoes increase in number and blend together, washing out the reverb’s decay. Greater diffusion works better with percussive sounds, whereas less amounts of diffusion work well with vocals and other sustained sounds.

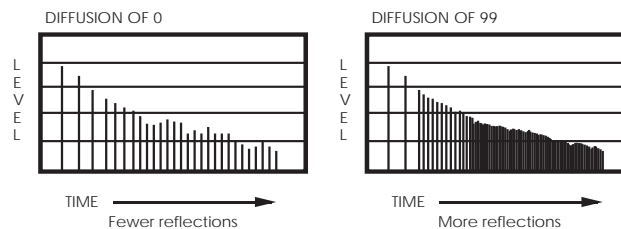

Note: The illustration above reflects a Density setting of 0.

OVERDRIVE

The Overdrive effect provides four parameters spread across four editing pages. It is only used in Configuration #5.

Overdrive Type (Hard or Soft)

Page 1

This selects one of two Overdrive Types: Soft and Hard. The Soft Overdrive has less gain and provides slightly less distortion than the Hard Overdrive. Also, there will still be a slight bit of distortion when using the Soft setting, if the signal feeding the Overdrive effect is below the Overdrive Threshold setting (see below). The Hard setting will only provide distortion when the signal feeding the Overdrive effect is above the Overdrive Threshold setting.

Overdrive Threshold (00 to 99)

Page 2

This sets the level the signal feeding the Overdrive effect must be reach before the Overdrive effect will begin distorting. It can be set between 00 and 99. If this number is very low, the Overdrive effect will start to distort almost right away. When set to a high number, the distortion will not occur until the signal feeding the overdrive becomes louder than the Threshold setting.

Overdrive Brightness (00 to 99)

Page 3

This sets the tone of the Overdrive effect. It can be set between 00 and 99. Higher numbers result in a brighter sounding overdrive. Lower numbers result in a duller distortion sound.

Overdrive Balance (<99 to <0> to 99>)

Page 4

This controls the output mix of the Overdrive effect. It can be set anywhere from “<99” to “<0>” to “99>”. When set to “<99”, the Overdrive effect cannot be heard at all. When set to “<0>”, you have an even mix between the original, unaffected signal and the overdriven signal. When set to “99>”, only the overdriven effect is heard.

Mix

Not to be confused with an actual Mix or Mix mode, the Effect's Mix function is where you can mix the various signal levels of all the effects to the Main Left and Right outputs of the QSR. Only effect modules that have access to the Main outputs will appear on the Mix page. There is a separate Mix page for each of the four effect busses whose effect modules feed the main output. Note that the Mix page doesn't control how much the individual effect modules feed to each other; only how much they feed to the Main outputs.

```
Send1: MIX      F1
Delay Output: 99
```

Depending on the selected Configuration, the order of the effects will differ (for example: in Configuration #1, the order reads Pitch, Delay, Reverb; but in Configuration #2, the order is Delay, Pitch, Reverb).

Pitch Level (00 to 99) Page 1(Config 1 and 4); Page 2 (Config 2 & 5)

Adjusting this value will cause the Pitch Output Level to increase or decrease. The Pitch Output level is the level for the Pitch Section of the QSR's effects processor to the Main outputs, and should be set as desired. Even if this parameter is set to 00, the output of the Pitch section is still available (depending on the bus and configuration) to following Delay and Reverb sections.

Delay Level (00 to 99) Page 2 (Config 1, 3, 4); Page 1 (Config 2); Page 3 (Config. 5)

Adjusting this value will cause the Delay Output Level to increase or decrease. The Delay Output level is the level for the Delay Section of the QSR's effects processor to the Main outputs, and should be set as desired. Even if this parameter is set to 00, the output of the Delay section is still available (depending on the bus and configuration) to following Pitch and Reverb sections.

Reverb Level (00 to 99) Page 3 (Config. 1 – 4); Page 4 (Config. 5)

Adjusting this value will cause the Reverb Output Level to increase or decrease. The Reverb Output level is the level for the Reverb Section of the QSR's effects processor to the main outputs, and should be set as desired.

Lezlie Level (00 to 99) Page 1 (Config. 3); Page 5 (Config. 5)

This is only available in Configurations 3 and 5. Adjusting this value will cause the Lezlie Output Level to increase or decrease. Even if this parameter is set to 00, the output of the Pitch section is still available (depending on the bus and configuration) to following Delay and Reverb sections.

Overdrive Level (00 to 99) Page 1 (Config. 5 Only)

This is only available in Configuration 5. Adjusting this value will cause the Overdrive Output Level to increase or decrease. The Overdrive Output level is the level for the Overdrive Section of the QSR's effects processor to the main outputs, and should be set as desired.

CHAPTER 8

GLOBAL SETTINGS

Global Edit Mode is where you will find several parameters which affect the entire instrument, such as overall master tuning, controller settings, and keyboard mode.

EDITING GLOBAL PARAMETERS

To select Global Edit Mode, follow these steps:

- ① Press the [EDIT SELECT] button.
- ② Press the BANK SELECT [UP] button (also labeled [GLOBAL]).
The display will look like this:



```
GLOBAL EDIT P1
Master Pch: 00
```

- ③ Use the [VALUE] knob to scroll through the various pages of Global Edit Mode.
The page number is displayed in the upper-right corner.
- ④ Press the [CURSOR ] button once to select the displayed parameter for editing.
- ⑤ Use the [VALUE] knob to adjust the selected Global parameter.

The following sections describe in detail each of the parameters found in the nineteen Global Edit Mode pages.

MASTER PITCH

Page 1

Page 1 of Global Edit Mode lets you adjust the QSR's overall Master Pitch (-12 to +12; up or down an octave). Adjust this parameter when you wish to globally transpose all sounds. This parameters have no effect on drum sounds or the Range settings.

MASTER TUNE

Page 2

Page 2 of Global Edit Mode lets you adjust the QSR's overall Master Tuning (-99 to +99; up or down 1/2 step). Adjust this parameter when tuning the QSR to other instruments. This parameters have no effect on drum sounds, the Range settings, or MIDI Out.

GENERAL MIDI MODE

Page 3

Page 3 of Global Edit Mode lets you enable and disable General MIDI Mode. If this parameter is turned on, you will immediately be taken out of Global Edit Mode and into Mix Mode, and Mix 00 of Preset Bank 4 will automatically be selected. For more information about General MIDI, refer to the MIDI Supplement in Appendix B.

ENABLING GENERAL MIDI MODE VIA MIDI

The QSR will respond to a universal MIDI Sysex message to turn General MIDI mode on or off. Some (but not all) General MIDI sequences will have a Sysex message at the beginning (bar 1) which tells the receiving device to go into its General MIDI mode. If this message is sent, no matter where you happen to be on the QSR, General MIDI mode will be enabled, and Mix 00 of Preset Bank 4 will automatically be selected.

CONTROLLERS A – D ASSIGNMENT

Page 4 – 7

The QSR allows you to assign up to four general purpose MIDI controllers. These controllers are assigned a letter, A–D. These are directly linked to specific MIDI controllers which can be received from another synth or sequencer.

Page 4 through 7 of Global Edit mode lets you choose which MIDI controllers (0 to 120) to assign as Controllers A, B, C and D. For a listing of all MIDI controllers and their designations, see page 127 in the Appendix B: MIDI Supplement.

PEDALS 1 AND 2 ASSIGNMENT

Page 8 & 9

Like the MIDI Controllers A–D, the two footpedal controls (Pedal 1 and Pedal 2) can be assigned to a MIDI controller. These two pedal controls are linked to specific MIDI controllers which can be received from another synth or sequencer.

Pages 8 and 9 of Global Edit mode lets you assign which MIDI controllers (0 to 120) that Pedal 1 and Pedal 2 will be transmitted as over MIDI Out. Simultaneously, if the same MIDI controller is received it will control any modulations that use either Pedal 1 or Pedal 2. Page 8 lets you select the controller for Pedal 1, while page 9 lets you select the controller for Pedal 2.



When recording into a MIDI sequencer, be careful not to accidentally assign either Pedal 1 or 2 to a controller which may already be used by another control (like MIDI Volume/controller 7, or Mod Wheel/controller 1).

USING A PEDAL TO CONTROL VOLUME OR MODULATION

If Pedal 1 is assigned to Controller 7 (Global Edit Mode, Page 8), then they will automatically control the volume of:

- any Sounds in a Program, and;
- in Mix Mode, any Sounds that are controlled by the Keyboard (Mix Edit Mode, Range, Page 2) and have Pedals turned on (Mix Edit Mode, Range, Page 3).



Likewise, if either Pedal is assigned to Controller 1, then they will automatically function like the Modulation Wheel for any Sound in Program Play Mode, and in Mix Play Mode, Sounds that are controlled by the Keyboard and have Pedals turned on. This is in addition to the fact that the pedals will be sending out MIDI information. The default settings are: Pedal 1 = 7; Pedal 2 = 4.

MIDI PROGRAM SELECT

Page 10

Page 14 of Global Edit mode lets you determine the MIDI Program Select Mode (Off, On, Channel 1 – 16). When this is set to “Off”, the QSR will not respond to incoming MIDI Program Change messages, nor will it transmit Program Changes.

When set to “On”, the QSR will respond to incoming Program Change messages. Likewise, when a Program or Mix is recalled from the front panel, its respective program change message will be sent out. However, the QSR will respond differently to incoming Program Change messages depending on whether Program Mode or Mix Mode is selected.

In Program Play Mode, the [ MIDI ] buttons determine which MIDI channel the QSR will receive MIDI Program Change messages on (as well as other messages like notes, controllers, etc.). The Program recalled will be the same number as the Program Change message that is received, from whichever bank (Preset or User) is currently selected. When a Program is recalled from the front panel, the QSR will transmit the equivalent Program Change message on this same MIDI channel.

In Mix Play Mode, when MIDI Program select is set to “On”, Program Changes received on any of the 16 MIDI channels will be received by the same numbered MIDI channels in the current Mix. The Mix itself will not respond to Program Changes on any MIDI channel.

When set to “Channel 1 – 16”, the QSR will change Mixes in response to Program Change messages received on the same MIDI channel as selected by this parameter, from whichever bank (Preset or User) is currently selected. Program Change messages received on any other channel (other than the one selected by this parameter) will change the individual Programs in the Mix on the same channels the messages are received on.

Note: When General MIDI Mode is enabled (see page 115), Channel 10 of the selected Mix will be used exclusively for drums. If a program change is received on Channel 10, a new drum kit will be recalled. These drum kits are used exclusively in General MIDI mode, and adhere to the General MIDI specification.

RECEIVING/TRANSMITTING BANK CHANGE MESSAGES

The QSR will respond to MIDI Bank Select messages. Bank Select messages are transmitted via MIDI Controller 0. The value of Controller 0 determines which bank (User, Preset 1–3, GenMIDI, Card 1–11) is to be recalled. *Example:* If a Bank Select (controller 0) message of 0 is received, it will cause the User Bank to be recalled. If a Bank Select message of 1 is received, Preset Bank 1 will be recalled. Additionally, if a Sound Card is inserted, the Card Banks can be selected using Controller 0 values between 5 and 15. Values higher than 15 are “wrapped around” and will recall the same Banks. *Example:* A Controller 0 message with a value of 39 will recall the User Bank.

Note: Bank change messages will be ignored if General MIDI Mode is enabled, so that only Programs within the General MIDI Bank (GenMIDI) can be recalled via MIDI Program changes.

If the MIDI Program Select parameter is “On” and a new Bank is selected using the BANK SELECT [DOWN] and [UP] buttons, a Bank Change message (followed by the appropriate Program Change message) will be transmitted out the MIDI [OUTPUT] connector.

If, additionally, a new Bank is selected in Mix Play Mode and any of its Channel’s MIDI Out parameters (Mix Edit Mode, Keyboard/MIDI Function, Page 2) are turned “On”, a Bank Select message (followed by the appropriate Program Change) will be transmitted out the MIDI Out connector for each of those MIDI Channels.

INPUT/OUTPUT MODE

Page 11

The I/O (Input/Output) Mode determines how the MIDI [INPUT] and [OUTPUT] connectors on the QSR’s rear panel will function in relation to the [SERIAL PORT] connector. The possible settings of the I/O parameter depend on the setting of the [SERIAL PORT] switch (located on the back panel next to the [SERIAL PORT]).

With [SERIAL PORT] set to...	The I/O parameter may be switched between...
PC	MIDI, PC 38.4kbaud and PC31.25kb
MAC	MIDI and MAC 1MHz

If you are using a PC compatible computer, consult the software you are using to determine which PC setting to set the I/O parameter to.

- When this parameter is switched to “MIDI”, the [SERIAL PORT] will not function, and the MIDI [INPUT] and [OUTPUT] will operate normally (receiving and transmitting MIDI information to and from the QSR).
- When this parameter is set to either “MAC 1MHz” (if the [SERIAL PORT] switch is set to MAC) or to “PC 38.4kbaud” or “PC31.25kbaud” (if the [SERIAL PORT] switch is set to PC), the MIDI [INPUT] will not function (any MIDI information received on the MIDI [INPUT] connector will be ignored), and the MIDI [OUTPUT] connector may act as a MIDI “Thru” connector for the connected computer —i.e. MIDI information received from the computer will be transmitted (see below).

For information regarding connecting a computer to the [SERIAL PORT], see page 22.



When the I/O parameter is NOT set to “MIDI”, the QSR will not transmit any locally generated MIDI information to the MIDI [OUTPUT] connector, but will only transmit this information to the connected computer via the [SERIAL PORT]. If the computer program has its “MIDI Thru” parameter turned on, this information will be “echoed” back from the computer to the QSR. The MIDI information coming from the computer will also be transmitted out the QSR’s MIDI [OUTPUT] connector.

MIDI OUT

Page 12

The MIDI Out Mode determines whether the MIDI [OUTPUT] connector will transmit MIDI information originating from the QSR (when set to "OUT"), or will "echo" MIDI information that is received at the MIDI [INPUT] connector (when set to "THRU").

If the I/O parameter (see previous page) is set to either "Mac", "PC 38.4kbaud" or "PC31.25kbaud", the MIDI Out parameter can only be set to "OFF" or "THRU". This is because unless the I/O parameter is set to "MIDI", the MIDI [OUTPUT] connector may only function as a MIDI "Thru" connector for the connected computer, and can only be switched off.

MIX GROUP CHANNEL





Page 13

This determines which MIDI channel will play all those channels in the selected Mix whose Group parameter is set to "On". When in Mix Mode, you have the option to transmit on several MIDI channels at once, or to temporarily isolate certain channels within a Mix.

1-16. When the Group Mix Channel parameter is set between 1 and 16, the number it is set to determines the single MIDI channel which, when MIDI information is received on it, will play the channels in the selected Mix which have their Group parameter turned on.

OFF. In this mode, the individual channels used by the selected Mix will only be triggered by MIDI information received on its designated MIDI channel (*Example:* the sound on channel 1 will only respond to information received on MIDI channel 1, the sound on channel 2 will only respond to information received on MIDI channel 2, etc.), regardless of whether each channel's Group parameter has been turned on or off. However, the MIDI In parameter for each channel must be turned on in order for that channel to respond to incoming MIDI information on its own channel.

To turn on the Group function for a channel in a Mix:

- ① From Mix Play Mode, press [EDIT].
- ② Turn the [VALUE] knob clockwise until the **KYED/MIDI** function appears.
- ③ Press the [CURSOR ] button once.
- ④ Turn the [VALUE] knob clockwise until page 3 is displayed.
- ⑤ Use the [ MIDI ] buttons to select one of the 16 channels in the Mix.
- ⑥ Press the [CURSOR ] button once.
- ⑦ Turn the [VALUE] knob clockwise to turn on the Group parameter.

CLOCK

PAGE 14

The Clock function, found on Page 14 of Global Edit Mode, determines the sample clock rate the QSR will use. Normally the QSR uses its own internal clock to determine the actual number of samples per second. Remember, the sounds in the QSR are based on digital recordings. These recordings are made up of several thousands of tiny digital audio “snapshots”, otherwise known as samples. These samples are played so quickly and run so close together, they all appear to the human ear to be one sound.

The rate at which samples are played back is determined by the Clock function. It has four settings: `Int48kHz`, `Int44.1k`, `Ext48kHz` and `Ext44.1k`. The default setting is `Int48kHz`.

When set to either `Internal` setting, the QSR uses its own internal sample clock as a reference for playing back the sampled sounds that make up a Program or Mix. However, if you are recording the QSR to ADAT using the QSR's [DIGITAL OUT] connector and the ADAT is using a sample rate of 44.1 kHz, you should set the QSR's Clock function to `Int44.1k`.

If you are recording to an ADAT and also have a BRC Master Remote Controller, the QSR must receive a clock signal from the BRC in order to maintain perfect sync with the ADAT system. This requires that you connect a BNC-to-BNC cable between the BRC's 48 kHz Clock Out to the QSR's [48 kHz IN]. When you are ready to record onto ADAT from the QSR, be sure to set the QSR's Clock function to either `Ext48kHz` (if the BRC is set to 48 kHz) or `Ext44.1k` (if the BRC is set to 44.1kHz). By setting the QSR's clock to the identical sample rate of the ADAT/BRC, you guarantee perfect sync between the two units. For more on connecting the BNC-to-BNC cable, see page 26.

CHAPTER 9

MIDI TRANSFER AND STORAGE OPERATIONS

USING PCMCIA EXPANSION CARDS

The QSR provides two PCMCIA EXPANSION CARD slots, [A] or [B], which are found on the front panel. These accommodate Alesis QCards and RAM cards. The RAM Card is a type of PCMCIA SRAM or FlashRAM card; it has 256K of memory and will store 4 complete banks. A 512K PCMCIA card can store 8 banks.

When saving data to a card that contains a ROM (READ-ONLY) bank, the ROM data is found in bank 1; this means you cannot save anything into bank 1. Each PCMCIA Expansion Card slot can house a card with up to 8 Mb of RAM, for a total of 16 additional megabytes of sound storage.

SAVING THE USER BANK TO A PCMCIA CARD

The entire contents of the QSR's User memory (100 Mixes and 128 Programs) can be stored to an Alesis PCMCIA RAM card inserted into PCMCIA EXPANSION CARD slot [A] on the QSR. Depending on the amount of RAM a particular card has, up to 8 complete banks can be stored onto it.



- ① Insert a card into Sound Card slot A on the front of the QSR. Alesis recommends that you use card slot A for all RAM card storage operations.
- ② Press [STORE].
- ③ Press [ CURSOR] three times to select Page 8 of the Store function. *This selects the "SAVE TO CARD" option. The display will look like this:*

```
Save USER to
CrdABnk1 (STR)
```

- ④ Use the [VALUE] knob to select a bank location on the card to store to (A-1-4, etc.). *If the card contains a ROM bank, it will show as Bank 1 and you will be unable to store to it.*
- ⑤ Press [STORE] to transfer the user bank data from the QSR onto the card.

If the display reads "CARD A IS WRITE PROTECTED.", switch the write-protect switch on the card to off and repeat the procedure.

LOADING A BANK FROM AN EXTERNAL CARD

The QSR can access Program and Mix data directly from a card by using the [ BANK] and [BANK ] buttons. To overwrite the User bank with a Card bank:

- ① Insert the card into one of the card slots on the front panel.
- ② Press [STORE].
- ③ Press [ CURSOR] twice to select Page 9 of the Store function.





Load USER from
CrdABnk1 (STR)

- ④ Use the [VALUE] knob to select the bank on the card you wish to load (1–11).
- ⑤ Press [STORE] to transfer the data from the card into the QSR.

STORING AN INDIVIDUAL PROGRAM OR MIX

You also have the option of storing a Mix or Program directly to a specific location in a RAM Sound Card Bank (instead of transferring the entire Bank) and vice versa. However, the Sound Card you are storing to must be of the current QSR Bank format. A Sound Card is formatted whenever an entire QSR Bank is stored onto it. If you are using an older QuadraSynth Sound Card that does not use the current Bank format, you will not be able to store individual Mixes or Programs onto it until you store an entire QSR Bank onto it first.

- ① Insert a card into Sound Card slot A on the front of the QSR. Alesis recommends that you use card slot A for all RAM card storage operations.
- ② Select the Program or Mix you wish to transfer to the card.
- ③ Press [STORE].
- ④ Press [ CURSOR] once.
- ⑤ Use the [VALUE] knob to select a bank location on the card to store to (1–11).
If the card contains a ROM bank, it will show as Bank 1 and you will be unable to store to it.
- ⑥ Press [CURSOR ] Once.
- ⑦ Use the [VALUE] knob to select a location in the selected card Bank to save to (00–127 if storing a Program; 00–99 if storing a Mix).
- ⑧ Press [STORE] to transfer the data from the QSR onto the card.

If the card is write-protected, or not inserted, or not of the current Bank format, the display will indicate the situation with an error message. If the card is not of the current Bank format, use the “Save To Card” command first (see previous page) to save the entire User Bank to the card. This however will erase all Programs and Mixes in the selected card Bank. If these are important to you, first load them into the

User Bank in the QSR, and then save them back onto the card in order to re-format the card using the new format.

LOADING AN INDIVIDUAL PROGRAM OR MIX

You can load a single Mix or Program from a Sound Card into the User Bank, instead of having to load the entire Bank from the Sound Card. To do this, select the Mix or Program in the Sound Card Bank that you wish to copy, then use the Store Function (as described above) to designate a location you wish to store to in the User Bank.

Note: When storing a Mix from a Sound Card into the User Bank, the individual Programs used by the Mix will not be moved into the User Program Bank. Once you store a Mix from a Sound Card into the User Bank, it will still look for its Programs in the Sound Card Bank, if that is where it was programmed to look for them in the first place (which is almost always the case).

Note: If the Mix or Program you wish to transfer uses samples that reside on a ROM card in slot A or B, you must have the ROM card in that same slot after the transfer in order for that portion of the Program or Mix to sound the same (or at all).

CARD STORAGE RAMIFICATIONS

It's not uncommon for someone to keep ROM cards in both slots A and B, create their own Mixes which access Programs from both cards, and use a RAM card in Slot A to occasionally to back up their User bank. In this case, there are a few considerations:

Whenever you transfer an internal Bank to a RAM card, the result is that all Mixes in the transferred Bank are changed so that they now access the Programs on the card bank to which the User bank was saved (since they reside there, now), instead of the Programs from the original internal Bank. And, when a Card Bank is transferred to an internal Bank location, the opposite happens – all Programs within a Mix which had previously accessed card bank 1 (for example) now point to the User bank.

However, a problem can arise when you have one or more Mixes in the Bank you are transferring which use Programs from a ROM card in slot A. *Example:* Let's say Mix 00 in the User Bank uses a Program that's located on Card A Bank 1 (the ROM card). If the ROM card is taken out of slot A, a RAM card is inserted, and the User Bank is transferred to the RAM card's Bank 1, the result will be that Mix 00 in Card Bank 1 now uses only Programs from Card Bank 1. If later you transfer the entire Bank back into the QS, you will find that Mix 00 no longer uses the Program on the Card as it was originally programmed to do.

Here are a few ways to avoid this problem. First, always transfer to a Card Bank that does not include any Programs used by the Mixes in the Bank you are transferring from. In other words, if we transferred the Bank into Card Bank 2, we would not have a problem, since the Mix would still be using the Program in Card Bank 1. Another way to avoid this problem is to transfer the Bank to a Card Bank, and then immediately store the individual Mix onto the Card by itself. When a Mix is stored individually to a Card in slot A, it is not modified in any way ; i.e. if it used Programs in the internal Banks, it will still use them even though the Mix and its Programs are in two different locations (the Mix is on the Card but the Programs it uses are stored in the internal Banks).

Finally, you could avoid this situation by always making sure your Mixes use only Programs located in the same Bank it is stored in. This could mean individually

storing some Programs from a RAM Card into one of the internal Banks. Although this is very limiting, it makes things much simpler in the long run.

SAVING PROGRAMS VIA MIDI Sys Ex

As an alternative to storing data to a card, the QSR lets you transmit internal data via MIDI System Exclusive messages. This data can be sent to a storage device, or recorded into a MIDI sequencer, or sent to another QSR or S4. You have a choice of sending any single Program in the User bank (00 to 127), or what is in the current Program Edit buffer, or what is in any of the 16 Mix Edit Program buffers, or the entire User bank (100 Mixes, 128 Programs, 128 Effects Patches) plus Global data. In the case of sending data to another QSR, you can send any individual Program to the same location or any other location in the receiving QSR, including any of its 17 Program Edit buffers.

To send the entire User bank via MIDI:

- ① Connect a MIDI cable from the QSR's [MIDI OUT] to the MIDI In of a device capable of receiving the data (a MIDI sequencer, another QSR, etc.).
- ② Press [STORE].
- ③ Press [CURSOR *The display will look like this:*

```
SEND ALL DATA  
TO MIDI? (STR)
```

- ④ Press [STORE] to transmit the data out the MIDI Out connector.
While transmitting the data, the display will temporarily read "SENDING OUT MIDI DATA.....".

To send a single Program via MIDI:

- ① Follow steps ① and ② in the instructions above.
- ② Press [CURSOR *The display will look like this:*

```
MIDI PRG 000 TO  
PRG 000? (STR)
```

- ③ Use the [VALUE] knob to select a Program to transmit. You may select any Program in the User bank (000 to 127) or the Program Edit buffer (EDIT) or any of the 16 Mix Edit buffers (E#01 to E#16).
As this value is changed, the second parameter (destination) will be linked. This is because most often you will want to transmit a Program to the same Program location. The only time to do otherwise is when sending to another QSR (see below).
- ④ Press [STORE] to transmit the data out the MIDI Out connector.

To send a single Program via MIDI to a *different* Program number:

- ① Follow steps ① through ③ in the instructions above.
- ② Press [CURSOR - ③ Use the [VALUE] knob to select a Program number to send the Program to.
- ④ Press [STORE] to transmit the data out the MIDI Out connector.

The procedure is similar for sending Mixes. Page 5 of the Store function allows you to send any one of the Mixes. In the case of storing a Mix, you may want to store each of the Programs used in the Mix. The "SEND ALL TO MIDI" command in Store mode is an easy shortcut to this (see above).

SEQUENCE PLAYBACK

Sound Bridge allows you to burn Standard MIDI sequence files on to PCMCIA cards. This allows you to play your own sequences at a live gig without taking your computer with you. See the Sound Bridge instructions on the QS CD-ROM for instructions on how to burn sequences to a card. To play back sequences from a PCMCIA card:

- ① Press and hold the [MIX] button.
- ② Press the [DOWN] button. The display will read:

```
Play CardA Seq01
<STORE>
```

- ③ Use the Value wheel to choose a sequence from either Card A or B, then press [STORE].

You can play any of the 50 sequences on a card in slot A by using the [00] through [40] buttons, and you can play the sequences from the card in slot B by using the [50] through [90] buttons. For example to play sequence 34 from card B, press [MIX], [80], then [4]. Remember that if you write a sequence to Card A, using Programs and wave data from that card, then play it from Slot B, the sequence will still look for its data in the Card A slot.

APPENDIX A

TROUBLE-SHOOTING



TROUBLE-SHOOTING INDEX

If you are experience problems while operating the QSR, please use the following table to locate possible causes and solutions before contacting Alesis customer service for assistance.

Symptom	Cause	Solution
The display does not light when the ON/OFF switch is turned on.	No power.	Check that the power cable is plugged in properly.
No sound.	Bad connections.	Check your audio cables; if necessary, swap cables.
	Volume is turned down.	Raise the [VOLUME] knob.
No MIDI input in Mix mode (cannot control through MIDI).	Bad connections.	Check MIDI cables.
	One or more channels' MIDI IN switch is off.	Make sure the MIDI IN parameter is turned on for the channel(s) you wish to control via MIDI.
	Group Mix Channel is set incorrectly.	Make sure the Group Mix Channel (Global, p. 13) is set to the same MIDI channel your master keyboard is transmitting on.

RE-INITIALIZING

If your unit behaves erratically or “freezes”, the first step is to power down the unit. and power it back up again. Disconnect any cables connected to the MIDI IN jack, and make sure that a sequencer or keyboard is not sending messages to the QSR that would make it behave erratically (such as a long stream of pitch bend messages on 16 channels simultaneously). If these steps do not solve the problem, you must re-initialize the software

To re-initialize the QSR, hold down both [ CURSOR ] buttons while turning on the power. This will reset all Global parameters to their default settings, and will initialize all edit buffers so that all Mix, Program and Effects parameters are reset to their default settings. However, none of the Programs, Mixes, or Effects are changed when re-initializing the unit.

CHECKING SOFTWARE VERSION

The current software version may be determined by simultaneously pressing both [◀ CURSOR ▶] buttons. The QSR will momentarily indicate the current software version installed in the display.

MAINTENANCE/SERVICE

CLEANING

Disconnect the AC cord, then use a damp cloth to clean the module's metal and plastic surfaces. For heavy dirt, use a non-abrasive household cleaner such as Formula 409 or Fantastik. **DO NOT SPRAY THE CLEANER DIRECTLY ONTO THE FRONT OF THE UNIT AS IT MAY DESTROY THE LUBRICANTS USED IN THE SWITCHES AND CONTROLS!** Spray onto a cloth, then use the cloth to clean the unit.

REFER ALL SERVICING TO ALESIS

We believe that the QSR is one of the most reliable modules that can be made using current technology, and should provide years of trouble-free use. However, should problems occur, **DO NOT** attempt to service the unit yourself. The full AC line voltage, as well as high voltage/high current DC voltages, are present at several points within the chassis. Service on this product should be performed only by qualified technicians. **THERE ARE NO USER-SERVICEABLE PARTS INSIDE.**

OBTAINING REPAIR SERVICE

Before contacting Alesis, check over all your connections, and make sure you've read the manual.

Customers in the USA:

If the problem persists, call Alesis USA at 1-800-5-ALESIS and request the Product Support department. Talk the problem over with one of our technicians; if necessary, you will be given a repair order (RO) number and instructions on how to return the unit. All units must be shipped prepaid and COD shipments will not be accepted.

For prompt service, indicate the RO number on the shipping label. If you do not have the original packing, ship the QSR in a sturdy carton, with shock-absorbing materials such as styrofoam pellets (the kind without CFCs, please) or "bubble-pack" surrounding the unit. Shipping damage caused by inadequate packing is not covered by the Alesis warranty.

Tape a note to the top of the unit describing the problem, include your name and a phone number where Alesis can contact you if necessary, as well as instructions on where you want the product returned. Alesis will pay for standard one-way shipping back to you on any repair covered under the terms of this warranty. Next day service is available for a surcharge.

Field repairs are not normally authorized during the warranty period, and repair attempts by unqualified personnel may invalidate the warranty.

Service address for customers in the USA:

Alesis Product Support
3630 Holdrege Avenue
Los Angeles, CA 90016

Customers outside the USA:

Contact your local Alesis dealer for warranty assistance. The Alesis Limited Warranty applies only to products sold to users in the USA and Canada. Customers outside of the USA and Canada are not covered by this Limited Warranty and may or may not be covered by an independent distributor warranty in the country of sale. Do not return products to the factory unless you have been given specific instructions to do so.

APPENDIX B

MIDI SUPPLEMENT

MIDI BASICS

Most current electronic instruments and signal processors, including the QSR, contain an internal computer. Computers and music have been working together for decades, which is not surprising considering music's mathematical basis (consider frequencies, harmonics, vibrato rates, tunings, etc.). In the mid-70s, microcomputers became inexpensive enough to be built into consumer-priced musical instruments. They were used for everything from sound generation to storing parameters in memory for later recall.

In 1983, the MIDI (Musical Instrument Digital Interface) specification was introduced to better exploit the computers inside these new musical instruments, primarily to ensure compatibility of equipment between manufacturers. MIDI expresses musical events (notes played, vibrato, dynamics, tempo, etc.) as a common "language" consisting of standardized digital data. This data can be understood by MIDI-compatible computers and computer-based musical instruments.

Before electronics, music was expressed exclusively as written symbols. By translating musical parameters into digital data, MIDI can express not only the types of musical events written into sheet music, but other parameters as well (such as amount of pitch bend or degree of vibrato).

MIDI HARDWARE

MIDI-compatible devices usually include both MIDI In and MIDI Out jacks, which terminate in 5-pin DIN-style connectors. The MIDI Out jack transmits MIDI data to another MIDI device. As you play a MIDI controller such as a keyboard, data corresponding to what you play exits the MIDI Out jack. Example: If you play middle C, the MIDI Out transmits a piece of data that says "middle C is down." If you release that key, the MIDI Out transmits another piece of data that says "middle C has been released."

If the keyboard responds to the dynamics of your playing, the note data will include dynamics information too. Moving the modulation wheels and pedals attached to many synthesizers will also generate data associated with the wheel or pedal being used.

The MIDI In jack receives data from another MIDI device. In addition to the type of performance data described above, rhythmically-oriented MIDI devices (e.g., drum machines) can often transmit and/or receive additional MIDI timing messages that keep other rhythmically-oriented units in a system synchronized with each other.

An optional MIDI Thru jack provides a duplicate of the signal at the MIDI In jack. This is handy if you want to route MIDI data appearing at one device to another device as well.

MIDI MESSAGE BASICS

There are two main types of MIDI messages. Channel messages, which are channel-specific, consist of Voice and Mode messages. System messages, which do not have a channel number and are received by all units in a system, include Common, Real Time, and Exclusive messages.

CHANNEL MESSAGES: MODE MESSAGES

There are two messages that determine the MIDI mode (i.e., how a device will receive MIDI data). The "Omni" message determines how many channels will be recognized. Omni On means that data from all channels will be received; Omni Off limits the number of channels, usually to one.

The "Mono/Poly" message deals with voice assignment within the synthesizer. In Mono mode, only one note at a time plays in response to voice messages; in Poly mode, as many voices can play notes as are available to play notes.

CHANNEL MESSAGES: VOICE MESSAGES

A synthesizer's voice is the most basic unit of sound generation. Usually, each voice plays one note at a time, so the number of notes you can play at one time will be limited by the available number of voices. MIDI messages that affect voices include:

Note On. Corresponds to a key being pressed down; values range from 000 (lowest note) to 127 (highest note). Middle C is 60.

Note Off. Corresponds to a key being released; values are the same as note on.

Velocity. Corresponds to dynamics; values range from 001 (minimum velocity) to 127 (maximum velocity). A velocity of 000 is equivalent to a note-off message.

Pressure. Indicates the pressure applied to a keyboard after pressing a key. Mono pressure (Aftertouch) represents the average amount of pressure applied by all keys. Poly Pressure produces individual pressure messages for each key.

Program Change. Sending a Program Change command from a sequencer or other MIDI keyboard can change synth patches automatically. There are 128 Program Change command numbers.

Also note that not all units number programs consistently. Some number them as 000-127, others as 001-128, and still others arrange programs in banks of 8 programs (such as A1-A8, B1-B8, C1-C8, etc.).

Pitch Bend. This "bends" a note from its standard pitch.

Continuous Controller. Footpedals, breath controllers, and modulation wheels can vary sounds as you play, thus adding expressiveness. MIDI allows for 64 continuous controllers (these act like potentiometers in that you can choose one of many different values) and 58 continuous/switch controllers (these can act like continuous controllers but some are assumed to choose between two possible states, such as on/off).

Each type of controller is stamped with its own controller identification number. Not all controller numbers have been standardized for specific functions, but the following indicates the current list of assigned controllers. Numbers in parenthesis indicate the controller range.

#	Function
1	Modulation Wheel (0-127)
2	Breath Controller (0-127)
3	Early DX7 Aftertouch (0-127)
4	Foot Controller (0-127)
5	Portamento Time (0-127)
6	Data Slider (0-127)
7	Main Volume (0-127)
8	Balance (0-127)
10	Pan (0-127)
11	Expression (0-127)
16	General Purpose #1 (0-127)
17	General Purpose #2 (0-127)
18	General Purpose #3 (0-127)
19	General Purpose #4 (0-127)
32-63	Least Significant Bits, Controllers 0-31 (0-127)
64	Sustain Pedal (0 or 127)
65	Portamento On/Off (0 or 127)
66	Sostenuto Pedal (0 or 127)
67	Soft Pedal (0 or 127)
69	Hold 2 (0 or 127)
80	General Purpose #5 (0 or 127)
81	General Purpose #6 (0 or 127)
82	General Purpose #7 (0 or 127)
83	General Purpose #8 (0 or 127)
92	Tremolo Depth (0-127)
93	Chorus Depth (0-127)
94	Celeste Depth (0-127)
95	Phase Depth (0-127)
96	Data Increment (0 or 127)
97	Data Decrement (0 or 127)
98	Non-Registered Parameter MSB (0-127)
99	Non-Registered Parameter LSB (0-127)
100	Registered Parameter MSB (0-127)
101	Registered Parameter LSB (0-127)
121	Reset All Controllers (0)
122	Local Control On/Off (0 or 127)
123	All Notes Off (0)
124	Omni Off (0)
125	Omni On (0)
126	Mono On (0-16; 0=Omni Off)
127	Poly On (0)

SYSTEM COMMON MESSAGES

Intended for all units in a system, some of these MIDI messages are:

Song Position Pointer. This indicates how many “MIDI beats” (normally a 16th note) have elapsed since a piece started (up to 16,384 total beats). It is primarily used to allow different sequencers and drum machines to auto-locate to each other so that if you start one sequencer, the other device will automatically jump to the same place in the song, whereupon both continue on together.

System Exclusive. This message (called Sys Ex for short) is considered “exclusive” because different manufacturers send and receive data over MIDI which is intended only for that manufacturer’s equipment. *Example:* Sending a QSR message to an Alesis D4 Drum Module won’t do anything, but the message will be understood by other QSR. This data often contains information about individual instrument programs.

Timing Clock. A master tempo source (such as a sequencer) emits 24 timing messages (clocks) per quarter note. Each device synchronized to the sequencer advances by 1/24th of a quarter note when it receives the clock message, thus keeping units in sync after they’ve both started at the same time. Many devices subdivide this clock signal internally for higher resolution (e.g., 96 pulses per quarter note).

Start. Signals all rhythmically-based units when to start playing.

Stop. Signals all rhythmically-based units when to stop playing.

Continue. Unlike a Start command, which re-starts a sequencer or drum machine from the beginning of a song each time it occurs, sending a continue message after stop will re-start units from where they were stopped.

GENERAL MIDI

General MIDI is an extension of the MIDI standard designed to meet the demands of the ever-growing multimedia industry, and to make simple the act of playing commercially produced MIDI sequences. The General MIDI standard utilizes all 16 channels available in MIDI. The QSR is a perfect General MIDI companion, since its Mix Mode uses 16 channels. Although many channels are commonly used for specific types of instruments (*Example:* Channel 1 is usually piano, channel 2 is usually bass, etc.), channel 10 is always used for drums.

General MIDI also standardizes the placement of sound types in a sound device’s memory bank. The QSR’s GenMIDI Bank is designed specifically for General MIDI, and organizes its sounds according to the General MIDI specification. This means, when a sequencer sends a MIDI program change message that is supposed to call up a particular sound, the correct sound on the QSR will be called up, even if the composer of the sequence used a different sound device. The Programs in the GenMIDI Bank use the General MIDI names (in some cases abbreviated) with the letters GM added to indicate their are designed specifically for use in General MIDI mode.

There are three MIDI registered parameters which the QSR will recognize in Mix Play Mode when General MIDI Mode is enabled. These are:

- **MIDI Registered Parameter 0** (Pitch Bend Sensitivity): This will directly effect the Pitch Wheel Range parameter of all four Sounds of the Program on the received MIDI Channel of the Mix. If the Channel is selected using the [◀ MIDI CH ▶] buttons, the word “**EDITED**” will appear below the Mix number in the lower-left section of the display if this parameter is received. However, if you are viewing the Pitch Wheel Range parameter in the display (Program Edit Mode, Pitch Function, Page 4), the display will not be updated to reflect the new setting. If you go to another Page or Function and then return to it, the display will now reflect the updated setting.
- **MIDI Registered Parameter 1** (Fine Tune): This will directly effect the Detune Amount parameter of all four Sounds of the Program on the received MIDI Channel of the Mix. If this MIDI registered parameter is received, the QSR will automatically make sure that all four Sounds of the Program have their Detune Type parameter set to “Normal” (Program Edit Mode, Pitch Function, Page 3). If the Channel is selected using the [◀ MIDI CH ▶] buttons, the word “**EDITED**” will appear below the Mix number in the lower-left section of the display if this parameter is received. However, if you are viewing the Detune Amount parameter in the display (Program Edit Mode, Pitch Function, Page 2), the display will not be updated to reflect the new setting. If you go to another Page or Function and then return to it, the display will now reflect the updated setting.
- **MIDI Registered Parameter 2** (Coarse Tune): This will directly effect the Tune Semitone parameter of all four Sounds of the Program on the received MIDI Channel of the Mix. If the Channel is selected using the [◀ MIDI CH ▶] buttons, the word “**EDITED**” will appear below the Mix number in the lower-left section of the display if this parameter is received. However, if you are viewing the Tune Semitone parameter in the display (Program Edit Mode, Pitch Function, Page 1), the display will not be updated to reflect the new setting. If you go to another Page or Function and then return to it, the display will now reflect the new setting.

(Portions of this appendix are abridged versions of material from Power Sequencing with Master Tracks Pro/Pro 4 and The Complete Guide to the Alesis HR-16 and MMT-8, copyright 1990 and 1989 respectively by AMSCO Publications, and is adapted with permission.)

MIDI IMPLEMENTATION CHART

Function		Transmitted	Recognized	Remarks
Basic Channel	Default	X	1 — 16	Memorized
	Changed	X	1 — 16 each	
Mode	Default	Mode 3	Mode 3	
	Messages Altered	X * * * * * * * *	X	
Note Number		X	0 — 127	
	True Voice	X	0 — 127	
Velocity	Note On	X	O	
	Note Off	X	O	
After Touch	Key's	X	O	
	Ch's	X	O	
Pitch Bender		X	O	
Control Change 0 — 120		X	O	
Prog Change		O ¹ 0 — 127 * * * * * * * *	O ¹ 0 — 127 0 — 127	
	True #			
System Exclusive		O	O	
System Common	Song Pos	X	X	
	Song Sel	X	X	
	Tune	X	X	
System Realtime	Clock	X	X	
	Commands	X	X	
Aux Messages	Local On/Off	X	O ²	
	All Notes Off	X	O	
	Active Sense	X	X	
	Reset	X	O ²	
	GM On	X	O	
Notes				
¹ O, X is selectable ² Recognized as ALL NOTES OFF				

Mode 1: OMNI ON, POLY
 Mode 1: OMNI ON, MONO

Mode 3: OMNI OFF, POLY
 Mode 4: OMNI OFF, MONO

O : Yes
 X : No

APPENDIX C:

PARAMETERS INDEX

PROGRAM EDIT PARAMETERS

Parameter	Function	Display Page	Page in Manual
Aftertouch Depth: Amp	Amp/Range	2	58
Aftertouch Depth: ALFO	Amp LFO	7	76
Aftertouch Depth: Filter	Filter	5	57
Aftertouch Depth: FLFO	Filter LFO	7	75
Aftertouch Depth: Pitch	Pitch	5	54
Aftertouch Depth: PLFO	Pitch LFO	7	74
Amp ENV Level	Amp ENV	10	68
Amp ENV Trigger	Amp ENV	7	67
Amp LFO Delay	Amp LFO	3	75
Amp LFO Depth	Amp/Range	3	59
Amp LFO Level	Amp LFO	5	76
Amp LFO Mod. Wheel Depth	Amp LFO	6	76
Amp LFO Speed	Amp LFO	2	75
Amp LFO Trigger	Amp LFO	4	75
Amp LFO Waveform	Amp LFO	1	75
Attack: Amp	Amp ENV	1	66
Attack: Filter	Filter ENV	1	64
Attack: Pitch	Pitch ENV	2	61
Decay: Amp	Amp ENV	2	66
Decay: Filter	Filter ENV	2	64
Decay: Pitch	Pitch ENV	2	61
Effect Bus	Level	5	53
Effect Level	Level	4	53
Filter ENV Depth	Filter	7	61
Filter ENV Level	Filter ENV	10	70
Filter ENV Trigger	Filter ENV	7	69
Filter ENV Velocity Depth	Filter ENV	11	70
Filter Frequency	Filter	1	60
Filter Keyboard Tracking	Filter	2	60
Filter LFO Delay	Filter LFO	3	74
Filter LFO Depth	Filter	6	57
Filter LFO Level	Filter LFO	5	74
Filter LFO Mod. Wheel Level	Filter LFO	6	75
Filter LFO Speed	Filter LFO	2	74
Filter LFO Trigger	Filter LFO	4	74
Filter LFO Waveform	Filter LFO	1	74
Keyboard Mode	Pitch	10	55
Mod. Wheel Depth: Amp LFO	Amp LFO	6	76
Mod. Wheel Depth: Filter	Filter	4	57
Mod. Wheel Depth: Filter LFO	Filter LFO	6	75
Modulation Destination	Mod 1 – 6	2	71

Parameter	Function	Page	Page in Manual
Modulation: Gate Mode	Mod 1 – 3	4	71
Modulation Level	Mod 1 – 6	3	71
Modulation: Quantize Mode	Mod 4 – 6	4	71
Modulation Source	Mod 1 – 6	1	69
Name (Program)	Name	1 – 10	68
Output	Level	3	53
Pan	Level	2	53
Pitch ENV Depth	Pitch	7	54
Pitch ENV Level	Pitch ENV	10	63
Pitch ENV Trigger	Pitch ENV	7	62
Pitch ENV Velocity Depth	Pitch ENV	11	63
Pitch LFO Delay	Pitch LFO	3	72
Pitch LFO Depth	Pitch	6	54
Pitch LFO Level	Pitch LFO	5	73
Pitch LFO Mod. Wheel Level	Pitch LFO	6	73
Pitch LFO Speed	Pitch LFO	2	72
Pitch LFO Trigger	Pitch LFO	4	73
Pitch LFO Waveform	Pitch LFO	1	72
Pitch Wheel Range: Pitch	Pitch	4	54
Portamento Type	Pitch	8	55
Portamento Rate	Pitch	9	55
Range Lower limit	Amp/Range	4	59
Range Upper Limit	Amp/Range	5	59
Release: Amp	Amp ENV	4	67
Release: Filter	Filter ENV	4	64
Release: Pitch	Pitch ENV	4	61
Sound Enable	Voice	1	50
Sound Overlap	Amp/Range	6	60
Sound Type	Voice	2	50
Sustain: Amp	Amp ENV	3	66
Sustain: Filter	Filter ENV	3	64
Sustain: Pitch	Pitch ENV	3	61
Sustain Decay: Amp	Amp ENV	6	67
Sustain Decay: Filter	Filter ENV	6	65
Sustain Decay: Pitch	Pitch ENV	6	62
Sustain Pedal: Amp	Amp ENV	9	68
Sustain Pedal: Filter	Filter ENV	9	65
Sustain Pedal: Pitch	Pitch ENV	9	63
Time Track: Amp ENV	Amp ENV	8	68
Time Track: Filter ENV	Filter ENV	8	65
Time Track: Pitch ENV	Pitch ENV	8	62
Track Input	Track Gen	1	77
Track Points (0—10)	Track Gen	2 – 12	77
Tuning: Semitone	Pitch	1	54
Tuning: Detune	Pitch	2	54
Tuning: Type	Pitch	3	54
Velocity	Filter	3	56

Parameter	Function	Page	Page in Manual
Velocity Curve/Crossfade	Amp/Range	1	58
Sound Group	Voice	3	51
Sound Name	Voice	4	51
Sound Volume	Level	1	53

MIX EDIT PARAMETERS

Parameter	Function	Display Page	Page in Manual
Aftertouch	Controllers	2	39
Controllers A–D	Controllers	4	39
Effect Channel	Effect	2	38
Effect MIDI	Effect	1	38
Keyboard	Keyboard/MIDI	3	38
MIDI In	Keyboard/MIDI	1	38
MIDI Out	Keyboard/MIDI	2	38
Name	Name	1 – 10	40
Pitchbend and Mod Wheels	Controllers	1	39
Program Effect Bus	Level	6	37
Program Effect Level	Level	5	37
Program Enable	Level	1	37
Program Output	Level	4	37
Program Pan	Level	3	37
Program Volume	Level	2	37
Range Lower limit	Range	1	40
Range Upper Limit	Range	2	40
Sustain Pedal	Controllers	3	39
Tuning: Octave	Pitch	1	38
Tuning: Semitone	Pitch	2	38

INDEX

- Aftertouch 15
 - Amp 62
 - Filter 60
 - Pitch 58
- Compare 29, 34
- Computer 23, 117
- Controllers 115
- Copy
 - Sound 85
 - Effects 85
- Demo 11
- Direct Select 33
- Digital Output 25
- Display 30
- Drum Mode 53
- Edit buffer 34, 40
- Effects Edit 29, 89
 - Clip 88
 - Configuration 91, 92-97
 - EQ 98
 - Mix 111
 - Mod 98
 - Modulation 98
 - Reverb 106
- Footswitch 24
- 48kHz Input 26
- Global Edit 29, 113
- Headphones 9
- Input/Output 117
- Keyboard
 - Curve 113
 - Mode 22, 45, 114
 - Scaling 114
 - Transpose 114
- Local Off 46
- Master Pitch 113
- Master Tune 113
- Memory
 - Preset 34
 - User 34
- MIDI 21-22, 121-132
 - Channel 14
 - Controllers 133
 - I/O 117
 - IN 21
 - OUT 21, 45, 118
 - Program Select 116
 - System Exclusive 21, 124
- Mix 28
 - Mix Edit 29, 39
 - Effect Bus 42
 - Effect Level 41
 - FX Channel 42
 - FX Program Change 42
 - Keyboard 42
 - MIDI 42,43
 - Name 44
 - Output 41
 - Pan 41
 - Pitch 42
 - Octave 42
 - Semitone 42
 - Range 44
 - Mix Mode 13, 16, 28, 39
 - Modulation Wheel 15
 - Name
 - Mix 44
 - Program 72
 - Outputs 9
 - PCMCIA 19
 - Pedals 24, 115
 - Pitch Bend 15
 - Polyphony 27, 45, 64
 - Power 7, 11
 - Preset Bank 27
 - Program 27
 - Program Edit 28, 54
 - Amp 51
 - Aftertouch 62
 - Velocity Curve 62
 - Amp Envelope 70
 - Amp LFO 63, 79
 - Amp/Range 62
 - Drum Mode 53, 82
 - Amp Envelope 84
 - Level 83
 - Pitch 83
 - Velocity 83
 - Effect
 - Effect Bus 57
 - Envelope 52
 - Filter
 - Aftertouch 61
 - Cutoff frequency 50
 - Lowpass 50
 - Modulation Wheel 61
 - Velocity 60
 - Filter Envelope 61, 68
 - Filter LFO 61, 78
 - Keyboard Mode 59
 - LFO 52
 - Modulation 51, 73
 - Name 72
 - Pan 57
 - Pitch
 - Aftertouch 58
 - Pitch Wheel 58
 - Pitch LFO 58, 76
 - Portamento 59
 - Sound 48, 49
 - Sound Enable 54
 - Sound Overlap 64
 - Sound Type 54
 - Voice 49, 54
 - Volume 57
- Program Mode 13, 28
- Re-initializing 86, 127
- Samples 27
- Software Version 127
- Sound 27
- Sound Bridge 20
- Sound Card 20
- Sound Groups 27
- Store 29, 35, 36, 37, 90
- Sustain Footswitch 24
- User Bank 27
- Velocity 15

Free Manuals Download Website

<http://myh66.com>

<http://usermanuals.us>

<http://www.somanuals.com>

<http://www.4manuals.cc>

<http://www.manual-lib.com>

<http://www.404manual.com>

<http://www.luxmanual.com>

<http://aubethermostatmanual.com>

Golf course search by state

<http://golfingnear.com>

Email search by domain

<http://emailbydomain.com>

Auto manuals search

<http://auto.somanuals.com>

TV manuals search

<http://tv.somanuals.com>