

# User's Guide

## for your frontload washer

### Inside . . .

Safety Information . . .	3
Operation . . . . .	6
Clothing Care . . . . .	18
Maintenance . . . . .	27
Troubleshooting . . . .	29



Para bajar una copia de estas instrucciones en español, visite [www.comlaundry.com](http://www.comlaundry.com).

  
**Alliance**  
Laundry Systems

[www.comlaundry.com](http://www.comlaundry.com)

Part No. 802753  
November 2006



## WARNING

For your safety and to reduce the risk of fire or an explosion, do not store or use gasoline or other flammable vapors and liquids in the vicinity of this or any other appliance.

W022E

# Safety Information

## Explanation of Safety Messages

Throughout this manual and on machine decals, you will find precautionary statements (“DANGER,” “WARNING,” and “CAUTION”) followed by specific instructions. These precautions are intended for the personal safety of the operator, user, servicer, and those maintaining the machine.

	<b>DANGER</b>
Indicates an imminently hazardous situation that, if not avoided, will cause severe personal injury or death.	

	<b>WARNING</b>
Indicates a hazardous situation that, if not avoided, could cause severe personal injury or death.	

	<b>CAUTION</b>
Indicates a hazardous situation that, if not avoided, may cause minor or moderate personal injury or property damage.	

Additional precautionary statements (“IMPORTANT” and “NOTE”) are followed by specific instructions.

**IMPORTANT:** The word “IMPORTANT” is used to inform the reader of specific procedures where minor machine damage will occur if the procedure is not followed.

**NOTE:** The word “NOTE” is used to communicate installation, operation, maintenance or servicing information that is important but not hazard related.

## Important Safety Instructions

### Save These Instructions

	<b>WARNING</b>
To reduce the risk of fire, electric shock, serious injury or death to persons when using your washer, follow these basic precautions:	
W023	

1. Read all instructions before using the washer.
2. Refer to the *Grounding (Earthing) Information* in the Installation Instructions for the proper grounding (earthing) of the washer.
3. Do not wash articles that have been previously cleaned in, washed in, soaked in, or spotted with gasoline, dry-cleaning solvents, or other flammable or explosive substances as they give off vapors that could ignite or explode.
4. Do not add gasoline, dry-cleaning solvents, or other flammable or explosive substances to the wash water. These substances give off vapors that could ignite or explode.



© Copyright 2006, Alliance Laundry Systems LLC  
All rights reserved. No part of the contents of this book may be reproduced or transmitted in any form or by any means without the expressed written consent of the publisher.

5. Under certain conditions, hydrogen gas may be produced in a hot water system that has not been used for two weeks or more. HYDROGEN GAS IS EXPLOSIVE. If the hot water system has not been used for such a period, before using a washing machine or combination washer-dryer, turn on all hot water faucets and let the water flow from each for several minutes. This will release any accumulated hydrogen gas. THE GAS IS FLAMMABLE. DO NOT SMOKE OR USE AN OPEN FLAME DURING THIS TIME.
6. Do not allow children to play on or in the washer. Close supervision of children is necessary when the washer is used near children. This is a safety rule for all appliances. This appliance is not intended for use by young children or infirm persons without supervision. Young children should be supervised to ensure that they do not play with the appliance.
7. Before the washer is removed from service or discarded, remove the door to the washing compartment.
8. Do not reach into the washer if the wash drum is moving.
9. Do not install or store the washer where it will be exposed to water and/or weather.
10. Do not tamper with the controls.
11. Do not repair or replace any part of the washer, or attempt any servicing unless specifically recommended in the user-maintenance instructions or in published user-repair instructions that you understand and have the skills to carry out.
12. To reduce the risk of an electric shock or fire, DO NOT use an extension cord or an adapter to connect the washer to the electrical power source.
13. Use your washer only for its intended purpose, washing clothes.
14. ALWAYS disconnect the washer from electrical supply before attempting any service. Disconnect the power cord by grasping the plug, not the cord.
15. Install the washer according to the Installation Instructions. All connections for water, drain, electrical power and grounding (earthing) must comply with local codes and be made by licensed personnel when required. Do not do it yourself unless you know how!
16. To reduce the risk of fire, clothes which have traces of any flammable substances such as vegetable oil, cooking oil, machine oil, flammable chemicals, thinner, etc. or anything containing wax or chemicals such as in mops and cleaning cloths, must not be put into the washer. These flammable substances may cause the fabric to catch on fire by itself.
17. Do not use fabric softeners or products to eliminate static unless recommended by the manufacturer of the fabric softener or product.
18. Keep your washer in good condition. Bumping or dropping the washer can damage safety features. If this occurs, have your washer checked by a qualified service person.
19. Replace worn power cords and/or loose plugs.
20. Be sure water connections have a shut-off valve and that fill hose connections are tight. CLOSE the shut-off valves at the end of each wash day.
21. Loading door MUST BE CLOSED any time the washer is to fill, tumble or spin. DO NOT by-pass the loading door by permitting the washer to operate with the loading door open.
22. Check washer for water leaks after each use. If water is found, turn off the water supply and call for service immediately. Don't use washer until it is repaired by an authorized service agent.
23. If the washer's volume or type of sound changes from what is normally heard, call an authorized service agent immediately to prevent possible damage to other components.
24. Never start a cycle and leave the property without first checking to make sure the wash cycle is complete.

25. Always read and follow manufacturer's instructions on packages of laundry and cleaning aids. Heed all warnings or precautions. To reduce the risk of poisoning or chemical burns, keep them out of the reach of children at all times (preferably in a locked cabinet).
26. Always follow the fabric care instructions supplied by the garment manufacturer.
27. Never operate the washer with any guards and/or panels removed.
28. DO NOT operate the washer with missing or broken parts.
29. DO NOT by-pass any safety devices.
30. Failure to install, maintain, and/or operate this machine according to the manufacturer's instructions may result in conditions which can produce bodily injury and/or property damage.
31. Replace washer fill hoses every five years.
32. If unit is a stacked washer and dryer, do not operate washer and dryer if the units have been separated.

**NOTE: The WARNING and Important Safety Instructions appearing in this manual are not meant to cover all possible conditions and situations that may occur. Observe and be aware of other labels and precautions that are located on the machine. They are intended to provide instructions for safe use of the machine. Common sense, caution and care must be exercised when installing, maintaining, or operating the washer.**

Always contact your dealer, distributor or service agent about any problems or conditions you do not understand.



# Operation

## Before Washing

### Prepare Wash Load

#### Empty Pockets and Cuffs

Make sure all pockets are empty and turn them inside out. One bobby pin, metal or plastic toy, nail or sharp object in a load can catch laundry and cause tears. Facial tissue left in a pocket will produce extreme "lint". A crayon or lipstick in a wash load may cause stains that cannot be removed. Roll down cuffs and shake out grass, sand and gravel.

#### Mend Rips and Tears

Little holes can become bigger in the washer. Mend holes and tears before placing garments in the washer.

#### Close Zipper and Fasten Hooks

These can catch on garments in a wash load and tear them. Tie belts and sashes so they won't wind around clothes.

#### Put Small Items in Bag

Small items such as baby socks may get stuck around the door. Put them inside a mesh garment bag.

#### Check For Colorfastness

Squeeze a portion of garment in warm or hot sudsy water. If the color bleeds or runs, wash the item separately in cold water.

### Sorting Items

Different items use different wash cycles and temperatures. Always follow the manufacturer's care label. Proper sorting is easy if you follow a few guidelines:

#### 1. Sort by Color:

Separate items into loads of whites, darks, lights and non-colorfast.

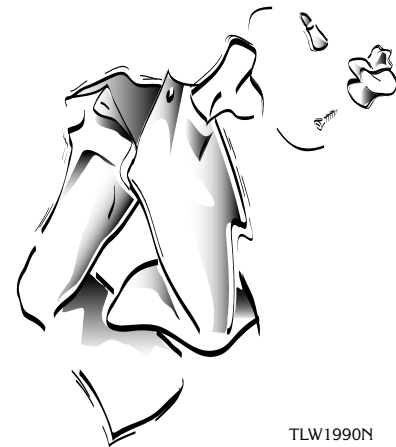

#### 2. Sort by Fabric and Construction:

Separate items into loads of cottons/linens, permanent press, synthetics/blends/poly knits, and delicates.



#### 3. Sort by Temperature:

Separate items into loads that can be washed in cold, warm or hot water.



#### 4. Sort by Type and Amount of Soil:

Heavily soiled clothes will need extra treatment. Lightly soiled clothes can become dingy if washed with heavily soiled items.

#### 5. Sort Lint "Shedders" From Lint "Receivers":

Some fabrics attract lint and should not be washed with lint-shedding loads. Lint shedders are cottons, terry towels, chenille bedspreads, rugs and clothes that have been heavily bleached.

Lint receivers are synthetics, permanent or durable press, knits (including socks), corduroy, and other smooth fabrics.

### Pretreat

Pretreat shirt collars and cuffs with a pretreat product or liquid detergent when placing them in the washer. Before washing, treat special stains individually. Refer to *Stain Removal* section for procedures on treating specific stains.



## WARNING

**Do not wash or dry items soiled with vegetable or cooking oils. Some oils may remain after washing and may cause the fabric to catch on fire by itself.**

W527

## Loading the Washer

### Load Articles

- Load items by the amount of space they take up, not by their weight. Mix large and small items in a load to get the best washing results.
- Load items loosely into the wash drum. The bulk of the clothes rather than the weight will determine load size.

### Load Sizes

- Load sizes vary. Small and large items should be washed together to create a balanced load. If washing a large item, two bath towels should be added to even the load.
- Smaller loads can create an unbalanced condition and cause premature wear on the washer. Do not hesitate to fill the entire inner drum of the washer. The load will compress a great deal when wet. This allows room for proper tumbling.

### Water Level

- The washer will automatically adjust the water level to the type and size of the load during any fill.

### Wash Temperature

#### *Boosted Hot Water (on select models only)*

The Boosted Hot Wash will boost the water temperature in the tub to 140°F (60°C) and is useful for improved cleaning of some loads. The red HEATING light will light up when heating. The cycle will not advance until 140°F (60°C) has been reached.

The time needed to reach this temperature may add an additional 30 to 60 minutes to the cycle time. Hot water is the most effective for cleaning but it is not recommended for all fabric types (read labels).

**NOTE: The Boosted Hot Wash can be turned off by changing the cycle selector knob to OFF and restarting a cycle with a different water temperature setting.**

#### *Hot Water*

The Hot Wash temperature is determined by the actual temperature of the hot water supplied to the washer. For models with Boosted Hot Wash, the heater element will not be on. Hot water is the most effective for cleaning, but it is not recommended for all fabric types (read labels).

#### *Warm Water*

The Warm Wash is useful for providing a thorough cleaning on lightly soiled clothing without damaging fabric or adding to color fading.

The Warm Rinse is useful in preventing wrinkles on certain fabrics. Check labels for fabric manufacturer's recommendations.

#### *Cold Water*

The Cold Wash is ideal for delicate items. Although its cleaning abilities are not as great with hot or warm water, it is useful for colors that bleed easily and for sensitive fabrics.

The Cold Rinse is optional in every cycle and is the most beneficial for fabrics. **Cold rinses reduce wrinkling and color fading. In addition, cold rinses will save money and energy.**

**NOTE: In wash temperatures colder than 60°F (15°C), detergents do not dissolve well. This may cause ineffective cleaning, or lint and residue to form.**

**NOTE: Always follow manufacturer's care labels.**



## Wash Temperature Guide

Water Temperature	Use	Comments
BOOSTED HOT (select models only) (approximately 140°F [60°C])	<ul style="list-style-type: none"> <li>Sturdy whites and colorfast items</li> <li>Work clothes</li> <li>Heavily soiled items</li> <li>Diapers</li> </ul>	<ul style="list-style-type: none"> <li>Best cleaning for heavily soiled items</li> <li>Best for sanitizing</li> </ul>
HOT (approximately 120°F [49°C] or as determined by outside hot water supply)	<ul style="list-style-type: none"> <li>Sturdy whites and colorfast items</li> <li>Work clothes</li> <li>Soiled items</li> <li>Diapers</li> </ul>	<ul style="list-style-type: none"> <li>Best cleaning for soiled items</li> <li>Good for sanitizing</li> </ul>
WARM (approximately 100° F [37°C])	<ul style="list-style-type: none"> <li>Rinsing of some items</li> <li>Light and moderately soiled items</li> <li>Non-colorfast or dark colors</li> <li>Permanent press</li> <li>Silks, woolens, nylon, acrylic</li> </ul>	<ul style="list-style-type: none"> <li>Reduces wrinkling in permanent press fabrics</li> <li>Less fading</li> <li>Reduces shrinking in knits</li> </ul>
COLD (approximately 60° F [15°C])	<ul style="list-style-type: none"> <li>Rinsing of most items</li> <li>Non-colorfast fabrics</li> <li>Extra delicate clothing</li> </ul>	<ul style="list-style-type: none"> <li>Saves energy</li> <li>Reduces color fading</li> <li>Reduces wrinkling</li> <li>Reduces shrinking</li> </ul>

### Energy

You can save energy when washing by following a few guidelines:

1. Heating water accounts for the greatest energy expense when washing. Save on heating water by using warm or cold washes as well as cold rinses.
2. Wash full loads, but do not overload.

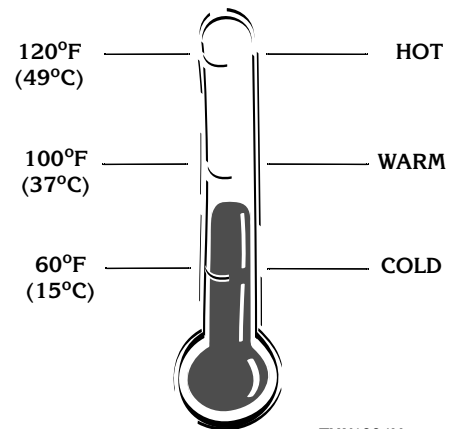



# Operating Your Washer

	<b>WARNING</b>
<p><b>To reduce the risk of fire, electric shock, serious injury or death to persons, read the <i>Safety Information</i> section before operating your washer.</b></p>	
<small>W522</small>	

**NOTE:** Always follow manufacturer's care labels.

## Determine Proper Cycle

**NOTE:** The cycle times might be longer if a **Boosted Hot Wash**, if available, is selected.

### *Regular Cycle*

Use for sturdy items, like play or work clothes, towels, T-shirts, etc. This cycle includes a wash tumble for 24 minutes. The cycle has two rinses with an optional third rinse. The final spin starts with a two-minute medium spin and finishes with a three-minute high spin. The total cycle time is approximately 44 minutes without the extra rinse.

### *Permanent Press Cycle*

Use for permanent press items and synthetics. This cycle includes a wash tumble of 20 minutes. The cycle has two rinses with an optional third rinse. The final spin starts with a three-minute medium spin and finishes with a two-minute high spin. The total cycle time is approximately 40 minutes without the extra rinse.

### *Delicate Cycle*

Wash delicate items usually washed by hand on this cycle. The cycle includes a wash tumble of 12 minutes. The cycle has two rinses with an optional third rinse. The final spin extracts moisture at a low spin for four minutes. The total cycle time is approximately 30 minutes without the extra rinse.

### *Rinse & Spin Cycle*

Use to quickly rinse items. The rinse is followed by a high spin. The total cycle time is approximately 12 minutes.

### *Spin Only Cycle*

Use to extract water from wet items. This cycle uses the high spin. The total cycle time is approximately 10 minutes.

### **OFF**

Use to stop a cycle or change cycles.

### **Extra Rinse**

This optional setting is useful for detergent sensitive skin. By pressing the "EXTRA RINSE" button to "ON," the REGULAR, PERMANENT PRESS and DELICATE cycles will each provide an additional rinse.



## To Wash Clothes

**IMPORTANT:** Before using your new washer, make sure the washer cord is plugged into an appropriate electrical outlet that has the proper grounding (earthing) and polarity. Refer to the washer nameplate and *Installation Instructions* for proper voltage and Hertz the washer is designed to operate on. Refer to *Contact Information* section for nameplate location. Make sure the washer hoses are connected to the hot and cold water faucets, and that the faucets are turned on. Be sure the drain hose is not kinked and is inserted into a drain. Refer to the **INSTALLATION INSTRUCTIONS** for details of proper washer installation.

**IMPORTANT:** Prior to first wash, use an all purpose cleaner, or a detergent and water solution, and a damp cloth to remove shipping dust from inside of wash drum.

1. Get the clothes ready for washing. Empty pockets and cuffs. Sort items into separate loads. Pretreat stains and heavily soiled areas.



TLW1991N

**IMPORTANT:** Remove all sharp objects from laundry to avoid tears and rips to items during normal machine operation.

2. Measure and add **low sudsing, high efficiency (HE) detergent**, fabric softener and bleach to the dispenser drawer. Refer to section on *Using Your Dispenser Drawer*. Follow instructions on detergent package for amount to use.



FLW2169N

**NOTE:** High efficiency (HE) detergents are designed especially for frontload washers to reduce oversudsing and maximize cleaning results.



Look for the HE logo or “high efficiency” on the detergent’s label.

**IMPORTANT:** If using detergents made for topload washers, avoid oversudsing by using only 1/4 cup regular detergent (1/2 of the recommended amount).

3. Load clothes into wash drum. (18 pounds [8.1 kg] maximum dry clothes load.) Refer to section on *Load Sizes*.

**NOTE:** Small items such as baby socks may get caught around the door. Place these articles inside a mesh garment bag.



FLW2170N

4. Close the loading door tightly. The washer will not operate with the loading door open.

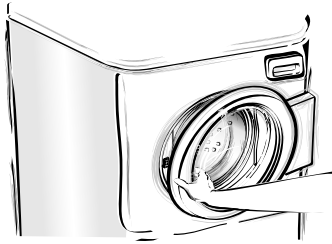

FLW2171N

6. Select EXTRA RINSE if desired.

**EXTRA  
RINSE**



FLW2175N

	<b>WARNING</b>
<p><b>To reduce the risk of serious injury, do not bypass the loading door switch by permitting the washer to tumble or spin with the loading door open.</b></p>	
W095	

5. Set WASH/RINSE temperatures.

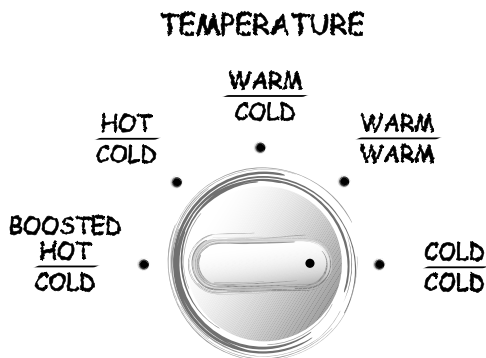

FLW2174N

There are four or five WASH/RINSE temperatures available – Boosted Hot Wash/Cold Rinse (select models only), Hot Wash/Cold Rinse, Warm Wash/Warm Rinse, Warm Wash/Cold Rinse, Cold Wash/Cold Rinse.

Refer to the Water Temperature section for the temperature that works best for your garments.

The extra rinse control is useful for detergent sensitive skin. By pressing the EXTRA RINSE to ON, the REGULAR, PERMANENT PRESS, and DELICATE cycles will each provide an additional rinse. If the rinse is desired, press the switch to ON. When the extra rinse is not wanted, OFF should be selected.

7. Select the cycle according to the type of fabric being washed. Use the indicator dot on the cycle selector knob as a guide.
8. Press and hold the START button for two seconds to start the washer. The DOOR light will come on after a short delay, water fill will begin, and wash drum will begin tumbling.

**NOTE: Washer door MUST be closed tightly to start washer.**

If items need to be added or removed after a cycle has started, turn the cycle selector knob to the OFF position. Wait until the DOOR light goes off (approximately 45 seconds after cycle has been stopped), open door, add or remove items, and start the cycle again.

	<b>WARNING</b>
<p><b>Window may be hot in the Boosted Hot and Hot wash cycles.</b></p>	
W325	



There is no agitator on this washer. Instead, the clothing gently tumbles through the water. The wash action consists of a period of tumbling in one direction, a brief pause, and then a reverse tumble in the opposite direction. The pauses are part of the tumble action and add to the unique cleaning capabilities of the washer. They are part of the cycle.

**NOTE: There will be extended pauses when Boosted Hot Wash, if available, is selected because the water is being heated.**

### **To Change Cycles**

If the selected cycle is not the correct cycle for the fabric being washed, you may change the cycle selection at any time until the first wash fill is complete. Once the washer has filled for the first part of the cycle (the wash portion), the current cycle must be aborted and a new cycle must be started.

**To change the cycle before the first fill is complete:**

Change the cycle selected on the cycle selector knob.

**To change the cycle after the first fill is complete and before the first wash is complete:**

1. Abort the current cycle by changing the cycle selector knob to the OFF position.
2. Set the WASH/RINSE temperature selector.
3. Set cycle selector knob.
4. Turn on extra rinse, if desired.
5. Press and hold the START button for two seconds.

**To change the cycle after the first wash is complete:**

**NOTE: This should only be done if the speed of the final extract is incorrect for the fabric being washed. For example, if washing delicate items on the REGULAR cycle, the high speed extract may damage the fabric. Or, if washing towels or jeans on the DELICATE cycle, the lower speed extract would increase drying time.**

1. Abort the current cycle by changing the cycle selector switch to the OFF position.
2. Restart the cycle from the beginning. Refer to the *To Wash Clothes* section.

### **To Pump Out Water After Aborting Cycle**

Run a SPIN ONLY cycle. This cycle will perform a high speed extract operation that will pump all of the water out of the washer.

### **Manual Soaking**

To soak a clothes load, start a wash in the desired cycle. After fill is complete and wash drum has started tumbling, turn the cycle selector knob to OFF. When the clothes have soaked the desired length of time, turn the cycle selector knob to the cycle and press the start button to restart the cycle.

## **DOOR Light**

When the washer is started, the DOOR light will come on after a short delay. The light will turn off approximately 45 seconds after the cycle is complete.

## **WASH Light**

This light comes on during the wash part of each cycle.

## **RINSE Light**

This light comes on for the rinse portion of each cycle.

## **FINAL SPIN Light**

This light comes on while the wash load is in the final spin of the cycle.

## **HEATING Light (Red Light – on select models only)**

This light comes on during the Boosted Hot setting only. While the washer is heating, the HEATING light will turn on.

## **Out of Balance Load**

If at the end of the cycle, the load is dripping wet, the washer has limited the spin speed. This is to prevent damage to the unit if there is a severely unbalanced load.

If this condition occurs, redistribute the load manually and run a RINSE & SPIN cycle.

If the condition persists, consider steps discussed in the *Before Washing* section.



## Available Washing Cycles

The cycles of your washer include several different settings. Refer to the table below for what can be expected during the cycles that you select.

<b>Regular Cycle</b>		
	<b>Activity</b>	<b>Water Temperatures</b>
<b>Wash</b>	Fill & Tumble	Boosted Hot (select models), Hot, Warm or Cold
<b>Spin</b>	Pulse Spin	
<b>Rinse</b>	Fill & Tumble	Cold
<b>Spin</b>	Pulse Spin	
<b>Extra Rinse (Optional)</b>	Fill & Tumble	Cold
<b>Spin</b>	Pulse Spin	
<b>Final Rinse</b>	Fill & Tumble	Warm or Cold
<b>Spin</b>	Pulse Spin	
<b>Spin</b>	Medium Spin (650 rpm)	
<b>Final Spin</b>	High Spin (1000 rpm)	
<b>Fluff</b>	Tumble	
<b>Permanent Press Cycle</b>		
	<b>Activity</b>	<b>Water Temperatures</b>
<b>Wash</b>	Fill & Tumble	Boosted Hot (select models), Hot, Warm or Cold
<b>Spin</b>	Pulse Spin	
<b>Rinse</b>	Fill & Tumble	Cold
<b>Spin</b>	Pulse Spin	
<b>Extra Rinse (Optional)</b>	Fill & Tumble	Cold
<b>Spin</b>	Pulse Spin	
<b>Final Rinse</b>	Fill & Tumble	Warm or Cold
<b>Spin</b>	Pulse Spin	
<b>Spin</b>	Medium Spin (650 rpm)	
<b>Final Spin</b>	High Spin (1000 rpm)	
<b>Fluff</b>	Tumble	

<b>Delicate Cycle</b>		
	<b>Activity</b>	<b>Water Temperatures</b>
<b>Wash</b>	Fill & Tumble	Boosted Hot (select models), Hot, Warm or Cold
<b>Spin</b>	Pulse Spin	
<b>Rinse</b>	Fill & Tumble	Cold
<b>Spin</b>	Pulse Spin	
<b>Extra Rinse (Optional)</b>	Fill & Tumble	Cold
<b>Spin</b>	Pulse Spin	
<b>Final Rinse</b>	Fill & Tumble	Warm or Cold
<b>Spin</b>	Pulse Spin	
<b>Final Spin</b>	Low Spin (500 rpm)	
<b>Fluff</b>	Tumble	
<b>Rinse &amp; Spin Cycle</b>		
	<b>Activity</b>	<b>Water Temperatures</b>
<b>Rinse</b>	Fill & Tumble	Warm or Cold
<b>Spin</b>	Pulse Spin	
<b>Spin</b>	Medium Spin (650 rpm)	
<b>Final Spin</b>	High Spin (1000 rpm)	
<b>Fluff</b>	Tumble	

**NOTE:** The Rinse setting will give a cold rinse when the optional Extra Rinse is selected.

### Common Washer Sounds

<b>Sounds</b>	<b>Cause</b>
<b>Accelerating</b>	This sound is heard during the spin portion of every cycle.
<b>Tapping</b>	These sharp sounds may come from metal fasteners, zippers, belt buckles or coins hitting the wash drum or door glass.
<b>Thumping</b>	Washer may be out of balance. Washer is designed to balance the load. If the washer is severely unbalanced, turn cycle selector knob to OFF and redistribute the load.
<b>Rumbling</b>	Washer may not be level. Stop washer and adjust leveling legs. Refer to INSTALLATION INSTRUCTIONS for details.

## Using Your Dispenser Drawer

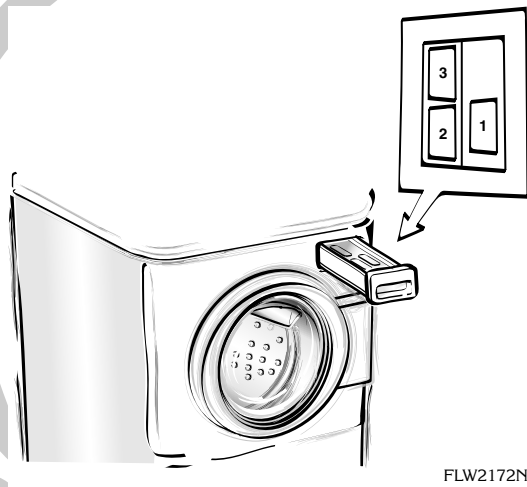

- 1 Detergent
- 2 Bleach
- 3 Fabric Softener

### Detergent Compartment

The detergent compartment is located on the right side of the dispenser drawer. Refer to compartment 1 of illustration.

Use low sudsing, high efficiency (HE) powdered or liquid detergents that are recommended for use with frontload washers. Powdered bleach can also be used in the dispenser along with the detergent.

**NOTE: High efficiency (HE) detergents are designed especially for frontload washers to reduce oversudsing and maximize cleaning results. Look for the HE logo or "high efficiency" on the detergent's label.**



**NOTE: If using detergents made for topload washers, avoid oversudsing by using only 1/4 cup regular detergent (1/2 of the recommended amount).**

When adding detergent, use only the recommended amount. Adding too much detergent or using regular sudsing detergent could result in an oversudsing condition, which would require additional rinsing with cold water. Use care when adding detergent so as not to spill into the other compartments. Detergent mixed with fabric softener can make the softener gummy.

**NOTE: The normal level of suds should be below center of the door.**

### Liquid Bleach Compartment

The bleach compartment is located in the left front corner of the dispenser drawer. Refer to compartment 2 of illustration. It has been designed to prevent the dispensing of undiluted bleach onto the clothes load.

Use liquid bleach in the dispenser. **Powdered bleach must not be used in this compartment. Powdered bleach can be used in the detergent compartment only and can be added along with the detergent.**

**DO NOT use more than the maximum level indicated for the bleach compartment.** Adding more than the maximum amount could result in early dispensing of the product and possible damage to fabrics.

Carefully pour recommended amount of bleach into the compartment before starting wash load.

Be careful not to spill undiluted bleach. It is a strong chemical and can damage some fabrics if it is not properly diluted. Follow bleach manufacturer's label for proper use.

Carefully close dispenser door. Do not allow bleach to spill into other compartments.



## Fabric Softener Compartment

The fabric softener compartment is located in the left rear corner of the dispenser drawer. Refer to compartment 3 of illustration.

Use no more than the maximum level indicated for the fabric softener compartment. Adding more than the maximum amount could result in early dispensing of the product and possible staining of fabrics.

Add fabric softener to compartment before beginning wash load. The fabric softener will be dispensed during the last rinse cycle.

Carefully close dispenser door. Do not allow softener to spill into other compartments.

### *To Clean the Dispenser*









Pour hot water into the dispenser drawer, making sure it flushes through each compartment. Use a small brush to thoroughly clean out any residue.



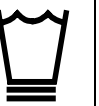







# Clothing Care











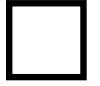



## Clothing Care Labels

The symbols below appear on many clothing care labels. Following the instructions on each label will help ensure the best laundry results.

WASH			
<b>Machine Wash Cycle</b>  Normal  Permanent Press/Wrinkle Resistant  Gentle/Delicate			<b>Warning Signs</b>  Hand wash  Do not wash
<b>Water Temperature</b>  Hot  Warm  Cold			 Do not wring

BLEACH	
<b>Bleach Symbols</b>  Any bleach (when needed)  Only non-chlorine bleach (when needed)	<b>Warning Signs</b>  Do not bleach

IRON			
<b>Iron - Dry or Steam</b>			
 Iron  High  Medium  Low	<b>Warning Signs</b>  Do not iron  No steam		

DRY				
<b>Tumble Dry Cycle</b>  Dry  Normal  Permanent Press/Wrinkle Resistant  Gentle/Delicate				<b>Warning Signs</b>  Do not tumble dry  Do not dry (used with Do not wash)
<b>Heat Setting</b>  High  Medium  Low  No heat/Air				
<b>Special Instructions</b>  Line dry/Hang to dry  Drip dry  Dry flat  In the shade				

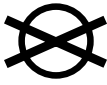
DRYCLEAN	
<b>Dryclean</b>  Dryclean	<b>Warning Signs</b>  Do not Dryclean

# Washing Special Items

**NOTE: Always Follow Manufacturer's Care Label Instructions.**

Bedding	<ul style="list-style-type: none"> <li>• Warm wash and warm rinse.</li> <li>• Use PERMANENT PRESS cycle.</li> <li>• Pretreat heavily soiled areas before washing.</li> <li>• When washing an electric blanket, protect the plug by stitching the edge of the blanket over the plug. Only dry in dryer if manufacturer says it can be done.</li> </ul>
Diapers	<ul style="list-style-type: none"> <li>• Rinse out diapers immediately in cold water and soak in a diaper pail with a small amount of detergent or enzyme presoak. Soak before washing.</li> <li>• Limit wash load to two dozen cloth diapers.</li> <li>• Use an all-purpose, low-sudsing detergent.</li> </ul>
Draperies, Curtains, Slip Covers	<ul style="list-style-type: none"> <li>• Shake to remove dust. Remove hooks and close zippers.</li> <li>• Sun-damaged draperies and curtains will not withstand washing.</li> <li>• Use warm water.</li> <li>• Wash curtains frequently. They can be weakened from soil, fumes, dust, and the sun.</li> <li>• Fiberglass curtains need gentle care. Read care label to see if washable. Some fiberglass curtains should be hand washed.</li> </ul>
Pillows (Feather and Down)	<ul style="list-style-type: none"> <li>• Do not wash pillows unless they can be dried in dryer. They may mildew if not dried completely.</li> <li>• Use warm wash, cold rinse and low-sudsing detergent.</li> </ul>
Rugs	<ul style="list-style-type: none"> <li>• Shake before washing. Do not use hot water on rubber-backed rugs.</li> <li>• Wash two or three rugs to balance the washer.</li> </ul>
Slips and Nightgowns	<ul style="list-style-type: none"> <li>• Wash often using all-purpose detergent, warm or hot water and cold rinse on the PERMANENT PRESS cycle.</li> <li>• To keep nylons and polyesters white, wash only with whites and use chlorine bleach occasionally.</li> <li>• Use fabric softener to remove static electricity.</li> </ul>
Shoes	<ul style="list-style-type: none"> <li>• Most shoes made of cloth and rubber can be washed.</li> <li>• Use the REGULAR cycle and warm water.</li> <li>• Wash with towels to balance the load.</li> </ul>
Small Items	<ul style="list-style-type: none"> <li>• Wash small items such as baby socks in a mesh garment bag.</li> </ul>
Cotton Knits	<ul style="list-style-type: none"> <li>• Unless the label indicates it is preshrunk, cotton knits will probably shrink to some degree.</li> <li>• Wash water should be hot or warm, suitable for color and soil.</li> <li>• Rinse water should be cold.</li> </ul>
Rayon Knits	<ul style="list-style-type: none"> <li>• Rayon stretches and shrinks easily. Treat as a delicate fabric and wash gently.</li> </ul>
Synthetic Fiber Knits	<ul style="list-style-type: none"> <li>• These items will generally keep their shape.</li> <li>• Make sure trimmings (including belts) are machine washable, seams are not puckered, and zippers and trimmings are well fastened.</li> </ul>
Knits of Manufactured Fibers	<ul style="list-style-type: none"> <li>• Use PERMANENT PRESS cycle.</li> <li>• Wash water should be warm, or suitable for color and soil.</li> <li>• Rinse water should be cold.</li> <li>• Do not wash with lint-shedding fabrics.</li> </ul>

continued

Sweaters of Manufactured Fibers	<ul style="list-style-type: none"> <li>• Follow directions for comparable knits.</li> <li>• Button sweaters and turn inside out.</li> <li>• Stretch to shape after washing.</li> <li>• Avoid pulling when wet.</li> </ul>
Wool Items	<ul style="list-style-type: none"> <li>• Unless labeled “machine washable,” wash by hand.</li> </ul>
Permanent Press	<ul style="list-style-type: none"> <li>• Wash often. Permanent press clothes tend to look clean even when they should be washed.</li> <li>• Do not wash with lint-shedding loads.</li> <li>• Pretreat grease stains and oily areas.</li> <li>• Use the PERMANENT PRESS cycle, hot or warm water, cold rinse and recommended amount of low-sudsing detergent.</li> <li>• Use fabric softener in the dispenser drawer. This will reduce the static electricity which attracts lint and makes garments cling.</li> </ul>

**NOTE: We do not recommend starching in this washer.**

## Clothing Concerns

To keep clothes looking white or bright, use good washing practices at all times to prevent a gradual build-up of soil or water hardness minerals on them. If you notice that your clothes are not as bright as they should be, take corrective measures immediately.

Problem	Cause	Solution
Gray or Dingy Clothes	Insufficient Detergent	Add recommended amount of low-sudsing detergent to dispenser drawer before loading clothes. Mild detergents are not suitable for average soil.
	Improper Sorting	Wash whites separately. Separate light from heavily soiled items. Clothes can pick up soil from dirty wash water.
	Water Not Hot Enough	White clothes will stay whiter with hot wash water. Increase temperature.
Yellowed Clothes	Unremoved Soil	Skin soil is hard to remove. Check hem edge of sheets and pillowcases, bottom end of t-shirts, etc. If this portion is white and center is yellow, the fabric contains unremoved soil. Use sufficient detergent and a hot wash. Chlorine bleach or powered bleach may be needed.
	Clothes Stained from Iron in the Water	To test for an iron stain, use a rust remover that is recommended for use with washing machines on a portion of the garment. Follow bottle directions for larger items.
	Older Clothes	Some white fabrics turn yellow with age and cannot be whitened.
Clothes Tearing or Damaged	Improper Use of Chlorine Bleach	No correction for bleach damaged clothes. Always keep level at or below maximum in bleach dispenser compartment.
	Insufficient Pre-care	Fasten all hooks and zippers. Mend tears. Remove objects from pockets.
Excessive Lint	Improper Sorting	Fabrics that shed lint cannot be washed with fabrics that receive lint.
	Insufficient Detergent	Use enough detergent so lint remains suspended in water and flushed out. Do not oversuds the water.
	Mixing Fabric Types	Knits and permanent press attract lint. Wash these only with similar items. Use fabric softener in dispenser drawer.
Wrinkling	Improper Sorting	Heavy items like towels should not be washed with light items like nightgowns.
	Improper Cycle	Make sure cycle selected is appropriate for type of clothes.
	Improper Temperature	Using a warm or cold wash and a cold rinse reduces wrinkling.

# Laundry Products

Laundry Aids	Use	Comments
Soak/Pretreat Products	<ul style="list-style-type: none"> <li>• Use a pretreating agent and soak overnight to remove stains and soils.</li> <li>• Always follow manufacturer's instructions with any pretreat product (Spray 'N Wash, Shout*, etc.).</li> </ul>	<ul style="list-style-type: none"> <li>• Do not use a pretreating agent with chlorine bleach.</li> <li>• Do not use pretreaters around the washer or dryer control panel. They may harm the finish or panel markings.</li> </ul>
Detergents/Soaps	<ul style="list-style-type: none"> <li>• Use low-sudsing, high efficiency (HE) detergent (recommended for frontload washers) in your washer.</li> <li>• When using detergents made for topload washers, use 1/2 of the recommended amount to prevent oversudsing. Using these detergents may decrease cleaning performance.</li> </ul>	<ul style="list-style-type: none"> <li>• Soap and powered detergent will not give good washing results in hard water. Soap in hard water will form sticky deposits.</li> <li>• We do not recommend the use of powered soap when washing in cold water.</li> </ul>
Bleaches	<ul style="list-style-type: none"> <li>• Use to remove certain stains, disinfect, and keep clothes white.</li> <li>• Do not use powered bleach in the bleach dispenser compartments. Powdered bleach can be used in the detergent compartment only.</li> <li>• Use liquid bleach in the proper dispenser compartment only. Do not add bleach to the wash load.</li> <li>• Follow directions on care label of garment.</li> <li>• Do not use bleach as a substitute for detergent.</li> </ul>	<ul style="list-style-type: none"> <li>• Always measure the bleach. Never exceed maximum level on bleach dispenser.</li> <li>• Never use chlorine bleach and ammonia in the same wash cycle.</li> <li>• Add powdered bleach along with the detergent.</li> </ul>
Bleach Alternatives	<ul style="list-style-type: none"> <li>• In some cases, mild bleaching may be accomplished using white vinegar, hydrogen peroxide or lemon juice as a pretreater.</li> </ul>	<ul style="list-style-type: none"> <li>• Always test to be sure that the product will not damage fabric by applying to a small part of the fabric that is not easily seen.</li> </ul>
Fabric Softeners	<ul style="list-style-type: none"> <li>• Use to soften clothes and remove static electricity from permanent press knits and other fabrics of manufactured fibers.</li> <li>• Add to the fabric softener dispenser compartment. Follow bottle directions carefully.</li> </ul>	<ul style="list-style-type: none"> <li>• Do not add fabric softener directly to load. Use fabric softener dispenser.</li> <li>• Do not mix with detergent or bleach.</li> <li>• Do not fill past maximum level on dispenser compartment.</li> </ul>

\*Brand names are trademarks of their respective manufacturers.

## Stain Removal

- Many soils will not become stains if treated promptly. Older stains may be difficult or impossible to remove. Hot water will set some stains, particularly protein based stains. Use cold or warm water on these before washing in hot water.
- Always follow the instructions on the clothing care label and instructions on stain removal products.
- When removing a stain, treat the stain from the back of the fabric unless otherwise noted. This will force the stain off the surface instead of driving it through the fabric.
- If you are not sure if a treatment is safe for the fabric, test a small part of the fabric that is not easily seen to make sure it will not become damaged.

	<b>WARNING</b>
<p><b>Never put highly flammable substances like gasoline, kerosene, waxes, cooking oils, dry cleaning solvents, etc. into a washer or dryer. Never put articles that have been cleaned with such substances into a washer or dryer. Failure to comply with these warnings could result in a fire, explosion, and/or serious burns or death. All items with these substances on them should be thoroughly hand-washed with a detergent so that no trace of the flammable substances remains. The articles can then be machine washed and/or dried.</b></p> <p style="text-align: right;">W525</p> <p><b>Do not wash or dry items soiled with vegetable or cooking oils. Some oils may remain after washing and may cause the fabric to catch on fire by itself.</b></p> <p style="text-align: right;">W527</p>	

Stain	Treatment
Alcoholic Beverages	Rinse stain immediately with cold water or soak stain 30 minutes in cold water. Apply detergent or dishwashing liquid to any trace of stain while still wet. If safe for the fabric, wash in hot water using chlorine bleach.
Baby Food, Formula	Rinse with cold water. Soak with an enzyme soaking product. Rinse. Wash as usual. If stain remains, apply a pretreat product and wash again.
Blood	Treat stain immediately. Soak 30 minutes or more in cold water. Rub detergent into stain. If stain persists, place a small amount of household ammonia on the stain and rub again with detergent. If safe for fabric, wash in hot water and chlorine bleach if traces of the stain persist.
Candle Wax	Rub with ice and scrape off excess wax. Place stain between paper towels and press with warm iron. Then place stain face down on paper towels and sponge with rubbing alcohol, if safe for fabric (refer to WARNING above). Let dry, wash. If traces of color remain, wash with commercial color remover (Rit, Putnam,* etc.) or, if safe for the fabric, hot water and chlorine bleach.
Cheese	Rinse with cold water. Soak with an enzyme soaking product. If the stain remains, apply a pretreat product. Wash as usual.
Chewing Gum	Rub with ice and scrape off excess gum. Place face down on paper towels and sponge with a pretreat product.

continued

Stain	Treatment
Chocolate or Cocoa	Rinse with cold water. Rub detergent into stain and soak in cold water. If greasy stain remains, sponge face down on paper towels with a pretreat product. If traces of the stain remain, wash in hot water and chlorine bleach (if safe for fabric).
Coffee, Tea	Soak in cold water. Rub detergent into stain, rinse. If traces of the stain remain, use a pretreat product and wash in warm water, or wash in hot water with chlorine bleach (if safe for fabric).
Copier Toner	Shake off loose powder. Brush stain with toothbrush to remove remaining powder. Sponge stain with soapy water. If stain remains, apply a pretreat product and wash in hot water (if safe for fabric).
Crayon	Treat the same as candle wax or place face down on paper towel and spray with WD-40*. Rinse. Wash in hot water (if safe for fabric) using soap (not a detergent) and 1-2 cups baking soda. If stains remain, professional drycleaning may be necessary.
Deodorants and Anti-Perspirants	Some of these products contain substances that can change the color of some dyes. The color can sometimes be restored if the area is sponged with ammonia then rinsed. To remove stains, apply white vinegar. Rub and rinse. If stains remain, rub detergent into stain and wash with hot water and chlorine bleach (if safe for fabric).
Dye	Treat with a commercial dye remover (Rit, Putnam*) or, if safe for fabric, bleach with chlorine bleach.
Egg, Gravy	If dried, scrape off excess. Soak in cold water. Rub detergent into damp stain and, if safe for fabric, wash in hot water and chlorine bleach.
Eye and Face Make-up	Tap on the stain with a spoon to loosen it. Rub dampened stain with bar soap, dishwashing liquid or detergent. If stain remains, soak in water and detergent. Apply a pretreat product and wash as usual.
Fabric Softener	Dampen stain and rub with bar soap. Wash as usual.
Felt-Tip Marker	Rub detergent into damp stain. Apply a pretreat product. If safe for fabric, wash in hot water and chlorine bleach.
Fruit Juices	Soak in cold water. Wash in hot water with chlorine bleach (if safe for fabric).
Grass	Place face down on paper towel and sponge with rubbing alcohol (if safe for fabric). Rinse. Apply a pretreat product and wash. If stain remains, wash in hot water with chlorine bleach (if safe for fabric).
Grease, Oil	Place face down on paper towel and sponge with a pretreat product. Dampen stain with water and rub with bar soap or detergent. Wash in hot water (if safe for fabric).
Ink	Saturate the stain with hair spray or place the fabric face down on paper towel and sponge with rubbing alcohol (refer to WARNING on previous page). Rinse. If traces of the stain remain, rub detergent into the dampened stain and wash. Some inks may be impossible to remove.
Iodine	Rinse from the back side of the stain with cold water. Then soak in a commercial color remover (Rit, Putnam*, etc.) or rub in a paste of water and starch. Let stand for 15-30 minutes and wash.
Jam, Jelly	Scrape off excess. Rinse with cold water. Rub dampened stain with detergent. Apply a pretreat product and launder with an enzyme soaking product. If stain remains, sponge with a mild bleach, such as water and white vinegar mix (equal parts) and wash again.



<b>Stain</b>	<b>Treatment</b>
Ketchup, Tomato-Based Products	Scrape off excess. Soak in cold water 30 minutes. Rub detergent into the stain and, if safe for fabric, wash in hot water and chlorine bleach.
Lipstick	Rub dampened stain with bar soap and wash.
Lotion (Hand, Body, Suntan)	Scrape off excess. Blot stain with paper towel. Rub colorless hand dishwashing liquid into stain and let stand several minutes. Rinse. Apply a pretreat product and wash in hot water (if safe for fabric.)
Mildew	Treat promptly. Mildew damages fabric and sometimes cannot be removed. Wash with chlorine bleach. For items that cannot be washed with chlorine bleach, soak in an all-fabric bleach, then wash.
Milk and Milk Products	Soak in cold water. Wash in hot water and chlorine bleach (if safe for fabric). Apply a pretreat product, if a stain is noticeable. Rewash.
Mud	Let dry. Scrape off excess. Soak in solution of one quart warm water, half teaspoon liquid hand dishwashing detergent and one tablespoon vinegar for 15 minutes. Rinse. Wash in hot or warm water with enzyme product.
Mustard	Rinse with cold water. Rub dampened stain with bar soap. Apply a pretreat product. Wash in hot water and chlorine bleach (if safe for fabric).
Nail Polish	Place face down on paper towel. Sponge with nail polish remover (non-oily) until stain disappears. Wash. Do not use nail polish remover on Acetate or Arnel fabrics.
Paint	Water-based — Treat by rinsing fabric in cool water while stains are still wet. Wash. To soften dried paint, apply soapy water or an acrylic paint and varnish remover. Rinse and then wash. Oil-based — Pretreat with a solvent recommended on the paint container. If not available, use mineral spirits. Rinse. Pretreat with a stain remover or detergent. Rinse and wash. Be sure to thoroughly rinse to remove all solvents to prevent a possible explosion in washer.
Perspiration	Rub dampened stain with detergent. Wash in hot water and chlorine bleach (if safe for fabric). If the fabric is discolored, you can try to restore it by treating fresh stains with ammonia or old stains with vinegar.
Rust	Apply a mild bleach such as lemon juice or a commercial rust remover (Whink, Rit, RoVer*, etc.) Follow manufacturer's directions. Wash as usual.
Salad Dressing, Mayonnaise	Scrape off excess. Apply a pretreat product. Rub stain with an enzyme soaking product and wash with hot water (if safe for fabric). Do not leave washer unattended as remaining residue may cause fabric to catch on fire.
Scorching	Wash using hot water and chlorine bleach (if safe for fabric). Fabrics can be damaged by being scorched. If this has happened, you may not be able to remove the marks.
Shoe Polish	Rub dampened stain with detergent. Wash in hot water and chlorine bleach if safe for fabric.
Soft Drinks	Rinse stain with cold water immediately. Wash in warm water and chlorine bleach, if safe for fabric.
Soy Sauce	Rinse with cold water. Apply a pretreat product. Wash as usual.
Tobacco	Dampen stain and rub with bar soap. Rinse. If necessary, soak in an all-fabric bleach solution. If stain remains, wash with chlorine bleach (if safe for fabric).
Toothpaste	Scrape off excess. Blot stain with enzyme soaking product and cold water. Rinse. Wash as usual.

Stain	Treatment
Urine	Rinse with cold water. Soak with an enzyme soaking product. Wash in hot water with chlorine bleach (if safe for fabric). If the color of the fabric has changed, sponging the area with ammonia may restore the color.
Vomit	Soak in a solution of one quart warm water, half teaspoon liquid hand dishwashing detergent, and one tablespoon ammonia (if safe for fabric). Soak 15 minutes. Use sponge to loosen stain. Blot with toweling. Wash in hot water (if safe for fabric) with an enzyme product.
Wine	Treat immediately. Rinse with cold water or club soda. Rub dampened stain with detergent and let stand several minutes. Apply a pretreat product and wash.

\*Brand names are trademarks of their respective manufacturers.

# Maintenance

---

## Lubrication

- All moving parts are sealed in a permanent supply of lubricant or are equipped with oilless bearings. Additional lubrication will not be necessary.

## Cold Weather Care

- If the washer is delivered on a cold day (below freezing), or is stored in an unheated room or area during the cold months, do not attempt to operate it until the washer has had a chance to warm up.

## Care of Your Washer

- Use only a damp or sudsy cloth for cleaning the control panel. Some spray pretreat products may harm the finish on the control panel or damage the interior of the hood.
- Wipe the washer cabinet as needed. If detergent, bleach or other washing products are spilled on the cabinet, wipe immediately. Some products will cause permanent damage if spilled on the cabinet.
- Do not use scouring pads or abrasive cleansers.
- The wash drum and window will need no particular care although they may need rinsing or wiping after an unusual load has been washed.
- The outside of the door window can be cleaned with household window cleaner.

## Cleaning Glass Sealing Area

In order to assure that the door properly seals against water leaks, the following surfaces should be wiped off periodically:

- The outside perimeter of the door glass where the seal contacts the glass
- The front surface of the door seal lip
- Usually a mild soap solution will work. If there is an extreme build-up of minerals from a hard water supply, the surfaces may need to be cleaned with a lime removal chemical.

## Replacing Hoses

- Hoses and other natural parts deteriorate after extended use. Hoses may develop cracks, blisters or material wear from the temperature and constant high pressure they are subjected to.
- All hoses should be checked on a yearly basis for any visible signs of deterioration. Any hose showing the signs of deterioration listed above should be replaced immediately.
- All hoses should be replaced every five years.



## Filter Screens

Check the filter screens in the fill hoses for debris or damage annually. Clean or replace them if necessary.

If the washer is filling with water slower than normal, check the filter screens. Clean or replace them if necessary.

Order filter screen Part No. F270300 from the nearest authorized parts distributor.

## Vacations and Extended Non-Use

- To avoid possible property damage due to flooding, turn off the water supply to the washer whenever there will be an extended period of non-use.

## Reinstallation of Shipping Materials

To prevent damage while moving the unit, the shipping materials **MUST** be reinstalled.

- Disconnect washer from electrical supply.
- While supporting the front access panel, remove two screws from the bottom edge of the panel.
- Gently lower the panel to remove it from the washer.
- Place the shock sleeves on all four shock absorbers. Refer to the illustration below.
- Insert hooked end of shipping brace into the open slot of the motor mount.
- Attach the brace with the five bolts and washers. Refer to the illustration below.
- Reinstall front access panel.

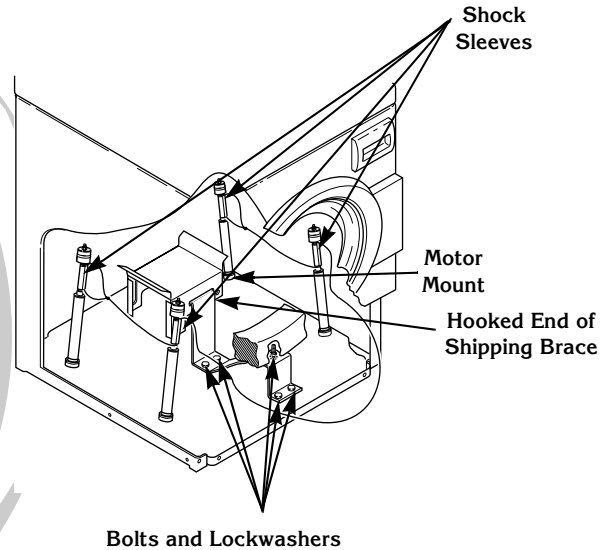

FLW2182N

Refer to the **INSTALLATION INSTRUCTIONS** for proper procedures whenever the washer is moved.

## Cleaning Foreign Object Trap

The washer's pump has a trap that may collect foreign objects. The trap may need to be cleaned if water is draining slower than usual. To clean:

- Disconnect washer from electrical supply.
- While supporting the front access panel, remove two screws from the bottom edge of the panel.
- Gently lower the panel to remove it from the washer.

**NOTE: The pump may have some water in it. Use a rag or a container to catch water. If the wash drum is full of water, use a wet/dry shop vacuum to catch the water.**

- With rag or vacuum ready, unscrew the cap on the left side of the pump and remove trap.
- Clean the debris from the trap.
- Reinstall the trap and access panel.
- Reconnect washer to electrical supply.

# Troubleshooting

Try these troubleshooting tips before making a service call. You may save time and money!

Washer Symptom	Possible Cause / Solution
Won't Fill	<ul style="list-style-type: none"> <li>• Make sure power cord is plugged all the way into the electrical outlet.</li> <li>• Make sure hot and cold water faucets are turned on.</li> <li>• Make sure that the fill hoses are not kinked or twisted.</li> <li>• Press and hold the start button for two seconds to start washer.</li> <li>• Make sure that the controls are properly set.</li> <li>• Make sure that the loading door is closed tightly.</li> <li>• Check the house fuse or circuit breaker.</li> <li>• Clean the screens in the water mixing valve and the filter screens located at the faucet end of the fill hoses. (Owner is responsible for service calls regarding cleaning of the screens.)</li> </ul>
Won't Start	<ul style="list-style-type: none"> <li>• Make sure loading door is closed tightly.</li> <li>• Press and hold start button for two seconds to start washer.</li> <li>• Make sure power cord is plugged all the way into the electrical outlet.</li> <li>• Make sure cycle selector knob is not set to the OFF position.</li> <li>• Check the house fuse or circuit breaker.</li> <li>• Make sure door latch is properly adjusted relative to door lock.</li> </ul>
Won't Spin/Tumble	<ul style="list-style-type: none"> <li>• Make sure loading door is closed tightly.</li> <li>• Press and hold the start button for two seconds to start washer.</li> <li>• Make sure power cord is plugged all the way into the electrical outlet.</li> <li>• Make sure controls are properly set.</li> <li>• Check the house fuse or circuit breaker.</li> <li>• Broken drive belt. Call the service person.</li> <li>• Foreign object trap in pump may be clogged. Clean the trap. Refer to Maintenance section.</li> </ul>
Stops/Pauses During Cycle	<ul style="list-style-type: none"> <li>• Pauses are part of the washer's normal operation.</li> <li>• Wash load may be unbalanced. Washer will stop and then restart spin automatically. If the washer is severely unbalanced, turn cycle selector knob to OFF and redistribute the load.</li> <li>• Check the house fuse or circuit breaker.</li> </ul>
Won't Drain	<ul style="list-style-type: none"> <li>• Make sure drain hose is not kinked or twisted.</li> <li>• Make sure drain hose is not clogged.</li> <li>• Make sure drain receptacle is not clogged.</li> <li>• Refer to the Installation Instructions to make sure that the drain hose has been properly installed.</li> <li>• Foreign object trap in pump may be clogged. Clean the trap. Refer to Maintenance section.</li> </ul>
Water Leaks	<ul style="list-style-type: none"> <li>• Check that fill hoses are properly installed on the faucets and the washer's water mixing valve.</li> <li>• Check the condition of the fill hoses. Replace fill hoses every five years.</li> <li>• Check the condition of the rubber door gasket for tears or holes.</li> <li>• Make sure drain receptacle is not clogged.</li> <li>• Check house plumbing.</li> <li>• Laundry load may be oversudsing or overloaded. Make sure you are using low-sudsing, high efficiency (HE) detergent and proper load sizes.</li> <li>• Make sure outside perimeter of the door glass where seal contacts glass is clean.</li> </ul>

continued

Washer Symptom	Possible Cause / Solution
Too Many Soap Suds	<ul style="list-style-type: none"> <li>• Laundry load may be oversudsing. Make sure you are using low sudsing, high efficiency (HE) detergent.</li> <li>• Make sure you are using the amount of detergent recommended on the detergent's label. If using detergents made for topload washers, use only 1/4 cup regular detergent (1/2 of the recommended amount).</li> <li>• Laundry load may be overloaded. Make sure you are using proper load sizes.</li> </ul>
Vibrates/Moves Slightly	<ul style="list-style-type: none"> <li>• Make sure washer is level. Uneven leveling can cause vibration.</li> <li>• Make sure washer is installed on a solid, sturdy and level floor. The washer should not be installed on carpeting, soft tile, a platform or other weakly supported structures.</li> <li>• Make sure rubber feet are installed on all four leveling legs.</li> </ul>
Is Noisy	<ul style="list-style-type: none"> <li>• Make sure washer is level. Uneven leveling can cause vibration.</li> <li>• Some sounds may be a part of normal operation for a frontload washer. Refer to <i>Common Washer Sounds</i> section.</li> </ul>
Load is too Wet	<ul style="list-style-type: none"> <li>• Wash load may be unbalanced. The washer may have limited the spin speed to prevent damage to the machine. Redistribute the load and run a RINSE &amp; SPIN cycle.</li> <li>• Load is too small. Add items to make full load.</li> </ul>
Wrong Water Temperature	<ul style="list-style-type: none"> <li>• Make sure that the controls are properly set.</li> <li>• Check fill hoses. Make sure hot faucet hose is connected to hot mixing valve (indicated with "H" on the valve bracket) and cold faucet is connected to cold mixing valve (indicated with "C" on the valve bracket).</li> <li>• Make sure house water heater is adjusted properly.</li> </ul>

## Contact Information

If service is required, contact the nearest Factory Authorized Service Center. To find the nearest service center, visit us online at [www.comlaundry.com](http://www.comlaundry.com).

If you are unable to locate an authorized service center or are unsatisfied with the service performed on your unit, contact:

**Alliance Laundry Systems**  
**Shepard Street**  
**P.O. Box 990**  
**Ripon, Wisconsin 54971-0990**  
**[www.comlaundry.com](http://www.comlaundry.com)**  
**Phone: (920)748-3121**

Date Purchased \_\_\_\_\_

Model Number \_\_\_\_\_

Serial Number \_\_\_\_\_

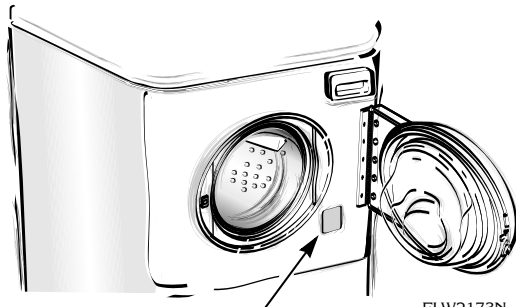

Model Number and  
Serial Number

FLW2173N

When contacting us about your washer, PLEASE GIVE THE MODEL AND SERIAL NUMBERS. The model and serial numbers are located on the nameplate. The nameplate will be in the location shown. Please include a copy of your bill of sale and any service receipts you have.

If replacement parts are required, contact the source from where you purchased your washer or visit us online at [www.comlaundry.com](http://www.comlaundry.com).



## WARNING

To reduce the risk of serious injury or death, **DO NOT** repair or replace any part of the washer or attempt any servicing unless specifically recommended in the user-maintenance instructions or in published user-repair instructions that you understand and have the skills to carry out.

W025E



## Free Manuals Download Website

<http://myh66.com>

<http://usermanuals.us>

<http://www.somanuals.com>

<http://www.4manuals.cc>

<http://www.manual-lib.com>

<http://www.404manual.com>

<http://www.luxmanual.com>

<http://aubethermostatmanual.com>

Golf course search by state

<http://golfingnear.com>

Email search by domain

<http://emailbydomain.com>

Auto manuals search

<http://auto.somanuals.com>

TV manuals search

<http://tv.somanuals.com>