

# AR700 Series Router Hardware Reference



AR725  
AR745  
AR750S  
AR750S-DP  
AR770S

AR700 Series Router Hardware Reference  
Document Number C613-03087-00 Rev E.

© 2005-2006 Allied Telesis Inc. All rights reserved. No part of this publication may be reproduced without prior written permission from Allied Telesis Inc.

Allied Telesis Inc. reserves the right to change specifications and other information in this document without prior written notice. The information provided herein is subject to change without notice. In no event shall Allied Telesis Inc. be liable for any incidental, special, indirect, or consequential damages whatsoever, including but not limited to lost profits, arising out of or related to this manual or the information contained herein, even if Allied Telesis Inc. has been advised of, known, or should have known, the possibility of such damages.

All company names, logos, and product designs that are trademarks or registered trademarks are the property of their respective owners.

# Contents

Introduction .....	4
Models Covered By This Reference .....	4
Where To Find More Information .....	4
AR700 Series Routers .....	5
AR725 Router .....	6
Hardware Features .....	6
Power Supply .....	7
AR725 LEDs and what they mean .....	10
AR745 Router .....	11
Hardware Features .....	11
Power Supply .....	13
AR745 LEDs and what they mean .....	15
AR750S Router .....	17
Hardware Features .....	17
Power Supply .....	18
AR750S LEDs and what they mean .....	19
AR750S-DP Router .....	20
Hardware Features .....	20
AT-PWR03 Power Supplies .....	21
AR750S-DP LEDs and what they mean .....	23
AR770S Router .....	24
Hardware Features .....	24
Power Supply .....	26
AR770S LEDs and what they mean .....	27
Online Documentation .....	28
To Access Documentation .....	28
AT-TFTP Server .....	29
Using Windows Terminal and Hyperterminal .....	30
Router Start-up .....	33
Memory .....	37
Random Access Memory (RAM) .....	37
Battery-Backed RAM (AR725, AR745, AR770S only) .....	39
Onboard Flash Memory .....	39
CompactFlash (AR725, AR745 only) .....	41
Expansion Options .....	43
AR740 RPS Redundant Power Supply (AT-AR725, AT-AR745 only) .....	43
SFP Ports (AR770S only) .....	46
PICs and NSMs .....	46
PCI Accelerator Cards (PACs) .....	47
Asynchronous Interfaces .....	50
Cables and Loopback Plugs .....	51
RS-232 Terminal and Modem Cables .....	51
Loopback Plugs for Testing Interfaces .....	56
Test Facility .....	58
Restricted Maintenance Procedures .....	60
Diagnostics .....	60
Lithium Battery Replacement .....	62
Contacting Us .....	62

## Introduction

---

This Hardware Reference describes the hardware features of AR700 Series router models, including information on PCI Accelerator Cards (PACs). Hardware and installation information for Port Interface Cards (PICs) and Network Service Modules (NSMs) can be found in their respective Quick Install Guides and Hardware References.

**Software and configuration** This hardware reference does not cover software configuration or software installation procedures. For information on software, refer to your router's *Software Reference*.

## Models Covered By This Reference

---

This Hardware Reference includes information on the following models:

- AR725 router
- AR745 router
- AR750S router
- AR750S-DP router
- AR770S router

Hardware Reference updates can be found at [www.alliedtelesis.com/support/software/](http://www.alliedtelesis.com/support/software/).

## Where To Find More Information

---

The Documentation and Tools CD-ROM bundled with each router contains the complete Document Set for your router and, where applicable, its expansion options. The CD-ROM also includes tools for managing your router. These documents can also be downloaded from the Support Site at [www.alliedtelesis.com/support/software/](http://www.alliedtelesis.com/support/software/).

The Document Set includes:

- The *Installation and Safety Guide* for your router, which provides safety and statutory information and outlines how to install the router.
- This *AR700 Series Router Hardware Reference* for your router, which provides detailed information on the hardware features of AR routers.
- The *AR700 Series Router Software Reference* for your router, which provides detailed information on configuring the router and its software.
- The *Port Interface Card Quick Install Guide*, which outlines the procedure for installing PICs
- The *Port Interface Card Hardware Reference*, which provides detailed information on PICs.
- The *Network Service Module Quick Install Guide*, which outlines the procedure for installing an NSM
- The *Network Service Module Hardware Reference*, which provides detailed information on NSMs.
- The *AR740 RPS Quick Install Guide*, which outlines the procedure for installing a redundant power supply for the AR725 and AR745 AC models.

- AT-TFTP Server for Windows, for downloading software versions.
- Adobe Acrobat Reader, for viewing online documentation.

## AR700 Series Routers

All AR700 Series routers include Ethernet ports, asynchronous ports, and PIC bays; the AR750S, AR750S-DP and AR770S also have switch ports. PIC bays add expansion flexibility by allowing the installation of PIC cards, which are available with additional interfaces, such as ISDN (PRI E1/T1, BRI S/T), synchronous, or asynchronous ports. The AT-AR745 routers also have an expansion bay to accommodate a *Network Service Module (NSM)*, which either directly provides further interfaces, or provides multiple slots where additional PIC interfaces can be added.

The AR725 and AR745 routers have a dedicated PCI Accelerator Card (PAC) slot that accommodates special purpose PAC coprocessor cards. PAC cards provide additional functionality or performance, such as compression or encryption, through a high performance PCI bus, but do not add extra interfaces. The AR750S and the AR750S-DP have built-in high performance encryption processing.

AR700 Series models are distinguished by the number and types of ports and presence or absence of an NSM bay and/or PCI Accelerator Card (PAC) slot.

Table 1: Interface configurations for AR700 Series routers

AR700 Series Model	Ethernet (Eth) Ports	Ethernet Switch Ports	Asynchronous Ports	PIC Bays	NSM Bays	PAC Slot
AT-AR725	2 (10/100)	-	2	2	-	1
AT-AR745	2 (10/100)	-	2	2	1	1
AT-AR750S	2 (10/100)	5 (10/100)	1	2	-	built in encryption
AT-AR750S-DP	2 (10/100)	5 (10/100)	1	2	-	built in encryption
AT-AR770S	2 (fibre-optic SFP or 10/100/1000)	4 (10/100/1000)	1	2	-	built in encryption

# AR725 Router

The AT-AR725 router consists of a base CPU card, enclosure and power supply. The base CPU card supports dual 10/100 autonegotiating Ethernet LAN (eth) ports and two asynchronous RS-232 ports.

Figure 1: Front and rear panels of the AR725 Series router

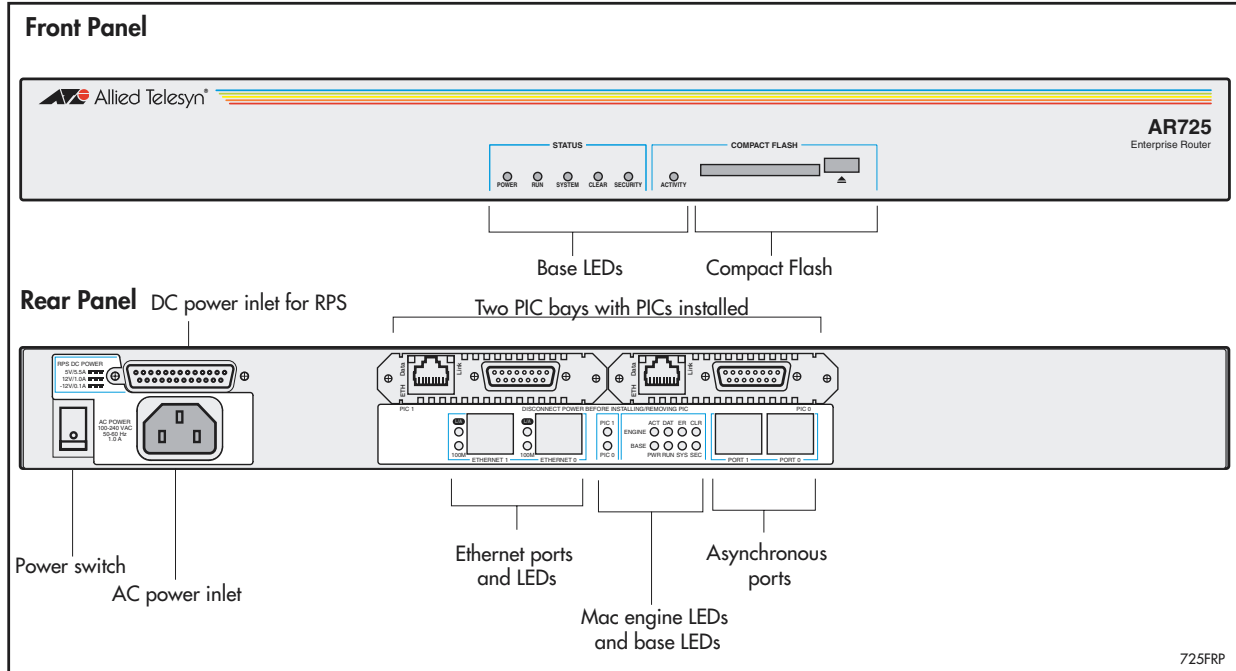

Figure 1 shows the AT-AR725 router's front and rear panels (with a PIC installed in each PIC bay). "AR725 LEDs and what they mean" on page 10 lists functions of the AT-AR725's LEDs. Additional rear panel LEDs may be present if PICs are installed. Functions of LEDs on PICs are described in the *Port Interface Card Quick Install Guide* and *Port Interface Card Hardware Reference*.

## Hardware Features

Main hardware features of the AT-AR725 are:

- 80 MHz RISC processor
- 1 MByte of EPROM
- 128 MBytes of synchronous DRAM (DIMM module)
- 16 MBytes of on-board flash memory
- CompactFlash slot
- 128 KBytes of battery backed SRAM
- 2 high performance autonegotiating full duplex 10/100 Fast Ethernet LAN ports
- 2 RS-232 asynchronous serial ports
- 2 PIC bays
- A PAC compression/encryption card slot
- Connector for a Redundant Power Supply (RPS)
- -48 V DC power supply option

**Asynchronous Ports** The two asynchronous serial ports can be used as general purpose ports for terminals, printers, or modems. They are effectively identical and can be independently configured. The default communications settings are:

- 9600 bps
- 8 data bits
- 1 stop bit
- No parity
- Hardware flow control

**PIC Bays** The chassis has two *Port Interface Card* (PIC) bays, which can accommodate any combination of the following PICs:

- AT-AR020 PRI E1/T1 PIC, one primary rate E1/T1 port
- AT-AR021(S) BRI-S/T PIC, one basic rate ISDN S/T port
- AT-AR021(U) BRI-U PIC, one basic rate ISDN U port
- AT-AR022 ETH PIC, one Ethernet LAN AUI/10BASE-T port
- AT-AR023 SYN PIC, one synchronous port with universal 50-way AMPLIMITE connector
- AT-AR024 ASYN4 PIC, four asynchronous ports with R-J45 connectors
- AT-AR026 4ETH PIC, four 10BASE-T/100BASE-TX ports with RJ-45 connectors
- AT-AR027 VoIP-FXS PIC, two Foreign Exchange Subscriber (FXS) ports with RJ-11 connectors

**CompactFlash slot** The AT-AR725 has a CompactFlash slot on its front panel. For information on CompactFlash, including a list of compatible flash cards, see [“CompactFlash \(AR725, AR745 only\)” on page 41](#).

**PAC slot** The AT-AR725 router has a single PAC slot inside the chassis. When installed, PACs provide hardware-based encryption and or compression capability via a PCI interface. For information on PACs, including a list of compatible PACs, see [“PCI Accelerator Cards \(PACs\)” on page 47](#).

## Power Supply

The AT-AR725 is available in two power supply configurations: a universal AC model and a 48V DC model. The AC model includes an inlet for the AR740 RPS (Redundant Power Supply). The AR740 RPS can be purchased separately, and each unit supports up to two AT-AR725 or AT-AR745 routers.

**AT-AR725 AC** AC models of the AT-AR725 have a universal AC input connector and a power switch on their rear panels. A DB25 connector for an optional external *Redundant Power Supply* (RPS), such as the AR740 RPS, is also located on the rear panel.

Pin outs for the DB25 RPS connector, and cable specifications for RPS supply cables, can be found in [“Redundant Power Supply \(RPS\)” on page 8](#).

The router can monitor the PSU and the fan in both the router and the RPS. See [“AR725 LEDs and what they mean” on page 10](#) for more information.

**AT-AR725-80 DC** The AT-AR725-80, designed for use by telecommunication carrier sites, supports connection to a 48V DC power supply (in the range 39 to 60 V DC). The DC model does not support an RPS connection, and does not support monitoring of the main PSU or fan.

DC supply cable specifications:

- Number of wires (cores): 3
- Minimum size: 2.1 mm<sup>2</sup> (14 AWG)
- Minimum cable rating: 600 V, 90 degrees Celsius

DC power supply specifications:

- 48 V DC (38 V to 60 V DC is acceptable)
- Either positive grounded or negative grounded

Figure 2: DC Power inlet terminals on an AR725

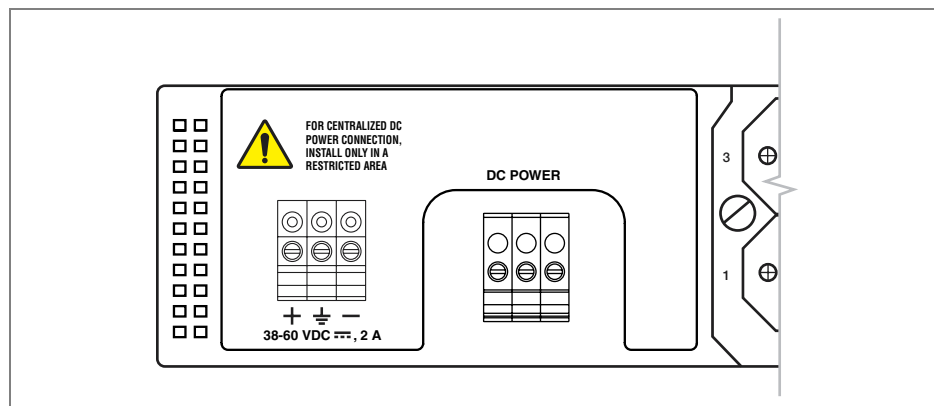

**Safety** Safety information and instructions outlining how to connect an AT-AR725-80 to a DC power supply can be found in the *AR700 Series Router Installation and Safety Guide*. You should read these instructions before attempting to connect the router to a DC power supply.



**Caution** Some interfaces that may be installed in the router are not transformer isolated. This means they will be referenced to the frame ground of the equipment and may be damaged if connected to an interface on another piece of equipment which is at a different ground potential.

### Redundant Power Supply (RPS)

AC models of the AT-AR725 can be used in conjunction with the AR740 RPS. Each AR740 RPS can provide power supply and mains circuit redundancy for up to two AT-AR725s or AT-AR745s. For more information on the AR740 RPS, see [“AR740 RPS Redundant Power Supply \(AT-AR725, AT-AR745 only\)”](#) on page 43.

For connection to an AR740 RPS, the AT-AR725 router has a female DB25 connector on its rear panel (Figure 3). Pin outs for the connector are listed in Table 2.



Figure 3: DB25 female connector pinout for an RPS on the AT-AR725 rear panel

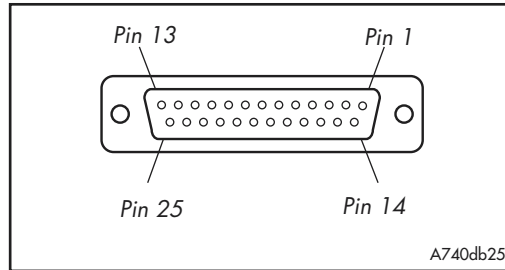

Table 2: DB25 RPS power connector pin out on the AT-AR725

Pin	Function	Direction
1, 25	Keying	-
2, 14	+12 V	input
3-5, 15-17	+5 V	input
6-8, 18-20	0 V	input
9	-12 V	input
10	VCC	output
11	Main PSU error	output
12	Main fan error	output
13	RPS disconnected	input
21	Sense 0 V	output
22	Sense +5 V	output
23	RPS PSU error	output
24	RPS fan error	input

## AR725 LEDs and what they mean

Functions of the AR725's LEDs are shown in the following table. Additional rear panel LEDs may be present if a PIC or NSM is installed. Functions of PIC and NSM LEDs are described in their respective Hardware References.

LED		Function
<b>Front panel</b>	<b>Rear panel</b>	
	<b>ETH</b>	These LEDs give indications about the Ethernet interfaces. There are two LEDs for each Eth port.
	L/A (Link/Activity)	Lit green when the Ethernet interface is connected to a device (e.g., a hub), which is generating link pulses. Blinks yellow when data is being transmitted or received on the Ethernet interface.
	100M	Lit when the Ethernet interface is in 100 Mbps mode.
	PIC0/PIC1	Lit when a PIC is inserted in either PIC bay 0 or PIC bay 1 (one LED for each PIC).
	<b>BASE</b>	These LEDs indicate the state of the main router unit.
Power	PWR	Lit when power is supplied and the router is switched on.
Run	RUN	Lit when the internal processor is executing code. If the processor stops for any reason (a fault condition), then the LED will not be lit.
System	SYS	This LED is not normally lit. It is used to signal various system conditions (e.g., when the processor executes the reboot sequence). Generally it signals a possible fault condition, but it is lit during a power-up or operator initiated reboot, and remains lit until a software version has been loaded from flash memory.
Security	SEC	Lit when a user is logged in with SECURITY OFFICER privilege and the router is in SECURITY MODE.
Activity (Compact Flash)		Lit when the compact flash card is accessed. <b>Do not remove the compact flash card when the LED is lit.</b>
	<b>ENGINE</b>	These LEDs give indications about PAC (PCI Accelerator Card), which can be installed for encryption and/or compression purposes.
	ACT	Lit when a PAC is installed in the PAC slot.
	DAT	Lit when data is transferred to or from the PAC.
	ERR	Lit when there is an error in the data transmission to or from the PAC.
Clear	CLR	Lit when a secure router has enabled PPP interfaces or Frame Relay circuits that are configured to send clear text.

## AR745 Router

The AT-AR745 router consists of a base CPU card, enclosure, and power supply. The base CPU card supports two 10/100 autonegotiating Ethernet LAN (eth) ports and two asynchronous RS-232 ports.

### Front and Rear Panels

Front and rear panels of the AT-AR745 router with a Port Interface Card (PIC) installed in each PIC bay, and an AT-AR040 4-PIC NSM installed in the NSM bay, are shown in the following figure.

Figure 4: Front and rear panels of the AT-AR745 router

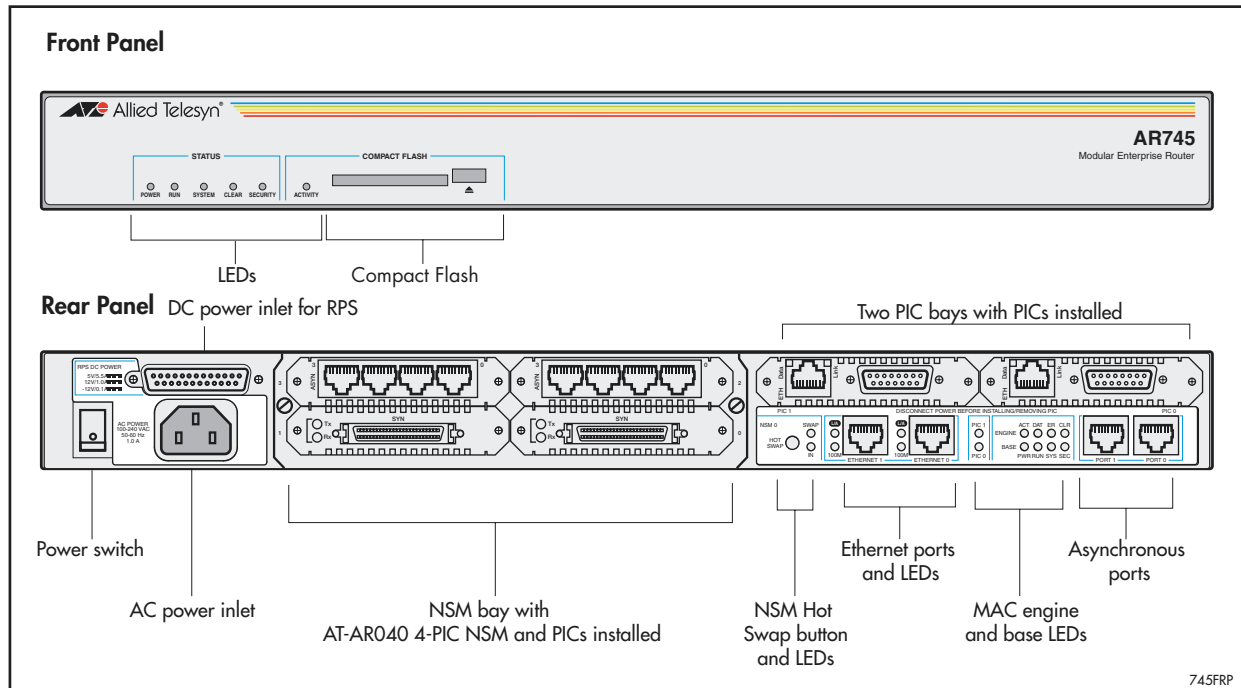

## Hardware Features

Main hardware features of the AT-AR745 are:

- 80 MHz RISC processor
- 1 MByte of EPROM
- 128 MBytes of synchronous DRAM (DIMM module)
- 16 MBytes of on-board flash memory
- CompactFlash slot
- 128 KBytes of battery-backed SRAM (NVS)
- 2 x 10/100 Mbps autonegotiating full-duplex Ethernet LAN (eth) ports
- 2 RS-232 asynchronous serial ports
- 2 PIC bays
- 1 hot swappable *Network Service Module* (NSM) bay
- 1 PAC slot for PAC compression and/or encryption cards
- Connector for a Redundant Power Supply (RPS)
- -48 V DC power supply option

**PIC bays and NSM bay** The AT-AR745 chassis has two PIC bays. A further four PIC bays can be added if an AT-AR040 NSM is installed in the NSM bay.

The NSM bay allows one NSM to be installed in the chassis. NSMs either have fixed ports (e.g., AT-AR041 and AT-AR042 BRI S/T NSMs) or PIC bays (e.g., the AT-AR040 4 PIC NSM). For detailed information on NSMs, see the *Network Service Module Hardware Reference*.

The PIC bays and the 4-PIC NSM can accommodate combinations of the following PICs (with a maximum of two E1/T1/PRI cards):

- AT-AR020 PRI E1/T1 PIC, one primary rate E1/T1 port
- AT-AR021(S) BRI-S/T PIC, one basic rate ISDN S/T port
- AT-AR021(U) BRI-U PIC, one basic rate ISDN U port
- AT-AR023 SYN PIC, one synchronous port with universal 50-way AMPLIMITE connector
- AT-AR024 ASYN4 PIC, four asynchronous ports with RJ-45 connectors
- AT-AR027 VoIP-FXS PIC, two Foreign Exchange Subscriber (FXS) ports with RJ-11 connectors

**Recommendation** AT-AR022 ETH PICs and AT-AR026 4ETH PICs are not recommended for use in NSM PIC bays, as performance of these interfaces is likely to be reduced and packet loss may occur. When used with an AR745 router, ETH PICs should be installed in the router's PIC bay 0 or PIC bay 1.

**Asynchronous Ports** The two asynchronous serial ports can be used as general purpose ports for terminals, printers or modems. They are effectively identical and can be independently configured. The default communications settings are:

- 9600 bps
- 8 data bits
- 1 stop bit
- no parity
- hardware flow control

**PAC Slot** AT-AR745 routers have a single PAC slot inside the chassis. When installed, PACs provide hardware-based encryption and or compression capability via a PCI interface. For information on PACs, including a list of compatible PACs, see "[PCI Accelerator Cards \(PACs\)](#)" on page 47.



**Caution** PACs should only be installed by authorised service personnel. Unauthorised opening of the router lid may cause danger of injury from electric shock, damage to the router, and invalidation of the product warranty.

## Power Supply

The AT-AR745 is available in two power supply configurations: a universal AC model and a 48 V DC model. The AC model includes an inlet for the AR740 RPS (Redundant Power Supply). The AR740 RPS can be purchased separately, and each unit supports up to two AT-AR745 or AT-AR725 routers.

**AT-AR745 AC** AC models of the AT-AR745 have a universal AC input connector and a power switch on their rear panels. A DB25 connector for an optional external *Redundant Power Supply (RPS)*, such as the AR740 RPS, is also located on the rear panel.

Pin outs for the DB25 RPS connector, and cable specifications for RPS supply cables, can be found in [“Redundant Power Supply \(RPS\)” on page 14](#).

The router can monitor the PSU and the fan in both the router and the RPS. See [“AR745 LEDs and what they mean” on page 15](#) for more information.

**AT-AR745-80 DC** The AT-AR745-80, designed for use by telecommunication carrier sites, supports connection to a 48 V DC power supply (in the range 39 V to 59 V DC). The DC model does not support an RPS connection, and does not support monitoring of the main PSU or fan.

DC supply cable specifications:

- Number of wires (cores): 3
- Minimum size: 2.1 mm<sup>2</sup> (14 AWG)
- Minimum cable rating: 600 V, 90 degrees Celsius

DC power supply specifications:

- 48 V DC (38 V to 60 V DC is acceptable)
- Either positive grounded or negative grounded

Figure 5: DC Power inlet terminals on an AR745

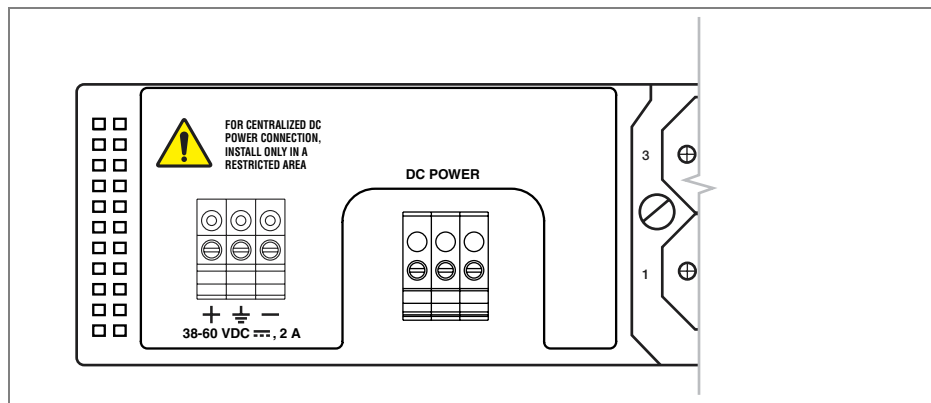

**Safety** Safety information and instructions outlining how to connect an AT-AR745-80 to a DC power supply can be found in the AR700 Series Router Installation and Safety Guide. You should read these instructions before attempting to connect the router to a DC power supply.



**Caution** Some interfaces that may be installed in the router are not transformer isolated. This means they will be referenced to the frame ground of the equipment and may be damaged if connected to an interface on another piece of equipment which is at a different ground potential.

## Redundant Power Supply (RPS)

AC models of the AT-AR745 can be used in conjunction with the AR740 RPS. Each AR740 RPS can provide power supply and mains circuit redundancy for up to two AT-AR745s or AT-AR725s. For more information on the AR740 RPS, see [“AR740 RPS Redundant Power Supply \(AT-AR725, AT-AR745 only\)”](#) on page 43.

For connection to an AR740 RPS, the AT-AR745 router has a female DB25 connector on its rear panel (Figure 6). Pin outs for the connector are listed in Table 3.

Figure 6: DB25 female connector pinout for an RPS on the AT-AR745 rear panel

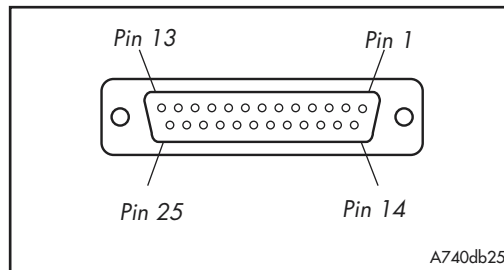

Table 3: DB25 RPS power connector pin out on the AT-AR745

Pin	Function	Direction
1, 25	Keying	-
2, 14	+12 V	input
3-5, 15-17	+5 V	input
6-8, 18-20	0 V	input
9	-12 V	input
10	VCC	output
11	Main PSU error	output
12	Main fan error	output
13	RPS disconnected	input
21	Sense 0 V	output
22	Sense +5 V	output
23	RPS PSU error	output
24	RPS fan error	input

## AR745 LEDs and what they mean

Functions of the AR745's LEDs are shown in the following table. Additional rear panel LEDs may be present if a PIC or NSM is installed. Functions of PIC and NSM LEDs are described in their respective Hardware References.

LED		Function
<b>Front panel</b>	<b>Rear panel</b>	
	<b>ETH</b>	These LEDs give indications about the Ethernet interfaces.
	LNK/ACT	Lit green when the Ethernet interface is connected to a device (e.g., a hub) which is generating link pulses. Lit yellow indicates transmission or reception activity.
	100M	Lit when the Ethernet interface is in 100 Mbps mode.
	PIC0/PIC1	Lit when a PIC is inserted in either PIC bay 0 or PIC bay 1 (one LED for each PIC).
	<b>BASE</b>	These LEDs indicate the state of the main router unit.
Power	PWR	Lit when power is supplied and the router is switched on.
Run	RUN	Lit when the internal processor is executing code. If the processor stops for any reason (a fault condition), then the LED will not be lit.
System	SYS	Lit when the router or management software is malfunctioning. Flashes to indicate fan, PSU, and RPS faults. 1 Flash: A router fan has failed. 2 Flashes: If an RPS is connected and RPS monitoring is enabled, an RPS fan has failed. 3 Flashes: If an RPS is connected, the router's PSU (Power Supply Unit) has failed. 4 Flashes: If RPS monitoring is enabled, the RPS PSU has failed. 5 Flashes: If RPS monitoring is enabled, an RPS is not connected or is not operational
Security	SEC	Lit when a user is logged in with SECURITY OFFICER privilege and the router is in SECURITY MODE.
Activity (Compact Flash)		Lit when the compact flash card is accessed. <b>Do not remove the compact flash card when the LED is lit.</b>
	<b>ENGINE</b>	These LEDs give indications about a PCI Accelerator Card (PAC), which can be installed for encryption and/or compression purposes.
	ACT	Lit when a PAC is installed in the PAC slot.
	DAT	Lit when data is transferred to or from the PAC.
	ERR	Lit when there is an error in the data transmission to or from the PAC.
Clear	CLR	Lit when a secure router has enabled PPP interfaces or Frame Relay circuits that are configured to send clear text.
	<b>NSM</b>	These LEDs give indications about an NSM installed in the router.
	Swap	Lit when the NSM and its PICs are powered down and can be hot swapped. Only lights if the Hot Swap button has been pressed and the software version supports hot swapping <sup>1</sup> .
	In Use	Lit when an NSM is correctly installed. If the software version supports hot swapping, it indicates that the NSM and its PICs are powered up and may not be swapped.

1. AT-AR021 (S) BRI-S/T, AT-AR021 (U) BRI-U, AT-AR022 ETH, AT-AR023 SYN, and AT-AR026 4ETH PICs can be hot swapped.

The AT-AR745 router automatically monitors its own power supply and fan, and has the option of a redundant power supply. If a redundant power supply (RPS) is attached, the AT-AR745 software can detect the presence of the RPS and the state of its output voltages and fan. RPS monitoring, turned off by default, can be turned on or off using the command:

```
set system rpsmonitor={on|off}
```

The **show system** command displays the state of the main power supply and fan, and whether or not the RPS is being monitored. If RPS monitoring is enabled, it also shows whether an RPS is connected, and the state of its output voltage and fan.

When a fault occurs in the main power supply or fan, system LEDs on the AT-AR745's front and back panels are flashed in a pattern that identifies the fault. If RPS monitoring is enabled, the system LEDs also flash to indicate failures in the RPS connection, power supply or fan. Multiple faults are indicated by cycling through each error code.



## AR750S Router

The AT-AR750S router has two 10/100 autonegotiating Ethernet (eth) ports, one asynchronous RS-232 port, five Ethernet switch ports, and two Port Interface Card (PIC) expansion bays.

Figure 7: Front and rear panels of the AT-AR750S router

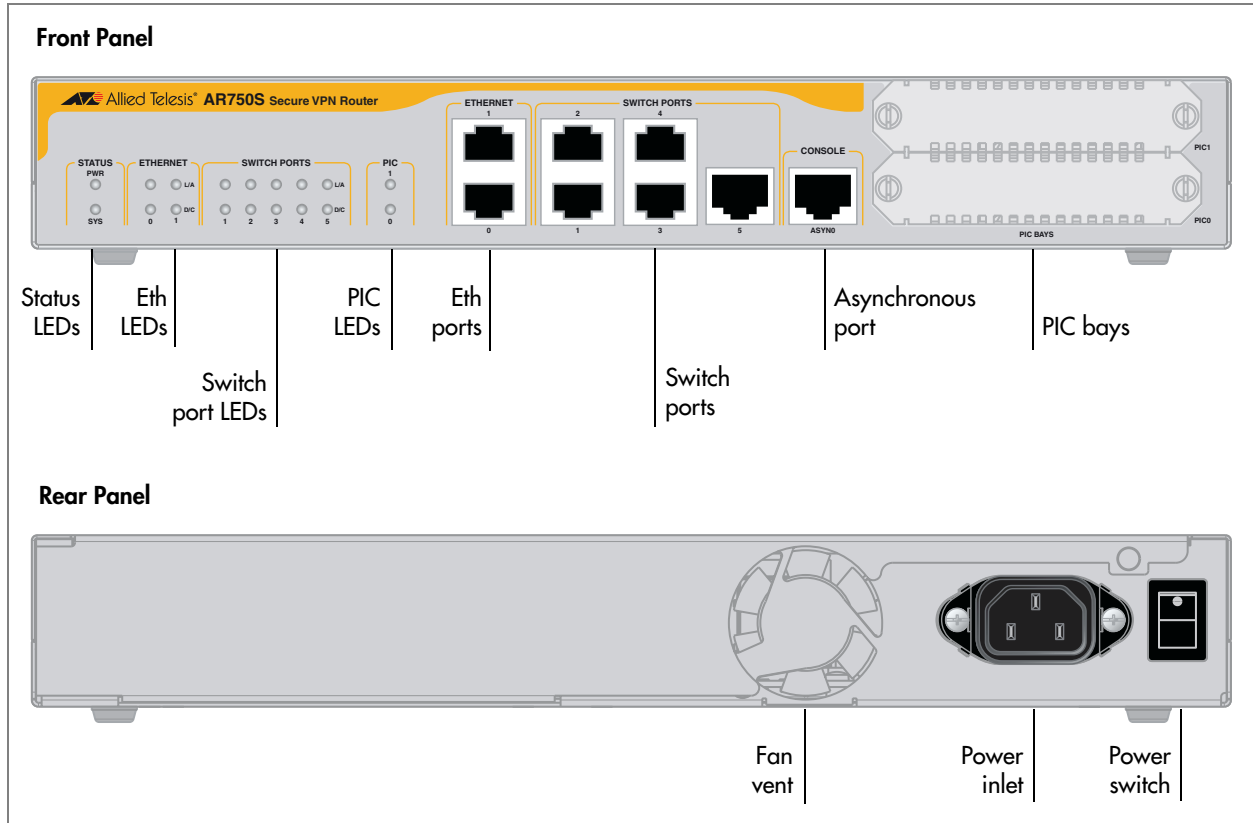

## Hardware Features

The main hardware features of the AT-AR750S are:

- 533 MHz PowerPC processor
- 64 MBytes of synchronous DRAM
- 16 MBytes of on-board flash memory, (1 MByte reserved for boot code)
- High performance security engine (used for IPSec, SSL, 3DES, AES)
- 2 x 10/100 Mbps autonegotiating full duplex Ethernet (eth) ports
- 5 x 10/100 Mbps autonegotiating full duplex switch ports
- 1 RS-232 asynchronous DTE console port, with RJ45 connector
- 2 PIC bays

**Asynchronous port** The asynchronous serial port (ASYN0) provides a general purpose port for terminals, printers or modems. The port is wired as a DTE ([Table 9 on page 50](#)). The default communications settings are:

- 9600 bps
- 8 data bits
- 1 stop bit
- no parity
- hardware flow control

**PIC bays** The AT-AR750S chassis has two PIC bays, which can accommodate combinations of the following PICs:

- AT-AR020 PRI E1/T1 PIC, one primary rate E1/T1 port.
- AT-AR021(S) BRI-S/T PIC, one basic rate ISDN S/T port.
- AT-AR023 SYN PIC, one synchronous port with universal 50-way AMPLIMITE connector.
- AT-AR024 ASYN4 PIC, four asynchronous ports with RJ-45 connectors.

## Power Supply

The AT-AR750S has a universal AC input connector and a power switch on its rear panel. It operates with an input voltage in the range 100 VAC to 240 VAC.

## AR750S LEDs and what they mean

Functions of the AR750S LEDs are shown in the following table. Additional LEDs may be present if a PIC is installed. Functions of PIC LEDs are described in the *Port Interface Card Hardware Reference*.

LED	State	Function
Power/PWR	Green	The router is receiving power and the power switch is ON.
System/SYS	Off	Normal operation.
	Amber	Lit briefly during router startup, or the router is malfunctioning.
	Flashing	There is a fault. To check the router's fan speed, temperature, and internal voltages, use the <b>show system</b> command.
	1 flash	The router fan has failed.
	3 flashes	There is an internal power supply fault in the router.
	6 flashes	The router temperature is too high or too low. Put the router in a location that will maintain an ambient temperature range of 0 °C to 50 °C (32 °F to 122 °F), with adequate airflow around the router and its vents.
PIC0 PIC1	Green	A port interface card (PIC) is correctly installed and has been detected by the router.
ETH0 / ETH1 L/A	Green	The Eth port has a 100 Mbps link.
	Amber	The Eth port has a 10 Mbps link.
	Flashing	Data is being transmitted on the Eth port.
ETH0 / ETH1 D/C	Green	The Eth port is operating at full duplex.
	Amber	The Eth port is operating at half duplex.
	Amber flashing	There is a collision on the Eth port.
PORT 1..5 L/A	Green	The switch port has a 100 Mbps link.
	Amber	The switch port has a 10 Mbps link.
	Flashing	Data is being transmitted on the switch port.
PORT 1..5 D/C	Green	The switch port is operating at full duplex.
	Amber	The switch port is operating at half duplex.
	Amber flashing	Collision on the switch port.

## AR750S-DP Router

The AT-AR750S-DP router has two 10/100 Mbps autonegotiating Ethernet (eth) ports, one asynchronous RS-232 port, five 10/100 Mbps Ethernet switch ports, and two Port Interface Card (PIC) expansion bays.

The AT-AR750S-DP uses AT-PWR03 dual hot-swappable power supplies (PSUs). You can install either AC or DC PSUs.

Figure 8: Front and rear panels of the AT-AR750S-DP router

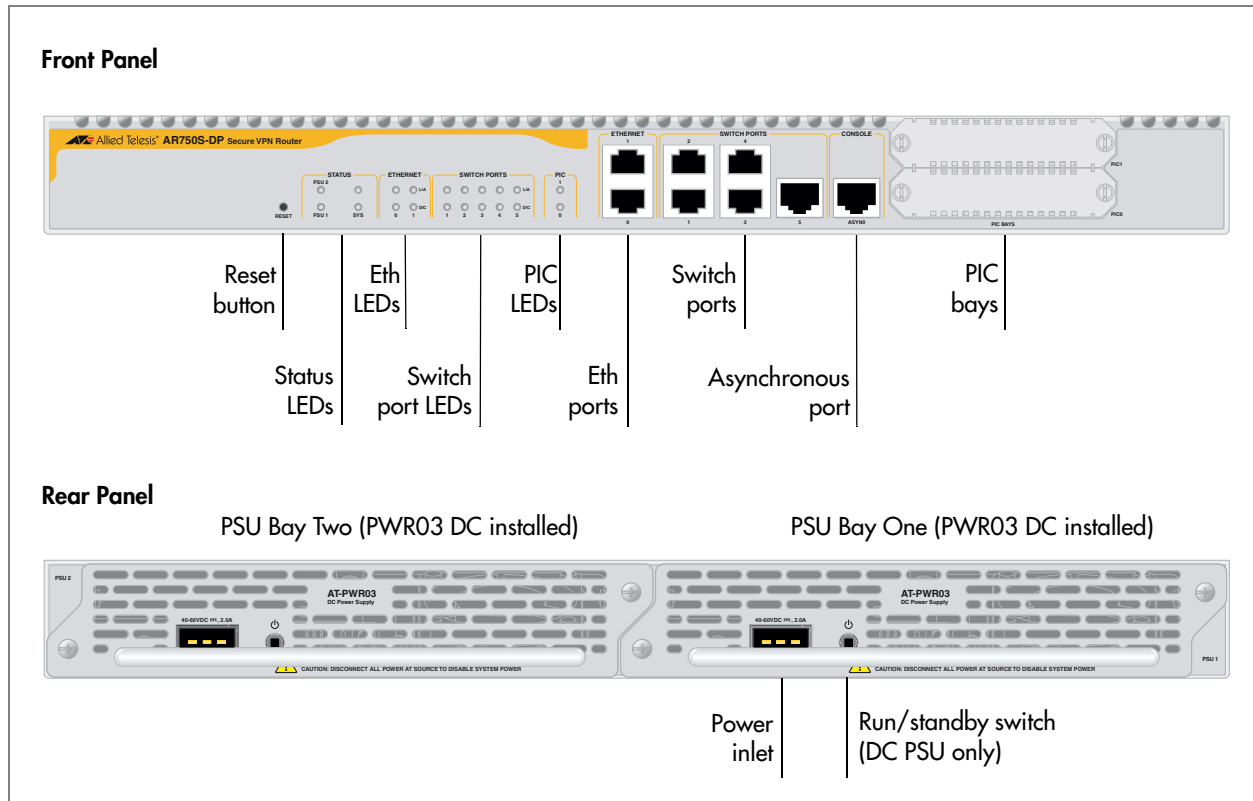

## Hardware Features

The main hardware features of the AT-AR750S-DP are:

- 533 MHz PowerPC processor
- 64 MBytes of synchronous DRAM
- 16 MBytes of on-board flash memory, (1 MByte reserved for boot code)
- 2 x 10/100 Mbps autonegotiating full duplex Ethernet (eth) ports
- 5 x 10/100 Mbps autonegotiating full duplex switch ports
- 1 RS-232 asynchronous DTE console port, with RJ45 connector
- 2 PIC bays
- High performance security engine (used for IPSec, SSL, 3DES, AES)
- 2 PSU bays compatible with dual hot-swappable, load sharing PSUs
- Reset button

**Asynchronous port** The asynchronous serial port (ASYN0) provides a general purpose port for terminals, printers or modems. The port is wired as a DTE (Table 9 on page 50). The default communications settings are:

- 9600 bps
- 8 data bits
- 1 stop bit
- no parity
- hardware flow control

**PIC bays** The AT-AR750S-DP chassis has two PIC bays, which can accommodate combinations of the following PICs:

- AT-AR020 PRI E1/T1 PIC, one primary rate E1/T1 port.
- AT-AR021(S) BRI-S/T PIC, one basic rate ISDN S/T port.
- AT-AR023 SYN PIC, one synchronous port with universal 50-way AMPLIMITE connector.
- AT-AR024 ASYN4 PIC, four asynchronous ports with RJ-45 connectors.

**Restart with default configuration** To restart the router with the default configuration, either press the Reset button on the front panel of the router, or use the command:

```
restart router config=none
```

This immediately restarts the router with the default configuration specified in the `boot.cfg` file. The factory-loaded default configuration is shown in the Installation and Safety Guide. If the file has been removed, the router restarts with no configuration. We recommend leaving `boot.cfg` unchanged, so that you can revert to the original configuration if necessary.

To return the router to the previous user configuration, restart the router by using the command:

```
restart router
```

This restarts the router with the startup configuration file previously specified by the command:

```
set config=filename
```

The **restart reboot** command or a power cycle also reload this user configuration. For information about configuration files, see the *Managing Configuration Files and Software Versions* chapter in the Software Reference.

## AT-PWR03 Power Supplies

The AR750S-DP comes with the option of installing one or two AT-PWR03 power supplies. When two are fitted, they must be the same type of current, either both AC or both DC.

The AR750S-DP should use only the AT-PWR03 power supply. Do not use any other power supply to power this router.

You can create triggers to execute scripts when specific PSU events occur. For more information, see the *Trigger Facility* chapter in the *AR700 Series Router Software Reference*.

**Safety** Safety information and instructions outlining how to use an AT-PWR03 AC or DC power supply can be found in the *AR750S-DP Router Installation and Safety Guide*. Read these instructions before attempting to install, remove or power an AT-PWR03.

**Hardware overview** The AT-PWR03 power supplies are hot-swappable and load share.

■ Dimensions:

- Height: 40.9 mm
- Width: 193 mm
- Depth: 130 mm

■ AC models:

- Universal 100 VAC to 240 VAC, 50 Hz to 60 Hz input
- Maximum continuous current draw: 1.6 A at 100 V, 1 A at 230 V
- Maximum inrush current (cold start at 25 °C/77 °F): 50 A at 240 V, 25 A at 115 V

■ DC models:

- 40 V to 60 V, 48 V nominal
- Supports either positive grounded or negative grounded operation
- Maximum continuous current draw: 2 A at 40 V
- Maximum standby current: 100 mA
- Run/standby switch

## AR750S-DP LEDs and what they mean

Functions of the AR750S-DP LEDs are shown in the following table. Additional LEDs may be present if a PIC is installed. Functions of PIC LEDs are described in the *Port Interface Card Hardware Reference*.

LED	State	Function
Status PSU 1..2	Green	The router is ON, and is receiving power from the PSU indicated by the LED.
	Amber	There is a fan or power fault.
Status/SYS	Off	Normal operation.
	Amber	Lit briefly during router startup, or if the router is malfunctioning.
	Flashing	There is a fault. To check the router's fan speed, temperature, and internal voltages, use the <b>show system</b> command.
	3 Flashes	There is an internal power supply fault in the router.
	6 Flashes	The router temperature is too high or too low.
	7 Flashes	The router has both an AC and a DC power supply connected to it. The router only supports dual power supplies when the PSUs have the same current type.
ETH0 / ETH1 L/A	Green	The Eth port has a 100 Mbps link.
	Amber	The Eth port has a 10 Mbps link.
	Flashing	Data is being transmitted or received on the Eth port.
ETH0 / ETH1 D/C	Green	The Eth port is operating at full duplex.
	Amber	The Eth port is operating at half duplex.
	Amber flashing	There is a collision on the Eth port.
PORT 1..5 L/A	Green	The switch port has a 100 Mbps link.
	Amber	The switch port has a 10 Mbps link.
	Flashing	Data is being transmitted or received on the switch port.
PORT 1..5 D/C	Green	The switch port is operating at full duplex.
	Amber	The switch port is operating at half duplex.
	Amber flashing	There is a collision on the switch port.
PIC0 PIC1	Green	A port interface card (PIC) is correctly installed and has been detected by the router.

## AR770S Router

The AT-AR770S Secure VPN Router provides gigabit Ethernet and switch ports, and can accommodate optional fibre-optic SFPs (small form-factor pluggable modules) and Port Interface Cards (PICs).

Figure 9: Front and rear panels of the AT-AR770S router

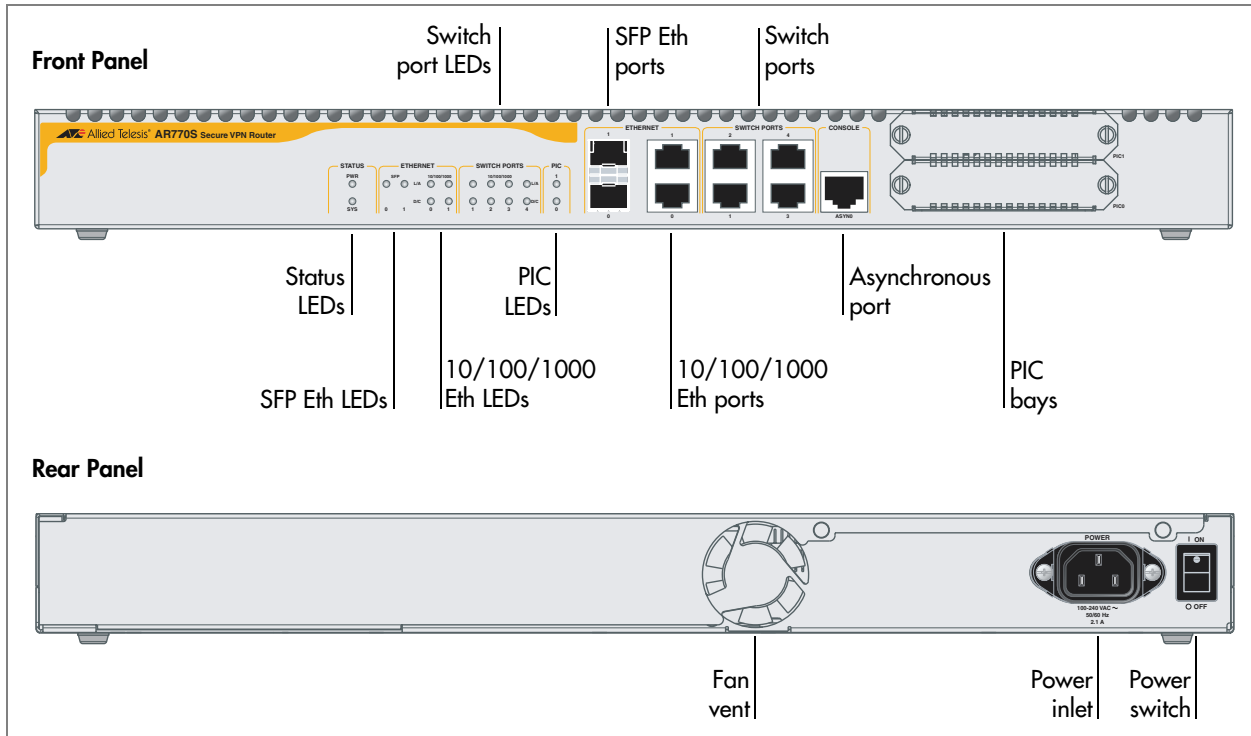

## Hardware Features

The main hardware features of the AT-AR770S are:

- 833 GHz PowerPC processor
- 128 MBytes of synchronous DRAM
- 512 kBytes of battery-backed SRAM (NVS)
- 32 MBytes of on-board flash memory, (1 MByte reserved for boot code)
- High performance security engine (used for IPSec, SSL, 3DES, AES)
- 2 autonegotiating full duplex Eth ports — each port may be either 10/100/1000 Base T, or SFP sockets for fibre-optic SFPs
- 4 autonegotiating 10/100/1000 Mbps full duplex switch ports
- 1 RS-232 asynchronous DTE console port, with RJ-45 connector
- 2 PIC bays



## Asynchronous port

The asynchronous serial port (ASYN0) is wired as a DTE ([Table 9 on page 50](#)), and can be used as general purpose port for terminals, printers or modems. The default communications settings are:

- 9600 bps
- 8 data bits
- 1 stop bit
- no parity
- hardware flow control

## Ethernet SFP sockets

The router has two eth interfaces (labelled Ethernet): eth0 (labelled 0) and eth1 (labelled 1). Each Eth interface has two connectors — an RJ-45 connector for a 10/100/1000 Mbps copper connection, and an SFP socket for a fibre-optic SFP. Only one of these can be operational at once. When an SFP transceiver is installed, the corresponding 10/100/1000 Eth port is disabled. When the SFP is removed, the RJ-45 port is again operational.

Figure 10: Eth1 SFP and 10/100/1000 options

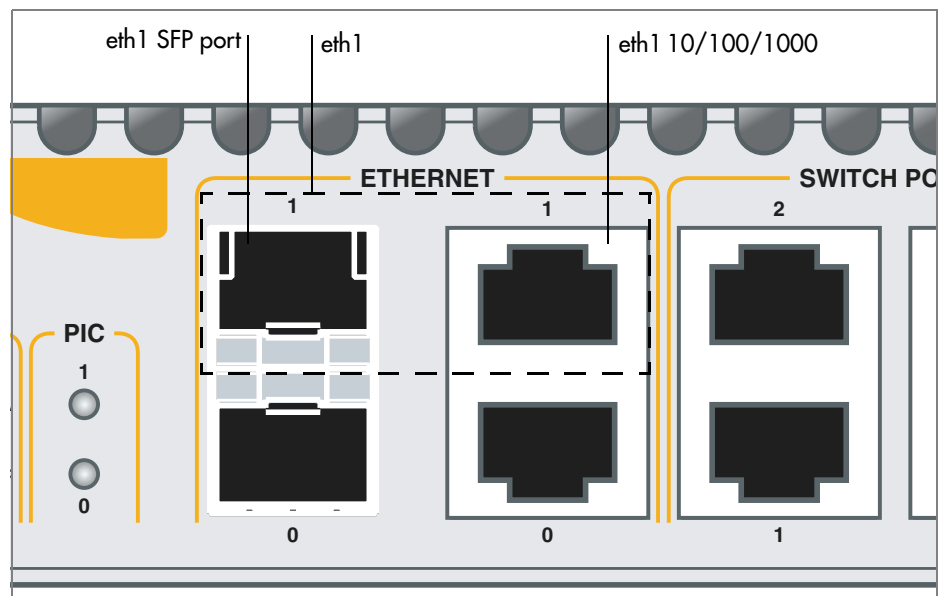

**Warning** Do not look into SFP cables or transceivers. Disconnected fibres or connectors may emit invisible laser radiation, which can damage eyes.

The Ethernet SFPs sockets support the following Small Form-factor Pluggable transceivers:

- AT-SPSX (previously AT-MG8SX)
- AT-SPLX10 (previously AT-MG8LX10)
- AT-SPZX80 (previously AT-MGZX)

For more information about SFP transceivers, see [“SFP Ports \(AR770S only\)” on page 46](#).

## PIC bays

The AT-AR770S chassis has two PIC bays, which can accommodate combinations of the following PICs:

- AT-AR020 PRI E1/T1 PIC, one primary rate E1/T1 port
- AT-AR021(S) BRI-S/T PIC, one basic rate ISDN S/T port
- AT-AR023 SYN PIC, one synchronous port with universal 50-way AMPLIMITE connector
- AT-AR024 ASYN4 PIC, four asynchronous ports with RJ-45 connectors

## Power Supply

The AT-AR770S has a universal AC input connector and a power switch on its rear panel. It operates with an input voltage in the range 100 VAC to 240 VAC.

## AR770S LEDs and what they mean

The following table shows the functions of the AR770S LEDs. Additional LEDs may be present if a PIC is installed. Functions of PIC LEDs are described in the *Port Interface Card Hardware Reference*.

LED	State	Function
Status PWR	Green	The router is receiving power and is switched ON.
Status SYS	Off	Normal operation.
	Amber	Lit briefly during router startup, or when the router system is malfunctioning.
	Flashing	There is a fault. To check the router's fan speed, temperature, and internal voltages, use the <b>show system</b> command.
	1 flash	The router fan has failed.
	3 flashes	There is an internal power supply fault in the router.
	6 flashes	The router temperature is too high or too low. Put the router in a location that will maintain an ambient temperature range of 0 °C to 50 °C (32 °F to 122 °F), with adequate airflow around the router and its vents.
Ethernet SFP 0..1 L/A	Green	The SFP Eth port has a 1000 Mbps link.
	Green flashing	Data is being transmitted or received.
	Amber	There is an SFP installed, but there is no link.
	Amber flashing	There is a transmission fault at this SFP port.
Ethernet 10/100/1000 0..1 L/A	Green	The Eth port has a 1000 Mbps link.
	Amber	The Eth port has a 10 or 100 Mbps link.
	Flashing	Data is being transmitted or received.
Ethernet 10/100/1000 0..1 D/C	Green	The Eth port is operating at full duplex.
	Amber	The Eth port is operating at half duplex.
	Amber flashing	There is a collision on the Eth port.
Switch Ports 10/100/1000 1..4 L/A	Green	The switch port has a 1000 Mbps link.
	Amber	The switch port has a 10 or 100 Mbps link.
	Flashing	Data is being transmitted or received
Switch Ports 10/100/1000 1..4 D/C	Green	The switch port is operating at full duplex.
	Amber	The switch port is operating at half duplex.
	Amber flashing	There is a collision.
PIC 0..1	Green	A port interface card (PIC) is correctly installed and has been detected by the router.

## Online Documentation

---

This section provides a step-by-step guide to accessing the documentation on the Documentation and Tools CD-ROM. Adobe Acrobat Reader must be installed to view the online documentation.

### To Access Documentation

To use the CD-ROM, follow these steps:

**1. Insert your router's Documentation and Tools CD-ROM in the CD-ROM drive.**

**2. If the CD browser menu does not appear.**

Select "Run" from the Start Menu (Windows 98, 2000 or Windows XP).

Type d:\start.exe (where d: is the CD-ROM drive letter) and click OK.

**3. To view a document.**

Click on the document title.

**4. To navigate around PDF documents.**

Use the toolbar buttons, keyboard shortcuts, or commands from the Document menu to page through the document.

Click on a bookmark, thumbnail or hypertext link to jump to a specific section or topic.

Use the Search command to search for keywords or phrases.

For more information about using the Adobe Acrobat Reader, select "Reader Guide" from the Help menu.

**5. To install any of the tools included on the CD-ROM.**

Click on a link in the CD browser menu.

## AT-TFTP Server

This section provides information on how to access and use AT-TFTP Server. AT-TFTP Server can be used to transfer configuration files as well as to download software patches and versions.

### To use AT-TFTP Server, follow these steps:

#### 1. If AT-TFTP Server has not yet been installed.

Install it now from the your router's Documentation and Tools CD-ROM.

To install AT-TFTP server:

Choose AT-TFTP Server from the Start > Programs > Allied Telesis > AT-TFTP Server menu.

#### 2. To set preferences for the AT-TFTP Server.

Select "Options" from the File menu to display the "Set Preferences" dialog box.

The "Default file transfer directory" field specifies the directory that AT-TFTP Server will read from or write to for file requests that do not include a directory specification.

To prevent unauthorised access to private directories, enter a path name in the "Restrict to directory" field. AT-TFTP Server will use only the specified directory, even if file requests contain references to other directories.

Select "Read only" to prevent files being written to the PC. To use the PC to archive router scripts created using the router's **create config** command, select "Read Write".

Make any required changes and click "OK".

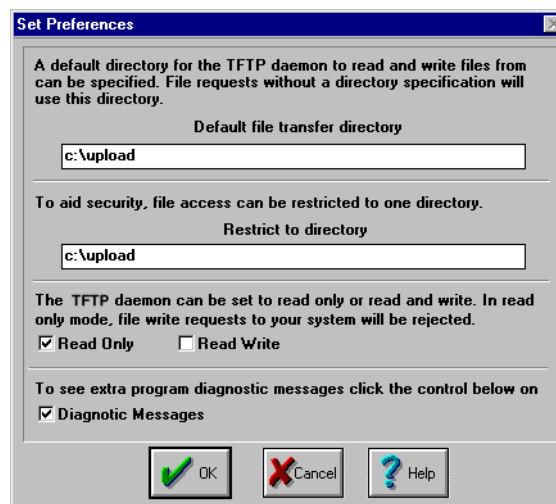

#### 3. To load a file from AT-TFTP Server to the router.

On a terminal connected to the router, type the command:

```
load method=tftp file=filename server=ipadd dest=flash
```

where *filename* is the name of the file to download and *ipadd* is the IP address of the PC running AT-TFTP Server.

#### 4. To save a TFTP Server log.

Select "Save As" from the File menu.

TFTP requests are logged to the AT-TFTP Server main window.

## Using Windows Terminal and Hyperterminal

You can use a PC running terminal emulation software as the manager console, instead of a terminal. There are many terminal emulation applications available for PCs, but the most readily available are the Terminal and HyperTerminal applications included in Microsoft Windows 98, 2000, and XP Professional. In standard Windows installations, HyperTerminal is available from the Communications submenu.

The key to successful use of terminal emulation software with the router is to configure the software and router with matching communications parameters. The following procedure can be applied to most terminal emulation programs. Dialog boxes in the procedure are from Windows 2000 and XP Professional.

### To configure Windows HyperTerminal for 2000 and XP Professional

1. Start the program in Windows by doing one of the following:
  - Select Programs > Accessories > Communications > HyperTerminal.
  - Double-click the Hypertrm.exe icon.
2. In the Connection Description dialog box:
  - Enter a name for the connection, such as Admin.
  - Select an icon from the scrollable list and click the OK button.



3. In the “Connect using” field on the Connect To dialog box, select the COM port on the PC used to connect to the router. and click the OK button.

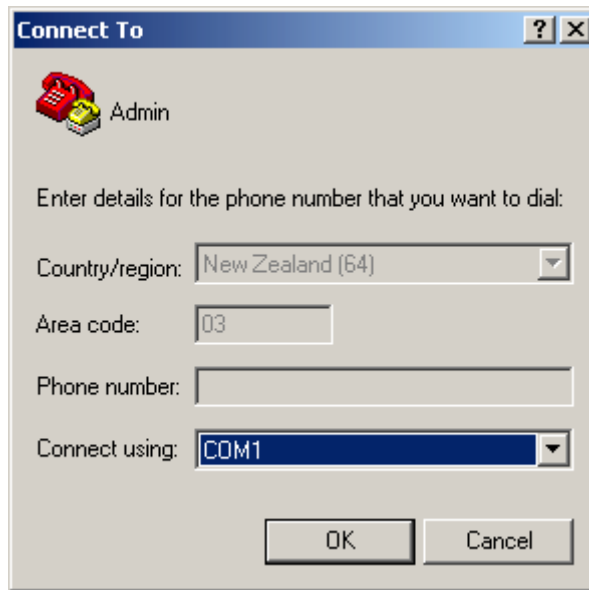

4. In the COM $n$  Properties dialog box, set port parameters as follows, and click the OK button.

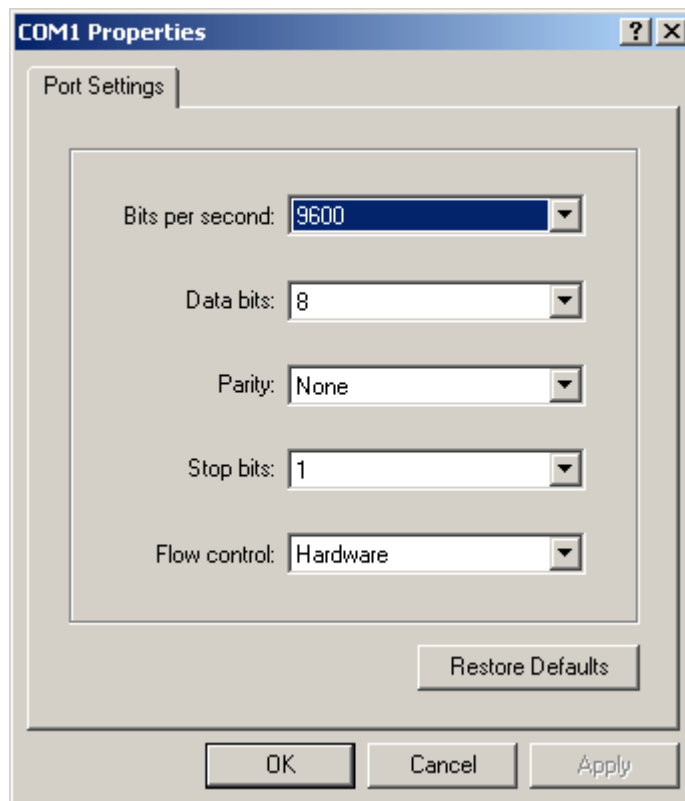

5. From the main HyperTerminal window, select Properties from the File menu. Click the Settings tab, and set the Properties dialog box as follows.

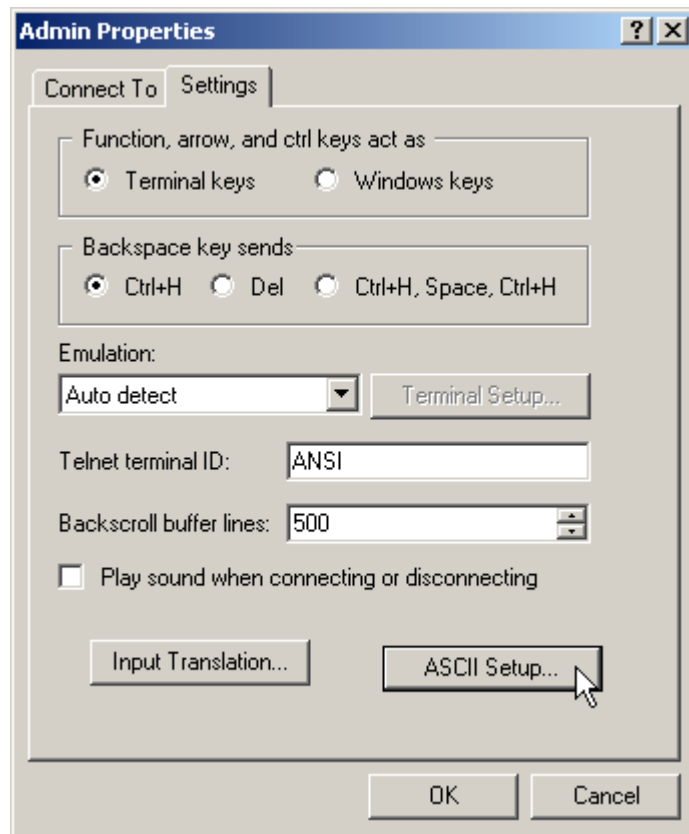

6. Click ASCII Setup to display the ASCII Setup dialog box, and ensure the following options are **not** selected:
- Echo typed characters locally
  - Append line feeds to incoming line ends

Set other parameters as necessary and click the OK buttons on both dialog boxes to close them.

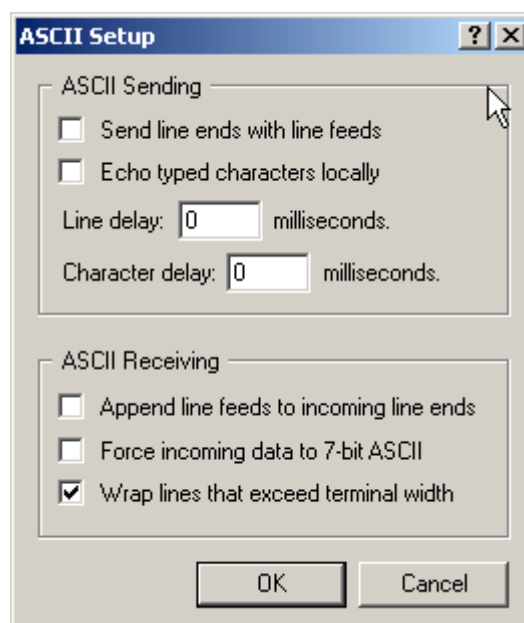



7. Save the current session by selecting Save from the File menu on the main HyperTerminal window. This creates a connection icon with the name you assigned in the HyperTerminal group.

To use the configuration, double-click the connection icon. When the HyperTerminal window appears, press the Enter key several times; the router's login prompt is then displayed.

## Router Start-up

---

At start-up, the manager can choose to run either the software version stored in the flash boot block, or the software version in the flash file system specified by the installation parameters previously set using the **set install** command.

All code is executed out of system RAM. At power-up the boot code is loaded from the flash boot block to RAM. The boot code checks the installation parameters then reloads RAM with the selected *temporary*, *preferred*, or *default* install version (stored in the flash file system) and runs this code.

The version is uncompressed as it loads to RAM. This may take 10 to 30 seconds. At this point, any required patches are loaded from the flash file system. Any patch is also uncompressed as it loads to RAM. This procedure ensures that the code runs at maximum speed, and allows updates to be made to the code. Updates can be downloaded over the network from a TFTP server and stored in the flash file system until required at power-up.

To download software onto the router, see the *Managing Configuration Files and Software Versions* chapter in the Software Reference.

All router software, patches, and configuration settings are stored as files in flash memory. Typically, the following files will be present in the flash file system:

- The current installed software version. Additional software versions may also be present.
- The current installed patch, if any. Additional patches may also be present.
- The command line help file for the command line interface (CLI). The command help is stored in a separate text file, with extension `.hlp`. The command help file is loaded with a software version.
- The boot configuration script `boot.cfg`. The boot script contains standard router commands (executed on start-up to configure the router).
- Additional user-defined configuration scripts containing commands to configure the router for different functions. These scripts are created using the built-in editor, the **add script** command (in the *Scripting* chapter of the Software Reference), or the **create config** command (in the *Managing Configuration Files and Software Versions* of the Software Reference).
- Other files required by the system.

Configuration information is stored in flash memory as configuration scripts. These scripts contain standard router commands. When a configuration command is entered at the command prompt from a terminal, terminal emulation program, or Telnet session, the command alters the dynamic configuration only; this is not saved over a power cycle. To ensure that configuration changes resulting from such commands are retained across a

power cycle, the dynamic configuration must be saved as a configuration script, using the **create config** command.

When the router starts up following either a power cycle or an operator-initiated reboot (using the **restart** command), it performs the following sequence of operations:

1. Perform start-up self tests.
2. Load the flash boot block version as the INSTALL boot into the router's RAM.
3. Prompt the manager for changes to the default start-up procedure:
 

```
Force EPROM download (Y)?
```

The manager may press one of the keys listed in [Table 4 on page 35](#) to override the default installation procedure.
4. Check the INSTALL information to determine which version to load and run, according to the INSTALL parameters, and the manager's response to the previous prompt. If none of the keys in [Table 4 on page 35](#) are pressed, the INSTALL parameters determine which version and patch are loaded and run.
5. Load the required version specified by the INSTALL parameters from the flash file system as the main boot.
6. Start the router.
7. Execute the boot configuration script, if one has been configured. (The boot configuration script is either a configuration file set using the **set config** command from the *Managing Configuration Files and Software Versions* chapter, or the file boot.cfg file, if there is one.)

A series of start-up messages is sent to asyn0 (the console or terminal port).

Figure 11: Example of router start-up messages on an AR750S

```
INFO: Self tests beginning.
INFO: RAM test beginning.
PASS: RAM test, 65536k bytes found.
INFO: Self tests complete
INFO: Downloading router software.
Force EPROM download (Y) ?
INFO: Initial download successful
INFO: Initialising Flash File System.
INFO: IGMP packet trapping is active for IGMP snooping, L3FILT
      is activated
INFO: Executing configuration script <flash:boot.cfg>
INFO: Router startup complete

login:
```

After the self tests are complete, the manager is given the option of forcing a mandatory boot from the flash boot block version. The following message is displayed on the terminal connected to the console port (asyn0) and the router pauses:

```
Force EPROM download (Y)?
```

If a key is not pressed within a few seconds, the start-up process continues and all steps in the start-up sequence are executed. Pressing selected keys on the terminal immediately after the "Force EPROM download" message is

displayed changes the router start-up process as described in the following table.

Table 4: Router start-up sequence keystrokes

Pressing key...	Forces the router to...
(no key pressed)	After a few seconds, the router startup process continues.
[Y]	Load the version, without any patches, from EPROM onto the RAM, and run the full version. Go to step 6.
[S]	Load and run the version and patch determined by the INSTALL parameters from the flash file system, ignoring any boot script or any previous configuration stored in NVS.
[N]	Load from flash to RAM the version and patch determined by the INSTALL parameters, and run using the current configuration stored in NVS (if any), ignoring any boot script.

During the start-up process the router generates four different types of messages. All messages are preceded by one of the words INFO, PASS, FAIL, or ERROR. The meaning of these words in the context of the messages is shown in the following table.

Table 5: Router start-up message classes

Message	Meaning
INFO	An informational message that an action has been taken by the system.
PASS	An informational message that a test has been completed successfully.
ERROR	An error message that a test has failed, but the system will continue to operate.
FAIL	An error message that a fatal error condition has caused the system to halt in an unrecoverable fashion.
WARNING	A serious error has occurred, which may indicate hardware failure.

The possible messages and their meanings are:

INFO: Self tests beginning.

The code loader tests are about to begin.

INFO: RAM test beginning.

The RAM tests are about to begin.

PASS: RAM test, 65536k bytes found.

The RAM test passed, and the indicated amount of memory was found and will be used in the router.

ERROR: RAM test 5. Error address = 00345678.

A RAM test failed, at the given address. In the example, it was the fifth test run. The RAM test repeats until it passes, so a number of messages like this may appear. This fault means that the memory system is faulty. If the fault continues, contact your distributor or reseller immediately.

INFO: BBR tests beginning.

The BBR tests are about to begin.

PASS: BBR test. Battery OK.

The BBR battery test passed.

ERROR: BBR Battery low.

The BBR battery test failed, indicating that the battery is running low. The BBR system will need to be replaced. Contact your distributor or reseller.

PASS: BBR test, 256k bytes found.

The BBR size/location test passed, with the indicated amount of BBR found.

FAIL: BBR test. Error address = 12345678.

The BBR size/location test failed at the given location. The test at this location failed, indicating the end of memory, but a valid location was discovered in the 255 long words following this location. The BBR system will need to be replaced. Contact your distributor or reseller.

FAIL: BBR test, only 16k bytes found.

The BBR size/location test completed, but only the displayed amount of memory was found. This amount is less than the minimum required to run the router software.

INFO: Self tests complete.

The start-up tests have finished.

INFO: Downloading router software.

The process of downloading the router software and vector table from ROM is about to begin.

ERROR: Code load retried.

FAIL: Code load failed.

The load of the code from ROM to RAM failed. The load is retried a number of times. Each time a failure occurs the ERROR message is displayed. If the maximum number of attempts is reached, the FAIL message is displayed.

ERROR: Vector load retried.

FAIL: Vector load failed.

The load of the vector table from ROM to RAM failed. The load is retried a number of times. Each time a failure occurs the ERROR message is displayed. If the maximum number of attempts is reached, the FAIL message is displayed. Contact your authorised distributor or reseller.

INFO: Initial download successful.

The start-up tests and download from ROM are complete, and the router software is about to be started. It takes a few seconds to decompress the software version.

INFO: Downloading compressed release. This may take up to 1 minute...

INFO: Loading software into memory. This may take up to 1 minute...

The main router software is about to be loaded into RAM. If the version is a compressed version, the version will be decompressed.

FAIL: Unexpected exception. Offset = 40, Addr = 0100045e.

An unexpected exception occurred while the start-up was executing. The vector offset and the program counter when the exception occurred are given in the message. Contact your distributor or reseller.

INFO: Executing configuration script <script-name>

The configuration commands stored in <script-name> are being executed. If an error is found in the script, one or more ERROR messages will be displayed.

INFO: Router startup complete.

The start-up process is complete and the router is now operational.

INFO: Initialising Flash (This may take some time)  
The flash file system was found to be corrupt. The router is now re-initialising the flash device to a "good" state. The process will take at least 4 minutes, depending on the router.

INFO: IGMP Snooping is activated.  
IGMP snooping has been enabled.

INFO: IGMP packet trapping is active for IGMP snooping, L3FILT is activated  
IGMP snooping has been enabled.

WARNING: IGMP Snooping not active, failed to enable ports.  
The IGMP snooping could not be activated on the switch ports. This may indicate a hardware failure. Contact your authorised Allied Telesis distributor or reseller.

ERR: Error (3035012): Parameter "<keyword>" not recognised.

ERR: Error (3035012): Parameter "firewall" not recognised.  
The configuration file contains commands not recognised by the software version that is loaded. In the example above, the configuration file contains commands to configure a firewall, but the software does not include the firewall feature - it may be the minimal boot version.

## Memory

---

The routers have memory in the form of:

- [“Random Access Memory \(RAM\)” on page 37](#)
- [“Battery-Backed RAM \(AR725, AR745, AR770S only\)” on page 39](#)
- [“Onboard Flash Memory” on page 39](#)
- [“CompactFlash \(AR725, AR745 only\)” on page 41](#)

## Random Access Memory (RAM)

The routers use RAM to run software for router operations, and to store the router’s dynamic configuration.

The AR725 and AR745 routers have 128 MB of SDRAM on a DIMM and can be upgraded. Contact your authorised Allied Telesis distributor or reseller for upgrade options. Other supplier’s DIMMs are not approved, not supported, and may not function correctly.



**Warning** DIMMs should be installed by authorised service personnel only. Unauthorised opening of the router lid may cause danger of injury from electric shock, damage to the router, and invalidation of the product warranty.

The AR750S and AR750S-DP routers have 64 MB of DDR SDRAM, and cannot be upgraded.

The AR770S has 128 MB of DDR SDRAM, and cannot be upgraded.

To check the amount of RAM present in a router, use the command:

```
show system
```

This will produce a display like that shown in [Figure 12](#). The *DRAM* and *FLASH* fields show the amounts of DRAM and flash memory, respectively.

Figure 12: Example output from the **show system** command

```

Router System Status                               Time 10:59:39 Date 23-Mar-2006.
Board      ID Bay  Board Name                    Host Id Rev  Serial number
-----
Base       241    AT-AR750S                                0 M1-0  ATR00434
PIC        38  0  AT-AR023-00 PIC Sync                    0 M3-0  50200528
-----
Memory -   DRAM : 65536 kB   FLASH : 16384 kB
Chip Revisions -
<U123:4567> <U23:456>  <U23:5566>  <U098:765>
-----
SysDescription
Allied Telesis AR750S version 2.7.6-00 11-Mar-2006

SysContact
David Johns, ext 8331
SysLocation
Laboratory, First Floor, Head Office Building
SysName
LAB
SysDistName

SysUpTime
510 ( 00:00:05 )
Boot Image      : 55_276.fbr size 732308 10-Mar-2006
Software Version: 2.7.6-00 11-Mar-2006
Release Version : 2.7.6-00 11-Mar-2006
Patch Installed : NONE
Territory       : europe
Country         : none
Help File       : help.hlp

Main Fan        : On

Temperature     : 30 Celsius
Main Fan Speed  : 4500 RPM

Voltage Status ( Rail : Read )
 1.2V : 1.17V  2.5V : 2.54V  3.3V : 2.98V
 5.0V : 4.84V 12.0V : 11.78V

Battery voltage : 3.14V

Configuration
Boot configuration file: flash:boot.cfg (exists)
Current configuration: flash:boot.cfg

Security Mode   : Disabled

Warning (2048284): No patches found.

```

## Battery-Backed RAM (AR725, AR745, AR770S only)

The AR725 and AR745 have 128 kB of battery-backed SRAM as NVS (non-volatile storage), and the AR770S has 512 kB. The router can store files such as logs and configuration scripts in NVS over a power cycle.

## Onboard Flash Memory

Flash memory is a nonvolatile reprogrammable memory storage device for router software versions, allowing upgrades to be remotely loaded from any WAN or LAN port. Flash memory is also used to store other types of data such as patches, logs and configurations.

There are two types of flash—onboard flash (flash connected directly to the router's PCB and available on all routers), and CompactFlash (flash provided by removable compact flash cards). All the routers have onboard flash memory; AR725 and AR745 routers also have a slot for compact flash cards. ("[CompactFlash \(AR725, AR745 only\)](#)" on page 41)

Of the router's onboard flash memory, 1 MB is reserved for the flash boot version. You can use the rest to store files in the flash file system, such as a software version file, GUI resource file, configuration scripts and command line help file. The router also stores system files in the flash file system.

### Testing Onboard Flash Memory

There are several ways to check that onboard flash memory is installed and operating correctly. First, check that the router has recognised the flash memory, using the command:

```
show system
```

to display system information ([Figure 12 on page 38](#)). The second part of the display shows the types and sizes of memory installed in the router. If the flash memory size is lower than expected, then the router's boot process has not correctly detected or recognised the flash memory's presence. If recognition fails, contact your authorised Allied Telesis distributor or reseller.

If the flash is recognised, enter the command:

```
show flash physical
```

to display flash memory size, device type and location.

Figure 13: Example output from the **show flash physical** command for an AT-AR750S

```

total size ..... 16 MBytes
  available to FFS ... 15 MBytes
  available to boot .. 1 MBytes
device type ..... 28F128
devices ..... 1
location ..... built in
programming power ..... off
block erase time ..... 1000 milliseconds
total erase blocks .... 128
  FFS erase blocks ... 120
  Boot erase blocks .. 8
erase block size ..... 128 kBytes
erase bit state ..... 1
page buffers ..... 1
size of page buffer ... 32 bytes

Manager >

```

Lastly, the Flash File System (FFS) can be checked to ensure that it has successfully formatted the flash, using the command:

```
show file
```

If flash memory has been used in the past then it may already be formatted and contain files. With erased or new flash memory that has been correctly formatted, an 80 byte hidden system file is present. A typical display for an FFS is shown in [Figure 14](#).

Figure 14: Example output from the **show file** command for an AT-AR750S

Filename	Device	Size	Created	Locks
55-271a.rez	flash	3796816	11 Jan-2005 13:58:28	0
55-273.rez	flash	3798416	11-Jun-2005 16:50:45	0
config.ins	flash	32	13-Dec-2004 09:37:32	0
feature.lic	flash	39	01-Dec-2004 09:45:51	0
isdn.scp	flash	1575	09-Dec-2004 15:38:50	0
longname.lfn	flash	17	23-Dec-2004 10:59:34	0
boot.cfg	flash	2769	30-Nov-2004 11:36:03	0
ppp.cfg	flash	2819	01-Dec-2004 10:14:28	0
prefer.ins	flash	64	14-Dec-2004 16:25:47	0
random.rnd	flash	3904	21-Dec-2004 12:14:24	0
release.lic	flash	32	30-Nov-2004 11:26:54	0

A complete test of flash memory may also be carried out by authorised support personnel using the router's built-in diagnostics. See ["Diagnostics" on page 60](#) for more information.



**Caution** The diagnostics flash memory test erases the entire flash contents.



## CompactFlash (AR725, AR745 only)

AR725 and AR745 routers have a CompactFlash slot on their front panel. Compact flash cards increase the flash memory available for file storage.

CompactFlash files can be manipulated using the command line interface. Any type of data, including versions, patches, GUIs and configurations can be stored on compact flash cards. However, version, patch, and GUI files cannot be run directly from CompactFlash. These files must be loaded into either NVS or onboard Flash.



**Caution** Data contained on compact flash cards can be read with any compliant reader. Do not keep sensitive data, for example security keys, on compact flash cards.

The AT-CF128A 128 MB CompactFlash card has been approved for use with the AR725 and AR745 routers. For the latest approved compact flash cards, see the datasheet for your router at [www.alliedtelesis.com](http://www.alliedtelesis.com). Only use approved CompactFlash cards. Using other cards may result in data loss.

### Installing and removing a compact flash card

Compact flash cards can be inserted into the CompactFlash slot at any time. CLI messages are displayed when a card is inserted or removed. It takes approximately two seconds for an inserted card to be initialised. Messages notify the user when a card has been inserted:

```
Info (1106257): Compact flash card inserted.
```

and when the card is ready for use:

```
Info (1106268): Compact flash card initialisation successful.
```

A message notifies the user if the compact flash card is not compatible with the router:

```
Info (3106300): Compact flash card initialisation  
unsuccessful.
```

When CompactFlash is in use, the CompactFlash Activity LED on the front panel of the router is green.



**Caution** Do not remove the compact flash card when it is being written to (that is, when the CompactFlash Activity LED is lit). Doing so will corrupt data on the file being written.

### Testing CompactFlash

To display information about the basic state of a compact flash card, including card size, file count and serial number, insert the card and enter the command:

```
show cflash
```

To display cluster ranges on a card, insert the card and enter:

```
show cflash test
```

Figure 15: Sample output from the **show cflash test** command, when no test is running

```

Clusters available for testing
  Ranges:
    [42645--61944]
    Number of free clusters = 19300
    Number of ranges       = 1
    Number of used clusters = 42645

```

To test a card, insert the card and enter:

```
enable cflash test start=startnumber end=endnumber
```

where *startnumber* and *endnumber* are positive integers within a cluster range. The endnumber must be higher than the startnumber. Cluster ranges are displayed in the output of the **show cflash test** command (Figure 15).

The test software will read the file allocation table and display a list of free sectors. Sectors can be tested as single sectors or as a range. The test will consist of a write/read/verify cycle.

To stop the test, use the command:

```
disable cflash test
```

To display the testing process while a test is in process, enter:

```
show cflash test
```

Figure 16: Sample output from the **show cflash test** command, when a test is running

```

Test Progress
  Starting cluster      = 700
  Ending cluster       = 1700
  Current cluster      = 1185

  Passed clusters number = 485
  Passed sectors number  = 1940

  Failed clusters number = 0
  Failed sectors number  = 0
  Used Clusters encountered = 0

  Duration..... 4417 ms

```

If used when testing is not active, the previous command displays blank cluster ranges on a compact flash card (Figure 15 on page 42).

Error messages are displayed when a file write fails. Failure could be due to the card being removed or an error in the card.

## Expansion Options

Expansion options include:

- “AR740 RPS Redundant Power Supply (AT-AR725, AT-AR745 only)” on page 43
- “CompactFlash (AR725, AR745 only)” on page 41
- “SFP Ports (AR770S only)” on page 46
- “PICs and NSMs” on page 46
- “PCI Accelerator Cards (PACs)” on page 47

### AR740 RPS Redundant Power Supply (AT-AR725, AT-AR745 only)

Each AR740 RPS can provide power supply and mains circuit redundancy for up to two AC routers. The AR740 RPS cannot be used with DC versions of the routers. [Figure 17](#) shows the AR740 RPS front and rear panels.

Installation instructions for the AR740 RPS can be found in the *AR740 RPS Quick Install Guide*. This guide is packed with each AR740 RPS, or can be downloaded from [www.alliedtelesis.com/support/software/](http://www.alliedtelesis.com/support/software/).

Figure 17: Front and rear panels of the AR740 RPS

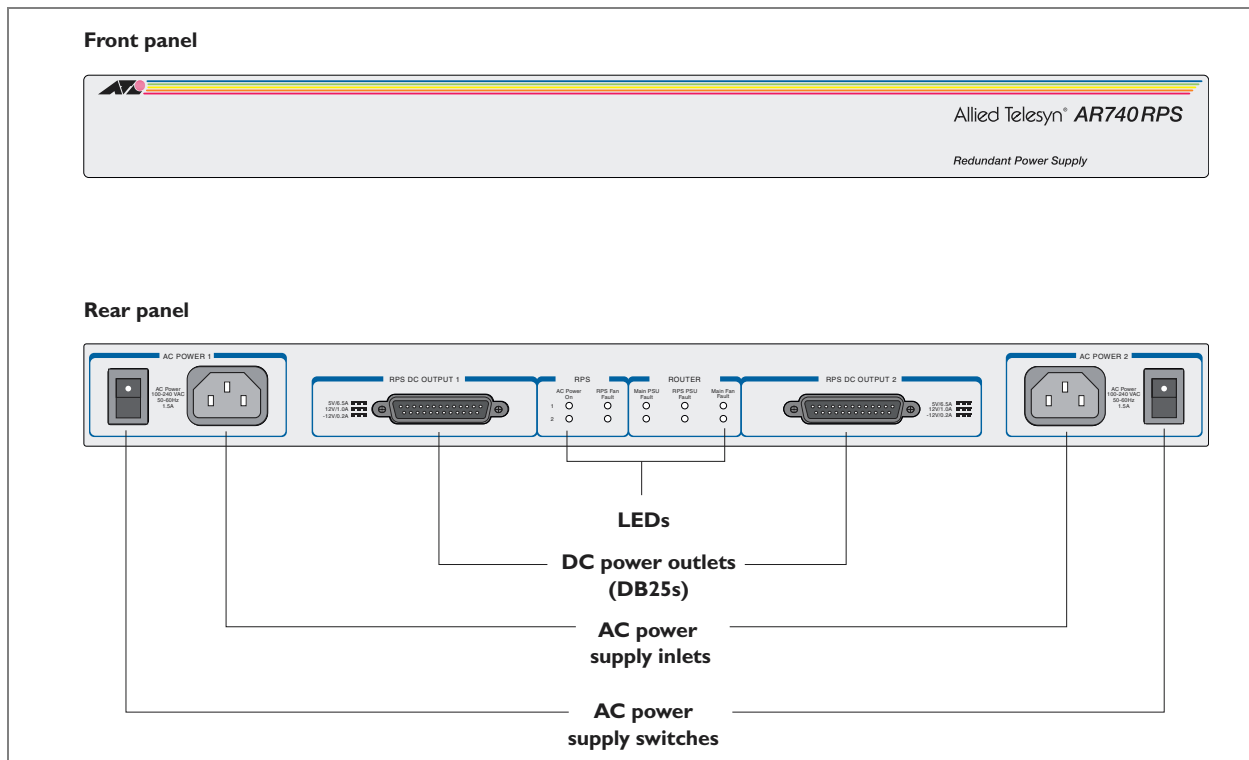

**DC supply cables** Two DC supply cables are packed with each AR740 RPS. If making your own cable, use a cable that conforms to UL2464, and has at least twenty-three 24 AWG cores. The cables will need a DB25 male connector on both ends and should be wired in a straight-through configuration. Pin outs for the connectors are listed in [Table 6](#).

Figure 18: DB25 male pinout on the AR740 RPS

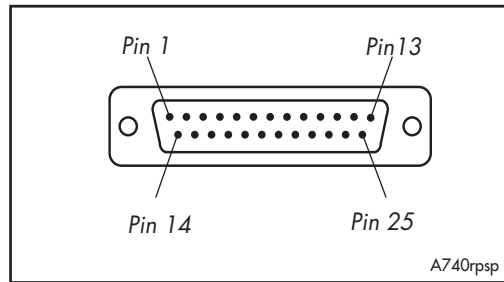

Table 6: DB25 RPS power connector pin out on AR740 RPS

Pin	Function	Direction
1, 25	Keying	-
2, 14	+12 V	output
3-5, 15-17	+5 V	output
6-8, 18-20	0 V	output
9	-12 V	output
10	VCC	input
11	Main PSU error	input
12	Main fan error	input
13	0 V	output
21	Sense 0 V	input
22	Sense +5 V	input
23	RPS PSU error	input
24	RPS fan error	output

## Specifications

### Dimensions

- Height = 44 mm (plus 5.5 mm if the rubber feet are used)
- Width = 440 mm (excluding rack-mounting brackets)
- Depth = 315 mm
- Weight = 3.75 kg

### Mounting System

- 1U rack mounting

### Environmental Conditions

- Operating temperature range: 0 to 40 °C (32 to 104 °F)
- Storage temperature range: -25 to 70 °C (-13 to 158 °F)
- Relative humidity range: 5 to 95% non-condensing

## LEDs

- AC power supply
- RPS fan fault
- Router PSU fault
- RPS PSU fault
- Main (router) fan fault

## AC Power Supply

- Universal 110 VAC to 240 VAC, 50 Hz to 60 Hz input

## DC Output

- 5 V/6.5 A
- 12 V/1.0 A
- -12 V/0.2 A

### AR740 RPS LEDs and what they mean

LEDs on the rear panel indicate the RPS's operational status.

Table 7: AR740 RPS LEDs

LED	State	Function
Power	Green	The RPS unit is receiving AC power and the voltage is within an acceptable range.
RPS Fan Fault	Amber	The RPS is switched OFF. Mains power to the RPS has failed. An RPS fan has failed.
	Off	Normal operation.
Main PSU Fault	Amber	The corresponding router is switched OFF or its PSU has failed. Mains power to the router has failed. The DC cable between the router and RPS is not connected. The RPS is supplying power to the router.
	Off	Normal operation.
RPS PSU Fault	Amber	The RPS is switched OFF or its PSU has failed. Mains power to the RPS has failed. The DC cable between the corresponding router and RPS is not connected.
	Off	Normal operation.
Main Fan Fault	Amber	The DC cable between the corresponding router and RPS is not connected. A main router fan has failed.
	Off	Normal operation.

## SFP Ports (AR770S only)

SFP (small form-factor pluggable) transceivers are compact, hot-swappable, and high speed. Certain fibre-optic SFP transceivers are supported by the AR770S router so that you can interchange port types to meet changing network requirements. The AR770S router has 1000BASE-X Small Form-factor Pluggable Eth slots conveniently located on the front panel.

**Approved SFP transceivers** You can purchase SFP transceivers when you purchase a router or order them separately as needed.

**SFP ports** These SFP transceivers are approved and supported for the AR770S router:

Product No.	Media Type	Description
AT-SPSX (previously AT-MG8SX)	1000BASE-SX	850 nm, 2 to 550 m with 50/125 $\mu$ m MM fibre, 2 to 275 m with 62.5/125 $\mu$ m MM fiber, LC connector
AT-SPLX10 (previously AT-MG8LX10)	1000BASE-LX	1310 nm, 2 m to 10 km with 9 $\mu$ m SM fibre, 2 m to 550 m with 50 $\mu$ m MM fibre, 2m to 550 m with 62.5 $\mu$ m MM fibre, LC connector
AT-SPZX80 (previously AT-MGZX)	1000BASE-ZX	1550 nm, 80 km with 9 $\mu$ m SM fibre, LC connector

For the latest list of approved SFP transceivers, contact your authorised Allied Telesis distributor or reseller.

For instructions on inserting or removing an SFP, see the *AR700 Series Router Installation and Safety Guide* packaged with your router, or available at [www.alliedtelesis.com/support/software/](http://www.alliedtelesis.com/support/software/).



**Warning** Do not look into SFP cables or transceivers. Invisible laser radiation may be emitted from disconnected fibres or connectors.

## PICs and NSMs

You can install PICs (Port Interface Cards) in AR700 Series routers to give the router additional interfaces. The sections describing each router model (earlier in this Reference) list which PICs can be installed in each model of router. Installation information for PICs can be found in the *Port Interface Card Quick Install Guide*. Detailed PIC hardware information can be found in the *Port Interface Card Hardware Reference*.

NSMs can be installed in the AR745 routers. Installation information for NSMs can be found in the *Network Service Module Quick Install Guide*. Detailed NSM hardware information can be found in the *Network Service Module Hardware Reference*.

The PIC and NSM Quick Install Guides and Hardware References are included on the Documentation and Tools CD-ROM bundled with the router. They can also be downloaded from [www.alliedtelesis.com/support/software/](http://www.alliedtelesis.com/support/software/).

## PCI Accelerator Cards (PACs)

PCI Accelerator Cards (PACs) provide additional processing features or performance, but do not add extra physical interfaces to the router. A PAC can be installed in the dedicated PAC slot on AT-AR725 and AT-AR745 routers. The AR750S, AR750S-DP, and AR770S routers have an inbuilt high performance encryption processor, and therefore do not have a PAC slot.



**Warning** PACs should only be installed by authorised service personnel. Unauthorised opening of the router's lid may cause danger of injury from electric shock, damage to the router, and invalidation of the product warranty.

Two PACs are available:

- AT-AR060 EPAC, Encryption PAC.
- AT-AR061 ECPAC, Encryption/Compression PAC.

### How PACs work

PACs provide AR725 and AR745 routers with high performance hardware-based encryption and/or compression services. PACs have a DMA slave processor, which operates independently of the base system. This processor is responsible for the transfer of data between the base system and the PAC, and the control of local high speed encryption and compression data processing devices.

This architecture allows data encoding to be performed off-line without involving the base router processor, thereby maximising PAC performance while at the same time minimising impact on the router.

The PAC is a single card. [Figure 19](#) shows the layout of the board for an AT-AR061 ECPAC.

Figure 19: Location of main components on the AT-AR061 ECPAC card

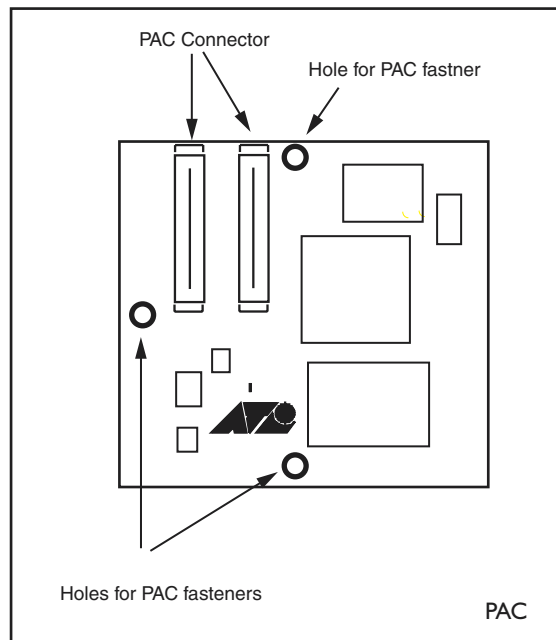

**Compression** PAC-based compression has the following features:

- Local 32-bit processor for high speed control and data transfer.
- Dedicated high performance 32-bit compression hardware.
- High compression ratio Lempel-Ziv algorithm in hardware.
- 2 MBytes of history memory.
- Support for up to 127 compression channels.

Compression and decompression operations are performed by a 32-bit data compression coprocessor specifically designed for high-performance Lempel-Ziv compression applications. The 2 MBytes of history memory allows up to 127 individual data links to use compression concurrently, enabling PACs to provide compression for complicated network architectures. Figure 20 shows typical compression ratios achieved by a PAC for a representative set of file types.

Figure 20: Typical hardware compression ratios by file type

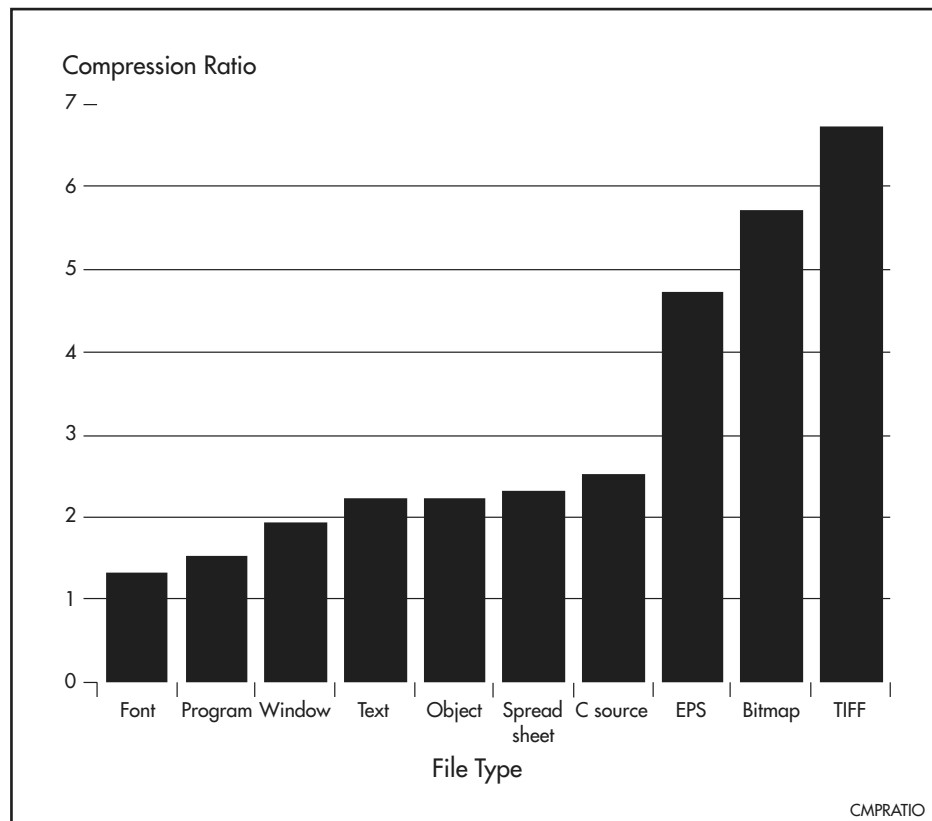

**Encryption** PAC-based encryption has the following features:

- Local 32-bit processor for high speed control and data transfer.
- Dedicated high performance 32-bit Data Encryption Standard – DES and Triple DES (3DES) – hardware.

PAC DES and triple DES encryption are based on a fast 32-bit device that complies with FIPS PUB 46, ISO DEA-1 and ANSI X3.92 standards.

**Dual Mode** Throughput of an encrypted link can be dramatically increased by using data compression. To support this, ECPACs support both encryption and compression, providing a dual mode that allows combined compression and encryption operations. So that the compression phase will have the best



opportunity at finding non-random data, compression occurs before encryption, in the order:

compression → encryption → // → decryption → decompression

Adding compression to an encrypted link increases line throughput. Once compression has been carried out there is less data requiring encryption, passing back to the base system, and transferring across the network, so less base system bus and network link bandwidth is required for a given amount of data. This results in the dual operation being very effective where encryption is required.

## Asynchronous Interfaces

Asynchronous interfaces, also known as terminal ports, (labelled ASYN0, ASYN1, RS-232 or CONSOLE) use RJ-45 connectors, wired as DTE with one of two pinout wiring schemes:

- For AR725, AR745 and AT-AR024 asynchronous port pinouts see [Table 8](#).
- For AR750S, AR750S-DP and AR770S asynchronous port pinouts see [Table 9](#).

Table 8: Pinout\* of asynchronous ports for AT-AR725, AT-AR745 and AT-AR024

RJ-45 Pin	Function	Signal Direction
1	RING	Input to router (only available on expansion card interfaces)
2	DCD	Input to router
3	DTR	Output from router
4	GND	
5	RXD	Input to router
6	TXD	Output from router
7	CTS	Input to router
8	RTS	Output from router

\* Pins are numbered from left to right looking into the socket with the locking tab down.

Table 9: Pinout\* of asynchronous interface on an AR750S, AR750S-DP, and AR770S

RJ-45 Pin	Function	Signal Direction
1	RTS	Output from router
2	DTR	Output from router
3	TXD	Output from router
4	GND	
5	GND	
6	RXD	Input to router
7	DCD	Input to router
8	CTS	Input to router

\* Pins are numbered from left to right looking into the socket with the locking tab down.

Asynchronous interfaces follow the RS-232 standard. A range of speeds is selectable using the **set asyn** command from the *Interfaces* chapter of the Software Reference.

Not all signals need to be connected. In particular, DCD, DTR, CTS and RTS are not required unless the interface has been specifically set up to use them. See the *Terminal Server* chapter in the Software Reference for more details. A typical terminal connection will only require RXD, TXD and GND, but refer to the equipment manual for the connected device for more specific data.

**LPD print ports** If LPD-based printer ports are required, then the router may expect to 'see' the DTR signal from the printer connected to the DCD pin of the router. This is used to detect both the fact that the printer is 'online' and that it

is 'powered-on'. This prevents print jobs from being sent to a disconnected printer and lost. See *the Printer Server* chapter of the Software Reference.

## Cables and Loopback Plugs

This section describes how to make cables for connecting the AR router to networks, terminals, and printers. It also describes loopback plugs, which are required for testing most router interfaces.

### RS-232 Terminal and Modem Cables

The following tables list the wiring diagrams to follow when constructing terminal and modem cables for various connector and port combinations for asynchronous ports.

- For AR725, AR745 and AT-AR024 asynchronous ports see [Table 10](#).
- For AR750S, AR750S-DP and AR770S asynchronous ports see [Table 11](#).

Table 10: Terminal and modem cables for AR725, AR745 and AT-AR024

Cable	Figure
Asyn port on router/PIC to DB25 female (terminal) cable (DTE to DTE)	<a href="#">Figure 21 on page 52</a>
Asyn port on router/PIC to DB9 female (terminal) cable (DTE to DTE)	<a href="#">Figure 23 on page 53</a>
Asyn port on router/PIC to DB25 male (modem) cable (DTE to DCE)	<a href="#">Figure 25 on page 54</a>
Asyn port on router/PIC to DB9 male (modem) cable (DTE to DCE)	<a href="#">Figure 27 on page 55</a>
Asyn port on router/PIC to MiniDin (Macintosh) (DTE to DTE)	<a href="#">Figure 29 on page 56</a>

Table 11: Terminal and modem cables for AR750S, AR750S-DP, and AR770S

Cable	Figure
Asyn port on router to DB25 female (terminal) cable (DTE to DTE)	<a href="#">Figure 22 on page 52</a>
Asyn port on router to DB9 female (terminal) cable (DTE to DTE)	<a href="#">Figure 24 on page 53</a>
Asyn port on router to DB25 male (modem) cable (DTE to DCE)	<a href="#">Figure 26 on page 54</a>
Asyn port on router to DB9 male (modem) cable (DTE to DCE)	<a href="#">Figure 28 on page 55</a>
Asyn port on router to MiniDin (Macintosh) (DTE to DTE)	<a href="#">Figure 30 on page 56</a>

**RING input** The RING input is only available on asynchronous ports on expansion cards. It is not available on asynchronous ports on base CPU boards.

An alternative method, for both terminal and modem cables, is to wire an RJ-45 patch cord (a straight pin-to-pin cable with RJ-45 connectors on both ends) and then use an RJ-45-to-DB25 adaptor wired internally as a crossed cable. These adaptors are available in DB9 and DB25 female and male versions from data cabling suppliers, and are supplied with wires terminated on the RJ-45 socket and pins on the free ends. The pins are inserted into the appropriate positions in the DB9 or DB25 shell.

Figure 21: Pin wiring for terminal cable to connect asyn port on AR725, AR745 or AT-AR024 to DB25 female (terminal) port

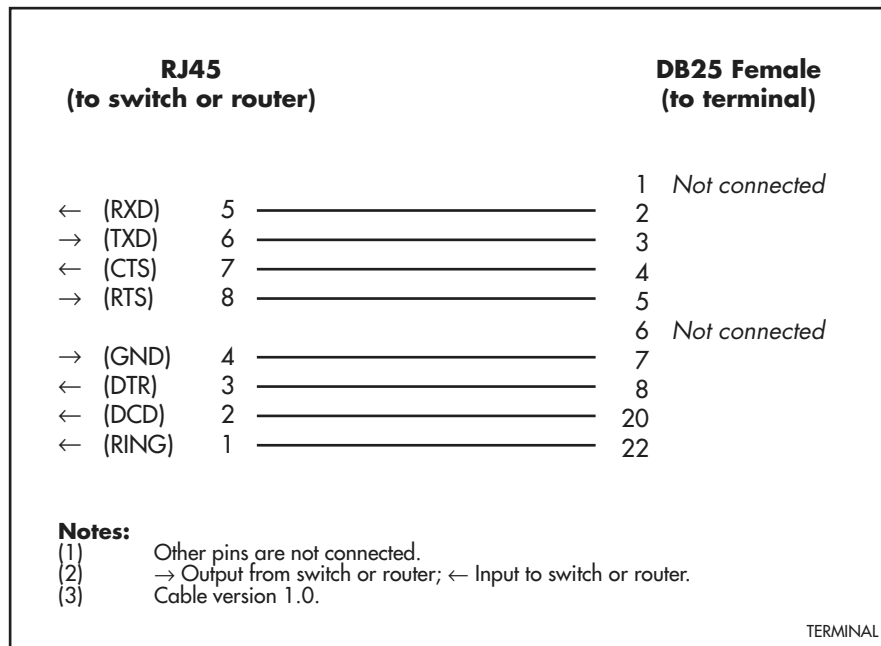

Figure 22: Pin wiring for terminal cable to connect asyn port on AR750S, AR750S-DP or AR770S to DB25 female (terminal) port

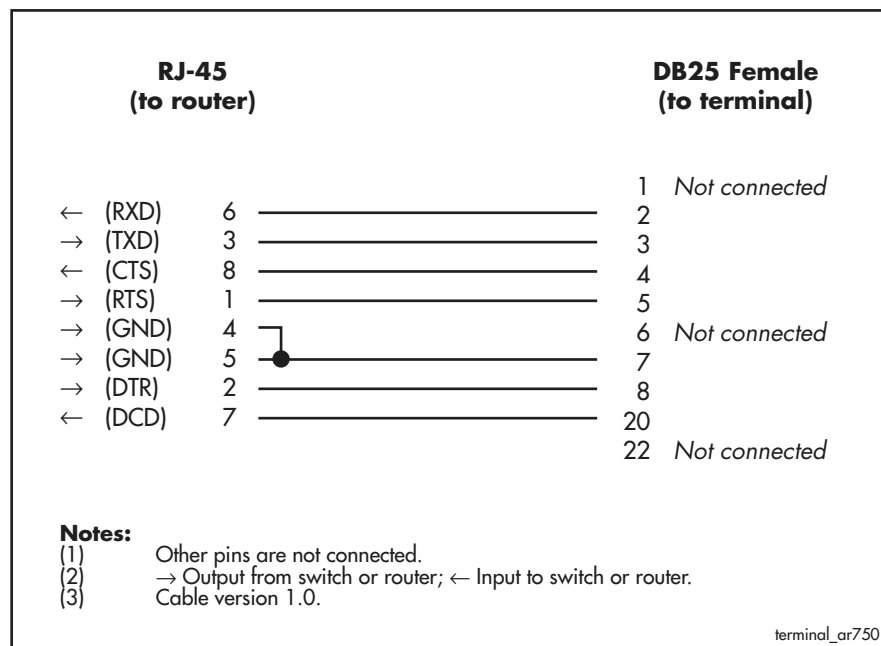

Figure 23: Pin wiring for terminal cable to connect asyn port on AR725, AR745 or AT-AR024 to DB9 female (terminal) port

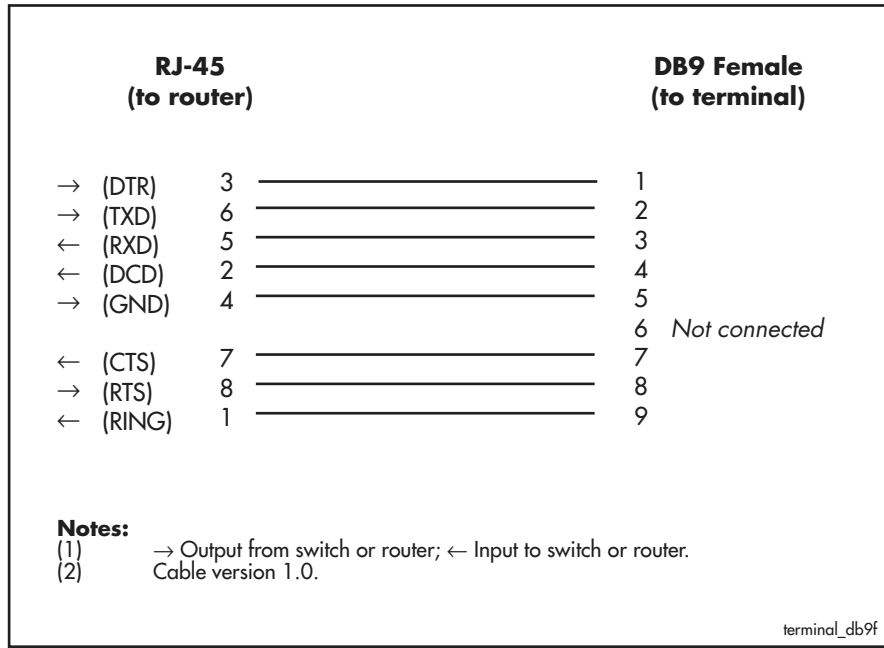

Figure 24: Pin wiring for terminal cable to connect asyn port on AR750S, AR750S-DP, or AR770S to DB9 female (terminal) port

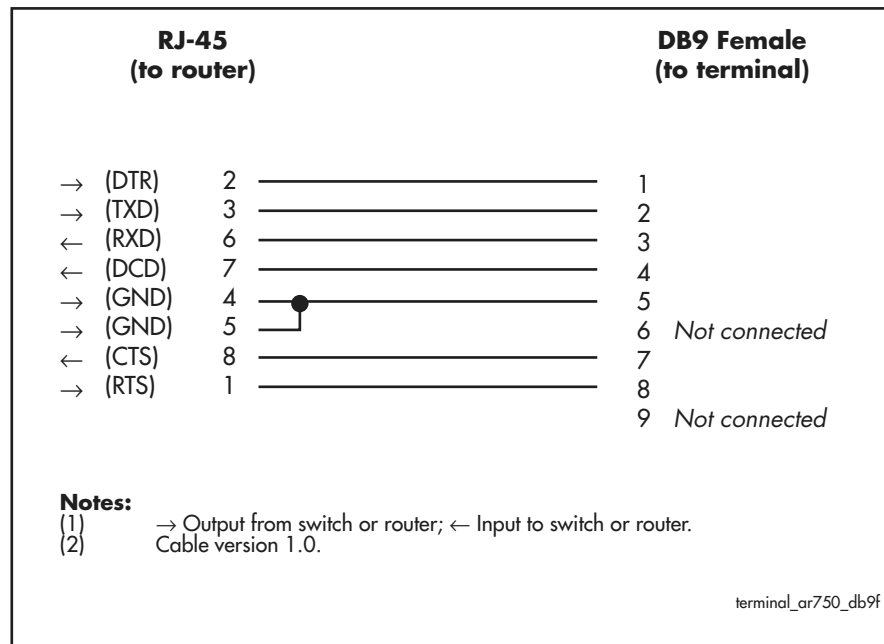

Figure 25: Pin wiring for modem cable to connect asyn port on AR725, AR745 or AT-AR024 to DB25 male (modem) port

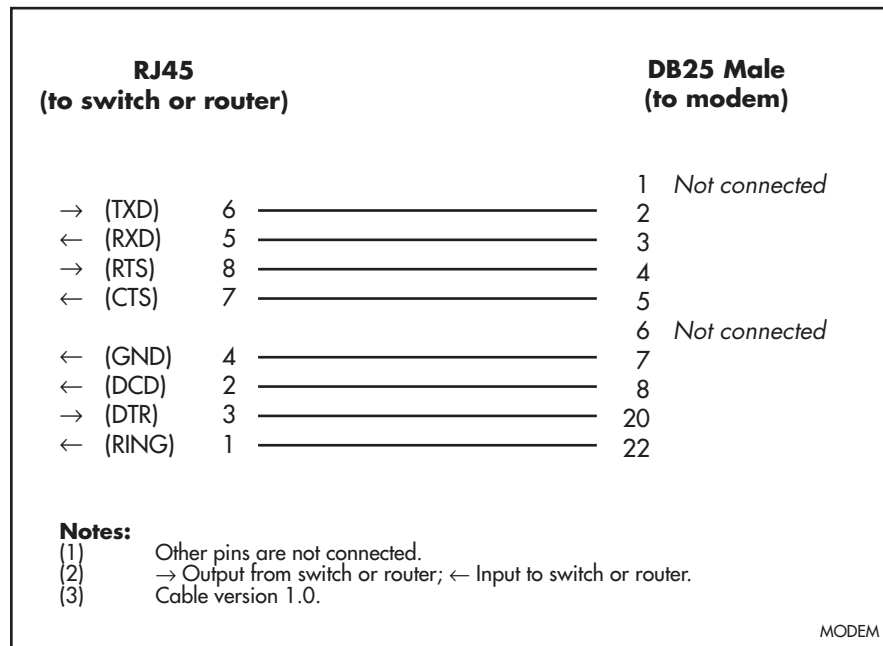

Figure 26: Pin wiring for modem cable to connect asyn port on AR750S, AR750S-DP, or AR770S to DB25 male (modem) port

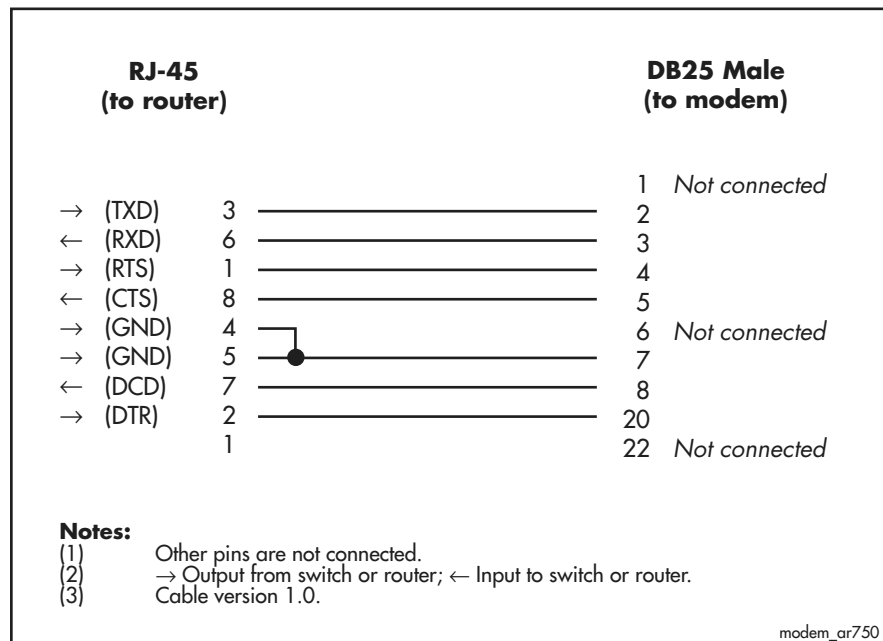

Figure 27: Pin wiring for modem cable to connect asyn port on AR725, AR745 or AT-AR024 to DB9 male (modem) port

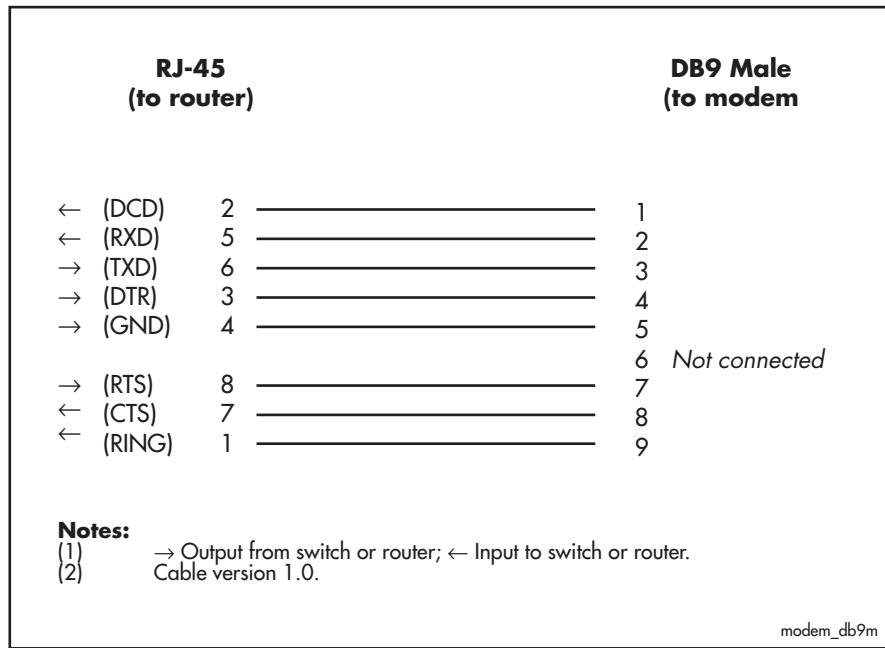

Figure 28: Pin wiring for modem cable to connect asyn port on AR750S, AR750S-DP, or AR770S to DB9 male (modem) port

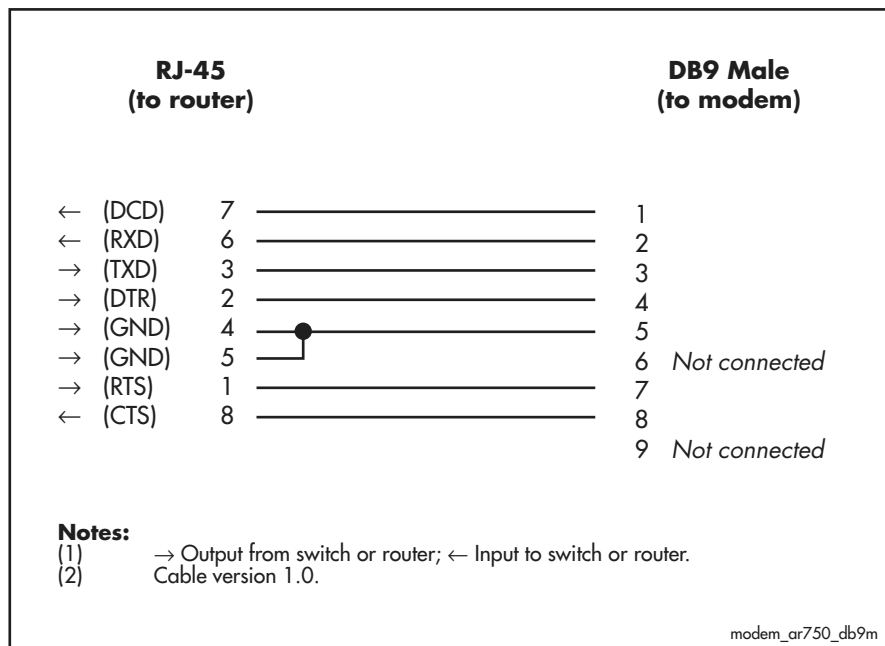

Figure 29: Pin wiring diagram for a Macintosh serial cable to connect asyn port on AR725, AR745 or AT-AR024 to MiniDin (Macintosh)

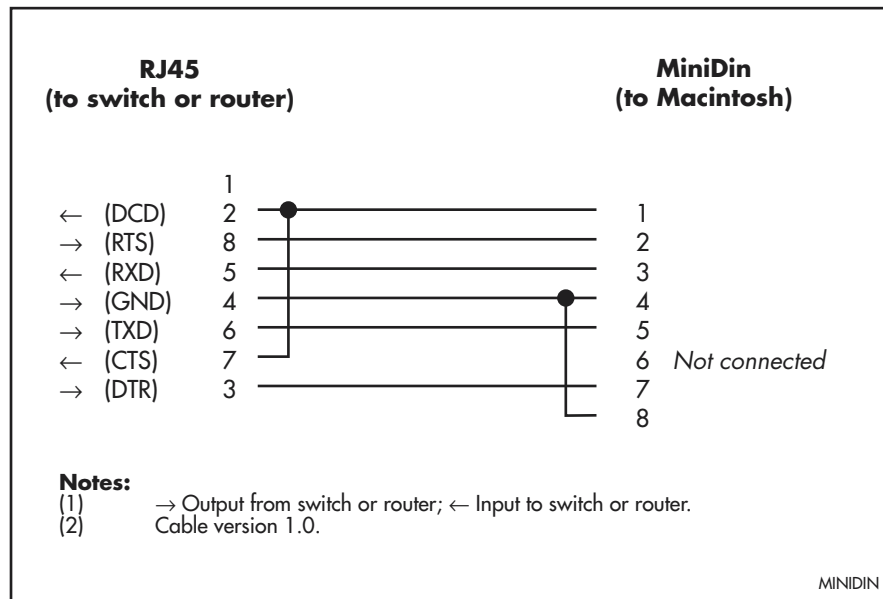
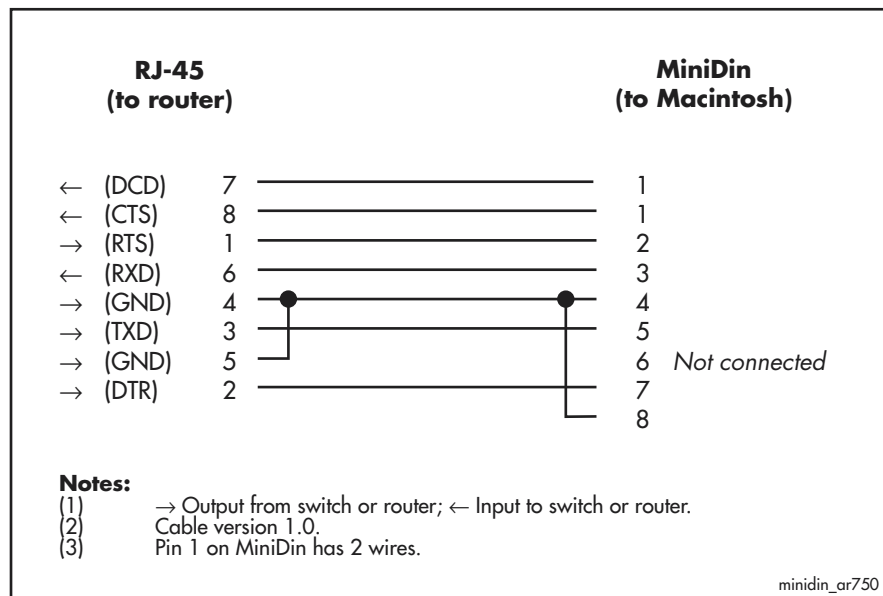

Figure 30: Pin wiring diagram for a Macintosh serial cable to connect asyn port on AR750S, AR750S-DP, or AR770S to MiniDin (Macintosh)



## Loopback Plugs for Testing Interfaces

Loopback plugs are used in conjunction with the Test Facility software (see the *Test Facility* chapter) to test the router's physical interfaces. The purpose of a loopback plug is to connect the output pins on the interface to the input pins so that any data transmitted over the interface is looped back and received at the same interface.

On interfaces with control signals, these are also looped back. The data received on the interface is compared with the data transmitted to determine whether or not the interface is functioning correctly. In order to produce a comprehensive test report, most tests performed by the Test Facility require a loopback plug to be inserted in the interface being tested.



Some interfaces (e.g., the synchronous ports) require a specially built external testing device (available from your authorised Allied Telesis distributor or reseller) to be used in conjunction with the Test Facility.

Table 12 lists the loopback plug wiring diagrams for each interface type.

Table 12: Loopback plug pin wiring diagrams

Physical Interface	Loopback Pin Wiring Diagram
RJ-45 asynchronous interface on AR725, AR745 or AT-AR024	Figure 31
RJ-45 asynchronous interface on AR750S, AR750S-DP or AR770S	Figure 32
Ethernet TP interface	Figure 33

Figure 31: RJ-45 loopback plug for testing asyn interfaces AR725, AR745 or AT-AR024

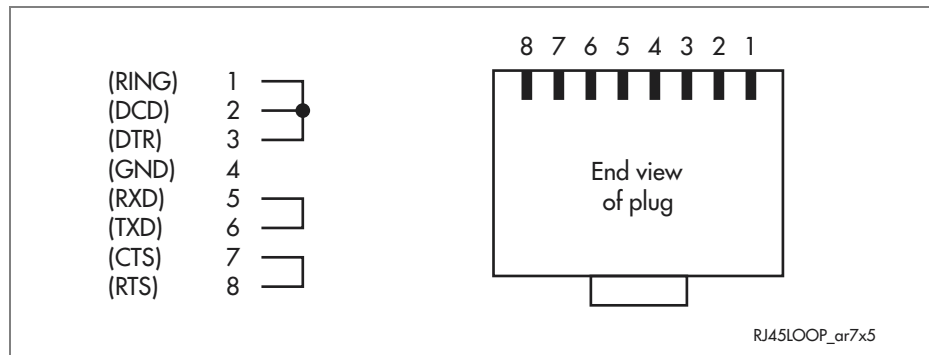

Figure 32: RJ-45 loopback plug for testing asyn interfaces on AR750S, AR750S-DP, or AR770S

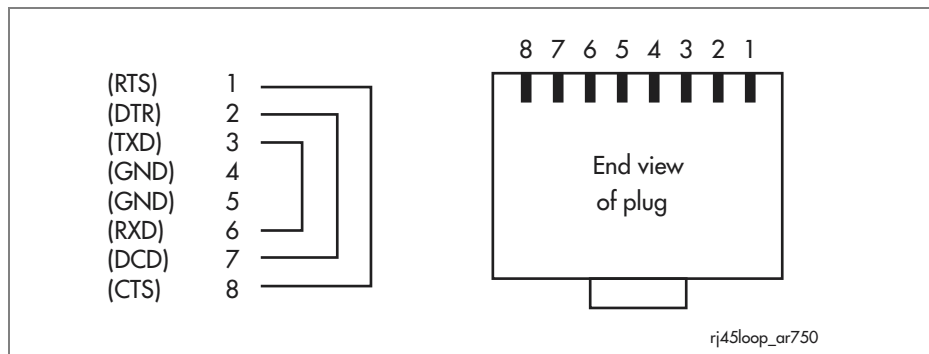
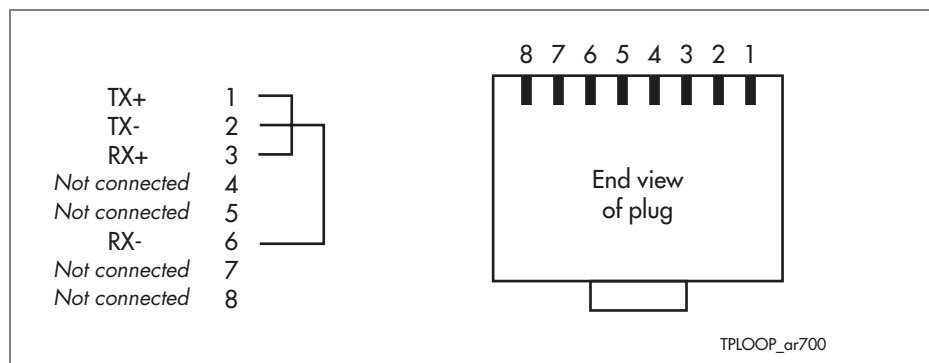

Figure 33: Ethernet twisted pair (TP) loopback plug



## Test Facility

A Test Facility designed to test the router's physical interfaces is built into all the router software. The Test Facility can be thought of as a specialised interface module like PPP or Frame Relay. Although the router can continue to operate normally during specific tests, any interfaces being tested are dedicated to the Test Facility. For more information on the Test Facility's operation, see the *Test Facility* chapter of the Software Reference.

The routers support a wide range of interface types, including Ethernet, asynchronous, synchronous, Basic Rate ISDN and Primary Rate ISDN. interface types (except Ethernet interfaces on the AT-AR026 PIC) can be tested independently using the Test Facility software. Most tests, however, will also require the use of a loopback plug. For more information on loopback plugs, see "[Loopback Plugs for Testing Interfaces](#)" on page 56.

**AR026 PIC** The Test Facility does not test Ethernet interfaces on AT-AR026 PICs.

The following examples show how to test specific interfaces.

To display test results use the command:

```
show test
```

which produces a display like that shown in [Figure 34](#).

**Test failure** If a test fails, please contact your authorised Allied Telesis distributor or reseller.

Figure 34: Example output from the **show test** command

Board	ID	Bay	Board Name	Host Id	Rev	Serial number
Base	241		AR750S	0	P1-0	ATR00433
PIC	38	0	AT-AR023-00	0	M2-0	42199300
PIC	38	1	AT-AR023-00	0	M2-0	41872128

Interface	State	Result	Type	Duration (minutes)	Details Data( %OK )	Control
eth0	no test	-	-	-	-	-
eth1	no test	-	-	-	-	-
port1	complete	good	-	2	good(100.0)	-
port2	complete	good	-	2	good(100.0)	-
port3	complete	good	-	2	good(100.0)	-
port4	complete	good	-	2	good(100.0)	-
port5	complete	good	-	2	good(100.0)	-
syn0	no test	-	-	-	-	-
syn1	complete	good	RS-232dte	1	good(100.0)	good
			dce	1	good(100.0)	good
			X.21 dte	1	good(100.0)	good
			dce	1	good(100.0)	good
			V.35 dte	1	good(100.0)	good
			dce	1	good(100.0)	good
asyn0	no test	-	-	-	-	-
enco0	no test	-	-	-	-	-

### Asynchronous Interface Tests

Asynchronous interfaces require a loopback plug to be installed before the test will operate. See “[Cables and Loopback Plugs](#)” on page 51 for details of how to make a loopback plug. To start a test of an asynchronous interface, use the command:

```
enable test int=portn
```

where *n* is the interface number. This will run the test for 4 minutes. Use the **show test** command (from the *Test Facility* chapter of the Software Reference), to observe the test progress.

### Ethernet Interface Tests for Switch and Eth Ports

A loopback plug is required to run the first part of the Ethernet test on eth ports and switch ports. See “[Cables and Loopback Plugs](#)” on page 51 for details of how to make a loopback plug.

To start a test of an Eth interface, use the command:

```
enable test int=ethn
```

where *n* is the Ethernet interface number.

To start a test of a switch port interface, use the command:

```
enable test int=portn
```

where *n* is the switch port number.

This will run the test for 4 minutes. Use the **show test** command (from the *Test Facility* chapter of the Software Reference), to observe the test progress.

**AR770S** To test an eth port on the AR770S in 1000 Mbps mode, loop the port back to the other eth port. To test a switch port in 1000 Mbps mode, loop the port back to another switch port. In 10 Mbps or 100 Mbps mode, either loop the port back to another port, or use a loopback plug. If two or more ports are looped back to each other, you must test both ports at the same time. Use the command:

```
enable test int=base
```

**AR026 PIC** The Test Facility does not test Ethernet interfaces on AT-AR026 PICs.

### WAN Port Tests

To fully test synchronous interfaces, an external tester (available from your authorised Allied Telesis distributor or reseller) is required. A loopback plug is not required to test BRI interfaces.

To start a WAN interface test, use the command:

```
enable test int=synn
```

or

```
enable test int=brin
```

where *n* is the WAN interface number. This will run the test for 4 minutes. Use the **show test** command (from the *Test Facility* chapter of the Software Reference), to observe the test progress.

## Restricted Maintenance Procedures

This section contains procedures that should only be performed by authorised service personnel. Unauthorised use of procedures in this section may cause danger of injury from electric shock, damage to the router, and invalidation of the product warranty.

If you would like to know more about the procedures outlined in this section, please contact your authorised Allied Telesis distributor or reseller.

## Diagnostics

The router software includes a set of diagnostic programs. These programs perform basic level checks of all system components. They do not run in conjunction with the normal operating code, and require that the system be totally dedicated to their use. A detailed knowledge of the way your router hardware functions is necessary if diagnostics are to be used effectively.



**Caution** Diagnostic mode is only to be used by authorised service personnel. Unauthorised use of diagnostic mode may cause the router to cease functioning.

The router will not function as a router if diagnostic mode is running.

**AR026 PIC** The diagnostics programs do not perform checks on AT-AR026 PICs.

### To enable diagnostics mode:

#### 1. Connect a terminal to the console port.

Connect a terminal to the console port (port 0) on the router's rear panel, and set the terminal communications parameters to:

- 9600 bps
- 8 data bits
- 1 stop bit
- No parity
- Hardware flow control

#### 2. Restart the router.

Restart the router, either by switching it off and on again using the power switch on the rear panel, or by using the terminal to login and enter the command:

```
restart reboot
```

### 3. Enable diagnostics mode during start-up.

During the router start-up process, at the prompt:

```
Force EPROM download (Y)?
```

press [Ctrl/D] on the terminal to enter diagnostics mode. A banner page is displayed on the terminal (Figure 35). This can be used to check that the terminal is correctly connected.



**Caution** Running the battery-backed RAM test, Full Flash test, or Totally Erase Flash option will cause important system files to be deleted. These will need to be reinstalled before the router can function normally.

Figure 35: Diagnostics banner page.

```
* * * Diagnostic Mode * * *

version: 12-Jan-2005

Main Menu:
 0. Restart
 1. Full RAM test
 2. ROM checksum test
 3. LED test
 4. Dump or Modify
Enter selection ==>
```

Figure 36: Example diagnostics banner page for the AR770S

```
* * * Diagnostic Mode * * *

version: Jul  8 2005 11:20:29

Main Menu:
 0. Restart
 1. Full RAM test
 2. ROM checksum test
 5. Battery backed RAM test
 9. LED test
 A. Dump or Modify
Enter selection ==>
```

To run a diagnostic program, enter the corresponding letter or number. There are several sub-menus to cover all the different options. Table 13 lists the keys that control the basic operation of the diagnostics.

Table 13: Basic commands for running diagnostics

Key	Function
Q	Quits any running tests and displays the banner page.
S	Prints a summary of test results so far.

Diagnostics are designed to be used with all models of the router, and therefore some instances of particular tests will not be appropriate for some models. A reasonable level of understanding of the system structure is needed to operate

diagnostics and interpret the results. Diagnostics only require the base CPU board to be installed in the system.

To restore an AR725, AR745, AR750S, or AR770S router to normal operation, perform a restart by switching its power switch (rear panel) OFF and ON. To restore the AR750S-DP to normal operation, use the Reset button on the front panel of the router.

**For more information** This manual is not intended as a guide to diagnostics. Diagnostics are designed to be run by service personnel only. For more information, contact your authorised Allied Telesis distributor or reseller.

## Lithium Battery Replacement

The routers have a replaceable lithium battery. The battery should be replaced when the router:

- has been in storage for more than two years
- has only been powered up intermittently over a two year period
- loses its time setting
- displays the message "ERROR: BBR Battery low"
- loses its configuration during a power cycle



**Caution** Batteries should be replaced by authorised service personnel only. Unauthorised opening of the router lid may cause danger of injury from electric shock, damage to the router, and invalidation of the product warranty.

The battery must be replaced by a 3 V lithium button cell, type CR2032 or equivalent.

## Contacting Us

---

With locations covering all of the established markets in North America, Latin America and Europe, Allied Telesis provides localized sales and technical support worldwide. To find our representative nearest you, visit Allied Telesis on the web at: <http://www.alliedtelesis.com>.

## Free Manuals Download Website

<http://myh66.com>

<http://usermanuals.us>

<http://www.somanuals.com>

<http://www.4manuals.cc>

<http://www.manual-lib.com>

<http://www.404manual.com>

<http://www.luxmanual.com>

<http://aubethermostatmanual.com>

Golf course search by state

<http://golfingnear.com>

Email search by domain

<http://emailbydomain.com>

Auto manuals search

<http://auto.somanuals.com>

TV manuals search

<http://tv.somanuals.com>