

High-Density Layer 3 Stackable Gigabit Ethernet Switch

AT-9724TS

Installation and User's Guide

PN D617/10032 Rev I

Copyright. 2004 Allied Telesyn, Inc.

19800 North Creek Parkway, Suite 200, Bothell WA 98011, USA

All rights reserved. No part of this publication may be reproduced without prior written permission from Allied Telesyn, Inc. All product names, company names, logos or other designations mentioned herein are trademarks or registered trademarks of their respective owners. Allied Telesyn, Inc. reserves the right to make changes in specifications and other information contained in this document without prior written notice. The information provided herein is subject to change without notice. In no event shall Allied Telesyn Inc. be liable for any incidental, special, indirect, or consequential damages whatsoever, including but not limited to lost profits, arising out of or related to this manual or the information contained herein, even if Allied Telesyn, Inc. has been advised of, known, or should have known, the possibility of such damages.

Electrical Safety and Emission Statement

Standards: This product meets the following standards.

CE Marking Warning: This is a Class A product. In a domestic environment this product may cause radio interference in which case the user may be required to take adequate measures.

Important: Appendix B contains translated safety statements for installing this equipment. When you see the go to Appendix A for the translated safety statement in your language.

Wichtig: Anhang B enthält übersetzte Sicherheitshinweise für die Installation dieses Geräts. Wenn Sie sehen, schlagen Sie in Anhang A den übersetzten Sicherheitshinweis in Ihrer Sprache nach.

Vigtigt: Tillæg B indeholder oversatte sikkerhedsadvarsler, der vedrører installation af dette udstyr. Når De ser symbolet, skal De slå op i tillæg A og finde de oversatte sikkerhedsadvarsler i Deres eget sprog.

Belangrijk: Appendix B bevat vertaalde veiligheidsopmerkingen voor het installeren van deze apparatuur. Wanneer u de ziet, raadpleeg Appendix A voor vertaalde veiligheidsinstructies in uw taal.

Important: L'annexe B contient les instructions de sécurité relatives à l'installation de cet équipement. Lorsque vous voyez le symbole, reportez-vous à l'annexe A pour consulter la traduction de ces instructions dans votre langue.

Tärkeää: Liite B sisältää tämän laitteen asentamiseen liittyvät käännetyt turvaohjeet. Kun näet -symbolin, katso käännettyä turvaohjetta liitteestä A.

Importante: L'Appendice B contiene avvisi di sicurezza tradotti per l'installazione di questa apparecchiatura. Il simbolo, indica di consultare l'Appendice A per l'avviso di sicurezza nella propria lingua.

Viktig: Tillegg B inneholder oversatt sikkerhetsinformasjon for installering av dette utstyret. Når du ser, åpner du til Tillegg A for å finne den oversatte sikkerhetsinformasjonen på ønsket språk.

Importante: O Anexo B contém advertências de segurança traduzidas para instalar este equipamento. Quando vir o símbolo, leia a advertência de segurança traduzida no seu idioma no Anexo A.

Importante: El Apéndice B contiene mensajes de seguridad traducidos para la instalación de este equipo. Cuando vea el símbolo, vaya al Apéndice A para ver el mensaje de seguridad traducido a su idioma.

Obs! Bilaga B innehåller översatta säkerhetsmeddelanden avseende installationen av denna utrustning. När du ser, skall du gå till Bilaga A för att läsa det översatta säkerhetsmeddelandet på ditt språk.

Table of Contents

Electrical Safety and Emission Statement	1
Preface	5
Purpose of This Guide	5
How This Guide is Organized	5
Document Conventions	6
Where to Find Related Guides	7
Contacting Allied Telesyn Technical Support	7
Returning Products	8
FTP Server	8
For Sales or Corporate Information	8
Tell Us What You Think	9
Introduction	10
Fast Ethernet	10
Gigabit Ethernet Technology	10
Switching Technology	10
Switch Description	11
Ports	12
Installing the SFP ports	12
Front-Panel Components	12
LED Indicators	13
Rear Panel Components	13
Side Panel Components	14
Installation	14
Package Contents	14
Before You Connect to the Network	14
Installing the Switch Without the Rack	15
Installing the Switch in a Rack	16
Mounting the Switch in a Standard 19" Rack	16
Power On	16
Power Failure	16
External Redundant Power System	16
Connecting The Switch	17
Switch To End Node	17
Switch to Hub or Switch	17
Connecting To Network Backbone or Server	18
Stacking and the AT-9724TS	18
Stacking Limitations utilizing a Ring Topology	19
Introduction To Switch Management	20
AT-9724TS Gigabit Layer 3 Switch Management Options	20
Web-based Management Interface	20
SNMP-Based Management	20
Command Line Console Interface Through The Serial Port	20
Connecting the Console Port (RS-232 DCE)	20
First Time Connecting to The Switch	21
Password Protection	22
SNMP Settings	22
Traps	23
MIBs	23
IP Address Assignment	23
Connecting Devices to the Switch	24
Introduction to Web-based Switch Configuration	25
Introduction	25
Login to Web Manager	25
Web-based User Interface	26
Areas of the User Interface	26
Web Pages	27
Configuring The Switch	28
Switch Information	28
IP Address	29
Setting the Switch's IP Address using the Console Interface	30
Advanced Settings	30
Box Information	31
Port Configurations	32
Port Description	33
Port Mirroring	34
Link Aggregation	34
Understanding Port Trunk Groups	34
LACP Port Setting	36
MAC Notification	37
MAC Notification Global Settings	37
MAC Notification Port Setting	38
IGMP	38
IGMP Snooping	40
Static Router Ports	41
Spanning Tree	42
802.1s MSTP	42
802.1w Rapid Spanning Tree	43
STP Bridge Global Settings	43
MST Configuration Table	45

MSTI Port Information	48
STP Instance Settings	49
STP Port Settings	51
Forwarding & Filtering	52
Unicast Forwarding	52
Static Multicast Forwarding	53
VLANs	54
Understanding IEEE 802.1p Priority	54
VLAN Description	54
Notes About VLANs on the AT-9724TS	54
IEEE 802.1Q VLANs	54
802.1Q VLAN Tags	55
Port VLAN ID	57
Tagging and Untagging	57
Ingress Filtering	57
Default VLANs	57
Port-based VLANs	58
VLAN Segmentation	58
VLAN and Trunk Groups	58
Protocol VLANs	59
Static VLAN Entry	59
GVRP Setting	62
Traffic Control	63
Port Security	64
Port Lock Entries	65
QoS	66
The Advantages of QoS	66
Understanding QoS	66
Bandwidth Control	67
QoS Scheduling Mechanism	68
Output Scheduling	68
Configuring the Combination Queue	69
802.1p Default Priority	70
802.1p User Priority	70
Traffic Segmentation	71
System Log Server	72
SNTP Settings	74
Current Time Settings	74
Time Zone and DST	75
Access Profile Table	76
Configuring the Access Profile Table	76
Port Access Entity (802.1X)	84
Understanding 802.1x Port-based and MAC-based Network Access Control	84
Port-Based Network Access Control	85
MAC-Based Network Access Control	85
Configure Authenticator	86
Local Users	87
PAE System Control	88
Port Capability Settings	88
Initializing Ports for Port Based 802.1x	89
Initializing Ports for MAC Based 802.1x	90
Reauthenticate Port(s) for Port Based 802.1x	90
Reauthenticate Port(s) for MAC Based 802.1x	91
RADIUS Server	92
Layer 3 IP Networking	93
Layer 3 Global Advanced Settings	93
Setting Up IP Interfaces	93
MDS Key Table Configuration	95
Route Redistribution Settings	96
Static/Default Route	97
Route Preference Settings	98
Static ARP Table	100
RIP	100
RIP Route Interpretation	101
RIP Configuration	102
Setting Up RIP	102
OSPF	103
General OSPF Settings	117
OSPF Area ID Settings	117
OSPF Interface Settings	118
OSPF Virtual Interface Settings	120
OSPF Area Aggregation Settings	121
OSPF Host Route Settings	121
DHCP / BOOTP Relay	122
DHCP / BOOTP Relay Information	122
DHCP/BootP Relay Settings	123
DNS Relay	123
Configuring DNS Relay	124
DNS Relay Static Settings	124
VRRP	125
VRRP Configuration	125
VRRP Interface Settings	126
IP Multicast Routing Protocol	129
IGMP Interface Configuration	129
DVMRP Interface Configuration	130
DVMRP Global Settings	130
DVMRP Interface Settings	130
PIM-DM Interface Configuration	132
PIM-DM Configuration	131

Security Management	133
Security IP	133
User Accounts	133
Admin and User Privileges	134
Access Authentication Control	135
Policy & Parameters	135
Application's Authentication Settings	136
Authentication Server Group Settings	136
Authentication Server Hosts	138
Login Method Lists	139
Enable Method Lists	140
Local Enable Password	141
Enable Admin	142
Secure Socket Layer (SSL)	143
Download Certificate	143
Configuration	144
Secure Shell (SSH)	145
SSH Configuration	145
SSH Algorithm	145
SSH User Authentication	147
SNMP Manager	149
SNMP Settings	149
SNMP User Table	150
SNMP View Table	151
SNMP Group Table	152
SNMP Community Table Configuration	153
SNMP Host Table	154
SNMP Engine ID	155
Monitoring	156
Port Utilization	156
CPU Utilization	156
Packets	157
Received (RX)	157
UMB Cast (RX)	159
Transmitted (TX)	160
Errors	162
Received (RX)	162
Transmitted (TX)	163
Size	165
Stacking Information	166
Device Status	167
MAC Address	168
Switch History Log	169
IGMP Snooping Group	170
IGMP Snooping Forwarding	170
Browse Router Port	171
Port Access Control	171
Authenticator State	171
Authenticator Statistics	172
Authenticator Session Statistics	174
Authenticator Diagnostics	175
RADIUS Authentication	176
RADIUS Accounting	177
Layer 3 Feature	178
Browse IP Address	178
Browse Routing Table	179
Browse ARP Table	179
Browse IP Multicast Forwarding Table	179
Browse IGMP Group Table	180
OSPF Monitoring	180
Browse OSPF LSDB Table	180
Browse OSPF Neighbor Table	181
OSPF Virtual Neighbor	181
DVMRP Monitoring	182
Browse DVMRP Routing Table	182
Browse DVMRP Neighbor Address Table	182
Browse DVMRP Routing Next Hop Table	183
PIM Monitoring	183
PIM Neighbor Address Table	183
Switch Maintenance	184
TFTP Services	184
Download Firmware	184
Download Configuration File	184
Upload Configuration	185
Upload Log	185
Multiple Image Services	185
Firmware Information	185
Config Firmware Image	186
Ping Test	187
Save Changes	188
Reset	188
Reboot Device	189
Logout	189
Appendix A Technical Specifications	190
Appendix B Translated Electrical Safety and Emission Information	192

Preface

Purpose of This Guide

This guide is intended for network administrators who are responsible for installing and maintaining the AT-9724TS Gigabit Switch.

How This Guide is Organized

This guide contains the following chapters and appendices:

- Chapter 1, Introduction, describes the features, functions, LEDs, and ports on the Gigabit Switch.
- Chapter 2 Installation, describes how to install the switch.
- Chapter 3 Connecting the Switch.
- Chapter 4. Introduction to Switch Management, basic management features, connecting devices to the switch.
- Chapter 5. Introduction to Web-based Switch Management.
- Chapter 6. Configuring the Switch, including accessing switch information, setting up network configurations.
- Chapter 7. Management, security features, user accounts, access authentication control.
- Chapter 8. SNMP Manager, description of features and brief introduction.
- Chapter 9. Monitoring
- Chapter 10. Maintenance, switch utility functions.
- Appendix A, Specifications, provides Residential Gateway specifications.
- Appendix B, Translated Electrical Safety and Emission Information, contains multi-language translations of the cautions and warnings in this manual.

Document Conventions

This guide uses several conventions that you should become familiar with before you begin to install the product:



Note

A note provides additional information.



Warning

A warning indicates that performing or omitting a specific action may result in bodily injury.



Caution

A caution indicates that performing or omitting a specific action may result in equipment damage or loss of data.

[]

In a command line, square brackets indicate an optional entry. For example: [copy filename] means that optionally you can type copy followed by the name of the file. Do not type the brackets.

Bold font

Indicates a button, a toolbar icon, menu, or menu item. For example: Open the File menu and choose Cancel. Used for emphasis. May also indicate system messages or prompts appearing on your screen. For example: You have mail. Bold font is also used to represent filenames, program names and commands. For example: use the copy command.

Typewriter Font

Indicates commands and responses to prompts that must be typed exactly as printed in the manual.

Italics

Indicates a window name or a field. Also can indicate a variable or parameter that is replaced with an appropriate word or string. For example: type *filename* means that you should type the actual filename instead of the word shown in italic.

Menu Name > Menu Option

Indicates the menu structure. **Device > Port > Port Properties** means the Port Properties menu option under the Port menu option that is located under the Device menu.

Where to Find Related Guides

The Allied Telesyn web site at **www.alliedtelesyn.com** under the support section contains the most recent documentation for all of our products. All web-based documents relating to this product and other Allied Telesyn products can be downloaded from the web site.

Contacting Allied Telesyn Technical Support

You can contact Allied Telesyn technical support through the company's web site **www.alliedtelesyn.com** under the support section or by telephone or fax.

EUROPEAN SUPPORT NUMBERS

Telephone support is available Monday through Friday between 0900 and 1730 local time (excluding national holidays).

Austria, Belgium, Finland, France, Germany, Ireland, Italy, Luxembourg, The Netherlands, Norway, Sweden, Switzerland and the United Kingdom

Free phone 00 800 287 877 678 or +31 20 711 4333
europe_support@alliedtelesyn.com

Spain:

Free phone 00 800 287 877 67 or +31 20 711 4333
europe_support@alliedtelesyn.com

Finland:

Free phone: 990 800 287 877 67 or +31 20 711 4333
europe_support@alliedtelesyn.com

Croatia and Slovenia:

Support Telephone number: +385 | 382 1341
Support Fax Number: + 385 | 382 1340
Support e-mail Address: AT1helpdesk_Croatia@alliedtelesyn.com

Czech Republic:

Support Telephone number: +420 296 538 888
Support Fax Number: +420 296 538 889
Support e-mail Address: Czech_support@alliedtelesyn.com

Hungary:

Support Telephone number: +36 | 382 6385
Support Fax number: +36 | 382 6398
Support e-mail Address: Hungary_Helpdesk@alliedtelesyn.com

Poland:

Support Telephone number: +48 22 535 9670
Support Fax number: +48 22 535 9671
Support e-mail Address: Polska_pomoc@alliedtelesyn.com

Serbia, Montenegro, Macedonia, Bosnia and Herzegovina and Bulgaria:

Support Telephone number: +381 | | 32 35 639
Support Fax Number: +381 | | 3235 992
Support e-mail Address: Yug.Servis@alliedtelesyn.com

Russia and former Soviet Union Countries:

Support Telephone number: +7-095-935 8585
Support Fax Number: +7-095-935 8586
Support e-mail Address : support_CIS@alliedtelesyn.ru

Ukraine:

Support Telephone number: +7-095-935 8585
Support Fax Number: +7-095-935 8586
Support e-mail Address : Ukraine support@alliedtelesyn.com

All other countries not listed above should refer their technical support request to:

Support Telephone number: +31 20 711 4333
Support e-mail Address: europe_support@alliedtelesyn.com

Americas:

Technical Support by Phone or Fax (8-5 PST M-F)
Toll-free: 1 800 428 4835
Fax: 1 425 481 3790

*Support for Puerto Rico and the US Virgin Islands is provided through our Technical Support Center in Latin America.

México

e-mail soporte_mexico@alliedtelesyn.com
Teléfono +52 55 5559 0611

Returning Products

Products for return or repair must first be assigned a Return Materials Authorization (RMA) number. RMA policy varies from country to country. Please check the applicable RMA policy at www.alliedtelesyn.com. For Europe, you can also contact our European Customer Service centre by e-mail at rma_europe@alliedtelesyn.com.

FTP Server

If you need management software for an Allied Telesyn managed device, you can download the software by connecting directly to our FTP server at [ftp.alliedtelesyn.com](ftp://ftp.alliedtelesyn.com). At login, enter "anonymous" as the user name and your e-mail address as the password.

European & Latin America Headquarters

Allied Telesyn International SA

Via Motta 24
6830 Chiasso
Switzerland
Tel: +41 91 6976900
Fax: +41 91 6976911

Allied Telesyn International Services

Piazza Tirana n.24/4 B
20147 Milano
Italy
Tel: +39 02 4141121
Fax: +39 02 41411261

REGIONAL LOCATIONS

Austria & Eastern Europe

Allied Telesyn Vertriebsgesellschaft m.b.H.
Lainzer Strasse 16/5-6
1130, Vienna
Tel: +43-1-876 24 41
Fax: +43-1-876 25 72

Poland

Allied Telesyn Vertriebsgesellschaft m.b.H.
Sp. z o.o. Oddzial w Polsce
ul. Elektoralna 13
00-137 Warszawa
Tel: +48 22 620 82 96
Fax: +48 22 654 48 56

Romania

Allied Telesyn Vertriebsgesellschaft m.b.H.
str.Thomas Masaryk 23
Sector 2, Bucharest 0209
Tel: +40-21-211-1817/8245
Fax: +40-21-210-5610

Russia

Allied Telesyn International
Ul. Korovij Vall
Dom 7 Str. 1 Office 190
119049 Moscow
Tel: +7095 9358585
Fax: +7095 9358586

Serbia & Montenegro

Allied Telesyn Vertriebsgesellschaft m.b.H.
Krunska 6
11000 Belgrade
Tel & Fax: +381 11 3033 208
+381 11 3033 209
+381 11 3235 639

France

Allied Telesyn International SAS
12, avenue de Scandinavie
Parc Victoria, Immeuble "Le Toronto"
91953 Courtaboeuf Cédex - Les Ulis
Tel: +33 1 60 92 15 25
Fax: +33 1 69 28 37 49

Greece

Allied Telesyn International S.r.l
Kiriazzi 14-16
145 62 Kifisia
Tel: +30 210 6234 200
Fax: +30 210 6234 209

Italy – North

Allied Telesyn International S.r.l.
Via Anna Kuliscioff, 37
20152 Milano
Tel: +39 02 41304.1
Fax: +39 02 41304.200

Italy – East

Tel: +39 348 1522583
Tel & Fax: +39 049 8868175

Italy – South

Allied Telesyn International S.r.l.
Via Troilo il Grande 3
00131 Roma
Tel: +39 06 41294507
Fax: +39 06 41404801

Turkey

Allied Telesyn International
6. Cadde 61/2 Öveçler
06460 Ankara
Tel: +90 312 472 1054/55
Fax: +90 312 472 1056

Germany – South

Allied Telesyn International GmbH
Zeppelinstr. 1
85399 Hallbergmoos
Tel: +49-811-999 37-0
Fax: +49-811-999 37-22

Germany - Köln

Allied Telesyn GmbH West
Edmund Rumpel-Str. 6b
51149 Köln
Deutschland
Tel.: +49 02203 1019685
Fax: +49 02203 1019678

Denmark

Allied Telesyn International
Jyllinge ErhvervsCenter
Møllehaven 8
DK-4040 Jyllinge
Tel: +45 46734835
Fax: +45 46734837

Finland

Allied Telesyn International Ltd.
Metsänneidonkuja 10
02130 ESPOO
Tel: +358 9 7255 5290
Fax: +358 9 7255 5299

Iceland +47 22 70 04 70

Ireland (Freephone) 1 800 409 127

The Netherlands

Allied Telesyn International BV
Hoeksteen 26
2132 MS Hoofddorp
Tel: +31 20 6540 246
Fax: +31 20 6540 249

Norway

Allied Telesyn International
Ole Deviksvvei 4
0666 Oslo
Tel: +47 22 70 04 70
Fax: +47 22 70 04 01

Sweden

Allied Telesyn International
Isafjordsgatan 22, B5tr
164 40 Kista
Sweden
Tel.: +46 (0) 8131414
Fax: +46 (0) 87506004

United Kingdom

Allied Telesyn International Ltd.
100 Longwater Avenue
GreenPark
Reading, RG2 6GP
Tel: +44 118 920 9800
Fax: +44 118 975 2456

Latin America – Support Office

Allied Telesyn International
19800 North Creek Parkway, Suite 200
Bothell, WA 98011 USA
Tel: +1 425 481 3852
Fax: +1 425 489 9191
Toll Free (Mexico & Puerto Rico): (95-800) 424 5012 ext. 3852

Latin America – Mexico

Allied Telesyn International
AV. Insurgentes Sur # 800, Piso 8
Col. Del Valle
México, DF, 03100
Tel: +52 55 5448 4989
Fax: +52 55 5448 4910

Portugal

Allied Telesyn International
Centro de Escritórios das Laranjeiras
Praça Nuno Rodrigues dos Santos, N° 7 Sala 21 I
1600-171 Lisbon
Tel: +351 21 721 74 00
Fax: +351 21 727 91 26

Spain

Allied Telesyn International S.L.U
Plaza de España
18-4º Ofic. 3, 28008 Madrid
Tel: +34 91 559 1055
Fax: +34 91 559 2644

Allied Telesyn International, Corp.

19800 North Creek Parkway, Suite 200
Bothell, WA 98011
Tel: 1 (425) 487-8880
Fax: 1 (425) 489-9191

For current information, please visit our web site
www.alliedtelesyn.com

Tell Us What You Think

If you have any comments or suggestions on how we might improve this or other Allied Telesyn documents, please contact us at www.alliedtelesyn.com.

Chapter I - Introduction

- I-1 Ethernet Technology
- I-2 Switch Description
- I-3 Features
- I-4 Ports
- I-5 Front Panel Components
- I-6 Rear-Panel Description
- I-7 Side-Panel Description
- I-8 Gigabit Combo Ports
- I-9 Ethernet Technology
- I-10 Fast Ethernet Technology

I-1 Ethernet Technology

Fast Ethernet

The growing importance of LANs and the increasing complexity of desktop computing applications are fueling the need for high performance networks. A number of high-speed LAN technologies are proposed to provide greater bandwidth and improve client/server response times. Among them, Fast Ethernet, or 100T, provides a non-disruptive, smooth evolution from 10T technology.

100Mbps Fast Ethernet is a standard specified by the IEEE 802.3 LAN committee. It is an extension of the 10Mbps Ethernet standard with the ability to transmit and receive data at 100Mbps, while maintaining the Carrier Sense Multiple Access with Collision Detection (CSMA/CD) Ethernet protocol.

Gigabit Ethernet Technology

Gigabit Ethernet is an extension of IEEE 802.3 Ethernet utilizing the same packet structure, format, and support for CSMA/CD protocol, full duplex, flow control, and management objects, but with a tenfold increase in theoretical throughput over 100Mbps Fast Ethernet and a one hundred-fold increase over 10Mbps Ethernet. Since it is compatible with all 10Mbps and 100Mbps Ethernet environments, Gigabit Ethernet provides a straightforward upgrade without wasting a company's existing investment in hardware, software, and trained personnel.

The increased speed and extra bandwidth offered by Gigabit Ethernet are essential to coping with the network bottlenecks that frequently develop as computers and their buses get faster and more users use applications that generate more traffic. Upgrading key components, such as your backbone and servers to Gigabit Ethernet can greatly improve network response times as well as significantly speed up the traffic between your subnetworks.

Gigabit Ethernet enables fast optical fibre connections to support video conferencing, complex imaging, and similar data-intensive applications. Likewise, since data transfers occur 10 times faster than Fast Ethernet, servers outfitted with Gigabit Ethernet NIC's are able to perform 10 times the number of operations in the same amount of time.

In addition, the phenomenal bandwidth delivered by Gigabit Ethernet is the most cost-effective method to take advantage of today and tomorrow's rapidly improving switching and routing internetworking technologies.

Switching Technology

Another key development pushing the limits of Ethernet technology is in the field of switching technology. A switch bridges Ethernet packets at the MAC address level of the Ethernet protocol transmitting among connected Ethernet or Fast Ethernet LAN segments.

Switching is a cost-effective way of increasing the total network capacity available to users on a local area network. A switch increases capacity and decreases network loading by making it possible for a local area network to be divided into different segments, which are not competing with each other for network transmission capacity, and therefore decreasing the load on each segment.

The Switch acts as a high-speed selective bridge between the individual segments. Traffic that needs to go from one segment to another (from one port to another) is automatically forwarded by the Switch, without interfering with any other segments (ports). This allows the total network capacity to be multiplied, while still maintaining the same network cabling and adapter cards.

For Fast Ethernet or Gigabit Ethernet networks, a switch is an effective way of eliminating problems of chaining hubs beyond the "two-repeater limit." A switch can be used to split parts of the network into different collision domains, for example, making it possible to expand your Fast Ethernet network beyond the 205-meter network diameter limit for 100TX networks. Switches supporting both traditional 10Mbps Ethernet and 100Mbps Fast Ethernet are also ideal for bridging between existing 10Mbps networks and new 100Mbps networks.

Switching LAN technology is a marked improvement over the previous generation of network bridges, which were characterized by higher latencies. Routers have also been used to segment local area networks, but the cost of a router and the setup and maintenance required make routers relatively impractical. Today's switches are an ideal solution to most kinds of local area network congestion problems.

I-2 Switch Description

The AT-9724TS has 24 1000T Gigabit ports that may be used in uplinking various network devices to the Switch, including PCs, hubs and other switches to provide a gigabit Ethernet uplink in full-duplex mode.

In addition, the AT-9724TS is equipped with 4 SFP (Small Form Factor Portable) combo ports, which are to be used with fibre-optical transceiver cabling in order to uplink various other networking devices for a gigabit link that may span great distances. These 4 SFP ports support full-duplex transmissions, have auto-negotiation and can be used with AT-MG8LX10 (1000LX), AT-MG8SX (1000SX) and AT-MG8ZX (1000ZX) transceivers. These four ports are referred to as "combo" ports which means that both the SFP ports and the 1000T ports are numbered the same (21–24) and cannot be used simultaneously. Attempting to use the ports simultaneously will cause a link down status for the 1000T ports. SFP ports will always have priority over these 1000T ports.

Also included at the rear of the Switch are two 10-gigabit stacking ports used to stack up to twelve switches in a ring topology. The AT-9724TS may be used as the master unit of a switch stack when utilizing these ports and, in total, may provide a stacking solution of up to 288 gigabit ports.

 **Note:** The four SFP combo ports on the Switch, numbered 21–24 cannot be used simultaneously with the corresponding 1000T ports, numbered 21–24. If both ports are in use at the same time (ex. port 21 of the SFP and port 21 of the 1000T), the SFP ports will take priority over the combo ports and render the 1000T ports inoperable.

I-3 Features

- IEEE 802.3z compliant
- IEEE 802.3x Flow Control in full-duplex compliant
- IEEE 802.3u compliant
- IEEE 802.3ab compliant
- IEEE 802.3ae compliant (for optional XFP module)
- IEEE 802.1p Priority Queues
- IEEE 802.3ad Link Aggregation Control Protocol support.
- IEEE 802.1x Port-based and MAC-based Access Control
- IEEE 802.1Q VLAN
- IEEE 802.1D Spanning Tree, IEEE 802.1W Rapid Spanning Tree and IEEE 802.1s Multiple Spanning Tree support
- Stacking support in Ring topology
- Access Control List (ACL) support
- IP Multinetting support
- Protocol VLAN support
- Single IP Management support
- Access Authentication Control utilizing TACACS, XTACACS, TACACS+ and RADIUS protocols
- Dual Image Firmware
- Simple Network Time Protocol support
- MAC Notification support
- System and Port Utilization support
- System Log Support
- High performance switching engine performs forwarding and filtering at full wire speed up to 128Gbps.
- Full- and half-duplex for all gigabit ports. Full duplex allows the switch port to simultaneously transmit and receive data. It only works with connections to full-duplex-capable end stations and switches. Connections to a hub must take place at half-duplex.
- Support broadcast storm filtering
- Non-blocking store and forward switching scheme capability to support rate adaptation and protocol conversion
- Supports by-port Egress/Ingress rate control
- Efficient self-learning and address recognition mechanism enables forwarding rate at wire speed
- Support port-based enable and disable
- Address table: Supports up to 8K MAC addresses per device
- Supports a packet buffer of up to 3 Mbits
- Supports Port-based VLAN Groups
- Port Trunking with flexible load distribution and fail-over function
- IGMP Snooping support
- Layer 3 support including DVMRP, OSPF and RIP

- SNMP support
- Secure Sockets Layer (SSL) and Secure Shell (SSH) support
- Port Mirroring support
- MIB support for:
 - RFC1213 MIB II
 - RFC1493 Bridge
 - RFC1757 RMON
 - RFC1643 Ether-like MIB
 - RFC2233 Interface MIB
 - IF MIB
 - Private MIB
 - RFC2674 for 802.Ip
 - IEEE 802.Ix MIB
- RS-232 DCE console port for Switch management
- Provides parallel LED display for port status such as link/act, speed, etc.

I-4 Ports

Twenty-four (24) 1000T combo ports that may be used in uplinking various network devices to the Switch, including PCs, hubs and other switches to provide a gigabit Ethernet uplink in full-duplex mode.

Four (4) high-performance SFP ports for a fibre-optic connection to various network connections, for use over great distances.

Two 10-gigabit stacking ports at the rear of the Switch for stacking switches utilizing ring topology.

RS-232 DCE Diagnostic port (console port) for setting up and managing the Switch via a connection to a console terminal or PC using a terminal emulation program.

Installing the SFP ports

The Switch is equipped with four SFP (Small Form Factor Portable) ports, which are to be used with fibre-optical transceiver cabling in order to uplink various other networking devices for a gigabit link that may span great distances.

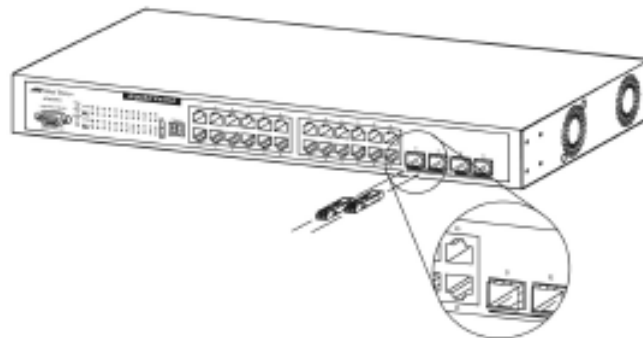

Figure I- 1. Inserting the fibre-optic transceivers into the AT-9724TS

I-5 Front Panel Components

The front panel of the Switch consists of LED indicators for Power, Master, Console, RPS, SIO (stacking), a seven-segment Stack ID LED and for Link/Act for each port on the Switch, as well as 24 1000T ports, 4 SFP gigabit Ethernet ports and a RS-232 DCE console port for Switch management.

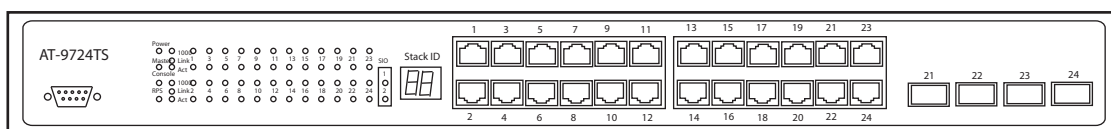

Figure I- 2. Front Panel View of the AT-9724TS as shipped

Comprehensive LED indicators display the status of the Switch and the network.

LED Indicators

The Switch supports LED indicators for Power, Master, Console, RPS, SIO (stacking indicators), a seven-segment Stack ID LED and Port LEDs. The following shows the LED indicators for the Switch along with an explanation of each indicator.

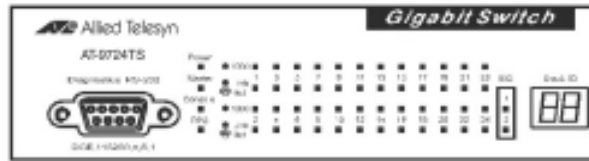

Figure I- 3. LED Indicators

LED Description

- Power** This LED will light green after the Switch is powered on to indicate the ready state of the device. The indicator is dark when the Switch is powered off.
- Master** This LED will light solid green when the Switch is configured to be a master switch of a switch stack in a ring topology or when it is in use as a stand-alone switch. This LED will remain dark if the Switch is not configured to be a master switch in a switch stack.
- Console** This LED should blink during the Power-On Self Test (POST). When the POST is finished successfully, the LED goes dark. This indicator will light solid green when the Switch is being logged into via out-of-band/local console management through the RS-232 console port in the front of the Switch using a straight-through serial cable.
This LED will light solid amber if the Power-On-Self-Test has failed.
- RPS** This LED will be lit when the internal power has failed and the RPS has taken over the power supply to the Switch. Otherwise, it will remain dark.
- Port LEDs** One row of LEDs for each port is located above the ports on the front panel. The first LED is for the top port and the second one is for the bottom ports. A solid light denotes activity on the port while a blinking light indicates a valid link. These LEDs will remain dark if there is no link/activity on the port.
- Stacking Ports (SIO)** There are two LEDs in the front of the Switch marked SIO, and they relate to the two 10-gigabit stacking ports at the rear of the Switch. These LEDs are marked 1 and 2 and will light solid green to denote activity on the port, while a blinking light will indicate a valid link.
- Stack ID** These two seven-segment LEDs display the current switch stack order of the Switch while in use. Possible numbers to be displayed range from 1-12 in use.

I-6 Rear Panel Components

The rear panel of the Switch contains an AC power connector, two 10-gigabit stacking ports and a redundant power supply connector.

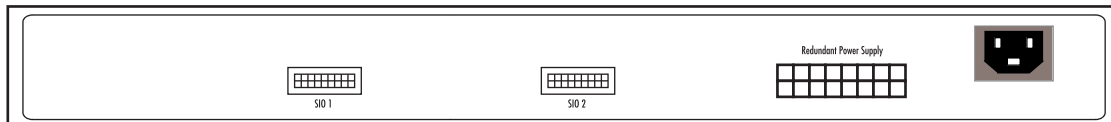

Figure I- 4. Rear panel view of the Switch

The AC power connector is a standard three-pronged connector that supports the power cord. Plug-in the female connector of the provided power cord into this socket, and the male side of the cord into a power outlet. The Switch automatically adjusts its power setting to any supply voltage in the range from 100 ~ 240VAC at 50 ~ 60 Hz.

The rear panel also includes an outlet for an optional external power supply. When power fails, the optional external RPS will take over all the power immediately and automatically.

I-7 Side-Panel Components

The right-hand side panel of the Switch contains 2 system fans, while the left hand panel includes a heat vent.

The system fans are used to dissipate heat. The sides of the system also provide heat vents to serve the same purpose. Do not block these openings, and leave at least 6 inches of space at the rear and sides of the Switch for proper ventilation. Be reminded that without proper heat dissipation and air circulation, system components might overheat, which could lead to system failure.

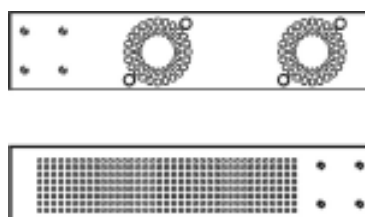

Figure I- 5. Side Panels

Chapter 2 - Installation

- 2-1 Package Contents
- 2-2 Before You Connect to the Network
- 2-3 Installing the Switch Without the Rack
- 2-4 Rack Installation
- 2-5 Power On
- 2-6 Power Failure
- 2-7 Redundant Power System

2-1 Package Contents

Open the shipping carton of the Switch and carefully unpack its contents. The carton should contain the following items:

- One AT-9724TS Switch
- One AC power cord
- One Stacking Cable
- One CD which includes the AT-9724TS Manual, and Net.Cover documents
- One Warranty Card
- Mounting kit (two brackets and screws)
- Four rubber feet with adhesive backing
- RS-232 console cable
- If any item is found missing or damaged, please contact your local Allied Telesyn Reseller for replacement.

2-2 Before You Connect to the Network

The site where you install the Switch may greatly affect its performance. Please follow these guidelines for setting up the Switch.

- Install the Switch on a sturdy, level surface that can support at least 6.6lb. (3kg) of weight. Do not place heavy objects on the Switch.
- The power outlet should be within 1.82 metres (6 feet) of the Switch.
- Visually inspect the power cord and see that it is fully secured to the AC power port.
- Make sure that there is proper heat dissipation from and adequate ventilation around the Switch. Leave at least 10 cm (4 inches) of space at the front and rear of the Switch for ventilation.
- Install the Switch in a fairly cool and dry place for the acceptable temperature and humidity operating ranges.
- Install the Switch in a site free from strong electromagnetic field generators (such as motors), vibration, dust, and direct exposure to sunlight.
- When installing the Switch on a level surface, attach the rubber feet to the bottom of the device. The rubber feet cushion the Switch, protect the casing from scratches and prevent it from scratching other surfaces.
- Ensure you program the Switch with a valid IP address – see section xxxx.

2-3 Installing the Switch without a Rack

When installing the Switch on a desktop or shelf, the rubber feet included with the Switch should first be attached. Attach these cushioning feet on the bottom at each corner of the device. Allow enough ventilation space between the Switch and any other objects in the vicinity.

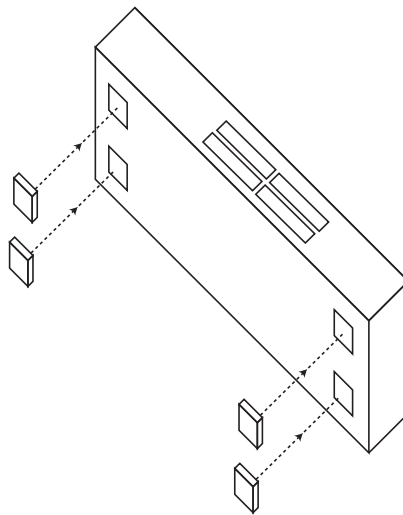

Figure 2- 1. Prepare Switch for installation on a desktop or shelf

2-4 Installing the Switch in a Rack

The Switch can be mounted in a standard 19" rack. Use the following diagrams to guide you.

Fasten the mounting brackets to the Switch using the screws provided. With the brackets attached securely, you can mount the Switch in a standard rack as shown in Figure 2-2.

2-5 Mounting the Switch in a Standard 19" Rack

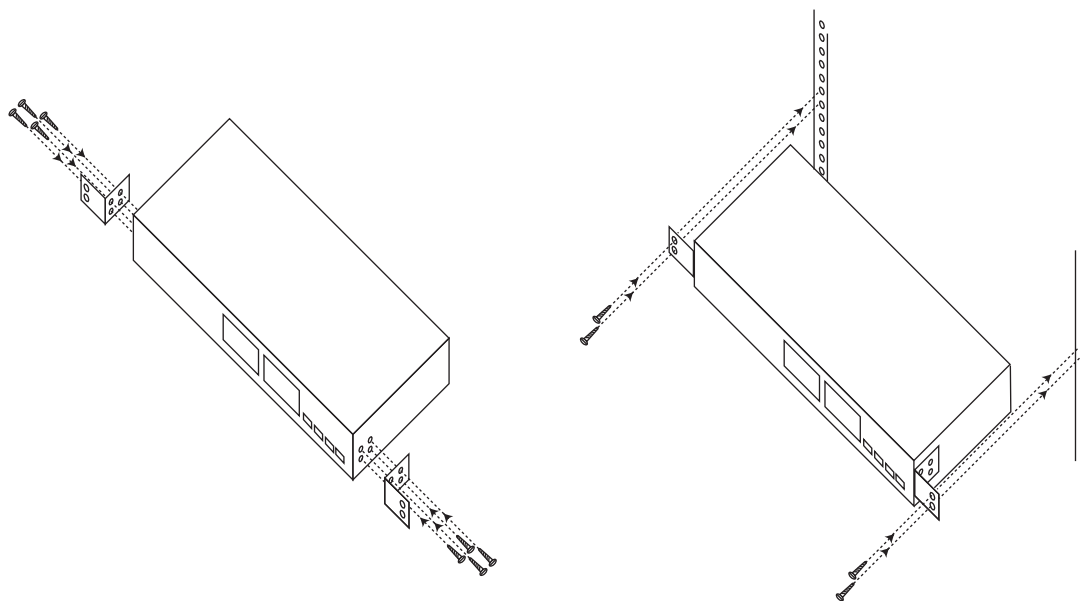

Figure 2- 2. Installing Switch in a rack

2-5 Power On

Plug one end of the AC power cord into the power connector of the Switch and the other end into the local power source outlet.

After the Switch is powered on, the LED indicators will momentarily blink. This blinking of the LED indicators represents a reset of the system.

2-6 Power Failure

As a precaution, in the event of a power failure, unplug the Switch. When power is resumed, plug the Switch back in.

2-7 External Redundant Power System

The Switch supports an external redundant power system.

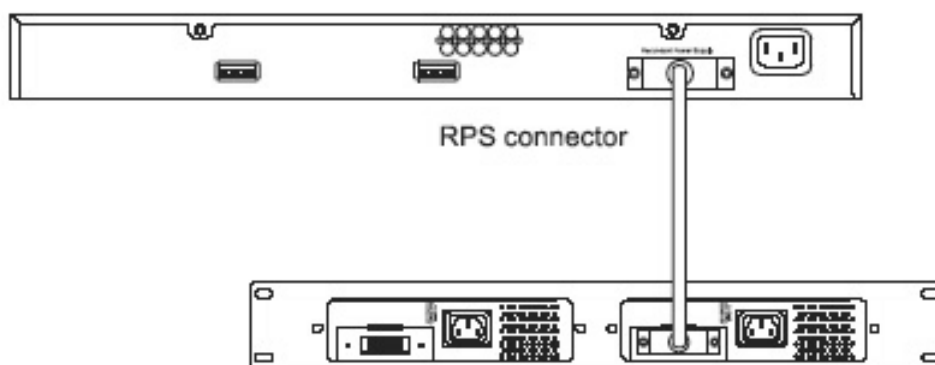

Figure 2- 3. The AT-9724TS with the AT-RPS7000 Redundant External Power Supply

Chapter 3 - Connecting the Switch

- 3-1 Switch to End Node
- 3-2 Switch to Hub or Switch
- 3-3 Connecting to Network Backbone or Server
- 3-4 Stacking and the AT-9724TS

3-1 Switch To End Node

End nodes include PCs outfitted with a 10, 100 or 1000Mbps RJ45 Ethernet Network Interface Card (NIC) and most routers.

An end node can be connected to the Switch via a twisted-pair UTP/STP cable. The end node should be connected to any of the 24 1000T ports of the Switch.

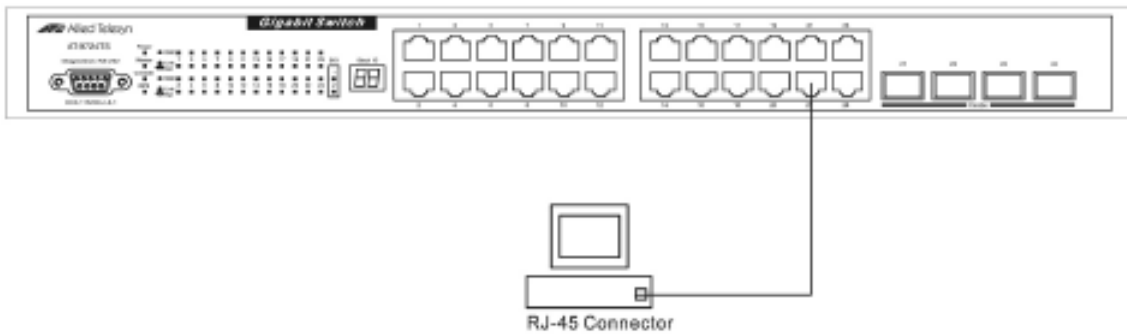

Figure 3- 1. Switch connected to an end node

The Link/Act LEDs for each UTP port will light green or amber when the link is valid. A blinking LED indicates packet activity on that port.

3-2 Switch to Hub or Switch

These connections can be accomplished in a number of ways using a normal cable.

- A 10T hub or switch can be connected to the Switch via a twisted-pair Category 3, 4 or 5 UTP/STP cable.
- A 100TX hub or switch can be connected to the Switch via a twisted-pair Category 5 UTP/STP cable.
- A 1000T switch can be connected to the Switch via a twisted pair Category 5e UTP/STP cable.
- A switch supporting a fibre-optic uplink can be connected to the Switch's SFP ports via fibre-optic cabling.

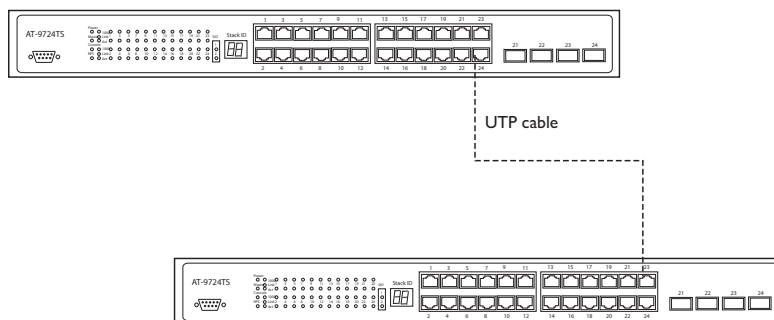

Figure 3- 2. Switch connected to a port on a hub or switch using either a straight or crossover cable – any normal cable is fine

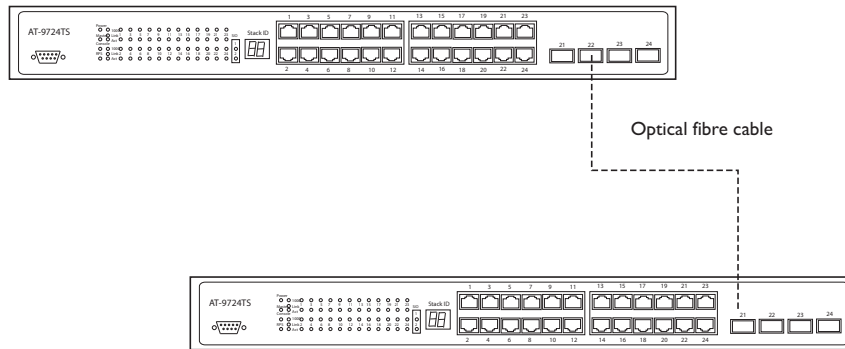

Figure 3- 3. Switch connected to switch using fibre-optic cabling

3-3 Connecting To Network Backbone or Server

The 4 combo SFP ports and the 24 1000T ports are ideal for uplinking to a network backbone, server or server farm. The copper ports operate at a speed of 1000, 100 or 10Mbps in full or half duplex mode. The fibre-optic ports can operate at 1000Mbps in full duplex mode only.

Connections to the Gigabit Ethernet ports are made using fibre-optic cable or Category 5e copper cable, depending on the type of port. A valid connection is indicated when the Link LED is lit.

3-4 Stacking and the AT-9724TS

The AT-9724TS is equipped with two 10-gigabit stacking ports at the rear of the Switch, as seen in Figure 3-5. These stacking ports may be used to stack the AT-9724TS to a master switch to be used in a switch stack.



Figure 3- 5. SIO 1 and SIO 2 Stacking ports at the rear of the AT-9724TS

These two stacking ports, named SIO 1 and SIO 2 can be used with other stacking switches for a scalable stacking solution of up to 288 ports in a ring topology. These two stacking ports have corresponding LEDs at the front of the Switch, labelled SIO 1 and SIO 2 will light solid green whenever the corresponding port is in use.

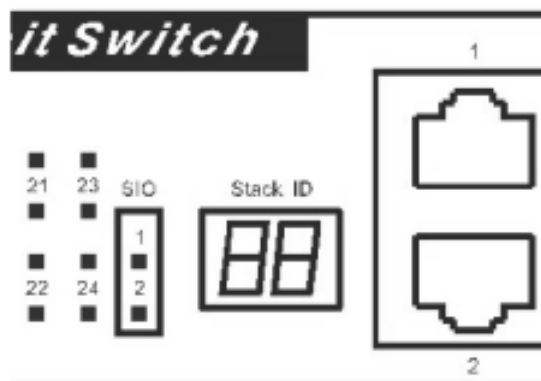

Figure 3- 6. Stacking LEDs (SIO) at the front of the AT-9724TS

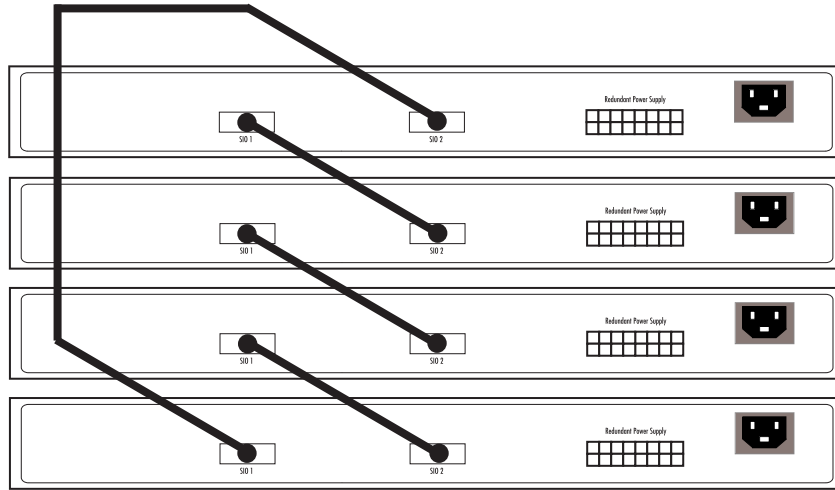



Figure 3- 8. Stacking in a Ring Architecture

 **Note:** Do not connect the stacked Switch group to the network until you have properly configured all Switches for stacking. An improperly configured Switch stack can cause a broadcast storm.

Stacking Limitations Utilizing a Ring Topology

There is a limit to the number of AT-9724TS Switches that can be stacked in a ring topology. A maximum of 12 switches can be stacked.

 **Note:** All Switches must have the same firmware rev.

Chapter 4 - Introduction to Switch Management

- 4-1 AT-9724TS Gigabit Layer 3 Switch Management Options
- 4-2 Web-based Management Interface
- 4-3 SNMP-Based Management
- 4-4 Command Line Console Interface Through The Serial Port
- 4-5 Connecting the Console Port (RS-232 DCE)
- 4-6 First Time Connecting to The Switch
- 4-7 Password Protection
- 4-8 SNMP Settings
- 4-9 IP Address Assignment
- 4-10 Connecting Devices to the Switch

4-1 AT-9724TS Gigabit Layer 3 Switch Management Options

This system may be managed out-of-band through the console port on the front panel or in-band using Telnet. The user may also choose the web-based management, accessible through a web browser.

4-2 Web-based Management Interface

After you have successfully installed the Switch, you can configure the Switch, monitor the LED panel, and display statistics graphically using a web browser, such as Netscape Navigator (version 6.2 and higher) or Microsoft® Internet Explorer (version 5.0).

4-3 SNMP-Based Management

You can manage the Switch with an SNMP-compatible console program. The Switch supports SNMP version 1.0, version 2.0 and version 3.0. The SNMP agent decodes the incoming SNMP messages and responds to requests with MIB objects stored in the database. The SNMP agent updates the MIB objects to generate statistics and counters.

4-4 Command Line Console Interface Through The Serial Port

You can also connect a computer or terminal to the serial console port to access the Switch. The command-line-driven interface provides complete access to all Switch management features.

4-5 Connecting the Console Port (RS-232 DCE)

The Switch provides an RS-232 serial port that enables a connection to a computer or terminal for monitoring and configuring the Switch. This port is a female DB-9 connector, implemented as a data terminal equipment (DTE) connection.

To use the console port, you need the following equipment:

- A terminal or a computer with both a serial port and the ability to emulate a terminal.
- A null modem or crossover RS-232 cable with a female DB-9 connector for the console port on the Switch (supplied with the switch).

To connect a terminal to the console port:

1. Connect the female connector of the RS-232 cable directly to the console port on the Switch, and tighten the captive retaining screws.
2. Connect the other end of the cable to a terminal or to the serial connector of a computer running terminal emulation software. Set the terminal emulation software as follows:
3. Select the appropriate serial port (COM port 1 or COM port 2).
4. Set the data rate to 115200 baud.
5. Set the data format to 8 data bits, 1 stop bit, and no parity.
6. Set flow control to none.
7. Under Properties, select VT100 for Emulation mode.
8. Select Terminal keys for Function, Arrow, and Ctrl keys. Ensure that you select Terminal keys (not Windows keys).

 **Note:** When you use HyperTerminal with the Microsoft® Windows® 2000 operating system, ensure that you have Windows 2000 Service Pack 2 or later installed. Windows 2000 Service Pack 2 allows you to use arrow keys in HyperTerminal's VT100 emulation. See www.microsoft.com for information on Windows 2000 service packs.

9. After you have correctly set up the terminal, plug the power cable into the power receptacle on the back of the Switch. The boot sequence appears in the terminal.
10. After the boot sequence completes, the console login screen displays.
11. If you have not logged into the command line interface (CLI) program, press the Enter key at the User name and password prompts. There is one default user name and password for the Switch. User names and passwords must first be created by the administrator. If you have previously set up user accounts, log in and continue to configure the Switch.
12. Enter the commands to complete your desired tasks. Many commands require administrator-level access privileges. Read the next section for more information on setting up user accounts. See the AT-9724TS Command Line Interface Reference Manual on the documentation CD for a list of all commands and additional information on using the CLI.
13. When you have completed your tasks, exit the session with the logout command or close the emulator program.

Make sure the terminal or PC you are using to make this connection is configured to match these settings.

If you are having problems making this connection on a PC, make sure the emulation is set to VT-100. You will be able to set the emulation by clicking on the **File** menu in your HyperTerminal window, clicking on **Properties** in the drop-down menu, and then clicking the **Settings** tab. This is where you will find the **Emulation** options. If you still do not see anything, try rebooting the Switch by disconnecting its power supply.

Once connected to the console, the screen below will appear on your console screen. This is where the user will enter commands to perform all the available management functions. The Switch will prompt the user to enter a user name and a password. Upon the initial connection, there is no user name or password and therefore just press enter twice to access the command line interface.

4-6 First Time Connecting to the Switch

The Switch supports user-based security that can allow you to prevent unauthorized users from accessing the Switch or changing its settings. This section tells how to log onto the Switch.

 **Note:** The passwords used to access the Switch are case-sensitive; therefore, "S" is not the same as "s."

When you first connect to the Switch, you will be presented with the first login screen (shown below).

 **Note:** Press Ctrl+R to refresh the screen. This command can be used at any time to force the console program in the Switch to refresh the console screen.



Figure 4- 1. Initial screen, first time connecting to the Switch

The initial username and password are:

Username: manager
Password: friend

You will be given access to the command prompt AT-9724TS:4# shown below.

```
AT-9724TS 24-Port 10/100/1000 Stackable Ethernet Switch
Command Line Interface

Firmware: Build 1.05
Copyright(C) 2004-2007 Allied Telesyn Inc. All rights reserved.

UserName:manager
Password:*****

AT-9724TS:4#_
```

Figure 4- 2. Command Prompt

 **Note:** The first user automatically gets Administrator level privileges. It is recommended to create at least one Admin-level user account for the Switch.

4-7 Password Protection

One of the first tasks when settings up the Switch is to create user accounts. If you log in using a predefined administrator-level user name, you have privileged access to the Switch's management software.

After your initial login, define new passwords for both default user names to prevent unauthorized access to the Switch, and record the passwords for future reference.

To create an administrator-level account for the Switch, do the following:

At the CLI login prompt, enter create account admin followed by the <user name> and press the **Enter** key.

You will be asked to provide a password.Type the <password> used for the administrator account being created and press the **Enter** key.

You will be prompted to enter the same password again to verify it.Type the same password and press the **Enter** key.

Successful creation of the new administrator account will be verified by a Success message.

 **Note:** Passwords are case sensitive. User names and passwords can be up to 15 characters in length.

The sample below illustrates a successful creation of a new administrator-level account with the user name "newmanager".

```
AT-9724TS:4#create account admin newmanager
Command: create account admin newmanager
Enter a case-sensitive new password:*****
Enter the new password again for confirmation:*****
Success.
AT-9724TS:4#
```

 **Caution:** CLI configuration commands only modify the running configuration file and are not saved when the Switch is rebooted.To save all your configuration changes in nonvolatile storage, you must use the save command to copy the running configuration file to the startup configuration.

4-8 SNMP Settings

Simple Network Management Protocol (SNMP) is an OSI Layer 7 (Application Layer) designed specifically for managing and monitoring network devices. SNMP enables network management stations to read and modify the settings of gateways, routers, switches, and other network devices. Use SNMP to configure system features for proper operation, monitor performance and detect potential problems in the Switch, switch group or network.

Managed devices that support SNMP include software (referred to as an agent), which runs locally on the device.A defined set of variables (managed objects) is maintained by the SNMP agent and used to manage the device.These objects are defined in a Management Information Base (MIB), which provides a standard presentation of the information controlled by the on-board SNMP agent. SNMP defines both the format of the MIB specifications and the protocol used to access this information over the network.

The AT-9724TS supports SNMP versions 1, 2c, and 3. You can specify which version of SNMP you want to use to monitor and control the Switch. The three versions of SNMP vary in the level of security provided between the management station and the network device.

In SNMP v.1 and v.2, user authentication is accomplished using 'community strings', which function like passwords. The remote user SNMP application and the Switch SNMP must use the same community string. SNMP packets from any station that has not been authenticated are ignored (dropped).

The default community strings for the Switch used for SNMP v.1 and v.2 management access are:

public – Allows authorized management stations to retrieve MIB objects.

private – Allows authorized management stations to retrieve and modify MIB objects.

SNMP v.3 uses a more sophisticated authentication process that is separated into two parts. The first part is to maintain a list of users and their attributes that are allowed to act as SNMP managers. The second part describes what each user on that list can do as an SNMP manager.

The Switch allows groups of users to be listed and configured with a shared set of privileges. The SNMP version may also be set for a listed group of SNMP managers. Thus, you may create a group of SNMP managers that are allowed to view read-only information or receive traps using SNMP v.1 while assigning a higher level of security to another group, granting read/write privileges using SNMP v.3.

Using SNMP v.3 individual users or groups of SNMP managers can be allowed to perform or be restricted from performing specific SNMP management functions. The functions allowed or restricted are defined using the Object Identifier (OID) associated with a specific MIB. An additional layer of security is available for SNMP v.3 in that SNMP messages may be encrypted. To read more about how to configure SNMP v.3 settings for the Switch read the section entitled Management.

Traps

Traps are messages that alert network personnel of events that occur on the Switch. The events can be as serious as a reboot (someone accidentally turned OFF the Switch), or less serious like a port status change. The Switch generates traps and sends them to the trap recipient (or network manager). Typical traps include trap messages for Authentication Failure, Topology Change and Broadcast/Multicast Storm.

MIBs

Management and counter information are stored by the Switch in the Management Information Base (MIB). The Switch uses the standard MIB-II Management Information Base module. Consequently, values for MIB objects can be retrieved from any SNMP-based network management software. In addition to the standard MIB-II, the Switch also supports its own proprietary enterprise MIB as an extended Management Information Base. The proprietary MIB may also be retrieved by specifying the MIB Object Identifier. MIB values can be either read-only or read-write.

4-9 IP Address Assignment

Each Switch must be assigned its own IP Address, which is used for communication with an SNMP network manager or other TCP/IP application (for example BOOTP, TFTP). The Switch's default IP address is 10.0.0.1. You can change the default Switch IP address to meet the specification of your networking address scheme.

The Switch is also assigned a unique MAC address by the factory. This MAC address cannot be changed, and can be found by entering the command "show switch" into the command line interface, as shown below.

```
Device Type      : AT-9724TS 24-Port 10/100/1000 Stackable Ethernet Switch
Unit ID         : 1
MAC Address      : 00-00-08-77-E6-00
IP Address       : 10.0.0.1 (Manual)
VLAN Name       : default
Subnet Mask      : 255.0.0.0
Default Gateway : 0.0.0.0
Boot PROM Version : Build 1.01
Firmware Version : Build 1.05
Hardware Version : 3R1
Device S/N      :
System Name     :
System Location  :
System Contact   :
Spanning Tree   : Disabled
GVRP            : Disabled
IGMP Snooping   : Disabled
RIP             : Disabled
DVMRP          : Disabled
PIN-CM         : Disabled
OSPF           : Disabled
TELNET         : Enabled (TCP 23)
[Ctrl-C] [F5] Quit [Space] Next Page [Enter] Next Entry [All]
```

Figure 4- 3. "show switch" command

The Switch's MAC address can also be found from the Web management program on the **Switch Information (Basic Settings)** window in the **Configuration** menu.

The IP address for the Switch must be set before it can be managed with the Web-based manager. The Switch IP address can be automatically set using BOOTP or DHCP protocols, in which case the actual address assigned to the Switch must be known.

The IP address may be set using the Command Line Interface (CLI) over the console serial port as follows:

Starting at the command line prompt, enter the commands **config ipif System ipaddress xxx.xxx.xxx.xxx/yyy.yyy.yyy.yyy**. Where the x's represent the IP address to be assigned to the IP interface named System and the y's represent the corresponding subnet mask.

Alternatively, you can enter **config ipif System ipaddress xxx.xxx.xxx.xxx/z**. Where the x's represent the IP address to be assigned to the IP interface named System and the z represents the corresponding number of subnets in CIDR notation.

The IP interface named System on the Switch can be assigned an IP address and subnet mask which can then be used to connect a management station to the Switch's Telnet or Web-based management agent.

```
AT-9724TS 24-Port 10/100/1000 Stackable Ethernet Switch
Command Line Interface

Firmware: Build 1.85
Copyright(C) 2004-2007 Allied Telesyn Inc. All rights reserved.

UserName:manager
Password:*****

AT-9724TS:4#config ipif System ipaddress 10.53.13.144/255.0.0.0
Command: config ipif System ipaddress 10.53.13.144/8

Success.

AT-9724TS:4#
```

Figure 4- 4.Assigning the Switch an IP Address

In the above example, the Switch was assigned an IP address of 10.53.13.144 with a subnet mask of 255.0.0.0. The system message **Success** indicates that the command was executed successfully. The Switch can now be configured and managed via Telnet and the CLI or via the Web-based management.

4-10 Connecting Devices to the Switch

After you assign IP addresses to the Switch, you can connect devices to the Switch.

To connect a device to an SFP transceiver port:

- Use your cabling requirements to select an appropriate SFP transceiver type.
- Insert the SFP transceiver (sold separately) into the SFP transceiver slot.
- Use the appropriate network cabling to connect a device to the connectors on the SFP transceiver.



Caution: When the SFP transceiver acquires a link, the associated integrated 10/100/1000T port is disabled.

Chapter 5 - Introduction to Web-based Switch Configuration

- 5-1 Introduction
- 5-2 Login to Web manager
- 5-3 Web-Based User Interface
- 5-4 Basic Setup
- 5-5 Reboot
- 5-6 Basic Switch Setup
- 5-7 Network Management
- 5-8 Switch Utilities
- 5-9 Network Monitoring
- 5-10 IGMP Snooping Status

5-1 Introduction

All software functions of the AT-9724TS can be managed, configured and monitored via the embedded web-based (HTML) interface. The Switch can be managed from remote stations anywhere on the network through a standard browser such as Netscape Navigator/Communicator or Microsoft Internet Explorer. The browser acts as a universal access tool and can communicate directly with the Switch using the HTTP protocol.

The Web-based management module and the Console program (and Telnet) are different ways to access the same internal switching software and configure it. Thus, all settings encountered in web-based management are the same as those found in the console program.

5-2 Login to Web Manager

To begin managing your Switch, simply run the browser you have installed on your computer and point it to the IP address you have defined for the device. The URL in the address bar should read something like: `http://123.123.123.123`, where the numbers 123 represent the IP address of the Switch.

 **Note:** The Factory default IP address for the Switch is 10.0.0.1.



Figure 5- 1. Login Button

This opens the management module's user authentication window, as seen below.

5-3 Web-based User Interface

The user interface provides access to various Switch configuration and management screens, allows you to view performance statistics, and permits you to graphically monitor the system status.

Areas of the User Interface

The figure below shows the user interface. The user interface is divided into 3 distinct areas as described in the table.

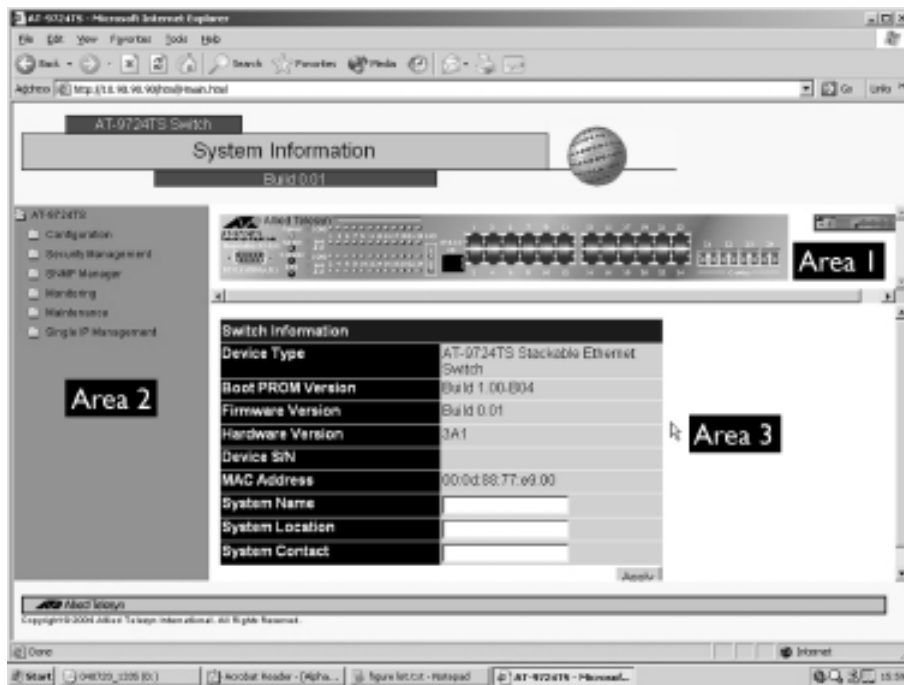

Figure 5- 2. Main Web-Manager Screen

Area	Function
1	Select the menu or window to be displayed. The folder icons can be opened to display the hyperlinked menu buttons and subfolders contained within them. Click the Allied Telesyn logo to go to the Allied Telesyn website.
2	Presents a graphical near real-time image of the front panel of the Switch. This area displays the Switch's ports and expansion modules, showing port activity, duplex mode, or flow control, depending on the specified mode. Various areas of the graphic can be selected for performing management functions, including port configuration.
3	Presents switch information based on your selection and the entry of configuration data.

Caution: Any changes made to the Switch configuration during the current session must be saved in the Save Changes web menu (explained below) or use the command line interface (CLI) command save.

Web Pages

Configurations – Contains screens concerning configurations for IP Address, Switch Information, Advanced Settings, Port Configuration, IGMP, Spanning Tree, Forwarding Filtering, VLANs, Port Bandwidth, SNMP Settings, Port Security, QoS, MAC Notification, LACP, Access Profile Table, System Log Servers, PAE Access Entity, and Layer 3 IP Networking.

Security Management – Contains screens concerning configurations for Security IP, User Accounts, Access Authentication Control (TACACS), Secure Sockets Layer (SSL), and Secure Shell (SSH).

SNMP Manager – Contains screens and windows concerning the implementation and upkeep of the SNMP Manager of the Switch.

Monitoring – Contains screens concerning monitoring the Switch, pertaining to Port Utilization, CPU Utilization, Packets, Errors Size, MAC Address, IGMP Snooping Group, IGMP Snooping Forwarding, VLAN Status, Router Port, Port Access Control and Layer 3 Feature.

Maintenance – Contains screens concerning configurations and information about Switch maintenance, including TFTP Services, CF Services, Dual Image Information, Switch History, Ping Test, Save Changes, Reboot Services and Logout.

Single IP Management – Contains screens concerning information on Single IP Management, including SIM Settings, Topology and Firmware/Configuration downloads.

 **Note:** Be sure to configure the user name and password in the User Accounts menu before connecting the Switch to the greater network.

Chapter 6 - Configuring The Switch

- 6-1 Switch Information
- 6-2 IP Address
- 6-3 Box Information
- 6-4 Advanced Settings
- 6-5 Port Configuration
- 6-6 Port Description
- 6-7 Port Mirroring
- 6-8 Link Aggregation
- 6-9 LACP Port Setting
- 6-10 MAC Notification
- 6-11 IGMP
- 6-12 Spanning Tree
- 6-13 Forward & Filtering
- 6-14 VLANs
- 6-15 Traffic Control
- 6-16 Port Security
- 6-17 Port Lock Entries
- 6-18 QoS
- 6-19 System Log Servers
- 6-20 SNMP Setting
- 6-21 Access Profile Table
- 6-22 Port Access Entity
- 6-23 Layer 3 IP Networking

6-1 Switch Information

The subsections below describe how to change some of the basic settings for the Switch such as changing IP settings and assigning user names and passwords for management access privileges, as well as how to save the changes and restart the Switch.

Click the **Switch Information** link in the **Configuration** menu.

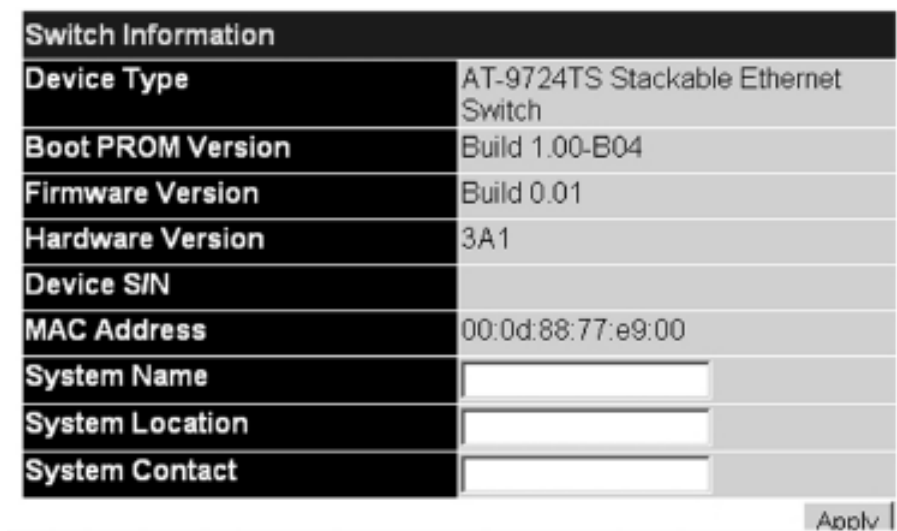

Switch Information	
Device Type	AT-9724TS Stackable Ethernet Switch
Boot PROM Version	Build 1.00-B04
Firmware Version	Build 0.01
Hardware Version	3A1
Device SIN	
MAC Address	00:0d:88:77:e9:00
System Name	<input type="text"/>
System Location	<input type="text"/>
System Contact	<input type="text"/>

Figure 6- 1. Switch Information – Basic Settings window

The **Switch Information** window shows the **Switch's MAC Address** (assigned by the factory and unchangeable), the **Boot PROM, Firmware Version, and Hardware Version**. This information is helpful to keep track of PROM and firmware updates and to obtain the Switch's MAC address for entry into another network device's address table, if necessary. The user may also enter a **System Name, System Location and System Contact** to aid in defining the Switch, to the user's preference.

6-2 IP Address

The IP Address may initially be set using the console interface prior to connecting to it through the Ethernet. If the Switch IP address has not yet been changed, read the introduction of the AT-9724TS Command Line Interface Reference Manual or return to Chapter 4 of this manual for more information.

To change IP settings using the web manager you must access the **IP Address** menu located in the **Configuration** folder.

To configure the Switch's IP address:

Open the **Configuration** folder and click the **IP Address** menu link. The web manager will display the Switch's current IP settings in the IP configuration menu, as seen below.

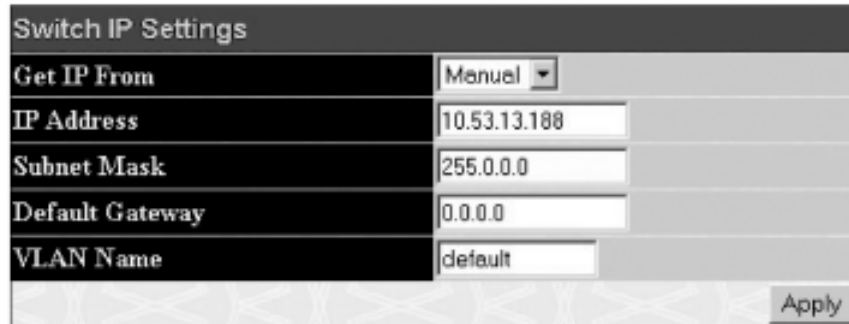

Parameter	Value
Get IP From	Manual
IP Address	10.53.13.100
Subnet Mask	255.0.0.0
Default Gateway	0.0.0.0
VLAN Name	default

Figure 6- 2. IP Address Settings window

To manually assign the Switch's IP address, subnet mask, and default gateway address:

1. Select *Manual* from the **Get IP From** drop-down menu.
2. Enter the appropriate **IP Address** and **Subnet Mask**.
3. If you want to access the Switch from a different subnet from the one it is installed on, enter the IP address of the **Default Gateway**. If you will manage the Switch from the subnet on which it is installed, you can leave the default address (0.0.0.0) in this field.
4. If no VLANs have been previously configured on the Switch, you can use the *default VLAN Name*. The *default VLAN* contains all of the Switch ports as members. If VLANs have been previously configured on the Switch, you will need to enter the *VLAN ID* of the VLAN that contains the port connected to the management station that will access the Switch. The Switch will allow management access from stations with the same VID listed here.

Note: The Switch's factory default IP address is 10.0.0.1 with a subnet mask of 255.0.0.0 and a default gateway of 0.0.0.0.

To use the BOOTP or DHCP protocols to assign the Switch an IP address, subnet mask, and default gateway address:

Use the **Get IP From:** <Manual> pull-down menu to choose from *BOOTP* or *DHCP*. This selects how the Switch will be assigned an IP address on the next reboot.

The IP Address Settings options are:

Parameter	Description
BOOTP	The Switch will send out a BOOTP broadcast request when it is powered up. The BOOTP protocol allows IP addresses, network masks, and default gateways to be assigned by a central BOOTP server. If this option is set, the Switch will first look for a BOOTP server to provide it with this information before using the default or previously entered settings.
DHCP	The Switch will send out a DHCP broadcast request when it is powered up. The DHCP protocol allows IP addresses, network masks, and default gateways to be assigned by a DHCP server. If this option is set, the Switch will first look for a DHCP server to provide it with this information before using the default or previously entered settings.
Manual	Allows the entry of an IP address, Subnet Mask, and a Default Gateway for the Switch. These fields should be of the form xxx.xxx.xxx.xxx, where each xxx is a number (represented in decimal form) between 0 and 255. This address should be a unique address on the network assigned for use by the network administrator.
Subnet Mask A	Bitmask that determines the extent of the subnet that the Switch is on. Should be of the form xxx.xxx.xxx.xxx, where each xxx is a number (represented in decimal) between 0 and 255. The value should be 255.0.0.0 for a Class A network, 255.255.0.0 for a Class B network, and 255.255.255.0 for a Class C network, but custom subnet masks are allowed.
Default Gateway	IP address that determines where packets with a destination address outside the current subnet should be sent. This is usually the address of a router or a host acting as an IP gateway. If your network is not part of an intranet, or you do not want the Switch to be accessible outside your local network, you can leave this field unchanged.

VLAN Name

This allows the entry of a VLAN Name from which a management station will be allowed to manage the Switch using TCP/IP (in-band via web manager or Telnet). Management stations that are on VLANs other than the one entered here will not be able to manage the Switch in-band unless their IP addresses are entered in the Security IP Management menu. If VLANs have not yet been configured for the Switch, the default VLAN contains all of the Switch's ports. There are no entries in the **Security IP Management** table, by default, so any management station that can connect to the Switch can access the Switch until a management VLAN is specified or **Management Station IP Addresses** are assigned.

Click **Apply** to let your changes take effect.

Setting the Switch's IP Address using the Console Interface

Each Switch must be assigned its own IP Address, which is used for communication with an SNMP network manager or other TCP/IP application (for example BOOTP, TFTP). The Switch's default IP address is 10.0.0.1. You can change the default Switch IP address to meet the specification of your networking address scheme.

The IP address for the Switch must be set before it can be managed with the Web-based manager. The Switch IP address can be automatically set using BOOTP or DHCP protocols, in which case the actual address assigned to the Switch must be known. The IP address may be set using the Command Line Interface (CLI) over the console serial port as follows:

Starting at the command line prompt, enter the commands `config ipif System ipaddress xxx.xxx.xxx.xxx/yyy.yyy.yyy.yyy`. Where the x's represent the IP address to be assigned to the IP interface named System and the y's represent the corresponding subnet mask.

Alternatively, you can enter `config ipif System ipaddress xxx.xxx.xxx.xxx/z`. Where the x's represent the IP address to be assigned to the IP interface named System and the z represents the corresponding number of subnets in CIDR notation.

The IP interface named System on the Switch can be assigned an IP address and subnet mask which can then be used to connect a management station to the Switch's Telnet or Web-based management agent.

The system message **Success** indicates that the command was executed successfully. The Switch can now be configured and managed via Telnet and the CLI or via the Web-based management agent using the above IP address to connect to the Switch.

Advanced Settings

The **Advanced Settings** window contains the main settings for all major functions for the Switch. To view the **Advanced Settings** window, click its link in the **Configuration** folder. This will enable the following window to be viewed and configured.

Switch Information (Advanced Settings)	
Serial Port Auto Logout	Never
Serial Port Baud Rate	115200
MAC Address Aging Time (10-1000000)	300
IGMP Snooping	Disabled
Multicast router Only	Disabled
GVRP Status	Disabled
Telnet Status	Enabled
Telnet TCP Port Number (1-65535)	23
Web Status	Enabled (TCP 80)
RMON Status	Disabled
Link Aggregation Algorithm	IP Source
Switch 802.1x	Disabled
Auth Protocol	Radius Eap
HOL Prevention	Enabled
Jumbo Frame	Disabled
Syslog state	Disabled

Figure 6- 3. Switch Information (Advanced Settings)

Parameter	Description
Serial Port Auto Logout Time	Select the logout time used for the console interface. This automatically logs the user out after an idle period of time, as defined. Choose from the following options: <i>2 Minutes</i> , <i>5 Minutes</i> , <i>10 Minutes</i> , <i>15 Minutes</i> or <i>Never</i> . The default setting is <i>10 minutes</i> .
Serial Port Baud Rate	This field specifies the baud rate for the serial port on the Switch. This field's menu is set at 115200 and cannot be changed.
MAC Address Aging Time (10-1000000)	This field specifies the length of time a learned MAC Address will remain in the forwarding table without being accessed (that is, how long a learned MAC Address is allowed to remain idle). The default age-out time for the Switch is 300 seconds. To change this, type in a different value representing the MAC address age-out time in seconds. The MAC Address Aging Time can be set to any value between 10 and 1,000,000 seconds. The default setting is <i>300 seconds</i> .
IGMP Snooping	To enable system-wide IGMP Snooping capability select <i>Enabled</i> . IGMP snooping is <i>Disabled</i> by default. Enabling IGMP snooping allows you to specify use of a multicast router only (see below). To configure IGMP Snooping for individual VLANs, use the IGMP Snooping page under the IGMP Snooping folder.
Multicast router Only	This field specifies that the Switch should only forward all multicast traffic to a multicast-enabled router, if enabled. Otherwise, the Switch will forward all multicast traffic to any IP router. The default is <i>Disabled</i> .
GVRP Status	Use this pull-down menu to enable or disable GVRP on the Switch.
Telnet Status	Telnet configuration is <i>Enabled</i> by default. If you do not want to allow configuration of the system through Telnet choose <i>Disabled</i> .
Telnet TCP Port Number (1-65535)	The TCP port number. TCP ports are numbered between 1 and 65535. The "well-known" TCP port for the Telnet protocol is 23.
Web Status	Web-based management is <i>Enabled</i> by default. If you choose to disable this by selecting <i>Disabled</i> , you will lose the ability to configure the system through the web interface as soon as these settings are applied.
RMON Status	Remote monitoring (RMON) of the Switch is <i>Enabled</i> or <i>Disabled</i> here.
Link Aggregation Algorithm	The algorithm that the Switch uses to balance the load across the ports that make up the port trunk group is defined by this definition. Choose <i>MAC Source</i> , <i>MAC Destination</i> , <i>MAC Src & Dest</i> , <i>IP Source</i> , <i>IP Destination</i> or <i>IP Src & Dest</i> (See the Link Aggregation section of this manual).
Switch 802.1x	The Switch's 802.1x function may be enabled by port or by MAC Address; the default is <i>Disabled</i> . This field must be enabled to view and configure certain windows for 802.1x. More information regarding 802.1x, its functions and implementation can be found later in this section, under the Port Access Entity folder. Port-Based 802.1x specifies that ports configured for 802.1x are initialized based on the port number only and are subject to any authorization parameters configured. MAC-based Authorization specifies that ports configured for 802.1x are initialized based on the port number and the MAC address of the computer being authorized and are then subject to any authorization parameters configured.
Auth Protocol	The user may use the pull down menu to choose between <i>radius eap</i> and <i>radius pap</i> for the 802.1x authentication protocol on the Switch. The default setting is <i>radius eap</i> .
HOL Prevention	This field will enable or disable Head of Line Prevention on the Switch. The default is <i>Enabled</i> .
Jumbo Frame	This field will enable or disable the Jumbo Frame function on the Switch. The default is <i>Disabled</i> .
Syslog State	Enables or disables Syslog State; default is <i>Disabled</i> .

Click **Apply** to implement changes made.

6.3 Box Information

The **Box Information Configuration** screen can be found in the **Configuration** folder under the heading **Box Information**. This window is used to configure the Master switch of a switch stack. The Master switch is the switch that will be used to configure the software applications regarding the switch stack.

Box Information	
Current Box ID	1
New Box ID	Auto
Box Type	AT-9724TS
Priority	16

Apply

Figure 6- 4. Box Information Configuration window

Parameter	Description
Current Box ID	The current Box ID of the Master switch in the stack.
New Box ID	The new box ID of the Master switch in the stack.
Box Type	The user may choose the model name of the Master switch in a stack to be the main configuring switch of that stack.
Priority	Displays the priority ID of the Switch. The lower the number, the higher the priority. The box (switch) with the lowest priority number in the stack is the Master switch.

Information configured in this screen may be found in the **Monitoring** folder under **Stack Information**.

6-4 Port Configuration

This section contains information for configuring various attributes and properties for individual physical ports, including port speed and address learning. Clicking on **Port Configurations** in the **Configuration** menu will display the following window for the user:

The screenshot shows a 'Port Configuration' window with a form at the top and a table below. The form has fields for Unit, From, To, State, Speed/Duplex, Flow Control, Learning, and an Apply button. The table below is titled 'The Port Information Table' and lists 24 ports with columns for Port, State, Speed/Duplex, Flow Control, Connection, and Learning.

Unit	From	To	State	Speed/Duplex	Flow Control	Learning	Apply
1	Port 1	Port 1	Disabled	Auto	Disabled	Disabled	Apply

Port	State	Speed/Duplex	Flow Control	Connection	Learning
1	Enabled	Auto	Disabled	Link Down	Enabled
2	Enabled	Auto	Disabled	Link Down	Enabled
3	Enabled	Auto	Disabled	Link Down	Enabled
4	Enabled	Auto	Disabled	Link Down	Enabled
5	Enabled	Auto	Disabled	Link Down	Enabled
6	Enabled	Auto	Disabled	Link Down	Enabled
7	Enabled	Auto	Disabled	Link Down	Enabled
8	Enabled	Auto	Disabled	Link Down	Enabled
9	Enabled	Auto	Disabled	Link Down	Enabled
10	Enabled	Auto	Disabled	Link Down	Enabled
11	Enabled	Auto	Disabled	Link Down	Enabled
12	Enabled	Auto	Disabled	Link Down	Enabled
13	Enabled	Auto	Disabled	Link Down	Enabled
14	Enabled	Auto	Disabled	Link Down	Enabled
15	Enabled	Auto	Disabled	Link Down	Enabled
16	Enabled	Auto	Disabled	Link Down	Enabled
17	Enabled	Auto	Disabled	Link Down	Enabled
18	Enabled	Auto	Disabled	Link Down	Enabled
19	Enabled	Auto	Disabled	Link Down	Enabled
20	Enabled	Auto	Disabled	Link Down	Enabled
21	Enabled	Auto	Disabled	Link Down	Enabled
22	Enabled	Auto	Disabled	Link Down	Enabled
23	Enabled	Auto	Disabled	1000M/FULL/None	Enabled
24	Enabled	Auto	Disabled	Link Down	Enabled

Figure 6- 5. Port Configuration and The Port Information Table window

To configure switch ports:

1. Choose the port or sequential range of ports using the **From...To...** port pull-down menus, and the **Unit** ID of the Switch to be configured.
2. Use the remaining pull-down menus to configure the parameters described below:

Parameter	Description
State	Toggle the State <Enabled> field to either enable or disable a given port or group of ports.
Speed/Duplex	<p>Toggle the Speed/Duplex field to either select the speed and duplex/half-duplex state of the port. <i>Auto</i> denotes auto-negotiation between 10 and 100Mbps devices, in full- or half-duplex. The <i>Auto</i> setting allows the port to automatically determine the fastest settings the device the port is connected to can handle, and then to use those settings. The other options are <i>Auto</i>, <i>10M/Half</i>, <i>10M/Full</i>, <i>100M/Half</i> and <i>100M/Full</i>, <i>1000M/Full_M</i> and <i>1000M/Full_S</i>. There is no automatic adjustment of port settings with any option other than <i>Auto</i>.</p> <p>The Switch allows the user to configure two types of gigabit connections; <i>1000M/Full_M</i> and <i>1000M/Full_S</i>. Gigabit connections are only supported in full duplex connections and take on certain characteristics that are different from the other choices listed.</p> <p>The <i>1000M/Full_M</i> (master) and <i>1000M/Full_S</i> (slave) parameters refer to connections running a 1000T cable for connection between the Switch port and other device capable of a gigabit connection. The master setting (<i>1000M/Full_M</i>) will allow the port to advertise capabilities related to duplex, speed and physical layer type. The master setting will also determine the master and slave relationship between the two connected physical layers. This relationship is necessary for establishing the timing control between the two physical layers. The timing control is set on a master physical layer by a local source. The slave setting (<i>1000M/Full_S</i>) uses loop timing, where the timing comes from a data stream received from the master. If one connection is set for <i>1000M/Full_M</i>, the other side of the connection must be set for <i>1000M/Full_S</i>. Any other configuration will result in a link down status for both ports.</p>
Flow Control	Displays the flow control scheme used for the various port configurations. Ports configured for full-duplex use 802.3x flow control, half-duplex ports use backpressure flow control, and <i>Auto</i> ports use an automatic selection of the two. The default is <i>Disabled</i> .
Learning	Enable or disable MAC address learning for the selected ports. When <i>Enabled</i> , destination and source MAC addresses are automatically listed in the forwarding table. When learning is <i>Disabled</i> , MAC addresses must be manually entered into the forwarding table. This is sometimes done for reasons of security or efficiency. See the section on Forwarding/Filtering for information on entering MAC addresses into the forwarding table. The default setting is <i>Disabled</i> .

Click **Apply** to implement the new settings on the Switch.

6-5 Port Description

The AT-9724TS supports a port description feature where the user may name various ports on the Switch. To assign names to various ports, click the **Port Description** on the **Configuration** menu:

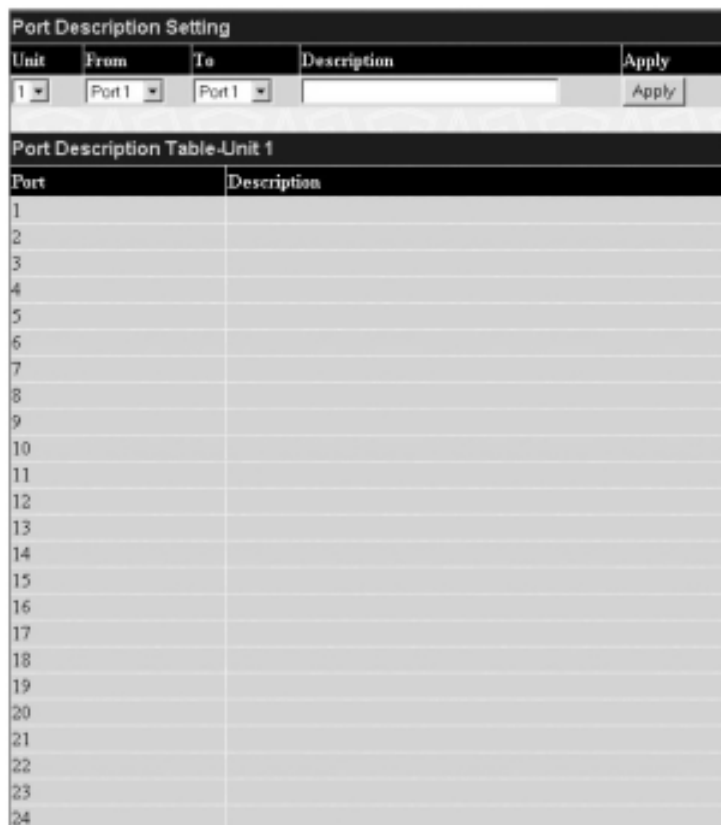

Figure 6- 6. Port Description Setting and Port Description Table window

Use the **From** and **To** pull down menu to choose a port or range of ports to describe and **Unit** to choose the Switch in the switch stack, and then enter a description of the port(s). Click **Apply** to set the descriptions in the **Port Description Table**.

6-6 Port Mirroring

The Switch allows you to copy frames transmitted and received on a port and redirect the copies to another port. You can attach a monitoring device to the mirrored port, such as a sniffer or an RMON probe, to view details about the packets passing through the first port. This is useful for network monitoring and troubleshooting purposes. To view the **Setup Port Mirroring** window, click **Port Mirroring** in the **Configuration** folder.

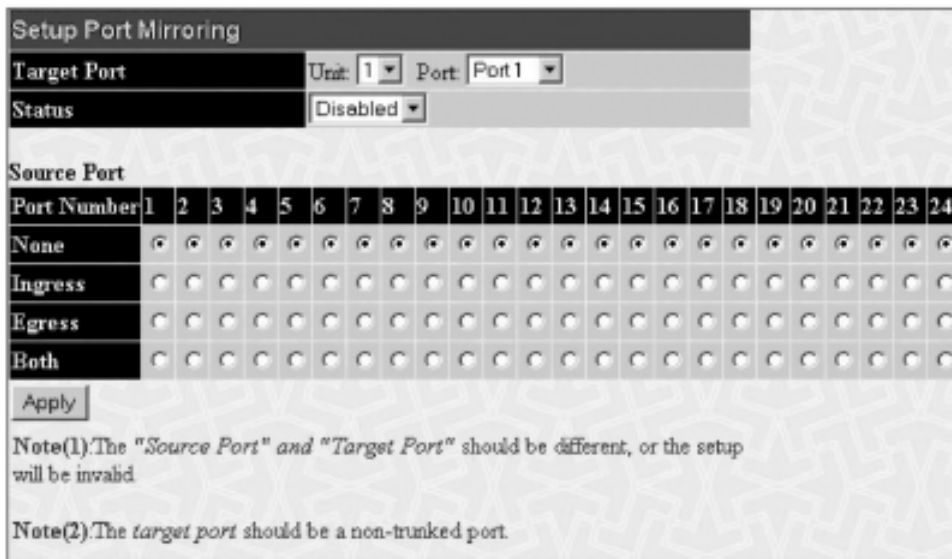

Figure 6- 7. Setup Port Mirroring window

To configure a mirror port:

- Select the **Source Port** from where you want to copy frames and the **Target Port**, which receives the copies from the source port.
- Select the **Source Direction, Ingress, Egress, or Both** and change the **Status** drop-down menu to **Enabled**.
- Click **Apply** to let the changes take effect.

Note: You cannot mirror a fast port onto a slower port. For example, if you try to mirror the traffic from a 100Mbps port onto a 10Mbps port, this can cause throughput problems. The port you are copying frames from should always support an equal or lower speed than the port to which you are sending the copies. Also, the target port for the mirroring cannot be a member of a trunk group. Please note a target port and a source port cannot be the same port.

6-7 Link Aggregation

Understanding Port Trunk Groups

Port trunk groups are used to combine a number of ports together to make a single high-bandwidth data pipeline.

The AT-9724TS supports up to 32 port trunk groups with 2 to 8 ports in each group. A potential bit rate of 8000Mbps can be achieved.

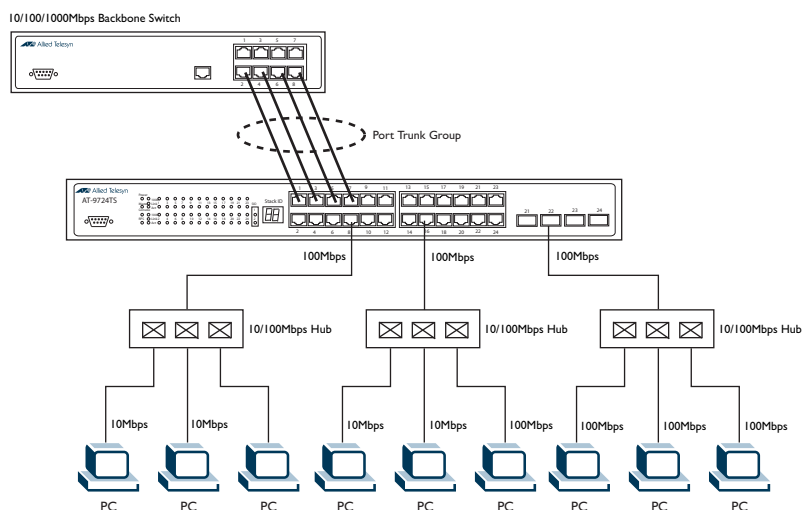



Figure 6- 8. Example of Port Trunk Group

The Switch treats all ports in a trunk group as a single port. Data transmitted to a specific host (destination address) will always be transmitted over the same port in a trunk group. This allows packets in a data stream to arrive in the same order they were sent.

 **Note:** If any ports within the trunk group become disconnected, packets intended for the disconnected port will be load shared among the other uplinked ports of the link aggregation group.

Link aggregation allows several ports to be grouped together and to act as a single link. This gives a bandwidth that is a multiple of a single link's bandwidth.

Link aggregation is most commonly used to link a bandwidth intensive network device or devices, such as a server, to the backbone of a network.

The Switch allows the creation of up to 32 link aggregation groups, each group consisting of 2 to 8 links (ports). All of the ports in the group must be members of the same VLAN, and their STP status, static multicast, traffic control, traffic segmentation and 802.1p default priority configurations must be identical. Port locking, port mirroring and 802.1X must not be enabled on the trunk group. Further, the aggregated links must all be of the same speed and should be configured as full-duplex.

The Master Port of the group is to be configured by the user, and all configuration options, including the VLAN configuration that can be applied to the Master Port, are applied to the entire link aggregation group.

Load balancing is automatically applied to the ports in the aggregated group, and a link failure within the group causes the network traffic to be directed to the remaining links in the group.

The Spanning Tree Protocol will treat a link aggregation group as a single link, on the switch level. On the port level, the STP will use the port parameters of the Master Port in the calculation of port cost and in determining the state of the link aggregation group. If two redundant link aggregation groups are configured on the Switch, STP will block one entire group, in the same way STP will block a single port that has a redundant link.

To configure port trunking, click on the **Link Aggregation** hyperlink in the **Configuration** folder to bring up the **Port Link Aggregation Group** table:

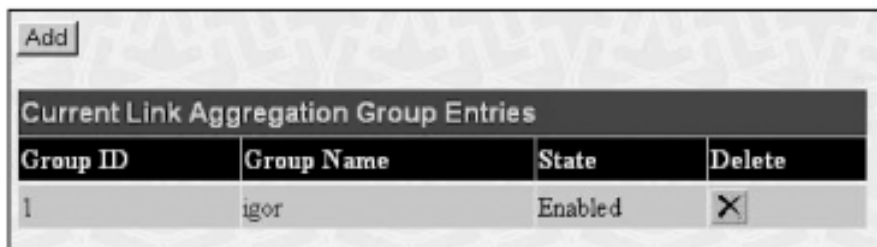

Current Link Aggregation Group Entries			
Group ID	Group Name	State	Delete
1	igor	Enabled	X

Figure 6- 9. Current Link Aggregation Group Entries window

To configure port trunk groups, click the **Add** button to add a new trunk group and use the **Link Aggregation Settings** menu (see example below) to set up trunk groups. To modify a port trunk group, click the hyperlinked group number corresponding to the entry you wish to alter. To delete a port trunk group, click the corresponding **X** under the **Delete** heading in the **Current Link Aggregation Group Entries** table.



Link Aggregation Group Configuration	
Group ID	0
Group Name	
Type	LACP
State	Disabled
Master Port	1 Port 1
Choose Member Ports	1 2 3 4 5 6 7 8 9 10 11 12 13 14 15 16 17 18 19 20 21 22 23 24
Flooding Port	X
Apply	
<p>Note(1): It is only valid to set up at most 8 member ports of any one trunk group and a port can be a member of only one trunk group at a time.</p> <p>Show All Link Aggregation Group Entries</p>	

Figure 6- 10. Link Aggregation Group Configuration window – Add

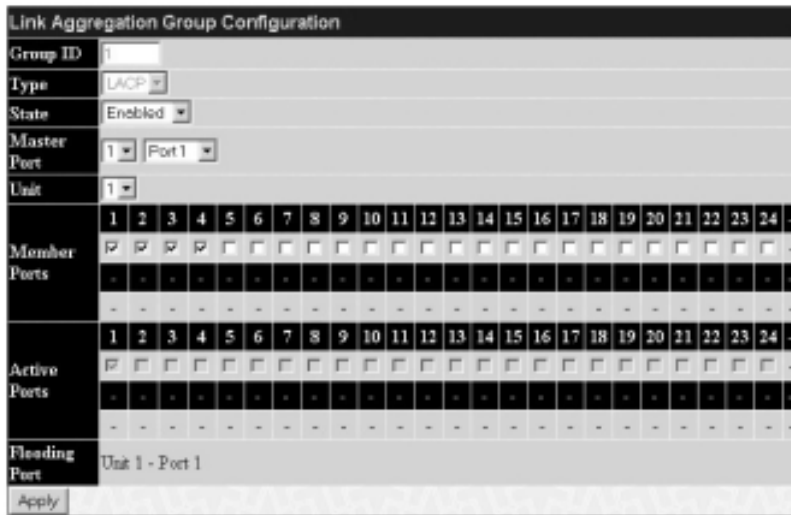

Figure 6- 11. Link Aggregation Group Configuration window – Modify

The user-changeable parameters are as follows:

Parameter	Description
Group ID	Select an ID number for the group, between 1 and 32.
State	Trunk groups can be toggled between <i>Enabled</i> and <i>Disabled</i> . This is used to turn a port trunking group on or off. This is useful for diagnostics, to quickly isolate a bandwidth intensive network device or to have an absolute backup aggregation group that is not under automatic control.
Master Port	Choose the Master Port for the trunk group using the pull down menu.
Member Ports	Choose the members of a trunked group. 2 to 8 ports can be assigned to an individual group.
Flooding Port	A trunking group must designate one port to allow transmission of broadcasts and unknown unicasts.
Active Port	Shows the port that is currently forwarding packets.
Type	This pull-down menu allows you to select between <i>Static</i> and <i>LACP</i> (Link Aggregation Control Protocol). LACP allows for the automatic detection of links in a Port Trunking Group.

After setting the previous parameters, click **Apply** to allow your changes to be implemented. Successfully created trunk groups will be show in the **Current Link Aggregation Group Entries**.

6-8 LACP Port Setting

The **LACP Port Setting** window is used in conjunction with the **Link Aggregation** window to create port trunking groups on the Switch. Using the following window, the user may set which ports will be active and passive in processing and sending LACP control frames.

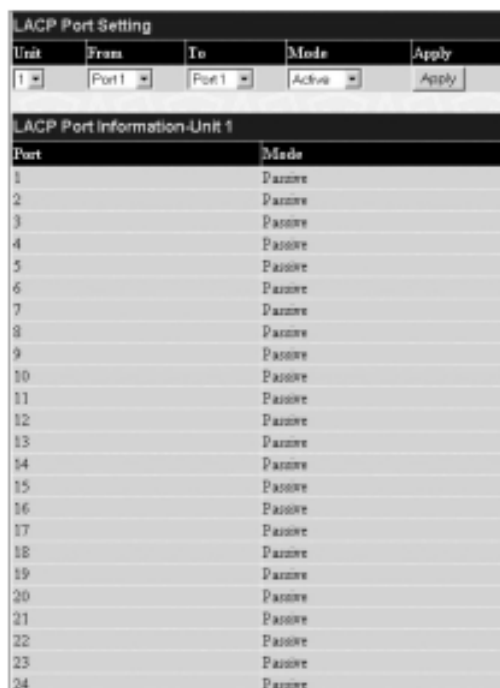

Figure 6- 12. LACP Port Setting and LACP Port Information window

The user may set the following parameters:

Parameter	Description
Unit	Choose the switch in the switch stack to be configured by using the pull-down menu.
From/To	A consecutive group of ports may be configured starting with the selected port.
Mode	<p><i>Active</i> – Active LACP ports are capable of processing and sending LACP control frames. This allows LACP compliant devices to negotiate the aggregated link so the group may be changed dynamically as needs require. In order to utilize the ability to change an aggregated port group, that is, to add or subtract ports from the group, at least one of the participating devices must designate LACP ports as active. Both devices must support LACP.</p> <p><i>Passive</i> – LACP ports that are designated as passive cannot initially send LACP control frames. In order to allow the linked port group to negotiate adjustments and make changes dynamically, one end of the connection must have "active" LACP ports (see above).</p>

After setting the previous parameters, click **Apply** to allow your changes to be implemented. The **LACP Port Table** shows which ports are active and/or passive.

6-9 MAC Notification

MAC Notification is used to monitor MAC addresses learned and entered into the forwarding database.

MAC Notification Global Settings

To globally set MAC notification on the Switch, open the following screen by opening the **MAC Notification** folder and clicking the **MAC Notification Global Settings** link:

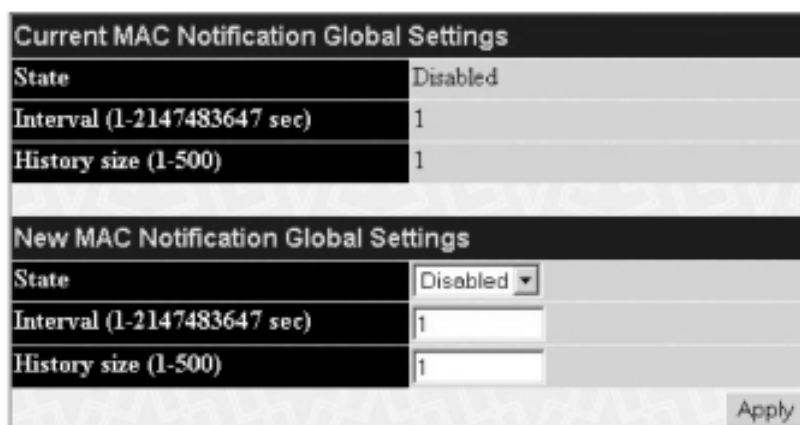

Figure 6- 13. Current and New MAC Notification Global Settings window

The following parameters may be modified:

Parameter	Description
State	Enable or disable MAC notification globally on the Switch. The default setting is <i>Disabled</i> .
Interval (sec)	The user may set the time, between 1 and 2,147,483,647 seconds, between MAC notifications. The default setting is 1 second.
History size	The maximum number of entries listed in the history log used for notification. Up to 500 entries can be specified. The default setting is 1.

Current MAC notification configurations can be viewed in the **Current MAC Notification Global Settings** window, as seen above.

MAC Notification Port Settings

To change MAC notification settings for a port or group of ports on the Switch, click **Port Settings** in the **MAC Notification** folder, which will display the following screen:

Unit	From	To	State	Apply
1	Port 1	Port 1	Disabled	Apply

MAC Notification Port State Table-Unit 1	
Port	State
1	Disabled
2	Disabled
3	Disabled
4	Disabled
5	Disabled
6	Disabled
7	Disabled
8	Disabled
9	Disabled
10	Disabled
11	Disabled
12	Disabled
13	Disabled
14	Disabled
15	Disabled
16	Disabled
17	Disabled
18	Disabled
19	Disabled
20	Disabled
21	Disabled
22	Disabled
23	Disabled
24	Disabled

Figure 6- 14. MAC Notification Port Settings and Port State Table

The following parameters may be set:

Parameter	Description
Unit	Choose the Switch ID number of the Switch in the switch stack to be modified.
From...To	Select a port or group of ports to enable for MAC notification using the pull down menus.
State	Enable MAC Notification for the ports selected using the pull down menu.

Click **Apply** to implement changes made.

6-10 IGMP

Computers and network devices that want to receive multicast transmissions need to inform nearby routers that they will become members of a multicast group. The **Internet Group Management Protocol (IGMP)** is used to communicate this information. IGMP is also used to periodically check the multicast group for members that are no longer active.

In the case where there is more than one multicast router on a subnetwork, one router is elected as the 'querier'. This router then keeps track of the membership of the multicast groups that have active members. The information received from IGMP is then used to determine if multicast packets should be forwarded to a given subnetwork or not. The router can check, using IGMP, to see if there is at least one member of a multicast group on a given subnetwork. If there are no members on a subnetwork, packets will not be forwarded to that subnetwork.

IGMP Versions 1 and 2

Multicast groups allow members to join or leave at any time. IGMP provides the method for members and multicast routers to communicate when joining or leaving a multicast group.

IGMP version 1 is defined in RFC 1112. It has a fixed packet size and no optional data.

The format of an IGMP packet is shown below:

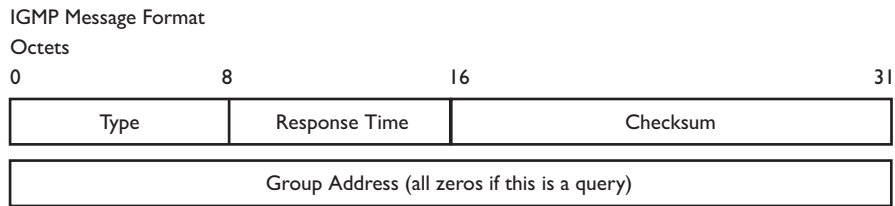

Figure 6- 15. IGMP Message Format

The IGMP Type codes are shown below:

Type	Meaning
0x11	Membership Query (if Group Address is 0.0.0.0)
0x11	Specific Group Membership Query (if Group Address is Present)
0x16	Membership Report (version 2)
0x17	Leave a Group (version 2)
0x12	Membership Report (version 1)

Table 6- 1. IGMP Type Codes

IGMP packets enable multicast routers to keep track of the membership of multicast groups, on their respective subnetworks. The following outlines what is communicated between a multicast router and a multicast group member using IGMP.

A host sends an IGMP “report” to join a group.

A host will never send a report when it wants to leave a group (for version 1).

A host will send a “leave” report when it wants to leave a group (for version 2).

Multicast routers send IGMP queries (to the all-hosts group address: 224.0.0.1) periodically to see whether any group members exist on their subnetworks. If there is no response from a particular group, the router assumes that there are no group members on the network.

The Time-to-Live (TTL) field of query messages is set to 1 so that the queries will not be forwarded to other subnetworks.

IGMP version 2 introduces some enhancements such as a method to elect a multicast querier for each LAN, an explicit leave message, and query messages that are specific to a given group.

The states a computer will go through to join or to leave a multicast group are shown below:

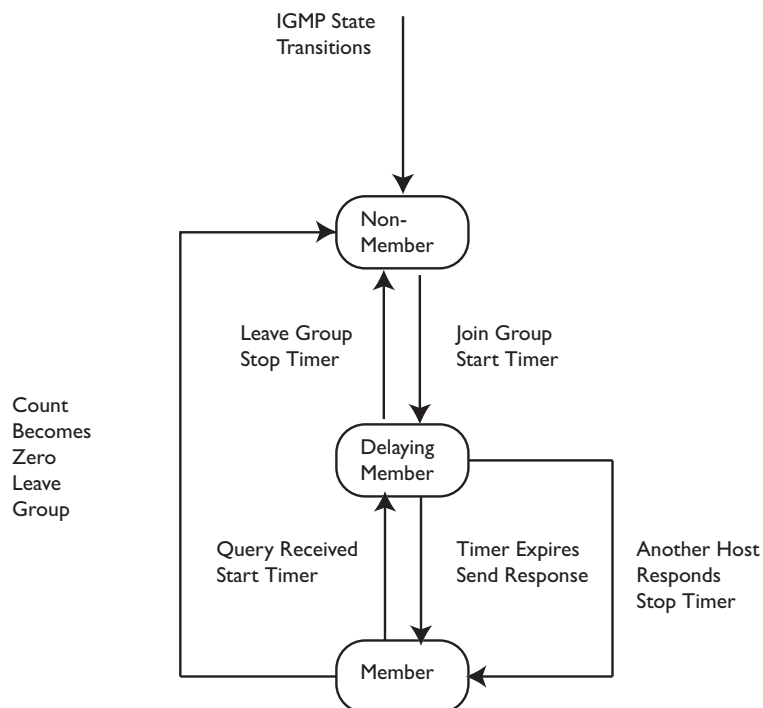

Figure 6- 16. IGMP State Transitions

IGMP Snooping

Internet Group Management Protocol (IGMP) snooping allows the Switch to recognize IGMP queries and reports sent between network stations or devices and an IGMP host. When enabled for IGMP snooping, the Switch can open or close a port to a specific device based on IGMP messages passing through the Switch.

In order to use IGMP Snooping it must first be enabled for the entire Switch (see **Advanced Settings**). You may then fine-tune the settings for each VLAN using the **IGMP Snooping** link in the **Configuration** folder. When enabled for IGMP snooping, the Switch can open or close a port to a specific Multicast group member based on IGMP messages sent from the device to the IGMP host or vice versa. The Switch monitors IGMP messages and discontinues forwarding multicast packets when there are no longer hosts requesting that they continue. Use the **IGMP Snooping Group Entry Table** to view IGMP Snooping status. To modify settings, click the **Modify** button for the VLAN Name entry you want to change.

Use the **Current IGMP Snooping Group Entries** window to view **IGMP Snooping** settings. To modify settings, click the **Modify** button for the VLAN ID you want to change.

Current IGMP Snooping Group Entries				
VLAN ID	VLAN Name	State	Querier State	Modify
1	default	Disabled	Disabled	<input type="button" value="Modify"/>
4094	Trinity	Disabled	Disabled	<input type="button" value="Modify"/>

Figure 6- 17. Current IGMP Snooping Group Entries

Clicking the **Modify** button will open the **IGMP Snooping Settings** menu, shown below:

IGMP Snooping Settings	
VLAN ID	<input type="text" value="1"/>
VLAN Name	<input type="text" value="default"/>
Query Interval (1-65535 sec)	<input type="text" value="125"/>
Max Response Time (1-25 sec)	<input type="text" value="10"/>
Robustness Value (1-255)	<input type="text" value="2"/>
Last Member Query Interval (1-25 sec)	<input type="text" value="1"/>
Host Timeout (1-16711450 sec)	<input type="text" value="260"/>
Router Timeout (1-16711450 sec)	<input type="text" value="260"/>
Leave Timer (1-16711450 sec)	<input type="text" value="2"/>
Querier State	<input type="text" value="Disabled"/>
Querier Router Behavior	Non-Querier
State	<input type="text" value="Disabled"/>

Figure 6- 18. IGMP Snooping Settings window

The following parameters may be viewed or modified:

Parameter	Description
VLAN ID	This is the VLAN ID that, along with the VLAN Name , identifies the VLAN the user wishes to modify the IGMP Snooping Settings for.
VLAN Name	This is the VLAN Name that, along with the VLAN ID , identifies the VLAN the user wishes to modify the IGMP Snooping Settings for.
Query Interval	The Query Interval field is used to set the time (in seconds) between transmitting IGMP queries. Entries between 1 and 65535 seconds are allowed. Default = 125.
Max Response Time	This determines the maximum amount of time in seconds allowed before sending an IGMP response report. The Max Response Time field allows an entry between 1 and 25 (seconds). Default = 10.

Robustness Value	Adjust this variable according to expected packet loss. If packet loss on the VLAN is expected to be high, the Robustness Variable should be increased to accommodate increased packet loss. This entry field allows an entry of 1 to 255. Default = 2.
Last Member Query Interval	This field specifies the maximum amount of time between group-specific query messages, including those sent in response to leave group messages. Default = 1.
Host Timeout	This is the maximum amount of time in seconds allowed for a host to continue membership in a multicast group without the Switch receiving a host membership report. Default = 260.
Router Timeout	This is the maximum amount of time in seconds a route is kept in the forwarding table without receiving a membership report. Default = 260.
Leave Timer	This specifies the maximum amount of time in seconds between the Switch receiving a leave group message from a host, and the Switch issuing a group membership query. If no response to the membership query is received before the Leave Timer expires, the (multicast) forwarding entry for that host is deleted.
Querier State	Choose <i>Enabled</i> to enable transmitting IGMP Query packets or Disabled to disable. The default is <i>Disabled</i> .
Querier Router Behavior	This read-only field describes the behavior of the router for sending query packets. <i>Querier</i> will denote that the router is sending out IGMP query packets. <i>Non-Querier</i> will denote that the router is not sending out IGMP query packets. This field will only read <i>Querier</i> when the Querier State and the State fields have been Enabled.
State	Select <i>Enabled</i> to implement IGMP Snooping. This field is <i>Disabled</i> by default.

Click **Apply** to implement the new settings. Click the [Show All IGMP Group Entries](#) link to return to the **Current IGMP Snooping Group Entries** window.

Static Router Ports

A static router port is a port that has a multicast router attached to it. Generally, this router would have a connection to a WAN or to the Internet. Establishing a router port will allow multicast packets coming from the router to be propagated through the network, as well as allowing multicast messages (IGMP) coming from the network to be propagated to the router.

A router port has the following behavior:

- All IGMP Report packets will be forwarded to the router port.
- IGMP queries (from the router port) will be flooded to all ports.
- All UDP multicast packets will be forwarded to the router port. Because routers do not send IGMP reports or implement IGMP snooping, a multicast router connected to the router port of a Layer 3 switch would not be able to receive UDP data streams unless the UDP multicast packets were all forwarded to the router port.

A router port will be dynamically configured when IGMP query packets, RIPv2 multicast, DVMRP multicast or PIM-DM multicast packets are detected flowing into a port.

Open the **IGMP** folder and click on the **Static Router Ports Entry** link to open the **Current Static Router Ports Entries** page, as shown below.

Current Static Router Ports Entries		
VLAN ID	VLAN Name	Modify
1	default	Modify

Figure 6- 19. Current Static Router Ports Entries window

The **Current Static Router Ports Entries** page (shown above) displays all of the current entries to the Switch's static router port table. To modify an entry, click the **Modify** button. This will open the **Static Router Ports Settings** page, as shown below.

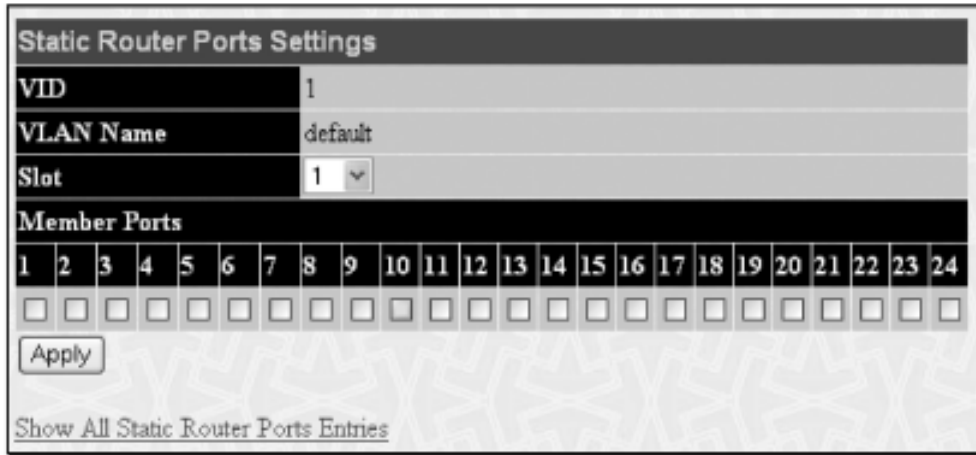

Figure 6- 20. Static Router Ports Settings window

The following parameters can be set:

Parameter	Description
VID (VLAN ID)	This is the VLAN ID that, along with the VLAN Name, identifies the VLAN where the multicast router is attached.
VLAN Name	This is the name of the VLAN where the multicast router is attached.
Unit	Choose the Switch ID number of the Switch in the switch stack to be modified.
Member Ports	These are the ports on the Switch that will have a multicast router attached to them.

Click **Apply** to implement the new settings, click the [Show All Static Router Port Entries](#) link to return to the **Current Static Router Port Entries** window.

6.11 Spanning Tree

This Switch supports three versions of the Spanning Tree Protocol; 802.1d STP, 802.1w Rapid STP and 802.1s MSTP. 802.1d STP will be familiar to most networking professionals. However, since 802.1w RSTP and 802.1s MSTP has been recently introduced to Allied Telesyn managed Ethernet switches, a brief introduction to the technology is provided below followed by a description of how to set up 802.1d STP, 802.1w RSTP and 802.1s MSTP.

802.1s MSTP

Multiple Spanning Tree Protocol, or MSTP, is a standard defined by the IEEE community that allows multiple VLANs to be mapped to a single spanning tree instance, which will provide multiple pathways across the network. Therefore, these MSTP configurations will balance the traffic load, preventing wide scale disruptions when a single spanning tree instance fails. This will allow for faster convergences of new topologies for the failed instance. Frames designated for these VLANs will be processed quickly and completely throughout interconnected bridges utilizing either of the three spanning tree protocols (STP, RSTP or MSTP).

This protocol will also tag BDPUs packets so receiving devices can distinguish spanning tree instances, spanning tree regions and the VLANs associated with them. These instances will be classified by an MSTI ID. MSTP will connect multiple spanning trees with a Common and Internal Spanning Tree (CIST). The CIST will automatically determine each MSTP region, its maximum possible extent and will appear as one virtual bridge that runs a single spanning tree. Consequentially, frames assigned to different VLANs will follow different data routes within administratively established regions on the network, continuing to allow simple and full processing of frames, regardless of administrative errors in defining VLANs and their respective spanning trees.

Each switch utilizing the MSTP on a network will have a single MSTP configuration that will have the following three attributes:

1. A configuration name defined by an alphanumeric string of up to 32 characters (defined in the **MST Configuration Table** window in the **Configuration Name** field).
2. A configuration revision number (named here as a **Revision Level** and found in the **MST Configuration Table** window) and;
3. A 4096 element table (defined here as a **VID List** in the **MST Configuration Table** window) which will associate each of the possible 4096 VLANs supported by the Switch for a given instance.

To utilize the MSTP function on the Switch, three steps need to be taken:

1. The Switch must be set to the MSTP setting (found in the **STP Bridge Global Settings** window in the **STP Version** field).
2. The correct spanning tree priority for the MSTP instance must be entered (defined here as a **Priority** in the **STP Instance Settings** window when configuring an **MSTI ID** settings).
3. VLANs that will be shared must be added to the **MSTP Instance ID** (defined here as a **VID List** in the **MST Configuration Table** window when configuring an MSTI ID settings).

802.1w Rapid Spanning Tree

The Switch implements three versions of the Spanning Tree Protocol, the Multiple Spanning Tree Protocol (MSTP) as defined by the IEEE 802.1s, the Rapid Spanning Tree Protocol (RSTP) as defined by the IEEE 802.1w specification and a version compatible with the IEEE 802.1d STP. RSTP can operate with legacy equipment implementing IEEE 802.1d, however the advantages of using RSTP will be lost.

The IEEE 802.1w Rapid Spanning Tree Protocol (RSTP) evolved from the 802.1d STP standard. RSTP was developed in order to overcome some limitations of STP that impede the function of some recent switching innovations, in particular, certain Layer 3 functions that are increasingly handled by Ethernet switches. The basic function and much of the terminology is the same as STP. Most of the settings configured for STP are also used for RSTP. This section introduces some new Spanning Tree concepts and illustrates the main differences between the two protocols.

Port Transition States

An essential difference between the three protocols is in the way ports transition to a forwarding state and in the way this transition relates to the role of the port (forwarding or not forwarding) in the topology. MSTP and RSTP combine the transition states disabled, blocking and listening used in 802.1d and creates a single state Discarding. In either case, ports do not forward packets. In the STP port transition states disabled, blocking or listening or in the RSTP/MSTP port state discarding, there is no functional difference, the port is not active in the network topology. Table 6-1 below compares how the three protocols differ regarding the port state transition.

All three protocols calculate a stable topology in the same way. Every segment will have a single path to the root bridge. All bridges listen for BPDU packets. However, BPDU packets are sent more frequently – with every Hello packet. BPDU packets are sent even if a BPDU packet was not received. Therefore, each link between bridges is sensitive to the status of the link. Ultimately this difference results in faster detection of failed links, and thus faster topology adjustment. A draw-back of 802.1d is this absence of immediate feedback from adjacent bridges.

802.1d MSTP	802.1w RSTP	802.1d STP	Forwarding	Learning
Discarding	Discarding	Disabled	No	No
Discarding	Discarding	Blocking	No	No
Discarding	Discarding	Listening	No	No
Learning	Learning	Learning	No	Yes
Forwarding	Forwarding	Forwarding	Yes	Yes

Table 6- 2. Comparing Port States

RSTP is capable of a more rapid transition to a forwarding state – it no longer relies on timer configurations – RSTP compliant bridges are sensitive to feedback from other RSTP compliant bridge links. Ports do not need to wait for the topology to stabilize before transitioning to a forwarding state. In order to allow this rapid transition, the protocol introduces two new variables: the edge port and the point-to-point (P2P) port.

Edge Port

The edge port is a configurable designation used for a port that is directly connected to a segment where a loop cannot be created. An example would be a port connected directly to a single workstation. Ports that are designated as edge ports transition to a forwarding state immediately without going through the listening and learning states. An edge port loses its status if it receives a BPDU packet, immediately becoming a normal spanning tree port.

P2P Port

A P2P port is also capable of rapid transition. P2P ports may be used to connect to other bridges. Under RSTP/MSTP, all ports operating in full-duplex mode are considered to be P2P ports, unless manually overridden through configuration.

802.1d / 802.1w / 802.1s Compatibility

MSTP or RSTP can interoperate with legacy equipment and is capable of automatically adjusting BPDU packets to 802.1d format when necessary. However, any segment using 802.1d STP will not benefit from the rapid transition and rapid topology change detection of MSTP or RSTP. The protocol also provides for a variable used for migration in the event that legacy equipment on a segment is updated to use RSTP or MSTP.

The Spanning Tree Protocol (STP) operates on two levels:

1. On the switch level, the settings are globally implemented.
2. On the port level, the settings are implemented on a per user-defined group of ports basis.

STP Bridge Global Settings

To open the following window, open the **Spanning Tree** folder in the **Configuration** menu and click the **STP Bridge Global Settings** link.

STP Bridge Global Settings	
STP Status	Enabled ▾
STP Version	STP compatible ▾
Hello Time(1-10 Sec)	2
Max Age(6-40 Sec)	20
Forward Delay(4-30 Sec)	15
Max Hops(1-20)	20
TX Hold Count(1-10)	3
Forwarding BPDU	Enabled ▾
Apply	

Figure 6- 21. STP Bridge Global Settings – STP compatible

STP Bridge Global Settings	
STP Status	Enabled ▾
STP Version	RSTP ▾
Hello Time(1-10 Sec)	2
Max Age(6-40 Sec)	20
Forward Delay(4-30 Sec)	15
Max Hops(1-20)	20
TX Hold Count(1-10)	3
Forwarding BPDU	Enabled ▾
Apply	

Figure 6- 22. STP Bridge Global Settings – RSTP (default)

STP Bridge Global Settings	
STP Status	Enabled ▾
STP Version	MSTP ▾
Max Age(6-40 Sec)	20
Forward Delay(4-30 Sec)	15
Max Hops(1-20)	20
TX Hold Count(1-10)	3
Forwarding BPDU	Enabled ▾
Apply	

Figure 6- 23. STP Bridge Global Settings

The following parameters can be set:

Parameter	Description
STP Status	Use the pull-down menu to enable or disable STP globally on the Switch. The default is <i>Disabled</i> .
STP Version	Use the pull-down menu to choose the desired version of STP to be implemented on the Switch. There are three choices: <i>STP</i> – Select this parameter to set the Spanning Tree Protocol (STP) globally on the switch. <i>RSTP</i> – Select this parameter to set the Rapid Spanning Tree Protocol (RSTP) globally on the Switch. <i>MSTP</i> – Select this parameter to set the Multiple Spanning Tree Protocol (MSTP) globally on the Switch.
Hello Time: (1-10 sec)	The Hello Time can be set from 1 to 10 seconds. This is the interval between two transmissions of BPDU packets sent by the Root Bridge to tell all other switches that it is indeed the Root Bridge. This field will only appear here when STP or RSTP is selected for the STP Version. For MSTP, the Hello Time must be set on a port per port basis. See the MST Port Settings section for further details.
Max Age: (6 - 40 sec)	The Max Age may be set to ensure that old information does not endlessly circulate through redundant paths in the network, preventing the effective propagation of the new information. Set by the Root Bridge, this value will aid in determining that the Switch has spanning tree configuration values consistent with other devices on the bridged LAN. If the value ages out and a BPDU has still not been received from the Root Bridge, the Switch will start sending its own BPDU to all other switches for permission to become the Root Bridge. If it turns out that your switch has the lowest Bridge Identifier, it will become the Root Bridge. The user may choose a time between 6 and 40 seconds. The default value is 20.
Forward Delay: (4 – 30 sec)	The Forward Delay can be from 4 to 30 seconds. Any port on the Switch spends this time in the listening state while moving from the blocking state to the forwarding state.
Max Hops (1-20)	Used to set the number of hops between devices in a spanning tree region before the BPDU (bridge protocol data unit) packet sent by the Switch will be discarded. Each switch on the hop count will reduce the hop count by one until the value reaches zero. The Switch will then discard the BPDU packet and the information held for the port will age out. The user may set a hop count from 1 to 20. The default is 20.
TX Hold Count (1-10)	Used to set the maximum number of Hello packets transmitted per interval. The count can be specified from 1 to 10. The default is 3.
Forwarding BPDU	This field can be <i>Enabled</i> or <i>Disabled</i> . When <i>Enabled</i> , it allows the forwarding of STP BPDU packets from other network devices. The default is <i>Enabled</i> .

Click **Apply** to implement changes made.

 **Note:** The Hello Time cannot be longer than the Max.Age. Otherwise, a configuration error will occur. Observe the following formulas when setting the above parameters:

$$\text{Max.Age} \leq 2 \times (\text{Forward Delay} - 1 \text{ second})$$

$$\text{Max.Age} \leq 2 \times (\text{Hello Time} + 1 \text{ second})$$

MST Configuration Table

The following screens in the **MST Configuration Table** window allow the user to configure a MSTI instance on the Switch. These settings will uniquely identify a multiple spanning tree instance set on the Switch. The Switch initially possesses one *CIST* or Common Internal Spanning Tree of which the user may modify the parameters for but cannot change the MSTI ID for, and cannot be deleted. To view the **Current MST Configuration Identification** window, click **Configuration > Spanning Tree > MST Configuration Table**:

Current MST Configuration Identification		
Configuration Name	Revision Level	
00:0D:88:77:E9:00	0	
MSTI ID	VID List	Delete
CIST	1-4094	<input type="button" value="X"/>

MST Configuration Identification Settings	
Configuration Name	<input type="text" value="00:0D:88:77:E9:00"/>
Revision Level(0-65535)	<input type="text" value="0"/>

Figure 6- 24. Current MST Configuration Identification window

The window above contains the following information:

Parameter	Description
Configuration Name	A previously configured name set on the Switch to uniquely identify the MSTI (Multiple Spanning Tree Instance). If a configuration name is not set, this field will show the MAC address to the device running MSTP.
Revision Level	This value, along with the Configuration Name will identify the MSTP region configured on the Switch.
MSTI ID	This field shows the MSTI IDs currently set on the Switch. This field will always have the CIST MSTI, which may be configured but not deleted. Clicking the hyperlinked name will open a new window for configuring parameters associated with that particular MSTI.
VID List	This field displays the VLAN IDs associated with the specific MSTI.

To delete a previously set MSTI Instance ID, click the corresponding **X** under the **Delete** heading in the **Current MST Configuration Identification** window. Clicking the **Add** button will reveal the following window to configure:

Figure 6- 25. Instance ID Settings window – Add

The user may configure the following parameters to create a MSTI in the Switch.

Parameter	Description
MSTI ID	Enter a number between 1 and 15 to set a new MSTI on the Switch.
Type	Create is selected to create a new MSTI. No other choices are available for this field when creating a new MSTI.
VID List (1-4094)	This field is used to specify the VID range from configured VLANs set on the Switch. Supported VIDs on the Switch range from ID number 1 to 4094.

Click **Apply** to implement changes made.

To configure the settings for the CIST, click on its hyperlinked **MSTI ID** number in the **Current MST Configuration Identification** window, which will reveal the following window to configure:

Figure 6- 26. Instance ID Settings window – CIST modify

The user may configure the following parameters to configure the CIST on the Switch.

Parameter	Description
MSTI ID	The MSTI ID of the CIST is 0 and cannot be altered.
Type	The type of configuration about to be processed. This window is used to add or delete VIDs to the configured MSTI or internal CIST. All other parameters are permanently set and therefore unchangeable.
VID List (1-4094)	This field is used to specify the VID range from configured VLANs set on the Switch. Supported VIDs on the Switch range from ID number 1 to 4094.

Click **Apply** to implement changes made.

To configure the parameters for a previously set MSTI, click on its hyperlinked **MSTI ID** number, which will reveal the following screen for configuration.



Figure 6- 27. Instance ID Settings window – modify

The user may configure the following parameters for a MSTI on the Switch.

Parameter	Description
MSTI ID	Displays the MSTI ID previously set by the user.
Type	This field allows the user to choose a desired method for altering the MSTI settings. The user has 4 choices. <i>Add VID</i> – Select this parameter to add VIDs to the MSTI ID, in conjunction with the VID List parameter. <i>Remove VID</i> – Select this parameter to remove VIDs from the MSTI ID, in conjunction with the VID List parameter.
VID List (1-4094)	This field is used to specify the VID range from configured VLANs set on the Switch that the user wishes to add to this MSTI ID. Supported VIDs on the Switch range from ID number 1 to 4094. This parameter can only be utilized if the Type chosen is <i>Add</i> or <i>Remove</i> .

Click **Apply** to implement changes made.

MSTI Port Information

This window displays the current MSTI configuration settings and can be used to update the port configuration for an MSTI ID. If a loop occurs, the MSTP function will use the port priority to select an interface to put into the forwarding state. Set a higher priority value for interfaces to be selected for forwarding first. In instances where the priority value is identical, the MSTP function will implement the lowest port number into the forwarding state and other interfaces will be blocked. Remember that lower priority values mean higher priorities for forwarding packets.

To view the following window, click **Configuration > Spanning Tree > MST Port Information**:

Unit	Port	Apply
1	Port 1	Apply

MSTI Port Information-Port 1 of Unit 1					
Msti	Designated Bridge	Internal PathCost	Prio	Status	Role
0	N/A	200000	128	Forwarding	NonStp

Figure 6- 28. MSTP Port Information window

To view the MSTI settings for a particular port, select the **Port** number and the Unit ID number of the switch in the switch stack, located in the top left hand corner of the screen and click **Apply**. To modify the settings for a particular **MSTI Instance**, click on its hyperlinked MSTI ID, which will reveal the following window.

MSTI Settings-Port 1 of Unit 1	
Instance ID	1
Internal cost(0=Auto)	0
Priority	128

Apply

Show MSTP Port Information Table-Port 1 of Unit 1

Figure 6- 29. MSTI Settings window

Parameter	Description
Instance ID	Displays the MSTI ID of the instance being configured. An entry of 0 in this field denotes the CIST (default MSTI).
Internal cost (0=Auto)	This parameter is set to represent the relative cost of forwarding packets to specified ports when an interface is selected within a STP instance. The default setting is 0 (auto). There are two options: <i>0 (auto)</i> – Selecting this parameter for the internal Cost will set quickest route automatically and optimally for an interface. The default value is derived from the media speed of the interface. <i>value 1-2000000</i> – Selecting this parameter with a value in the range of 1-2000000 will set the quickest route when a loop occurs. A lower Internal cost represents a quicker transmission.
Priority	Enter a value between 0 and 240 to set the priority for the port interface. A higher priority will designate the interface to forward packets first. A lower number denotes a higher priority. This entry must be divisible by 16. The default priority setting is 128.

Click **Apply** to implement changes made.

STP Instance Settings

The following window displays MSTIs currently set on the Switch. To view the following table, click **Configuration > Spanning Tree > STP Instance Settings**:

STP Instance Table			
Instance Type	Instance Status	Instance Priority	Priority
CIST	Enabled	32768(bridge priority : 32768, sys ID ext : 0)	Modify
2	Disabled	32770(bridge priority : 32768, sys ID ext : 2)	Modify

Figure 6- 30. STP Instance Settings

The following information is displayed:

Parameter	Description
Instance Type	Displays the instance type(s) currently configured on the Switch. Each instance type is classified by a MSTI ID. CIST refers to the default MSTI configuration set on the Switch.
Instance Status	Displays the current status of the corresponding MSTI ID.
Instance Priority	Displays the priority of the corresponding MSTI ID. The lowest priority will be the root bridge.
Priority	Click the Modify button to change the priority of the MSTI. This will open the Instance ID Settings window to configure. The Type field in this window will be permanently set to Set Priority Only. Enter the new priority in the Priority field and click Apply to implement the new priority setting.

Click **Apply** to implement changes made.

Clicking the hyperlinked name will allow the user to view the current parameters set for the MSTI Instance.

STP Instance Operational Status	
Designated Root Bridge	4096/00-01-27-32-26-95
External Root Cost	200004
Regional Root Bridge	32768/00-53-13-1a-33-24
Internal Root Cost	0
Designated Bridge	32768/00-50-ba-71-20-d6
Root Port	1
Max Age	20
Forward Delay	15
Last Topology Change	177
Topology Changes Count	157
Show STP Instance Table	

Figure 6- 31. STP Instance Operational Status – CIST

STP Instance Operational Status	
Regional Root Bridge	32770/00-53-13-1a-33-24
Internal Root Cost	0
Designated Bridge	32770/00-53-13-1a-33-24
Root Port	None
Remaining Hops	20
Last Topology Change	288
Topology Changes Count	3
Show STP Instance Table	

Figure 6- 32. STP Instance Operational Status – Previously Configured MSTI

The following parameters may be viewed in the **STP Instance Operational Status** windows:

Parameter	Description
Designated Root Bridge	This field will show the priority and MAC address of the Root Bridge.
External Root Cost	This defines a metric that indicates the relative cost of forwarding packets to the specified port list. Port cost can be set automatically or as a metric value. The default value is 0 (auto). <i>0 (auto)</i> – Setting 0 for the external cost will automatically set the speed for forwarding packets to the specified port(s) in the list for optimal efficiency. Default port cost: 100Mbps port = 200000. Gigabit port = 20000. <i>value 1-200000000</i> – Define a value between 1 and 200000000 to determine the external cost. The lower the number, the greater the probability the port will be chosen to forward packets.
Regional Root Bridge	This field will show the priority and MAC address of the Regional (Internal) Root Bridge. This MAC address should be the MAC address of the Switch.
Internal Root Cost	This parameter is set to represent the relative cost of forwarding packets to specified ports when an interface is selected within a STP instance. The default setting is 0 (auto). There are two options: <i>0 (auto)</i> – Selecting this parameter for the <i>internalCost</i> will set quickest route automatically and optimally for an interface. The default value is derived from the media speed of the interface. <i>value 1-2000000</i> – Selecting this parameter with a value in the range of 1-2000000 will set the quickest route when a loop occurs. A lower Internal cost represents a quicker transmission.
Designated Bridge	This field will show the priority and MAC address of the Designated Bridge. The information shown in this table comes from a BPDU packet originating from this bridge.
Root Port	This is the port on the Switch that is physically connected to the Root Bridge.
Max Age	The Max Age may be set to ensure that old information does not endlessly circulate through redundant paths in the network, preventing the effective propagation of the new information. Set by the Root Bridge, this value will aid in determining that the Switch has spanning tree configuration values consistent with other devices on the bridged LAN. If the value ages out and a BPDU has still not been received from the Root Bridge, the Switch will start sending its own BPDU to all other switches for permission to become the Root Bridge. If it turns out that your switch has the lowest Bridge Identifier, it will become the Root Bridge. The user may choose a time between 6 and 40 seconds. The default value is 20.
Forward Delay	The Forward Delay can be from 4 to 30 seconds. Any port on the Switch spends this time in the listening state while moving from the blocking state to the forwarding state.
Last Topology Change	This field shows the time, in seconds, since the last spanning tree topology change.
Topology Changes Count	This field displays the number of times that the spanning tree topology has changed since the original initial boot up of the Switch.

STP Port Settings

STP can be set up on a port per port basis. To view the following window click **Configuration > Spanning Tree > STP Port Settings**:

STP Port Settings								
Unit	From	To	External Cost (0=Auto)	Hello Time	Migrate	Edge	P2P	State
1	Port 1	Port 1	0		Yes	False	True	Enabled

Apply

STP Port Settings Table-Unit 1					
Port	External Cost	Hello Time	Edge	P2P	Port STP
1	AUTO/200000	2/2	No/No	Auto/Yes	Enabled
2	AUTO/200000	2/2	No/No	Auto/Yes	Enabled
3	AUTO/200000	2/2	No/No	Auto/Yes	Enabled
4	AUTO/200000	2/2	No/No	Auto/Yes	Enabled
5	AUTO/200000	2/2	No/No	Auto/Yes	Enabled
6	AUTO/200000	2/2	No/No	Auto/Yes	Enabled
7	AUTO/200000	2/2	No/No	Auto/Yes	Enabled
8	AUTO/200000	2/2	No/No	Auto/Yes	Enabled
9	AUTO/200000	2/2	No/No	Auto/Yes	Enabled
10	AUTO/200000	2/2	No/No	Auto/Yes	Enabled
11	AUTO/200000	2/2	No/No	Auto/Yes	Enabled
12	AUTO/200000	2/2	No/No	Auto/Yes	Enabled
13	AUTO/200000	2/2	No/No	Auto/Yes	Enabled
14	AUTO/200000	2/2	No/No	Auto/Yes	Enabled
15	AUTO/200000	2/2	No/No	Auto/Yes	Enabled
16	AUTO/200000	2/2	No/No	Auto/Yes	Enabled
17	AUTO/200000	2/2	No/No	Auto/Yes	Enabled
18	AUTO/200000	2/2	No/No	Auto/Yes	Enabled
19	AUTO/200000	2/2	No/No	Auto/Yes	Enabled
20	AUTO/200000	2/2	No/No	Auto/Yes	Enabled
21	AUTO/200000	2/2	No/No	Auto/Yes	Enabled
22	AUTO/200000	2/2	No/No	Auto/Yes	Enabled
23	AUTO/200000	2/2	No/No	Auto/Yes	Enabled
24	AUTO/200000	2/2	No/No	Auto/Yes	Enabled

Figure 6- 33. STP Port Settings and MSTP Port Information Table

In addition to setting Spanning Tree parameters for use on the switch level, the Switch allows for the configuration of groups of ports, each port-group of which will have its own spanning tree, and will require some of its own configuration settings. An STP Group will use the switch-level parameters entered above, with the addition of **Port Priority** and **Port Cost**.

An STP Group spanning tree works in the same way as the switch-level spanning tree, but the root bridge concept is replaced with a root port concept. A root port is a port of the group that is elected based on port priority and port cost, to be the connection to the network for the group. Redundant links will be blocked, just as redundant links are blocked on the switch level.

The STP on the switch level blocks redundant links between switches (and similar network devices). The port level STP will block redundant links within an STP Group.

It is advisable to define an STP Group to correspond to a VLAN group of ports.

The following fields can be set:

Parameter	Description
Unit	Choose the Switch ID number of the Switch in the switch stack to be modified.
From/To	A consecutive group of ports may be configured starting with the selected port.
External Cost	This defines a metric that indicates the relative cost of forwarding packets to the specified port list. Port cost can be set automatically or as a metric value. The default value is 0 (auto).

0 (auto) – Setting 0 for the external cost will automatically set the speed for forwarding packets to the specified port(s) in the list for optimal efficiency. Default port cost: 100Mbps port = 200000. Gigabit port = 20000.

value 1-200000000 – Define a value between 1 and 200000000 to determine the external cost. The lower the number, the greater the probability the port will be chosen to forward packets.

Hello Time

The time interval between the transmission of configuration messages by the designated port, to other devices on the bridged LAN, thus stating that the Switch is still functioning. The user may choose a time between 1 and 10 seconds. The default is 2 seconds. This field is only operable when the Switch is enabled for MSTP.

Migration

Setting this parameter as "yes" will set the ports to send out BPDU packets to other bridges, requesting information on their STP setting. If the Switch is configured for RSTP, the port will be capable to migrate from 802.1d STP to 802.1w RSTP. If the Switch is configured for MSTP, the port is capable of migrating from 802.1d STP to 802.1s MSTP. RSTP and MSTP can coexist with standard STP, however the benefits of RSTP and MSTP are not realized on a port where an 802.1d network connects to an 802.1w or 802.1s enabled network. Migration should be set as yes on ports connected to network stations or segments that are capable of being upgraded to 802.1w RSTP or 802.1s MSTP on all or some portion of the segment.

Edge

Choosing the true parameter designates the port as an edge port. Edge ports cannot create loops, however an edge port can lose edge port status if a topology change creates a potential for a loop. An edge port normally should not receive BPDU packets. If a BPDU packet is received, it automatically loses edge port status. Choosing the false parameter indicates that the port does not have edge port status.

P2P

Choosing the True parameter indicates a point-to-point (P2P) shared link. P2P ports are similar to edge ports, however they are restricted in that a P2P port must operate in full-duplex. Like edge ports, P2P ports transition to a forwarding state rapidly thus benefiting from RSTP. A p2p value of false indicates that the port cannot have p2p status. Auto allows the port to have p2p status whenever possible and operate as if the p2p status were true. If the port cannot maintain this status, (for example if the port is forced to half-duplex operation) the p2p status changes to operate as if the p2p value were False. The default setting for this parameter is True.

State

This drop-down menu allows you to enable or disable STP for the selected group of ports. The default is Enabled.

Click **Apply** to implement changes made.

6-13 Forwarding & Filtering

Unicast Forwarding

Open the **Forwarding & Filtering** folder in the **Configuration** menu and click on the **Unicast Forwarding** link. This will open the **Setup Static Unicast Forwarding Table**, as shown below:

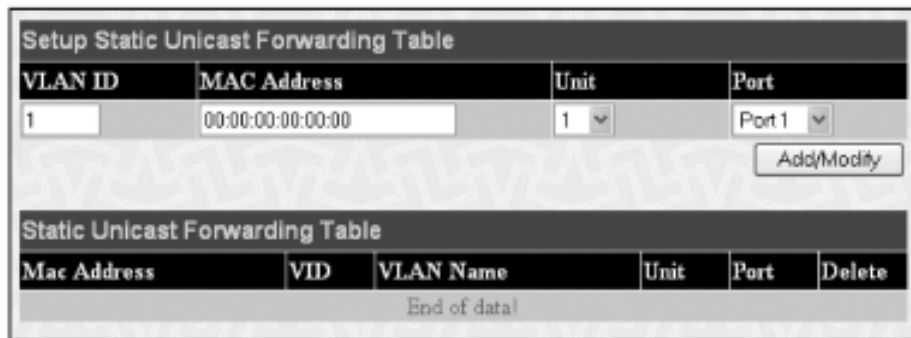

Figure 6- 34. Setup Static Unicast Forwarding Table and Static Unicast Forwarding Table window

To add or edit an entry, define the following parameters and then click **Add/Modify**:

Parameter	Description
VLAN ID (VID)	The VLAN ID number of the VLAN on which the above Unicast MAC address resides.
MAC Address	The MAC address to which packets will be statically forwarded. This must be a unicast MAC address.
Unit	Choose the Switch ID number of the Switch in the switch stack to be modified.
Port	Allows the selection of the port number on which the MAC address entered above resides.

Click **Apply** to implement the changes made. To delete an entry in the **Static Unicast Forwarding Table**, click the corresponding **X** under the **Delete** heading.

Static Multicast Forwarding

The following figure and table describe how to set up **Multicast Forwarding** on the Switch. Open the **Forwarding Filtering** folder and click on the **Multicast Forwarding** link to see the entry screen below:

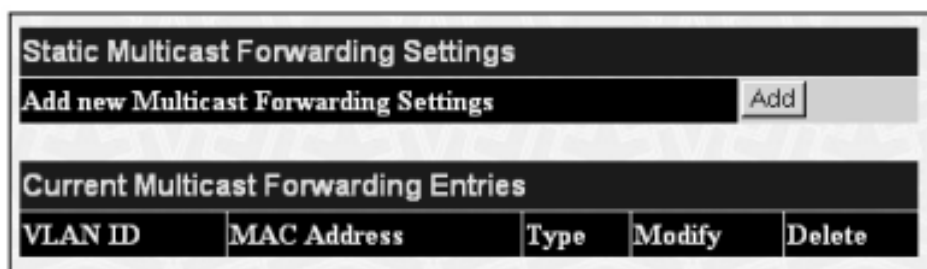

Figure 6- 35. Static Multicast Forwarding Settings and Current Multicast Forwarding Entries

The **Static Multicast Forwarding Settings** page displays all of the entries made into the Switch's static multicast forwarding table. Click the **Add** button to open the **Setup Static Multicast Forwarding Table**, as shown below:

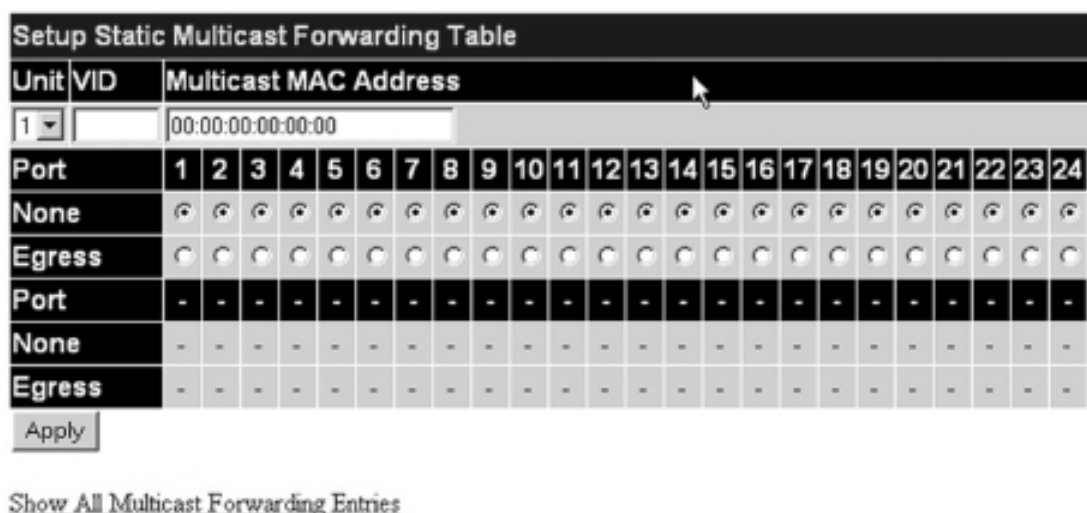

Figure 6- 36. Setup Static Multicast Forwarding Table

The following parameters can be set:

Parameter	Description
Unit	Choose the Switch ID number of the Switch in the switch stack to be modified.
VID	The VLAN ID of the VLAN the corresponding MAC address belongs to.
Multicast MAC Address	The MAC address of the static source of multicast packets. This must be a multicast MAC address.
Port	Allows the selection of ports that will be members of the static multicast group. The options are: <i>None</i> – No restrictions on the port dynamically joining the multicast group. When None is chosen, the port will not be a member of the Static Multicast Group. <i>Egress</i> – The port is a static member of the multicast group.

Click **Apply** to implement the changes made. To delete an entry in the **Static Multicast Forwarding Table**, click the corresponding **X** under the **Delete** heading. Click the [Show All Multicast Forwarding Entries](#) link to return to the **Static Multicast Forwarding Settings** window.

Understanding IEEE 802.1p Priority

Priority tagging is a function defined by the IEEE 802.1p standard designed to provide a means of managing traffic on a network where many different types of data may be transmitted simultaneously. It is intended to alleviate problems associated with the delivery of time critical data over congested networks. The quality of applications that are dependent on such time critical data, such as video conferencing, can be severely and adversely affected by even very small delays in transmission.

Network devices that are in compliance with the IEEE 802.1p standard have the ability to recognize the priority level of data packets. These devices can also assign a priority label or tag to packets. Compliant devices can also strip priority tags from packets. This priority tag determines the packet's degree of expeditiousness and determines the queue to which it will be assigned.

Priority tags are given values from 0 to 7 with 0 being assigned to the lowest priority data and 7 assigned to the highest. The highest priority tag 7 is generally only used for data associated with video or audio applications, which are sensitive to even slight delays, or for data from specified end users whose data transmissions warrant special consideration.

The Switch allows you to further tailor how priority tagged data packets are handled on your network. Using queues to manage priority tagged data allows you to specify its relative priority to suit the needs of your network. There may be circumstances where it would be advantageous to group two or more differently tagged packets into the same queue.

Generally, however, it is recommended that the highest priority queue, Queue 1, be reserved for data packets with a priority value of 7. Packets that have not been given any priority value are placed in Queue 0 and thus given the lowest priority for delivery.

A weighted round robin system is employed on the Switch to determine the rate at which the queues are emptied of packets. The ratio used for clearing the queues is 4:1. This means that the highest priority queue, Queue 1, will clear 4 packets for every 1 packet cleared from Queue 0.

Remember, the priority queue settings on the Switch are for all ports, and all devices connected to the Switch will be affected. This priority queuing system will be especially beneficial if your network employs switches with the capability of assigning priority tags.

VLAN Description

A Virtual Local Area Network (VLAN) is a network topology configured according to a logical scheme rather than the physical layout. VLANs can be used to combine any collection of LAN segments into an autonomous user group that appears as a single LAN. VLANs also logically segment the network into different broadcast domains so that packets are forwarded only between ports within the VLAN. Typically, a VLAN corresponds to a particular subnet, although not necessarily.

VLANs can enhance performance by conserving bandwidth, and improve security by limiting traffic to specific domains.

A VLAN is a collection of end nodes grouped by logic instead of physical location. End nodes that frequently communicate with each other are assigned to the same VLAN, regardless of where they are physically on the network. Logically, a VLAN can be equated to a broadcast domain, because broadcast packets are forwarded to only members of the VLAN on which the broadcast was initiated.

Notes About VLANs on the AT-9724TS

No matter what basis is used to uniquely identify end nodes and assign these nodes VLAN membership, packets cannot cross VLANs without a network device performing a routing function between the VLANs.

The AT-9724TS supports IEEE 802.1Q VLANs and Port-Based VLANs. The port untagging function can be used to remove the 802.1Q tag from packet headers to maintain compatibility with devices that are tag-unaware. The Switch's default is to assign all ports to a single 802.1Q VLAN named "default."

The "default" VLAN has a VID = 1.

The member ports of Port-based VLANs may overlap, if desired.

IEEE 802.1Q VLANs

Some relevant terms:

Tagging – The act of putting 802.1Q VLAN information into the header of a packet.

Untagging – The act of stripping 802.1Q VLAN information out of the packet header.

Ingress port – A port on a switch where packets are flowing into the Switch and VLAN decisions must be made.

Egress port – A port on a switch where packets are flowing out of the Switch, either to another switch or to an end station, and tagging decisions must be made.

IEEE 802.1Q (tagged) VLANs are implemented on the Switch. 802.1Q VLANs require tagging, which enables them to span the entire network (assuming all switches on the network are IEEE 802.1Q-compliant).

VLANs allow a network to be segmented in order to reduce the size of broadcast domains. All packets entering a VLAN will only be forwarded to the stations (over IEEE 802.1Q enabled switches) that are members of that VLAN, and this includes broadcast, multicast and unicast packets from unknown sources.

VLANs can also provide a level of security to your network. IEEE 802.1Q VLANs will only deliver packets between stations that are members of the VLAN.

Any port can be configured as either tagging or untagging. The untagging feature of IEEE 802.1Q VLANs allows VLANs to work with legacy switches that don't recognize VLAN tags in packet headers. The tagging feature allows VLANs to span multiple 802.1Q-compliant switches through a single physical connection and allows Spanning Tree to be enabled on all ports and work normally.

The IEEE 802.1Q standard restricts the forwarding of untagged packets to the VLAN the receiving port is a member of.

The main characteristics of IEEE 802.1Q are as follows:

- Assigns packets to VLANs by filtering.
- Assumes the presence of a single global spanning tree.
- Uses an explicit tagging scheme with one-level tagging.
- 802.1Q VLAN Packet Forwarding
- Packet forwarding decisions are made based upon the following three types of rules:
 - Ingress rules – rules relevant to the classification of received frames belonging to a VLAN.
 - Forwarding rules between ports – decides whether to filter or forward the packet.
 - Egress rules – determines if the packet must be sent tagged or untagged.

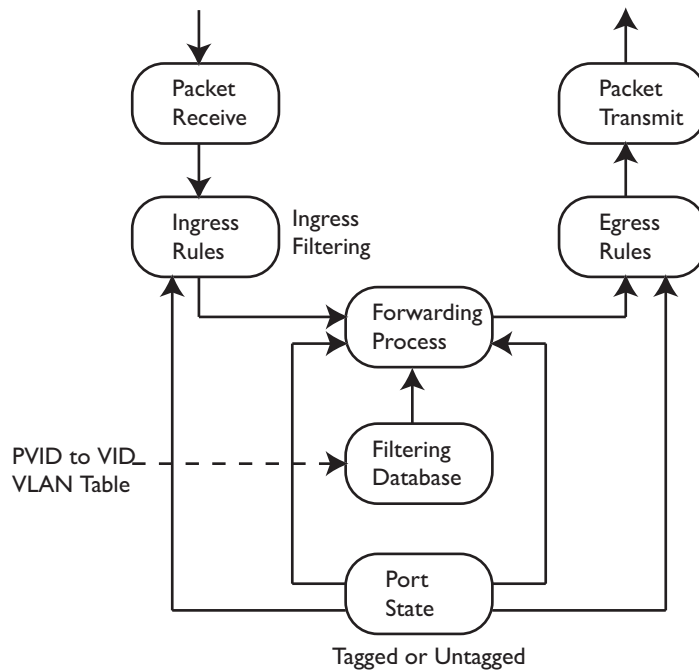

Figure 6- 37. IEEE 802.1Q Packet Forwarding

802.1Q VLAN Tags

The figure below shows the 802.1Q VLAN tag. There are four additional octets inserted after the source MAC address. Their presence is indicated by a value of 0x8100 in the EtherType field. When a packet's EtherType field is equal to 0x8100, the packet carries the IEEE 802.1Q/802.1p tag. The tag is contained in the following two octets and consists of 3 bits of user priority, 1 bit of Canonical Format Identifier (CFI - used for encapsulating Token Ring packets so they can be carried across Ethernet backbones), and 12 bits of VLAN ID (VID). The 3 bits of user priority are used by 802.1p. The VID is the VLAN identifier and is used by the 802.1Q standard. Because the VID is 12 bits long, 4094 unique VLANs can be identified.

The tag is inserted into the packet header making the entire packet longer by 4 octets. All of the information originally contained in the packet is retained.

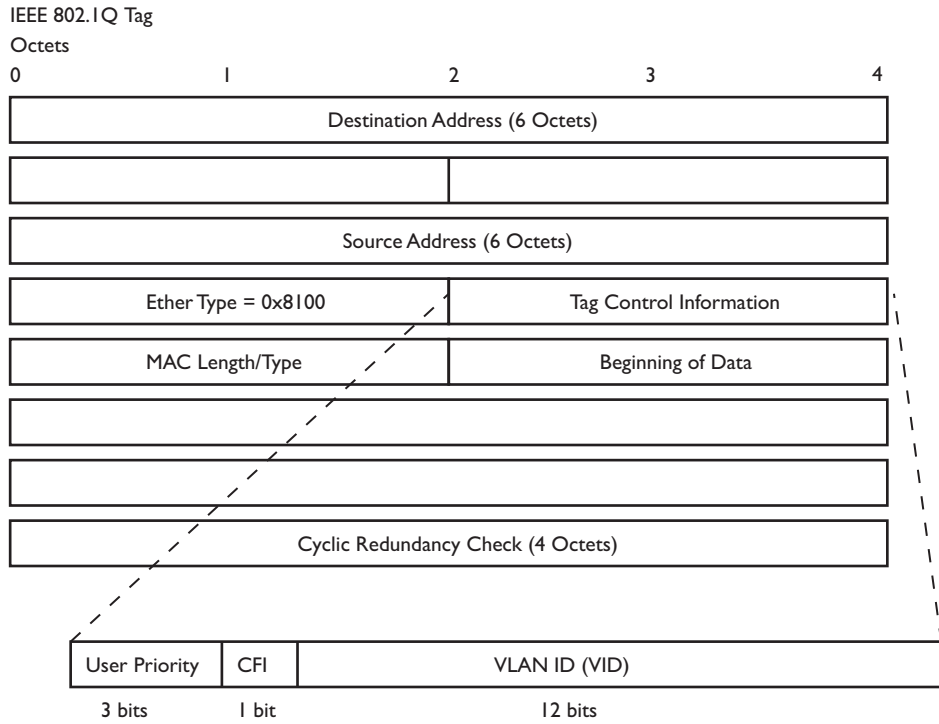

Figure 6- 38. IEEE 802.1Q Tag

The EtherType and VLAN ID are inserted after the MAC source address, but before the original EtherType/Length or Logical Link Control. Because the packet is now a bit longer than it was originally, the Cyclic Redundancy Check (CRC) must be recalculated.

Adding an IEEE 802.1 Tag

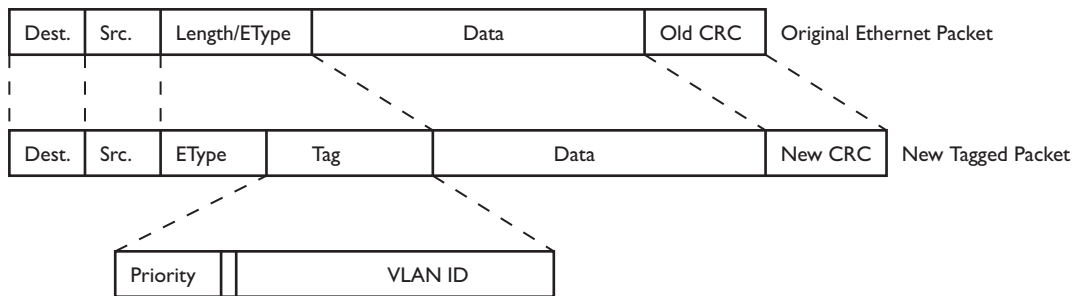

Figure 6- 39. Adding an IEEE 802.1Q Tag

Port VLAN ID

Packets that are tagged (are carrying the 802.1Q VID information) can be transmitted from one 802.1Q compliant network device to another with the VLAN information intact. This allows 802.1Q VLANs to span network devices (and indeed, the entire network, if all network devices are 802.1Q compliant).

Unfortunately, not all network devices are 802.1Q compliant. These devices are referred to as tag-unaware. 802.1Q devices are referred to as tag-aware.

Prior to the adoption of 802.1Q VLANs, port-based and MAC-based VLANs were in common use. These VLANs relied upon a Port VLAN ID (PVID) to forward packets. A packet received on a given port would be assigned that port's PVID and then be forwarded to the port that corresponded to the packet's destination address (found in the Switch's forwarding table). If the PVID of the port that received the packet is different from the PVID of the port that is to transmit the packet, the Switch will drop the packet.

Within the Switch, different PVIDs mean different VLANs (remember that two VLANs cannot communicate without an external router). So, VLAN identification based upon the PVIDs cannot create VLANs that extend outside a given switch (or switch stack).

Every physical port on a switch has a PVID. 802.1Q ports are also assigned a PVID, for use within the Switch. If no VLANs are defined on the Switch, all ports are then assigned to a default VLAN with a PVID equal to 1. Untagged packets are assigned the PVID of the port on which they were received. Forwarding decisions are based upon this PVID, in so far as VLANs are concerned. Tagged packets are forwarded according to the VID contained within the tag. Tagged packets are also assigned a PVID, but the PVID is not used to make packet forwarding decisions, the VID is.

Tag-aware switches must keep a table to relate PVIDs within the Switch to VIDs on the network. The Switch will compare the VID of a packet to be transmitted to the VID of the port that is to transmit the packet. If the two VIDs are different, the Switch will drop the packet. Because of the existence of the PVID for untagged packets and the VID for tagged packets, tag-aware and tag-unaware network devices can coexist on the same network.

A switch port can have only one PVID, but can have as many VIDs as the Switch has memory in its VLAN table to store them.

Because some devices on a network may be tag-unaware, a decision must be made at each port on a tag-aware device before packets are transmitted – should the packet to be transmitted have a tag or not? If the transmitting port is connected to a tag-unaware device, the packet should be untagged. If the transmitting port is connected to a tag-aware device, the packet should be tagged.

Tagging and Untagging

Every port on an 802.1Q compliant switch can be configured as tagging or untagging.

Ports with tagging enabled will put the VID number, priority and other VLAN information into the header of all packets that flow into and out of it. If a packet has previously been tagged, the port will not alter the packet, thus keeping the VLAN information intact. The VLAN information in the tag can then be used by other 802.1Q compliant devices on the network to make packet-forwarding decisions.

Ports with untagging enabled will strip the 802.1Q tag from all packets that flow into and out of those ports. If the packet doesn't have an 802.1Q VLAN tag, the port will not alter the packet. Thus, all packets received by and forwarded by an untagging port will have no 802.1Q VLAN information. (Remember that the PVID is only used internally within the Switch). Untagging is used to send packets from an 802.1Q-compliant network device to a non-compliant network device.

Ingress Filtering

A port on a switch where packets are flowing into the Switch and VLAN decisions must be made is referred to as an ingress port. If ingress filtering is enabled for a port, the Switch will examine the VLAN information in the packet header (if present) and decide whether or not to forward the packet.

If the packet is tagged with VLAN information, the ingress port will first determine if the ingress port itself is a member of the tagged VLAN. If it is not, the packet will be dropped. If the ingress port is a member of the 802.1Q VLAN, the Switch then determines if the destination port is a member of the 802.1Q VLAN. If it is not, the packet is dropped. If the destination port is a member of the 802.1Q VLAN, the packet is forwarded and the destination port transmits it to its attached network segment.

If the packet is not tagged with VLAN information, the ingress port will tag the packet with its own PVID as a VID (if the port is a tagging port). The switch then determines if the destination port is a member of the same VLAN (has the same VID) as the ingress port. If it does not, the packet is dropped. If it has the same VID, the packet is forwarded and the destination port transmits it on its attached network segment.

This process is referred to as ingress filtering and is used to conserve bandwidth within the Switch by dropping packets that are not on the same VLAN as the ingress port at the point of reception. This eliminates the subsequent processing of packets that will just be dropped by the destination port.

Default VLANs

The Switch initially configures one VLAN, VID = 1, called "default." The factory default setting assigns all ports on the Switch to the "default." As new VLANs are configured in Port-based mode, their respective member ports are removed from the "default."

Packets cannot cross VLANs. If a member of one VLAN wants to connect to another VLAN, the link must be through an external router.

 **Note:** If no VLANs are configured on the Switch, then all packets will be forwarded to any destination port. Packets with unknown source addresses will be flooded to all ports. Broadcast and multicast packets will also be flooded to all ports.

An example is presented below:

VLAN Name	VID	Switch Ports
System (default)	1	5, 6, 7, 8, 21, 22, 23, 24
Engineering	2	9, 10, 11, 12
Marketing	3	13, 14, 15, 16
Finance	4	17, 18, 19, 20
Sales	5	1, 2, 3, 4

Table 6- 3.VLAN Example – Assigned Ports

Port-based VLANs

Port-based VLANs limit traffic that flows into and out of switch ports. Thus, all devices connected to a port are members of the VLAN(s) the port belongs to, whether there is a single computer directly connected to a switch, or an entire department.

On port-based VLANs, NICs do not need to be able to identify 802.1Q tags in packet headers. NICs send and receive normal Ethernet packets. If the packet's destination lies on the same segment, communications take place using normal Ethernet protocols. Even though this is always the case, when the destination for a packet lies on another switch port, VLAN considerations come into play to decide if the packet gets dropped by the Switch or delivered.

VLAN Segmentation

Take for example a packet that is transmitted by a machine on Port 1 that is a member of VLAN 2. If the destination lies on another port (found through a normal forwarding table lookup), the Switch then looks to see if the other port (Port 10) is a member of VLAN 2 (and can therefore receive VLAN 2 packets). If Port 10 is not a member of VLAN 2, then the packet will be dropped by the Switch and will not reach its destination. If Port 10 is a member of VLAN 2, the packet will go through. This selective forwarding feature based on VLAN criteria is how VLANs segment networks. The key point being that Port 1 will only transmit on VLAN 2.

Network resources such as printers and servers however, can be shared across VLANs. This is achieved by setting up overlapping VLANs. That is ports can belong to more than one VLAN group. For example, setting VLAN 1 members to ports 1, 2, 3, and 4 and VLAN 2 members to ports 1, 5, 6, and 7. Port 1 belongs to two VLAN groups. Ports 8, 9, and 10 are not configured to any VLAN group. This means ports 8, 9, and 10 are in the same VLAN group.

VLAN and Trunk Groups

The members of a trunk group have the same VLAN setting. Any VLAN setting on the members of a trunk group will apply to the other member ports.

 **Note:** In order to use VLAN segmentation in conjunction with port trunk groups, you can first set the port trunk group(s), and then you may configure VLAN settings. If you wish to change the port trunk grouping with VLANs already in place, you will not need to reconfigure the VLAN settings after changing the port trunk group settings. VLAN settings will automatically change in conjunction with the change of the port trunk group settings.

Protocol VLANs

The AT-9724TS incorporates the idea of protocol-based VLANs. This standard, defined by the IEEE 802.1v standard maps packets to protocol-defined VLANs by examining the type octet within the packet header to discover the type of protocol associated with it. After assessing the protocol, the Switch will forward the packets to all ports within the protocol-assigned VLAN. This feature will benefit the administrator by better balancing load sharing and enhancing traffic classification. The Switch supports fifteen (15) pre-defined protocols for configuration. The user may also choose a protocol that is not one of the fifteen defined protocols by properly configuring the userDefined protocol VLAN. The supported protocols for the protocol VLAN function on this switch include IP, IPX, DEC, DEC LAT, SNAP, NetBIOS, AppleTalk, XNS, SNA, IPv6, RARP and VINES.

The following is a list of type headers for each protocol listed for VLAN configuration.

Protocol	Type Header in Hexadecimal Form
IP over Ethernet	0x0800
IPX 802.3	0xFFFF
IPX 802.2	0xE0E0
IPX SNAP	0x8137
IPX over Ethernet2	0x8137
DecLAT	0x6000
DecOther	0x6009
SNA 802.2	0x0404
NetBios	0xF0F0
XNS	0x0600
VINES	0x0BAD
IPv6	0x86DD
AppleTalk	0x809B
RARP	0x8035

Table 6- 4. Protocol/VLAN and the corresponding type header

In configuring the user-defined protocol, the administrator must make sure that the pre-defined user type header does not match any other type header. A match may cause discrepancies within the local network and failure to define the VLAN to forward packets to.

Static VLAN Entry

In the **Configuration** folder, open the **VLAN** folder and click the **Static VLAN Entry** link to open the following window:

Current 802.1Q Static VLANs Entries			
VLAN ID	VLAN name	Advertisement	Delete
1	default	Enabled	X
4094	Trinity	Disabled	X

Figure 6- 40. Current 802.1Q Static VLANs Entries window

The **802.1Q Static VLANs** menu lists all previously configured VLANs by **VLAN ID** and **VLAN Name**. To delete an existing 802.1Q VLAN, click the corresponding button under the **Delete** heading.

To create a new 802.1Q VLAN, click the Add button in the **802.1Q Static VLANs** menu. A new menu will appear, as shown below, to configure the port settings and to assign a unique name and number to the new VLAN. See the table below for a description of the parameters in the new menu.

802.1Q Static VLANs																									
Unit	VID	VLAN Name																			Advertisement				
1																					Disabled				
Type	Protocol ID								User Defined Packet ID								Encap								
	port																								
Port Settings	1	2	3	4	5	6	7	8	9	10	11	12	13	14	15	16	17	18	19	20	21	22	23	24	-
Tag	<input checked="" type="checkbox"/>	<input checked="" type="checkbox"/>	<input checked="" type="checkbox"/>	<input checked="" type="checkbox"/>	<input checked="" type="checkbox"/>	<input checked="" type="checkbox"/>	<input checked="" type="checkbox"/>	<input checked="" type="checkbox"/>	<input checked="" type="checkbox"/>	<input checked="" type="checkbox"/>	<input checked="" type="checkbox"/>	<input checked="" type="checkbox"/>	<input checked="" type="checkbox"/>	<input checked="" type="checkbox"/>	<input checked="" type="checkbox"/>	<input checked="" type="checkbox"/>	<input checked="" type="checkbox"/>	<input checked="" type="checkbox"/>	<input checked="" type="checkbox"/>	<input checked="" type="checkbox"/>	<input checked="" type="checkbox"/>	<input checked="" type="checkbox"/>	<input checked="" type="checkbox"/>	<input checked="" type="checkbox"/>	-
None	<input type="checkbox"/>	<input type="checkbox"/>	<input type="checkbox"/>	<input type="checkbox"/>	<input type="checkbox"/>	<input type="checkbox"/>	<input type="checkbox"/>	<input type="checkbox"/>	<input type="checkbox"/>	<input type="checkbox"/>	<input type="checkbox"/>	<input type="checkbox"/>	<input type="checkbox"/>	<input type="checkbox"/>	<input type="checkbox"/>	<input type="checkbox"/>	<input type="checkbox"/>	<input type="checkbox"/>	<input type="checkbox"/>	<input type="checkbox"/>	<input type="checkbox"/>	<input type="checkbox"/>	<input type="checkbox"/>	<input type="checkbox"/>	-
Egress	<input type="checkbox"/>	<input type="checkbox"/>	<input type="checkbox"/>	<input type="checkbox"/>	<input type="checkbox"/>	<input type="checkbox"/>	<input type="checkbox"/>	<input type="checkbox"/>	<input type="checkbox"/>	<input type="checkbox"/>	<input type="checkbox"/>	<input type="checkbox"/>	<input type="checkbox"/>	<input type="checkbox"/>	<input type="checkbox"/>	<input type="checkbox"/>	<input type="checkbox"/>	<input type="checkbox"/>	<input type="checkbox"/>	<input type="checkbox"/>	<input type="checkbox"/>	<input type="checkbox"/>	<input type="checkbox"/>	<input type="checkbox"/>	-
Forbidden	<input type="checkbox"/>	<input type="checkbox"/>	<input type="checkbox"/>	<input type="checkbox"/>	<input type="checkbox"/>	<input type="checkbox"/>	<input type="checkbox"/>	<input type="checkbox"/>	<input type="checkbox"/>	<input type="checkbox"/>	<input type="checkbox"/>	<input type="checkbox"/>	<input type="checkbox"/>	<input type="checkbox"/>	<input type="checkbox"/>	<input type="checkbox"/>	<input type="checkbox"/>	<input type="checkbox"/>	<input type="checkbox"/>	<input type="checkbox"/>	<input type="checkbox"/>	<input type="checkbox"/>	<input type="checkbox"/>	<input type="checkbox"/>	-
Port Settings	-	-	-	-	-	-	-	-	-	-	-	-	-	-	-	-	-	-	-	-	-	-	-	-	-
Tag	-	-	-	-	-	-	-	-	-	-	-	-	-	-	-	-	-	-	-	-	-	-	-	-	-
None	-	-	-	-	-	-	-	-	-	-	-	-	-	-	-	-	-	-	-	-	-	-	-	-	-
Egress	-	-	-	-	-	-	-	-	-	-	-	-	-	-	-	-	-	-	-	-	-	-	-	-	-
Forbidden	-	-	-	-	-	-	-	-	-	-	-	-	-	-	-	-	-	-	-	-	-	-	-	-	-
Apply																									

Figure 6- 41. 802.1Q Static VLANs – Add

To return to the **Current 802.1Q Static VLANs Entries** window, click the [Show All Static VLAN Entries](#) link. To change an existing 802.1Q VLAN entry, click the **Modify** button of the corresponding entry you wish to modify. A new menu will appear to configure the port settings and to assign a unique name and number to the new VLAN. See the table below for a description of the parameters in the new menu.

802.1Q Static VLANs																									
Unit	VID	VLAN Name																			Advertisement				
1	4094	Trinity																			Disabled				
Type	Protocol ID								User Defined Packet ID								Encap								
1QVLAN	port																								
Port Settings	1	2	3	4	5	6	7	8	9	10	11	12	13	14	15	16	17	18	19	20	21	22	23	24	-
Tag	<input checked="" type="checkbox"/>	<input checked="" type="checkbox"/>	<input checked="" type="checkbox"/>	<input checked="" type="checkbox"/>	<input checked="" type="checkbox"/>	<input checked="" type="checkbox"/>	<input checked="" type="checkbox"/>	<input checked="" type="checkbox"/>	<input checked="" type="checkbox"/>	<input checked="" type="checkbox"/>	<input checked="" type="checkbox"/>	<input checked="" type="checkbox"/>	<input checked="" type="checkbox"/>	<input checked="" type="checkbox"/>	<input checked="" type="checkbox"/>	<input checked="" type="checkbox"/>	<input checked="" type="checkbox"/>	<input checked="" type="checkbox"/>	<input checked="" type="checkbox"/>	<input checked="" type="checkbox"/>	<input checked="" type="checkbox"/>	<input checked="" type="checkbox"/>	<input checked="" type="checkbox"/>	<input checked="" type="checkbox"/>	-
None	<input type="checkbox"/>	<input type="checkbox"/>	<input type="checkbox"/>	<input type="checkbox"/>	<input type="checkbox"/>	<input type="checkbox"/>	<input type="checkbox"/>	<input type="checkbox"/>	<input type="checkbox"/>	<input type="checkbox"/>	<input type="checkbox"/>	<input type="checkbox"/>	<input type="checkbox"/>	<input type="checkbox"/>	<input type="checkbox"/>	<input type="checkbox"/>	<input type="checkbox"/>	<input type="checkbox"/>	<input type="checkbox"/>	<input type="checkbox"/>	<input type="checkbox"/>	<input type="checkbox"/>	<input type="checkbox"/>	<input type="checkbox"/>	-
Egress	<input type="checkbox"/>	<input type="checkbox"/>	<input type="checkbox"/>	<input type="checkbox"/>	<input type="checkbox"/>	<input type="checkbox"/>	<input type="checkbox"/>	<input type="checkbox"/>	<input type="checkbox"/>	<input type="checkbox"/>	<input type="checkbox"/>	<input type="checkbox"/>	<input type="checkbox"/>	<input type="checkbox"/>	<input type="checkbox"/>	<input type="checkbox"/>	<input type="checkbox"/>	<input type="checkbox"/>	<input type="checkbox"/>	<input type="checkbox"/>	<input type="checkbox"/>	<input type="checkbox"/>	<input type="checkbox"/>	<input type="checkbox"/>	-
Forbidden	<input type="checkbox"/>	<input type="checkbox"/>	<input type="checkbox"/>	<input type="checkbox"/>	<input type="checkbox"/>	<input type="checkbox"/>	<input type="checkbox"/>	<input type="checkbox"/>	<input type="checkbox"/>	<input type="checkbox"/>	<input type="checkbox"/>	<input type="checkbox"/>	<input type="checkbox"/>	<input type="checkbox"/>	<input type="checkbox"/>	<input type="checkbox"/>	<input type="checkbox"/>	<input type="checkbox"/>	<input type="checkbox"/>	<input type="checkbox"/>	<input type="checkbox"/>	<input type="checkbox"/>	<input type="checkbox"/>	<input type="checkbox"/>	-
Port Settings	-	-	-	-	-	-	-	-	-	-	-	-	-	-	-	-	-	-	-	-	-	-	-	-	-
Tag	-	-	-	-	-	-	-	-	-	-	-	-	-	-	-	-	-	-	-	-	-	-	-	-	-
None	-	-	-	-	-	-	-	-	-	-	-	-	-	-	-	-	-	-	-	-	-	-	-	-	-
Egress	-	-	-	-	-	-	-	-	-	-	-	-	-	-	-	-	-	-	-	-	-	-	-	-	-
Forbidden	-	-	-	-	-	-	-	-	-	-	-	-	-	-	-	-	-	-	-	-	-	-	-	-	-
Apply																									
Show All Static VLAN Entries																									

Figure 6- 42. 802.1Q Static VLANs – Modify

The following fields can then be set in either the Add or Modify 802.1Q Static VLANs menus:

Parameter	Description
Unit	Choose the Switch ID number of the Switch in the switch stack to be modified.
VID (VLAN ID)	Allows the entry of a VLAN ID in the Add dialog box, or displays the VLAN ID of an existing VLAN in the Modify dialog box. VLANs can be identified by either the VID or the VLAN name.
VLAN Name	Allows the entry of a name for the new VLAN in the Add dialog box, or for editing the VLAN name in the Modify dialog box.
Advertisement	Enabling this function will allow the Switch to send out GVRP packets to outside sources, notifying that they may join the existing VLAN.
Type	Displays the type of protocol associated with this VLAN.
Protocol ID	<p>The following parameters allow for the creation of protocol-based VLANs. The Switch supports 15 pre-configured protocol-based VLANs plus one user-defined protocol based VLAN where the administrator may configure the settings for the appropriate protocol and forwarding of packets (16 total). Selecting a specific protocol will indicate which protocol will be utilized in determining the VLAN ownership of a tagged packet. Pre-set protocol-based VLANs on the switch include:</p> <p><i>port</i> – Using this parameter will allow the creation of a normal 802.1Q VLAN on the Switch.</p> <p><i>ip</i> – Using this parameter will instruct the Switch to forward packets to this VLAN if the tag in the packet header is concurrent with this protocol. This packet header information is based on the Ethernet protocol.</p> <p><i>rarp</i> – Using this parameter will instruct the Switch to forward packets to this VLAN if the tag in the packet header is concurrent with this protocol. This packet header information is defined by the Reverse Address Resolution (RARP) Protocol.</p> <p><i>ipx802dot3</i> – Using this parameter will instruct the Switch to forward packets to this VLAN if the tag in the packet header is concurrent with this protocol. This packet header information is defined by Novell NetWare 802.3 (IPX - Internet Packet Exchange).</p> <p><i>ipx802dot2</i> – Using this parameter will instruct the Switch to forward packets to this VLAN if the tag in the packet header is concurrent with this protocol. This packet header information is defined by Novell NetWare 802.2 (IPX - Internet Packet Exchange).</p> <p><i>ipxSnap</i> – Using this parameter will instruct the Switch to forward packets to this VLAN if the tag in the packet header is concurrent with this protocol. This packet header information is defined by Novell and the Sub Network Access Protocol (SNAP).</p> <p><i>ipxEthernet2</i> – Using this parameter will instruct the Switch to forward packets to this VLAN if the tag in the packet header is concurrent with this protocol. This packet header information is defined by the Ethernet Protocol.</p> <p><i>AppleTalk</i> – Using this parameter will instruct the Switch to forward packets to this VLAN if the tag in the packet header is concurrent with this protocol. This packet header information is defined by the AppleTalk protocol.</p> <p><i>decLAT</i> – Using this parameter will instruct the Switch to forward packets to this VLAN if the tag in the packet header is concurrent with this protocol. This packet header information is defined by the Digital Equipment Corporation (DEC) Local Area Transport (LAT) protocol.</p> <p><i>decOther</i> – Using this parameter will instruct the Switch to forward packets to this VLAN if the tag in the packet header is concurrent with this protocol. This packet header information is defined by the Digital Equipment Corporation (DEC) Protocol.</p> <p><i>sna802dot2</i> – Using this parameter will instruct the Switch to forward packets to this VLAN if the tag in the packet header is concurrent with this protocol. This packet header information is defined by the Systems Network Architecture (SNA) 802.2 Protocol.</p> <p><i>netBios</i> – Using this parameter will instruct the Switch to forward packets to this VLAN if the tag in the packet header is concurrent with this protocol. This packet header information is defined by the NetBIOS Protocol.</p> <p><i>xns</i> – Using this parameter will instruct the Switch to forward packets to this VLAN if the tag in the packet header is concurrent with this protocol. This packet header information is defined by the Xerox Network Systems (XNS) Protocol.</p> <p><i>vines</i> – Using this parameter will instruct the Switch to forward packets to this VLAN if the tag in the packet header is concurrent with this protocol. This packet header information is defined by the Banyan Virtual Integrated Network Service (VINES) Protocol.</p> <p><i>ipV6</i> – Using this parameter will instruct the Switch to forward packets to this VLAN if the tag in the packet header is concurrent with this protocol. This packet header information is defined by the Internet Protocol Version 6 (IPv6) Protocol.</p> <p><i>userDefined</i> – Using this parameter will instruct the Switch to forward packets to this VLAN if the tag in the packet header is concurrent with this protocol defined by the user. This packet header information is defined by entering the following information:</p>

User Defined Pid – Specifies that the VLAN will only accept packets with this hexadecimal 802.1Q Ethernet type value in the packet header. The user may define an entry, in the hexadecimal form (ffff) to define the packet identification. (The user only need enter the final four integers of the hexadecimal format to define the packet ID –{hex 0x0 0xffff}) This field is only operable if *userDefined* is selected in the Protocol ID field.

encap [ethernet | llc | snap | all] – Specifies that the Switch will examine the octet of the packet header referring to one of the protocols listed (Ethernet, LLC or SNAP), looking for a match of the hexadecimal value previously entered. *all* will instruct the Switch to examine the total packet header. After a match is found, the Switch will forward the packet to this VLAN. This field is only operable if *userDefined* is selected in the Protocol ID field.

Port Settings

Allows an individual port to be specified as member of a VLAN.

Tag

Specifies the port as either 802.1Q tagging or 802.1Q untagged. Checking the box will designate the port as Tagged.

None

Allows an individual port to be specified as a non-VLAN member.

Egress

Select this to specify the port as a static member of the VLAN. Egress member ports are ports that will be transmitting traffic for the VLAN. These ports can be either tagged or untagged.

Forbidden

Select this to specify the port as not being a member of the VLAN and that the port is forbidden from becoming a member of the VLAN dynamically.

Click **Apply** to implement changes made. Click the [Show All Static VLAN Entries](#) link to return to the **Current 802.1Q Static VLAN Entries** window.

GVRP Setting

In the **Configuration** menu, open the **VLANs** folder and click **GVRP Setting**.

The **802.1Q Port Settings** dialog box, shown below, allows you to determine whether the Switch will share its VLAN configuration information with other GARP VLAN Registration Protocol (GVRP) enabled switches. In addition, **Ingress Checking** can be used to limit traffic by filtering incoming packets whose PVID does not match the PVID of the port. Results can be seen in the table under the configuration settings, as seen below.

GVRP Settings							
Unit	From	To	GVRP	Ingress Check	Acceptable Frame Type	PVID	Apply
1	Port 1	Port 1	Disabled	Enabled	Admit_All		Apply

GVRP Table				
Port	PVID	GVRP	Ingress Check	Acceptable Frame Type
1	1	Disabled	Enabled	All Frames
2	1	Disabled	Enabled	All Frames
3	1	Disabled	Enabled	All Frames
4	1	Disabled	Enabled	All Frames
5	1	Disabled	Enabled	All Frames
6	1	Disabled	Enabled	All Frames
7	1	Disabled	Enabled	All Frames
8	1	Disabled	Enabled	All Frames
9	1	Disabled	Enabled	All Frames
10	1	Disabled	Enabled	All Frames
11	1	Disabled	Enabled	All Frames
12	1	Disabled	Enabled	All Frames
13	1	Disabled	Enabled	All Frames
14	1	Disabled	Enabled	All Frames
15	1	Disabled	Enabled	All Frames
16	1	Disabled	Enabled	All Frames
17	1	Disabled	Enabled	All Frames
18	1	Disabled	Enabled	All Frames
19	1	Disabled	Enabled	All Frames
20	1	Disabled	Enabled	All Frames
21	1	Disabled	Enabled	All Frames
22	1	Disabled	Enabled	All Frames
23	1	Disabled	Enabled	All Frames
24	1	Disabled	Enabled	All Frames

Figure 6- 43. GVRP Settings and Table window

The following fields can be set:

Parameter	Description
Unit	Choose the Switch ID number of the Switch in the switch stack to be modified.
From/To	These two fields allow you to specify the range of ports that will be included in the Port-based VLAN that you are creating using the 802.1Q Static VLANs page.
GVRP	The Group VLAN Registration Protocol (GVRP) enables the port to dynamically become a member of a VLAN. GVRP is <i>Disabled</i> by default.
Ingress Check	This field can be toggled using the space bar between <i>Enabled</i> and <i>Disabled</i> . <i>Enabled</i> enables the port to compare the VID tag of an incoming packet with the PVID number assigned to the port. If the two are different, the port filters (drops) the packet. <i>Disabled</i> disables ingress filtering. Ingress Checking is <i>Disabled</i> by default.
Acceptable Frame Type	This field denotes the type of frame that will be accepted by the port. The user may choose between <i>Tagged Only</i> , which means only VLAN tagged frames will be accepted, and <i>Admit_All</i> , which means both tagged and untagged frames will be accepted. <i>Admit_All</i> is enabled by default.
PVID	The read only field in the GVRP Table shows the current PVID assignment for each port, which may be manually assigned to a VLAN when created in the 802.1Q Static VLANs table. The Switch's default is to assign all ports to the default VLAN with a VID of 1. The PVID is used by the port to tag outgoing, untagged packets, and to make filtering decisions about incoming packets. If the port is specified to accept only tagged frames – as tagging, and an untagged packet is forwarded to the port for transmission, the port will add an 802.1Q tag using the PVID to write the VID in the tag. When the packet arrives at its destination, the receiving device will use the PVID to make VLAN forwarding decisions. If a packet is received by the port, and Ingress filtering is enabled, the port will compare the VID of the incoming packet to its PVID. If the two are unequal, the port will drop the packet. If the two are equal, the port will receive the packet.

Click **Apply** to implement changes made.

6-15 Traffic Control

Use the **Traffic Control** menu to enable or disable storm control and adjust the threshold for multicast and broadcast storms, as well as DLF (Destination Look Up Failure). Traffic control settings are applied to individual Switch modules.

To view the following window, click **Configuration > Traffic Control**:

Traffic Control Settings							
Unit	From	To	Broadcast Storm	Multicast Storm	DA-Unknow	Threshold	Apply
1	Port 1	Port 1	Disabled	Disabled	Disabled	128	Apply

Traffic Control Table-Unit 1				
Port	Broadcast Storm	Multicast Storm	DA-Unknow	Threshold
1	Disabled	Disabled	Disabled	128
2	Disabled	Disabled	Disabled	128
3	Disabled	Disabled	Disabled	128
4	Disabled	Disabled	Disabled	128
5	Disabled	Disabled	Disabled	128
6	Disabled	Disabled	Disabled	128
7	Disabled	Disabled	Disabled	128
8	Disabled	Disabled	Disabled	128
9	Disabled	Disabled	Disabled	128
10	Disabled	Disabled	Disabled	128
11	Disabled	Disabled	Disabled	128
12	Disabled	Disabled	Disabled	128
13	Disabled	Disabled	Disabled	128
14	Disabled	Disabled	Disabled	128
15	Disabled	Disabled	Disabled	128
16	Disabled	Disabled	Disabled	128
17	Disabled	Disabled	Disabled	128
18	Disabled	Disabled	Disabled	128
19	Disabled	Disabled	Disabled	128
20	Disabled	Disabled	Disabled	128
21	Disabled	Disabled	Disabled	128
22	Disabled	Disabled	Disabled	128
23	Disabled	Disabled	Disabled	128
24	Disabled	Disabled	Disabled	128

Figure 6- 44. Traffic Control Settings and Traffic Control Table window

To configure **Traffic Control**, first select the Switch's **Unit** ID number from the pull down menu and then a group of ports by using the **Group** pull down menu. Finally, enable or disable the **Broadcast Storm**, **Multicast Storm** and **Destination Unknown** using their corresponding pull-down menus.

The purpose of this window is to limit too many broadcast, multicast or unknown unicast packets flooding the network. Each port has a counter that tracks the number of broadcast packets received per second, and this counter is cleared once every second. If the broadcast, multicast or unknown unicast storm control is enabled, the port will discard all broadcast, multicast or unknown unicast packets received when the counter exceeds or equals the Threshold specified.

The **Threshold** value is the upper threshold at which the specified traffic control is switched on. This is the number of Broadcast, Multicast or DLF packets, in Kpps (kilopackets per second), received by the Switch that will trigger the storm traffic control measures. The **Threshold** value can be set from 0 to 255 kilopackets per second. The default setting is 128. The settings of each port may be viewed in the **Traffic Control Table** in the same window. Click **Apply** to implement changes made.

6-16 Port Security

A given port's (or a range of ports') dynamic MAC address learning can be locked such that the current source MAC addresses entered into the MAC address forwarding table can not be changed once the port lock is enabled. The port can be locked by using the **Admin State** pull-down menu to *Enabled*, and clicking **Apply**.

Port Security is a security feature that prevents unauthorized computers (with source MAC addresses) unknown to the Switch prior to locking the port (or ports) from connecting to the Switch's locked ports and gaining access to the network.

Unit	From	To	Admin State	Max. Addr(0-64)	Mode	Apply
1	Port 1	Port 1	Disabled	0	DeleteOnReset	Apply

Port Security Table -Unit 1			
Port	Admin State	Max.Learning Addr	Lock Address Mode
1	Disabled	1	DeleteOnReset
2	Disabled	1	DeleteOnReset
3	Disabled	1	DeleteOnReset
4	Disabled	1	DeleteOnReset
5	Disabled	1	DeleteOnReset
6	Disabled	1	DeleteOnReset
7	Disabled	1	DeleteOnReset
8	Disabled	1	DeleteOnReset
9	Disabled	1	DeleteOnReset
10	Disabled	1	DeleteOnReset
11	Disabled	1	DeleteOnReset
12	Disabled	1	DeleteOnReset
13	Disabled	1	DeleteOnReset
14	Disabled	1	DeleteOnReset
15	Disabled	1	DeleteOnReset
16	Disabled	1	DeleteOnReset
17	Disabled	1	DeleteOnReset
18	Disabled	1	DeleteOnReset
19	Disabled	1	DeleteOnReset
20	Disabled	1	DeleteOnReset
21	Disabled	1	DeleteOnReset
22	Disabled	1	DeleteOnReset
23	Disabled	1	DeleteOnReset
24	Disabled	1	DeleteOnReset

Figure 6- 45. Port Security Settings and Port Security Table window

The following parameters can be set:

Parameter	Description
Unit	Choose the Switch ID number of the Switch in the switch stack to be modified.
From/To	A consecutive group of ports may be configured starting with the selected port.
Admin State	This pull-down menu allows you to enable or disable Port Security (locked MAC address table for the selected ports).
Max. Learning Addr. (0-64)	The number of MAC addresses that will be in the MAC address forwarding table for the selected switch and group of ports.
Mode	This pull-down menu allows you to select how the MAC address table locking will be implemented on the Switch, for the selected group of ports. The options are: <i>Permanent</i> – The locked addresses will not age out after the aging timer expires. <i>DeleteOnTimeout</i> – The locked addresses will age out after the aging timer expires. <i>DeleteOnReset</i> – The locked addresses will not age out until the Switch has been reset.

Click **Apply** to implement changes made.

6-17 Port Lock Entries

The **Port Lock Entry Delete** window is used to remove an entry from the port security entries learned by the Switch and entered into the forwarding database. To view the following window, click **Configuration > Port Lock Entries**:

Port Lock Entries Table						
VID	VLAN Name	MAC Address	Unit	Port	Type	Delete
1	default	00-00-80-c8-09-89	1	11	Secured_Permanent	X
1	default	00-01-30-10-00-0b	1	11	Secured_Permanent	X
1	default	00-02-06-12-34-56	1	11	Secured_Permanent	X
1	default	00-02-a5-9a-f5-61	1	11	Secured_Permanent	X
1	default	00-03-09-18-10-01	1	11	Secured_Permanent	X
1	default	00-04-13-04-03-01	1	11	Secured_Permanent	X
1	default	00-05-5d-ed-84-ea	1	11	Secured_Permanent	X
1	default	00-06-01-01-01-00	1	11	Secured_Permanent	X
1	default	00-08-02-54-0e-9d	1	11	Secured_Permanent	X
1	default	00-08-02-54-0f-ce	1	11	Secured_Permanent	X
1	default	00-0c-6e-12-e1-1a	1	11	Secured_Permanent	X
1	default	00-0c-6e-1f-9c-aa	1	11	Secured_Permanent	X
1	default	00-0c-6e-35-90-ee	1	11	Secured_Permanent	X
1	default	00-0c-6e-d5-5b-f0	1	11	Secured_Permanent	X
1	default	00-0c-eb-20-90-01	1	11	Secured_Permanent	X
1	default	00-0c-eb-3e-e0-0d	1	11	Secured_Permanent	X
1	default	00-0c-eb-42-c0-01	1	11	Secured_Permanent	X
1	default	00-0c-eb-44-10-01	1	11	Secured_Permanent	X
1	default	00-0e-a6-01-d5-6c	1	11	Secured_Permanent	X
1	default	00-0e-a6-11-7c-5f	1	11	Secured_Permanent	X

Next

Figure 6- 46. Port Lock Entries Table

This function is only operable if the **Mode** in the **Port Security** window is selected as **Permanent** or **DeleteOnReset**, or in other words, only addresses that are permanently learned by the Switch can be deleted. Once the entry has been defined by entering the correct information into the window above, click the **X** under the Delete heading of the corresponding MAC address to be deleted. Click the **Next** button to view the next page of entries listed in this table. This window displays the following information:

Parameter	Description
VID	The VLAN ID of the entry in the forwarding database table that has been permanently learned by the Switch.
VLAN NAME	The VLAN Name of the entry in the forwarding database table that has been permanently learned by the Switch.
MAC Address	The MAC address of the entry in the forwarding database table that has been permanently learned by the Switch.
Unit	The ID number of the Switch in the switch stack that has permanently learned the MAC address.
Port	The ID number of the port that has permanently learned the MAC address.
Type	The type of MAC address in the forwarding database table. Only entries marked Secured_Permanent can be deleted.
Delete	Click the X in this field to delete the corresponding MAC address that was permanently learned by the Switch.

The AT-9724TS supports 802.1p priority queuing Quality of Service. The following section discusses the implementation of QoS (Quality of Service) and benefits of using 802.1p priority queuing.

The Advantages of QoS

QoS is an implementation of the IEEE 802.1p standard that allows network administrators a method of reserving bandwidth for important functions that require a large bandwidth or have a high priority, such as VoIP (voice-over Internet Protocol), web browsing applications, file server applications or video conferencing. Not only can a larger bandwidth be created, but other less critical traffic can be limited, so excessive bandwidth can be saved. The Switch has separate hardware queues on every physical port to which packets from various applications can be mapped to, and, in turn prioritized. View the following map to see how the AT-9724TS implements 802.1p priority queuing.

How 802.1p works (Switch default settings)

7 priority queues

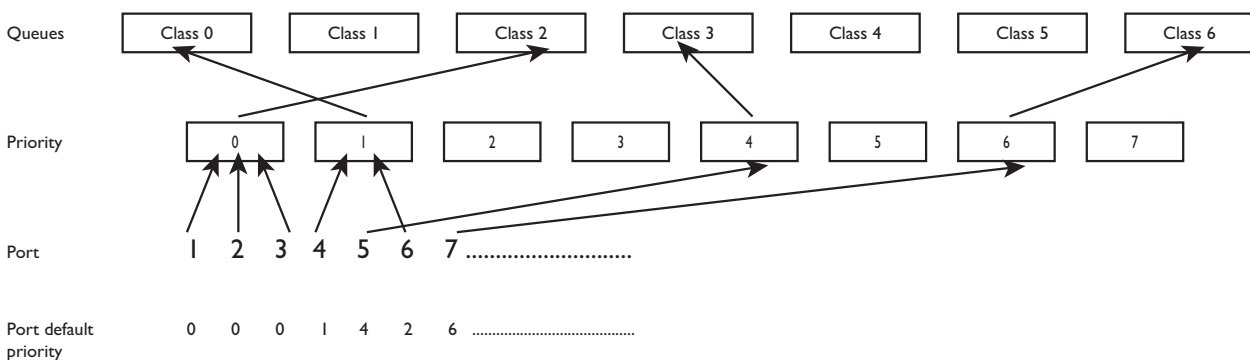

Figure 6- 47. Mapping QoS on the Switch

The picture above shows the default priority setting for the Switch. Class-6 has the highest priority of the seven priority classes of service on the Switch. In order to implement QoS, the user is required to instruct the Switch to examine the header of a packet to see if it has the proper identifying tag tagged. Then the user may forward these tagged packets to designated classes of service on the Switch where they will be emptied, based on priority.

For example, lets say a user wishes to have a video conference between two remotely set computers. The administrator can add priority tags to the video packets being sent out, utilizing the Access Profile commands. Then, on the receiving end, the administrator instructs the Switch to examine packets for this tag, acquires the tagged packets and maps them to a class queue on the Switch. Then in turn, the administrator will set a priority for this queue so that will be emptied before any other packet is forwarded. This results in the end user receiving all packets sent as quickly as possible, thus prioritizing the queue and allowing for an uninterrupted stream of packets, which optimizes the use of bandwidth available for the video conference.

Understanding QoS

The Switch has eight priority classes of service, one of which is internal and unconfigurable. These priority classes of service are labelled as 6, the high class to 0, the lowest class. The eight priority tags, specified in IEEE 802.1p are mapped to the Switch's priority classes of service as follows:

- Priority 0 is assigned to the Switch's Q2 class.
- Priority 1 is assigned to the Switch's Q0 class.
- Priority 2 is assigned to the Switch's Q1 class.
- Priority 3 is assigned to the Switch's Q3 class.
- Priority 4 is assigned to the Switch's Q4 class.
- Priority 5 is assigned to the Switch's Q5 class.
- Priority 6 is assigned to the Switch's Q6 class.
- Priority 7 is assigned to the Switch's Q6 class.

For strict priority-based scheduling, any packets residing in the higher priority classes of service are transmitted first. Multiple strict priority classes of service are emptied based on their priority tags. Only when these classes are empty, are packets of lower priority transmitted.

For weighted round-robin queuing, the number of packets sent from each priority queue depends upon the assigned weight. For a configuration of 8 CoS queues, Allied Telesyn AT-9724TS High-Density Layer 3 Stackable Gigabit Ethernet Switch

A~H with their respective weight value: 8~1, the packets are sent in the following sequence: A1, B1, C1, D1, E1, F1, G1, H1, A2, B2, C2, D2, E2, F2, G2, A3, B3, C3, D3, E3, F3, A4, B4, C4, D4, E4, A5, B5, C5, D5, A6, B6, C6, A7, B7, A8, B8, A1, B1, C1, D1, E1, F1, G1, H1.

For weighted round-robin queuing, if each CoS queue has the same weight value, then each CoS queue has an equal opportunity to send packets just like round-robin queuing.

For weighted round-robin queuing, if the weight for a CoS is set to 0, then it will continue processing the packets from this CoS until there are no more packets for this CoS. The other CoS queues that have been given a nonzero value, and depending upon the weight, will follow a common weighted round-robin scheme.

Remember that the AT-9724TS has 7 configurable priority queues (and seven Classes of Service) for each port on the Switch.

Caution: The Switch contains eight classes of service for each port on the Switch. One of these classes is reserved for internal use on the Switch and is therefore unconfigurable. All references in the following section regarding classes of service will refer to only the seven classes of service that may be used and configured by the Switch's Administrator.

Bandwidth Control

The bandwidth control settings are used to place a ceiling on the transmitting and receiving data rates for any selected port. In the **Configuration** folder, click **Bandwidth Control**, to view the screen shown below.

Unit	From	To	Type	no_limit	Rate	Apply
1	Port1	Port1	Both	Disabled	1	Apply

Port Bandwidth Table-Unit 1		
Port	RX Rate (Mbit/sec)	TX Rate (Mbit/sec)
1	no_limit	no_limit
2	no_limit	no_limit
3	no_limit	no_limit
4	no_limit	no_limit
5	no_limit	no_limit
6	no_limit	no_limit
7	no_limit	no_limit
8	no_limit	no_limit
9	no_limit	no_limit
10	no_limit	no_limit
11	no_limit	no_limit
12	no_limit	no_limit
13	no_limit	no_limit
14	no_limit	no_limit
15	no_limit	no_limit
16	no_limit	no_limit
17	no_limit	no_limit
18	no_limit	no_limit
19	no_limit	no_limit
20	no_limit	no_limit
21	no_limit	no_limit
22	no_limit	no_limit
23	no_limit	no_limit
24	no_limit	no_limit

Figure 6- 48. Bandwidth Settings and Port Bandwidth Table

The following parameters can be set or are displayed:

Parameter	Description
Unit	Choose the Switch ID number of the Switch in the switch stack to be modified.
From/To	A consecutive group of ports may be configured starting with the selected port.
Type	This drop-down menu allows you to select between RX (receive,) TX (transmit,) and Both. This setting will determine whether the bandwidth ceiling is applied to receiving, transmitting, or both receiving and transmitting packets.
no_limit	This drop-down menu allows you to specify that the selected port will have no bandwidth limit. Enabled disables the limit.
Rate	This field allows you to enter the data rate, in Mbit/s, that will be the limit for the selected port.

Click **Apply** to set the bandwidth control for the selected ports. Results of configured **Bandwidth Settings** will be displayed in the **Port Bandwidth Table**.

QoS Scheduling Mechanism

This drop-down menu allows you to select between a **Weight Fair** and a **Strict** mechanism for emptying the classes of service. In the **Configuration** folder open the **QoS** folder and click **QoS Scheduling Mechanism**, to view the screen shown below.



Figure 6- 49. Scheduling Mechanism Configuration and QoS Scheduling Mechanism Table

The **Scheduling Mechanism** has the following parameters.

Parameter	Description
Strict	The highest queue is the first to process traffic. That is, the highest queue will finish before other queues empty.
Weight fair	Use the weighted round-robin (WRR) algorithm to handle packets in an even distribution in priority queues.

Click **Apply** to let your changes take effect.

Output Scheduling

QoS can be customized by changing the output scheduling used for the classes of service in the Switch. As with any changes to QoS implementation, careful consideration should be given to how network traffic in lower classes of service is affected. Changes in scheduling may result in unacceptable levels of packet loss or significant transmission delay. If you choose to customize this setting, it is important to monitor network performance, especially during peak demand, as bottlenecks can quickly develop if the QoS settings are not suitable. In the **Configuration** folder open the **QoS** folder and click **QoS Output Scheduling**, to view the screen shown below.

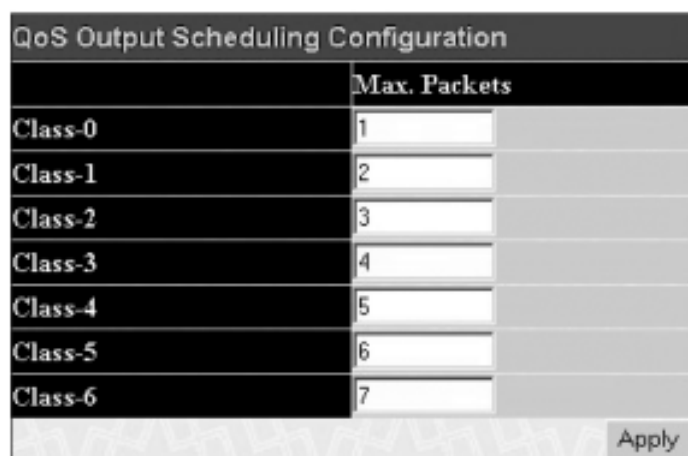



Figure 6- 50. QoS Output Scheduling Configuration window

You may assign the following values to the QoS classes to set the scheduling.

Parameter	Description
Max. Packets	Specifies the maximum number of packets the above specified hardware priority queue will be allowed to transmit before allowing the next lowest priority queue to transmit its packets. A value between 0 and 15 can be specified.

Click **Apply** to implement changes made.

 **Note:** Entering a 0 for the **Max Packets** field in the **QoS Output Scheduling Configuration** window above will create a Combination Queue. For more information on implementation of this feature, see the next section, **Configuring the Combination Queue**.

Configuring the Combination Queue

Utilizing the **QoS Output Scheduling Configuration** window shown above, the AT-9724TS can implement a combination queue for forwarding packets. This combination queue allows for a combination of strict and weight-fair (weighted round-robin "WRR") scheduling for emptying given classes of service. To set the combination queue, enter a 0 for the Max Packets entry of the corresponding priority classes of service listed in the window above. Priority classes of service that have a 0 in the Max Packet field will forward packets with strict priority scheduling. The remaining classes of service, that do not have a 0 in their **Max Packet** field, will follow a weighted round-robin (WRR) method of forwarding packets – as long as the priority classes of service with a 0 in their **Max Packet** field are empty. When a packet arrives in a priority class with a 0 in its **Max Packet** field, this class of service will automatically begin forwarding packets until it is empty. Once a priority class of service with a 0 in its **Max Packet** field is empty, the remaining priority classes of service will reset the weighted round-robin (WRR) cycle of forwarding packets, starting with the highest available priority class of service. Priority classes of service with an equal level of priority and equal entries in their Max Packet field will empty their fields based on hardware priority scheduling. The **Max Packet** parameter allows you to specify the maximum number of packets a given priority class of service can transmit per weighted round-robin (WRR) scheduling cycle. This provides for a controllable CoS behavior while allowing other classes to empty as well. A value between 0 and 15 packets can be specified per priority class of service to create the combination queue.

The example window below displays an example of the combination queue where Class-1 will have a strict priority for emptying its class, while the other classes will follow a weight fair scheduling.

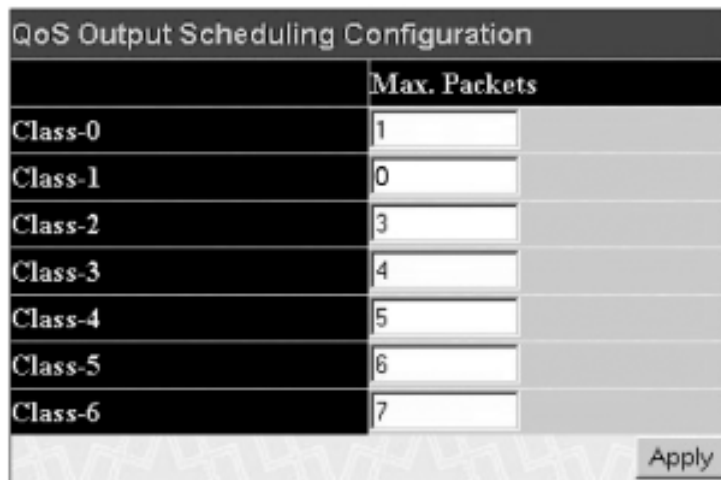

Figure 6- 51. QoS Output Scheduling Configuration window – Combination queue example

802. Ip Default Priority

The Switch allows the assignment of a default 802.Ip priority to each port on the Switch. In the **Configuration** folder open the **QoS** folder and click **802. Ip Default Priority**, to view the screen shown below.

Unit	From	To	Priority(0-7)	Apply
1	Port 1	Port 1	0	Apply

The Port Priority Table-Unit 1	
Port	Priority
1	0
2	0
3	0
4	0
5	0
6	0
7	0
8	0
9	0
10	0
11	0
12	0
13	0
14	0
15	0
16	0
17	0
18	0
19	0
20	0
21	0
22	0
23	0
24	0

Figure 6- 52. Port Default Priority Assignment and The Port Priority Table window

This page allows you to assign a default 802.Ip priority to any given port on the Switch. The priority queues are numbered from 0, the lowest priority, to 7, the highest priority. To implement a new default priority, choose the Switch of the Switch stack to be configured by using the **Unit** pull-down menu, choose a port range by using the **From** and **To** pull-down menus and then insert a priority value, from 0-7 in the **Priority** field. Click **Apply** to implement your settings.

802. Ip User Priority

The AT-9724TS allows the assignment of classes of service to each of the 802.Ip priorities. In the **Configuration** folder open the **QoS** folder and click **802. Ip User Priority**, to view the screen shown below.

User Priority Configuration	
Priority-0	Class-2
Priority-1	Class-0
Priority-2	Class-1
Priority-3	Class-3
Priority-4	Class-4
Priority-5	Class-5
Priority-6	Class-6
Priority-7	Class-6

Apply

Figure 6- 53. User Priority Configuration window

Once you have assigned a priority to the port groups on the Switch, you can then assign this Class to each of the 7 levels of 802.1p priorities. Click **Apply** to set your changes.

Traffic Segmentation

Traffic segmentation is used to limit traffic flow from a single port to a group of ports on either a single Switch (in standalone mode) or a group of ports on another switch in a switch stack. This method of segmenting the flow of traffic is similar to using VLANs to limit traffic, but is more restrictive. It provides a method of directing traffic that does not increase the overhead of the Master switch CPU.

In the Configuration folder open the **QoS** folder and click **Traffic Segmentation**, to view the screen shown below.

Unit	Port Map
1	1-24
2	1-24
3	
4	
5	
6	
7	
8	
9	
10	
11	
12	

Figure 6- 54. Current Traffic Segmentation Table

Click on the **Setup** button to open the **Setup Forwarding Ports** page, as shown below.

Unit	Port	Apply
1	Port 1	Apply

Unit	1
Forward Port	<input checked="" type="checkbox"/> 1 <input checked="" type="checkbox"/> 2 <input checked="" type="checkbox"/> 3 <input checked="" type="checkbox"/> 4 <input checked="" type="checkbox"/> 5 <input checked="" type="checkbox"/> 6 <input checked="" type="checkbox"/> 7 <input checked="" type="checkbox"/> 8 <input checked="" type="checkbox"/> 9 <input checked="" type="checkbox"/> 10 <input checked="" type="checkbox"/> 11 <input checked="" type="checkbox"/> 12 <input checked="" type="checkbox"/> 13 <input checked="" type="checkbox"/> 14 <input checked="" type="checkbox"/> 15 <input checked="" type="checkbox"/> 16 <input checked="" type="checkbox"/> 17 <input checked="" type="checkbox"/> 18 <input checked="" type="checkbox"/> 19 <input checked="" type="checkbox"/> 20 <input checked="" type="checkbox"/> 21 <input checked="" type="checkbox"/> 22 <input checked="" type="checkbox"/> 23 <input checked="" type="checkbox"/> 24

View Settings of Unit 1 Port 1

Figure 6- 55. Setup Forwarding Ports window

This page allows you to determine which port on a given switch in a switch stack will be allowed to forward packets to other ports on that switch.

Configuring traffic segmentation on the AT-9724TS is accomplished in two parts. First, you specify a switch from a switch stack by using the **Unit** pull-down menu, and then a port from that switch, using the **Port** pull-down menu. Then specify a second switch from the switch stack, and then you select which ports (or different ports on the same switch,) on that switch that you want to be able to receive packets from the switch and port you specified in the first part.

Clicking the **Apply** button will enter the combination of transmitting port and allowed receiving ports into the Switch's Traffic Segmentation table.

The **Unit** drop-down menu at the top of the page allows you to select a switch from a switch stack using that switch's Unit ID. The **Port** drop-down menu allows you to select a port from that switch. This is the port that will be transmitting packets.

The **Unit** drop-down menu under the Setup Forwarding ports heading allows you to select a switch from a switch stack using that switch's Unit ID. The **Forward Port** click boxes allow you to select which of the ports on the selected switch will be able to forward packets. These are the ports that will be allowed to receive packets from the port specified above.

Click **Apply** to enter the settings into the Switch's **Traffic Segmentation** table.

Clicking the **Apply** button will enter the combination of transmitting port and allowed receiving ports into the Switch's **Traffic Segmentation Table**.

6-19 System Log Server

The Switch can send Syslog messages to up to four designated servers using the **System Log Server**. In the **Configuration** folder, click **System Log Server**, to view the screen shown below.

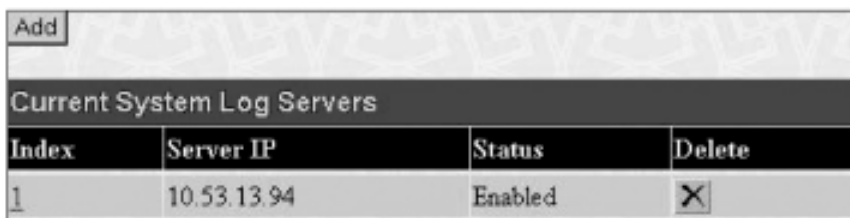

The screenshot shows a window titled "Current System Log Servers". At the top left is an "Add" button. Below the title is a table with four columns: "Index", "Server IP", "Status", and "Delete". There is one row in the table with the following values: Index: 1, Server IP: 10.53.13.94, Status: Enabled, and Delete: a button with an 'X' icon.

Index	Server IP	Status	Delete
1	10.53.13.94	Enabled	X

Figure 6- 56. System Log Servers window

The parameters configured for adding and editing **System Log Server** settings are the same. To add a new Syslog Server, click the **Add** button. To modify a current entry, click the hyperlinked number of the server in the **Index** field. Both actions will result in the same screen to configure. See the table below for a description of the parameters in the following window.

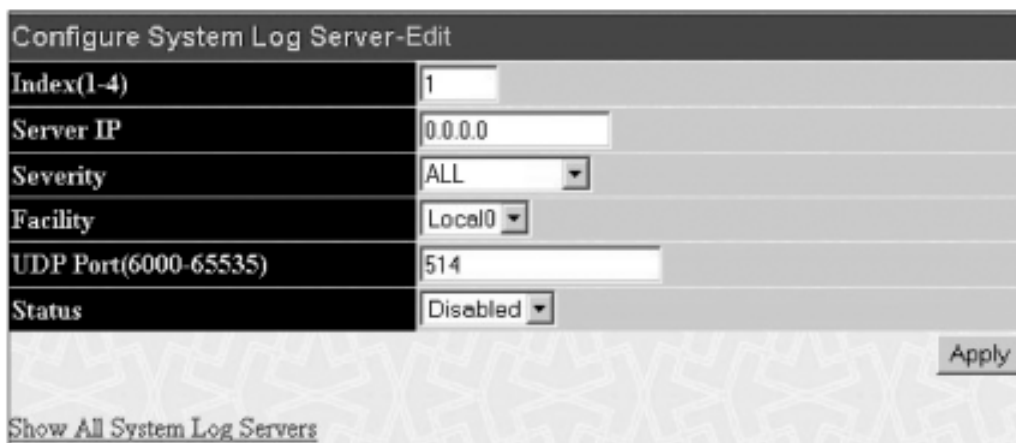

The screenshot shows a configuration window titled "Configure System Log Server-Edit". It contains several fields for configuration:

Index(1-4)	1
Server IP	0.0.0.0
Severity	ALL
Facility	Local0
UDP Port(6000-65535)	514
Status	Disabled

At the bottom right is an "Apply" button. At the bottom left is a link that says "Show All System Log Servers".

Figure 6- 57. System Log Servers – Add

The following parameters can be set:

Parameter	Description																																																
Index	Syslog server settings index (1-4).																																																
Server IP	The IP address of the Syslog server.																																																
Severity	This drop-down menu allows you to select the level of messages that will be sent. The options are <i>Warning</i> , <i>Informational</i> , and <i>All</i> .																																																
Facility	<p>Some of the operating system daemons and processes have been assigned Facility values. Processes and daemons that have not been explicitly assigned a Facility may use any of the "local use" facilities or they may use the "user-level" Facility. Those Facilities that have been designated are shown in the following: Bold font denotes the facility values that the Switch currently implements.</p> <table border="1"> <thead> <tr> <th>Numerical Code</th> <th>Facility</th> </tr> </thead> <tbody> <tr><td>0</td><td>kernel messages</td></tr> <tr><td>1</td><td>user-level messages</td></tr> <tr><td>2</td><td>mail system</td></tr> <tr><td>3</td><td>system daemons</td></tr> <tr><td>4</td><td>security/authorization messages</td></tr> <tr><td>5</td><td>messages generated internally by syslog line printer subsystem</td></tr> <tr><td>7</td><td>network news subsystem</td></tr> <tr><td>8</td><td>UUCP subsystem</td></tr> <tr><td>9</td><td>clock daemon</td></tr> <tr><td>10</td><td>security/authorization messages</td></tr> <tr><td>11</td><td>FTP daemon</td></tr> <tr><td>12</td><td>NTP subsystem</td></tr> <tr><td>13</td><td>log audit</td></tr> <tr><td>14</td><td>log alert</td></tr> <tr><td>15</td><td>clock daemon</td></tr> <tr><td>16</td><td>local use 0 (local0)</td></tr> <tr><td>17</td><td>local use 1 (local1)</td></tr> <tr><td>18</td><td>local use 2 (local2)</td></tr> <tr><td>19</td><td>local use 3 (local3)</td></tr> <tr><td>20</td><td>local use 4 (local4)</td></tr> <tr><td>21</td><td>local use 5 (local5)</td></tr> <tr><td>22</td><td>local use 6 (local6)</td></tr> <tr><td>23</td><td>local use 7 (local7)</td></tr> </tbody> </table>	Numerical Code	Facility	0	kernel messages	1	user-level messages	2	mail system	3	system daemons	4	security/authorization messages	5	messages generated internally by syslog line printer subsystem	7	network news subsystem	8	UUCP subsystem	9	clock daemon	10	security/authorization messages	11	FTP daemon	12	NTP subsystem	13	log audit	14	log alert	15	clock daemon	16	local use 0 (local0)	17	local use 1 (local1)	18	local use 2 (local2)	19	local use 3 (local3)	20	local use 4 (local4)	21	local use 5 (local5)	22	local use 6 (local6)	23	local use 7 (local7)
Numerical Code	Facility																																																
0	kernel messages																																																
1	user-level messages																																																
2	mail system																																																
3	system daemons																																																
4	security/authorization messages																																																
5	messages generated internally by syslog line printer subsystem																																																
7	network news subsystem																																																
8	UUCP subsystem																																																
9	clock daemon																																																
10	security/authorization messages																																																
11	FTP daemon																																																
12	NTP subsystem																																																
13	log audit																																																
14	log alert																																																
15	clock daemon																																																
16	local use 0 (local0)																																																
17	local use 1 (local1)																																																
18	local use 2 (local2)																																																
19	local use 3 (local3)																																																
20	local use 4 (local4)																																																
21	local use 5 (local5)																																																
22	local use 6 (local6)																																																
23	local use 7 (local7)																																																
UDP Port (514 or 6000-65535)	Type the UDP port number used for sending Syslog messages. The default is 514.																																																
Status	Choose Enabled or Disabled to activate or deactivate.																																																

To set the System Log Server configuration, click **Apply**. To delete an entry from the **Current System Log Server** window, click the corresponding **X** under the **Delete** heading of the entry to delete. To return to the **Current System Log Servers** window, click the [Show All System Log Servers](#) link.

6-20 SNTP Settings

Current Time Settings

To configure the time settings for the Switch, open the **Configuration** folder, then the **SNTP** folder and click on the **Current Time Setting** link, revealing the following screen for the user to configure.

The screenshot displays three configuration panels. The first panel, 'Current Time: Status', shows 'System Boot Time' as 21 Jul 2004 08:30:09, 'Current Time' as 21 Jul 2004 09:09:50, and 'Time Source' as System Clock. The second panel, 'Current Time: SNTP Settings', includes a dropdown for 'SNTP State' set to 'Disabled', text boxes for 'SNTP Primary Server' and 'SNTP Secondary Server' both containing '0.0.0.0', and a text box for 'SNTP Poll Interval in Seconds(30-99999)' set to '720'. An 'Apply' button is at the bottom right. The third panel, 'Current Time: Set Current Time', features dropdowns for 'Year' (2002), 'Month' (January), and 'Day' (01), and three dropdowns for 'Time in HH MM SS' (00, 00, 00). An 'Apply' button is also present at the bottom right.

Figure 6- 58. Time Settings Page

The following parameters can be set or are displayed:

Parameter	Description
Current Time: Status	
System Boot Time	Displays the time when the Switch was initially started for this session.
Current Time	Displays the current time.
Time Source	Displays the source of the time settings viewed here.
Current Time: SNTP Settings	
SNTP State	Use this pull-down menu to Enable or Disable SNTP.
SNTP Primary Server	This is the IP address of the primary server the SNTP information will be taken from.
SNTP Secondary Server	This is the IP address of the secondary server the SNTP information will be taken from.
SNTP Poll Interval in Seconds (30-99999)	This is the interval, in seconds, between requests for updated SNTP information.
Current Time: Set Current Time	
Year	Enter the current year, if you want to update the system clock.
Month	Enter the current month, if you would like to update the system clock.
Day	Enter the current day, if you would like to update the system clock.
Time in HH MM SS	Enter the current time in hours and minutes, if you would like to update the system clock.

Click **Apply** to implement your changes.

Time Zone and DST

The following are screens used to configure time zones and Daylight Savings time settings for SNTP. Open the **Configuration** folder, then the **SNTP** folder and click on the **Time Zone and DST** link, revealing the following screen.

The screenshot shows the 'Time Zone and DST Settings' configuration window. It is organized into three main sections:

- Time Zone and DST Settings:**
 - Daylight Saving Time State: Disabled (dropdown)
 - Daylight Saving Time Offset in Minutes: 60 (dropdown)
 - Time Zone Offset from GMT in +/- HH:MM: + 00:00 (dropdowns)
- DST Repeating Settings:**
 - From Which Day: First (dropdown)
 - From Day of Week: Sunday (dropdown)
 - From Month: April (dropdown)
 - From time in HH:MM: 00:00 (dropdowns)
 - To Which Day: Last (dropdown)
 - To Day of Week: Sunday (dropdown)
 - To Month: October (dropdown)
 - To time in HH:MM: 00:00 (dropdowns)
- DST Annual Settings:**
 - From Month: April (dropdown)
 - From Day: 29 (dropdown)
 - From time in HH:MM: 00:00 (dropdowns)
 - To Month: October (dropdown)
 - To Day: 12 (dropdown)
 - To Time in HH:MM: 00:00 (dropdowns)

An 'Apply' button is located at the bottom right of the window.

Figure 6- 59. Time Zone and DST Settings Page

The following parameters can be set:

Parameter	Description
Daylight Saving Time State	Use this pull-down menu to Enable or Disable the DST Settings.
Daylight Saving Time Offset in Minutes	Use this pull-down menu to specify the amount of time that will constitute your local DST offset - 30, 60, 90, or 120 minutes.
Time Zone Offset from GMT in +/- HH:MM	Use these pull-down menus to specify your local time zone's offset from Greenwich Mean Time (GMT).
DST Repeating Settings	Using repeating mode will enable DST seasonal time adjustment. Repeating mode requires that the DST beginning and ending date be specified using a formula. For example, specify to begin DST on Saturday during the second week of April and end DST on Sunday during the last week of October.
From: Which Day	Enter the week of the month that DST will start.
From: Day of Week	Enter the day of the week that DST will start on.
From: Month	Enter the month DST will start on.
From: Time in HH:MM	Enter the time of day that DST will start on.
To: Which Day	Enter the week of the month the DST will end.
To: Day of Week	Enter the day of the week that DST will end.
To: Month	Enter the month that DST will end.
To: time in HH:MM	Enter the time DST will end.
DST Annual Settings	Using annual mode will enable DST seasonal time adjustment. Annual mode requires that the DST beginning and ending date be specified concisely. For example, specify to begin DST on April 3 and end DST on October 14.
From: Month	Enter the month DST will start on, each year.
From: Day	Enter the day of the month DST will start on, each year.
From: Time in HH:MM	Enter the time of day DST will start on, each year.
To: Month	Enter the month DST will end on, each year.
To: Day	Enter the day of the month DST will end on, each year.
To: Time in HH:MM	Enter the time of day that DST will end on, each year.

Click **Apply** to implement changes made to the **Time Zone and DST** window.

6-21 Access Profile Table

Configuring the Access Profile Table

Access profiles allow you to establish criteria to determine whether or not the Switch will forward packets based on the information contained in each packet's header. These criteria can be specified on a basis of VLAN, MAC address or IP address.

Creating an access profile is divided into two basic parts. The first is to specify which part or parts of a frame the Switch will examine, such as the MAC source address or the IP destination address. The second part is entering the criteria the Switch will use to determine what to do with the frame. The entire process is described below in two parts.

To display the currently configured Access Profiles on the Switch, open the **Configuration** folder and click on the **Access Profile Table** link. This will open the **Access Profile Table** page, as shown below.

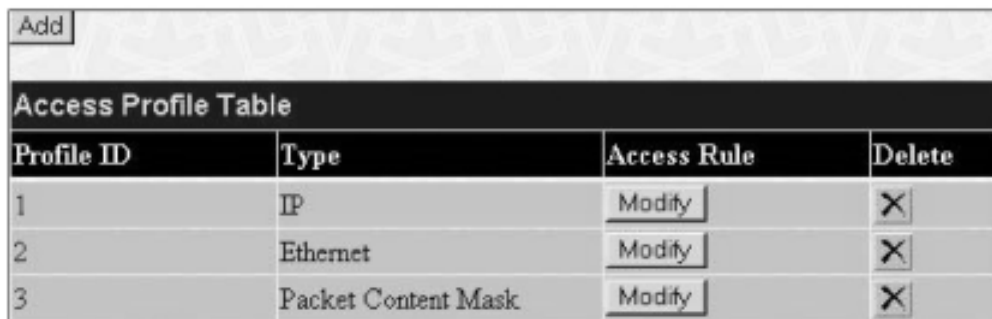

Profile ID	Type	Access Rule	Delete
1	IP	Modify	X
2	Ethernet	Modify	X
3	Packet Content Mask	Modify	X

Figure 6- 60. Access Profile Table

To add an entry to the **Access Profile Table**, click the **Add** button. This will open the **Access Profile Configuration** page, as shown below. There are three **Access Profile Configuration** pages; one for **Ethernet** (or MAC address-based) profile configuration, one for **IP** address-based profile configuration and one for the **Packet Content Mask**. You can switch between the three **Access Profile Configuration** pages by using the **Type** drop-down menu. The page shown below is the **Ethernet Access Profile Configuration** page.

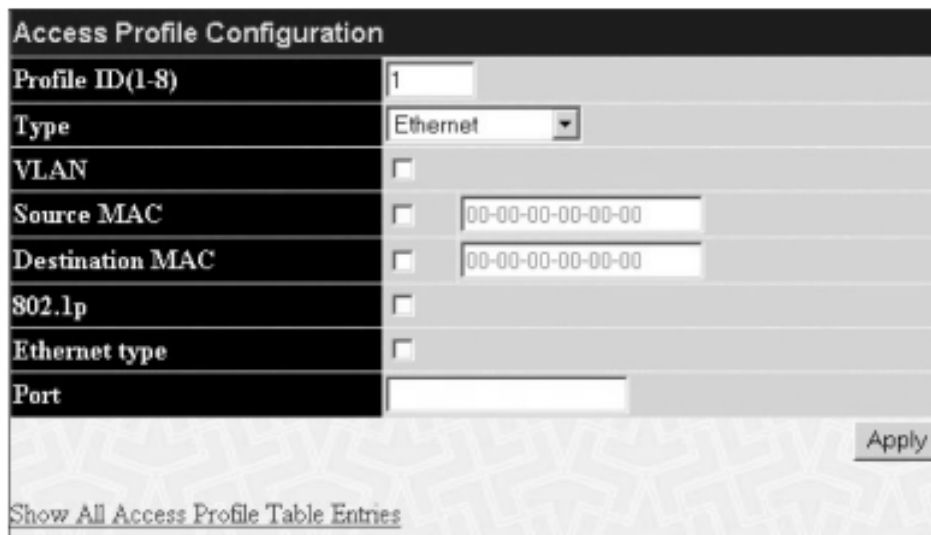

Profile ID(1-8)	1
Type	Ethernet
VLAN	<input type="checkbox"/>
Source MAC	<input type="checkbox"/> 00-00-00-00-00-00
Destination MAC	<input type="checkbox"/> 00-00-00-00-00-00
802.1p	<input type="checkbox"/>
Ethernet type	<input type="checkbox"/>
Port	

Apply

Show All Access Profile Table Entries

Figure 6- 61. Access Profile Table (Ethernet)

The following parameters can be set, for the **Ethernet** type:

Parameter	Description
Profile ID (1-8)	Type in a unique identifier number for this profile set. This value can be set from 1 - 8.
Type	Select profile based on Ethernet (MAC Address), IP address or packet content mask. This will change the menu according to the requirements for the type of profile. Select <i>Ethernet</i> to instruct the Switch to examine the layer 2 part of each packet header. Select <i>IP</i> to instruct the Switch to examine the IP address in each frame's header. Select <i>Packet Content Mask</i> to specify a mask to hide the content of the packet header.
VLAN	Selecting this option instructs the Switch to examine the VLAN identifier of each packet header and use this as the full or partial criterion for forwarding.
Source MAC	Source MAC Mask – Enter a MAC address mask for the source MAC address.
Destination MAC	Destination MAC Mask – Enter a MAC address mask for the destination MAC address.
802.1p	Selecting this option instructs the Switch to examine the 802.1p priority value of each packet header and use this as the, or part of the criterion for forwarding.
Ethernet type	Selecting this option instructs the Switch to examine the Ethernet type value in each frame's header.
Port	The user may set the Access Profile Table on a per-port basis by entering a port number in this field. The port list is specified by listing the lowest switch number and the beginning port number on that switch, separated by a colon. Then the highest switch number, and the highest port number of the range (also separated by a colon) are specified. The beginning and end of the port list range are separated by a dash. For example, 1:3 specifies switch number 1, port 3. 2:4 specifies switch number 2, port 4. 1:3 -2:4 specifies all of the ports between switch 1, port 3 and switch 2, port 4 • in numerical order. Entering all will denote all ports on the Switch.

The page shown below is the **IP Access Profile Configuration** page.

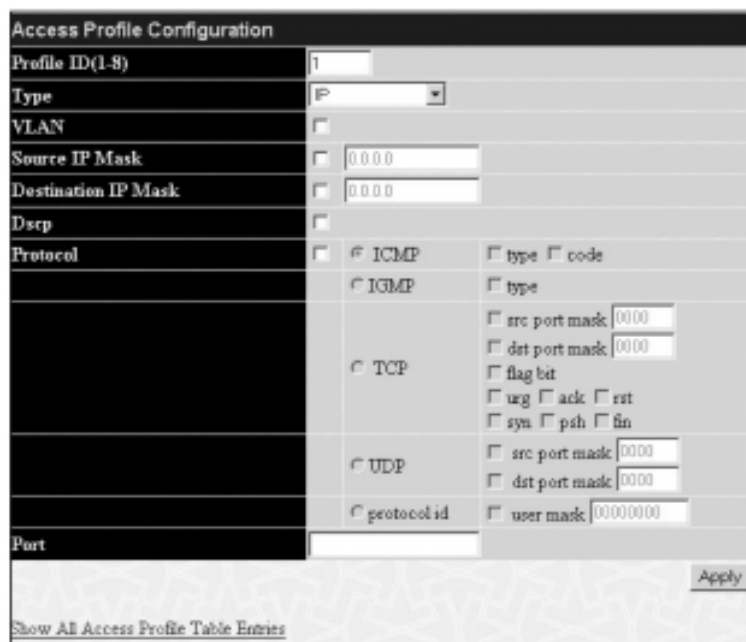

Figure 6- 62. Access Profile Configuration (IP)

The following parameters can be set, for **IP**:

Parameter	Description
Profile ID (1-8)	Type in a unique identifier number for this profile set. This value can be set from 1 - 8.
Type	Select profile based on Ethernet (MAC Address), IP address or packet content mask. This will change the menu according to the requirements for the type of profile. Select <i>Ethernet</i> to instruct the Switch to examine the layer 2 part of each packet header. Select <i>IP</i> to instruct the Switch to examine the IP address in each frame's header. Select <i>Packet Content Mask</i> to specify a mask to hide the content of the packet header.
VLAN	Selecting this option instructs the Switch to examine the VLAN part of each packet header and use this as the, or part of the criterion for forwarding.

Source IP Mask Enter an IP address mask for the source IP address.

Destination IP Mask Enter an IP address mask for the destination IP address.

DSCP Selecting this option instructs the Switch to examine the DiffServ Code part of each packet header and use this as the, or part of the criterion for forwarding.

Protocol Selecting this option instructs the Switch to examine the protocol type value in each frame's header. You must then specify what protocol(s) to include according to the following guidelines:

Select **ICMP** to instruct the Switch to examine the Internet Control Message Protocol (ICMP) field in each frame's header.

Select **Type** to further specify that the access profile will apply an ICMP type value, or specify Code to further specify that the access profile will apply an ICMP code value.

Select **IGMP** to instruct the Switch to examine the Internet Group Management Protocol (IGMP) field in each frame's header.

Select **Type** to further specify that the access profile will apply an IGMP type value.

Select **TCP** to use the TCP port number contained in an incoming packet as the forwarding criterion. Selecting TCP requires that you specify a source port mask and/or a destination port mask. The user may also identify which flag bits to filter. Flag bits are parts of a packet that determine what to do with the packet. The user may filter packets by filtering certain flag bits within the packets, by checking the boxes corresponding to the flag bits of the TCP field. The user may choose between **urg** (urgent), **ack** (acknowledgement), **psh** (push), **rst** (reset), **syn** (synchronize), **fin** (finish).

src port mask – Specify a TCP port mask for the source port in hex form (hex 0x0-0xffff), which you wish to deny.

dest port mask – Specify a TCP port mask for the destination port in hex form (hex 0x0-0xffff) which you wish to deny.

Select **UDP** to use the UDP port number contained in an incoming packet as the forwarding criterion. Selecting UDP requires that you specify a source port mask and/or a destination port mask.

src port mask – Specify a TCP port mask for the source port in hex form (hex 0x0-0xffff).

dest port mask – Specify a TCP port mask for the destination port in hex form (hex 0x0-0xffff).

protocol id – Enter a value defining the protocol ID in the packet header to mask. Specify the protocol ID mask in hex form (hex 0x0-0xffff).

Port The user may set the Access Profile Table on a per-port basis by entering an entry in this field. Entering all will denote all ports on the Switch. The port list is specified by listing the lowest switch number and the beginning port number on that switch, separated by a colon. Then the highest switch number, and the highest port number of the range (also separated by a colon) are specified. The beginning and end of the port list range are separated by a dash. For example, 1:3 specifies switch number 1, port 3. 2:4 specifies switch number 2, port 4. 1:3 - 2:4 specifies all of the ports between switch 1, port 3 and switch 2, port 4 •in numerical order. Entering all will denote all ports on the Switch.

The page shown below is the **Packet Content Mask** configuration window.

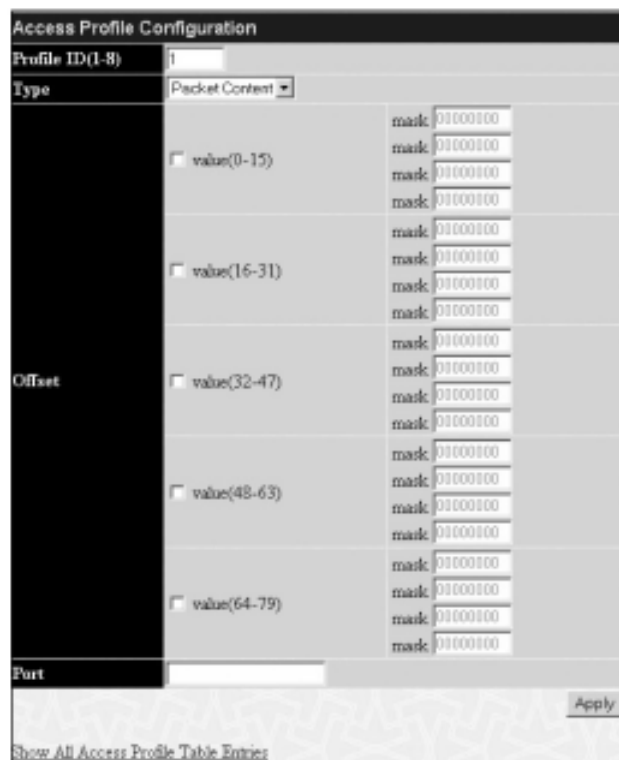

Figure 6- 63. Access Profile Configuration window (Packet Content Mask)

This screen will aid the user in configuring the Switch to mask packet headers beginning with the offset value specified. The following fields are used to configure the **Packet Content Mask**:

Parameter	Description
Profile ID (1-8)	Type in a unique identifier number for this profile set. This value can be set from 1 - 8.
Type	Select profile based on Ethernet (MAC Address), IP address or packet content mask. This will change the menu according to the requirements for the type of profile. Select <i>Ethernet</i> to instruct the Switch to examine the layer 2 part of each packet header. Select <i>IP</i> to instruct the Switch to examine the IP address in each frame's header. Select <i>Packet Content Mask</i> to specify a mask to hide the content of the packet header.
Offset	This field will instruct the Switch to mask the packet header beginning with the offset value specified: <i>value (0-15)</i> - Enter a value in hex form to mask the packet from the beginning of the packet to the 15th byte. <i>value (16-31)</i> - Enter a value in hex form to mask the packet from byte 16 to byte 31. <i>value (32-47)</i> - Enter a value in hex form to mask the packet from byte 32 to byte 47. <i>value (48-63)</i> - Enter a value in hex form to mask the packet from byte 48 to byte 63. <i>value (64-79)</i> - Enter a value in hex form to mask the packet from byte 64 to byte 79.
Port	The user may set the Access Profile Table on a per-port basis by entering an entry in this field. Entering all will denote all ports on the Switch. The port list is specified by listing the lowest switch number and the beginning port number on that switch, separated by a colon. Then the highest switch number, and the highest port number of the range (also separated by a colon) are specified. The beginning and end of the port list range are separated by a dash. For example, 1:3 specifies switch number 1, port 3. 2:4 specifies switch number 2, port 4. 1:3 - 2:4 specifies all of the ports between switch 1, port 3 and switch 2, port 4 *in numerical order. Entering all will denote all ports on the Switch.

Click **Apply** to implement changes made.

To establish the rule for a previously created Access Profile:

In the **Configuration** folder, click the **Access Profile Table** link opening the **Access Profile Table**. Under the heading **Access Rule**, clicking **Modify**, will open the following window.

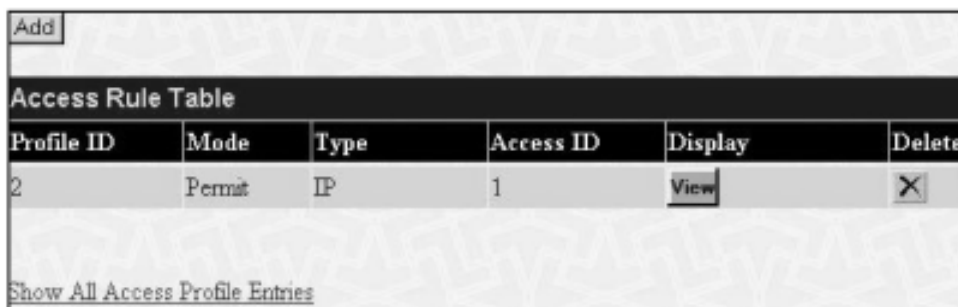

Figure 6- 64. Access Rule Table window – IP

To create a new rule set for an access profile click the **Add** button. A new window is displayed. To remove a previously created rule, click the corresponding **X** button.

Figure 6- 65. Access Rule Configuration window (IP)

Configure the following **Access Rule Configuration** settings for IP:

Parameter	Description
Profile ID	This is the identifier number for this profile set.
Mode	Select Permit to specify that the packets that match the access profile are forwarded by the Switch, according to any additional rule added (see below). Select Deny to specify that packets that do not match the access profile are not forwarded by the Switch and will be filtered.
Access ID	Type in a unique identifier number for this access. This value can be set from 1-50.
Type	Selected profile based on Ethernet (MAC Address), IP address or Packet Content Mask . <i>Ethernet</i> instructs the Switch to examine the layer 2 part of each packet header. <i>IP</i> instructs the Switch to examine the IP address in each frame's header. <i>Packet Content Mask</i> instructs the Switch to examine the packet header.
Priority (0-7)	This parameter is specified if you want to re-write the 802.1p default priority previously set in the Switch, which is used to determine the CoS queue to which packets are forwarded to. Once this field is specified, packets accepted by the Switch that match this priority are forwarded to the CoS queue specified previously by the user. <i>Replace priority with</i> – Click the corresponding box if you want to re-write the 802.1p default priority of a packet to the value entered in the Priority field, which meets the criteria specified previously in this command, before forwarding it on to the specified CoS queue. Otherwise, a packet will have its incoming 802.1p user priority re-written to its original value before being forwarded by the Switch. For more information on priority queues, CoS queues and mapping for 802.1p, see the QoS section of this manual.
Replace Dscp (0-63)	Select this option to instruct the Switch to replace the DSCP value (in a packet that meets the selected criteria) with the value entered in the adjacent field.
VLAN Name	Allows the entry of a name for a previously configured VLAN.
Source IP	Enter an IP Address mask for the source IP address.
Destination IP	Enter an IP Address mask for the destination IP address.
Dscp (0-63)	This field allows the user to enter a DSCP value in the space provided, which will instruct the Switch to examine the DiffServ Code part of each packet header and use this as the, or part of the criterion for forwarding. The user may choose a value between 0 and 63.
Protocol	This field allows the user to modify the protocol used to configure the Access Rule Table; depending on which protocol the user has chosen in the Access Profile Table.

To view the settings of a previously correctly configured rule, click **View** in the **Access Rule Table** to view the following screen:

Access Rule Display	
Profile ID	2
Access ID	1
Mode	Permit
Type	IP
Priority	0
Replace Dscp with	-----
VLAN Name	default
Source IP	-----
Destination IP	-----
Dscp	-----
Protocol	-----
Show All Access Rule Entries	

Figure 6- 66.Access Rule Display window (IP)

To configure the **Access Rule for Ethernet**, open the **Access Profile Table** and click **Modify** for an Ethernet entry.This will open the following screen:

Access Rule Table					
Profile ID	Mode	Type	Access ID	Display	Delete
1	Permit	Ethernet	1	View	X
Show All Access Profile Entries					

Figure 6- 67.Access Rule Table

To remove a previously created rule,select it and click the **X** button.To add a new Access Rule,click the **Add** button:

Access Rule Configuration	
Profile ID	1
Mode	<input checked="" type="radio"/> Permit <input type="radio"/> Deny
Access ID	1
Type	Ethernet
Priority(0-7)	<input type="checkbox"/> 0 <input type="checkbox"/> Replace Priority with
Replace Dscp with(0-63)	<input type="checkbox"/> 0
VLAN Name	
Source MAC	00-00-00-00-00-00
Destination MAC	00-00-00-00-00-00
802.1p(0-7)	0
Ethernet Type	0000
Apply	
Show All Access Rule Entries	

Figure 6- 68.Access Rule Configuration window – Ethernet

To set the Access Rule for Ethernet, adjust the following parameters and click **Apply**.

Parameter	Description
Profile ID	This is the identifier number for this profile set.
Mode	Select Permit to specify that the packets that match the access profile are forwarded by the Switch, according to any additional rule added (see below). Select Deny to specify that packets that do not match the access profile are not forwarded by the Switch and will be filtered.
Access ID	Type in a unique identifier number for this access. This value can be set from 1 - 50.
Type	Selected profile based on Ethernet (MAC Address), IP address or Packet Content Mask . Ethernet instructs the Switch to examine the layer 2 part of each packet header. IP instructs the Switch to examine the IP address in each frame's header. Packet Content Mask instructs the Switch to examine the packet header
Priority (0-7)	This parameter is specified if you want to re-write the 802.1p default priority previously set in the Switch, which is used to determine the CoS queue to which packets are forwarded to. Once this field is specified, packets accepted by the Switch that match this priority are forwarded to the CoS queue specified previously by the user. <i>Replace priority with</i> – Click the corresponding box if you want to re-write the 802.1p default priority of a packet to the value entered in the Priority field, which meets the criteria specified previously in this command, before forwarding it on to the specified CoS queue. Otherwise, a packet will have its incoming 802.1p user priority re-written to its original value before being forwarded by the Switch. For more information on priority queues, CoS queues and mapping for 802.1p, see the QoS section of this manual.
VLAN Name	Allows the entry of a name for a previously configured VLAN.
Source MAC Source	Enter a MAC Address for the source MAC address.
Destination MAC Destination	Enter a MAC Address mask for the destination MAC address.
802.1p (0-7)	Enter a value from 0-7 to specify that the access profile will apply only to packets with this 802.1p priority value.
Ethernet Type	Specifies that the access profile will apply only to packets with this hexadecimal 802.1Q Ethernet type value (hex 0x0-0xffff) in the packet header. The Ethernet type value may be set in the form: hex 0x0-0xffff, which means the user may choose any combination of letters and numbers ranging from a-f and from 0-9999.

To view the settings of a previously correctly configured rule, click **View** in the **Access Rule Table** to view the following screen:

Access Rule Display	
Profile ID	1
Access ID	1
Mode	Permit
Type	Ethernet
Priority	-----
Replace Dscp with	-----
VLAN Name	default
Source Mac	-----
Destination Mac	-----
802.1p	-----
Ethernet Type	-----
Show All Access Rule Entries	

Figure 6- 69. Access Rule Display window (Ethernet)

To configure the Access Rule for **Packet Content Mask**, open the **Access Profile Table** and click **Modify** for a **Packet Content Mask** entry. This will open the following screen:

Access Rule Table					
Profile ID	Mode	Type	Access ID	Display	Delete
3	Permit	Packet Content	1	<input type="button" value="View"/>	<input type="button" value="X"/>

[Show All Access Profile Entries](#)

Figure 6- 70. Access Rule Table (Packet Content Mask)

To remove a previously created rule, select it and click the **X** button. To add a new Access Rule, click the **Add** button:

Access Rule Configuration		
Profile ID	4	
Mode	<input checked="" type="radio"/> Permit <input type="radio"/> Deny	
Access ID	1	
Type	Packet Content Mask	
Priority(0-7)	<input type="checkbox"/> <input type="text"/> <input type="checkbox"/> Replace Priority with	
Replace Dscp with(0-63)	<input type="checkbox"/> <input type="text"/>	
Offset	<input type="checkbox"/> value(0-15)	mask <input type="text" value="00000000"/> mask <input type="text" value="00000000"/> mask <input type="text" value="00000000"/> mask <input type="text" value="00000000"/>
	<input type="checkbox"/> value(16-31)	mask <input type="text" value="00000000"/> mask <input type="text" value="00000000"/> mask <input type="text" value="00000000"/> mask <input type="text" value="00000000"/>
	<input type="checkbox"/> value(32-47)	mask <input type="text" value="00000000"/> mask <input type="text" value="00000000"/> mask <input type="text" value="00000000"/> mask <input type="text" value="00000000"/>
	<input type="checkbox"/> value(48-63)	mask <input type="text" value="00000000"/> mask <input type="text" value="00000000"/> mask <input type="text" value="00000000"/> mask <input type="text" value="00000000"/>
	<input type="checkbox"/> value(64-79)	mask <input type="text" value="00000000"/> mask <input type="text" value="00000000"/> mask <input type="text" value="00000000"/> mask <input type="text" value="00000000"/>

Figure 6- 71. Access Rule Configuration – Packet Content Mask

To set the Access Rule for the **Packet Content Mask**, adjust the following parameters and click **Apply**.

Parameter	Description
Profile ID	This is the identifier number for this profile set.
Mode	Select Permit to specify that the packets that match the access profile are forwarded by the Switch, according to any additional rule added (see below). Select Deny to specify that packets that do not match the access profile are not forwarded by the Switch and will be filtered.
Access ID	Type in a unique identifier number for this access. This value can be set from 1 - 50.
Type	Selected profile based on Ethernet (MAC Address), IP address or Packet Content Mask. <i>Ethernet</i> instructs the Switch to examine the layer 2 part of each packet header. <i>IP</i> instructs the Switch to examine the IP address in each frame's header. <i>Packet Content Mask</i> instructs the Switch to examine the packet header.

Priority

This parameter is specified if you want to re-write the 802.Ip default priority previously set in the Switch, which is used to determine the CoS queue to which packets are forwarded to. Once this field is specified, packets accepted by the Switch that match this priority are forwarded to the CoS queue specified previously by the user.

Replace priority with – Click the corresponding box if you want to re-write the 802.Ip default priority of a packet to the value entered in the **Priority** field, which meets the criteria specified previously in this command, before forwarding it on to the specified CoS queue. Otherwise, a packet will have its incoming 802.Ip user priority re-written to its original value before being forwarded by the Switch.

For more information on priority queues, CoS queues and mapping for 802.Ip, see the **QoS** section of this manual.

Offset

This field will instruct the Switch to mask the packet header beginning with the offset value specified:

value (0-15) – Enter a value in hex form to mask the packet from the beginning of the packet to the 15th byte.

value (16-31) – Enter a value in hex form to mask the packet from byte 16 to byte 31.

value (32-47) – Enter a value in hex form to mask the packet from byte 32 to byte 47.

value (48-63) – Enter a value in hex form to mask the packet from byte 48 to byte 63.

value (64-79) – Enter a value in hex form to mask the packet from byte 64 to byte 79.

To view the settings of a previously correctly configured rule, click **View** in the **Access Rule Table** to view the following screen:



Access Rule Display	
Profile ID	1
Access ID	1
Mode	Permit
Type	Packet Content
Priority	-----
Replace Dscp	-----
Offset	Offset (0 - 15)
	mask: 0x00000000
	mask: 0x00000000
	mask: 0x00000000
	mask: 0x00000000
	Offset (16 - 31)
	mask: 0x00000000
	mask: 0x00000000
	mask: 0x00000000
	mask: 0x00000000
	Offset (32 - 47)
	mask: 0x00000000
mask: 0x00000000	
mask: 0x00000000	
mask: 0x00000000	
Offset (48 - 63)	
mask: 0x00000000	
mask: 0x00000000	
mask: 0x00000000	
mask: 0x00000000	

Figure 6- 72. Access Rule Display window (Packet Content Mask)

6-22 Port Access Entity (802.Ix)

Understanding 802.Ix Port-based and MAC-based Network Access Control

The original intent behind the development of 802.IX was to leverage the characteristics of point-to-point connections associated with UTP based LANs. All single LAN segment in such infrastructures has no more than two devices attached to it, one of which is a Bridge Port. The Bridge Port detects events that indicate the attachment of an active device at the remote end of the link, or an active device becoming inactive. These events can be used to control the authorization state of the Port and initiate the process of authenticating the attached device if the Port is unauthorized. This is the Port-Based Network Access Control.

Port-Based Network Access Control

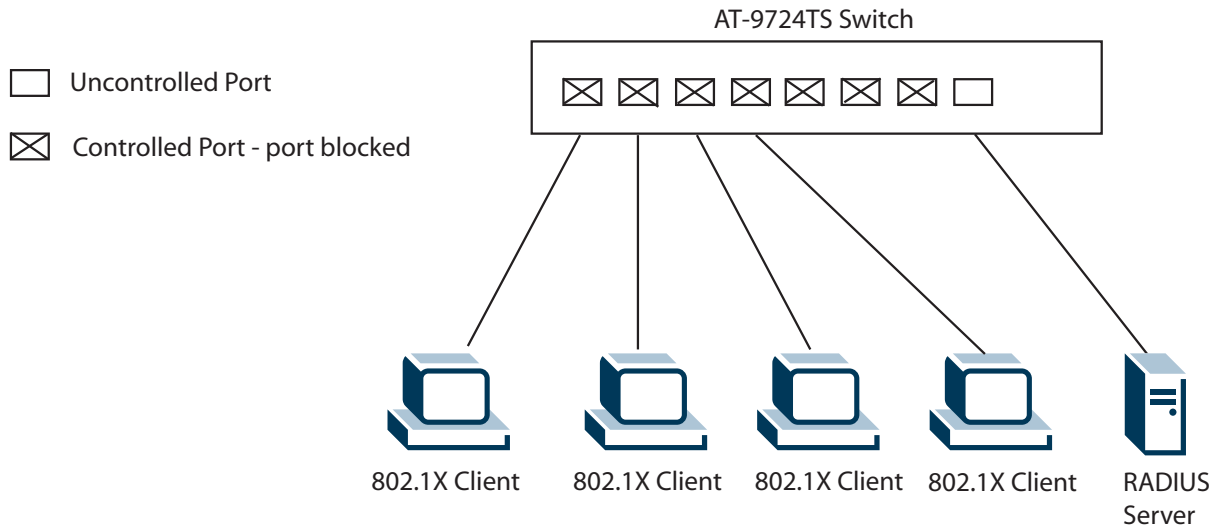

Figure 6- 73. Example of Typical Port-Based Configuration

Once the connected device has successfully been authenticated, the Port then becomes Authorized, and all subsequent traffic on the Port is not subject to access control restriction until an event occurs that causes the Port to become Unauthorized. Hence, if the Port is actually connected to a shared media LAN segment with more than one attached device, successfully authenticating one of the attached devices effectively provides access to the LAN for all devices on the shared segment. Clearly, the security offered in this situation is open to attack.

MAC-Based Network Access Control

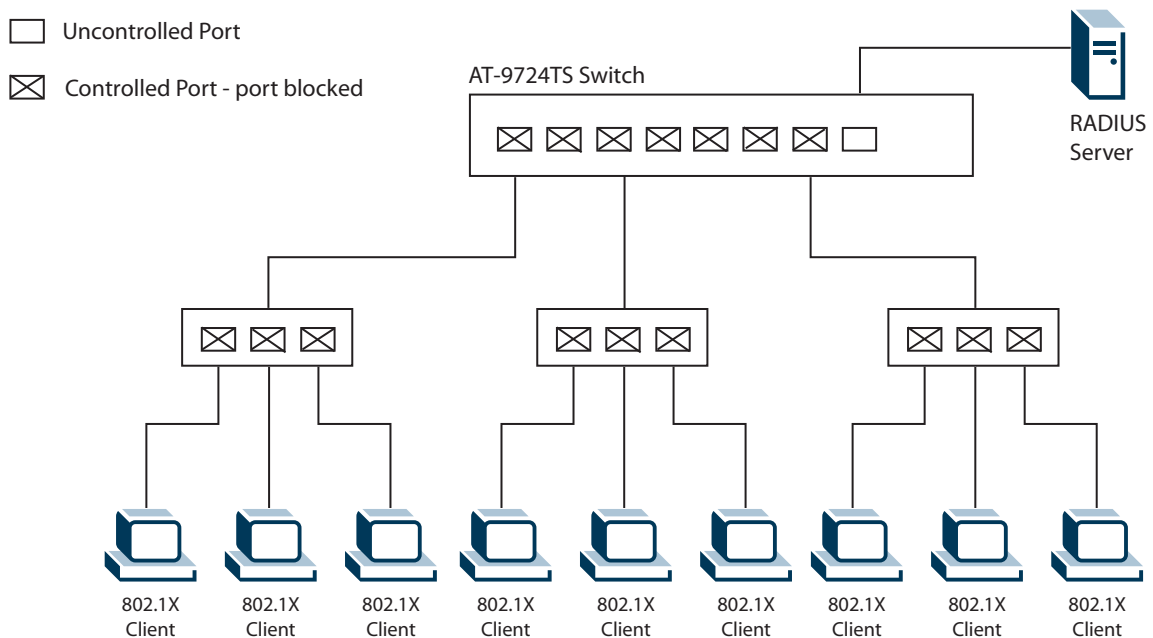

Figure 6- 74. Example of Typical MAC-Based Configuration

In order to successfully make use of 802.1X in a shared media LAN segment, it would be necessary to create “logical” Ports, one for each attached device that required access to the LAN. The Switch would regard the single physical Port connecting it to the shared media segment as consisting of a number of distinct logical Ports, each logical Port being independently controlled from the point of view of EAPOL exchanges and authorization state. The Switch learns each attached devices’ individual MAC addresses, and effectively creates a logical Port that the attached device can then use to communicate with the LAN via the Switch.

Configure Authenticator

To configure the 802.1X Authenticator Settings, click **PAE Access Entity > Configure Authenticator**:

Unit: 1

802.1X Authenticator Settings-Unit 1

Port	AdmDir	Port Control	TxPeriod	Quiet Period	Supp Timeout	Server Timeout	MaxReq	ReAuth Period	ReAuth Enabled
1	both	Auto	30	60	30	30	2	3600	No
2	both	Auto	30	60	30	30	2	3600	No
3	both	Auto	30	60	30	30	2	3600	No
4	both	Auto	30	60	30	30	2	3600	No
5	both	Auto	30	60	30	30	2	3600	No
6	both	Auto	30	60	30	30	2	3600	No
7	both	Auto	30	60	30	30	2	3600	No
8	both	Auto	30	60	30	30	2	3600	No
9	both	Auto	30	60	30	30	2	3600	No
10	both	Auto	30	60	30	30	2	3600	No
11	both	Auto	30	60	30	30	2	3600	No
12	both	Auto	30	60	30	30	2	3600	No
13	both	Auto	30	60	30	30	2	3600	No
14	both	Auto	30	60	30	30	2	3600	No
15	both	Auto	30	60	30	30	2	3600	No
16	both	Auto	30	60	30	30	2	3600	No
17	both	Auto	30	60	30	30	2	3600	No
18	both	Auto	30	60	30	30	2	3600	No
19	both	Auto	30	60	30	30	2	3600	No
20	both	Auto	30	60	30	30	2	3600	No
21	both	Auto	30	60	30	30	2	3600	No
22	both	Auto	30	60	30	30	2	3600	No
23	both	Auto	30	60	30	30	2	3600	No
24	both	Auto	30	60	30	30	2	3600	No

Figure 6- 75. 802.1X Authenticator Settings window

To view the 802.1X Authenticator settings on a different switch in the switch stack, use the **Unit** pull-down menu to select that switch by its ID number in the switch stack. To configure the settings by port, click on the hyperlinked port number under the **Port** heading, which will display the following table to configure:

802.1X Authenticator Settings

From	Port 1
To	Port 1
AdminCtrlDir	both
PortControl	Auto
TxPeriod	30
QuietPeriod	60
Supp Timeout	30
Server Timeout	30
MaxReq	2
ReAuthPeriod	3600
ReAuth	Disabled

[Show Authenticators Setting](#) Apply

Figure 6- 76. 802.1X Authenticator Settings – Modify

This screen allows you to set the following features:

Parameter	Description
Unit	Choose the Switch ID number of the Switch in the switch stack to be modified.
From [] To []	Enter the port or ports to be set.
AdmCtrlDir	Sets the administrative-controlled direction to either <i>in</i> or <i>both</i> . If <i>in</i> is selected, control is only exerted over incoming traffic through the port you selected in the first field. If <i>both</i> is selected, control is exerted over both incoming and outgoing traffic through the controlled port selected in the first field.
PortControl	This allows you to control the port authorization state. Select <i>forceAuthorized</i> to disable 802.1X and cause the port to transition to the authorized state without any authentication exchange required. This means the port transmits and receives normal traffic without 802.1X-based authentication of the client. If <i>forceUnauthorized</i> is selected, the port will remain in the unauthorized state, ignoring all attempts by the client to authenticate. The Switch cannot provide authentication services to the client through the interface. If <i>Auto</i> is selected, it will enable 802.1X and cause the port to begin in the unauthorized state, allowing only EAPOL frames to be sent and received through the port. The authentication process begins when the link state of the port transitions from down to up, or when an EAPOL-start frame is received. The Switch then requests the identity of the client and begins relaying authentication messages between the client and the authentication server. The default setting is <i>Auto</i> .
TxPeriod	This sets the TxPeriod of time for the authenticator PAE state machine. This value determines the period of an EAP Request/Identity packet transmitted to the client. The default setting is 30 seconds.
QuietPeriod	This allows you to set the number of seconds that the Switch remains in the quiet state following a failed authentication exchange with the client. The default setting is 60 seconds.
SuppTimeout	This value determines timeout conditions in the exchanges between the Authenticator and the client. The default setting is 30 seconds.
ServerTimeout	This value determines timeout conditions in the exchanges between the Authenticator and the authentication server. The default setting is 30 seconds.
MaxReq	The maximum number of times that the Switch will retransmit an EAP Request to the client before it times out of the authentication sessions. The default setting is 2.
ReAuthPeriod	A constant that defines a nonzero number of seconds between periodic reauthentication of the client. The default setting is 3600 seconds.
ReAuth	Determines whether regular reauthentication will take place on this port. The default setting is Disabled.

Click **Apply** to implement your configuration changes. To view configurations for the **802.1X Authenticator Settings** on a port-by-port basis, see the **802.1X Authenticator Settings** table.

Local Users

In the configuration folder, open the **Port Access Entity** folder and click **Local users** to open the **802.1x Local User Table Configuration** window. This window will allow the user to set different local users on the Switch.

802.1x Local User Table Configuration		
User Name	Password	Confirm Password
<input type="text"/>	<input type="text"/>	<input type="text"/>
<input type="button" value="Apply"/>		
Total Entries: 1		
802.1x Local User Table		
User Name	Password	Delete
Trinity	1	<input type="button" value="X"/>

Figure 6- 77. 802.1x Local User Table Configuration and 802.1x Local User Table window

Enter a **User Name**, **Password** and confirmation of that password. Properly configured local users will be displayed in the **802.1x Local User Table** in the same window.

PAE System Control

Existing 802.1x port settings are displayed and can be configured using the windows below.

Port Capability Settings

Click **Port Access Entity > PAE System Control > 802.1X Capability Settings** to view the following window:

Unit	From	To	Capability	Apply
1	Port1	Port1	None	Apply

Port	Capability
1	None
2	None
3	None
4	None
5	None
6	None
7	None
8	None
9	None
10	None
11	None
12	None
13	None
14	None
15	None
16	None
17	None
18	None
19	None
20	None
21	None
22	None
23	None
24	None

Figure 6- 78. 802.1x Capability Settings and Table window

To set up the Switch's 802.1x port-based authentication, select the switch in the switch stack by using the **Unit** pull-down menu and then select which ports are to be configured in the **From** and **To** fields. Next, enable the ports by selecting *Authenticator* from the drop-down menu under **Capability**. Click **Apply** to let your change take effect.

Configure the following 802.1x capability settings:

Parameter	Description
Unit	Choose the Switch ID number of the Switch in the switch stack to be modified.
From and To	Ports being configured for 802.1x settings.
Capability	Two role choices can be selected: <i>Authenticator</i> – A user must pass the authentication process to gain access to the network. <i>None</i> – The port is not controlled by the 802.1x functions.

Initializing Ports for Port Based 802.1x

Existing 802.1x port settings are displayed and can be configured using the window below.

 **Note:** Ensure Port Based 802.1x is enabled under **Configuration > Advanced Settings**.

Click **Port Access Entity > PAE System Control > Initialize Port(s)** to open the following window:



Unit	From	To	Apply
1	Port1	Port1	Apply

Port	Auth PAE State	Backend_State	Port Status
1	ForceAuth	Success	Authorized
2	ForceAuth	Success	Authorized
3	ForceAuth	Success	Authorized
4	ForceAuth	Success	Authorized
5	ForceAuth	Success	Authorized
6	ForceAuth	Success	Authorized
7	ForceAuth	Success	Authorized
8	ForceAuth	Success	Authorized
9	ForceAuth	Success	Authorized
10	ForceAuth	Success	Authorized
11	ForceAuth	Success	Authorized
12	ForceAuth	Success	Authorized
13	ForceAuth	Success	Authorized
14	ForceAuth	Success	Authorized
15	ForceAuth	Success	Authorized
16	ForceAuth	Success	Authorized
17	ForceAuth	Success	Authorized
18	ForceAuth	Success	Authorized
19	ForceAuth	Success	Authorized
20	ForceAuth	Success	Authorized
21	ForceAuth	Success	Authorized
22	ForceAuth	Success	Authorized
23	ForceAuth	Success	Authorized
24	ForceAuth	Success	Authorized

Figure 6- 79. Initialize Port window (Port-based)

This window allows you to initialize a port or group of ports. The **Initialize Port Table** in the bottom half of the window displays the current status of the port(s).

This window displays the following information:

Parameter	Description
Unit	Choose the Switch ID number of the Switch in the switch stack to be modified.
From and Port	To Select ports to be initialized. A read only field indicating a port on the Switch.
Auth PAE State	The Authenticator PAE State will display one of the following: <i>Initialize, Disconnected, Connecting, Authenticating, Authenticated, Aborting, Held, ForceAuth, ForceUnauth, and N/A.</i>
Backend State	The Backend Authentication State will display one of the following: <i>Request, Response, Success, Fail, Timeout, Idle, Initialize, and N/A.</i>
Port Status	The status of the controlled port can be <i>Authorized, Unauthorized, or N/A.</i>

Initializing Ports for MAC Based 802.1x

To initialize ports for the MAC side of 802.1x, the user must first enable 802.1x by MAC address in the **Advanced Settings** window. Click **Port Access Entity > PAE System Control > Initialize Port(s)** to open the following window:

Figure 6- 80. Initialize Ports window (MAC based 802.1x)

To initialize ports, first choose the switch in the switch stack by using the **Unit** pull-down menu, then the range of ports in the **From** and **To** field. Then the user must specify the MAC address to be initialized by entering it into the **MAC Address** field and checking the corresponding check box. To begin the initialization, click **Apply**.

 **Note:** The user must first globally enable 802.1X in the **Advanced Settings** window in the **Configuration** folder before initializing ports. Information in the **Initialize Ports Table** cannot be viewed before enabling 802.1X.

Reauthenticate Port(s) for Port Based 802.1x

This window allows you to reauthenticate a port or group of ports by choosing a port or group of ports by using the pull down menus **From** and **To** and clicking **Apply**. The **Reauthenticate Port Table** displays the current status of the reauthenticated port(s) once you have clicked **Apply**.

Click **Port Access Entity > PAE System Control > Reauthenticate Port(s)** to open the **Reauthenticate Port(s)** window:

Port	Auth PAE State	BackendState	PortStatus
1	ForceAuth	Success	Authorized
2	ForceAuth	Success	Authorized
3	ForceAuth	Success	Authorized
4	ForceAuth	Success	Authorized
5	ForceAuth	Success	Authorized
6	ForceAuth	Success	Authorized
7	ForceAuth	Success	Authorized
8	ForceAuth	Success	Authorized
9	ForceAuth	Success	Authorized
10	ForceAuth	Success	Authorized

Figure 6- 81. Reauthenticate Port and Reauthenticate Port Table window

This window displays the following information:

Parameter	Description
Unit	Choose the Switch ID number of the Switch in the switch stack to be modified.
Port	The port number of the reauthenticated port.
Auth State	The Authenticator State will display one of the following: <i>Initialize, Disconnected, Connecting, Authenticating, Authenticated, Aborting, Held, ForceAuth, ForceUnauth,</i> and <i>N/A</i> .
BackendState	The Backend State will display one of the following: <i>Request, Response, Success, Fail, Timeout, Idle, Initialize,</i> and <i>N/A</i> .
OpenDir	Operational Controlled Directions are <i>both</i> and <i>in</i> .
PortStatus	The status of the controlled port can be Authorized, Unauthorized, or N/A.

 **Note:** The user must first globally enable 802.1X in the **Advanced Settings** window in the **Configuration** folder before reauthenticating ports. Information in the **Reauthenticate Ports Table** cannot be viewed before enabling 802.1X.

Reauthenticate Port(s) for MAC Based 802.1x

To reauthenticate ports for the MAC side of 802.1x, the user must first enable 802.1x by MAC address in the **Advanced Settings** window. Click **Port Access Entity > PAE System Control > Reauthenticate Port(s)** to open the following window:

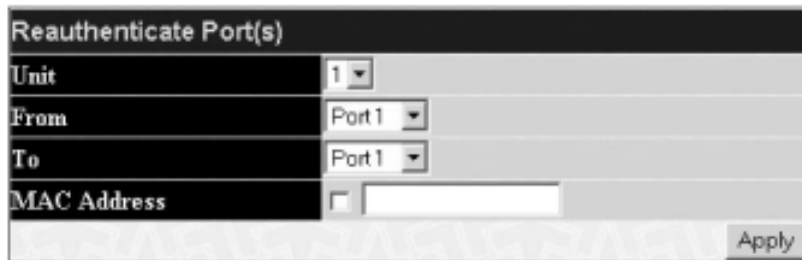

Figure 6- 82. Reauthenticate Ports – MAC based 802.1x

To reauthenticate ports, first choose the switch in the switch stack by using the **Unit** pull-down menu, then the range of ports in the **From** and **To** field. Then the user must specify the MAC address to be reauthenticated by entering it into the **MAC Address** field and checking the corresponding check box. To begin the reauthentication, click **Apply**.

RADIUS Server

The RADIUS feature of the Switch allows you to facilitate centralized user administration as well as providing protection against a sniffing, active hacker. The Web Manager offers three windows.

Click **Port Access Entity > RADIUS Server > Authentic RADIUS Server** to open the **RADIUS Server Authentication Setting** window shown below:

Succession	Radius Server	Auth UDP Port	Acct UDP Port	Status	Key
First					
Second					
Third					

Figure 6- 83. Authentic RADIUS Server Setting and Current RADIUS Server Settings Table window

This window displays the following information:

Parameter	Description
Succession	Choose the desired RADIUS server to configure: <i>First, Second or Third.</i>
RADIUS Server	Set the RADIUS server IP.
Authentic Port	Set the RADIUS authentic server(s) UDP port. The default port is 1812.
Accounting Port	Set the RADIUS account server(s) UDP port. The default port is 1813.
Key	Set the key the same as that of the RADIUS server.
Confirm Key	Confirm the shared key is the same as that of the RADIUS server.
Status	This allows you to set the RADIUS Server as Valid (Enabled) or Invalid (Disabled).

Click **Apply** to implement changes made.

6-23 Layer 3 IP Networking

Layer 3 Global Advanced Settings

The **L3 Global Advanced Settings** window allows the user to enable and disable Layer 3 settings and functions from a single window. The full settings and descriptions for these functions will appear later in this section. To view this window, open the **Configuration** folder and then the **Layer 3 IP Networking** folder and click on the **L3 Global Advanced Settings** link to access the following window.

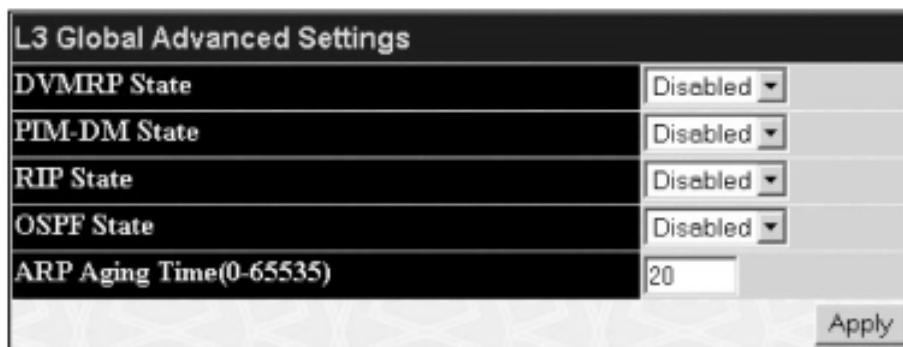

Figure 6- 84. L3 Global Advanced Settings window

The user may set the following:

Parameter	Description
DVMRP State	The user may globally enable or disable the Distance Vector Multicast Routing Protocol (DVMRP) function by using the pull down menu.
PIM-DM State	The user may globally enable or disable the Protocol Independent Multicast – Dense Mode (PIM-DM) function by using the pull down menu.
RIP State	The user may globally enable or disable the Routing Information Protocol (RIP) function by using the pull down menu.
OSPF State	The user may globally enable or disable the Open Shortest Path first (OSPF) function by using the pull down menu.
ARP Aging Time (0-65535)	The user may globally set the maximum amount of time, in minutes, that an Address Resolution Protocol (ARP) entry can remain in the Switch's ARP table, without being accessed, before it is dropped from the table. The value may be set in the range of 0-65535 minutes with a default setting of 20 minutes.

Setting Up IP Interfaces

Each VLAN must be configured prior to setting up the VLAN's corresponding IP interface.

An example is presented below:

VLAN Name	VID	Switch Ports
System (default)	1	5, 6, 7, 8, 21, 22, 23, 24
Engineer	2	9, 10, 11, 12
Marketing	3	13, 14, 15, 16
Finance	4	17, 18, 19, 20
Sales	5	1, 2, 3, 4
Backbone	6	25, 26

Table 6- 5. VLAN Example – Assigned Ports

In this case, six IP interfaces are required, so a CIDR notation of 10.32.0.0/11 (or a 11-bit) addressing scheme will work. This addressing scheme will give a subnet mask of 11111111.11100000.00000000.00000000 (binary) or 255.224.0.0 (decimal).

Using a 10.xxx.xxx.xxx IP address notation, the above example would give 6 network addresses and 6 subnets.

Any IP address from the allowed range of IP addresses for each subnet can be chosen as an IP address for an IP interface on the switch.

For this example, we have chosen the next IP address above the network address for the IP interface's IP Address:

VLAN Name	VID	Network Number	IP Address
System (default)	1	10.32.0.0	10.32.0.1
Engineer	2	10.64.0.0	10.64.0.1
Marketing	3	10.96.0.0	10.96.0.1
Finance	4	10.128.0.0	10.128.0.1
Sales	5	10.160.0.0	10.160.0.1
Backbone	6	10.192.0.0	10.192.0.1

Table 6- 6.VLAN Example – Assigned IP Interfaces

The 6 IP interfaces, each with an IP address (listed in the table above), and a subnet mask of 255.224.0.0 can be entered into the **Setup IP Interface** window.

To setup IP Interfaces on the Switch:

Go to the **Configuration** folder, and click on the **Layer 3 IP Networking** folder, and then click on the **IP Interfaces Table** link to open the following dialog box:

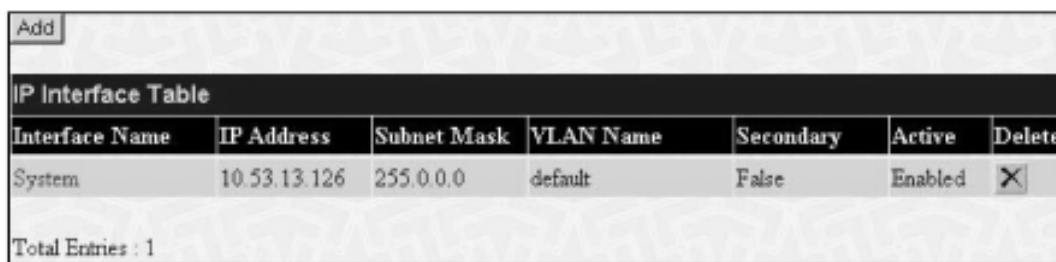

Figure 6- 85. IP Interface Table window

To setup a new IP interface, click the **Add** button. To edit an existing IP Interface entry, click on an entry under the **Interface Name** heading. Both actions will result in the same screen to configure, as shown below.

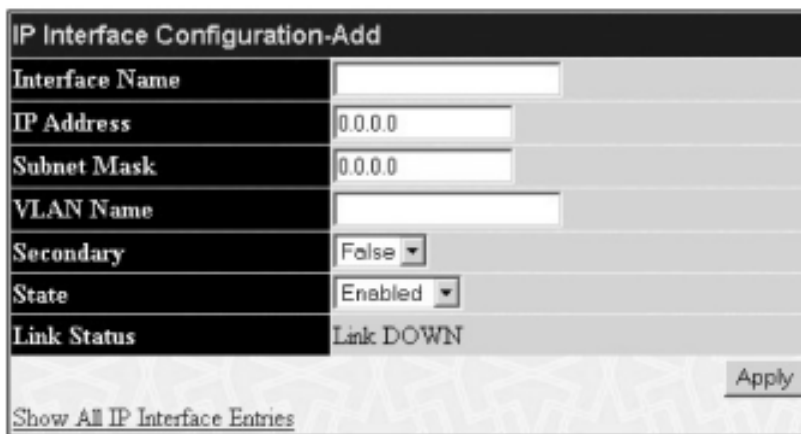

Figure 6- 86. IP Interface Configuration – Add window

Figure 6- 87. IP Interface Configuration – Edit window

Choose a name for the interface to be added and enter it in the **Interface Name** field (if you are editing an IP Interface, the **Interface Name** will already be in the top field as seen in the window above). Enter the interface's IP address and subnet mask in the corresponding fields. Pull the **State** pull-down menu to *Enabled* and click **Apply** to enter to make the IP interface effective. To view entries in the **IP Interface Table**, click the [Show All IP Interface Entries](#) hyperlink. Use the **Save Changes** dialog box from the **Maintenance** folder to enter the changes into NV-RAM.

The following fields can be set:

Parameter	Description
Interface Name	This field displays the name for the IP interface. The default IP interface is named "System".
IP Address	This field allows the entry of an IP address to be assigned to this IP interface.
Subnet Mask	This field allows the entry of a subnet mask to be applied to this IP interface.
VLAN Name	This field allows the entry of the VLAN Name for the VLAN the IP interface belongs to.
Secondary	Use the pull-down menu to set the IP interface as <i>True</i> or <i>False</i> . <i>True</i> will set the interface as secondary and <i>False</i> will denote the interface as the primary interface of the VLAN entered above. <i>Secondary</i> interfaces can only be configured if a <i>primary</i> interface is first configured.
State	This field may be altered between <i>Enabled</i> and <i>Disabled</i> using the pull down menu. This entry determines whether the interface will be active or not.
Link Status	This read only field states the current status of the IP Interface on the Switch. Link Up denotes that the IP interface is up and running on the Switch. Link Down will denote that the IP interface is not currently set and/or enabled on the Switch.

Click **Apply** to implement changes made.

MD5 Key Table Configuration

The **MD5 Key Table Configuration** menu allows the entry of a sixteen-character Message Digest – version 5 (MD5) key which can be used to authenticate every packet exchanged between OSPF routers. It is used as a security mechanism to limit the exchange of network topology information to the OSPF routing domain.

MD5 Keys created here can be used in the **OSPF Interface Configuration** menu below.

To configure an **MD5 Key**, click the **MD5 Key** link to open the following dialog box:

Figure 6- 88. MD5 Key Setting and Table window

The following fields can be set:

Parameter	Description
Key ID	A number from 1 to 255 used to identify the MD5 Key.
Key	A alphanumeric string of between 1 and 16 case-sensitive characters used to generate the Message Digest which is in turn, used to authenticate OSPF packets within the OSPF routing domain.

Click **Apply** to enter the new Key ID settings. To delete a Key ID entry, click the corresponding **X** under the **Delete** heading.

Route Redistribution Settings

Route redistribution allows routers on the network, which are running different routing protocols to exchange routing information. This is accomplished by comparing the routes stored in the various routers routing tables and assigning appropriate metrics. This information is then exchanged among the various routers according to the individual routers current routing protocol. The Switch can redistribute routing information between the OSPF and RIP routing protocols to all routers on the network that are running OSPF or RIP. Routing information entered into the **Static Routing Table** on the local AT-9724TS switch is also redistributed.

Routing information source – OSPF and the Static Route table. Routing information will be redistributed to RIP. The following table lists the allowed values for the routing metrics and the types (or forms) of the routing information that will be redistributed.

Route Source	Metric	Type
OSPF	0 to 16	All
		Internal
		External
		ExtType1
		ExtType2
		Inter-E1
		Inter-E2
RIP	0 to 1677214	Type 1
		Type 2
Static	0 to 1677214	Type 1
		Type 2
Local	0 to 1677214	Type 1
		Type 2

Table 6- 7. Route Redistribution Source table

Entering the Type combination – internal type_1 type_2 is functionally equivalent to all. Entering the combination type_1 type_2 is functionally equivalent to external. Entering the combination internal external is functionally equivalent to all.

Entering the metric 0 specifies transparency.

This window will redistribute routing information between the OSPF and RIP routing protocols to all routers on the network that are running OSPF or RIP. To access the **Route Redistribution Table Configuration** window, go to **Configuration > Layer 3 IP Networking > Route Redistribution Settings**:

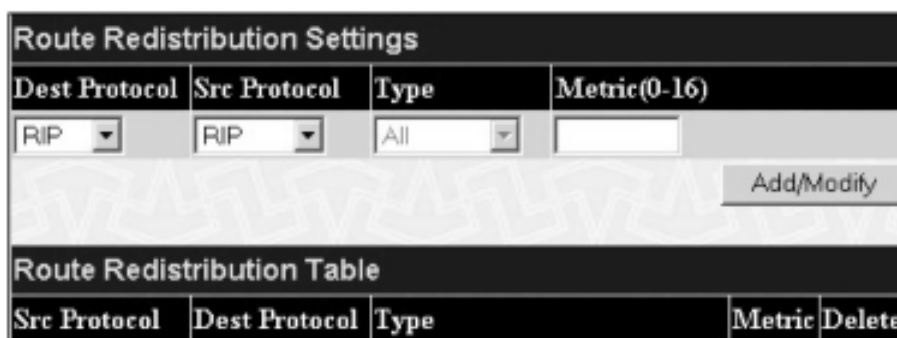



Figure 6- 89. Route Redistribution Settings and Table window

The following parameters may be set or viewed:

Parameter	Description
Dest Protocol	Allows for the selection of the protocol for the destination device. Choose between <i>RIP</i> and <i>OSPF</i> .
Src Protocol	Allows for the selection of the protocol for the source device. Choose between <i>RIP</i> , <i>OSPF</i> , <i>Static</i> and <i>Local</i> .
Type	Allows for the selection of one of six methods of calculating the metric value. The user may choose between <i>All</i> , <i>Internal</i> , <i>External</i> , <i>ExtType1</i> , <i>ExtType2</i> , <i>Inter-E1</i> , <i>Inter-E2</i> . See the table above for available metric value types for each source protocol.
Metric	Allows the entry of an OSPF interface cost. This is analogous to a Hop Count in the RIP routing protocol.

Click **Add/Modify** to implement changes made.

 **Note:** The source protocol (**Src Protocol**) entry and the destination protocol (**Dest Protocol**) entry cannot be the same.

Static/Default Route

Entries into the Switch's forwarding table can be made using both MAC addresses and IP addresses. Static IP forwarding is accomplished by the entry of an IP address into the **Switch's Static IP Routing Table**.

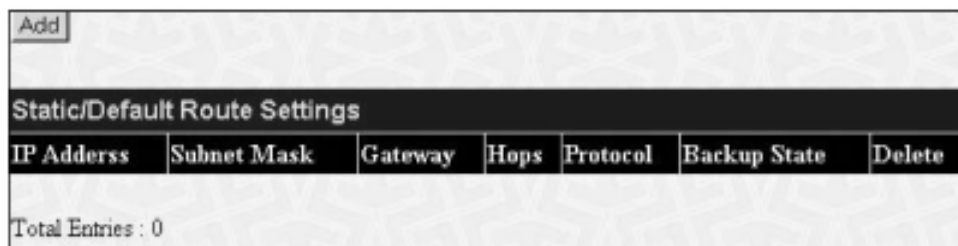

Figure 6- 90. Static/Default Route Settings window

This window shows the following values:

Parameter	Description
IP Address	The IP address of the Static/Default Route.
Subnet Mask	The corresponding Subnet Mask of the IP address entered into the table.
Gateway	The corresponding Gateway of the IP address entered into the table.
Hops	Represents the metric value of the IP interface entered into the table. This field may read a number between 1-65535 for an OSPF setting, and 1-16 for a RIP setting.
Protocol	Represents the protocol used for the Routing Table entry of the IP interface. This field may read OSPF, RIP, Static or Local.
Backup State	Represents the Backup state that this IP interface is configured for. This field may read Primary or Backup.
Delete	Click the X if you would like to delete this entry from the Static/Default Route Settings table.

To enter an IP Interface into the Switch's **Static/Default Routes** window, click the **Add** button, revealing the following window to configure.



Figure 6- 91. Static/Default Route Settings – Add window

The following fields can be set:

Parameter	Description
IP Address	Allows the entry of an IP address that will be a static entry into the Switch's Routing Table.
Subnet Mask	Allows the entry of a subnet mask corresponding to the IP address above.
Gateway IP	Allows the entry of an IP address of a gateway for the IP address above.
Metric (1-65535)	Allows the entry of a routing protocol metric representing the number of routers between the Switch and the IP address above.
Backup State	The user may choose between Primary and Backup. If the Primary Static/Default Route fails, the Backup Route will support the entry. Please take note that the Primary and Backup entries cannot have the same Gateway.

Click **Apply** to implement changes made.

Route Preference Settings

Route Preference is a way for routers to select the best path when there are two or more different routes to the same destination from two different routing protocols. The majority of routing protocols are not compatible when used in conjunction with each other. This Switch supports and may be configured for many routing protocols, as a stand-alone switch or more importantly, in utilizing the stacking function and Single IP Management of the Switch. Therefore, the ability to exchange route information and select the best path is essential to optimal use of the Switch and its capabilities.

The first decision the Switch will make in selecting the best path is to consult the Route Preference Settings table of the switch. This table can be viewed by clicking **Configuration > Layer 3 IP Networking > Route Preference Settings**, and it holds the list of possible routing protocols currently implemented on the Switch, along with a **Preference** value which determines which routing protocol will be the most dependable to route packets. Below is a list of the default route preferences set on the Switch.

Route Type	Validity Range	Default Value
Local	0 – Permanently set on the switch and unconfigurable.	0
Static	1 – 999	60
OSPF Intra	1 – 999	80
OSPF Inter	1 – 999	90
RIP	1 – 999	100
OSPF ExtT1	1 – 999	110
OSPF ExtT2	1 – 999	115

Table 6- 8. Route Preference Table

As shown above, Local will always be the first choice for routing purposes and the next most reliable path is Static due to the fact that its has the next lowest value. To set a higher reliability for a route, change its value to a number less than the value of a route preference that has a greater reliability value using the **New Route Preference Settings** window command. For example, if the user wishes to make RIP the most reliable route, the user can change its value to one that is less than the lowest value (Static - 60) or the user could change the other route values to more than 100.

The user should be aware of three points before configuring the route preference:

1. No two route preference values can be the same. Entering the same route preference may cause the switch to crash due to indecision by the switch.
2. If the user is not fully aware of all the features and functions of the routing protocols on the switch, a change in the default route preference value may cause routing loops or black holes.

- After changing the route preference value for a specific routing protocol, that protocol needs to be restarted because the previously learned routes have been dropped from the Switch. The Switch must learn the routes again before the new settings can take effect.

To view the **Route Preference Settings** window, click **Configuration > Layer 3 IP Networking > Route Preference Settings**:

Current Route Preference Settings	
Route Type	Preference
RIP	100
OSPF Intra	80
STATIC	60
LOCAL	0
OSPF Inter	90
OSPF ExtT1	110
OSPF ExtT2	115

New Route Preference Settings	
Route Type	Preference
RIP(1-999)	<input type="text" value="100"/>
OSPF Intra(1-999)	<input type="text" value="80"/>
STATIC(1-999)	<input type="text" value="60"/>
OSPF Inter(1-999)	<input type="text" value="90"/>
OSPF ExtT1(1-999)	<input type="text" value="110"/>
OSPF ExtT2(1-999)	<input type="text" value="115"/>

Figure 6- 92. Current and New Route Preference Settings window

The following fields can be viewed or set:

Parameter	Description
RIP (1-999)	Enter a value between 1 and 999 to set the route preference for <i>RIP</i> . The lower the value, the higher the chance the specified protocol will be chosen as the best path for routing packets. The default value is 100.
OSPF Intra (1-999)	Enter a value between 1 and 999 to set the route preference for <i>OSPF Intra</i> . The lower the value, the higher the chance the specified protocol will be chosen as the best path for routing packets. The default value is 80.
STATIC (1-999)	Enter a value between 1 and 999 to set the route preference for <i>Static</i> . The lower the value, the higher the chance the specified protocol will be chosen as the best path for routing packets. The default value is 60.
OSPF Inter (1-999)	Enter a value between 1 and 999 to set the route preference for <i>OSPF Inter</i> . The lower the value, the higher the chance the specified protocol will be chosen as the best path for routing packets. The default value is 90.
OSPF ExtT1 (1-999)	Enter a value between 1 and 999 to set the route preference for <i>OSPF ExtT1</i> . The lower the value, the higher the chance the specified protocol will be chosen as the best path for routing packets. The default value is 110.
OSPF ExtT2 (1-999)	Enter a value between 1 and 999 to set the route preference for <i>OSPF ExtT2</i> . The lower the value, the higher the chance the specified protocol will be chosen as the best path for routing packets. The default value is 115.

Click **Apply** to implement changes made.

Static ARP Table

The *Address Resolution Protocol (ARP)* is a TCP/IP protocol that converts IP addresses into physical addresses. This table allows network managers to view, define, modify and delete ARP information for specific devices.

Static entries can be defined in the **ARP Table**. When static entries are defined, a permanent entry is entered and is used to translate IP address to MAC addresses.

To open the **Static ARP Table** open the **Configuration** folder, and then open the **Layer 3 IP Networking** folder and click on the **Static ARP Table** link.



Figure 6- 93. Static ARP Settings window

To add a new entry, click the **Add** button, revealing the following screen to configure:

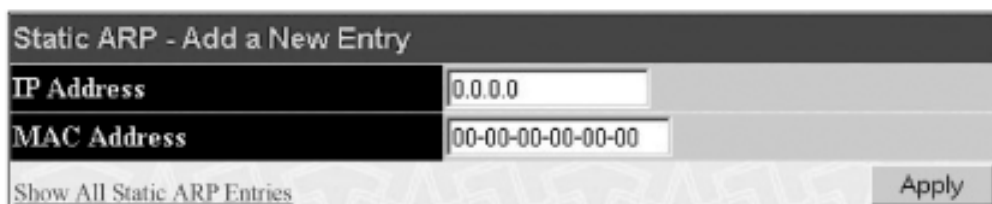

Figure 6- 94. Static ARP Table – Add a New Entry window

The following fields can be set:

Parameter	Description
IP Address	The IP address of the ARP entry.
MAC Address	The MAC address of the ARP entry.

After entering the IP Address and MAC Address of the **Static ARP** entry, click **Apply** to implement the new entry. To completely clear the **Static ARP Settings**, click the **Clear All** button. To delete an entry located in the Static ARP Settings window, click the corresponding **X** under the **Delete** heading.

RIP

The Routing Information Protocol is a distance-vector routing protocol. There are two types of network devices running RIP – active and passive. Active devices advertise their routes to others through RIP messages, while passive devices listen to these messages. Both active and passive routers update their routing tables based upon RIP messages that active routers exchange. Only routers can run RIP in the active mode.

Every 30 seconds, a router running RIP broadcasts a routing update containing a set of pairs of network addresses and a distance (represented by the number of hops or routers between the advertising router and the remote network). So, the vector is the network address and the distance is measured by the number of routers between the local router and the remote network.

RIP measures distance by an integer count of the number of hops from one network to another. A router is one hop from a directly connected network, two hops from a network that can be reached through a router, etc. The more routers between a source and a destination, the greater the RIP distance (or hop count).

There are a few rules to the routing table update process that help to improve performance and stability. A router will not replace a route with a newly learned one if the new route has the same hop count (sometimes referred to as 'cost'). So learned routes are retained until a new route with a lower hop count is learned.

When learned routes are entered into the routing table, a timer is started. This timer is restarted every time this route is advertised. If the route is not advertised for a period of time (usually 180 seconds), the route is removed from the routing table.

RIP does not have an explicit method to detect routing loops. Many RIP implementations include an authorization mechanism (a password) to prevent a router from learning erroneous routes from unauthorized routers.

To maximize stability, the hop count RIP uses to measure distance must have a low maximum value. Infinity (that is, the network is unreachable) is defined as 16 hops. In other words, if a network is more than 16 routers from the source, the local router will consider the network unreachable.

RIP can also be slow to converge (to remove inconsistent, unreachable or looped routes from the routing table) because RIP messages propagate relatively slowly through a network.

Slow convergence can be solved by using split horizon update, where a router does not propagate information about a route back to the interface on which it was received. This reduces the probability of forming transient routing loops.

Hold down can be used to force a router to ignore new route updates for a period of time (usually 60 seconds) after a new route update has been received. This allows all routers on the network to receive the message.

A router can 'poison reverse' a route by adding an infinite (16) hop count to a route's advertisement. This is usually used in conjunction with triggered updates, which force a router to send an immediate broadcast when an update of an unreachable network is received.

RIP Version 1 Message Format

There are two types of RIP messages: routing information messages and information requests. Both types use the same format.

The Command field specifies an operation according to the following table:

Command	Meaning
1	Request for partial or full routing information
2	Response containing network-distance pairs from sender's routing table
3	Turn on trace mode (obsolete)
4	Turn off trace mode (obsolete)
5	Reserved for Sun Microsystem's internal use
9	Update Request
10	Update Response
11	Update Acknowledgement

RIP Command Codes

The field Version contains the protocol version number (1 in this case), and is used by the receiver to verify which version of RIP the packet was sent.

RIP 1 Message

RIP is not limited to TCP/IP. Its address format can support up to 14 octets (when using IP, the remaining 10 octets must be zeros). Other network protocol suites can be specified in the Family of Source Network field (IP has a value of 2). This will determine how the address field is interpreted.

RIP specifies that the IP address, 0.0.0.0, denotes a default route.

The distances, measured in router hops are entered in the Distance to Source Network, and Distance to Destination Network fields.

RIP 1 Route Interpretation

RIP was designed to be used with classed address schemes, and does not include an explicit subnet mask. An extension to version 1 does allow routers to exchange subnetted addresses, but only if the subnet mask used by the network is the same as the subnet mask used by the address. This means the RIP version 1 cannot be used to propagate classless addresses.

Routers running RIP version 1 must send different update messages for each IP interface to which it is connected. Interfaces that use the same subnet mask as the router's network can contain subnetted routes, other interfaces cannot. The router will then advertise only a single route to the network.

RIP Version 2 Extensions

RIP version 2 includes an explicit subnet mask entry, so RIP version 2 can be used to propagate variable length subnet addresses or CIDR classless addresses. RIP version 2 also adds an explicit next hop entry, which speeds convergence and helps prevent the formation of routing loops.

RIP2 Message Format

The message format used with RIP2 is an extension of the RIP1 format:

RIP version 2 also adds a 16-bit route tag that is retained and sent with router updates. It can be used to identify the origin of the route.

Because the version number in RIP2 occupies the same octet as in RIP1, both versions of the protocols can be used on a given router simultaneously without interference.

RIP Configuration

To setup RIP for the IP interfaces configured on the Switch, the user must enable RIP and then configure RIP settings for the individual IP interfaces. To globally enable RIP on the Switch, open the **Configuration** folder to **Layer 3 Networking** and then open the **RIP** folder and click on the **RIP Configuration** link to access the following screen:

Figure 6- 95. RIP Global Setting window



To enable RIP, simply use the pull down menu, select **Enabled** and click **Apply**.

Setting Up RIP

RIP settings are configured for each IP interface on the Switch. Click the **RIP Interface Settings** link in the **RIP** folder. The menu appears in table form listing settings for IP interfaces currently on the Switch. To configure RIP settings for an individual interface, click on the hyperlinked **Interface Name**. To view the next page of RIP Interface Settings, click the **Next** button.

Figure 6- 96. RIP Interface Settings window

RIP Interface Settings					
Interface Name	IP Address	Tx Mode	RX Mode	Auth.	State
System	10.53.13.126	Disabled	Disabled	Disabled	Disabled

Next

Click the hyperlinked name of the interface you want to set up for RIP, which will give access to the following menu:

Figure 6- 97. RIP Interface Settings – Edit window

RIP Interface Settings-Edit	
Interface Name	System
IP Address	10.53.13.126
Tx Mode	Disabled
RX Mode	Disabled
Authentication	Disabled
Password	<input type="text"/>
State	Disabled
Interface Metric	1

Apply

[Show All RIP Interface Entries](#)

Refer to the table below for a description of the available parameters for RIP interface settings.

The following RIP settings can be applied to each IP interface:

Parameter	Description
Interface Name	The name of the IP interface on which RIP is to be setup. This interface must be previously configured on the Switch.
IP Address	The IP address corresponding to the Interface Name showing in the field above.
TX Mode <Disabled>	Toggle among <i>Disabled</i> , <i>v1 Only</i> , <i>v1 Compatible</i> , and <i>v2 Only</i> . This entry specifies which version of the RIP protocol will be used to transmit RIP packets. <i>Disabled</i> prevents the transmission of RIP packets.
RX Mode <Disabled>	Toggle among <i>Disabled</i> , <i>v1 Only</i> , <i>v2 Only</i> , and <i>v1 or v2</i> . This entry specifies which version of the RIP protocol will be used to interpret received RIP packets. <i>Disabled</i> prevents the reception of RIP packets.
Authentication	Toggle between <i>Disabled</i> and <i>Enabled</i> to specify that routers on the network should use the Password above to authenticate router table exchanges.
Password	A password to be used to authenticate communication between routers on the network.
State	Toggle between <i>Disabled</i> and <i>Enabled</i> to disable or enable this RIP interface on the switch.
Interface Metric	A read only field that denotes the Metric value of the current IP Interface setting.

Click **Apply** to implement changes made.

OSPF

The Open Shortest Path First (OSPF) routing protocol uses a link-state algorithm to determine routes to network destinations. A "link" is an interface on a router and the "state" is a description of that interface and its relationship to neighboring routers. The state contains information such as the IP address, subnet mask, type of network the interface is attached to, other routers attached to the network, etc. The collection of link-states is then collected in a link-state database that is maintained by routers running OSPF.

OSPF specifies how routers will communicate to maintain their link-state database and defines several concepts about the topology of networks that use OSPF.

To limit the extent of link-state update traffic between routers, OSPF defines the concept of Area. All routers within an area share the exact same link-state database, and a change to this database on one router triggers an update to the link-state database of all other routers in that area. Routers that have interfaces connected to more than one area are called Border Routers and take the responsibility of distributing routing information between areas.

One area is defined as Area 0 or the Backbone. This area is central to the rest of the network in that all other areas have a connection (through a router) to the backbone. Only routers have connections to the backbone and OSPF is structured such that routing information changes in other areas will be introduced into the backbone, and then propagated to the rest of the network.

When constructing a network to use OSPF, it is generally advisable to begin with the backbone (area 0) and work outward.

Link-State Algorithm

An OSPF router uses a link-state algorithm to build a shortest path tree to all destinations known to the router. The following is a simplified description of the algorithm's steps:

- When OSPF is started, or when a change in the routing information changes, the router generates a link-state advertisement. This advertisement is a specially formatted packet that contains information about all the link-states on the router.
- This link-state advertisement is flooded to all router in the area. Each router that receives the link-state advertisement will store the advertisement and then forward a copy to other routers.
- When the link-state database of each router is updated, the individual routers will calculate a Shortest Path Tree to all destinations - with the individual router as the root. The IP routing table will then be made up of the destination address, associated cost, and the address of the next hop to reach each destination.
- Once the link-state databases are updated, Shortest Path Trees calculated, and the IP routing tables written - if there are no subsequent changes in the OSPF network (such as a network link going down) there is very little OSPF traffic.

Shortest Path Algorithm

The Shortest Path to a destination is calculated using the Dijkstra algorithm. Each router is placed at the root of a tree and then calculates the shortest path to each destination based on the cumulative cost to reach that destination over multiple possible routes. Each router will then have its own Shortest Path Tree (from the perspective of its location in the network area) even though every router in the area will have and use the exact same link-state database.

The following sections describe the information used to build the Shortest Path Tree.

OSPF Cost

Each OSPF interface has an associated cost (also called "metric") that is representative of the overhead required to send packets over that interface. This cost is inversely proportional to the bandwidth of the interface (i.e. a higher bandwidth interface has a lower cost). There is then a higher cost (and longer time delays) in sending packets over a 56 Kbps dial-up connection than over a 10Mbps Ethernet connection. The formula used to calculate the OSPF cost is as follows:

Cost = 100,000,000 / bandwidth in bps

As an example, the cost of a 10Mbps Ethernet line will be 10 and the cost to cross a 1.544Mbps T1 line will be 64.

Shortest Path Tree

To build Router A's shortest path tree for the network diagrammed below, Router A is put at the root of the tree and the smallest cost link to each destination network is calculated.

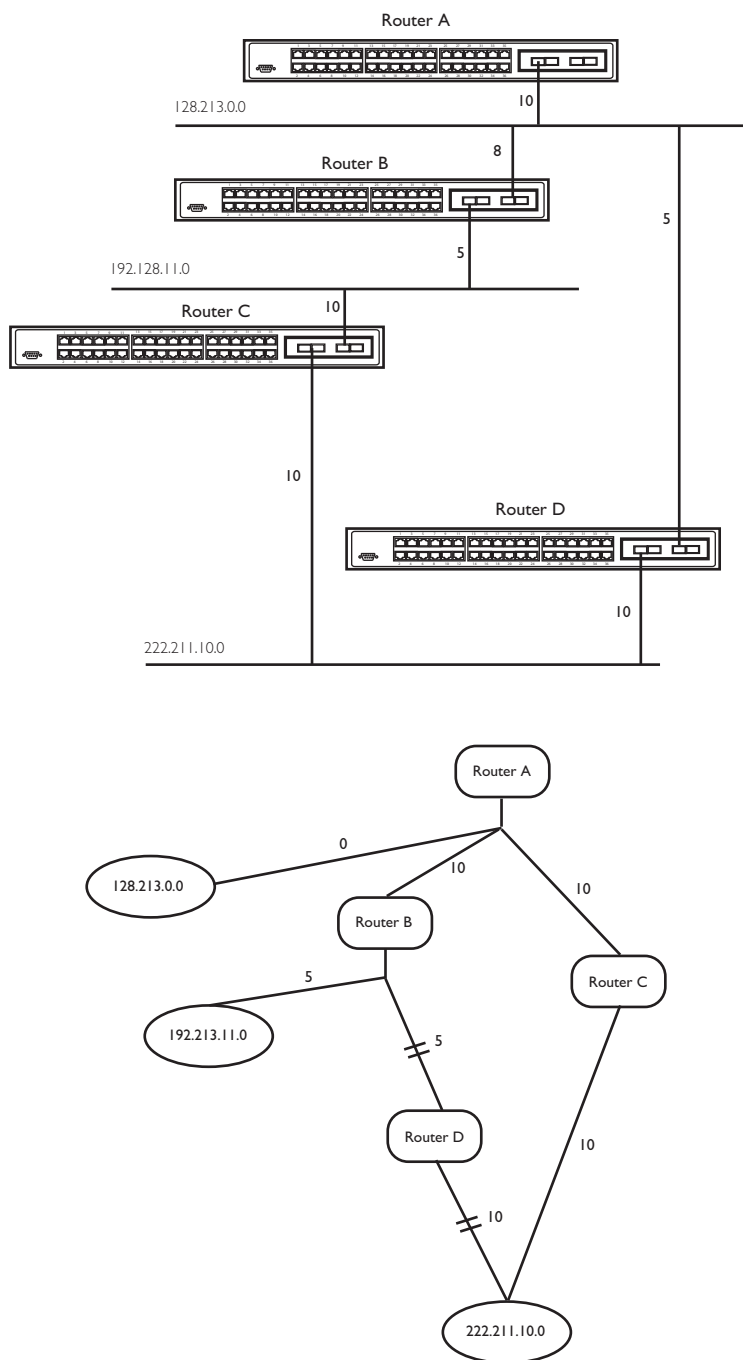

Figure 6- 98. Constructing a Shortest Path Tree

The diagram above shows the network from the viewpoint of Router A. Router A can reach 192.213.11.0 through Router B with a cost of $10+5=15$. Router A can reach 222.211.10.0 through Router C with a cost of $10+10=20$. Router A can also reach 222.211.10.0 through Router B and Router D with a cost of $10+5+10=25$, but the cost is higher than the route through Router C. This higher-cost route will not be included in the Router A's shortest path tree. The resulting tree will look like this:

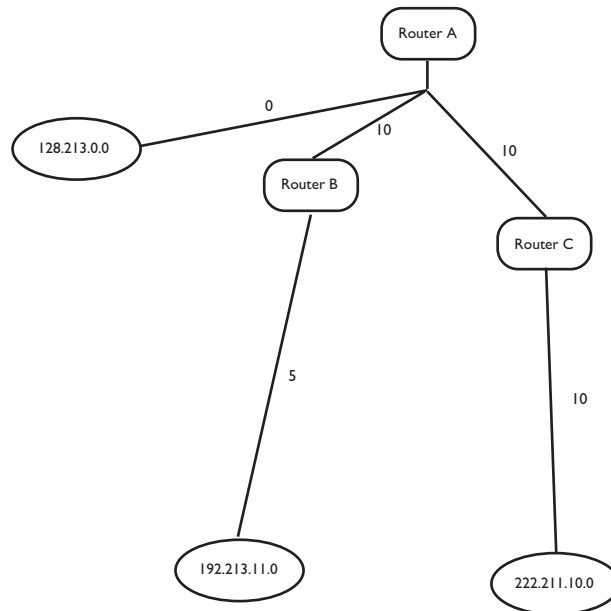

Figure 6- 99. Constructing a Shortest Path Tree – Completed

Note that this shortest path tree is only from the viewpoint of Router A. The cost of the link from Router B to Router A, for instance is not important to constructing Router A's shortest path tree, but is very important when Router B is constructing its shortest path tree.

Note also that directly connected networks are reached at a cost of 0, while other networks are reached at the cost calculated in the shortest path tree.

Router A can now build its routing table using the network addresses and costs calculated in building the above shortest path tree.

Areas and Border Routers

OSPF link-state updates are forwarded to other routers by flooding to all routers on the network. OSPF uses the concept of areas to define where on the network routers that need to receive particular link-state updates are located. This helps ensure that routing updates are not flooded throughout the entire network and to reduce the amount of bandwidth consumed by updating the various router's routing tables.

Areas establish boundaries beyond which link-state updates do not need to be flooded. So the exchange of link-state updates and the calculation of the shortest path tree are limited to the area that the router is connected to.

Routers that have connections to more than one area are called Border Routers (BR). The Border Routers have the responsibility of distributing necessary routing information and changes between areas.

Areas are specific to the router interface. A router that has all of its interfaces in the same area is called an Internal Router. A router that has interfaces in multiple areas is called a Border Router. Routers that act as gateways to other networks (possibly using other routing protocols) are called Autonomous System Border Routers (ASBRs).

Link-State Packets

There are a number of different types of link-state packets, four of which are illustrated below:

- Router Link-State Updates – These describe a router's links to destinations within an area.
- Summary Link-State Updates – Issued by Border Routers and describe links to networks outside the area but within the Autonomous System (AS).
- Network Link-State Updates – Issued by multi-access areas that have more than one attached router. One router is elected as the Designated Router (DR) and this router issues the network link-state updates describing every router on the segment.
- External Link-State Updates – Issued by an Autonomous System Border Router and describes routes to destinations outside the AS or a default route to the outside AS.

The format of these link-state updates is described in more detail below.

Router link-state updates are flooded to all routers in the current area. These updates describe the destinations reachable through all of the router's interfaces.

Summary link-state updates are generated by Border Routers to distribute routing information about other networks within the AS. Normally, all Summary link-state updates are forwarded to the backbone (area 0) and are then forwarded to all other areas in the network. Border Routers also have the responsibility of distributing routing information from the Autonomous System Border Router in order for routers in the network to get and maintain routes to other Autonomous Systems.

Network link-state updates are generated by a router elected as the Designated Router on a multi-access segment (with more than one attached router). These updates describe all of the routers on the segment and their network connections.

External link-state updates carry routing information to networks outside the Autonomous System. The Autonomous System Border Router is responsible for generating and distributing these updates.

OSPF Authentication

OSPF packets can be authenticated as coming from trusted routers by the use of predefined passwords. The default for routers is to use not authentication.

There are two other authentication methods – simple password authentication (key) and Message Digest authentication (MD-5).

Message Digest Authentication (MD-5)

MD-5 authentication is a cryptographic method. A key and a key-ID are configured on each router. The router then uses an algorithm to generate a mathematical “message digest” that is derived from the OSPF packet, the key and the key-ID. This message digest (a number) is then appended to the packet. The key is not exchanged over the wire and a non-decreasing sequence number is included to prevent replay attacks.

Simple Password Authentication

A password (or key) can be configured on a per-area basis. Routers in the same area that participate in the routing domain must be configured with the same key. This method is possibly vulnerable to passive attacks where a link analyzer is used to obtain the password.

Backbone and Area 0

OSPF limits the number of link-state updates required between routers by defining areas within which a given router operates. When more than one area is configured, one area is designated as area 0 – also called the backbone.

The backbone is at the center of all other areas – all areas of the network have a physical (or virtual) connection to the backbone through a router. OSPF allows routing information to be distributed by forwarding it into area 0, from which the information can be forwarded to all other areas (and all other routers) on the network.

In situations where an area is required, but is not possible to provide a physical connection to the backbone, a virtual link can be configured.

Virtual Links

Virtual links accomplish two purposes:

- Linking an area that does not have a physical connection to the backbone.
- Patching the backbone in case there is a discontinuity in area 0.

Areas Not Physically Connected to Area 0

All areas of an OSPF network should have a physical connection to the backbone, but in some cases it is not possible to physically connect a remote area to the backbone. In these cases, a virtual link is configured to connect the remote area to the backbone. A virtual path is a logical path between two border routers that have a common area, with one border router connected to the backbone.

Partitioning the Backbone

OSPF also allows virtual links to be configured to connect the parts of the backbone that are discontinuous. This is the equivalent to linking different area 0s together using a logical path between each area 0. Virtual links can also be added for redundancy to protect against a router failure. A virtual link is configured between two border routers that both have a connection to their respective area 0s.

Neighbors

Routers that are connected to the same area or segment become neighbors in that area. Neighbors are elected via the Hello protocol. IP multicast is used to send out Hello packets to other routers on the segment. Routers become neighbors when they see themselves listed in a Hello packet sent by another router on the same segment. In this way, two-way communication is guaranteed to be possible between any two neighbor routers.

Any two routers must meet the following conditions before they become neighbors:

- **Area ID** – Two routers having a common segment – their interfaces have to belong to the same area on that segment. Of course, the interfaces should belong to the same subnet and have the same subnet mask.
- **Authentication** – OSPF allows for the configuration of a password for a specific area. Two routers on the same segment and belonging to the same area must also have the same OSPF password before they can become neighbors.
- **Hello and Dead Intervals** – The Hello interval specifies the length of time, in seconds, between the hello packets that a router sends on an OSPF interface. The dead interval is the number of seconds that a router’s Hello packets have not been seen before its neighbors declare the OSPF router down. OSPF routers exchange Hello packets on each segment in order to acknowledge each other’s existence on a segment and to elect a Designated Router on multi-access segments. OSPF requires these intervals to be exactly the same between any two neighbors. If any of these intervals are different, these routers will not become neighbors on a particular segment.
- **Stub Area Flag** – Any two routers also have to have the same stub area flag in their Hello packets in order to become neighbors.

Adjacencies

Adjacent routers go beyond the simple Hello exchange and participate in the link-state database exchange process. OSPF elects one router as the Designated Router (DR) and a second router as the Backup Designated Router (BDR) on each multi-access segment (the BDR is a backup in case of a DR failure). All other routers on the segment will then contact the DR for link-state database updates and exchanges. This limits the bandwidth required for link-state database updates.

Designated Router Election

The election of the DR and BDR is accomplished using the Hello protocol. The router with the highest OSPF priority on a given multi-access segment will become the DR for that segment. In case of a tie, the router with the highest Router ID wins. The default OSPF priority is 1. A priority of zero indicates a router that cannot be elected as the DR.

Building Adjacency

Two routers undergo a multi-step process in building the adjacency relationship. The following is a simplified description of the steps required:

- **Down** – No information has been received from any router on the segment.
- **Attempt** – On non-broadcast multi-access networks (such as Frame Relay or X.25), this state indicates that no recent information has been received from the neighbor. An effort should be made to contact the neighbor by sending Hello packets at the reduced rate set by the Poll Interval.
- **Init** – The interface has detected a Hello packet coming from a neighbor but bi-directional communication has not yet been established.
- **Two-way** – Bi-directional communication with a neighbor has been established. The router has seen its address in the Hello packets coming from a neighbor. At the end of this stage the DR and BDR election would have been done. At the end of the Two-way stage, routers will decide whether to proceed in building an adjacency or not. The decision is based on whether one of the routers is a DR or a BDR or the link is a point-to-point or virtual link.
- **Exstart** – (Exchange Start) Routers establish the initial sequence number that is going to be used in the information exchange packets. The sequence number insures that routers always get the most recent information. One router will become the primary and the other will become secondary. The primary router will poll the secondary for information.
- **Exchange** – Routers will describe their entire link-state database by sending database description packets.
- **Loading** – The routers are finalizing the information exchange. Routers have link-state request list and a link-state retransmission list. Any information that looks incomplete or outdated will be put on the request list. Any update that is sent will be put on the retransmission list until it gets acknowledged.
- **Full** – The adjacency is now complete. The neighboring routers are fully adjacent. Adjacent routers will have the same link-state database.

Adjacencies on Point-to-Point Interfaces

OSPF Routers that are linked using point-to-point interfaces (such as serial links) will always form adjacencies. The concepts of DR and BDR are unnecessary.

OSPF Packet Formats

All OSPF packet types begin with a standard 24-byte header and there are five packet types. The header is described first, and each packet type is described in a subsequent section.

All OSPF packets (except for Hello packets) forward link-state advertisements. Link-State Update packets, for example, flood advertisements throughout the OSPF routing domain.

- OSPF packet header
- Hello packet
- Database Description packet
- Link-State Request packet
- Link-State Update packet
- Link-State Acknowledgment packet

OSPF Packet Header

Every OSPF packet is preceded by a common 24-byte header. This header contains the information necessary for a receiving router to determine if the packet should be accepted for further processing.

The format of the OSPF packet header is shown below:

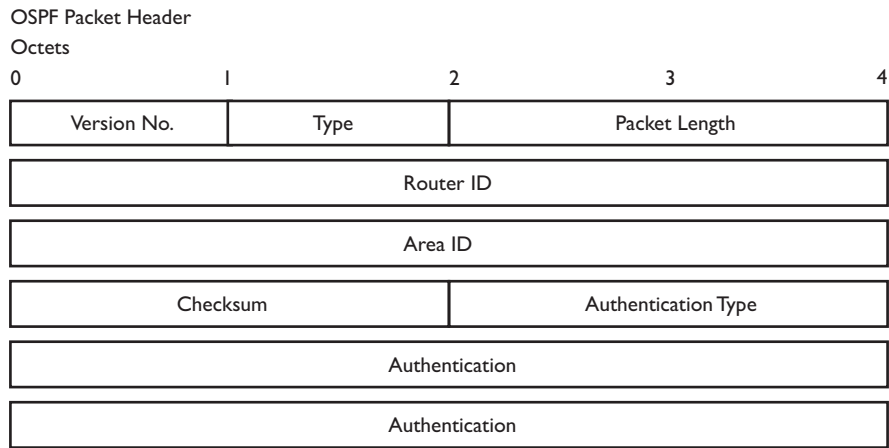

Figure 6- 100. OSPF Packet Header Format

Field	Description
Version No.	The OSPF version number.
Type	The OSPF packet type. The OSPF packet types are as follows: Type Description Hello Database Description Link-State Request Link-State Update Link-State Acknowledgment.
Packet Length	The length of the packet in bytes. This length includes the 24-byte header.
Router ID	The Router ID of the packet's source.
Area ID	A 32-bit number identifying the area that this packet belongs to. All OSPF packets are associated with a single area. Packets traversing a virtual link are assigned the backbone Area ID of 0.0.0.0
Checksum	A standard IP checksum that includes all of the packet's contents except for the 64-bit authentication field.
Authentication Type	The type of authentication to be used for the packet.
Authentication	A 64-bit field used by the authentication scheme.

Hello Packet

Hello packets are OSPF packet type 1. They are sent periodically on all interfaces, including virtual links, in order to establish and maintain neighbor relationships. In addition, Hello Packets are multicast on those physical networks having a multicast or broadcast capability, enabling dynamic discovery of neighboring routers.

All routers connected to a common network must agree on certain parameters such as the Network Mask, the Hello Interval, and the Router Dead Interval. These parameters are included in hello packets, so that differences can inhibit the forming of neighbor relationships. A detailed explanation of the receive processing for Hello packets, so that differences can inhibit the forming of neighbor relationships.

The format of the Hello packet is shown below:

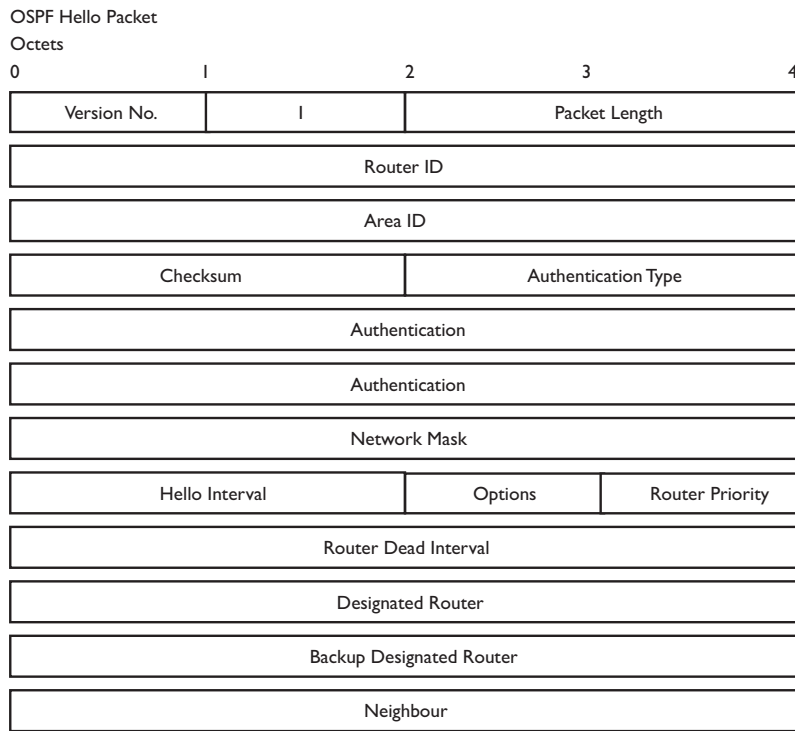

Figure 6- 101. Hello Packet

Field	Description
Network Mask	The network mask associated with this interface.
Options	The optional capabilities supported by the router.
Hello Interval	The number of seconds between this router's Hello packets.
Router Priority	This router's Router Priority. The Router Priority is used in the election of the DR and BDR. If this field is set to 0, the router is ineligible to become the DR or the BDR.
Router Dead Interval	The number of seconds that must pass before declaring a silent router as down.
Designated Router	The identity of the DR for this network, in the view of the advertising router. The DR is identified here by its IP interface address on the network.
Backup Designated Router	The identity of the Backup Designated Router (BDR) for this network. The BDR is identified here by its IP interface address on the network. This field is set to 0.0.0.0 if there is no BDR.
Neighbor	The Router IDs of each router from whom valid Hello packets have been seen within the Router Dead Interval on the network.

Database Description Packet

Database Description packets are OSPF packet type 2. These packets are exchanged when an adjacency is being initialized. They describe the contents of the topological database. Multiple packets may be used to describe the database. For this purpose a poll-response procedure is used. One of the routers is designated to be master, the other a slave. The master sends Database Description packets (polls) that are acknowledged by Database Description packets sent by the slave (responses). The responses are linked to the polls via the packets' DD sequence numbers.

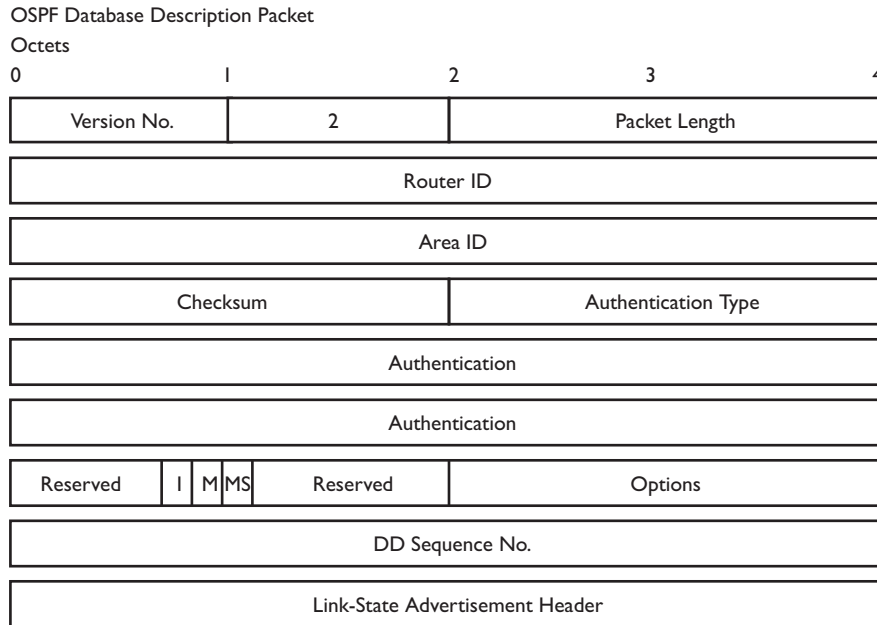

Figure 6- 102. Database Description Packet

Field	Description
Options	The optional capabilities supported by the router.
I – bit	The Initial bit. When set to 1, this packet is the first in the sequence of Database Description packets.
M – bit	The More bit. When set to 1, this indicates that more Database Description packets will follow.
MS – bit	The Master Slave bit. When set to 1, this indicates that the router is the master during the Database Exchange process. A zero indicates the opposite.
DD Sequence Number	User to sequence the collection of Database Description Packets. The initial value (indicated by the Initial bit being set) should be unique. The DD sequence number then increments until the complete database description has been sent.

The rest of the packet consists of a list of the topological database's pieces. Each link state advertisement in the database is described by its link state advertisement header.

Link-State Request Packet

Link-State Request packets are OSPF packet type 3. After exchanging Database Description packets with a neighboring router, a router may find that parts of its topological database are out of date. The Link-State Request packet is used to request the pieces of the neighbor's database that are more up to date. Multiple Link-State Request packets may need to be used. The sending of Link-State Request packets is the last step in bringing up an adjacency.

A router that sends a Link-State Request packet has in mind the precise instance of the database pieces it is requesting, defined by LS sequence number, LS checksum, and LS age, although these fields are not specified in the Link-State Request packet itself. The router may receive even more recent instances in response.

The format of the Link-State Request packet is shown below:

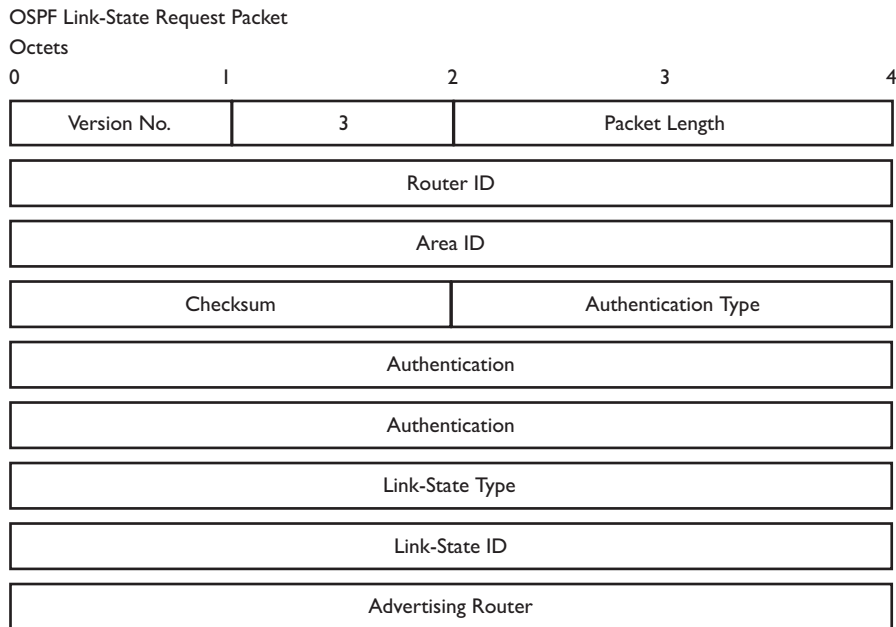

Figure 6- 103. Link-State Request Packet

Each advertisement requested is specified by its Link-State Type, Link-State ID, and Advertising Router. This uniquely identifies the advertisement, but not its instance. Link-State Request packets are understood to be requests for the most recent instance.

Link-State Update Packet

Link-State Update packets are OSPF packet type 4. These packets implement the flooding of link-state advertisements. Each Link-State Update packet carries a collection of link-state advertisements one hop further from its origin. Several link-state advertisements may be included in a single packet.

Link-State Update packets are multicast on those physical networks that support multicast/broadcast. In order to make the flooding procedure reliable, flooded advertisements are acknowledged in Link-State Acknowledgment packets. If retransmission of certain advertisements is necessary, the retransmitted advertisements are always carried by unicast Link-State Update packets.

The format of the Link-State Update packet is shown below:

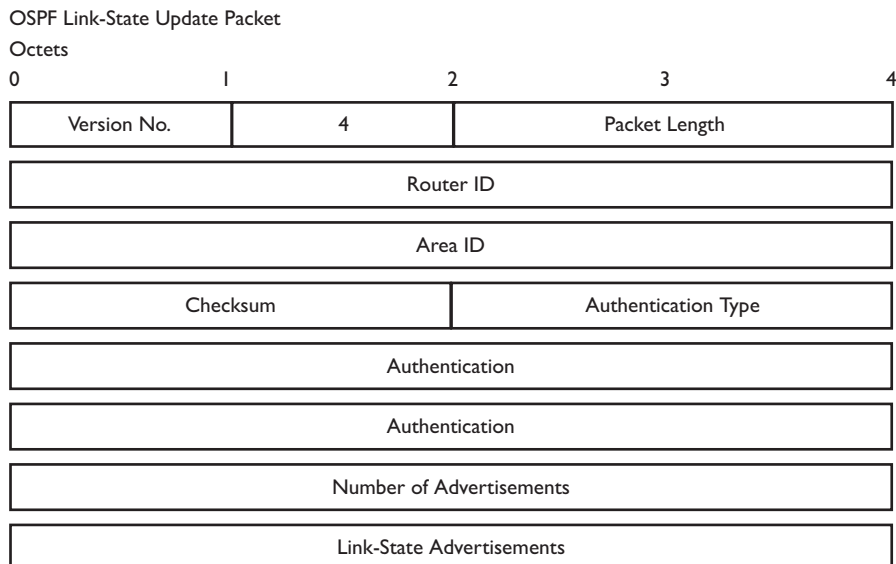

Figure 6- 104. Link-State Update Packet

The body of the Link-State Update packet consists of a list of link-state advertisements. Each advertisement begins with a common 20-byte header, the link-state advertisement header. Otherwise, the format of each of the five types of link-state advertisements is different.

Link-State Acknowledgment Packet

Link-State Acknowledgment packets are OSPF packet type 5. To make the flooding of link-state advertisements reliable, flooded advertisements are explicitly acknowledged. This acknowledgment is accomplished through the sending and receiving of Link-State Acknowledgment packets. Multiple link-state advertisements can be acknowledged in a single Link-State Acknowledgment packet. Depending on the state of the sending interface and the source of the advertisements being acknowledged, a Link-State Acknowledgment packet is sent either to the multicast address AllSPFRouters, to the multicast address AllDRouters, or as a unicast packet.

The format of this packet is similar to that of the Data Description packet. The body of both packets is simply a list of link-state advertisement headers.

The format of the Link-State Acknowledgment packet is shown below:

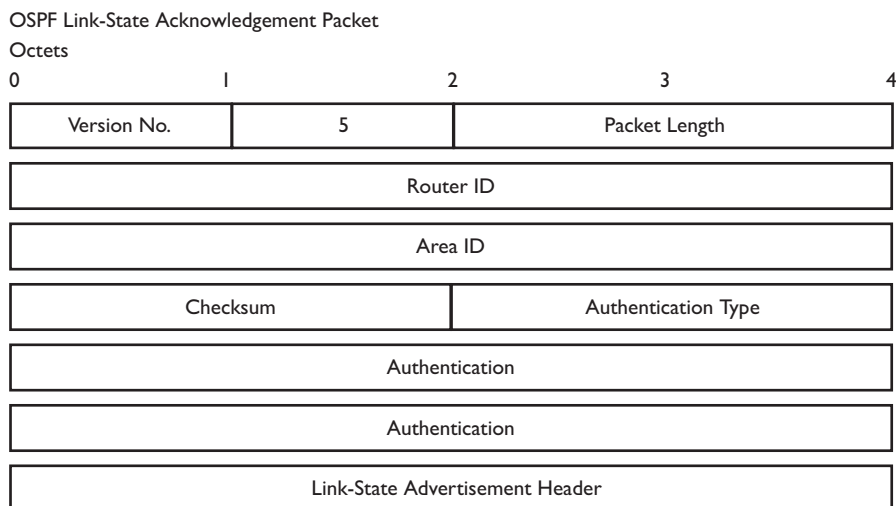

Figure 6- 105. Link State Acknowledge Packet

Each acknowledged link-state advertisement is described by its link-state advertisement header. It contains all the information required to uniquely identify both the advertisement and the advertisement's current instance.

Link-State Advertisement Formats

There are five distinct types of link-state advertisements. Each link-state advertisement begins with a standard 20-byte link-state advertisement header. Succeeding sections then diagram the separate link-state advertisement types.

Each link-state advertisement describes a piece of the OSPF routing domain. Every router originates a router links advertisement. In addition, whenever the router is elected as the Designated Router, it originates a network links advertisement. Other types of link-state advertisements may also be originated. The flooding algorithm is reliable, ensuring that all routers have the same collection of link-state advertisements. The collection of advertisements is called the link-state (or topological) database.

From the link-state database, each router constructs a shortest path tree with itself as root. This yields a routing table.

There are four types of link state advertisements, each using a common link state header. These are:

- Router Links Advertisements
- Network Links Advertisements
- Summary Link Advertisements
- Autonomous System Link Advertisements

Link State Advertisement Header

All link state advertisements begin with a common 20-byte header. This header contains enough information to uniquely identify the advertisements (Link State Type, Link State ID, and Advertising Router). Multiple instances of the link state advertisement may exist in the routing domain at the same time. It is then necessary to determine which instance is more recent. This is accomplished by examining the link state age, link state sequence number and link state checksum fields that are also contained in the link state advertisement header.

The format of the Link State Advertisement Header is shown below:

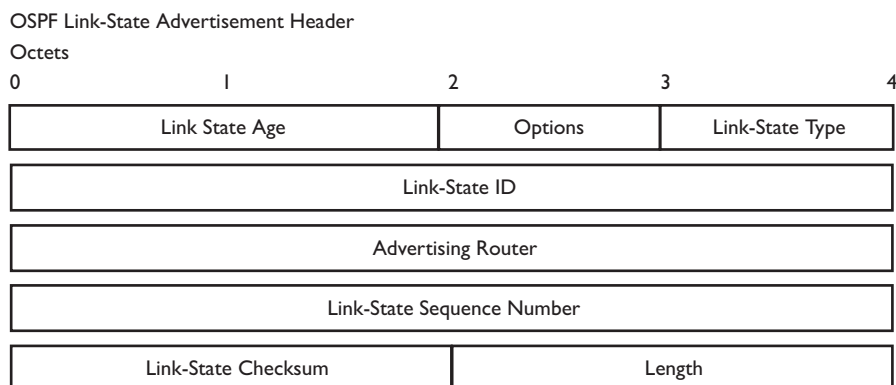

Figure 6- 106. Link State Advertisement Header

Field	Description
Link State Age	The time in seconds since the link state advertisement was originated.
Options	The optional capabilities supported by the described portion of the routing domain.
Link State Type	The type of the link state advertisement. Each link state type has a separate advertisement format. The link state types are as follows: Router Links, Network Links, Summary Link (IP Network), Summary Link (ASBR), AS External Link.
Link State ID	This field identifies the portion of the internet environment that is being described by the advertisement. The contents of this field depend on the advertisement's Link State Type.
Advertising Router	The Router ID of the router that originated the Link State Advertisement. For example, in network links advertisements this field is set to the Router ID of the network's Designated Router.
Link State Sequence Number	Detects old or duplicate link state advertisements. Successive instances of a link state advertisement are given successive Link State Sequence numbers.
Link State Checksum	The Fletcher checksum of the complete contents of the link state advertisement, including the link state advertisement header by accepting the Link State Age field.
Length	The length in bytes of the link state advertisement. This includes the 20-byte link state advertisement header.

Router Links Advertisements

Router links advertisements are type 1 link state advertisements. Each router in an area originates a router's links advertisement. The advertisement describes the state and cost of the router's links to the area. All of the router's links to the area must be described in a single router links advertisement.

The format of the Router Links Advertisement is shown below:

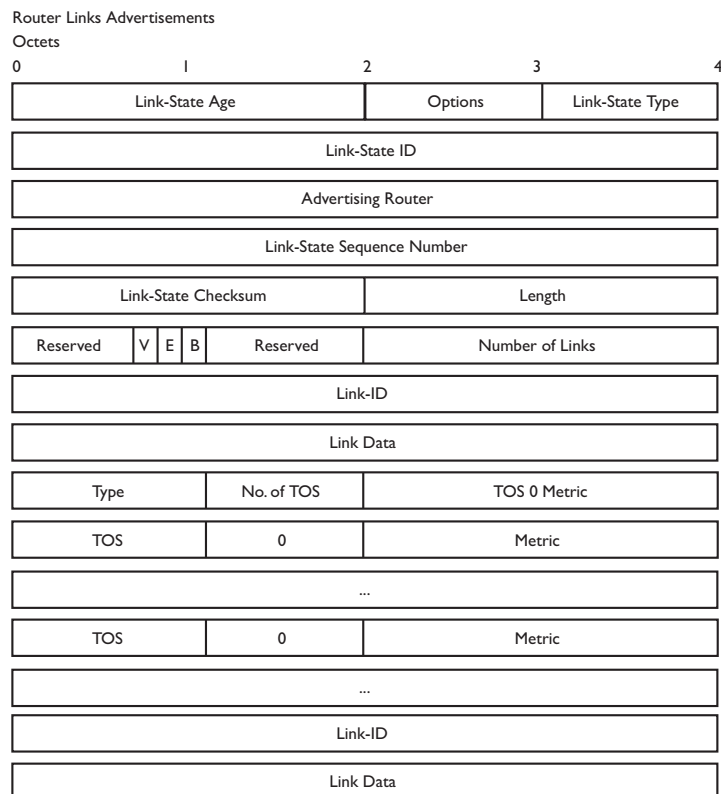

Figure 6- 107. Routers Links Advertisements

In router links advertisements, the Link State ID field is set to the router's OSPF Router ID. The T-bit is set in the advertisement's Option field if and only if the router is able to calculate a separate set of routes for each IP Type of Service (TOS). Router links advertisements are flooded throughout a single area only.

Field	Description
V – bit	When set, the router is an endpoint of an active virtual link that is using the described area as a Transit area (V is for Virtual link endpoint).
E – bit	When set, the router is an Autonomous System (AS) boundary router (E is for External).
B – bit	When set, the router is an area border router (B is for Border).
Number of Links	The number of router links described by this advertisement. This must be the total collection of router links to the area.

The following fields are used to describe each router link. Each router link is typed. The Type field indicates the kind of link being described. It may be a link to a transit network, to another router or to a stub network. The values of all the other fields describing a router link depend on the link's Type. For example, each link has an associated 32-bit data field. For links to stub networks this field specifies the network's IP address mask. For other link types the Link Data specifies the router's associated IP interface address.

Field	Description
Type	A quick classification of the router link. One of the following: Type Description Point-to-point connection to another router. Connection to a transit network. Connection to a stub network. Virtual link.
Link ID	Identifies the object that this router link connects to. Value depends on the link's Type. When connecting to an object that also originates a link state advertisement (i.e. another router or a transit network) the Link ID is equal to the neighboring advertisement's Link State ID. This provides the key for looking up an advertisement in the link state database. Type Link ID Neighboring router's Router ID. IP address of Designated Router. IP network/subnet number. Neighboring router's Router ID.
Link Data	Contents again depend on the link's Type field. For connections to stub networks, it specifies the network's IP address mask. For unnumbered point-to-point connection, it specifies the interface's MIB-II ifIndex value. For other link types it specifies the router's associated IP interface address. This latter piece of information is needed during the routing table build process, when calculating the IP address of the next hop.
No. of TOS	The number of different Type of Service (TOS) metrics given for this link, not counting the required metric for TOS 0. If no additional TOS metrics are given, this field should be set to 0.
TOS 0 Metric	The cost of using this router link for TOS 0.

For each link, separate metrics may be specified for each Type of Service (TOS). The metric for TOS 0 must always be included, and was discussed above. Metrics for non-zero TOS are described below. Note that the cost for non-zero TOS values that are not specified defaults to the TOS 0 cost. Metrics must be listed in order of increasing TOS encoding. For example, the metric for TOS 16 must always follow the metric for TOS 8 when both are specified.

Field	Description
TOS	IP Type of Service that this metric refers to.
Metric	The cost of using this outbound router link, for traffic of the specified TOS.

Network Links Advertisements

Network links advertisements are Type 2 link state advertisements. A network links advertisement is originated for each transit network in the area. A transit network is a multi-access network that has more than one attached router. The network links advertisement is originated by the network's Designated router. The advertisement describes all routers attached to the network, including the Designated Router itself. The advertisement's Link State ID field lists the IP interface address of the Designated Router.

The distance from the network to all attached routers is zero, for all TOS. This is why the TOS and metric fields need not be specified in the network links advertisement.

The format of the Network Links Advertisement is shown below:

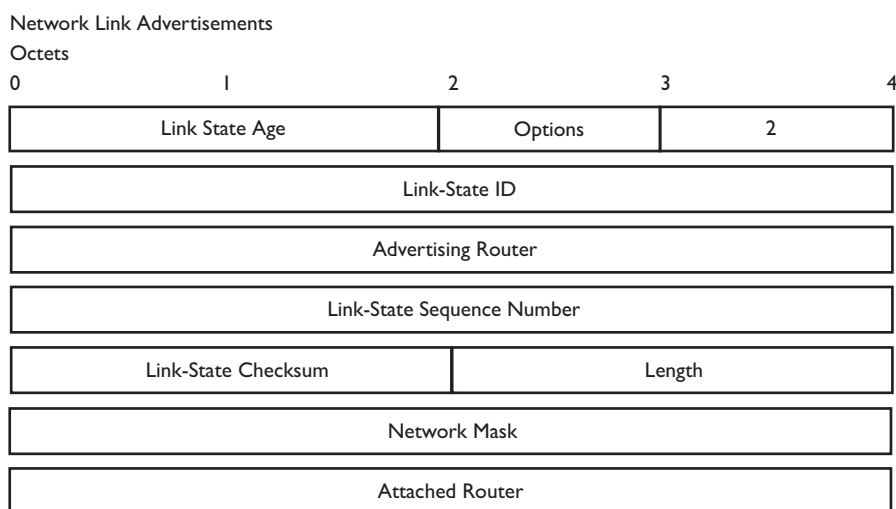

Figure 6- 108. Network Link Advertisements

Field	Description
Network Mask	The IP address mask for the network.
Attached Router	The Router Ids of each of the routers attached to the network. Only those routers that are fully adjacent to the Designated Router (DR) are listed. The DR includes itself in this list.

Summary Link Advertisements

Summary link advertisements are Type 3 and 4 link state advertisements. These advertisements are originated by Area Border routers. A separate summary link advertisement is made for each destination known to the router, that belongs to the Autonomous System (AS), yet is outside the area.

Type 3 link state advertisements are used when the destination is an IP network. In this case, the advertisement's Link State ID field is an IP network number. When the destination is an AS boundary router, a Type 4 advertisement is used, and the Link State ID field is the AS boundary router's OSPF Router ID. Other than the difference in the Link State ID field, the format of Type 3 and 4 link state advertisements is identical.

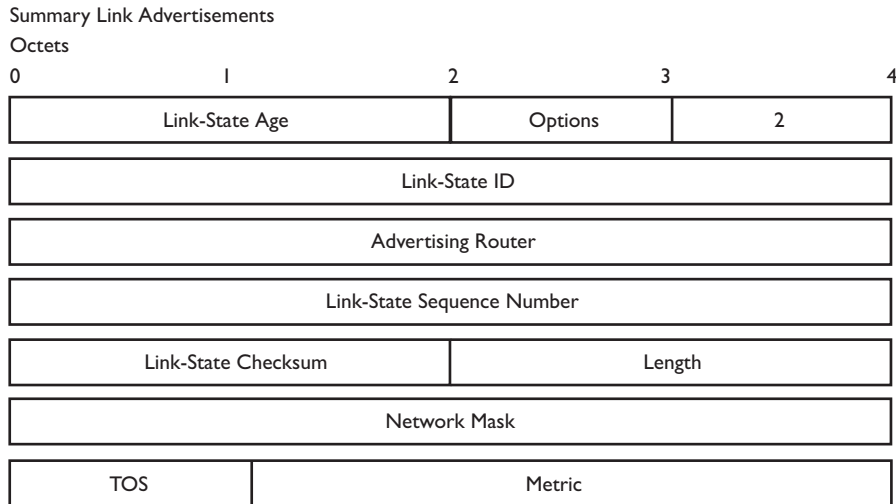

Figure 6- 109. Summary Link Advertisements

For stub area, Type 3 summary link advertisements can also be used to describe a default route on a per-area basis. Default summary routes are used in stub area instead of flooding a complete set of external routes. When describing a default summary route, the advertisement's Link State ID is always set to the Default Destination – 0.0.0.0, and the Network Mask is set to 0.0.0.0.

Separate costs may be advertised for each IP Type of Service. Note that the cost for TOS 0 must be included, and is always listed first. If the T-bit is reset in the advertisement's Option field, only a route for TOS 0 is described by the advertisement. Otherwise, routes for the other TOS values are also described. If a cost for a certain TOS is not included, its cost defaults to that specified for TOS 0.

Field	Description
Network Mask	For Type 3 link state advertisements, this indicates the destination network's IP address mask. For example, when advertising the location of a class A network the value 0xff000000
TOS	The Type of Service that the following cost is relevant to.
Metric	The cost of this route. Expressed in the same units as the interface costs in the router links advertisements.

Autonomous Systems External Link Advertisements

Autonomous Systems (AS) link advertisements are Type 5 link state advertisements. These advertisements are originated by AS boundary routers. A separate advertisement is made for each destination known to the router that is external to the AS.

AS external link advertisements usually describe a particular external destination. For these advertisements the Link State ID field specifies an IP network number. AS external link advertisements are also used to describe a default route. Default routes are used when no specific route exists to the destination. When describing a default route, the Link Stat ID is always set the Default Destination address (0.0.0.0) and the Network Mask is set to 0.0.0.0.

The format of the AS External Link Advertisement is shown below:

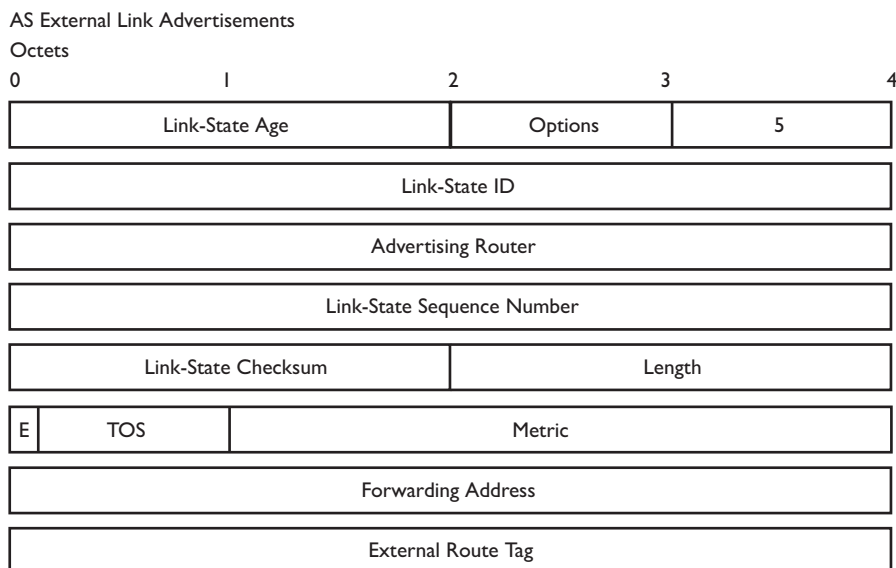

Figure 6- 110. AS External Link Advertisements

Field	Description
Network Mask	The IP address mask for the advertised destination.
E – bit	The type of external metric. If the E - bit is set, the metric specified is a Type 2 external metric. This means the metric is considered larger than any link state path. If the E - bit is zero, the specified metric is a Type 1 external metric. This means that is comparable directly to the link state metric.
Forwarding Address	Data traffic for the advertised destination will be forwarded to this address. If the Forwarding Address is set to 0.0.0.0, data traffic will be forwarded instead to the advertisement's originator.
TOS	The Type of Service that the following cost is relevant to.
Metric	The cost of this route. The interpretation of this metric depends on the external type indication (the E - bit above).
External Route Tag	A 32-bit field attached to each external route. This is not used by the OSPF protocol itself.

General OSPF Settings

The **OSPF General Setting** menu allows OSPF to be enabled or disabled on the Switch – without changing the Switch's OSPF configuration.

From the Layer 3 IP Networking folder, open the OSPF folder and click on the OSPF General Setting link. To enable OSPF, first supply an **OSPF Route ID** (see below), select *Enabled* from the **State** drop-down menu and click the **Apply** button.

OSPF Global Settings	
OSPF Route ID	0.0.0.0
Current Route ID	0.0.0.0 (Auto selected)
State	Disabled

Apply

Figure 6- 111. OSPF Global Settings window

The following parameters are used for general OSPF configuration:

Parameter	Description
OSPF Route ID	A 32-bit number (in the same format as an IP address – xxx.xxx.xxx.xxx) that uniquely identifies the Switch in the OSPF domain. It is common to assign the highest IP address assigned to the Switch (router). In this case, it would be 10.53.13.189, but any unique 32-bit number will do. If 0.0.0.0 is entered, the highest IP address assigned to the Switch will become the OSPF Route ID.
Current Route ID	Displays the OSPF Route ID currently in use by the Switch. This Route ID is displayed as a convenience to the user when changing the Switch's OSPF Route ID.
State	Allows OSPF to be enabled or disabled globally on the Switch without changing the OSPF configuration.

OSPF Area ID Setting

This menu allows the configuration of OSPF Area IDs and to designate these areas as either **Normal** or **Stub**. Normal OSPF areas allow Link-State Database (LSDB) advertisements of routes to networks that are external to the area. Stub areas do not allow the LSDB advertisement of external routes. Stub areas use a default summary external route (0.0.0.0 or Area 0) to reach external destinations.

To set up an OSPF Area configuration click **Configuration > Layer 3 IP Networking > OSPF > OSPF Area ID Settings** link to open the following dialog box:

OSPF Area Settings			
Area ID	Type	Stub Import Summary LSA	Stub Default Cost
0.0.0.0	Normal	Disabled	1

Add/Modify

OSPF Area ID Table				
Area ID	Type	Stub Import Summary LSA	Stub Default Cost	Delete
0.0.0.0	Normal	None	None	X

Figure 6- 112. OSPF Area ID Settings and Table window

To add an OSPF Area to the table, type a unique **Area ID** (see below) select the **Type** from the drop-down menu. For a Stub type, choose *Enabled* or *Disabled* from the **Stub Import Summary LSA** drop-down menu and determine the **Stub Default Cost**. Click the **Add/Modify** button to add the **Area ID** set to the table.

To remove an Area ID configuration set, simply click **X** in the **Delete** column for the configuration.

To change an existing set in the list, type the **Area ID** of the set you want to change, make the changes and click the **Add/Modify** button. The modified OSPF Area ID will appear in the table.

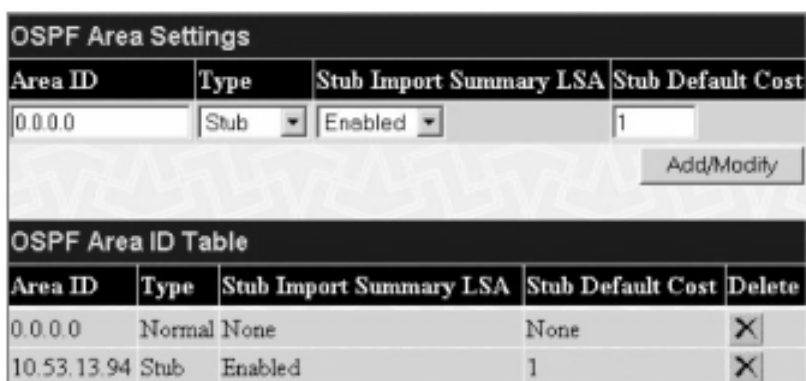

Figure 6- 113. OSPF Area Setting Example window

See the parameter descriptions below for information on the **OSPF Area ID Settings**.

The **Area ID** settings are as follows:

Parameter	Description
Area ID	A 32-bit number in the form of an IP address (xxx.xxx.xxx.xxx) that uniquely identifies the OSPF area in the OSPF domain.
Type	This field can be toggled between Normal and Stub using the space bar. When it is toggled to Stub, additional fields appear •Stub Import Summary LSA, and Default Cost.
Stub Import Summary LSA	Displays whether or not the selected Area will allow Summary Link-State Advertisements (Summary LSAs) to be imported into the area from other areas.
Stub Default Cost	Displays the default cost for the route to the stub of between 0 and 65,535. The default is 1.

OSPF Interface Settings

To set up OSPF interfaces, click **Configuration > Layer 3 IP Networking > OSPF > OSPF Interface Settings** to view OSPF settings for existing IP interfaces. If there are no IP interfaces configured (besides the default System interface), only the System interface settings will appear listed. To change settings for in IP interface, click on the hyperlinked name of the interface to see the configuration menu for that interface.

OSPF Interface Settings					
Name	IP Address	Area ID	Auth. Type	State	Metric
System	10.53.13.126	0.0.0.0	None	Disabled	1

Figure 6- 114. OSPF Interface Settings window

OSPF Interface Settings - Edit	
Interface Name	System
IP Address	10.53.13.126(Link Up)
Network Medium Type	BROADCAST
Area ID	0000
Router Priority(0-255)	1
Hello Interval(1-65535)	10
Dead Interval(1-65535)	40
State	Disabled
Auth. Type	None
Auth. Key ID	
Metric(1-65535)	1
DR State	DOWN
DR Address	0.0.0.0
Backup DR Address	0.0.0.0
transmit Delay	1
Retransmit Time	5
Apply	
Show All OSPF Interface Entries	

Figure 6- 115. OSPF Interface Settings – Edit window

Configure each IP interface individually using the **OSPF Interface Settings – Edit** menu. Click the **Apply** button when you have entered the settings. The new configuration appears listed in the **OSPF Interface Settings** table. To return to the **OSPF Interface Settings** table, click the [Show All OSPF Interface Entries](#) link.

OSPF interface settings are described below. Some OSPF interface settings require previously configured OSPF settings. Read the descriptions below for details.

Parameter	Description
Interface Name	Displays the of an IP interface previously configured on the Switch.
Area ID	Allows the entry of an OSPF Area ID configured above.
Router Priority (0-255)	Allows the entry of a number between 0 and 255 representing the OSPF priority of the selected area. If a Router Priority of 0 is selected, the Switch cannot be elected as the Designated Router for the network.
Hello Interval (1-65535)	Allows the specification of the interval between the transmission of OSPF Hello packets, in seconds. Between 1 and 65535 seconds can be specified. The Hello Interval, Dead Interval, Authorization Type, and Authorization Key should be the same for all routers on the same network.
Dead Interval (1-65535)	Allows the specification of the length of time between the receipt of Hello packets from a neighbor router before the selected area declares that router down. An interval between 1 and 65535 seconds can be specified. The Dead Interval must be evenly divisible by the Hello Interval.
State	Allows the OSPF interface to be disabled for the selected area without changing the configuration for that area.
Auth Type	This field can be toggled between None, Simple, and MD5 using the space bar. This allows a choice of authorization schemes for OSPF packets that may be exchanged over the OSPF routing domain. None specifies no authorization. Simple uses a simple password to determine if the packets are from an authorized OSPF router. When Simple is selected, the Auth Key field allows the entry of a 8 character password that must be the same as a password configured on a neighbor OSPF router. MD5 uses a cryptographic key entered in the MD5 Key Table Configuration menu. When MD5 is selected, the Auth Key ID field allows the specification of the Key ID as defined in the MD5 configuration above. This must be the same MD5 Key as used by the neighboring router.
Auth. Key ID	Enter a Key ID of up to 5 characters to set the Auth. Key ID for either the Simple Auth Type or the MD5 Auth Type, as specified in the previous parameter.
Metric (1-65535)	This field allows the entry of a number between 1 and 65,535 that is representative of the OSPF cost of reaching the selected OSPF interface. The default metric is 1.
DR State	A read only field describing the Designated Router state of the IP interface. This field may read DR if the interface is the designated router, or Backup DR if the interface is the Backup Designated Router. The highest IP address will be the Designated Router and is determined by the OSPF Hello Protocol of the Switch.
DR Address	The IP address of the aforementioned Designated Router.
Backup DR Address	The IP address of the aforementioned Backup Designated Router.
Transmit Delay	A read only field that denotes the estimated time to transmit a Link State Update Packet over this interface, in seconds.
Retransmit Time	A read only field that denotes the time between LSA retransmissions over this interface, in seconds.

OSPF Virtual Interface Settings

Click the **OSPF Virtual Interface Settings** link to view the current **OSPF Virtual Interface Settings**. There are not virtual interface settings configured by default, so the first time this table is viewed there will be not interfaces listed. To add a new OSPF virtual interface configuration set to the table, click the **Add** button. A new menu appears (see below). To change an existing configuration, click on the hyperlinked Transit Area ID for the set you want to change. The menu to modify an existing set is the same as the menu used to add a new one. To eliminate an existing configuration, click the **X** in the Delete column.

Transit Area ID	Neighbor Router ID	Hello Interval	Dead Interval	Auth. Type	Transmit Delay	RetransInterval	Status	Delete
OSPF Virtual Interface Settings								

Figure 6- 116. OSPF Virtual Interface Settings window

The status of the virtual interface appears (Up or Down) in the **Status** column.

OSPF Virtual Link Setting - Add

Transit Area ID	0.0.0.0
Neighbor Router ID	0.0.0.0
Hello Interval(1-65535)	10
Dead Interval(1-65535)	60
Auth Type	None
Password/Auth. Key ID	
Transmit Delay	1
RetransInterval	5

[Show All OSPF Virtual Link Entries](#)

Figure 6- 117. OSPF Virtual Link Setting – Add

Configure the following parameters if you are adding or changing an **OSPF Virtual Interface**:

Parameter	Description
Transit Area ID	Allows the entry of an OSPF Area ID – previously defined on the Switch – that allows a remote area to communicate with the backbone (area 0). A Transit Area cannot be a Stub Area or a Backbone Area.
Neighbor Router	The OSPF router ID for the remote router. This is a 32-bit number in the form of an IP address (xxx.xxx.xxx.xxx) that uniquely identifies the remote area's Area Border Router.
Hello Interval (1-65535)	Specify the interval between the transmission of OSPF Hello packets, in seconds. Enter a value between 1 and 65535 seconds. The Hello Interval, Dead Interval, Authorization Type, and Authorization Key should have identical settings for all routers on the same network.
Dead Interval (1-65535)	Specify the length of time between (receiving) Hello packets from a neighbor router before the selected area declares that router down. Again, all routers on the network should use the same setting.
Auth Type	If using authorization for OSPF routers, select the type being used. MD5 key authorization must be set up in the MD5 Key Settings menu.
Password/Auth. Key ID	Enter a case-sensitive password for simple authorization or enter the MD5 key you set in the MD5 Key settings menu.
Transmit Delay	The number of seconds required to transmit a link state update over this virtual link. Transit delay takes into account transmission and propagation delays. This field is fixed at 1 second.
RetransInterval	The number of seconds between link state advertisement retransmissions for adjacencies belonging to this virtual link. This field is fixed at 5 seconds.

Click **Apply** to implement changes made.

 **Note:** For OSPF to function properly some settings should be identical on all participating OSPF devices. These settings include the Hello Interval and Dead Interval. For networks using authorization for OSPF devices, the Authorization Type and Password or Key used must likewise be identical.

OSPF Area Aggregation Settings

Area Aggregation allows all of the routing information that may be contained within an area to be aggregated into a summary LSDB advertisement of just the network address and subnet mask. This allows for a reduction in the volume of LSDB advertisement traffic as well as a reduction in the memory overhead in the Switch used to maintain routing tables.

Click the **OSPF Area Aggregation Settings** link to view the current settings. There are no aggregation settings configured by default, so there will not be any listed the first accessing the menu. To add a new **OSPF Area Aggregation** setting, click the **Add** button. A new menu (pictured below) appears. To change an existing configuration, click on the hyperlinked Area ID for the set you want to change. The menu to modify an existing configuration is the same as the menu used to add a new one. To eliminate an existing configuration, click the **X** in the Delete column for the configuration being removed.

OSPF Area Aggregation Settings					
Area ID	Network Number	Network Mask	LSDB Type	Advertisement	Delete

Figure 6- 118. OSPF Area Aggregation Settings window

Use the menu below to change settings or add a new **OSPF Area Aggregation** setting.

OSPF Aggregation Configuration - Add	
Area ID	0.0.0.0
Network Number	0.0.0.0
Network Mask	0.0.0.0
LSDB Type	Summary
Advertisement	Enabled
Apply	
Show All OSPF Aggregation Entries	

Figure 6- 119. OSPF Aggregation Configuration – Add window

Specify the OSPF aggregation settings and click the **Apply** button to add or change the settings. The new settings will appear listed in the **OSPF Area Aggregation Settings** table. To view the table, click the [Show All OSPF Aggregation Entries](#) link to return to the previous window.

Configure the following settings for **OSPF Area Aggregation**:

Parameter	Description
Area ID	Allows the entry the OSPF Area ID for which the routing information will be aggregated. This Area ID must be previously defined on the Switch.
Network Number	Sometimes called the Network Address. The 32-bit number in the form of an IP address that uniquely identifies the network that corresponds to the OSPF Area above.
Network Mask	The corresponding network mask for the Network Number specified above.
LSDB Type	Specifies the type of address aggregation, which is set at <i>Summary</i> .
Advertisement	Select Enabled or Disabled to determine whether the selected OSPF Area will advertise its summary LSDB (Network-Number and Network-Mask).

OSPF Host Route Settings

OSPF host routes work in a way analogous to RIP, only this is used to share OSPF information with other OSPF routers. This is used to work around problems that might prevent OSPF information sharing between routers.

To configure OSPF host routes, click the **OSPF Host Route Settings** link. To add a new OSPF Route, click the **Add** button. Configure the setting in the menu that appears. The **Add** and **Modify** menus for OSPF host route setting are nearly identical. The difference being that if you are changing an existing configuration you will be unable to change the Host Address. To change an existing configuration, click on the hyperlinked Host Address in the list for the configuration you want to change and proceed to change the metric or area ID. To eliminate an existing configuration, click the **X** in the Delete column for the configuration being removed.



Figure 6- 120. OSPF Host Route Settings window

Use the menu below to set up OSPF host routes.

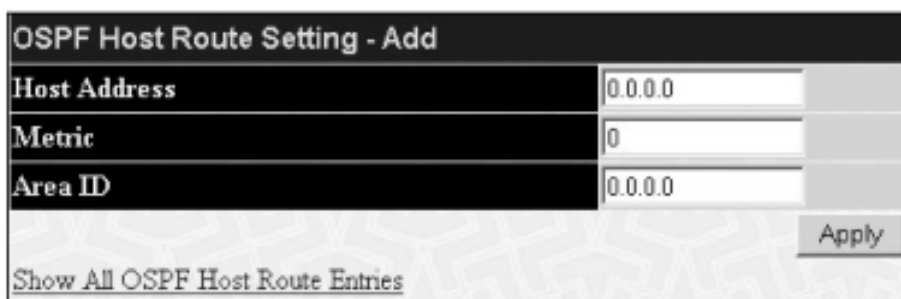

Figure 6- 121. OSPF Host Route Setting – Add window

Specify the host route settings and click the **Apply** button to add or change the settings. The new settings will appear listed in the **OSPF Host Route Settings** list. To view the previous window, click the [Show All OSPF Host Route Entries](#) link to return to the previous window.

The following fields are configured for OSPF host route:

Parameter	Description
Host Address	The IP address of the OSPF host.
Metric	A value between 1 and 65535 that will be advertised for the route.
Area ID	A 32-bit number in the form of an IP address (xxx.xxx.xxx.xxx) that uniquely identifies the OSPF area in the OSPF domain.

DHCP / BOOTP Relay

The BOOTP hops count limit allows the maximum number of hops (routers) that the BOOTP messages can be relayed through to be set. If a packet's hop count is more than the hop count limit, the packet is dropped. The range is between 1 and 16 hops, with a default value of 4. The relay time threshold sets the minimum time (in seconds) that the Switch will wait before forwarding a BOOT REQUEST packet. If the value in the seconds field of the packet is less than the relay time threshold, the packet will be dropped. The range is between 0 and 65,536 seconds, with a default value of 0 seconds.

DHCP / BOOTP Relay Information

To enable and configure BOOTP or DHCP on the Switch, click **Configuration > DHCP/BOOTP Relay > DHCP/BOOTP Global Settings**:

Figure 6- 122. DHCP/BootP Global Settings window

The following fields can be set:

Parameter	Description
BOOTP Relay Status	This field can be toggled between <i>Enabled</i> and <i>Disabled</i> using the pull-down menu. It is used to enable or disable the BOOTP/DHCP Relay service on the Switch. The default is <i>Disabled</i> .
BOOTP HOPS Count Limit (1-16)	This field allows an entry between 1 and 16 to define the maximum number of router hops BOOTP messages can be forwarded across. The default hop count is 4.
BOOTP Relay Time Threshold (0-65535)	Allows an entry between 0 and 65535 seconds, and defines the maximum time limit for routing a BOOTP/DHCP packet. If a value of 0 is entered, the Switch will not process the value in the seconds field of the BOOTP or DHCP packet. If a non-zero value is entered, the Switch will use that value, along with the hop count to determine whether to forward a given BOOTP or DHCP packet.

Click **Apply** to implement changes made.

DHCP/BootP Relay Settings

The DHCP/BootP Relay settings allow the user to set up a server, by IP address, for relaying DHCP/BootP information to the Switch. The user may enter a previously configured IP interface on the Switch that will be connected directly to the DHCP/BootP server using the following window. Properly configured settings will be displayed in the BootP Relay Table at the bottom of the following window, once the user clicks the **Add** button. The user may add up to four Server IPs per IP interface on the Switch. Entries may be deleted by clicking its corresponding **X**.

Figure 6- 123. DHCP/BootP Relay Settings and BootP Relay Table window

The following parameters may be configured or viewed.

Parameter	Description
Interface	The IP interface on the Switch that will be connected directly to the Server.
Server IP	Enter the IP address of the DHCP/BootP server. Up to four Server IPs can be configured per IP Interface.

DNS Relay

Computer users usually prefer to use text names for computers they may want to open a connection with. Computers themselves, require 32 bit IP addresses. Somewhere, a database of network devices' text names and their corresponding IP addresses must be maintained.

The Domain Name System (DNS) is used to map names to IP addresses throughout the Internet and has been adapted for use within intranets.

For two DNS servers to communicate across different subnets, the **DNS Relay** of the Switch must be used. The DNS servers are identified by IP addresses.

Mapping Domain Names to Addresses

Name-to-address translation is performed by a program called a Name server. The client program is called a Name resolver. A Name resolver may need to contact several Name servers to translate a name to an address.

The Domain Name System (DNS) servers are organized in a somewhat hierarchical fashion. A single server often holds names for a single network, which is connected to a root DNS server – usually maintained by an ISP.

Domain Name Resolution

The domain name system can be used by contacting the name servers one at a time, or by asking the domain name system to do the complete name translation. The client makes a query containing the name, the type of answer required, and a code specifying whether the domain name system should do the entire name translation, or simply return the address of the next DNS server if the server receiving the query cannot resolve the name.

When a DNS server receives a query, it checks to see if the name is in its sub domain. If it is, the server translates the name and appends the answer to the query, and sends it back to the client. If the DNS server cannot translate the name, it determines what type of name resolution the client requested. A complete translation is called recursive resolution and requires the server to contact other DNS servers until the name is resolved. Iterative resolution specifies that if the DNS server cannot supply an answer, it returns the address of the next DNS server the client should contact.

Each client must be able to contact at least one DNS server, and each DNS server must be able to contact at least one root server.

The address of the machine that supplies domain name service is often supplied by a DHCP or BOOTP server, or can be entered manually and configured into the operating system at startup.

Configuring DNS Relay Information

To configure the DNS function on the Switch, open the **Configuration** folder and click the **DNS Relay** folder. In this folder, click the **DNS Relay Information** link to open the following window.

DNS Global Settings	
DNS Relay Status	Disabled
Primary Name Server	0.0.0.0
Secondary Name Server	0.0.0.0
DNSR Cache Status	Disabled
DNSR Static Table Status	Disabled

Apply

Figure 6- 124. DNS Global Settings window

The following fields can be set:

Parameter	Description
DNS Relay Status	This field can be toggled between <i>Disabled</i> and <i>Enabled</i> using the pull-down menu, and is used to enable or disable the DNS Relay service on the Switch.
Primary Name Server	Allows the entry of the IP address of a primary domain name server (DNS).
Secondary Name Server	Allows the entry of the IP address of a secondary domain name server (DNS).
DNSR Cache Status	This can be toggled between <i>Disabled</i> and <i>Enabled</i> . This determines if a DNS cache will be enabled on the Switch.
DNS Static Table Status	This field can be toggled using the pull-down menu between <i>Disabled</i> and <i>Enabled</i> . This determines if the static DNS table will be used or not.

DNS Relay Static Settings

To view the **DNS Relay Static Settings**, open the **DNS Relay** folder in the **Configuration** folder and click the **DNS Relay Static Settings** link, which will open the following window.

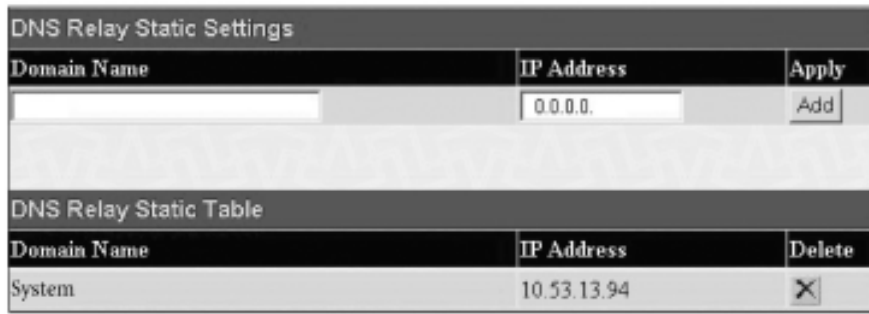

Figure 6- 125. DNS Relay Static Settings and Table window

To add an entry into the **DNS Relay Static Table**, simply enter a *Domain Name* with its corresponding IP address and click **Add**. A successful entry will be presented in the table below, as shown in the example above. To erase an entry from the table, click the corresponding **X** of the entry you wish to delete.

VRRP

VRRP or Virtual Routing Redundancy Protocol is a function on the Switch that dynamically assigns responsibility for a virtual router to one of the VRRP routers on a LAN. The VRRP router that controls the IP address associated with a virtual router is called the Master, and will forward packets sent to this IP address. This will allow any Virtual Router IP address on the LAN to be used as the default first hop router by end hosts. Utilizing VRRP, the administrator can achieve a higher available default path cost without needing to configure every end host for dynamic routing or routing discovery protocols.

Statically configured default routes on the LAN are prone to a single point of failure. VRRP is designed to eliminate these failures by setting an election protocol that will assign a responsibility for a virtual router to one of the VRRP routers on the LAN. When a virtual router fails, the election protocol will select a virtual router with the highest priority to be the Master router on the LAN. This retains the link and the connection is kept alive, regardless of the point of failure.

To configure VRRP for virtual routers on the Switch, an IP interface must be present on the system and it must be a part of a VLAN. VRRP IP interfaces may be assigned to every VLAN, and therefore IP interface, on the Switch. VRRP routers within the same VRRP group must be consistent in configuration settings for this protocol to function optimally.

VRRP Configuration

To enable VRRP globally on the Switch, click **Configuration > Layer 3 IP Networking > VRRP > VRRP Global Settings**:

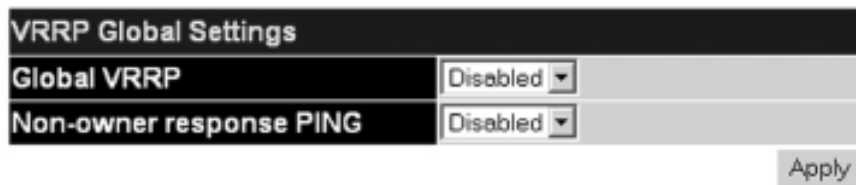

Figure 6- 126. VRRP Global Settings window

The following fields can be set:

Parameter	Description
Global VRRP	Use the pull-down menu to enable or disable VRRP globally on the Switch. The default is <i>Disabled</i> .
Non-owner response PING	Enabling this parameter will allow the virtual IP address to be pinged from other host end nodes to verify connectivity. This will only enable the ping connectivity check function. This command is Disabled by default.

Click **Apply** to implement changes made.

VRRP Interface Settings

The following window will allow the user to view the parameters for the VRRP function on the Switch. To view this window, click **Configuration > Layer 3 IP Networking > VRRP > VRRP Configuration**:



Figure 6- 127.VRRP Configuration window

The following fields are displayed in the window above:

Parameter	Description
Interface Name	An IP interface name that has been enabled for VRRP. This entry must have been previously set in the IP Interfaces table.
Authentication type	Displays the type of authentication used to compare VRRP packets received by a virtual router. Possible authentication types include <i>No authentication</i> – No authentication has been selected to compare VRRP packets received by a virtual router. <i>Simple Text Password</i> – A Simple password has been selected to compare VRRP packets received by a virtual router, for authentication. <i>IP Authentication Header</i> – An MD5 message digest algorithm has been selected to compare VRRP packets received by a virtual router, for authentication.
VRID	Displays the virtual router ID set by the user. This will uniquely identify the VRRP Interface on the network.
Display	Click the View button to display the settings for this particular VRRP entry.
Delete	Click the X to delete this VRRP entry.

Click the **Add** button to display the following window to configure a VRRP interface.

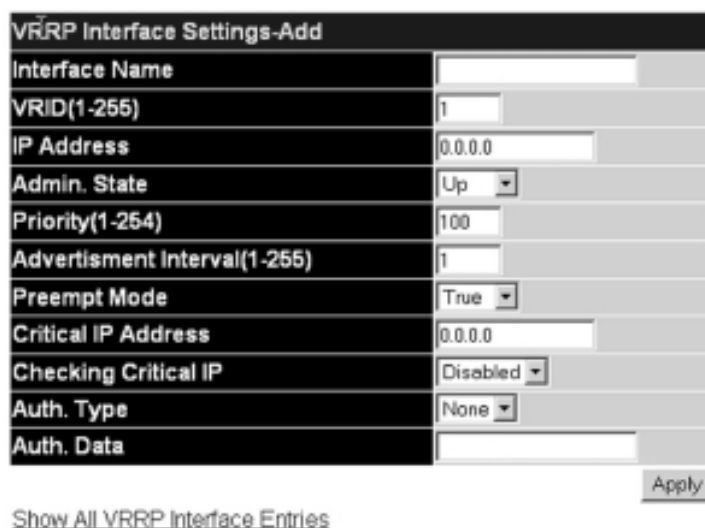

Figure 6- 128.VRRP Interface Settings – Add window

Or, the user may click the hyperlinked **Interface Name** to view the same window:

The following parameters may be set to configure an existing or new VRRP interface.

Parameter	Description
Interface Name	Enter the name of a previously configured IP interface to create a VRRP entry for. This IP interface must be assigned to a VLAN on the Switch.
VRID (1-255)	Enter a value between 1 and 255 to uniquely identify this VRRP group on the Switch. All routers participating in this group must be assigned the same VRID value. This value MUST be different from other VRRP groups set on the Switch.
IP Address	Enter the IP address that will be assigned to the VRRP router. This IP address is also the default gateway that will be statically assigned to end hosts and must be set for all routers that participate in this group.
Admin. State	Used to enable (Up) and disable (Down) the VRRP IP interface on the Switch.
Priority (1-254)	Enter a value between 1 and 254 to indicate the router priority. The VRRP Priority value may determine if a higher priority VRRP router overrides a lower priority VRRP router. A higher priority will increase the probability that this router will become the Master router of the group. A lower priority will increase the probability that this router will become the backup router. VRRP routers that are assigned the same priority value will elect the highest physical IP address as the Master router. The default value is 100. (The value of 255 is reserved for the router that owns the IP address associated with the virtual router and is therefore set automatically.)
Advertisement Interval (1-255)	Enter a time interval value, in seconds, for sending VRRP message packets. This value must be consistent with all participating routers. The default is 1 second.
Preempt Mode	This entry will determine the behavior of backup routers within the VRRP group by controlling whether a higher priority backup router will preempt a lower priority Master router. A <i>True</i> entry, along with having the backup router's priority set higher than the master's priority, will set the backup router as the Master router. A <i>False</i> entry will disable the backup router from becoming the Master router. This setting must be consistent with all routers participating within the same VRRP group. The default setting is <i>True</i> .
Critical IP Address	Enter the IP address of the physical device that will provide the most direct route to the Internet or other critical network connections from this virtual router. This must be a real IP address of a real device on the network. If the connection from the virtual router to this IP address fails, the virtual router will automatically be disabled. A new Master will be elected from the backup routers participating in the VRRP group. Different critical IP addresses may be assigned to different routers participating in the VRRP group, and can therefore define multiple routes to the Internet or other critical network connections.
Checking Critical IP	Use the pull-down menu to enable or disable the Critical IP address entered above.
Auth. Type	Specifies the type of authentication used. The Auth. Type must be consistent with all routers participating within the VRRP group. The choices are: <i>None</i> – Selecting this parameter indicates that VRRP protocol exchanges will not be authenticated. <i>Simple</i> – Selecting this parameter will require the user to set a simple password in the Auth. Data field for comparing VRRP message packets received by a router. If the two passwords are not exactly the same, the packet will be dropped. <i>IP</i> – Selecting this parameter will require the user to set a MD5 message digest for authentication in comparing VRRP messages received by the router. If the two values are inconsistent, the packet will be dropped.
Auth. Data	This field is only valid if the user selects Simple or IP in the Auth. Type field. Simple will require the user to enter an alphanumeric string of no more than 8 characters to identify VRRP packets received by a router. IP will require the user to enter a MD5 message digest for authentication in comparing VRRP messages received by the router. This entry must be consistent with all routers participating in the same IP interface.

Click **Apply** to implement changes made.

To view the settings for a particular VRRP setting, click the corresponding **View** in the **VRRP Interface Table** of the entry, which will display the following:

VRRP Interface Entry Display	
Interface Name	Darren
Authentication type	No Authentication
VRID	2
Virtual IP Address	11.1.1.1
Virtual MAC Address	00:00:5e:00:01:02
Virtual Router State	Initialize
Admin. State	Up
Priority	255
Master IP Address	11.1.1.1
Critical IP Address	10.53.13.126
Checking Critical IP	Disabled
Advertisement Interval	1
Preempt Mode	True
Virtual Router Up Time	0
Show All VRRP Interface Entries	

Figure 6- 129.VRRP Interface Entry Display window

This window displays the following information:

Parameter	Description
Interface Name	An IP interface name that has been enabled for VRRP.This entry must have been previously set in the IP Interface Settings table.
Authentication type	Displays the type of authentication used to compare VRRP packets received by a virtual router. Possible authentication types include: <i>No authentication</i> – No authentication has been selected to compare VRRP packets received by a virtual router. <i>Simple Text Password</i> –A Simple password has been selected to compare VRRP packets received by a virtual router, for authentication. <i>IP Authentication Header</i> – An MD5 message digest algorithm has been selected to compare VRRP packets received by a virtual router, for authentication.
VRID	Displays the virtual router ID set by the user.This will uniquely identify the VRRP Interface on the network Interface on the network.
Virtual IP Address	The IP address of the Virtual router configured on the Switch.
Virtual MAC Address	The MAC address of the device that holds the Virtual router.
Virtual Router State	Displays the current status of the virtual router. Possible states include <i>Initialize</i> , <i>Master</i> and <i>Backup</i> .
Admin. State	Displays the current state of the router. <i>Up</i> will be displayed if the virtual router is enabled and <i>Down</i> if the virtual router is disabled.
Priority	Displays the priority of the virtual router.A higher priority will increase the probability that this router will become the Master router of the group.A lower priority will increase the probability that this router will become the backup router.The lower the number, the higher the priority.
Master IP Address	Displays the IP address of the Master router for the VRRP function.
Critical IP Address	Displays the critical IP address of the VRRP function.This address will judge if a virtual router is qualified to be a master router.
Checking Critical IP	Displays the status of the Critical IP address. May be enabled or disabled.
Advertisement Interval	Displays the time interval, in seconds that VRRP messages are sent out to the network.
Preempt Mode	Displays the mode for determining the behavior of backup routers set on this VRRP interface. <i>True</i> will denote that this will be the backup router, if the routers priority is set higher than the master router. <i>False</i> will disable the backup router from becoming the master router.
Virtual Router Up Time	Displays the time, in minutes, since the virtual router has been initialized.

IP Multicast Routing Protocol

The functions supporting IP multicasting are added under the **IP Multicast Routing Protocol** folder, from the **Layer 3 IP Networking** folder.

IGMP Snooping, **DVMRP**, and **PIM-DM** can be enabled or disabled on the Switch without changing the individual protocol's configuration.

IGMP Interface Configuration

The Internet Group Multicasting Protocol (IGMP) can be configured on the Switch on a per-IP interface basis. To view the **IGMP Interface Table**, open the **IP Multicast Routing Protocol** folder under **Configuration** and click **IGMP Interface Settings**. Each IP interface configured on the Switch is displayed in the below **IGMP Interface Table** dialog box. To configure IGMP for a particular interface, click the corresponding hyperlink for that IP interface. This will open another **IGMP Interface Configuration** window:

Interface Name	IP Address	Version	Query Interval	Max Response Time	Robustness Value	Last Member Query Interval	State
System	10.53.13.126	2	125	10	2	1	Disabled
Darren	11.1.1.1	2	125	10	2	1	Disabled

Figure 6- 130. IGMP Interface Table

IGMP Interface Configuration	
Interface Name	Darren
IP Address	11.1.1.1
Version	2
Query Interval(1-65535)	125
Max Response Time(1-25)	10
Robustness Variable(1-255)	2
Last Member Query Interval(1-25)	1
State	Disabled

[Show All IGMP Interface Entries](#)

Figure 6- 131. IGMP Interface Configuration window

This window allows the configuration of IGMP for each IP interface configured on the Switch. IGMP can be configured as Version 1 or 2 by toggling the **Version** field using the pull-down menu. The length of time between queries can be varied by entering a value between 1 and 65,535 seconds in the **Query Interval** field. The maximum length of time between the receipt of a query and the sending of an IGMP response report can be varied by entering a value in the **Max Response Time** field.

The **Robustness Variable** field allows IGMP to be 'tuned' for sub-networks that are expected to lose a lot of packets. A high value (max. 255) for the robustness variable will help compensate for 'lossy' sub-networks. A low value (min. 2) should be used for less 'lossy' sub-networks.

The following fields can be set:

Parameter	Description
Interface Name	Displays the name of the IP interface that is to be configured for IGMP. This must be a previously configured IP interface.
IP Address	Displays the IP address corresponding to the IP interface name above.
Version	Enter the IGMP version (1 or 2) that will be used to interpret IGMP queries on the interface.
Query Interval	Allows the entry of a value between 1 and 65535 seconds, with a default of 125 seconds. This specifies the length of time between sending IGMP queries.
Max Response Time	Sets the maximum amount of time allowed before sending an IGMP response report. A value between 1 and 25 seconds can be entered, with a default of 10 seconds.
Robustness Variable	A tuning variable to allow for subnetworks that are expected to lose a large number of packets. A value between 2 and 255 can be entered, with larger values being specified for subnetworks that are expected to lose larger numbers of packets.
Last Member Query Interval	Specifies the maximum amount of time between group-specific query messages, including those sent in response to leave group messages. A value between 1 and 25. The default is 1 second.
State	This field can be toggled between Enabled and Disabled and enables or disables IGMP for the IP interface. The default is Disabled.

DVMRP Interface Configuration

The Distance Vector Multicast Routing Protocol (**DVMRP**) is a hop-based method of building multicast delivery trees from multicast sources to all nodes of a network. Because the delivery trees are 'pruned' and 'shortest path', DVMRP is relatively efficient. Because multicast group membership information is forwarded by a distance-vector algorithm, propagation is slow. DVMRP is optimized for high delay (high latency) relatively low bandwidth networks, and can be considered as a 'best-effort' multicasting protocol.

DVMRP resembles the Routing Information Protocol (RIP), but is extended for multicast delivery. DVMRP builds a routing table to calculate 'shortest paths' back to the source of a multicast message, but defines a 'route cost' (similar to the hop count in RIP) as a relative number that represents the real cost of using this route in the construction of a multicast delivery tree to be 'pruned' – once the delivery tree has been established.

When a sender initiates a multicast, DVMRP initially assumes that all users on the network will want to receive the multicast message. When an adjacent router receives the message, it checks its unicast routing table to determine the interface that gives the shortest path (lowest cost) back to the source. If the multicast was received over the shortest path, then the adjacent router enters the information into its tables and forwards the message. If the message is not received on the shortest path back to the source, the message is dropped.

Route cost is a relative number that is used by DVMRP to calculate which branches of a multicast delivery tree should be 'pruned'. The 'cost' is relative to other costs assigned to other DVMRP routes throughout the network.

The higher the route cost, the lower the probability that the current route will be chosen to be an active branch of the multicast delivery tree (not 'pruned') – if there is an alternative route.

DVMRP Global Setting

To enable DVMRP globally on the Switch, open the **IP Multicast Routing Protocol** folder in the Configuration folder, and click the **DVMRP Configuration** link. This will give the user access to the following screen:



Figure 6- 132. DVMRP Global Settings window

Use the pull down menu, choose Enabled, and click Apply to implement the DVMRP function on the Switch.

DVMRP Interface Settings

To view the **DVMRP Interface Table**, open the **IP Multicasting** folder under **Configuration** and click **DVMRP Interface Settings**. This menu allows the **Distance-Vector Multicast Routing Protocol (DVMRP)** to be configured for each IP interface defined on the Switch. Each IP interface configured on the Switch is displayed in the below **DVMRP Interface Configuration** dialog box. To configure DVMRP for a particular interface, click the corresponding hyperlink for that IP interface. This will open the **DVMRP Interface Configuration** window:

DVMRP Interface Settings					
Interface Name	IP Address	Neighbor Timeout	Probe	Metric	State
System	10.90.90.90	35	10	1	Disabled

Figure 6- 133. DVMRP Interface Settings window

DVMRP Interface Settings	
Interface Name	System
IP Address	10.90.90.90
Neighbor Timeout Interval(1-65535 sec)	35
Probe Interval(1-65535 sec)	10
Metric(1-31)	1
State	Disabled

[Show All DVMRP Interface Entries](#)

Figure 6- 134. DVMRP Interface Settings – Edit window

The following fields can be set:

Parameter	Description
Interface Name	Displays the name of the IP interface for which DVMRP is to be configured. This must be a previously defined IP interface.
IP Address	Displays the IP address corresponding to the IP Interface name entered above.
Neighbor Timeout Interval (1-65535)	This field allows an entry between 1 and 65,535 seconds and defines the time period for DVMRP will hold Neighbor Router reports before issuing poison route messages. The default is 35 seconds.
Probe Interval (1-65535)	This field allows an entry between 1 and 65,535 seconds and defines the interval between 'probes'. The default is 10.
Metric (1-31)	This field allows an entry between 1 and 31 and defines the route cost for the IP interface. The DVMRP route cost is a relative number that represents the real cost of using this route in the construction of a multicast delivery tree. It is similar to, but not defined as, the hop count in RIP. The default cost is 1.
State	This field can be toggled between Enabled and Disabled and enables or disables DVMRP for the IP interface. The default is Disabled.

PIM-DM Interface Configuration

The *Protocol Independent Multicast – Dense Mode* (PIM-DM) protocol should be used in networks with a low delay (low latency) and high bandwidth as PIM-DM is optimized to guarantee delivery of multicast packets, not to reduce overhead.

The PIM-DM multicast routing protocol assumes that all downstream routers want to receive multicast messages and relies upon explicit prune messages from downstream routers to remove branches from the multicast delivery tree that do not contain multicast group members.

PIM-DM has no explicit 'join' messages. It relies upon periodic flooding of multicast messages to all interfaces and then either waiting for a timer to expire (the **Join/Prune Interval**) or for the downstream routers to transmit explicit 'prune' messages indicating that there are no multicast members on their respective branches. PIM-DM then removes these branches ('prunes' them) from the multicast delivery tree.

Because a member of a pruned branch of a multicast delivery tree may want to join a multicast delivery group (at some point in the future), the protocol periodically removes the 'prune' information from its database and floods multicast messages to all interfaces on that branch. The interval for removing 'prune' information is the **Join/Prune Interval**.

PIM-DM Configuration

To enable PIM-DM globally on the Switch, go to **Configuration > IP Multicast Routing Protocol > PIM > PIM-DM Configuration**. This will give the user access to the following screen:



Figure 6- 135. PIM DM Global Settings window

Use the pull down menu, choose *Enabled*, and click **Apply** to set the PIM-DM function on the Switch.

To view the **PIM-DM Table**, open the **IP Multicasting** folder under **Configuration** and click **PIM-DM Interface Configuration**. This window allows the **PIM-DM** to be configured for each IP interface defined on the Switch. Each IP interface configured on the Switch is displayed in the below **PIM-DM Interface Table** dialog box. To configure PIM-DM for a particular interface, click the corresponding hyperlink for that IP interface. This will open the **PIM-DM Interface Configuration** window:

PIM-DM Interface Settings				
Interface Name	IP Address	Hello Interval	Join/Prune Interval	State
System	10.90.90.90	30	60	Disabled

Figure 6- 136. PIM-DM Interface Settings window

PIM-DM Interface Settings	
Interface Name	System
IP Address	10.90.90.90
Hello Interval(1-18724 sec)	<input type="text" value="30"/>
Join-Prune Interval(1-18724 sec)	<input type="text" value="60"/>
State	Disabled <input type="button" value="v"/>

[Show All PIM-DM Interface Entries](#)

Figure 6- 137. PIM-DM Interface Settings window – Modify

The following fields can be set:

Parameter	Description
Interface Name	Allows the entry of the name of the IP interface for which PIM-DM is to be configured. This must be a previously defined IP interface.
IP Address	Displays the IP address for the IP interface named above.
Hello Interval (1-18724)	This field allows an entry of between 1 and 18724 seconds and determines the interval between sending Hello packets to other routers on the network. The default is 30 seconds.
Join/Prune Interval (1-18724)	This field allows an entry of between 1 and 18724 seconds. This interval also determines the time interval the router uses to automatically remove prune information from a branch of a multicast delivery tree and begin to flood multicast messages to all branches of that delivery tree. These two actions are equivalent. The default is 60 seconds.
State	This field can be toggled between Enabled and Disabled using the pull-down menu, and is used to enable or disable PIM-DM for the IP interface. The default is Disabled.

Click **Apply** to implement changes made. Click [Show All PIM-DM Interface Entries](#) to return to the **PIM-DM Interface Table**.

Chapter 7 - Security Management

- 7-1 Security IP
- 7-2 User Accounts
- 7-3 Access Authentication Control (TACACS)
- 7-4 Secure Sockets Layer (SSL)
- 7-5 Secure Shell (SSH)

The following section will aid the user in configuring security functions for the Switch. The Switch includes various functions for security, including *TACACS*, *Security IPs*, *SSL*, and *SSH*, all discussed in detail in the following section.

7-1 Security IP

Go to the **Security Management** folder and click on the **Security IP** link; the following screen will appear.

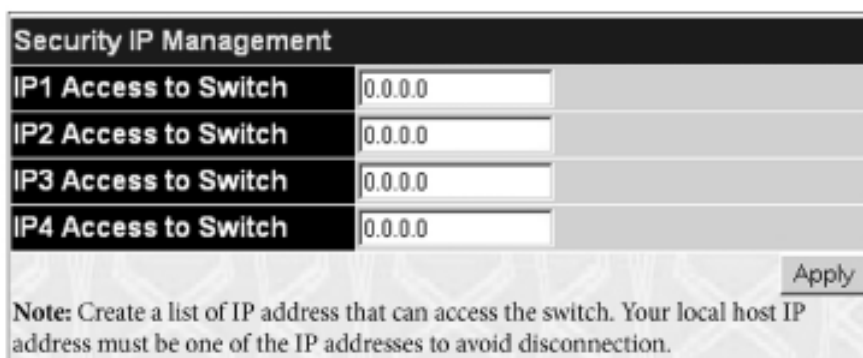

Security IP Management	
IP1 Access to Switch	<input type="text" value="0.0.0.0"/>
IP2 Access to Switch	<input type="text" value="0.0.0.0"/>
IP3 Access to Switch	<input type="text" value="0.0.0.0"/>
IP4 Access to Switch	<input type="text" value="0.0.0.0"/>

Note: Create a list of IP address that can access the switch. Your local host IP address must be one of the IP addresses to avoid disconnection.

Figure 7- 1. Security IP Management window

Use the **Security IP Management** window to permit remote stations to manage the Switch. If you choose to define one or more designated management stations, only the chosen stations, as defined by IP address, will be allowed management privilege through the web manager or Telnet session. To define a management station IP setting, type in the IP address and click the **Apply** button.

7-2 User Accounts

Use the **User Accounts Management** window to control user privileges. To view existing User Accounts, open the **Security Management** folder and click on the **User Accounts** link. This will open the **User Account Management** page, as shown below.



User Name	Access Right	
Trinity	Admin	<input type="button" value="Add"/> <input type="button" value="Modify"/>

Figure 7- 2. User Account Management Table

To add a new user, click on the **Add** button. To modify or delete an existing user, click on the **Modify** button for that user.

Figure 7- 3. User Accounts Modify Table – Add

Add a new user by typing in a **User Name**, and **New Password** and retype the same password in the **Confirm New Password**. Choose the level of privilege (*Admin* or *User*) from the **Access Right** drop-down menu.

Figure 7- 4. User Account Modify Table – Modify

Modify or delete an existing user account in the **User Account Modify Table**. To delete the user account, click on the **Delete** button. To change the password, type in the **New Password** and retype it in the **Confirm New Password** entry field. The level of privilege (*Admin* or *User*) can be viewed in the **Access Right** field.

Admin and User Privileges

There are two levels of user privileges, **Admin** and **User**. Some menu selections available to users with **Admin** privileges may not be available to those with **User** privileges.

The following table summarizes the Admin and User privileges:

Management	Admin	User
Configuration	Yes	Read Only
Network Monitoring	Yes	Read Only
Community Strings and Trap Stations	Yes	Read Only
Update Firmware and Configuration Files	Yes	No
System Utilities	Yes	No
Factory Reset	Yes	No
User Account Management		
Add/Update/Delete User Accounts	Yes	No
View User Accounts	Yes	No

Table 7- 1. Admin and User Privileges

After establishing a User Account with Admin-level privileges, be sure to save the changes by opening the Maintenance folder, opening the Save Changes window and clicking the Save Configuration button.

7-3 Access Authentication Control

The TACACS / XTACACS / TACACS+ / RADIUS commands let you secure access to the Switch using the TACACS / XTACACS / TACACS+ / RADIUS protocols. When a user logs in to the Switch or tries to access the administrator level privilege, he or she is prompted for a password. If TACACS / XTACACS / TACACS+ / RADIUS authentication is enabled on the Switch, it will contact a TACACS / XTACACS / TACACS+ / RADIUS server to verify the user. If the user is verified, he or she is granted access to the Switch.

There are currently three versions of the TACACS security protocol, each a separate entity. The Switch's software supports the following versions of TACACS:

- **TACACS** (Terminal Access Controller Access Control System) – Provides password checking and authentication, and notification of user actions for security purposes utilizing via one or more centralized TACACS servers, utilizing the UDP protocol for packet transmission.
- **Extended TACACS (XTACACS)** – An extension of the TACACS protocol with the ability to provide more types of authentication requests and more types of response codes than TACACS. This protocol also uses UDP to transmit packets.
- **TACACS+ (Terminal Access Controller Access Control System plus)** – Provides detailed access control for authentication for network devices. TACACS+ is facilitated through Authentication commands via one or more centralized servers. The TACACS+ protocol encrypts all traffic between the Switch and the TACACS+ daemon, using the TCP protocol to ensure reliable delivery.

In order for the TACACS / XTACACS / TACACS+ / RADIUS security function to work properly, a TACACS / XTACACS / TACACS+ / RADIUS server must be configured on a device other than the Switch, called an Authentication Server Host and it must include usernames and passwords for authentication. When the user is prompted by the Switch to enter usernames and passwords for authentication, the Switch contacts the TACACS / XTACACS / TACACS+ / RADIUS server to verify, and the server will respond with one of three messages:

- The server verifies the username and password, and the user is granted normal user privileges on the Switch.
- The server will not accept the username and password and the user is denied access to the Switch.
- The server doesn't respond to the verification query. At this point, the Switch receives the timeout from the server and then moves to the next method of verification configured in the method list.

The Switch has four built-in **Authentication Server Groups**, one for each of the TACACS, XTACACS, TACACS+ and RADIUS protocols. These built-in Authentication Server Groups are used to authenticate users trying to access the Switch. The users will set **Authentication Server Hosts** in a preferable order in the built-in Authentication Server Groups and when a user tries to gain access to the Switch, the Switch will ask the first Authentication Server Hosts for authentication. If no authentication is made, the second server host in the list will be queried, and so on. The built-in Authentication Server Groups can only have hosts that are running the specified protocol. For example, the TACACS Authentication Server Groups can only have TACACS Authentication Server Hosts.

The administrator for the Switch may set up 6 different authentication techniques per user-defined method list (TACACS / XTACACS / TACACS+ / RADIUS / local / none) for authentication. These techniques will be listed in an order preferable, and defined by the user for normal user authentication on the Switch, and may contain up to eight authentication techniques. When a user attempts to access the Switch, the Switch will select the first technique listed for authentication. If the first technique goes through its Authentication Server Hosts and no authentication is returned, the Switch will then go to the next technique listed in the server group for authentication, until the authentication has been verified or denied, or the list is exhausted.

Please note that users granted access to the Switch will be granted normal user privileges on the Switch. To gain access to administrator level privileges, the user must access the **Enable Admin** window and then enter a password, which was previously configured by the administrator of the Switch.

 **Note:** TACACS, XTACACS and TACACS+ are separate entities and are not compatible. The Switch and the server must be configured exactly the same, using the same protocol. (For example, if the Switch is set up for TACACS authentication, so must be the host server.)

Policy & Parameters

This command will enable an administrator-defined authentication policy for users trying to access the Switch. When enabled, the device will check the **Login Method List** and choose a technique for user authentication upon login.

To access the following window, click **Security Management > Access Authentication Control > Policy & Parameters**:

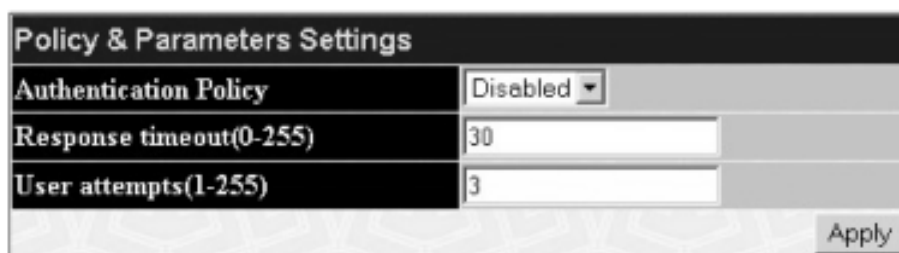

Figure 7- 5. Policy & Parameters Settings window

The following parameters can be set:

Parameter	Description
Authentication Policy	Use the pull down menu to enable or disable the Authentication Policy on the Switch.
Response Timeout (0-255)	This field will set the time the Switch will wait for a response of authentication from the user. The user may set a time between 0 and 255 seconds. The default setting is 30 seconds.
User Attempts (1-255)	This command will configure the maximum number of times the Switch will accept authentication attempts. Users failing to be authenticated after the set amount of attempts will be denied access to the Switch and will be locked out of further authentication attempts. Command line interface users will have to wait 60 seconds before another authentication attempt. TELNET and web users will be disconnected from the Switch. The user may set the number of attempts from 1 to 255. The default setting is 3.

Click **Apply** to implement changes made.

Application's Authentication Settings

This window is used to configure switch configuration applications (console, Telnet, SSH, web) for login at the user level and at the administration level (**Enable Admin**) utilizing a previously configured method list. To view the following window, click **Security Management > Access Authentication Control > Application Authentication Settings**:

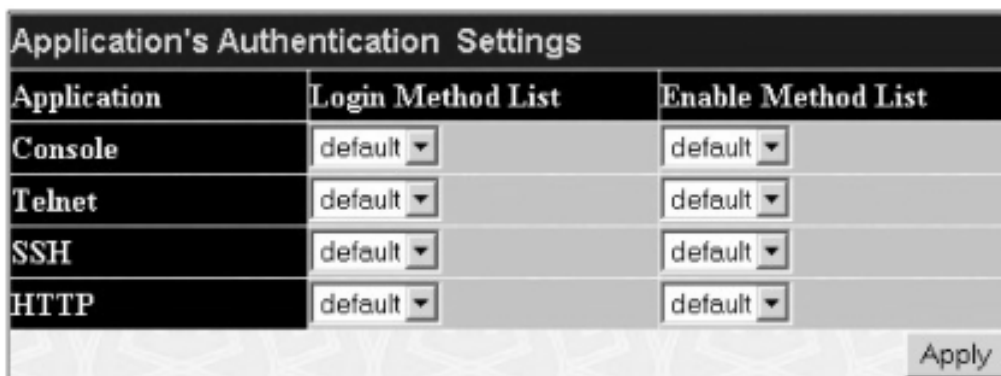

Figure 7- 6. Application's Authentication Settings window

The following parameters can be set:

Parameter	Description
Application	Lists the configuration applications on the Switch. The user may configure the Login Method List and Enable Method List for authentication for users utilizing the Console (Command Line Interface) application, the Telnet application, SSH and the WEB (HTTP) application.
Login Method List	Using the pull down menu, configure an application for normal login on the user level, utilizing a previously configured method list. The user may use the default Method List or other Method List configured by the user. See the Login Method Lists window, in this section, for more information.
Enable Method List	Using the pull down menu, configure an application for normal login on the user level, utilizing a previously configured method list. The user may use the default Method List or other Method List configured by the user. See the Enable Method Lists window, in this section, for more information.

Click **Apply** to implement changes made.

Authentication Server Group Settings

This window will allow users to set up **Authentication Server Groups** on the Switch. A server group is a technique used to group TACACS/XTACACS/TACACS+/RADIUS server hosts into user-defined categories for authentication using method lists. The user may define the type of server group by protocol or by previously defined server group. The Switch has four built-in Authentication Server Groups that cannot be removed but can be modified. Up to eight (8) authentication server hosts may be added to any particular group.

To view the following window, click **Security Management > Access Authentication Control > Authentication Server Group**:



Figure 7- 7.Authentication Server Group Settings window

This screen displays the Authentication Server Groups on the Switch. The Switch has four built-in Authentication Server Groups that cannot be removed but can be modified. To modify a particular group, click its hyperlinked **Group Name**, which will then display the following window.

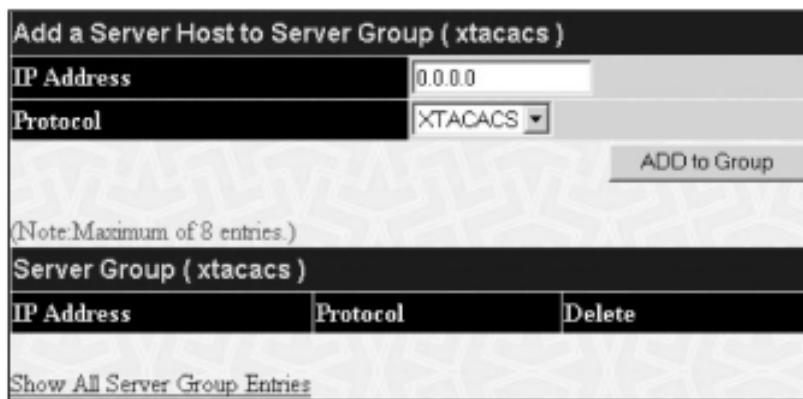

Figure 7- 8.Add a Server Host to Server Group (XTACACS) window.

To add an Authentication Server Host to the list, enter its IP address in the IP Address field, choose the protocol associated with the IP address of the Authentication Server Host and click **ADD to Group** to add this Authentication Server Host to the group.

To add a server group other than the ones listed, click the add button, revealing the following window to configure.



Figure 7- 9.Authentication Server Group Table Add Settings window

Enter a group name of up to 15 characters into the **Group Name** field and click **Apply**. The entry should appear in the **Authentication Server Group Settings** window, as shown in Figure 7-7 (trinity).

Note: The user must configure Authentication Server Hosts using the Authentication Server Hosts window before adding hosts to the list. Authentication Server Hosts must be configured for their specific protocol on a remote centralized server before this function can work properly.

Note: The built-in server groups can only have server hosts running the same TACACS or RADIUS daemon. TACACS/XTACACS/TACACS+ protocols are separate entities and are not compatible with each other.

Authentication Server Hosts

This window will set user-defined **Authentication Server Hosts** for the TACACS / XTACACS / TACACS+ / RADIUS security protocols on the Switch. When a user attempts to access the Switch with Authentication Policy enabled, the Switch will send authentication packets to a remote TACACS / XTACACS / TACACS+ / RADIUS server host on a remote host. The TACACS / XTACACS / TACACS+ / RADIUS server host will then verify or deny the request and return the appropriate message to the Switch. More than one authentication protocol can be run on the same physical server host but, remember that TACACS / XTACACS / TACACS+ / RADIUS are separate entities and are not compatible with each other. The maximum supported number of server hosts is 16.

To view the following window, click **Security Management > Access Authentication Control > Authentication Server Host**:

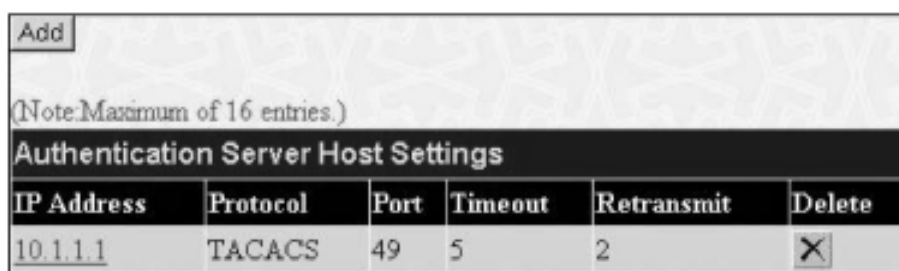

Figure 7- 10. Authentication Server Host Settings window

To add an Authentication Server Host, click the **Add** button, revealing the following window:

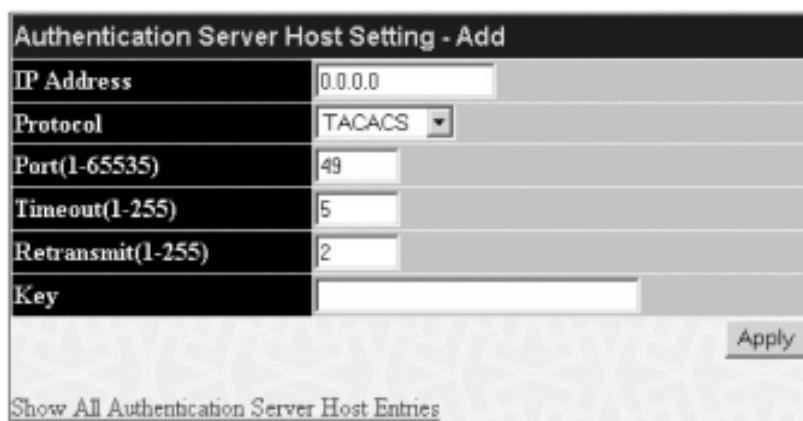



Figure 7- 11. Authentication Server Host Setting window – Add

Configure the following parameters to add an Authentication Server Host:

Parameter	Description
IP Address	The IP address of the remote server host the user wishes to add.
Protocol	The protocol used by the server host. The user may choose one of the following: TACACS – Enter this parameter if the server host utilizes the TACACS protocol. XTACACS – Enter this parameter if the server host utilizes the XTACACS protocol. TACACS+ – Enter this parameter if the server host utilizes the TACACS+ protocol. RADIUS – Enter this parameter if the server host utilizes the RADIUS protocol.
Port (1-65535)	Enter a number between 1 and 65535 to define the virtual port number of the authentication protocol on a server host. The default port number is 49 for TACACS/XTACACS/TACACS+ servers and 1813 for RADIUS servers but the user may set a unique port number for higher security.
Timeout (1-255)	Enter the time in seconds the Switch will wait for the server host to reply to an authentication request. The default value is 5 seconds.
Retransmit (1-255)	Enter the value in the retransmit field to change how many times the device will resend an authentication request when the TACACS server does not respond.
Key	Authentication key to be shared with a configured TACACS+ or RADIUS servers only. Specify an alphanumeric string up to 254 characters.

Click **Apply** to add the server host.

 **Note:** More than one authentication protocol can be run on the same physical server host but, remember that TACACS/XTACACS/TACACS+ are separate entities and are not compatible with each other.

Login Method Lists

This command will configure a user-defined or default **Login Method List** of authentication techniques for users logging on to the Switch. The sequence of techniques implemented in this command will affect the authentication result. For example, if a user enters a sequence of techniques, for example TACACS - XTACACS- local, the Switch will send an authentication request to the first TACACS host in the server group. If no response comes from the server host, the Switch will send an authentication request to the second TACACS host in the server group and so on, until the list is exhausted. At that point, the Switch will restart the same sequence with the following protocol listed, XTACACS. If no authentication takes place using the XTACACS list, the local account database set in the Switch is used to authenticate the user. When the local method is used, the privilege level will be dependant on the local account privilege configured on the Switch.

Successful login using any of these techniques will give the user a "User" privilege only. If the user wishes to upgrade his or her status to the administrator level, the user must use the **Enable Admin** window, in which the user must enter a previously configured password, set by the administrator. (See the **Enable Admin** part of this section for more detailed information concerning the **Enable Admin** command.)

To view the following screen click **Security Management > Access Authentication Control > Login Method Lists:**

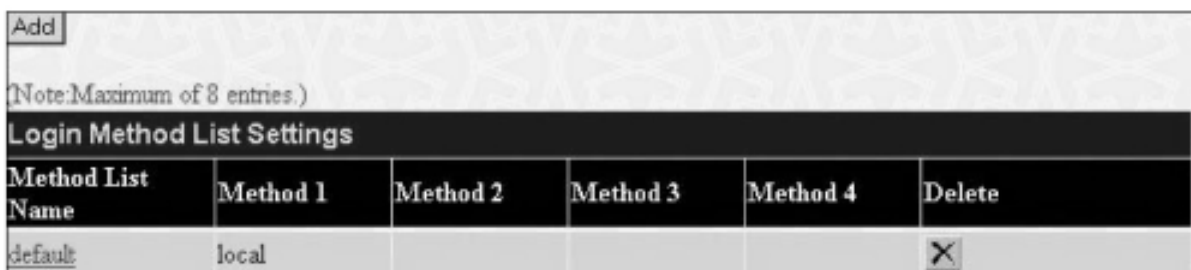

Method List Name	Method 1	Method 2	Method 3	Method 4	Delete
default	local				X

Figure 7- 12. Login Method Lists Settings window

The Switch contains one **Method List** that is set and cannot be removed, yet can be modified. To delete a **Login Method List** defined by the user, click the **X** under the **Delete** heading corresponding to the entry desired to be deleted. To modify a Login Method List, click on its hyperlinked **Method List Name**. To configure a new Method List, click the **Add** button.

Both actions will result in the same screen to configure:

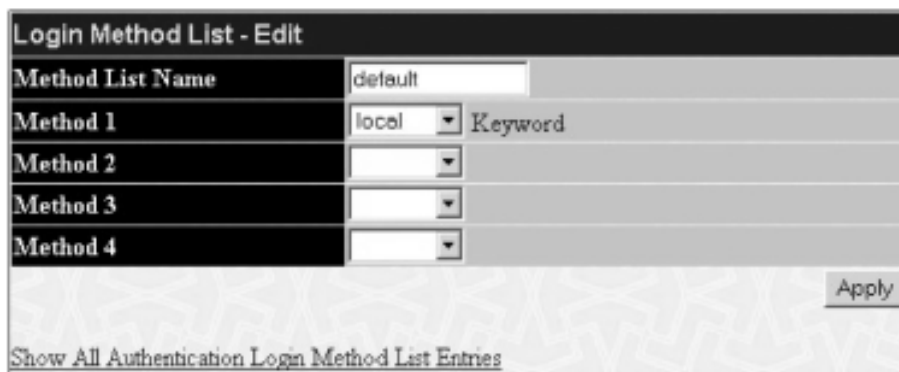

Figure 7- 13. Login Method List – Edit (default)

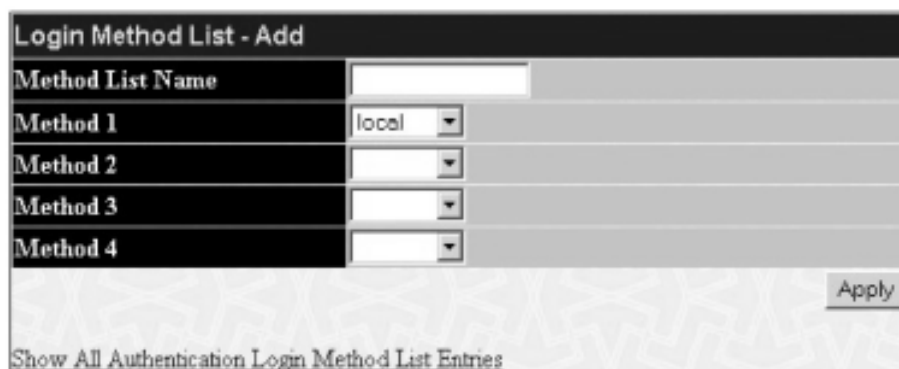

Figure 7- 14. Login Method List – Add

To define a Login Method List, set the following parameters and click **Apply**:

Parameter	Description
Method List Name	Enter a method list name defined by the user of up to 15 characters.
Method 1, 2, 3, 4	<p>The user may add one, or a combination of up to four (4) of the following authentication methods to this method list:</p> <p><i>tacacs</i> – Adding this parameter will require the user to be authenticated using the TACACS protocol from a remote TACACS server.</p> <p><i>xtacacs</i> – Adding this parameter will require the user to be authenticated using the XTACACS protocol from a remote XTACACS server.</p> <p><i>tacacs+</i> – Adding this parameter will require the user to be authenticated using the TACACS+ protocol from a remote TACACS+ server.</p> <p><i>radius</i> – Adding this parameter will require the user to be authenticated using the RADIUS protocol from a remote RADIUS server.</p> <p><i>server_group</i> – Adding this parameter will require the user to be authenticated using a user-defined server group previously configured on the Switch.</p> <p><i>local</i> – Adding this parameter will require the user to be authenticated using the local user account database on the Switch.</p> <p><i>none</i> – Adding this parameter will require no authentication to access the Switch.</p>

Enable Method Lists

The **Enable Method Lists** window is used to set up Method Lists to promote users with user level privileges to Administrator (Admin) level privileges using authentication methods on the Switch. Once a user acquires normal user level privileges on the Switch, he or she must be authenticated by a method on the Switch to gain administrator privileges on the Switch, which is defined by the Administrator. A maximum of eight (8) Enable Method Lists can be implemented on the Switch, one of which is a default Enable Method List. This default Enable Method List cannot be deleted but can be configured.

The sequence of methods implemented in this command will affect the authentication result. For example, if a user enters a sequence of methods like TACACS - XTACACS - Local Enable, the Switch will send an authentication request to the first TACACS host in the server group. If no verification is found, the Switch will send an authentication request to the second TACACS host in the server group and so on, until the list is exhausted. At that point, the Switch will restart the same sequence with the following protocol listed, XTACACS. If no authentication takes place using the XTACACS list, the Local Enable password set in the Switch is used to authenticate the user.

Successful authentication using any of these methods will give the user an "Admin" privilege.

 **Note** To set the Local Enable Password, see the next section, entitled Local Enable Password.

To view the following table, click **Security Management > Access Authentication Control > Enable Method Lists**:

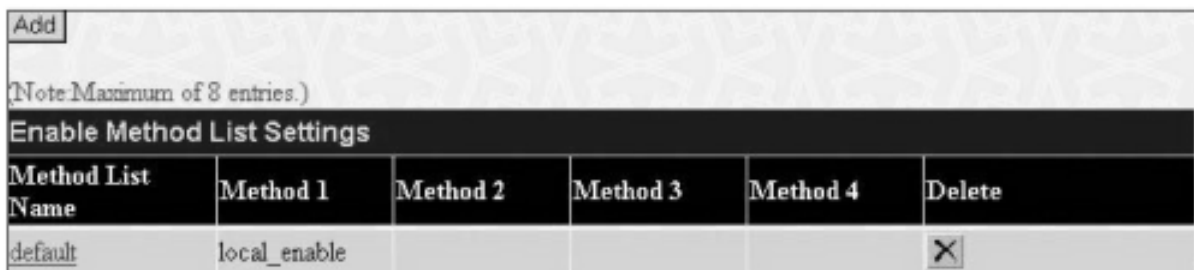

Enable Method List Settings					
Method List Name	Method 1	Method 2	Method 3	Method 4	Delete
default	local_enable				

Figure 7- 15. Enable Method List Settings window.

To delete an Enable Method List defined by the user, click the **X** under the **Delete** heading corresponding to the entry desired to be deleted. To modify an Enable Method List, click on its hyperlinked **Method List Name**. To configure a Method List, click the **Add** button.

Both actions will result in the same screen to configure:

Figure 7- 16. Enable Method List – Edit window

Figure 7- 17. Enable Method List – Add window

To define an Enable Login Method List, set the following parameters and click **Apply**:

Parameter	Description
Method List Name	Enter a method list name defined by the user of up to 15 characters.
Method 1, 2, 3, 4	<p>The user may add one, or a combination of up to four (4) of the following authentication methods to this method list:</p> <p><i>local_enable</i> – Adding this parameter will require the user to be authenticated using the local enable password database on the Switch. The local enable password must be set by the user in the next section entitled Local Enable Password.</p> <p><i>none</i> – Adding this parameter will require no authentication to access the Switch.</p> <p><i>radius</i> – Adding this parameter will require the user to be authenticated using the RADIUS protocol from a remote RADIUS server.</p> <p><i>tacacs</i> – Adding this parameter will require the user to be authenticated using the TACACS protocol from a remote TACACS server.</p> <p><i>xtacacs</i> – Adding this parameter will require the user to be authenticated using the XTACACS protocol from a remote XTACACS server.</p> <p><i>tacacs+</i> – Adding this parameter will require the user to be authenticated using the TACACS protocol from a remote TACACS server.</p> <p><i>server_group</i> – Adding a previously configured server group will require the user to be authenticated using a user-defined server group previously configured on the Switch.</p>

Local Enable Password

This window will configure the locally enabled password for the **Enable Admin** command. When a user chooses the "local_enable" method to promote user level privileges to administrator privileges, he or she will be prompted to enter the password configured here that is locally set on the Switch.

To view the following window, click **Security Management > Access Authentication Control > Local Enable Password**:

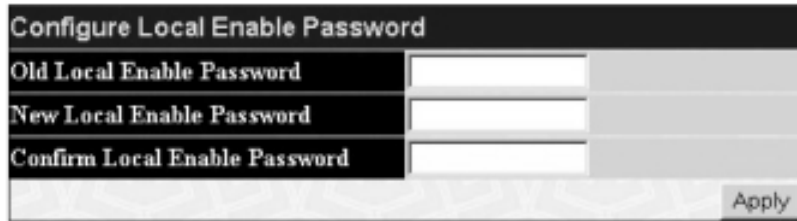

Figure 7- 18. Configure Local Enable Password window

To set the Local Enable Password, set the following parameters and click **Apply**.

Parameter	Description
Old Local Enable Password	If a password was previously configured for this entry, enter it here in order to change it to a new password.
New Local Enable Password	Enter the new password that you wish to set on the Switch to authenticate users attempting to access Administrator Level privileges on the Switch. The user may set a password of up to 15 characters.
Confirm Local Enable Password	Confirm the new password entered above. Entering a different password here from the one set in the New Local Enabled field will result in a fail message.

Enable Admin

The **Enable Admin** window is for users who have logged on to the Switch on the normal user level, and wish to be promoted to the administrator level. After logging on to the Switch, users will have only user level privileges. To gain access to administrator level privileges, the user will open this window and will have to enter an authentication password. Possible authentication methods for this function include TACACS/XTACACS/TACACS+/RADIUS, user defined server groups, local enable (local account on the Switch), or no authentication (none). Because XTACACS and TACACS do not support the enable function, the user must create a special account on the server host, which has the username "enable", and a password configured by the administrator that will support the "enable" function. This function becomes inoperable when the authentication policy is disabled.

To view the following window, click **Security Management > Access Authentication Control > Enable Admin**:

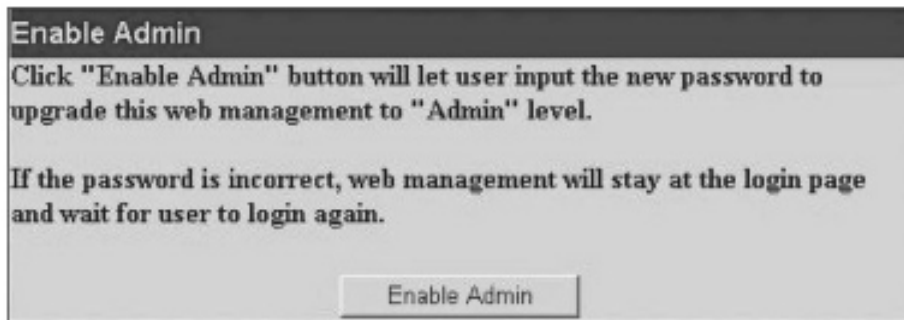

Figure 7- 19. Enable Admin Screen

When this screen appears, click the **Enable Admin** button revealing a window for the user to enter authentication (password, username), as seen below. A successful entry will promote the user to Administrator level privileges on the Switch.



Figure 7- 20. Enter Network Password window

7-4 Secure Socket Layer (SSL)

Secure Sockets Layer or SSL is a security feature that will provide a secure communication path between a host and client through the use of authentication, digital signatures and encryption. These security functions are implemented through the use of a ciphersuite, which is a security string that determines the exact cryptographic parameters, specific encryption algorithms and key sizes to be used for an authentication session and consists of three levels:

1. **Key Exchange:** The first part of the ciphersuite string specifies the public key algorithm to be used. This Switch utilizes the Rivest Shamir Adleman (RSA) public key algorithm and the Digital Signature Algorithm (DSA), specified here as the *DHE DSS* Diffie-Hellman (DHE) public key algorithm. This is the first authentication process between client and host as they “exchange keys” in looking for a match and therefore authentication to be accepted to negotiate encryptions on the following level.
2. **Encryption:** The second part of the ciphersuite that includes the encryption used for encrypting the messages sent between client and host. The Switch supports two types of cryptology algorithms:

Stream Ciphers – There are two types of stream ciphers on the Switch, *RC4 with 40-bit keys* and *RC4 with 128-bit keys*. These keys are used to encrypt messages and need to be consistent between client and host for optimal use.

CBC Block Ciphers – CBC refers to Cipher Block Chaining, which means that a portion of the previously encrypted block of encrypted text is used in the encryption of the current block. The Switch supports the *3DES EDE* encryption code defined by the Data Encryption Standard (DES) to create the encrypted text.
3. **Hash Algorithm:** This part of the ciphersuite allows the user to choose a message digest function which will determine a Message Authentication Code. This Message Authentication Code will be encrypted with a sent message to provide integrity and prevent against replay attacks. The Switch supports two hash algorithms, *MD5* (Message Digest 5) and *SHA* (Secure Hash Algorithm).

These three parameters are uniquely assembled in four choices on the Switch to create a three-layered encryption code for secure communication between the server and the host. The user may implement any one or combination of the ciphersuites available, yet different ciphersuites will affect the security level and the performance of the secured connection. The information included in the ciphersuites is not included with the Switch and requires downloading from a third source in a file form called a *certificate*. This function of the Switch cannot be executed without the presence and implementation of the certificate file and can be downloaded to the Switch by utilizing a TFTP server. The Switch supports SSLv3 and TLSv1. Other versions of SSL may not be compatible with this Switch and may cause problems upon authentication and transfer of messages from client to host.

Download Certificate

This window is used to download a certificate file for the SSL function on the Switch from a TFTP server. The certificate file is a data record used for authenticating devices on the network. It contains information on the owner, keys for authentication and digital signatures. Both the server and the client must have consistent certificate files for optimal use of the SSL function. The Switch only supports certificate files with .der file extensions.

To view the following window, click **Security Management > Secure Socket Layer (SSL) > Download Certificate**:



Figure 7- 21. Download Certificate window

To download certificates, set the following parameters and click **Apply**.

Parameter	Description
Certificate Type	Enter the type of certificate to be downloaded. This type refers to the server responsible for issuing certificates. This field has been limited to <i>local</i> for this firmware release.
Server IP	Enter the IP address of the TFTP server where the certificate files are located.
Certificate File Name	Enter the path and the filename of the certificate file to download. This file must have a .der extension. (Ex. c:/cert.der).
Key File Name	Enter the path and the filename of the key file to download. This file must have a .der extension (Ex. c:/pkey.der).

Configuration

This screen will allow the user to enable SSL on the Switch and implement any one or combination of listed ciphersuites on the Switch. A **ciphersuite** is a security string that determines the exact cryptographic parameters, specific encryption algorithms and key sizes to be used for an authentication session. The Switch possesses four possible ciphersuites for the SSL function, which are all enabled by default. To utilize a particular ciphersuite, disable the unwanted ciphersuites, leaving the desired one for authentication.

When the SSL function has been enabled, the web will become disabled. To manage the Switch through the web based management while utilizing the SSL function, the web browser must support SSL encryption and the header of the URL must begin with https://. (Ex. https://10.90.90.90) Any other method will result in an error and no access can be authorized for the web-based management.

To view the following window, click **Security Management > Secure Socket Layer (SSL) > Configuration**:

Figure 7- 22. Configuration and Ciphersuite window

To set up the SSL function on the Switch, configure the following parameters and click **Apply**.

Parameter	Description
Configuration	
SSL Status	Use the pull down menu to enable or disable the SSL status on the switch. The default is <i>Disabled</i> .
Cache Timeout (60-84600)	This field will set the time between a new key exchange between a client and a host using the SSL function. A new SSL session is established every time the client and host go through a key exchange. Specifying a longer timeout will allow the SSL session to reuse the master key on future connections with that particular host, therefore speeding up the negotiation process. The default setting is 600 seconds.
Ciphersuite	
RSA with RC4 128 MD5	This ciphersuite combines the RSA key exchange, stream cipher RC4 encryption with 128-bit keys and the MD5 Hash Algorithm. Use the pull down menu to enable or disable this ciphersuite. This field is <i>Enabled</i> by default.
RSA with 3DES EDE CBC SHA	This ciphersuite combines the RSA key exchange, CBC Block Cipher 3DES_EDE encryption and the SHA Hash Algorithm. Use the pull down menu to enable or disable this ciphersuite. This field is <i>Enabled</i> by default.
DHS DSS with 3DES EDE CBC SHA	This ciphersuite combines the DSA Diffie Hellman key exchange, CBC Block Cipher 3DES_EDE encryption and SHA Hash Algorithm. Use the pull down menu to enable or disable this ciphersuite. This field is <i>Enabled</i> by default.
RSA EXPORT with RC4 40 MD5	This ciphersuite combines the RSA Export key exchange and stream cipher RC4 encryption with 40-bit keys. Use the pull down menu to enable or disable this ciphersuite. This field is <i>Enabled</i> by default.

 **Note:** Certain implementations concerning the function and configuration of SSL are not available on the web-based management of this Switch and need to be configured using the command line interface. For more information on SSL and its functions, see the **AT-9724TS Command Line Reference Manual**, located on the documentation CD of this product.

 **Note:** Enabling the SSL command will disable the web-based switch management. To log on to the Switch again, the header of the URL must begin with https://. Entering anything else into the address field of the web browser will result in an error and no authentication will be granted.

7-5 Secure Shell (SSH)

SSH is an abbreviation of **Secure Shell**, which is a program allowing secure remote login and secure network services over an insecure network. It allows a secure login to remote host computers, a safe method of executing commands on a remote end node, and will provide secure encrypted and authenticated communication between two non-trusted hosts. SSH, with its array of unmatched security features is an essential tool in today's networking environment. It is a powerful guardian against numerous existing security hazards that now threaten network communications.

The steps required to use the SSH protocol for secure communication between a remote PC (the SSH client) and the Switch (the SSH server) are as follows:

1. Create a user account with admin-level access using the User Accounts window in the **Security Management** folder. This is identical to creating any other admin-level User Account on the Switch, including specifying a password. This password is used to logon to the Switch, once a secure communication path has been established using the SSH protocol.
2. Configure the User Account to use a specified authorization method to identify users that are allowed to establish SSH connections with the Switch using the **SSH User Authentication** window. There are three choices as to the method SSH will use to authorize the user, which are **Host Based, Password** and **Public Key**.
3. Configure the encryption algorithm that SSH will use to encrypt and decrypt messages sent between the SSH client and the SSH server, using the **SSH Algorithm** window.
4. Finally, enable SSH on the Switch using the **SSH Configuration** window.

After completing the preceding steps, a SSH Client on a remote PC can be configured to manage the Switch using a secure, in band connection.

SSH Configuration

The following window is used to configure and view settings for the SSH server and can be opened by clicking **Security Management > Secure Shell (SSH) > SSH Configuration**:

The screenshot displays the 'SSH Configuration' window, divided into two sections: 'Current SSH Configuration Settings' and 'New SSH Configuration Settings'. The 'Current' section shows: SSH Server Status (Disabled), Max Session (3), Connection TimeOut (120), Auth. Fail (2), and Session Rekeying (Never). The 'New' section shows: SSH Server Status (Disabled), Max Session(1-3) (3), Connection TimeOut(120-600) (120), Auth. Fail(2-20) (2), and Session Rekeying (Never). An 'Apply' button is located at the bottom right.

Figure 7- 23. Current and New SSH Configuration Settings

To configure the SSH server on the Switch, modify the following parameters and click **Apply**:

Parameter	Description
SSH Server Status	Use the pull-down menu to enable or disable SSH on the Switch. The default is <i>Disabled</i> .
Max Session (1-3)	Enter a value between 1 and 3 to set the number of users that may simultaneously access the Switch. The default setting is 3.
Connection TimeOut (120-600)	Allows the user to set the connection timeout. The user may set a time between 120 and 600 seconds. The default setting is 120 seconds.
Auth. Fail (2-20)	Allows the Administrator to set the maximum number of attempts that a user may try to log on to the SSH Server utilizing the SSH authentication. After the maximum number of attempts has been exceeded, the Switch will be disconnected and the user must reconnect to the Switch to attempt another login. The number of maximum attempts may be set between 2 and 20. The default setting is 2.
Session Rekeying	This field is used to set the time period that the Switch will change the security shell encryptions by using the pull-down menu. The available options are Never, 10 min, 30 min, and 60 min. The default setting is Never.

SSH Algorithm

The SSH Algorithm window allows the configuration of the desired types of SSH algorithms used for authentication encryption. There are three categories of algorithms listed and specific algorithms of each may be enabled or disabled by using their corresponding pull-down menus. All algorithms are enabled by default. To open the following window, click **Security Management > Secure Shell (SSH) > SSH Algorithm**:



Figure 7- 24. SSH Algorithms window

The following algorithms may be set:

Parameter	Description
Authentication Mode Configuration	
Password	This field may be enabled or disabled to choose if the administrator wishes to use a locally configured password for authentication on the Switch. This field is <i>Enabled</i> by default.
Public Key	This field may be enabled or disabled to choose if the administrator wishes to use a publickey configuration set on a SSH server, for authentication. This field is <i>Enabled</i> by default.
Host-based	This field may be enabled or disabled to choose if the administrator wishes to use a host computer for authentication. This parameter is intended for Linux users requiring SSH authentication techniques and the host computer is running the Linux operating system with a SSH program previously installed. This field is <i>Enabled</i> by default.
Encryption Algorithm	
3DES-CBC	Use the pull-down to enable or disable the Triple Data Encryption Standard encryption algorithm with Cipher Block Chaining. The default is <i>Enabled</i> .
Blow-fish CBC	Use the pull-down to enable or disable the Blowfish encryption algorithm with Cipher Block Chaining. The default is <i>Enabled</i> .
AES128-CBC	Use the pull-down to enable or disable the Advanced Encryption Standard AES128 encryption algorithm with Cipher Block Chaining. The default is <i>Enabled</i> .
AES192-CBC	Use the pull-down to enable or disable the Advanced Encryption Standard AES192 encryption algorithm with Cipher Block Chaining. The default is <i>Enabled</i> .
AES256-CBC	Use the pull-down to enable or disable the Advanced Encryption Standard AES-256 encryption algorithm with Cipher Block Chaining. The default is <i>Enabled</i> .
ARC4	Use the pull-down to enable or disable the Arcfour encryption algorithm with Cipher Block Chaining. The default is <i>Enabled</i> .
Cast128-CBC	Use the pull-down to enable or disable the Cast128 encryption algorithm with Cipher Block Chaining. The default is <i>Enabled</i> .
Twofish128	Use the pull-down to enable or disable the twofish128 encryption algorithm. The default is <i>Enabled</i> .
Twofish192	Use the pull-down to enable or disable the twofish192 encryption algorithm. The default is <i>Enabled</i> .
Twofish256	Use the pull-down to enable or disable the twofish256 encryption algorithm. The default is <i>Enabled</i> .

Data Integrity Algorithm

HMAC-SHA1 Use the pull-down to enable or disable the HMAC (Hash for Message Authentication Code) mechanism utilizing the Secure Hash algorithm. The default is *Enabled*.

HMAC-MD5 Use the pull-down to enable or disable the HMAC (Hash for Message Authentication Code) mechanism utilizing the MD5 Message Digest encryption algorithm. The default is *Enabled*.

Public Key Algorithm

HMAC-RSA Use the pull-down to enable or disable the HMAC (Hash for Message Authentication Code) mechanism utilizing the RSA encryption algorithm. The default is *Enabled*.

HMAC-DSA Use the pull-down to enable or disable the HMAC (Hash for Message Authentication Code) mechanism utilizing the Digital Signature Algorithm encryption. The default is *Enabled*.

Click **Apply** to implement changes made.

SSH User Authentication

The following windows are used to configure parameters for users attempting to access the Switch through SSH. To access the following window, click **Security Management > Secure Shell > SSH User Authentication**.

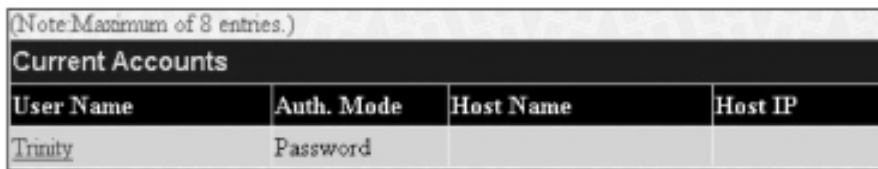

(Note: Maximum of 8 entries.)			
Current Accounts			
User Name	Auth. Mode	Host Name	Host IP
Trinity	Password		

Figure 7- 25. Current Accounts window

In the example screen above, the User Account “Trinity” has been previously set using the User Accounts window in the **Security Management** folder. A User Account **MUST** be set in order to set the parameters for the SSH user. To configure the parameters for a SSH user, click on the hyperlinked **User Name** in the **Current Accounts** window, which will reveal the following window to configure.

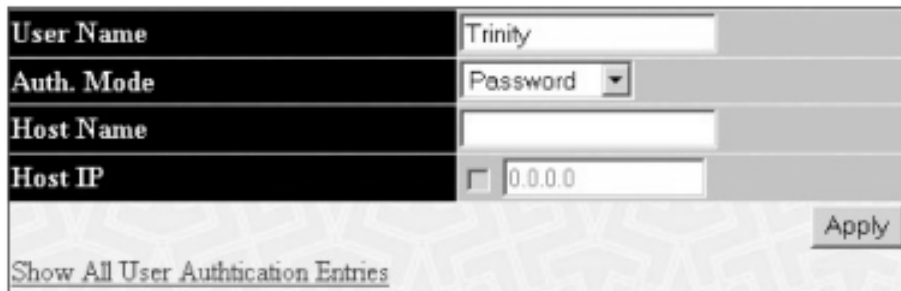

User Name	Trinity
Auth. Mode	Password
Host Name	
Host IP	<input type="checkbox"/> 0.0.0.0

Apply

[Show All User Authentication Entries](#)

Figure 7- 26. SSH User window

The user may set the following parameters:

Parameter	Description
User Name	Enter a User Name of no more than 15 characters to identify the SSH user. This User Name must be a previously configured user account on the Switch.
Auth. Mode	<p>The administrator may choose one of the following to set the authorization for users attempting to access the Switch.</p> <p><i>Host Based</i> – This parameter should be chosen if the administrator wishes to use a remote SSH server for authentication purposes. Choosing this parameter requires the user to input the following information to identify the SSH user.</p> <p style="padding-left: 40px;"><i>Host Name</i> – Enter an alphanumeric string of no more than 32 characters to identify the remote SSH user.</p> <p style="padding-left: 40px;"><i>Host IP</i> – Enter the corresponding IP address of the SSH user.</p> <p><i>Password</i> – This parameter should be chosen if the administrator wishes to use an administrator-defined password for authentication. Upon entry of this parameter, the Switch will prompt the administrator for a password, and then to re-type the password for confirmation.</p> <p><i>Public Key</i> – This parameter should be chosen if the administrator wishes to use the publickey on a SSH server for authentication.</p>
Host Name	Enter an alphanumeric string of no more than 32 characters to identify the remote SSH user. This parameter is only used in conjunction with the Host Based choice in the Auth. Mode field.
Host IP	Enter the corresponding IP address of the SSH user. This parameter is only used in conjunction with the Host Based choice in the Auth. Mode field.

Click **Apply** to implement changes made.

 **Note:** To set the **SSH User Authentication** parameters on the Switch, a User Account must be previously configured. For more information on configuring local User Accounts on the Switch, see the **User Accounts** section of this manual located in this section.

Chapter 8 - SNMP Manager

SNMP Settings

Simple Network Management Protocol (SNMP) is an OSI Layer 7 (Application Layer) designed specifically for managing and monitoring network devices. SNMP enables network management stations to read and modify the settings of gateways, routers, switches, and other network devices. Use SNMP to configure system features for proper operation, monitor performance and detect potential problems in the Switch, switch group or network.

Managed devices that support SNMP include software (referred to as an agent), which runs locally on the device. A defined set of variables (managed objects) is maintained by the SNMP agent and used to manage the device. These objects are defined in a Management Information Base (MIB), which provides a standard presentation of the information controlled by the on-board SNMP agent. SNMP defines both the format of the MIB specifications and the protocol used to access this information over the network.

The AT-9724TS supports the SNMP versions 1, 2c, and 3. You can specify which version of the SNMP you want to use to monitor and control the Switch. The three versions of SNMP vary in the level of security provided between the management station and the network device.

In SNMP v.1 and v.2, user authentication is accomplished using 'community strings', which function like passwords. The remote user SNMP application and the Switch SNMP must use the same community string. SNMP packets from any station that has not been authenticated are ignored (dropped).

The default community strings for the Switch used for SNMP v1 and v2 management access are:

public – Allows authorized management stations to retrieve MIB objects.

private – Allows authorized management stations to retrieve and modify MIB objects.

SNMPv3 uses a more sophisticated authentication process that is separated into two parts. The first part is to maintain a list of users and their attributes that are allowed to act as SNMP managers. The second part describes what each user on that list can do as an SNMP manager.

The Switch allows groups of users to be listed and configured with a shared set of privileges. The SNMP version may also be set for a listed group of SNMP managers. Thus, you may create a group of SNMP managers that are allowed to view read-only information or receive traps using SNMPv1 while assigning a higher level of security to another group, granting read/write privileges using SNMPv3.

Using SNMPv3 individual users or groups of SNMP managers can be allowed to perform or be restricted from performing specific SNMP management functions. The functions allowed or restricted are defined using the Object Identifier (OID) associated with a specific MIB. An additional layer of security is available for SNMPv3 in that SNMP messages may be encrypted. To read more about how to configure SNMPv3 settings for the Switch read the next section.

Traps

Traps are messages that alert network personnel of events that occur on the Switch. The events can be as serious as a reboot (someone accidentally turned OFF the Switch), or less serious like a port status change. The Switch generates traps and sends them to the trap recipient (or network manager). Typical traps include trap messages for Authentication Failure, Topology Change and Broadcast\Multicast Storm.

MIBs

Management and counter information are stored by the Switch in the Management Information Base (MIB). The Switch uses the standard MIB-II Management Information Base module. Consequently, values for MIB objects can be retrieved from any SNMP-based network management software. In addition to the standard MIB-II, the Switch also supports its own proprietary enterprise MIB as an extended Management Information Base. The proprietary MIB may also be retrieved by specifying the MIB Object Identifier. MIB values can be either read-only or read-write.

The AT-9724TS incorporates a flexible SNMP management for the switching environment. SNMP management can be customized to suit the needs of the networks and the preferences of the network administrator. Use the SNMPV3 menus to select the SNMP version used for specific tasks.

The AT-9724TS supports the Simple Network Management Protocol (SNMP) versions 1, 2c, and 3. The administrator can specify the SNMP version used to monitor and control the Switch. The three versions of SNMP vary in the level of security provided between the management station and the network device.

SNMP settings are configured using the menus located on the SNMPV3 folder of the web manager. Workstations on the network that are allowed SNMP privileged access to the Switch can be restricted with the Management Station IP Address menu.

SNMP User Table

The **SNMP User Table** displays all of the SNMP User's currently configured on the Switch.

In the **SNMP Manager** folder, click on the **SNMP User Table** link. This will open the **SNMP User Table**, as shown below.



User Name	Group Name	SNMP Version	Delete
initial	initial	V3	X

Figure 8- 1. SNMP User Table

To delete an existing SNMP User Table entry, click the **X** below the **Delete** heading corresponding to the entry you wish to delete.

To display the detailed entry for a given user, click on the hyperlinked User Name. This will open the **SNMP User Table Display** page, as shown below.

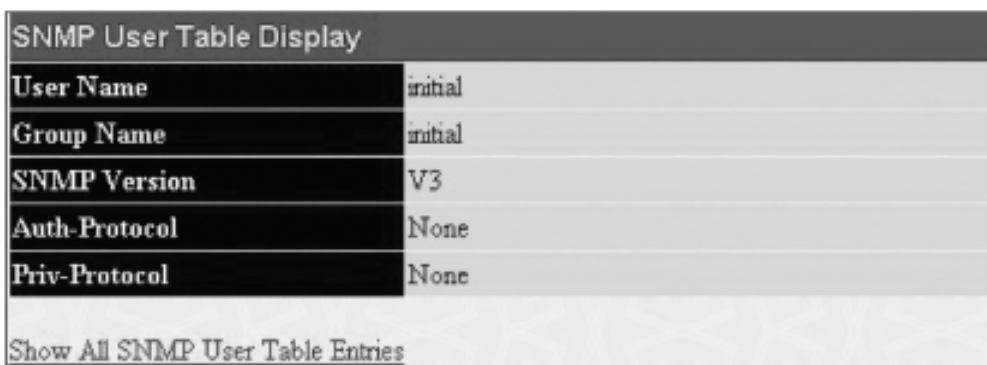

Figure 8- 2. SNMP User Table Display window

The following parameters are displayed:

Parameter	Description
User Name	An alphanumeric string of up to 32 characters. This is used to identify the SNMP users.
Group Name	This name is used to specify the SNMP group created can request SNMP messages.
SNMP Version	V1 – Indicates that SNMP version 1 is in use. V2 – Indicates that SNMP version 2 is in use. V3 – Indicates that SNMP version 3 is in use.
Auth-Protocol	None – Indicates that no authorization protocol is in use. MD5 – Indicates that the HMAC-MD5-96 authentication level will be used. SHA – Indicates that the HMAC-SHA authentication protocol will be used.
Priv-Protocol	None – Indicates that no authorization protocol is in use. DES – Indicates that DES 56-bit encryption is in use based on the CBC-DES (DES-56) standard.

To return to the **SNMP User Table**, click the [Show All SNMP User Table Entries](#) link.

To add a new entry to the **SNMP User Table Configuration**, click on the **Add** button on the **SNMP User Table** page.

This will open the **SNMP User Table Configuration** page, as shown below.

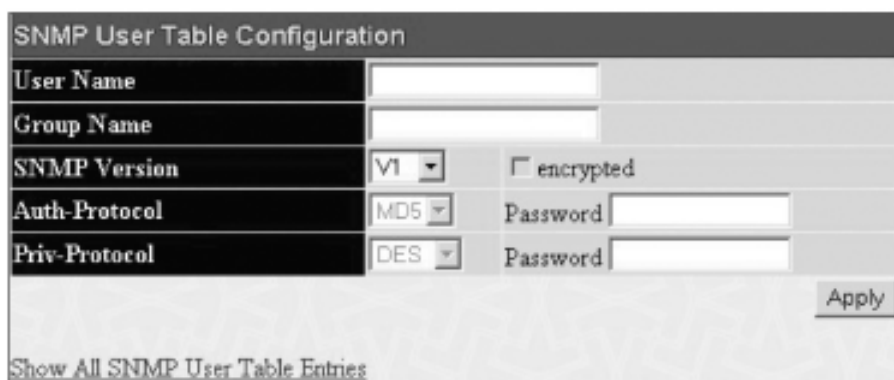

Figure 8- 3. SNMP User Table Configuration window

The following parameters can be set:

Parameter	Description
User Name	Enter an alphanumeric string of up to 32 characters. This is used to identify the SNMP user.
Group Name	This name is used to specify the SNMP group created can request SNMP messages.
SNMP Version	V1 – Specifies that SNMP version 1 will be used. V2 – Specifies that SNMP version 2 will be used. V3 – Specifies that SNMP version 3 will be used.
Auth-Protocol	MD5 – Specifies that the HMAC-MD5-96 authentication level will be used. This field is only operable when V3 is selected in the SNMP Version field and the Encryption field has been checked. This field will require the user to enter a password. SHA – Specifies that the HMAC-SHA authentication protocol will be used. This field is only operable when V3 is selected in the SNMP Version field and the Encryption field has been checked. This field will require the user to enter a password.
Priv-Protocol	None – Specifies that no authorization protocol is in use. DES – Specifies that DES 56-bit encryption is in use, based on the CBC-DES (DES-56) standard. This field is only operable when V3 is selected in the SNMP Version field and the Encryption field has been checked. This field will require the user to enter a password between 8 and 16 alphanumeric characters.
Encrypted	Checking the corresponding box will enable encryption for SNMPV3 and is only operable in SNMPV3 mode.

To implement changes made, click **Apply**. To return to the **SNMP User Table**, click the [Show All SNMP User Table Entries](#) link.

SNMP View Table

The SNMP View Table is used to assign views to community strings that define which MIB objects can be accessed by a remote SNMP manager. To view the **SNMP View Table**, open the **SNMP Manager** folder and click the **SNMP View Table** entry. The following screen should appear:

Add			
Total Entries: 8 (Note: Maximum of 30 entries.)			
SNMP View Table			
View Name	Subtree	View Type	Delete
restricted	1.3.6.1.2.1.1	Included	X
restricted	1.3.6.1.2.1.11	Included	X
restricted	1.3.6.1.6.3.10.2.1	Included	X
restricted	1.3.6.1.6.3.11.2.1	Included	X
restricted	1.3.6.1.6.3.15.1.1	Included	X
CommunityView	1	Included	X
CommunityView	1.3.6.1.6.3	Excluded	X
CommunityView	1.3.6.1.6.3.1	Included	X

Figure 8- 4. SNMP View Table

To delete an existing **SNMP View Table** entry, click the **X** in the **Delete** column corresponding to the entry you wish to delete. To create a new entry, click the **Add** button and a separate menu will appear.

Figure 8- 5. SNMPView Table Configuration window

The SNMP Group created with this table maps SNMP users (identified in the **SNMP User Table**) to the views created in the previous menu. The following parameters can be set:

Parameter	Description
View Name	Type an alphanumeric string of up to 32 characters. This is used to identify the new SNMP view being created.
Subtree OID	Type the Object Identifier (OID) Subtree for the view. The OID identifies an object tree (MIB tree) that will be included or excluded from access by an SNMP manager.
View Type	Select Included to include this object in the list of objects that an SNMP manager can access. Select Excluded to exclude this object from the list of objects that an SNMP manager can access.

To implement your new settings, click **Apply**. To return to the **SNMP View Table**, click the [Show All SNMPView Table Entries](#) link.

SNMP Group Table

An SNMP Group created with this table maps SNMP users (identified in the SNMP User Table) to the views created in the previous menu. To view the **SNMP Group Table**, open the **SNMP Manager** folder and click the **SNMP Group Table** entry. The following screen should appear:

Unit: 1 , Port: Port 1 Time Interval: 1s 0s			
Rx Packets	Total	Rate(1/Sec)	Max Rate
Bytes	68648580	5318	8975
Packets	519343	30	78
Rx Packets	Total	Rate(1/Sec)	Max Rate
Unicast	9855	6	9
Multicast	62137	7	16
Broadcast	447351	17	66
Tx Packets	Total	Rate(1/Sec)	Max Rate
Bytes	1796046	320	3408
Packets	3819	5	6

Figure 8- 6. SNMP Group Table

To delete an existing **SNMP Group Table** entry, click the corresponding **X** under the **Delete** heading.

To display the current settings for an existing **SNMP Group Table** entry, click the hyperlink for the entry under the **Group Name**.

To add a new entry to the Switch's **SNMP Group Table**, click the **Add** button in the upper left-hand corner of the **SNMP Group Table** page. This will open the **SNMP Group Table Configuration** page, as shown below.

The image shows a configuration window titled "SNMP Group Table Configuration". It contains several input fields and dropdown menus:

- Group Name:** A text input field.
- Read View Name:** A text input field.
- Write View Name:** A text input field.
- Notify View Name:** A text input field.
- Security Model:** A dropdown menu with "SNMPv1" selected.
- Security Level:** A dropdown menu with "NoAuthNoPriv" selected.

At the bottom right, there is an "Apply" button. At the bottom left, there is a link that says "Show All SNMP Group Table Entries".

Figure 8- 7. SNMP Group Table Configuration window

The following parameters can be set:

Parameter	Description
Group Name	Type an alphanumeric string of up to 32 characters. This is used to identify the new SNMP group of SNMP users.
Read View Name	This name is used to specify the SNMP group created can request SNMP messages.
Write View Name	Specify a SNMP group name for users that are allowed SNMP write privileges to the Switch's SNMP agent.
Notify View Name	Specify a SNMP group name for users that can receive SNMP trap messages generated by the Switch's SNMP agent.
Security Model	<p><i>SNMPv1</i> – Specifies that SNMP version 1 will be used.</p> <p><i>SNMPv2</i> – Specifies that SNMP version 2c will be used. The SNMPv2 supports both centralized and distributed network management strategies. It includes Read View Name improvements in the Structure of Management Information (SMI) and adds some security features.</p> <p><i>SNMPv3</i> – Specifies that the SNMP version 3 will be used. SNMPv3 provides secure access to devices through a combination of authentication and encrypting packets over the network.</p>
Security Level	<p>The Security Level settings only apply to SNMPv3.</p> <p><i>NoAuthNoPriv</i> – Specifies that there will be no authorization and no encryption of packets sent between the Switch and a remote SNMP manager.</p> <p><i>AuthNoPriv</i> – Specifies that authorization will be required, but there will be no encryption of packets sent between the Switch and a remote SNMP manager.</p> <p><i>AuthPriv</i> – Specifies that authorization will be required, and that packets sent between the Switch and a remote SNMP manager will be encrypted.</p>

To implement your new settings, click **Apply**. To return to the **SNMP Group Table**, click the [Show All SNMP Group Table Entries](#) link.

SNMP Community Table Configuration

Use this table to create an SNMP community string to define the relationship between the SNMP manager and an agent. The community string acts like a password to permit access to the agent on the Switch. One or more of the following characteristics can be associated with the community string:

- An Access List of IP addresses of SNMP managers that are permitted to use the community string to gain access to the Switch's SNMP agent.
- Any MIB view that defines the subset of all MIB objects will be accessible to the SNMP community.
- Read/write or read-only level permission for the MIB objects accessible to the SNMP community.

To configure **SNMP Community** entries, open the **SNMP Manager** folder and click the **SNMP Community Table** link, which will open the following screen:

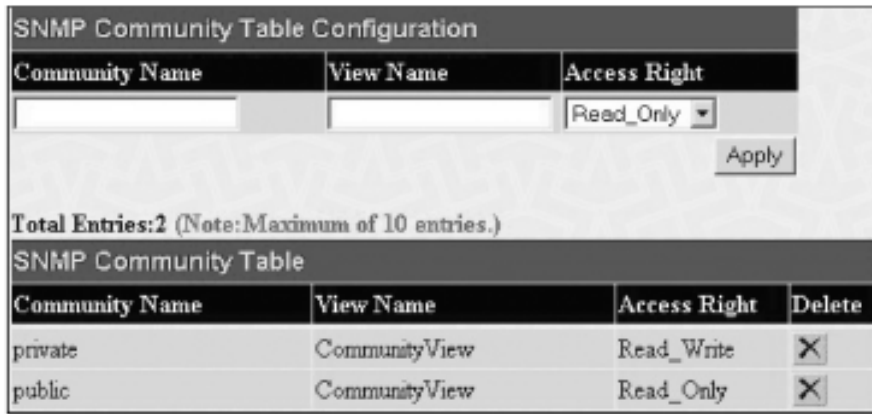

Figure 8- 8. SNMP Community Table Configuration and Table window

The following parameters can be set:

Parameter	Description
Community Name	Type an alphanumeric string of up to 33 characters that is used to identify members of an SNMP community. This string is used like a password to give remote SNMP managers access to MIB objects in the Switch's SNMP agent.
View Name	Type an alphanumeric string of up to 32 characters that is used to identify the group of MIB objects that a remote SNMP manager is allowed to access on the Switch. The view name must exist in the SNMPView Table.
Access Right	<i>Read Only</i> – Specifies that SNMP community members using the community string created can only read the contents of the MIBs on the Switch. <i>Read Write</i> – Specifies that SNMP community members using the community string created can read from, and write to the contents of the MIBs on the Switch.

To implement the new settings, click **Apply**. To delete an entry from the **SNMP Community Table**, click the **X** under the **Delete** heading, corresponding to the entry you wish to delete.

SNMP Host Table

Use the **SNMP Host Table** to set up SNMP trap recipients.

Open the **SNMP Manager** folder and click on the **SNMP Host Table** link. This will open the **SNMP Host Table** page, as shown below.

To delete an existing **SNMP Host Table** entry, click the corresponding **X** under the **Delete** heading.

To display the current settings for an existing **SNMP Group Table** entry, click the blue link for the entry under the **Host IP Address** heading.

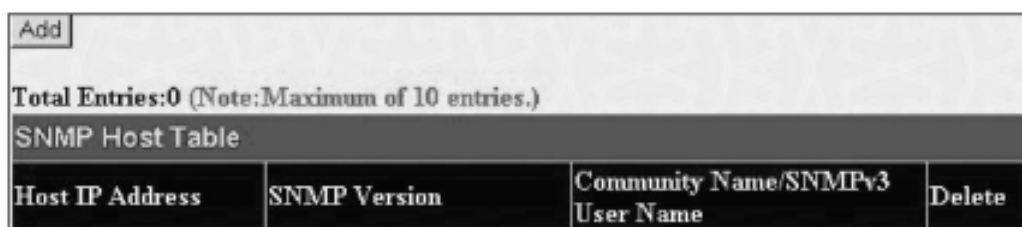

Figure 8- 9. SNMP Host Table

To add a new entry to the Switch's **SNMP Host Table**, click the **Add** button in the upper left-hand corner of the page. This will open the **SNMP Host Table Configuration** page, as shown below.

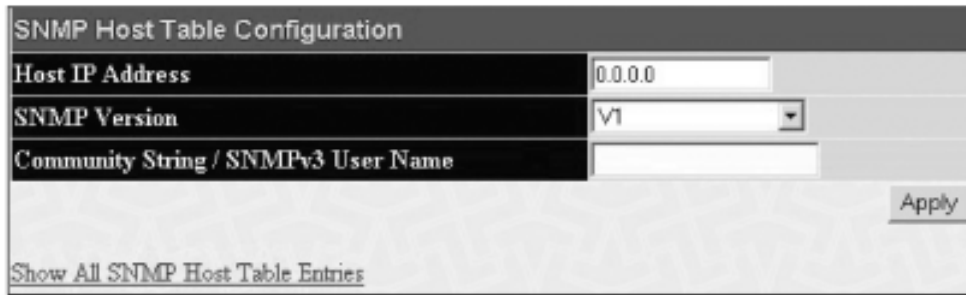

Figure 8-10. SNMP Host Table Configuration window

The following parameters can be set:

Parameter	Description
Host IP Address	Type the IP address of the remote management station that will serve as the SNMP host for the Switch.
SNMP Version	<p>V1 – To specifies that SNMP version 1 will be used.</p> <p>V2 – To specify that SNMP version 2 will be used.</p> <p>V3-NoAuth-NoPriv – To specify that the SNMP version 3 will be used, with a NoAuth-NoPriv security level.</p> <p>V3-Auth-NoPriv – To specify that the SNMP version 3 will be used, with an Auth-NoPriv security level.</p> <p>V3-Auth-Priv – To specify that the SNMP version 3 will be used, with an Auth-Priv security level.</p>
Community String or SNMP V3 User Name	Type in the community string or SNMPV3 user name as appropriate.

To implement your new settings, click **Apply**. To return to the **SNMP Host Table**, click the [Show All SNMP Host Table Entries](#) link.

SNMP Engine ID

The Engine ID is a unique identifier used for SNMPV3 implementations. This is an alphanumeric string used to identify the SNMP engine on the Switch.

To display the Switch's SNMP Engine ID, open the **SNMP Manager** folder and click on the **SNMP Engine ID** link. This will open the **SNMP Engine ID Configuration** window, as shown below.

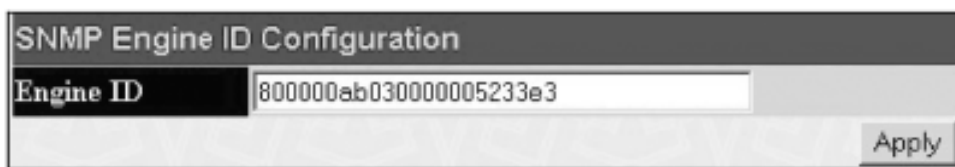

Figure 8-11. SNMP Engine ID Configuration window

To change the Engine ID, type the new Engine ID in the space provided and click the **Apply** button.

Chapter 9 - Monitoring

9-1 Port Utilization

The **Port Utilization** page displays the percentage of the total available bandwidth being used on the port.

To view the port utilization, open the **Monitoring** folder and then the **Port Utilization** link:

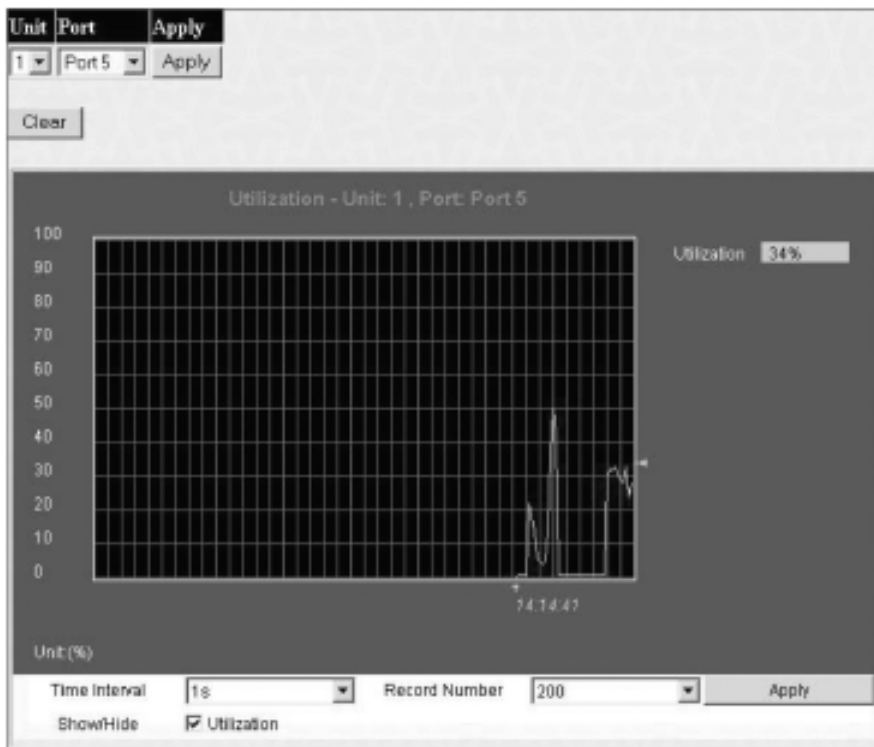

Figure 9- 1. Port Utilization window

To select a port to view these statistics for, first select the Switch in the switch stack by using the **Unit** pull-down menu and then select the port by using the **Port** pull down menu. The user may also use the real-time graphic of the Switch and/or switch stack at the top of the web page by simply clicking on a port.

The following fields can be set:

Parameter	Description
Time Interval	Select the desired setting between 1s and 60s, where "s" stands for seconds. The default value is one second.
Record Number	Select number of times the Switch will be polled between 20 and 200. The default value is 200.

Click **Clear** to refresh the graph. Click **Apply** to set changes implemented.

9-2 CPU Utilization

The **CPU Utilization** displays the percentage of the CPU being used, expressed as an integer percentage and calculated as a simple average by time interval. To view the **CPU Utilization** window, open the **Monitoring** folder and click the **CPU Utilization** link.

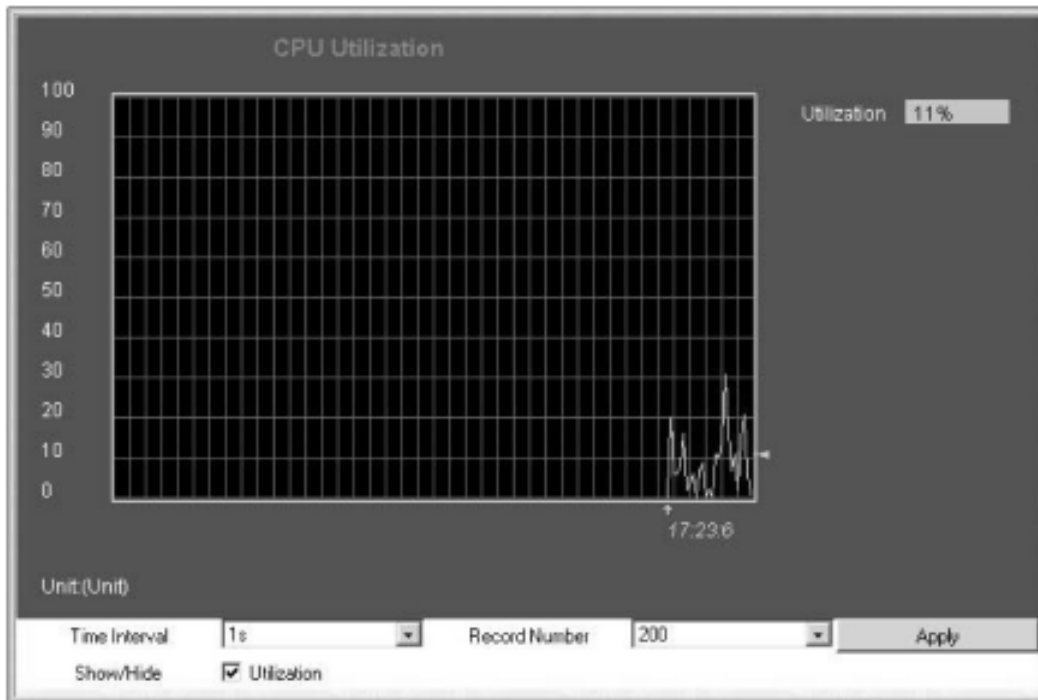

Figure 9- 2. CPU Utilization graph

Click **Apply** to implement the configured settings. The window will automatically refresh with new updated statistics.

The information is described as follows:

Parameter	Description
Time Interval	Select the desired setting between 1s and 60s, where "s" stands for seconds. The default value is one second.
Record Number	Select number of times the Switch will be polled between 20 and 200. The default value is 200.
Utilization	Check whether or not to display Utilization.

9-3 Packets

The Web Manager allows various packet statistics to be viewed as either a line graph or a table. Six windows are offered.

Received (RX)

Click the **Received (RX)** link in the **Packets** folder of the **Monitoring** menu to view the following graph of packets received on the Switch. To select a port to view these statistics for, first select the Switch in the switch stack by using the **Unit** pull-down menu and then select the port by using the **Port** pull down menu. The user may also use the real-time graphic of the Switch and/or switch stack at the top of the web page by simply clicking on a port.

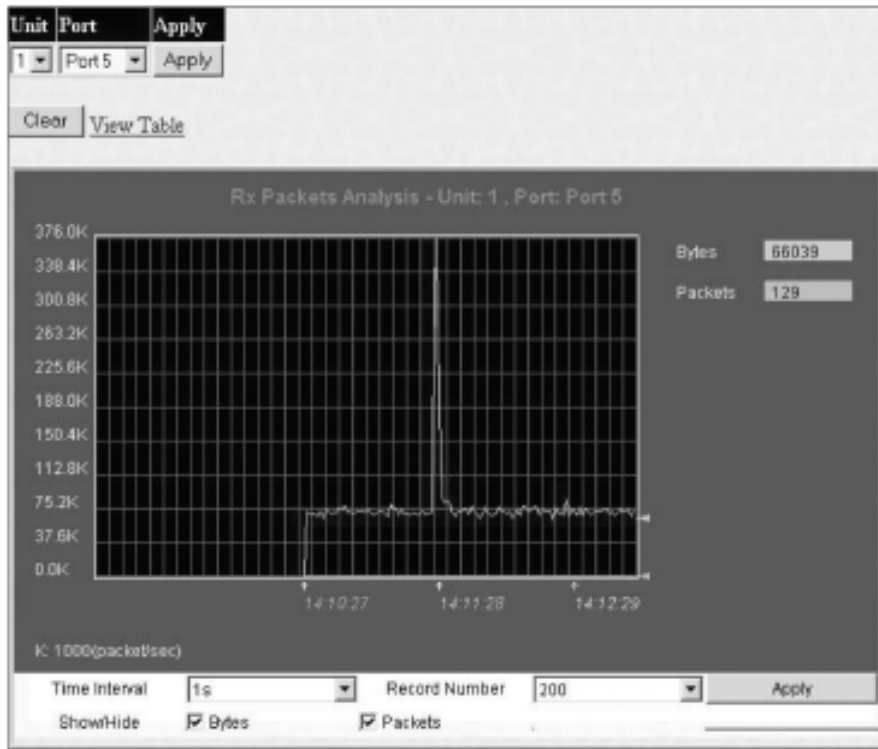

Figure 9- 3. Rx Packets Analysis window (line graph for Bytes and Packets)

To view the **Received Packets Table**, click the link **View Table**, which will show the following table:

View LineChart

Unit: 1, Port: Port 5 Time Interval: 1s OK

Rx Packets	Total	Rate(1/Sec)	Max Rate
Bytes	1518425142	65740	378597
Packets	5754407	130	1121
Rx Packets	Total	Rate(1/Sec)	Max Rate
Unicast	1694049	15	513
Multicast	2742554	67	94
Broadcast	1327804	48	542
Tx Packets	Total	Rate(1/Sec)	Max Rate
Bytes	5901279	484	44888
Packets	16600	3	49

Figure 9- 4. Rx Packets Analysis window (table for Bytes and Packets)

The following fields may be set or viewed:

Parameter	Description
Time Interval	Select the desired setting between 1s and 60s, where "s" stands for seconds. The default value is one second.
Record Number	Select number of times the Switch will be polled between 20 and 200. The default value is 200.
Bytes	Counts the number of bytes received on the port.
Packets	Counts the number of packets received on the port.
Unicast	Counts the total number of good packets that were received by a unicast address.
Multicast	Counts the total number of good packets that were received by a multicast address.
Broadcast	Counts the total number of good packets that were received by a broadcast address.
Show/Hide	Check whether to display Bytes and Packets.
Clear	Clicking this button clears all statistics counters on this window.
View Table	Clicking this button instructs the Switch to display a table rather than a line graph.
View Line	Chart Clicking this button instructs the Switch to display a line graph rather than a table.

UMB Cast (RX)

Click the **UMB Cast (RX)** link in the **Packets** folder of the **Monitoring** menu to view the following graph of UMB cast packets received on the Switch. To select a port to view these statistics for, first select the Switch in the switch stack by using the Unit pull-down menu and then select the port by using the Port pull down menu. The user may also use the real-time graphic of the Switch and/or switch stack at the top of the web page by simply clicking on a port.

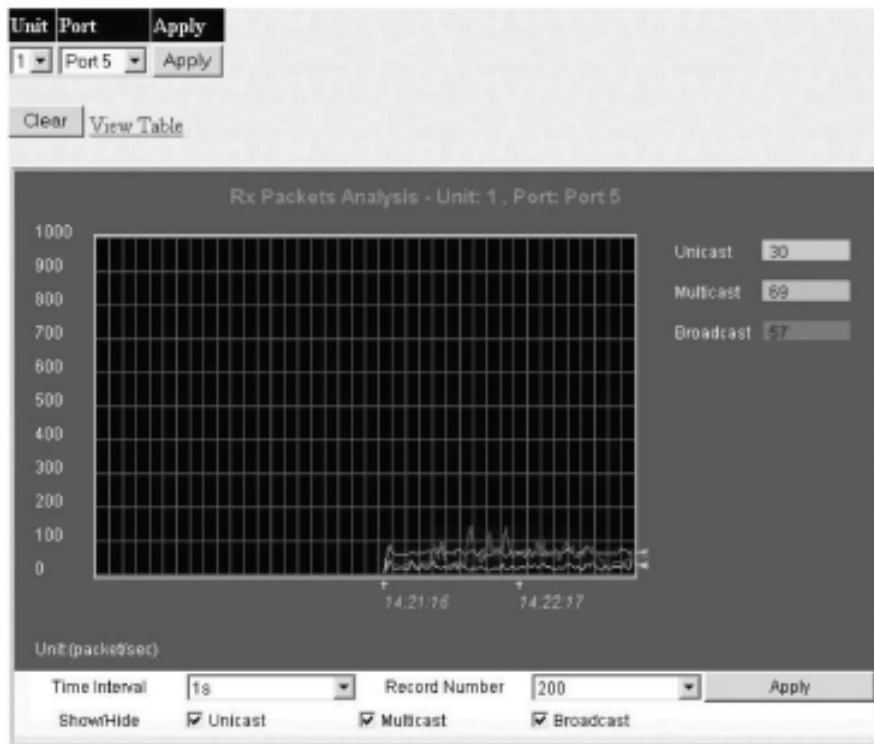

Figure 9- 5. Rx Packets Analysis window (line graph for Unicast, Multicast, and Broadcast Packets)

To view the **UMB Cast Table**, click the **View Table** link, which will show the following table:

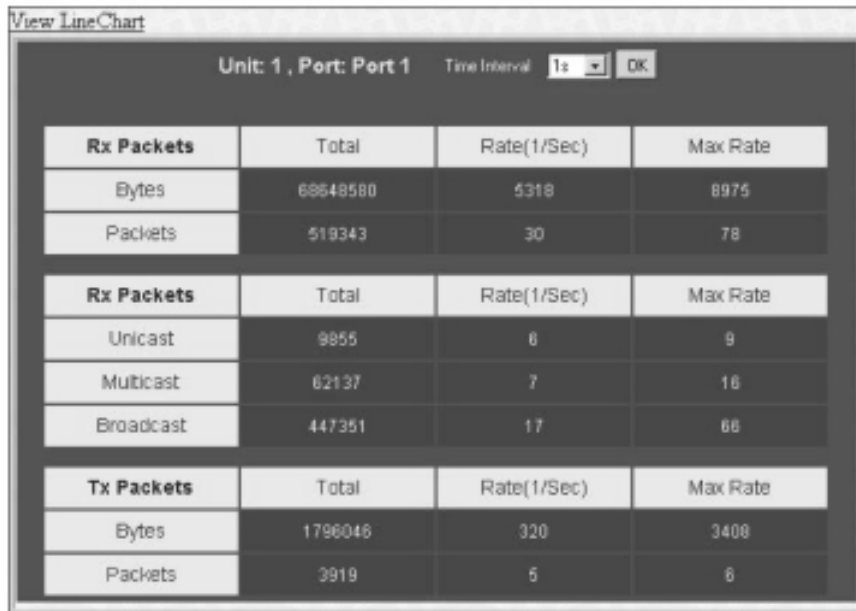

Figure 9- 6. Rx Packets Analysis window (table for Unicast, Multicast, and Broadcast Packets)

The following fields may be set or viewed:

Parameter	Description
Time Interval	Select the desired setting between 1s and 60s, where "s" stands for seconds. The default value is one second.
Record Number	Select number of times the Switch will be polled between 20 and 200. The default value is 200.
Unicast	Counts the total number of good packets that were received by a unicast address.
Multicast	Counts the total number of good packets that were received by a multicast address.
Broadcast	Counts the total number of good packets that were received by a broadcast address.
Show/Hide	Check whether or not to display Multicast, Broadcast, and Unicast Packets.
Clear	Clicking this button clears all statistics counters on this window.
View Table	Clicking this button instructs the Switch to display a table rather than a line graph.
View Line	Chart Clicking this button instructs the Switch to display a line graph rather than a table.

Transmitted (TX)

Click the **Transmitted (TX)** link in the **Packets** folder of the **Monitoring** menu to view the following graph of packets transmitted from the Switch. To select a port to view these statistics for, first select the Switch in the switch stack by using the Unit pull-down menu and then select the port by using the Port pull down menu. The user may also use the real-time graphic of the Switch and/or switch stack at the top of the web page by simply clicking on a port.

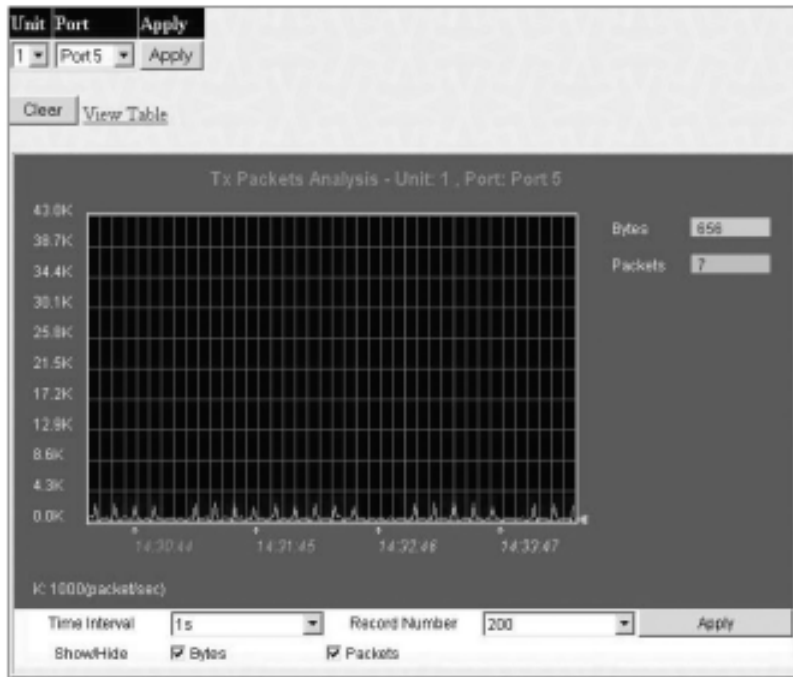

Figure 9- 7. Tx Packets Analysis window (line graph for Bytes and Packets)

To view the **Transmitted (TX) Table**, click the link [View Table](#), which will show the following table:

View LineChart				
Unit: 1 , Port: Port 5				
		Time Interval	1s	OK
Rx Packets	Current	Total	Average	Peak
Bytes	1828492956	9392357	9545414	0
Packets	7052946	9010	86871	0
Rx Packets	Current	Total	Average	Peak
Unicast	2703060	83	86745	0
Multicast	2929174	7644	7644	0
Broadcast	1420712	1283	1665	0
Tx Packets	Current	Total	Average	Peak
Bytes	6871194	627	44888	0
Packets	22491	5	62	0

Figure 9- 8. Tx Packets Analysis window (table for Bytes and Packets)

The following fields may be set or viewed:

Parameter	Description
Time Interval	Select the desired setting between 1s and 60s, where "s" stands for seconds. The default value is one second.
Record Number	Select number of times the Switch will be polled between 20 and 200. The default value is 200.
Bytes	Counts the number of bytes successfully sent from the port.
Packets	Counts the number of packets successfully sent on the port.
Unicast	Counts the total number of good packets that were transmitted by a unicast address.
Multicast	Counts the total number of good packets that were transmitted by a multicast address.
Broadcast	Counts the total number of good packets that were transmitted by a broadcast address.
Show/Hide	Check whether or not to display Bytes and Packets.
Clear	Clicking this button clears all statistics counters on this window.
View Table	Clicking this button instructs the Switch to display a table rather than a line graph.
View Line Chart	Clicking this button instructs the Switch to display a line graph rather than a table.

9-4 Errors

The Web Manager allows port error statistics compiled by the Switch's management agent to be viewed as either a line graph or a table. Four windows are offered.

Received (RX)

Click the **Received (RX)** link in the **Error** folder of the **Monitoring** menu to view the following graph of error packets received on the Switch. To select a port to view these statistics for, first select the Switch in the switch stack by using the Unit pull-down menu and then select the port by using the Port pull down menu. The user may also use the real-time graphic of the Switch and/or switch stack at the top of the web page by simply clicking on a port.

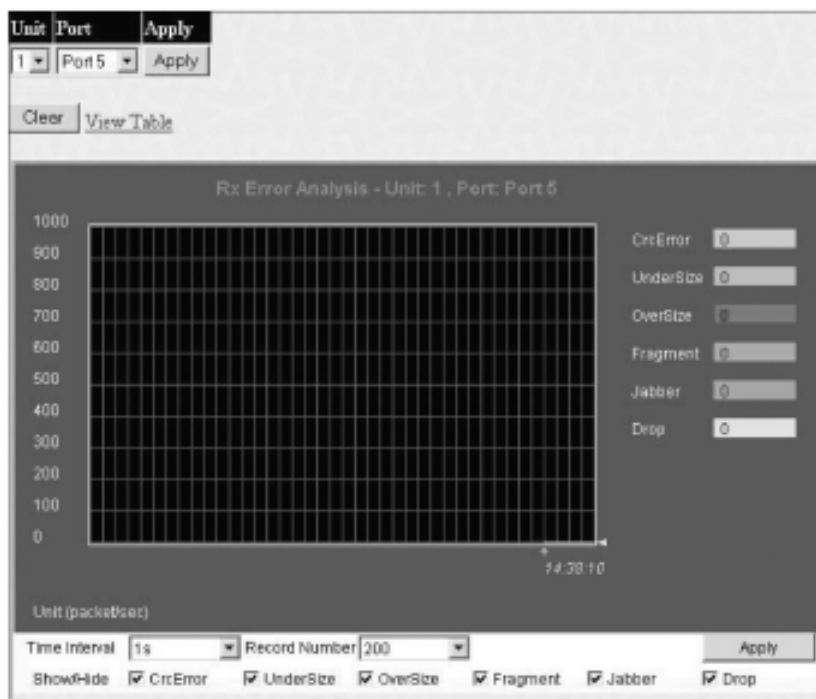

Figure 9- 9. Rx Error Analysis window (line graph)

To view the **Received Error Packets Table**, click the link **View Table**, which will show the following table:

Rx Error	Total	Rate(1/Sec)	Max Rate
CrcError	71	0	0
UnderSize	0	0	0
OverSize	0	0	0
Fragment	0	0	0
Jabber	9	0	0
Drop	131	1	1

Figure 9- 10. Rx Error Analysis window (table)

The following fields can be set:

Parameter	Description
Time Interval	Select the desired setting between 1s and 60s, where "s" stands for seconds. The default value is one second.
Record Number	Select number of times the Switch will be polled between 20 and 200. The default value is 200.
Crc Error	Counts otherwise valid packets that did not end on a byte (octet) boundary.
Under Size	The number of packets detected that are less than the minimum permitted packets size of 64 bytes and have a good CRC. Undersize packets usually indicate collision fragments, a normal network occurrence.
Over Size	Counts packets received that were longer than 1518 octets, or if a VLAN frame is 1522 octets, and less than the MAX_PKT_LEN. Internally, MAX_PKT_LEN is equal to 1522.
Fragment	The number of packets less than 64 bytes with either bad framing or an invalid CRC. These are normally the result of collisions.
Jabber	The number of packets with lengths more than the MAX_PKT_LEN bytes. Internally, MAX_PKT_LEN is equal to 1522.
Drop	The number of packets that are dropped by this port since the last Switch reboot.
Show/Hide	Check whether or not to display Crc Error, Under Size, Over Size, Fragment, Jabber, and Drop errors.
Clear	Clicking this button clears all statistics counters on this window.
View Table	Clicking this button instructs the Switch to display a table rather than a line graph.
View Line	Chart Clicking this button instructs the Switch to display a line graph rather than a table.

Transmitted (TX)

Click the Transmitted (TX) link in the Error folder of the Monitoring menu to view the following graph of error packets received on the Switch. To select a port to view these statistics for, first select the Switch in the switch stack by using the Unit pull-down menu and then select the port by using the Port pull down menu. The user may also use the real-time graphic of the Switch and/or switch stack at the top of the web page by simply clicking on a port.

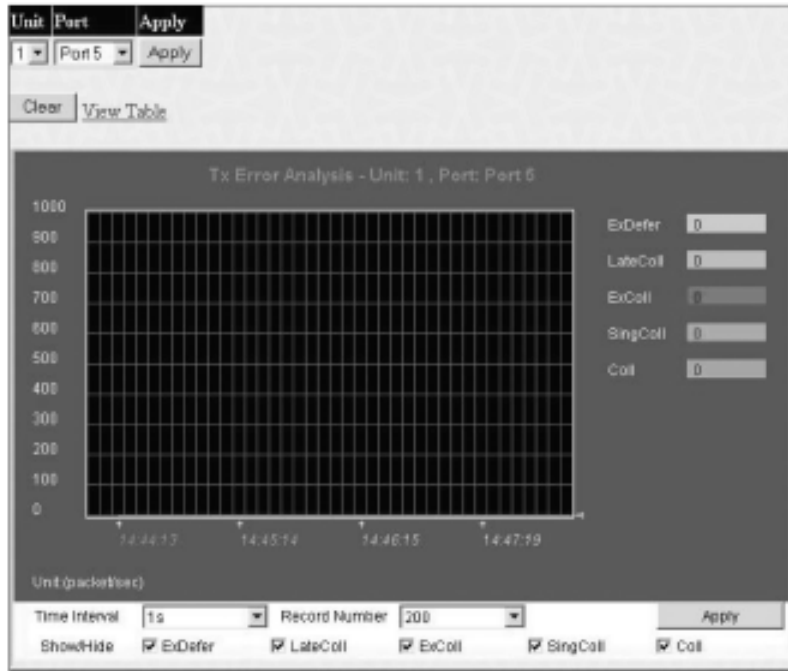

Figure 9- 11.Tx Error Analysis window (line graph)

To view the **Transmitted Error Packets Table**, click the link [View Table](#), which will show the following table:

View LineChart

Unit: 1 , Port: Port 5 Time Interval 1s OK

Tx Error	Total	Rate(1/Sec)	Max Rate
ExDefer	0	0	0
LateColl	0	0	0
ExColl	0	0	0
SingColl	0	0	0
Coll	0	0	0

Figure 9- 12.Tx Error Analysis window (table)

The following fields may be set or viewed:

Parameter	Description
Time Interval	Select the desired setting between 1s and 60s, where "s" stands for seconds. The default value is one second.
Record Number	Select number of times the Switch will be polled between 20 and 200. The default value is 200.
ExDefer	Counts the number of packets for which the first transmission attempt on a particular interface was delayed because the medium was busy.
LateColl	Counts the number of times that a collision is detected later than 512 bit-times into the transmission of a packet.
ExColl	Excessive Collisions. The number of packets for which transmission failed due to excessive collisions.
SingColl	Single Collision Frames. The number of successfully transmitted packets for which transmission is inhibited by more than one collision.
Coll	An estimate of the total number of collisions on this network segment.
Show/Hide	Check whether or not to display ExDefer, LateColl, ExColl, SingColl, and Coll errors.
Clear	Clicking this button clears all statistics counters on this window.
View Table	Clicking this button instructs the Switch to display a table rather than a line graph.
View Line	Chart Clicking this button instructs the Switch to display a line graph rather than a table.

9-5 Size

The Web Manager allows packets received by the Switch, arranged in six groups and classed by size, to be viewed as either a line graph or a table. Two windows are offered. To select a port to view these statistics for, first select the Switch in the switch stack by using the **Unit** pull-down menu and then select the port by using the **Port** pull down menu. The user may also use the real-time graphic of the Switch and/or switch stack at the top of the web page by simply clicking on a port.

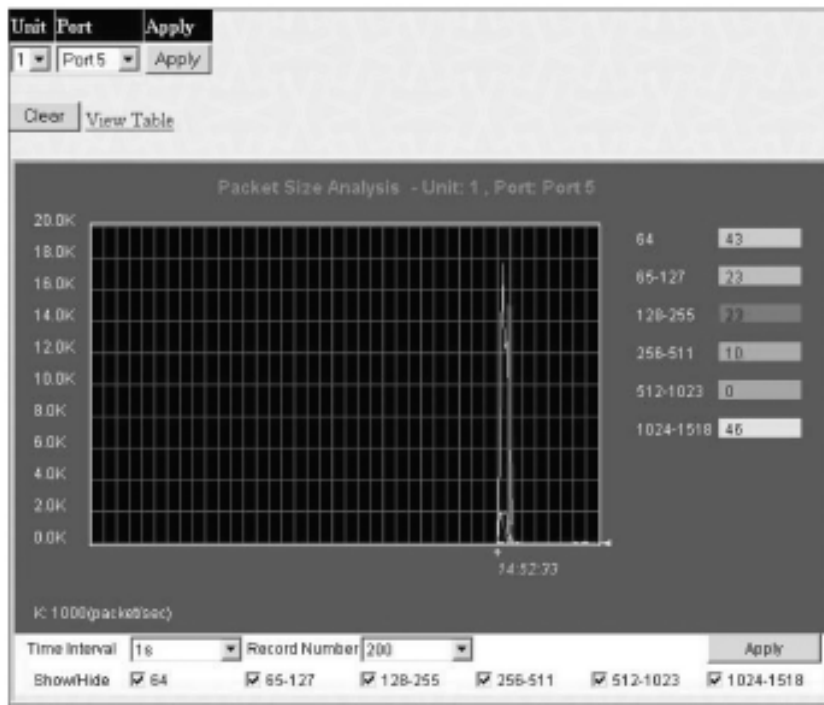

Figure 9- 13. Rx Size Analysis window (line graph)

To view the **Packet Size Analysis Table**, click the link [View Table](#), which will show the following table:

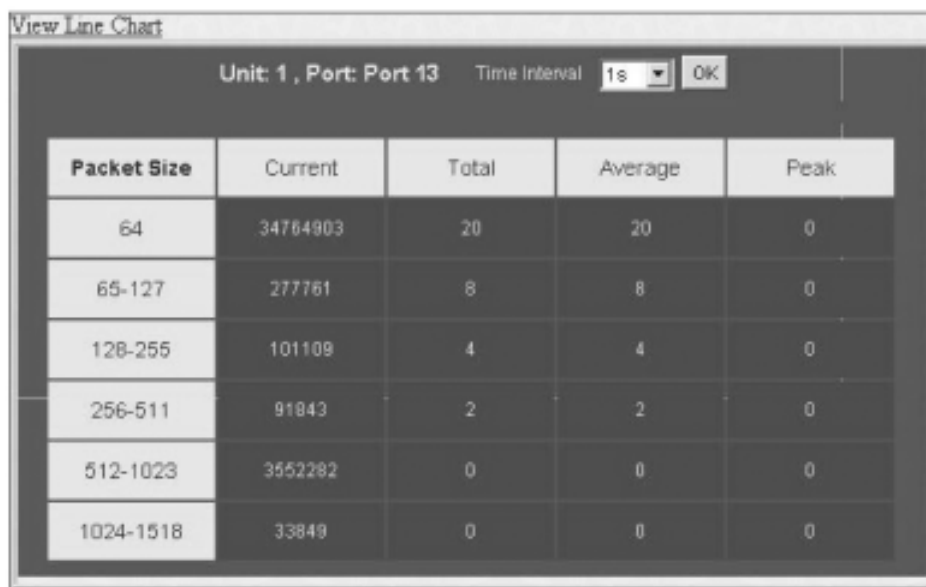

Figure 9- 14. Rx Size Analysis window (table)

The following fields can be set or viewed:

Parameter	Description
Time Interval	Select the desired setting between 1s and 60s, where "s" stands for seconds. The default value is one second.
Record Number	Select number of times the Switch will be polled between 20 and 200. The default value is 200.
64	The total number of packets (including bad packets) received that were 64 octets in length (excluding framing bits but including FCS octets).
65-127	The total number of packets (including bad packets) received that were between 65 and 127 octets in length inclusive (excluding framing bits but including FCS octets).
128-255	The total number of packets (including bad packets) received that were between 128 and 255 octets in length inclusive (excluding framing bits but including FCS octets).
256-511	The total number of packets (including bad packets) received that were between 256 and 511 octets in length inclusive (excluding framing bits but including FCS octets).
512-1023	The total number of packets (including bad packets) received that were between 512 and 1023 octets in length inclusive (excluding framing bits but including FCS octets).
1024-1518	The total number of packets (including bad packets) received that were between 1024 and 1518 octets in length inclusive (excluding framing bits but including FCS octets).
Show/Hide	Check whether or not to display 64, 65-127, 128-255, 256-511, 512-1023, and 1024-1518 packets received
Clear	Clicking this button clears all statistics counters on this window.
View Table	Clicking this button instructs the Switch to display a table rather than a line graph.
View Line Chart	Clicking this button instructs the Switch to display a line graph rather than a table.

Stacking Information

To change a switch's default stacking configuration (for example, the order in the stack), see **Box Information** in the **Configuration** folder.

The number of switches in the switch stack (up to 12 total) are displayed in the upper right-hand corner of your web-browser. The icons are in the same order as their respective Unit numbers, with the Unit 1 switch corresponding to the icon in the upper left-most corner of the icon group.

When the switches are properly interconnected through their optional Stacking Modules, information about the resulting switch stack is displayed under the **Stack Information** link.

To view the stacking information, click on the **Stacking Information** link from the **Monitoring** folder:

Stacking Information							
Box ID	User Set	Type	Exist	Priority	Prom version	Runtime version	HW version
1	Auto	AT-9724TS	exist	16	1.00-B04	0.01	3A1
2	---	USR-NOT-CFG	no				
3	---	USR-NOT-CFG	no				
4	---	USR-NOT-CFG	no				
5	---	USR-NOT-CFG	no				
6	---	USR-NOT-CFG	no				
7	---	USR-NOT-CFG	no				
8	---	USR-NOT-CFG	no				
9	---	USR-NOT-CFG	no				
10	---	USR-NOT-CFG	no				
11	---	USR-NOT-CFG	no				
12	---	USR-NOT-CFG	no				

Topology : DUPLEX_CHAIN
My Box ID : 1
Current state : MASTER
Box count : 1

Figure 9- 15. Stacking Information window

The **Stacking Information** window holds the following information:

Parameter	Description
Box ID	Displays the Switch's order in the stack.
User Set	Box ID can be assigned automatically (Auto), or can be assigned statically. Default is Auto.
Type	Displays the model name of the corresponding switch in a stack.
Exist	Denotes whether a switch does or does not exist in a stack.
Priority	Displays the priority ID of the Switch. The lower the number, the higher the priority. The box (switch) with the lowest priority number in the stack denotes the Master switch. The AT-9724TS will always be the master switch in a Star topology.
Prom Version	Shows the PROM in use for the Switch. This may be different from the values shown in the illustration.
Runtime Version	Shows the firmware version in use for the Switch. This may be different from the values shown in the illustrations.
H/W Version	Shows the hardware version in use for the Switch. This may be different from the values shown in the illustration.
Topology	Show the current topology employed using this Switch.
My Box ID	Displays the Box ID of the Switch currently in use.
Current State	Displays the current stacking state of the Switch, which may be MASTER or SLAVE.
Box Count	Displays the number of switches in the switch stack.

Device Status

The **Device Status** window can be found in the **Monitoring** menu by clicking the **Device Status** link. This window shows the status of the physical attributes of the Switch, including power sources and fans.

Device Status				
ID	Internal Power	External Power	Side Fan	Back Fan
1	Active	Fail	OK	OK

Figure 9- 16. Device Status window

The following fields may be viewed in this window:

Parameter	Description
ID	The Box ID of the Switch in the switch stack.
Internal Power	A read only field denoting the current status of the internal power supply.Active will suggest the mechanism is functioning correctly while Fail will show the mechanism is not functioning correctly.
External Power	A read only field denoting the current status of the external power supply.Active will suggest the mechanism is functioning correctly while Fail will show the mechanism is not functioning correctly.
Side Fan	A read only field denoting if the side fan of the Switch is functioning properly.
Back Fan	A read only field denoting if the back fan of the Switch is functioning properly.

9-6 MAC Address

This allows the Switch's dynamic MAC address forwarding table to be viewed.When the Switch learns an association between a MAC address and a port number, it makes an entry into its forwarding table.These entries are then used to forward packets through the Switch.

To view the MAC Address forwarding table, from the **Monitoring** menu, click the **MAC Address** link:

VID	VLAN Name	MAC Address	Unit	Port	Type
1	default	00-00-48-a8-62-23	1	1	Dynamic
1	default	00-00-55-46-03-00	1	1	Dynamic
1	default	00-00-5e-00-01-5f	1	1	Dynamic
1	default	00-00-5e-00-01-fa	1	1	Dynamic
1	default	00-00-80-c8-09-89	1	1	Dynamic
1	default	00-00-e2-2f-44-ec	1	1	Dynamic
1	default	00-00-e2-4f-57-03	1	1	Dynamic
1	default	00-00-e2-82-7d-90	1	1	Dynamic
1	default	00-00-e2-93-66-06	1	1	Dynamic
1	default	00-01-02-03-04-00	1	1	Dynamic
1	default	00-01-02-03-04-01	1	1	Dynamic
1	default	00-01-02-03-92-27	1	1	Dynamic
1	default	00-01-24-02-45-00	1	1	Dynamic
1	default	00-01-30-12-13-02	1	1	Dynamic
1	default	00-02-06-12-34-56	1	1	Dynamic
1	default	00-03-09-18-10-01	1	1	Dynamic
1	default	00-03-11-04-10-00	1	1	Dynamic
1	default	00-03-47-91-4a-1c	1	1	Dynamic
1	default	00-03-6d-1e-76-79	1	1	Dynamic
1	default	00-04-13-04-03-01	1	1	Dynamic

Total Entries: 332

Figure 9- 17. MAC Address Table

The following fields can be viewed or set:

Parameter	Description
VLAN Name	Enter a VLAN Name for the forwarding table to be browsed by.
MAC Address	Enter a MAC address for the forwarding table to be browsed by.
Unit – Port	Select the switch Unit ID of the switch in the Switch stack and then the port by using the corresponding pull-down menus.
Find	Allows the user to move to a sector of the database corresponding to a user defined port,VLAN, or MAC address.
VID	The VLAN ID of the VLAN the port is a member of.
MAC Address	The MAC address entered into the address table.
Unit	Refers to the Unit of the switch stack that the MAC address was learned from.
Port	The port that the MAC address above corresponds to.
Type	How the Switch discovered the MAC address.The possible entries are Dynamic, Self, and Static.
Next	Click this button to view the next page of the address table.
Clear Dynamic Entry	Clicking this button will clear Dynamic entries learned by the Switch.This may be accomplished by VLAN Name or by Port.
View All Entry	Clicking this button will allow the user to view all entries of the address table.
Clear All Entry	Clicking this button will allow the user to delete all entries of the address table.

9-7 Switch History Log

The Web manager allows the Switch's history log, as compiled by the Switch's management agent, to be viewed.To view the Switch history log, open the Monitoring folder and click the Switch History Log link.

Switch History		
Sequence	Time	Log Text
14	2004-07-05, 10:40:52	Successful login through Web (Username: Anonymous)
13	2004-07-05, 10:40:27	Successful login through Web (Username: Anonymous)
12	2004-07-05, 10:39:44	Unit 1, Configuration saved to flash (Username: Anonymous)
11	2004-07-05, 10:36:35	Unit 1, Successful login through Console (Username: Anonymous)
10	2004-07-05, 10:34:23	Port 1:1 link up, 100Mbps FULL duplex
9	2004-07-05, 10:34:22	Unit 1, System started up
8	2004-06-29, 09:47:40	Unit 1, Firmware upgraded successfully (Username: Anonymous)
7	2004-06-29, 09:46:24	Unit 1, Successful login through Console (Username: Anonymous)
6	2004-06-29, 09:44:48	Port 1:1 link up, 100Mbps FULL duplex
5	2004-06-29, 09:44:48	Unit 1, System started up
4	2004-06-25, 11:58:45	Unit 1, Firmware upgraded successfully (Username: Anonymous)
3	2004-06-25, 11:57:42	Unit 1, Successful login through Console (Username: Anonymous)
2	2004-06-25, 11:57:31	Port 1:1 link up, 100Mbps FULL duplex
1	2004-06-25, 11:57:30	Unit 1, System started up
<input type="button" value="Clear"/>		

Figure 9- 18. Switch History window

The Switch can record event information in its own logs, to designated SNMP trap receiving stations, and to the PC connected to the console manager. Click Next to go to the next page of the **Switch History Log**. Clicking **Clear** will allow the user to clear the **Switch History Log**.

The information is described as follows:

Parameter	Description
Sequence	A counter incremented whenever an entry to the Switch's history log is made. The table displays the last entry (highest sequence number) first.
Time	Displays the time in days, hours, and minutes since the Switch was last restarted.
Log Text	Displays text describing the event that triggered the history log entry.

9-8 IGMP Snooping Group

This window allows the Switch's **IGMP Snooping Table** to be viewed. IGMP Snooping allows the Switch to read the Multicast Group IP address and the corresponding MAC address from IGMP packets that pass through the Switch. The number of IGMP reports that were snooped is displayed in the **Reports** field.

To view the **IGMP Snooping** table, click **IGMP Snooping Group** on the **Monitoring** menu:

VLAN Name :		Search																							
Total Entries : 0																									
IGMP Snooping Group Table																									
VLAN Name	Multicast Group	MAC Address	Reports																						
	0.0.0.0	00:00:00:00:00:00	0																						
Port Member																									
Unit	1	2	3	4	5	6	7	8	9	10	11	12	13	14	15	16	17	18	19	20	21	22	23	24	25
	26	27	28	29	30	31	32	33	34	35	36	37	38	39	40	41	42	43	44	45	46	47	48	49	50

Figure 9- 19. IGMP Snooping Group Table

The user may search the **IGMP Snooping Table** by VLAN Name by entering it in the top left hand corner and clicking **Search**.

The following field can be viewed:

Parameter	Description
VLAN Name	The VLAN Name of the multicast group.
Multicast Group	The IP address of the multicast group.
MAC Address	The MAC address of the multicast group.
Reports	The total number of reports received for this group.
Port Member	These are the ports where the IGMP packets were snooped are displayed.

 **Note:** To configure IGMP snooping for the AT-9724TS, go to the **Configuration** folder and select **IGMP Snooping**. Configuration and other information concerning IGMP snooping may be found in Section 6 of this manual under **IGMP**.

9-9 IGMP Snooping Forwarding

This window will display the current IGMP snooping forwarding table entries currently configured on the Switch. To view the following screen, open the **Monitoring** folder and click the **IGMP Snooping Forwarding** link.

VLAN Name :		Search																							
Total Entries : 0																									
IGMP Snooping Forwarding Table																									
VLAN Name	Source IP	Multicast Group																							
	0.0.0.0	0.0.0.0																							
Port Member																									
Unit	1	2	3	4	5	6	7	8	9	10	11	12	13	14	15	16	17	18	19	20	21	22	23	24	25
	26	27	28	29	30	31	32	33	34	35	36	37	38	39	40	41	42	43	44	45	46	47	48	49	50

Figure 9- 20. IGMP Snooping Forwarding Table

The user may search the **IGMP Snooping Forwarding Table** by VLAN Name using the top left hand corner **Search**.

The following fields can be viewed:

Parameter	Description
VLAN Name	The VLAN Name of the multicast group.
Source IP	The Source IP address of the multicast group.
Multicast Group	The IP address of the multicast group.
Port Map	These are the ports where the IP multicast packets are being forwarded to.

9-10 Browse Router Port

This displays which of the Switch's ports are currently configured as router ports. A router port configured by a user (using the console or Web-based management interfaces) is displayed as a static router port, designated by **S**. A router port that is dynamically configured by the Switch is designated by **D**.

Browse Router Port																									
VLAN ID	VLAN Name																								
1	default																								
Unit	Ports																								
	1	2	3	4	5	6	7	8	9	10	11	12	13	14	15	16	17	18	19	20	21	22	23	24	25
1	26	27	28	29	30	31	32	33	34	35	36	37	38	39	40	41	42	43	44	45	46	47	48	49	50

Figure 9- 21. Browse Router Port window

9-11 Port Access Control

The following screens are used to monitor 802.1x statistics of the Switch, on a per port basis. To view the **Port Access Control** screens, open the monitoring folder and click the **Port Access Control** folder. There are six screens to monitor.

Note: 802.1X must be enabled under **Configuration > Advanced Settings**.

Authenticator State

The following section describes the 802.1X Status on the Switch. To view the Authenticator State, click **Monitoring > Port Access Control > Authenticator State**.

Port	Auth_Prot_State	Bypass_State	PortStatus
1	Forcible	Success	Authorized
2	Forcible	Success	Authorized
3	Forcible	Success	Authorized
4	Forcible	Success	Authorized
5	Forcible	Success	Authorized
6	Forcible	Success	Authorized
7	Forcible	Success	Authorized
8	Forcible	Success	Authorized
9	Forcible	Success	Authorized
10	Forcible	Success	Authorized
11	Forcible	Success	Authorized
12	Forcible	Success	Authorized
13	Forcible	Success	Authorized
14	Forcible	Success	Authorized
15	Forcible	Success	Authorized
16	Forcible	Success	Authorized
17	Forcible	Success	Authorized
18	Forcible	Success	Authorized
19	Forcible	Success	Authorized
20	Forcible	Success	Authorized
21	Forcible	Success	Authorized
22	Forcible	Success	Authorized
23	Forcible	Success	Authorized
24	Forcible	Success	Authorized

Figure 9- 22. Authenticator State window – Port Based 802.1x

Unit	Port	Apply
1	Port 1	Apply

Show Authenticator State of Unit 1 Port 1 Time Interval: 1s OK

Index	MAC Address	Auth PAE State	Backend State	Port Status
1	N/A	N/A	N/A	N/A
2	N/A	N/A	N/A	N/A
3	N/A	N/A	N/A	N/A
4	N/A	N/A	N/A	N/A
5	N/A	N/A	N/A	N/A
6	N/A	N/A	N/A	N/A
7	N/A	N/A	N/A	N/A
8	N/A	N/A	N/A	N/A
9	N/A	N/A	N/A	N/A
10	N/A	N/A	N/A	N/A
11	N/A	N/A	N/A	N/A
12	N/A	N/A	N/A	N/A
13	N/A	N/A	N/A	N/A
14	N/A	N/A	N/A	N/A
15	N/A	N/A	N/A	N/A
16	N/A	N/A	N/A	N/A

Figure 9- 23.Authenticator State – MAC Based 802.IX

This window displays the **Authenticator State** for individual ports on a selected device. To select unit within the switch stack, use the pull-down menu at the top of the window and click **Apply**. A polling interval between 1 and 60 seconds can be set using the drop-down menu at the top of the window and clicking **OK**.

The information on this window is described as follows:

Parameter	Description
Auth PAE State	The Authenticator PAE State value can be: <i>Initialize, Disconnected, Connecting, Authenticating, Authenticated, Aborting, Held, Force_Auth, Force_Unauth, or N/A</i> . <i>N/A</i> (Not Available) indicates that the port's authenticator capability is disabled.
Backend State	The Backend Authentication State can be <i>Request, Response, Success, Fail, Timeout, Idle, Initialize, or N/A</i> . <i>N/A</i> (Not Available) indicates that the port's authenticator capability is disabled.
Port Status	Controlled Port Status can be <i>Authorized, Unauthorized, or N/A</i> .
MAC Address	Displays the MAC address of the Authenticator. Up to 16 MAC address can be implemented for MAC based 802.Ix.

Authenticator Statistics

This table contains the statistics objects for the Authenticator PAE associated with each port. An entry appears in this table for each port that supports the Authenticator function. To view the Authenticator Statistics, click **Monitoring > Port Access Control > Authenticator Statistics**.

Port	Frames Rx	Frames Tx	Rx Start	Tx ReqId	Rx LogOff	Tx Req	Rx RespId	Rx Resp	Rx Invalid	Rx Error	Last Version	Last Source
1	0	0	0	0	0	0	0	0	0	0	0	00:00:00:00:00:00
2	0	0	0	0	0	0	0	0	0	0	0	00:00:00:00:00:00
3	0	0	0	0	0	0	0	0	0	0	0	00:00:00:00:00:00
4	0	0	0	0	0	0	0	0	0	0	0	00:00:00:00:00:00
5	0	0	0	0	0	0	0	0	0	0	0	00:00:00:00:00:00
6	0	0	0	0	0	0	0	0	0	0	0	00:00:00:00:00:00
7	0	0	0	0	0	0	0	0	0	0	0	00:00:00:00:00:00
8	0	0	0	0	0	0	0	0	0	0	0	00:00:00:00:00:00
9	0	0	0	0	0	0	0	0	0	0	0	00:00:00:00:00:00
10	0	0	0	0	0	0	0	0	0	0	0	00:00:00:00:00:00
11	0	0	0	0	0	0	0	0	0	0	0	00:00:00:00:00:00
12	0	0	0	0	0	0	0	0	0	0	0	00:00:00:00:00:00
13	0	0	0	0	0	0	0	0	0	0	0	00:00:00:00:00:00
14	0	0	0	0	0	0	0	0	0	0	0	00:00:00:00:00:00
15	0	0	0	0	0	0	0	0	0	0	0	00:00:00:00:00:00
16	0	0	0	0	0	0	0	0	0	0	0	00:00:00:00:00:00
17	0	0	0	0	0	0	0	0	0	0	0	00:00:00:00:00:00
18	0	0	0	0	0	0	0	0	0	0	0	00:00:00:00:00:00
19	0	0	0	0	0	0	0	0	0	0	0	00:00:00:00:00:00
20	0	0	0	0	0	0	0	0	0	0	0	00:00:00:00:00:00
21	0	0	0	0	0	0	0	0	0	0	0	00:00:00:00:00:00
22	0	0	0	0	0	0	0	0	0	0	0	00:00:00:00:00:00
23	0	0	0	0	0	0	0	0	0	0	0	00:00:00:00:00:00
24	0	0	0	0	0	0	0	0	0	0	0	00:00:00:00:00:00

Figure 9- 24.Authenticator Statistics window

The user can specify a switch in a switch stack using that switch's Unit ID by using the pull down menu in the top left hand corner.The user may also select the desired time interval to update the statistics, between 1s and 60s, where "s" stands for seconds.The default value is one second.

The following fields can be viewed:

Parameter	Description
Port	The identification number assigned to the Port by the System in which the Port resides.
Frames Rx	The number of valid EAPOL frames that have been received by this Authenticator.
Frames Tx	The number of EAPOL frames that have been transmitted by this Authenticator.
Rx Start	The number of EAPOL Start frames that have been received by this Authenticator.
TxReqId	The number of EAP Req/Id frames that have been transmitted by this Authenticator.
RxLogOff	The number of EAPOL Logoff frames that have been received by this Authenticator.
Tx Req	The number of EAP Request frames (other than Rq/Id frames) that have been transmitted by this Authenticator.
Rx RespId	The number of EAP Resp/Id frames that have been received by this Authenticator.
Rx Resp	The number of valid EAP Response frames (other than Resp/Id frames) that have been received by this Authenticator.
Rx Invalid	The number of EAPOL frames that have been received by this Authenticator in which the frame type is not recognized.
Rx Error	The number of EAPOL frames that have been received by this Authenticator in which the Packet Body Length field is invalid.
Last Version	The protocol version number carried in the most recently received EAPOL frame.
Last Source	The source MAC address carried in the most recently received EAPOL frame.

Authenticator Session Statistics

This table contains the session statistics objects for the Authenticator PAE associated with each port. An entry appears in this table for each port that supports the Authenticator function. To view the **Authenticator Session Statistics**, click **Monitoring > Port Access Control > Authenticator Session Statistics**.

Port	Octets Rx	Octets Tx	Frames Rx	Frames Tx	ID	Authentic Method	Time	Terminate Cause	Username
1	0	0	0	0	NA	Remote Authentic Server	0	Supplicant Logoff	NA
2	0	0	0	0	NA	Remote Authentic Server	0	Supplicant Logoff	NA
3	0	0	0	0	NA	Remote Authentic Server	0	Supplicant Logoff	NA
4	0	0	0	0	NA	Remote Authentic Server	0	Supplicant Logoff	NA
5	0	0	0	0	NA	Remote Authentic Server	0	Supplicant Logoff	NA
6	0	0	0	0	NA	Remote Authentic Server	0	Supplicant Logoff	NA
7	0	0	0	0	NA	Remote Authentic Server	0	Supplicant Logoff	NA
8	0	0	0	0	NA	Remote Authentic Server	0	Supplicant Logoff	NA
9	0	0	0	0	NA	Remote Authentic Server	0	Supplicant Logoff	NA
10	0	0	0	0	NA	Remote Authentic Server	0	Supplicant Logoff	NA
11	0	0	0	0	NA	Remote Authentic Server	0	Supplicant Logoff	NA
12	0	0	0	0	NA	Remote Authentic Server	0	Supplicant Logoff	NA
13	0	0	0	0	NA	Remote Authentic Server	0	Supplicant Logoff	NA
14	0	0	0	0	NA	Remote Authentic Server	0	Supplicant Logoff	NA
15	0	0	0	0	NA	Remote Authentic Server	0	Supplicant Logoff	NA
16	0	0	0	0	NA	Remote Authentic Server	0	Supplicant Logoff	NA
17	0	0	0	0	NA	Remote Authentic Server	0	Supplicant Logoff	NA
18	0	0	0	0	NA	Remote Authentic Server	0	Supplicant Logoff	NA
19	0	0	0	0	NA	Remote Authentic Server	0	Supplicant Logoff	NA
20	0	0	0	0	NA	Remote Authentic Server	0	Supplicant Logoff	NA
21	0	0	0	0	NA	Remote Authentic Server	0	Supplicant Logoff	NA
22	0	0	0	0	NA	Remote Authentic Server	0	Supplicant Logoff	NA
23	0	0	0	0	NA	Remote Authentic Server	0	Supplicant Logoff	NA
24	0	0	0	0	NA	Remote Authentic Server	0	Supplicant Logoff	NA

Figure 9- 25. Authenticator Session Statistics window

The user can specify a switch in a switch stack using that switch's Unit ID by using the pull down menu in the top left hand corner. The user may also select the desired time interval to update the statistics, between 1s and 60s, where "s" stands for seconds. The default value is one second.

The following fields can be viewed:

Parameter	Description
Port	The identification number assigned to the Port by the System in which the Port resides.
Octets Rx	The number of octets received in user data frames on this port during the session.
Octets Tx	The number of octets transmitted in user data frames on this port during the session.
Frames Rx	The number of user data frames received on this port during the session.
Frames Tx	The number of user data frames transmitted on this port during the session.
ID	A unique identifier for the session, in the form of a printable ASCII string of at least three characters.
Authentic Method	The authentication method used to establish the session. Valid Authentic Methods include: <i>Remote Authentic Server</i> – The Authentication Server is external to the Authenticator's System. <i>Local Authentic Server</i> – The Authentication Server is located within the Authenticator's System.
Time	The duration of the session in seconds.
Terminate Cause	The reason for the session termination. There are eight possible reasons for termination. <ol style="list-style-type: none"> 1. Supplicant Logoff 2. Port Failure 3. Supplicant Restart 4. Reauthentication Failure 5. AuthControlledPortControl set to ForceUnauthorized 6. Port re-initialization 7. Port Administratively Disabled 8. Not Terminated Yet
UserName	The User-Name representing the identity of the Supplicant PAE.

Authenticator Diagnostics

This table contains the diagnostic information regarding the operation of the Authenticator associated with each port. An entry appears in this table for each port that supports the Authenticator function. To view the **Authenticator Diagnostics**, click **Monitoring > Port Access Control > Authenticator Diagnostics**.

Figure 9- 26. Authenticator Diagnostics window

The user can specify a switch in a switch stack using that switch's **Unit ID** by using the pull down menu in the top left hand corner. The user may also select the desired time interval to update the statistics, between 1s and 60s, where "s" stands for seconds. The default value is one second.

The following fields can be viewed:

Parameter	Description
Port	The identification number assigned to the Port by the System in which the Port resides.
Connect Enter	Counts the number of times that the state machine transitions to the CONNECTING state from any other state.
Connect LogOff	Counts the number of times that the state machine transitions from CONNECTING to DISCONNECTED as a result of receiving an EAPOL-Logoff message.
Auth Enter	Counts the number of times that the state machine transitions from CONNECTING to AUTHENTICATING, as a result of an EAP-Response/Identity message being received from the Supplicant.
Auth Success	Counts the number of times that the state machine transitions from AUTHENTICATING to AUTHENTICATED, as a result of the Backend Authentication state machine indicating successful authentication of the Supplicant (authSuccess = TRUE).
Auth Timeout	Counts the number of times that the state machine transitions from AUTHENTICATING to ABORTING, as a result of the Backend Authentication state machine indicating authentication timeout (authTimeout = TRUE).
Auth Fail	Counts the number of times that the state machine transitions from AUTHENTICATING to HELD, as a result of the Backend Authentication state machine indicating authentication failure (authFail = TRUE).
Auth Reauth	Counts the number of times that the state machine transitions from AUTHENTICATING to ABORTING, as a result of a reauthentication request (reAuthenticate = TRUE).
Auth Start	Counts the number of times that the state machine transitions from AUTHENTICATING to ABORTING, as a result of an EAPOL-Start message being received from the Supplicant.
Auth LogOff	Counts the number of times that the state machine transitions from AUTHENTICATING to ABORTING, as a result of an EAPOL-Logoff message being received from the Supplicant.
Authed Reauth	Counts the number of times that the state machine transitions from AUTHENTICATED to CONNECTING, as a result of a reauthentication request (reAuthenticate = TRUE).

Authenticated Start	Counts the number of times that the state machine transitions from AUTHENTICATED to CONNECTING, as a result of an EAPOL-Start message being received from the Supplicant.
Authenticated LogOff	Counts the number of times that the state machine transitions from AUTHENTICATED to DISCONNECTED, as a result of an EAPOL-Logoff message being received from the Supplicant.
Responses	Counts the number of times that the state machine sends an initial Access-Request packet to the Authentication server (i.e., executes sendRespToServer on entry to the RESPONSE state). Indicates that the Authenticator attempted communication with the Authentication Server.
AccessChallenges	Counts the number of times that the state machine receives an initial Access-Challenge packet from the Authentication server (i.e., aReq becomes TRUE, causing exit from the RESPONSE state). Indicates that the Authentication Server has communication with the Authenticator.
OtherReqToSupp	Counts the number of times that the state machine sends an EAP-Request packet (other than an Identity, Notification, Failure, or Success message) to the Supplicant (i.e., executes txReq on entry to the REQUEST state). Indicates that the Authenticator chose an EAP-method.
NonNakRespFromSup	Counts the number of times that the state machine receives a response from the Supplicant to an initial EAP-Request, and the response is something other than EAP-NAK (i.e., rxResp becomes TRUE, causing the state machine to transition from REQUEST to RESPONSE, and the response is not an EAP-NAK). Indicates that the Supplicant can respond to the Authenticator's chosen EAP-method.
Bac Auth Success	Counts the number of times that the state machine receives an Accept message from the Authentication Server (i.e., aSuccess becomes TRUE, causing a transition from RESPONSE to SUCCESS). Indicates that the Supplicant has successfully authenticated to the Authentication Server.
Bac Auth Fail	Counts the number of times that the state machine receives a Reject message from the Authentication Server (i.e., aFail becomes TRUE, causing a transition from RESPONSE to FAIL). Indicates that the Supplicant has not authenticated to the Authentication Server.

RADIUS Authentication

This table contains information concerning the activity of the RADIUS authentication client on the client side of the RADIUS authentication protocol. It has one row for each RADIUS authentication server that the client shares a secret with. To view the **RADIUS Authentication**, click **Monitoring > Port Access Control > RADIUS Authentication**.

The screenshot shows a web interface window titled 'RADIUS Authentication of Jun 1'. It contains a table with 15 columns: ServerIndex, InvalidServerAddr, Identifier, AuthServerAddr, ServerPortNumber, RoundTripTime, AccessRequests, AccessRetrans, AccessAccepts, AccessRejects, AccessChallenges, AccessResponses, RejectedAuth, InvalidAuth, and FailedDrop. The table has three rows of data. A 'Clear' button is located in the top left corner of the window.

Figure 9- 27. RADIUS Authentication window

The user may also select the desired time interval to update the statistics, between 1s and 60s, where “s” stands for seconds. The default value is one second. To clear the current statistics shown, click the **Clear** button in the top left hand corner.

The following fields can be viewed:

Parameter	Description
ServerIndex	The identification number assigned to each RADIUS Authentication server that the client shares a secret with.
InvalidServerAddr	The number of RADIUS Access-Response packets received from unknown addresses.
Identifier	The NAS-Identifier of the RADIUS authentication client. (This is not necessarily the same as sysName in MIB II.)
AuthServerAddr	The (conceptual) table listing the RADIUS authentication servers with which the client shares a secret.
ServerPortNumber	The UDP port the client is using to send requests to this server.
RoundTripTime	The time interval (in hundredths of a second) between the most recent Access-Reply/Access-Challenge and the Access-Request that matched it from this RADIUS authentication server.
AccessRequests	The number of RADIUS Access-Request packets sent to this server. This does not include retransmissions.
AccessRetrans	The number of RADIUS Access-Request packets retransmitted to this RADIUS authentication server.
AccessAccepts	The number of RADIUS Access-Accept packets (valid or invalid) received from this server.
AccessRejects	The number of RADIUS Access-Reject packets (valid or invalid) received from this server.
AccessChallenges	The number of RADIUS Access-Challenge packets (valid or invalid) received from this server.
AccessResponses	The number of malformed RADIUS Access-Response packets received from this server. Malformed packets include packets with an invalid length. Bad authenticators or Signature attributes or known types are not included as malformed access responses.

BadAuthenticators	The number of RADIUS Access-Response packets containing invalid authenticators or Signature attributes received from this server.
PendingRequests	The number of RADIUS Access-Request packets destined for this server that have not yet timed out or received a response. This variable is incremented when an Access-Request is sent and decremented due to receipt of an Access-Accept, Access-Reject or Access-Challenge, a timeout or retransmission.
Timeouts	The number of authentication timeouts to this server. After a timeout the client may retry to the same server, send to a different server, or give up. A retry to the same server is counted as a retransmit as well as a timeout. A send to a different server is counted as a Request as well as a timeout.
UnknownTypes	The number of RADIUS packets of unknown type which were received from this server on the authentication port
PacketsDropped	The number of RADIUS packets of which were received from this server on the authentication port and dropped for some other reason.

RADIUS Accounting

This window shows managed objects used for managing RADIUS accounting clients, and the current statistics associated with them. It has one row for each RADIUS authentication server that the client shares a secret with. To view the **RADIUS Accounting**, click **Monitoring > Port Access Control > RADIUS Accounting**.

ServerIndex	InvalidServerAddr	Identifier	ServerAddress	ServerPortNumber	RoundTripTime	Requests	Retransmissions	Responses	MalformedResponses	BadAuthenticators	PendingRequests	Timeouts	UnknownTypes	PacketsDropped
1	NA	NA	NA	NA	NA	NA	NA	NA	NA	NA	NA	NA	NA	NA
2	NA	NA	NA	NA	NA	NA	NA	NA	NA	NA	NA	NA	NA	NA
3	NA	NA	NA	NA	NA	NA	NA	NA	NA	NA	NA	NA	NA	NA

Figure 9- 28. RADIUS Accounting window

The user may also select the desired time interval to update the statistics, between 1s and 60s, where “s” stands for seconds. The default value is one second. To clear the current statistics shown, click the **Clear** button in the top left hand corner.

The following fields can be viewed:

Parameter	Description
ServerIndex	The identification number assigned to each RADIUS Accounting server that the client shares a secret with.
InvalidServerAddr	The number of RADIUS Accounting-Response packets received from unknown addresses.
Identifier	The NAS-Identifier of the RADIUS accounting client. (This is not necessarily the same as sysName in MIB II.)
ServerAddress	The (conceptual) table listing the RADIUS accounting servers with which the client shares a secret.
ServerPortNumber	The UDP port the client is using to send requests to this server.
RoundTripTime	The time interval between the most recent Accounting-Response and the Accounting-Request that matched it from this RADIUS accounting server.
Requests	The number of RADIUS Accounting-Request packets sent. This does not include retransmissions.
Retransmissions	The number of RADIUS Accounting-Request packets retransmitted to this RADIUS accounting server. Retransmissions include retries where the Identifier and Acct-Delay have been updated, as well as those in which they remain the same.
Responses	The number of RADIUS packets received on the accounting port from this server.
MalformedResponses	The number of malformed RADIUS Accounting-Response packets received from this server. Malformed packets include packets with an invalid length. Bad authenticators and unknown types are not included as malformed accounting responses.
BadAuthenticators	The number of RADIUS Accounting-Response packets, which contained invalid authenticators, received from this server.
PendingRequests	The number of RADIUS Accounting-Request packets sent to this server that have not yet timed out or received a response. This variable is incremented when an Accounting-Request is sent and decremented due to receipt of an Accounting-Response, a timeout or a retransmission.
Timeouts	The number of accounting timeouts to this server. After a timeout the client may retry to the same server, send to a different server, or give up. A retry to the same server is counted as a retransmit as well as a timeout. A send to a different server is counted as an Accounting-Request as well as a timeout.
UnknownTypes	The number of RADIUS packets of unknown type which were received from this server on the accounting port.
PacketsDropped	The number of RADIUS packets, which were received from this server on the accounting port and dropped for some other reason.

 **Note:** To configure 802.1x features for the AT-9724TS, go to the **Configuration** folder and select **Port Access Entity. Configuration** and other information concerning 802.1x may be found in Section 6 of this manual under **Port Access Entity**.

9-12 Layer 3 Feature

This folder in the **Monitoring** section will display information concerning settings configured in **Layer 3 IP Networking** of the **Configuration** folder. These settings and parameters have been previously described in **Chapter 6** of this manual, under **Layer 3 IP Networking**.

Browse IP Address

The **Browse IP Address** window may be found in the **Monitoring** menu in the **Layer 3 Feature** folder. The **Browse IP Address** window is a read only screen where the user may view IP addresses discovered by the Switch. To search a specific IP address, enter it into the field labelled **IP Address** at the top of the screen and click **Find** to begin your search.



Interface	IP Address	Port	Learned
System	10.0.0.1	1:19	Dynamic
System	10.0.0.121	1:19	Dynamic
System	10.0.1.100	1:19	Dynamic
System	10.0.25.1	1:19	Dynamic
System	10.0.34.1	1:19	Dynamic
System	10.0.46.1	1:19	Dynamic
System	10.0.51.1	1:19	Dynamic
System	10.0.58.4	1:19	Dynamic
System	10.0.85.168	1:19	Dynamic
System	10.1.1.1	1:19	Dynamic
System	10.1.1.4	1:19	Dynamic
System	10.1.1.80	1:19	Dynamic
System	10.1.1.101	1:19	Dynamic
System	10.1.1.102	1:19	Dynamic
System	10.1.1.103	1:19	Dynamic
System	10.1.1.163	1:19	Dynamic
System	10.1.1.164	1:19	Dynamic
System	10.1.1.166	1:19	Dynamic
System	10.1.1.167	1:19	Dynamic
System	10.1.1.168	1:19	Dynamic

Figure 9- 29. Browse IP Address Table

Browse Routing Table

The **Browse Routing Table** window may be found in the **Monitoring** menu in the **Layer 3 Feature** folder. This screen shows the current IP routing table of the Switch. To find a specific IP route, enter an IP address into the **Destination Address** field along with a proper subnet mask into the **Mask** field and click **Find**.

Destination Address	<input type="text" value="0.0.0.0"/>				
Mask	<input type="text" value="0.0.0.0"/>	<input type="button" value="Find"/>			
Routing Table					
IP Address	Netmask	Gateway	Interface	Cost	Protocol
10.0.0.0	255.0.0.0	0.0.0.0	System	1	Local
Total Entries: 1					

Figure 9- 30. Browse Routing Table window

Browse ARP Table

The **Browse ARP Table** window may be found in the **Monitoring** menu in the **Layer 3 Feature** folder. This window will show current ARP entries on the Switch. To search a specific ARP entry, enter an interface name into the **Interface Name** or an **IP address** and click **Find**. To clear the ARP Table, click **Clear All**.

Interface Name	<input type="text"/>		
IP Address	<input type="text" value="0.0.0.0"/>	<input type="button" value="Find"/> <input type="button" value="Clear All"/>	
ARP Table			
Interface Name	IP Address	Mac Address	Type
System	10.0.0.0	ff-ff-ff-ff-ff	Local/Broadcast
System	10.0.0.1	00-04-23-5a-34-df	Dynamic
System	10.0.0.121	00-a0-c5-15-3b-6e	Dynamic
System	10.0.1.100	00-50-ba-f4-96-9a	Dynamic
System	10.0.25.1	00-d0-59-a9-2a-c4	Dynamic
System	10.0.34.1	00-0c-6e-6e-14-13	Dynamic
System	10.0.46.1	00-80-c8-91-15-eb	Dynamic
System	10.0.51.1	00-80-c8-4c-69-fb	Dynamic
System	10.0.58.4	00-0c-6e-43-13-ae	Dynamic
System	10.0.85.168	00-50-ba-11-08-e4	Dynamic
System	10.1.1.1	00-05-5d-00-00-00	Dynamic
System	10.1.1.4	00-ff-7f-47-d9-42	Dynamic
System	10.1.1.80	00-05-5d-95-bf-9b	Dynamic
System	10.1.1.101	00-50-ba-15-48-56	Dynamic
System	10.1.1.102	00-50-ba-97-d7-c0	Dynamic
System	10.1.1.103	00-50-ba-97-d7-c9	Dynamic
System	10.1.1.163	00-50-ba-70-e4-55	Dynamic
System	10.1.1.164	00-50-ba-70-e4-65	Dynamic
System	10.1.1.166	00-50-ba-70-e4-58	Dynamic
System	10.1.1.167	00-50-ba-70-e4-45	Dynamic
Total Entries: 730			
<input type="button" value="Next"/>			

Figure 9- 31. Browse ARP Table window

Browse IP Multicast Forwarding Table

The **Browse IP Multicast Forwarding Table** window may be found in the **Monitoring** menu in the **Layer 3 Feature** folder. This window will show current IP multicasting information on the Switch. To search a specific entry, enter a multicast group IP address into the **Multicast Group** field or a **Source IP** address and click **Find**.

Multicast Group	<input type="text" value="0.0.0.0"/>	<input type="text"/>	<input type="text"/>	<input type="text"/>	<input type="text"/>
Source IP	<input type="text" value="0.0.0.0"/>	<input type="text"/>	<input type="text"/>	<input type="text"/>	<input type="text"/>
<input type="button" value="Find"/>					
IP Multicast Forwarding Table					
Multicast Group	Source IP Address	Source Mask	Upstream Neighbor	Expire Time	Protocol
Total Entries: 0					

Figure 9- 32. Browse IP Multicast Forwarding Table

Browse IGMP Group Table

The **Browse IGMP Group Table** window may be found in the **Monitoring** menu in the **Layer 3 Feature** folder. This window will show current IGMP group entries on the Switch. To search a specific IGMP group entry, enter an interface name into the **Interface Name** field or a **Multicast Group** IP address and click **Find**.

Interface Name	<input type="text"/>	<input type="text"/>	<input type="text"/>	<input type="text"/>	<input type="text"/>
Multicast Group	<input type="text" value="0.0.0.0"/>	<input type="text"/>	<input type="text"/>	<input type="text"/>	<input type="text"/>
<input type="button" value="Find"/>					
IGMP Group Table					
Interface Name	Multicast Group	Last Reporter IP	IP Querier	IP Expire	
Total Entries: 0					

Figure 9- 33. Browse IGMP Group Table

OSPF Monitoring

This section offers windows regarding OSPF (Open Shortest Path First) information on the Switch, including the **OSPF LSDB Table**, **OSPF Neighbor Table** and the **OSPF Virtual Neighbor Table**. To view these tables, open the **Monitoring** folder and click **OSPF Monitoring**.

Browse OSPF LSDB Table

This table can be found in the **OSPF Monitoring** folder by clicking on the **Browse OSPF LSDB Table** link. The **OSPF Link-State Database Table** displays the current link-state database in use by the OSPF routing protocol on a per-OSPF area basis.

Search Type	<input type="text" value="ALL"/>	<input type="text"/>	<input type="text"/>	<input type="text"/>	<input type="text"/>
Area ID	<input type="text" value="0.0.0.0"/>	<input type="text"/>	<input type="text"/>	<input type="text"/>	<input type="text"/>
Advertise Router ID	<input type="text" value="0.0.0.0"/>	<input type="text"/>	<input type="text"/>	<input type="text"/>	<input type="text"/>
LSDB Type	<input type="text" value="RtrLink"/>	<input type="text"/>	<input type="text"/>	<input type="text"/>	<input type="text"/>
<input type="button" value="Find"/>					
OSPF LSDB Table					
Area ID	LSDB Type	Adv. Router ID	Link State ID	Cost	Sequence

Figure 9- 34. Browse OSPF LSDB Table

The user may search for a specific entry by entering the following information into the fields at the top of the screen:

To browse the **OSPF LSDB Table**, you first must select which browse method you want to use in the **Search Type** field. The choices are *All*, *Area ID*, *Advertise Router ID*, *LSDB*, *Area ID & Advertise Router ID*, *Area ID & LSDB*, and *Advertise Router ID & LSDB*.

If *Area ID* is selected as the browse method, you must enter the IP address in the **Area ID** field, and then click *Find*.

If *Adv. Router ID* is selected, you must enter the IP address in the **Advertisement Router ID** field, and then click *Find*.

If *LSDB* is selected, you must select the type of link state (*RtrLink*, *NetLink*, *Summary*, *ASSummary* and *ASExtLink*) in the **LSDB Type** field, and then click *Find*.

The following fields are displayed in the **OSPF LSDB Table**:

Parameter	Description										
Area ID	Allows the entry of an OSPF Area ID. This Area ID will then be used to search the table, and display an entry – if there is one.										
LSDB Type	Displays which one of eight types of link advertisements by which the current link was discovered by the Switch: All, Router link (<i>RTRLink</i>), Network link (<i>NETLink</i>), Summary link (<i>Summary</i>), Autonomous System link (<i>ASSummary</i>), Autonomous System external link (<i>ASExternal</i>), MCGLink (<i>Multicast Group</i>), and NSSA (<i>Not So Stubby Area</i>)										
Adv. Router ID	Displays the Advertising Router's ID.										
Link State	ID This field identifies the portion of the Internet environment that is being described by the advertisement. The contents of this field depend on the advertisement's LS type. <table border="1" style="margin-left: 20px;"> <thead> <tr> <th>LS Type</th> <th>LinkState ID</th> </tr> </thead> <tbody> <tr> <td>1</td> <td>The originating router's Router ID.</td> </tr> <tr> <td>2</td> <td>The IP interface address of the network's Designated Router.</td> </tr> <tr> <td>3</td> <td>The destination network's IP address.</td> </tr> <tr> <td>4</td> <td>The Router ID of the described AS boundary router.</td> </tr> </tbody> </table>	LS Type	LinkState ID	1	The originating router's Router ID.	2	The IP interface address of the network's Designated Router.	3	The destination network's IP address.	4	The Router ID of the described AS boundary router.
LS Type	LinkState ID										
1	The originating router's Router ID.										
2	The IP interface address of the network's Designated Router.										
3	The destination network's IP address.										
4	The Router ID of the described AS boundary router.										
Cost	Displays the cost of the table entry.										
Sequence	Displays a sequence number corresponding to number of times the current link has been advertised as changed.										

Browse OSPF Neighbor Table

This table can be found in the **OSPF Monitoring** folder by clicking on the **Browse OSPF Neighbor Table** link. Routers that are connected to the same area or segment become neighbors in that area. Neighbors are elected via the Hello protocol. IP multicast is used to send out Hello packets to other routers on the segment. Routers become neighbors when they see themselves listed in a Hello packet sent by another router on the same segment. In this way, two-way communication is guaranteed to be possible between any two neighbor routers. This table displays OSPF neighbors of the Switch.

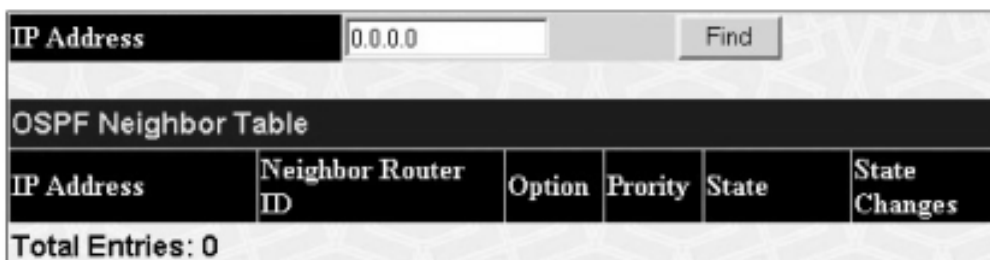

Figure 9- 35. OSPF Neighbor Table

To search for OSPF neighbors, enter an IP address and click **Find**. Valid OSPF neighbors will appear in the **OSPF Neighbor Table** below.

OSPF Virtual Neighbor

This table can be found in the **OSPF Monitoring** folder by clicking on the **Browse OSPF Virtual Neighbor** link. This table displays a list of **Virtual OSPF Neighbors** of the Switch. The user may choose specifically search a virtual neighbor by using one of the two search options at the top of the screen, which are:

Parameter	Description
Transit Area ID	Allows the entry of an OSPF Area ID – previously defined on the Switch – that allows a remote area to communicate with the backbone (area 0). A Transit Area cannot be a Stub Area or a Backbone Area.
Neighbor ID	The OSPF router ID for the remote router. This IP address uniquely identifies the remote area's Area Border Router.

Transit Area ID	<input type="text" value="0.0.0.0"/>				
Neighbor ID	<input type="text" value="0.0.0.0"/>		<input type="button" value="Browse"/>		
OSPF Virtual Neighbor Table					
Transit Area ID	Virtual Neighbor ID	IP Address	Virtual Neighbor Option	Virtual Neighbor State	Events
There is no entry found.					
Total Entries: 0					

Figure 9- 36 .OSPF Virtual Neighbor Table

DVMRP Monitoring

This menu allows the **DVMRP** (Distance-Vector Multicast Routing Protocol) to be monitored for each IP interface defined on the Switch. This folder, found in the **Monitoring** folder, offers 3 screens for monitoring: **Browse DVMRP Routing Table**, **Browse DVMRP Neighbor Address Table** and **Browse DVMRP Routing Next Hop Table**. Information on DVMRP and its features in relation to the AT-9724TS can be found in Chapter 6, under **IP Multicast Routing Protocol**.

Browse DVMRP Routing Table

Multicast routing information is gathered and stored by DVMRP in the **DVMRP Routing Table**, which may be found in the **Monitoring** folder under **Browse DVMRP Monitoring**. This table contains one row for each port in a DVMRP mode. Each routing entry contains information about the source and multicast group, and incoming and outgoing interfaces. You may define your search by entering a **Source IP Address** and its subnet mask into the fields at the top of the page.

Source IP Address	<input type="text" value="0.0.0.0"/>					
Source Mask	<input type="text" value="0.0.0.0"/>		<input type="button" value="Browse"/>			
DVMRP Routing Table						
Source IP Address	Source Mask	Upstream Neighbor	Metric	Learned	Interface Name	Expire
10.0.0.0	255.0.0.0	10.53.13.144	1	Local	System	---
Total Entries: 1						

Figure 9- 37 . DVMRP Routing Table

Browse DVMRP Neighbor Address Table

This table, found in the **Monitoring** menu under **DVMRP Monitor > Browse DVMRP Neighbor Address Table** contains information about DVMRP neighbors of the Switch. To search this table, enter either an **Interface Name** or **Neighbor Address** into the respective field and click the **Find** button. DVMRP neighbors of that entry will appear in the **DVMRP Neighbor Table** below.

Interface Name	<input type="text"/>		
Neighbor Address	<input type="text" value="0.0.0.0"/>		<input type="button" value="Find"/>
DVMRP Neighbor Table			
Interface Name	Neighbor Address	Generation ID	Expire Time
System	10.20.6.24	1070379305	34
System	10.20.6.26	141	34
System	10.53.10.8	1014658134	34
Total Entries: 3			

Figure 9- 38. DVMRP Neighbor Table

Browse DVMRP Routing Next Hop Table

The **DVMRP Routing Next Hop Table** contains information regarding the next-hop for forwarding multicast packets on outgoing interfaces. Each entry in the **DVMRP Routing Next Hop Table** refers to the next-hop of a specific source to a specific multicast group address. This table is found in the **Monitoring** menu under **DVMRP Monitoring**, with the heading **Browse DVMRP Routing Next Hop Table**. To search this table, enter either an **Interface Name** or **Source IP Address** into the respective field and click the **Find** button. The next hop of that DVMRP Routing entry will appear in the **DVMRP Routing Next Hop Table** below.

Interface Name	<input type="text"/>		
Neighbor Address	<input type="text" value="0.0.0.0"/>	<input type="button" value="Find"/>	
DVMRP Neighbor Table			
Interface Name	Neighbor Address	Generation ID	Expire Time
System	10.20.6.24	1070379305	34
System	10.20.6.26	141	34
System	10.53.10.8	1014658134	34
Total Entries: 3			

Figure 9- 39. DVMRP Routing Next Hop Table

PIM Monitoring

Multicast routers use **Protocol Independent Multicast (PIM)** to determine which other multicast routers should receive multicast packets. To find out more information concerning PIM and its configuration on the Switch, see the IP Multicasting chapter of Chapter 6, **Configuration**.

PIM Neighbor Address Table

The **PIM Neighbor Address Table** contains information regarding each of a router's PIM neighbors. This screen may be found in the **Monitoring** folder under the heading **PIM Monitor**. To search this table, enter either an **Interface Name** or **Neighbor Address** into the respective field and click the **Find** button. PIM neighbors of that entry will appear in the **PIM Neighbor Table** below.

Interface Name	<input type="text"/>		
Neighbor Address	<input type="text" value="0.0.0.0"/>	<input type="button" value="Find"/>	
PIM Neighbor Table			
Interface Name	Neighbor Address	Expire Time	
System	10.22.8.100	97	
System	12.10.27.32	99	
System	15.1.1.251	103	
Total Entries: 3			

Figure 9- 40. PIM Neighbor Table

Chapter 10 - Switch Maintenance

- 10-1 TFTP Services
- 10-2 Multiple Image Services
- 10-3 CF Services
- 10-4 Ping Test
- 10-5 Save Changes
- 10-6 Reset
- 10-7 Reboot Services
- 10-8 Logout

10-1 TFTP Service

Trivial File Transfer Protocol (TFTP) services allow the Switch's firmware to be upgraded by transferring a new firmware file from a TFTP server to the Switch. A configuration file can also be loaded into the Switch from a TFTP server, switch settings can be saved to the TFTP server, and a history log can be uploaded from the Switch to the TFTP server.

Download Firmware

To update the Switch's firmware, open the **TFTP Services** folder in the **Maintenance** folder and then click the **Download Firmware** link:

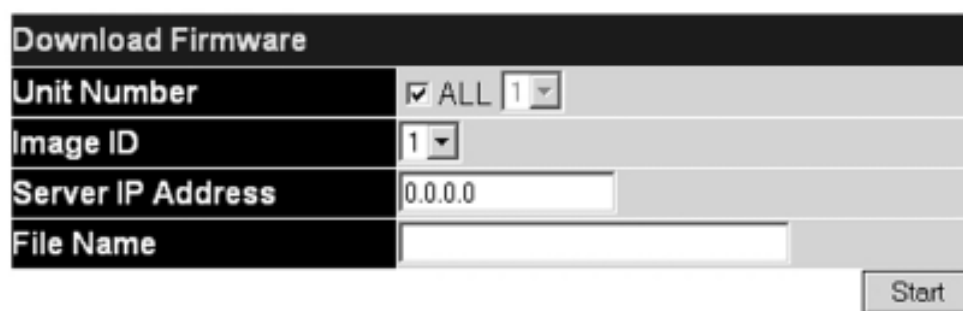

Figure 10- 1. Download Firmware window

Unit ID – Select which switch of a switch stack you want to update the firmware on. This allows the selection of a particular switch from a switch stack if you have installed the optional stacking module and have properly interconnected the switches. **All** indicates all switches in a switch stack will download the same firmware.

Enter the IP address of the TFTP server in the **Server IP Address** field.

Select the Image ID of the firmware. The AT-9724TS can hold two firmware images in its memory. Image ID 1 will always be the boot up firmware for the Switch unless specified by the user. Information on configuring Image IDs can be found in this section, under the heading **MULTIPLE IMAGE Services**.

The TFTP server must be on the same IP subnet as the Switch.

Enter the path and the filename to the firmware file on the TFTP server. Note that in the above example, the firmware file is in the root directory of the D drive of the TFTP server.

The TFTP server must be running TFTP server software to perform the file transfer. TFTP server software is a part of many network management software packages – such as NetSight, or can be obtained as a separate program.

Click Start to record the IP address of the TFTP server and begin the file transfer.

Download Configuration File

To download a configuration file from a TFTP server, click on the **TFTP Service** folder in the **Maintenance** folder and then the **Download Configuration File** link:



Figure 10- 2. Download Configuration File window

Enter the IP address of the TFTP server and specify the location of the switch configuration file on the TFTP server.

Click **Start** to initiate the file transfer.

Upload Configuration

To upload the Switch's settings to a TFTP server, click on the **TFTP Service** folder in the **Maintenance** folder and then click the **Save Settings** link:



Figure 10- 3. Upload Configuration window

Enter the IP address of the TFTP server and the path and filename for the configuration file on the TFTP server.

Click **Start** to initiate the file transfer.

Upload Log

To upload the Switch history log file to a TFTP server, open the **TFTP Service** folder in the **Maintenance** folder and then click the **Upload Log** link:



Figure 10- 4. Upload Log window

Enter the IP address of the TFTP server and the path and filename for the history log on the TFTP server.

Click **Start** to record the IP address of the TFTP server and to initiate the file transfer.

10-2 Multiple Image Services

The **Multiple Image Services** folder allow users of the AT-9724TS to configure and view information regarding firmware located on the Switch. The Switch allows two firmware images to be stored in its memory and either can be configured to be the boot up firmware for the Switch. For information regarding firmware images located on the Switch, open the **Firmware Information** link. The default setting for the Switch's firmware will have the boot up firmware stored in Image 1, but the user may set either firmware stored to be the boot up firmware by using the **Config Firmware Image** window.

Firmware Information

The following screen allows the user to view information about current firmware images stored on the Switch. To access the following screen, click **Maintenance > MULTIPLE IMAGE Services > Firmware Information**.

Firmware Information						
BOX	ID	Version	Size	Update Time	From	User
1	1	*1.06	3611379	2099/02/15 05:10:58	10.0.0.2(W)	manager
1	2	(empty)				

* means boot up firmware

(R) means firmware update thru Serial Port (RS232)

(T) means firmware update thru TELNET

(S) means firmware update thru SNMP

(W) means firmware update thru WEB

Figure 10- 5. Firmware Information window

This window holds the following information:

Parameter	Description
BOX	States the stacking ID number of the switch in the switch stack.
ID	States the image ID number of the firmware in the Switch's memory. The Switch can store 2 firmware images for use. Image ID 1 will be the default boot up firmware for the Switch unless otherwise configured by the user.
Version	States the firmware version.
Size	States the size of the corresponding firmware, in bytes.
Update Time	States the specific time the firmware version was downloaded to the Switch.
From	States the IP address of the origin of the firmware. There are four ways firmware may be downloaded to the Switch. R – If the IP address has this letter attached to it, it denotes a firmware upgrade through the Console Serial Port (RS-232). T – If the IP address has this letter attached to it, it denotes a firmware upgrade through Telnet. S – If the IP address has this letter attached to it, it denotes a firmware upgrade through the Simple Network Management Protocol (SNMP). W – If the IP address has this letter attached to it, it denotes a firmware upgrade through the web-based management interface.
User	States the user who downloaded the firmware. This field may read “Anonymous” or “Unknown” for users that are not identified.

Config Firmware Image

The **Config Firmware Image** window allows users to configure firmware images saved in the memory of the Switch. To access the following window, click **Maintenance > MULTIPLE IMAGE Services > Config Firmware Image**.

Figure 10- 6. Config Firmware Image window

This window offers the following information:

Parameter	Description
Image	Select the firmware image to be configured using the pull-down menu. The Switch allows two firmware images to be stored in the Switch's memory.
Active	This field has two options for configuration. <i>Delete</i> – Select this option to delete the firmware image specified in the Image field above. <i>Boot</i> – Select this option to set the firmware image specified above as the boot up firmware for the Switch. This firmware will be set as the boot up firmware after a switch reboot has been performed. The default setting has firmware image ID 1 as the boot up firmware image for the Switch unless specified here.

Click **Apply** to implement changes made.

10-4 Ping Test

Ping is a small program that sends ICMP Echo packets to the IP address you specify. The destination node then responds to or "echoes" the packets sent from the Switch. This is very useful to verify connectivity between the Switch and other nodes on the network.

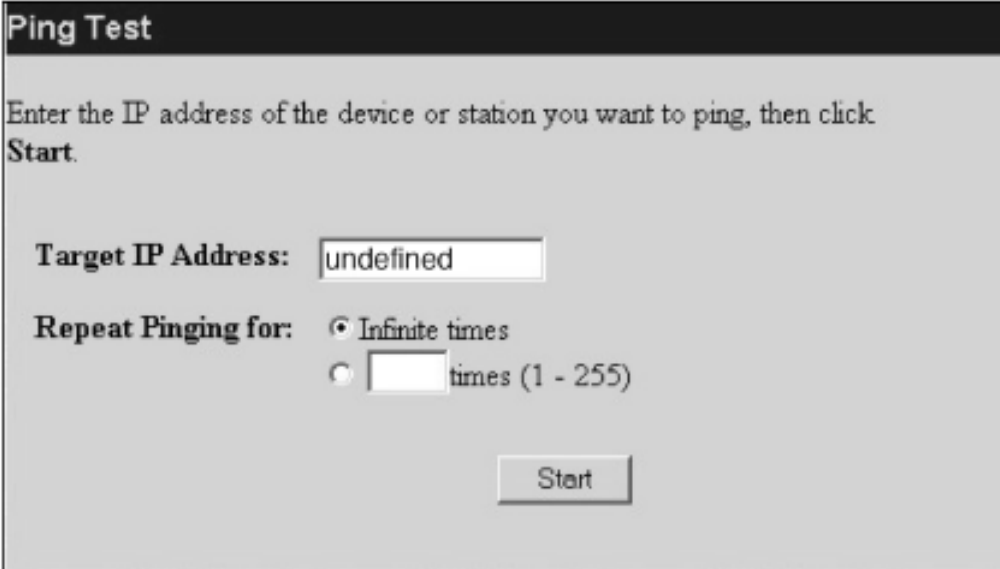

Ping Test

Enter the IP address of the device or station you want to ping, then click Start.

Target IP Address:

Repeat Pinging for: Infinite times
 times (1 - 255)

Start

Figure 10- 7. Ping Test

The user may use Infinite times radio button, in the **Repeat Pinging for:** field, which will tell the ping program to keep sending ICMP Echo packets to the specified IP address until the program is stopped. The user may opt to choose a specific number of times to ping the **Target IP Address** by clicking its radio button and entering a number between 1 and 255.

Click **Start** to initiate the Ping program.

10-5 Save Changes

The AT-9724TS has two levels of memory; normal RAM and non-volatile or NV-RAM. Configuration changes are made effective clicking the **Apply** button. When this is done, the settings will be immediately applied to the switching software in RAM, and will immediately take effect.

Some settings, though, require you to restart the Switch before they will take effect. Restarting the Switch erases all settings in RAM and reloads the stored settings from the NV-RAM. Thus, it is necessary to save all setting changes to NV-RAM before rebooting the switch.

To retain any configuration changes permanently, click on the **Save** button in the **Save Changes** page, as shown below.

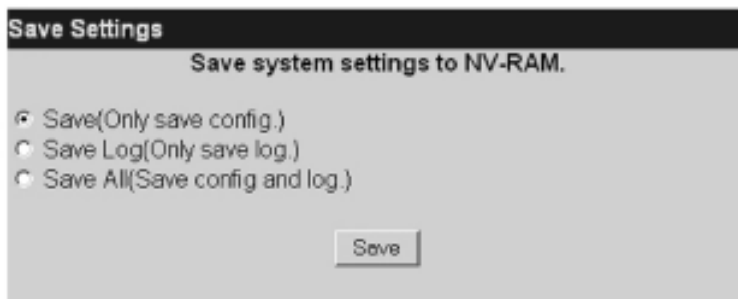

Figure 10- 8. Save Changes Screen

The Switch has three levels of save, which are as follows:

Parameter	Description
Save (Only save config)	Clicking the radio button for this entry will save only the current switch configuration to NV-RAM.
Save Log (Only save log)	Clicking the radio button for this entry will save only the current current log file to NV- RAM.
Save All (Save config and log)	Clicking the radio button for this entry will save both the current switch configuration and the current log file to NV-RAM.

These settings will be used every time the Switch is rebooted. See the **Reset** section for more information on changing configurations saved to NV-RAM.

10-6 Reset

The **Reset** function has several options when resetting the Switch. Some of the current configuration parameters can be retained while resetting all other configuration parameters to their factory defaults.

 **Note:** Only the **Reset System** option will enter the factory default parameters into the Switch's non-volatile RAM, and then restart the Switch. All other options enter the factory defaults into the current configuration, but do not save this configuration. **Reset System** will return the Switch's configuration to the state it was when it left the factory.

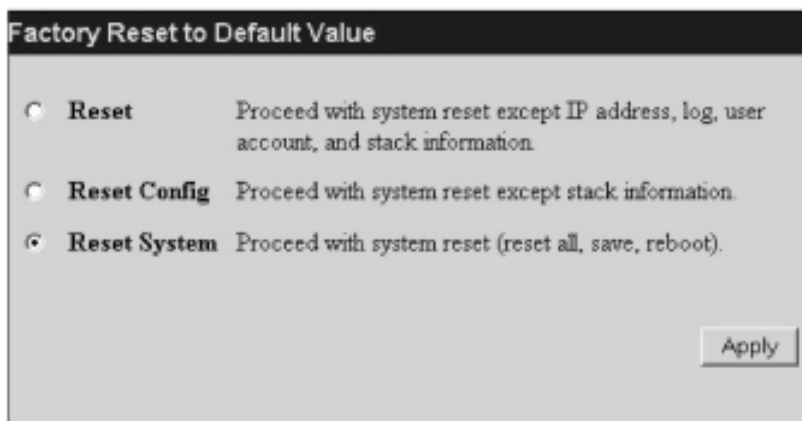

Figure 10- 9. Factory Reset to Default Value window

10-7 Reboot Device

The following menu is used to restart the Switch.

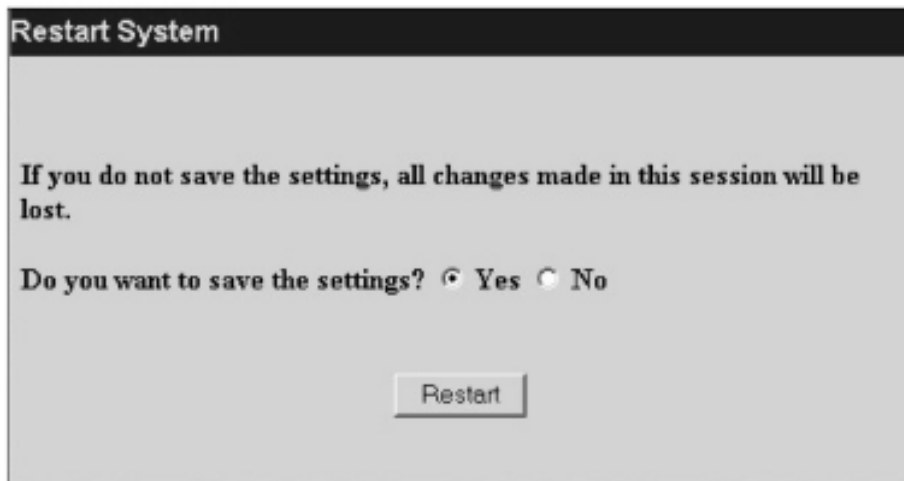

Figure 10- 10. Restart System window

Clicking the **Yes** click-box will instruct the Switch to save the current configuration to non-volatile RAM before restarting the Switch.

Clicking the **No** click-box instructs the Switch not to save the current configuration before restarting the Switch. All of the configuration information entered from the last time **Save Changes** was executed, will be lost.

Click the **Restart** button to restart the Switch.

10-8 Logout

Use the **Logout** page to logout of the Switch's Web-based management agent by clicking on the **Log Out** button.

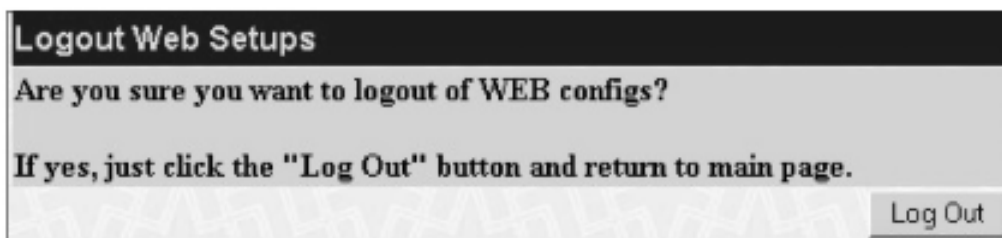

Figure 10- 11 . Logout window

Appendix A - Technical Specifications

General

Standard	IEEE 802.3u 100TX Fast Ethernet IEEE 802.3ab 1000T Gigabit Ethernet IEEE 802.1 P/Q VLAN IEEE 802.3x Full-duplex Flow Control IEEE 802.3 Nway auto-negotiation
Protocols	CSMA/CD
Data Transfer Rates:	Half-duplex Full-duplex
Ethernet	10Mbps 20Mbps
Fast Ethernet	100Mbps 200Mbps
Gigabit Ethernet	1000Mbps 2000Mbps
Fibre Optic	IEC 793-2: 1992 Type A1a - 50/125um multi-mode Type A1b - 62.5/125um multi-mode Both types use LC optical connector
Topology	Ring
Network Cables	UTP Cat.5 for 100Mbps UTP Cat.3, 4, 5 for 10Mbps EIA/TIA-568 100-ohm screened twisted-pair (STP)(100m)

Physical & Environmental

AC inputs & External Redundant Power Supply	100 – 240 VAC, 50/60 Hz (internal universal power supply)
Power Consumption:	90 watts maximum
DC fans:	2 built-in 40 x 40 x 10 mm fans; 1 built-in 60 x 60 x 18 mm fan
Operating Temperature:	0 to 40 degrees C
Storage Temperature:	-25 to 55 degrees C
Humidity:	Operating: 5% to 95% RH non-condensing Storage: 0% to 95% RH non-condensing
Dimensions:	441 mm x 207 mm x 44 mm (1U), 19 inch rackmount width
Weight:	3.15 kg
EMC:	FCC Part 15 Class A/ ICES-003 Class (Canada) EN55022 Class A / EN55024
Safety:	CSA International

Performance

Transmission Method:	Store-and-forward
RAM Buffer:	2 MB per device
Filtering Address Table:	16 K MAC address per device
Packet Filtering/ Forwarding Rate:	Full-wire speed for all connections. 148,810 pps per port (for 100Mbps) 1,488,100 pps per port (for 1000Mbps)
MAC Address Learning:	Automatic update.
Forwarding Table Age Time:	Max age: 10 – 1000000 seconds. Default = 300.

Appendix B - Translated Electrical Safety and Emission Information

Important: This appendix contains multiple-language translations for the safety statements in this guide.

Wichtig: Dieser Anhang enthält Übersetzungen der in diesem Handbuch enthaltenen Sicherheitshinweise in mehreren Sprachen.

Vigtigt: Dette tillæg indeholder oversættelser i flere sprog af sikkerhedsadvarselne i denne håndbog.

Belangrijk: Deze appendix bevat vertalingen in meerdere talen van de veiligheidsopmerkingen in deze gids.

Important: Cette annexe contient la traduction en plusieurs langues des instructions de sécurité figurant dans ce guide.

Tärkeää: Tämä liite sisältää tässä oppaassa esiintyvät turvaohjeet usealla kielellä.

Importante: questa appendice contiene traduzioni in più lingue degli avvisi di sicurezza di questa guida.







Viktig: Dette tillegget inneholder oversettelser til flere språk av sikkerhetsinformasjonen i denne veiledningen.

Importante: Este anexo contém traduções em vários idiomas das advertências de segurança neste guia.





Importante: Este apéndice contiene traducciones en múltiples idiomas de los mensajes de seguridad incluidos en esta guía.

Obs! Denna bilaga innehåller flerspråkiga översättningar av säkerhetsmeddelandena i denna handledning.



Standards: This product meets the following safety standards.

- 1  **LIGHTNING DANGER**
DANGER: DO NOT WORK on equipment or CABLES during periods of LIGHTNING ACTIVITY.
- 2  **CAUTION:** POWER CORD IS USED AS A DISCONNECTION DEVICE. TO DE-ENERGIZE EQUIPMENT, disconnect the power cord.
- 3  **ELECTRICAL – TYPE CLASS I EQUIPMENT**
THIS EQUIPMENT MUST BE EARTHED. Power plug must be connected to a properly wired earth ground socket outlet. An improperly wired socket outlet could place hazardous voltages on accessible metal parts.
- 4  **PLUGGABLE EQUIPMENT,** the socket outlet shall be installed near the equipment and shall be easily accessible.
- 5  **CAUTION:** Air vents must not be blocked and must have free access to the room ambient air for cooling.
- 6  **OPERATING TEMPERATURE:** This product is designed for a maximum ambient temperature of 40° degrees C.
- 7  **ALL COUNTRIES:** Install product in accordance with local and National Electrical Codes.







Normen: Dieses Produkt erfüllt die Anforderungen der nachfolgenden Normen.

- 1  **GEFAHR DURCH BLITZSCHLAG**
GEFAHR: Keine Arbeiten am Gerät oder an den Kabeln während eines Gewitters ausführen.
- 2  **VORSICHT:** DAS NETZKABEL DIENT ZUM TRENNEN DER STROMVERSORGUNG. ZUR TRENNUNG VOM NETZ, KABEL AUS DER STECKDOSE ZIEHEN.
- 3  **GERÄTE DER KLASSE I**
DIESE GERÄTE MÜSSEN GEERDET SEIN. Der Netzstecker darf nur mit einer vorschriftsmäßig geerdeten Steckdose verbunden werden. Ein unvorschriftsmäßiger Anschluß kann die Metallteile des Gehäuses unter gefährliche elektrische Spannungen setzen.
- 4  **STECKBARES GERÄT:** Die Anschlußbuchse sollte in der Nähe der Einrichtung angebracht werden und leicht zugänglich sein.
- 5  **VORSICHT**

Die Entlüftungsöffnungen dürfen nicht versperrt sein und müssen zum Kühlen freien Zugang zur Raumluft haben.

- 6  **BETRIEBSTEMPERATUR:** Dieses Produkt wurde für den Betrieb in einer Umgebungstemperatur von nicht mehr als 40° C entworfen.
- 7  **ALLE LÄNDER:** Installation muß örtlichen und nationalen elektrischen Vorschriften entsprechen.



Standarder: Dette produkt tilfredsstiller de følgende standarder.





- 1  **FARE UNDER UVEJR**
FARE: UNDLAD at arbejde på udstyr eller KABLER i perioder med LYNAKTIVITET.
- 2  **ADVARSEL:** DEN STRØMFØRENDE LEDNING BRUGES TIL AT AFBRYDE STRØMMEN.
SKAL STRØMMEN TIL APPARATET AFBRYDES, tages ledningen ud af stikket.
- 3  **ELEKTRISK – KLASSE I-UDSTYR**
DETTE UDSTYR KRÆVER JORDFORBINDELSE. Stikket skal være forbundet med en korrekt installeret jordforbunden stikkontakt. En ukorrekt installeret stikkontakt kan sætte livsfarlig spænding til tilgængelige metaldele.
- 4  **UDSTYR TIL STIKKONTAKT,** stikkontakten bør installeres nær ved udstyret og skal være let tilgængelig.
- 5  **ADVARSEL:** Ventilationsåbninger må ikke blokeres og skal have fri adgang til den omgivende luft i rummet for afkøling.
- 6  **BETJENINGSTEMPERATUR:** Dette apparat er konstrueret til en omgivende temperatur på maksimum 40 grader C.
- 7  **ALLE LANDE:** Installation af produktet skal ske i overensstemmelse med lokal og national lov givning for elektriske installationer.

Eisen: Dit product voldoet aan de volgende eisen.







- 1  **GEVAAR VOOR BLIKSEMINSLAG GEVAAR:** NIET aan toestellen of KABELS WERKEN bij BLIKSEM.
- 2  **WAARSCHUWING:** HET TOESTEL WORDT UITGESCHAKELD DOOR DE STROOMKABEL TE ONTKOPPELEN. OM HET TOESTEL STROOMLOOS TE MAKEN: de stroomkabel ontkoppelen.
- 3  **ELEKTRISCHE TOESTELLEN VAN KLASSE I**
DIT TOESTEL MOET GEAARD WORDEN. De stekker moet aangesloten zijn op een juist geaarde contactdoos. Een onjuist geaarde contactdoos kan de metalen onderdelen waarmee de gebruiker eventueel in aanraking komt onder gevaarlijke spanning stellen.
- 4  **AAN TE SLUITEN APPARATUUR,** de contactdoos wordt in de nabijheid van de apparatu ur geïnstalleerd en is gemakkelijk te bereiken."
- 5  **OPGELET:** De ventilatiegaten mogen niet worden gesperd en moeten de omgevingslucht onge hinderd toelaten voor afkoeling.
- 6  **BEDRIJFSTEMPERATUUR:** De omgevingstemperatuur voor dit produkt mag niet meer bedra gen dan 40 graden Celsius.
- 7  **ALLE LANDEN:** het toestel installeren overeenkomstig de lokale en nationale elektrische voorschriften.

Normes: ce produit est conforme aux normes de suivantes:







- 1  **DANGER DE Foudre**
DANGER: NE PAS MANIER le matériel ou les CÂBLES lors d'activité orageuse.
- 2  **ATTENTION:** LE CORDON D'ALIMENTATION SERT DE MISE HORS CIRCUIT. POUR COUPER L'ALIMENTATION DU MATÉRIEL, débrancher le cordon.

- 3  **ÉQUIPEMENT DE CLASSE I ÉLECTRIQUE CE MATÉRIEL DOIT ÊTRE MIS A LA TERRE.** La prise de courant doit être branchée dans une prise femelle correctement mise à la terre car des tensions dangereuses risqueraient d'atteindre les pièces métalliques accessibles à l'utilisateur.
- 4  **EQUIPEMENT POUR BRANCHEMENT ELECTRIQUE,** la prise de sortie doit être placée près de l'équipement et facilement accessible".
- 5  **ATTENTION:** Ne pas bloquer les fentes d'aération, ceci empêcherait l'air ambiant de circuler librement pour le refroidissement.
- 6  **TEMPÉRATURE DE FONCTIONNEMENT:** Ce matériel est capable de tolérer une température ambiante maximum de ou 40 degrés Celsius
- 7  **POUR TOUS PAYS:** Installer le matériel conformément aux normes électriques nationales et locales.



Standardit: Tämä tuote on seuraavien standardien mukainen.

- 1  **SALAMANISKUVAARA**
HENGENVAARA: ÄLÄ TYÖSKENTELE laitteiden tai KAAPELEIDEN KANSSA SALAMOIN NIN AIKANA.
- 2  **HUOMAUTUS:** VIRTajohtoa KÄYTETÄÄN VIRRANKATKAISULAITTEENA. VIRTA KATKAISTAAN irrottamalla virtajohto.
- 3  **SÄHKÖ – TYYPPILUOKAN I LAITTEET TÄMÄ LAITE TÄYTY MAADOITTA.** Pistoke täytyy liittää kunnollisesti maadoitettuun pistorasiaan. Virheellisesti johdotettu pistorasia voi altistaa met alliosat vaarallisille jännitteille.
- 4  **PISTORASIAAN KYTKETTÄVÄ LAITE;** pistorasia on asennettava laitteen lähelle ja siihen on oltava esteetön pääsy."
- 5  **HUOMAUTUS:** Ilmavaihtoreikiä ei pidä tukkia ja niillä täytyy olla vapaa yhteys ympäröivään huoneilmaan, jotta ilmanvaihto tapahtuisi.
- 6  **KÄYTTÖLÄMPÖTILA:** Tämä tuote on suunniteltu ympäröivän ilman maksimilämpötilalle 40°C.
- 7  **KAIKKI MAAT:** Asenna tuote paikallisten ja kansallisten sähköturvallisuusmääräysten mukaisesti.







Standard: Questo prodotto è conforme ai seguenti standard.

- 1  **PERICOLO DI FULMINI**
PERICOLO: NON LAVORARE sul dispositivo o sui CAVI durante PRECIPITAZIONI TEMPORALESCE.
- 2  **ATTENZIONE:** IL CAVO DI ALIMENTAZIONE È USATO COME DISPOSITIVO DI DISATTIVAZIONE. PER TOGLIERE LA CORRENTE AL DISPOSITIVO staccare il cavo di alimentazione.
- 3  **ELETTRICITÀ – DISPOSITIVI DI CLASSE I**
QUESTO DISPOSITIVO DEVE AVERE LA MESSA A TERRA. La spina deve essere inserita in una presa di corrente specificamente dotata di messa a terra. Una presa non cablata in maniera corretta rischia di scaricare una tensione pericolosa su parti metalliche accessibili.
- 4  **APPARECCHIATURA COLLEGABILE,** la presa va installata vicino all'apparecchio per risultare facilmente accessibile.
- 5  **ATTENZIONE:** le prese d'aria non vanno ostruite e devono consentire il libero ricircolo dell'aria ambiente per il raffreddamento.
- 6  **TEMPERATURA DI FUNZIONAMENTO:** Questo prodotto è concepito per una temperatura ambientale massima di 40 gradi centigradi.
- 7  **TUTTI I PAESI:** installare il prodotto in conformità delle vigenti normative elettriche nazionali.



Sikkerhetsnormer: Dette produktet tilfredsstiller følgende sikkerhetsnormer.





- 1  **FARE FOR LYNNEDSLAG**
FARE: ARBEID IKKE på utstyr eller KABLER i TORDENVÆR.
- 2  **FORSIKTIG: STRØMLEDNINGEN BRUKES TIL Å FRAKOBLE UTSTYRET. FOR Å DEAKTIVISERE UTSTYRET,**
må strømforsyningen kobles fra.
- 3  **ELEKTRISK – TYPE I - KLASSE UTSTYR DETTE UTSTYRET MÅ JORDES.** Strømkontakten må være tilkopleet en korrekt jordet kontakt. En kontakt som ikke er korrekt jordet kan føre til farlig spenninger i lett tilgjengelige metalldeleer.
- 4  **UTSTYR FOR STIKKONTAKT.** Stikkontakten skal monteres i nærheten av utstyret og skal være lett tilgjengelig."
- 5  **FORSIKTIG:** Lufteventilene må ikke blokkeres, og må ha fri tilgang til luft med romtemperatur for avkjøling.
- 6  **DRIFTSTEMPERATUR:** Dette produktet er konstruert for bruk i maksimum romtemperatur på 40 grader celsius.
- 7  **ALLE LAND:** Produktet må installeres i samsvar med de lokale og nasjonale elektriske koder.

Padrões: Este produto atende aos seguintes padrões.







- 1  **PERIGO DE CHOQUE CAUSADO POR RAIOS PERIGO:** NÃO TRABALHE no equipamento ou nos CABOS durante períodos suscetíveis a QUEDAS DE RAIOS.
- 2  **CUIDADO:** O CABO DE ALIMENTAÇÃO É UTILIZADO COMO UM DISPOSITIVO DE DESCONEXÃO. PARA DESELETRIFICAR O EQUIPAMENTO, desconecte o cabo de ALIMENTAÇÃO.
- 3  **ELÉTRICO – EQUIPAMENTOS DO TIPO CLASSE I**
DEVE SER FEITA LIGAÇÃO DE FIO TERRA PARA ESTE EQUIPAMENTO. O plugue de alimentação deve ser conectado a uma tomada com adequada ligação de fio terra. Tomadas sem adequada ligação de fio terra podem transmitir voltagens perigosas a peças metálicas expostas.
- 4  **EQUIPAMENTO DE LIGAÇÃO,** a tomada eléctrica deve estar instalada perto do equipamento e ser de fácil acesso."
- 5  **CUIDADO:** As aberturas de ventilação não devem ser bloqueadas e devem ter acesso livre ao ar ambiente para arrefecimento adequado do aparelho.
- 6  **TEMPERATURA DE FUNCIONAMENTO:** Este produto foi projetado para uma temperatura ambiente máxima de 40 graus centígrados.
- 7  **TODOS OS PAÍSES:** Instale o produto de acordo com as normas nacionais e locais para instalações eléctricas.

Estándares: Este producto cumple con los siguientes estándares.

- 1  **PELIGRO DE RAYOS**
PELIGRO: NO REALICE NINGUN TIPO DE TRABAJO O CONEXION en los equipos o en LOS CABLES durante TORMENTAS ELECTRICAS.
- 2  **ATENCION:** EL CABLE DE ALIMENTACION SE USA COMO UN DISPOSITIVO DE DESCONEXION. PARA DESACTIVAR EL EQUIPO, desconecte el cable de alimentación.
- 3  **ELECTRICO – EQUIPO DEL TIPO CLASE I**
ESTE EQUIPO TIENE QUE TENER CONEXION A TIERRA. El cable tiene que conectarse a un enchufe a tierra debidamente instalado. Un enchufe que no está correctamente instalado podría ocasionar tensiones peligrosas en las partes metálicas que están expuestas.

- 4  **EQUIPO CONECTABLE**, el tomacorriente se debe instalar cerca del equipo, en un lugar con acceso fácil".
- 5  **ATENCION:** Las aberturas para ventilación no deberán bloquearse y deberán tener acceso libre al aire ambiental de la sala para su enfriamiento.
- 6  **TEMPERATURA REQUERIDA PARA LA OPERACIÓN:** Este producto está diseñado para una temperatura ambiental máxima de 40 grados C.
- 7  **PARA TODOS LOS PAÍSES:** Monte el producto de acuerdo con los Códigos Eléctricos locales y nacionales.

Standarder: Denna produkt uppfyller följande standarder.

- 1  **FARA FÖR BLIXTNEDSLAG**
FARA: ARBETA EJ på utrustningen eller kablarna vid ÅSKVÄDER.
- 2  **VARNING:** NÄTKABELN ANVÄNDS SOM STRÖMBRYTARE FÖR ATT KOPPLA FRÅN STRÖMMEN, dra ur nätkabeln.
- 3  **ELEKTRISKT – TYP KLASS I UTRUSTNING**
DENNA UTRUSTNING MÅSTE VARA JORDAD. Nätkabeln måste vara ansluten till ett ordentligt jordat uttag. Ett felaktigt uttag kan göra att närliggande metalldelar utsätts för högspänning. Apparaten skall anslutas till jordat uttag, när den ansluts till ett nätverk.
- 4  **UTRUSTNING MED PLUGG.** Uttaget skall installeras i utrustningens närhet och vara lättåtkomligt".
- 5  **VARNING:** Luftventilerna får ej blockeras och måste ha fri tillgång till omgivande rumsluft för avsvälvning.
- 6  **DRIFTSTEMPERATUR:** Denna produkt är konstruerad för rumstemperatur ej överstigande 40 grader Celsius.
- 7  **ALLA LÄNDER:** Installera produkten i enlighet med lokala och statliga bestämmelser för elektrisk utrustning.

Free Manuals Download Website

<http://myh66.com>

<http://usermanuals.us>

<http://www.somanuals.com>

<http://www.4manuals.cc>

<http://www.manual-lib.com>

<http://www.404manual.com>

<http://www.luxmanual.com>

<http://aubethermostatmanual.com>

Golf course search by state

<http://golfingnear.com>

Email search by domain

<http://emailbydomain.com>

Auto manuals search

<http://auto.somanuals.com>

TV manuals search

<http://tv.somanuals.com>