

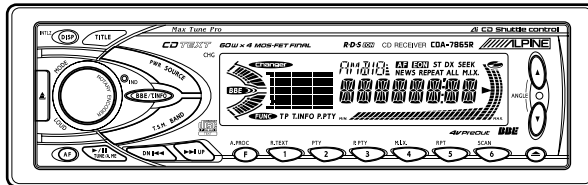

CDA-7865R

FM/MW/LW/RDS CD Receiver

- **OWNER'S MANUAL**
Please read before using this equipment.
- **BEDIENUNGSANLEITUNG**
Lesen Sie diese Bedienungsanleitung bitte vor Gebrauch des Gerätes.
- **MODE D'EMPLOI**
Veuillez lire avant d'utiliser cet appareil.
- **MANUAL DE OPERACIÓN**
Léalo antes de utilizar este equipo.
- **ISTRUZIONI PER L'USO**
Si prega di leggere prima di utilizzare il attrezzatura.
- **ANVÄNDARHANDLEDNING**
Innan du använder utrustningen bör du läsa igenom denna användarhandledning.



ALPINE ELECTRONICS, INC.
Tokyo office: 1-1-8 Nishi Gotanda,
Shinagawa-ku,
Tokyo 141-8501, Japan
Tel.: (03) 3494-1101

ALPINE ELECTRONICS OF AMERICA, INC.
19145 Gramercy Place, Torrance,
California 90501, U.S.A.
Tel.: 1-800-ALPINE-1 (1-800-257-4631)

ALPINE ELECTRONICS OF CANADA, INC.
Suite 203, 7300 Warden Ave. Markham,
Ontario L3R 9Z6, Canada
Tel.: 1-800-ALPINE-1 (1-800-257-4631)

ALPINE ELECTRONICS OF AUSTRALIA PTY. LTD.
6-8 Fiveways Boulevard Keysborough,
Victoria 3173, Australia
Tel.: (03) 9769-0000

ALPINE ELECTRONICS GmbH
Kreuzerkamp 7-11 40878 Ratingen, Germany
Tel.: 02102-45 50

ALPINE ITALIA S.p.A.
Via C. Colombo 8, 20090 Trezzano Sul Naviglio
MI, Italy
Tel.: 02-48 47 81

ALPINE ELECTRONICS FRANCE S.A.R.L.
(RCS PONTOISE B 338 101 280)
98, Rue De La Belle Etoile, Z.I. Paris Nord II
B.P. 50016 F-95945, Roissy, Charles De Gaulle
Cedex, France
Tel.: 01-48 63 89 89

ALPINE ELECTRONICS OF U.K., LTD.
13 Tanners Drive, Blakelands, Milton Keynes
MK14 5BU, U.K.
Tel.: 01908-61 15 56

ALPINE ELECTRONICS DE ESPAÑA, S.A.
Portal De Gamarra 36, Pabellón 32
01013 Vitoria (Alava)-Apdo. 133, Spain
Tel.: 34-45-283588

EN

DE

FR

ES

IT

SE

CD changer for CDA-7865R
CD-Wechsler für CDA-7865R
Changeur CD pour CDA-7865R
Cambiador de CD para
CDA-7865R
Cambia CD per CDA-7865R
CD-växlare för CDA-7865R



CHA-S624

CD changer for CDA-7865R
CD-Wechsler für CDA-7865R
Changeur CD pour CDA-7865R
Cambiador de CD para
CDA-7865R
Cambia CD per CDA-7865R
CD-växlare för CDA-7865R



CHA-1214



CHM-S620

Alpine CD Changers Give You More!

More musical selections, more versatility, more convenience.

An Alpine CD Changer adds more musical choices to your sound system. All models can be controlled from Alpine head units and deliver excellent sound quality. The CHA-S624 is a high-performance 6-disc changer with a new M DAC, Ai-NET compatibility, Optical Digital Output, 150 Disc Title Memory and CD TEXT. The CHA-1214 Ai-NET model holds 12 discs, and the CHM-S620 M-Bus model is a super-compact 6-disc changer.

Von Alpine CD-Wechslern haben Sie mehr!

Mehr Musikauswahl, mehr Vielseitigkeit, mehr Komfort.

Mit einem Alpine CD-Wechsler erweitern Sie die Musikauswahl Ihres Systems. Sämtliche Modelle lassen sich von einer Alpine-Bedieneinheit aus steuern und liefern hervorragende Klangqualität. Der CHA-S624 ist ein Ai-NET-kompatibler Hochleistungs-Wechsler für 6 CDs mit dem neuen M-DAC, Digitalausgang für Glasfaserkabel, CD-Titelspeicher für 150 Titel und CD-TEXT. Das Ai-NET-Modell CHA-1214 nimmt 12 CDs auf, und der M-Bus-kompatible CHM-S620 ist ein superkompakter Wechsler für 6 CDs.

Changeurs de CD Alpine : vous avez le choix!

Plus de sélections musicales, plus de souplesse, plus de confort.

Un changeur de CD Alpine permet d'augmenter la plage des sélections musicales de votre système embarqué. Tous les modèles peuvent être contrôlés à partir des autoradios Alpine et offrent une excellente qualité audio. Le modèle CHA-S624 est un changeur 6 disques ultra performant compatible Ai-NET et équipé d'un convertisseur N/A standard, d'une sortie optique numérique, d'une mémoire d'une capacité de 150 titres et de la fonction CD TEXT. Le modèle CHA-1214 Ai-NET peut contenir 12 disques. Le modèle CHM-S620 M-Bus est un changeur 6 disques super compact.

¡Los cambiadores Alpine de CD le ofrecen más!

Más selecciones musicales, más versatilidad y más ventajas.

Un cambiador Alpine de CD añade más opciones musicales a su equipo de sonido. Todos los modelos pueden controlarse desde las unidades principales de Alpine y proporcionar un sonido de calidad excepcional. El modelo CHA-S624 es un cambiador de 6 discos de alto rendimiento con el nuevo DAC "M" y compatibilidad con Ai-NET, salida digital óptica, memoria de títulos de 150 discos y TEXTO CD. El modelo CHA-1214 Ai-NET admite 12 discos y el modelo CHM-S620 Bus-M es un cambiador de 6 discos y tamaño reducido.

I caricatori CD Alpine danno di più!

Più scelta, più versatilità, più comodità.

Un caricatore CD Alpine offre maggiore scelta. Tutti i modelli possono essere controllati tramite le unità di controllo Alpine e producono un suono di qualità eccellente. CHA-S624 è un caricatore a 6 dischi Ai NET compatibile e dotato di un nuovo M DAC, di un'uscita ottica digitale, memorizzazione dei titoli di 150 dischi e CD TEXT. Il modello CHA-1214 Ai NET può contenere un massimo di 12 dischi, mentre il modello CHM-S620 M-Bus è un caricatore a 6 dischi ultra compatto.

Alpines CD-växlare ger mer!

Fler musikval, mer variation, större bekvämlighet.

Med Alpines CD-växlare i systemet får du större musikalisk valfrihet. Alla modeller kan styras från Alpines huvudenheter och ger enastående ljudkvalitet. CHA-S624 är en högpresterande växlare för 6 skivor med en ny M D/A-omvandlare, kompatibel med Ai-NET, optisk digitalutgång, titelminne för 150 skivor och CD-TEXT. Modellen CHA-1214 Ai-NET rymmer 12 skivor och modellen CHM-S620 M-Bus är en superkompakt växlare för 6 skivor.

Contents

Operating Instructions

WARNING

WARNING	2
CAUTION	2
PRECAUTION	2

Basic Operation

Detaching the Front Panel	4
Attaching the Front Panel	4
Initial System Start-Up	4
Turning Power On and Off	4
Display Angle Adjustment	5
Adjusting Volume/Bass/Treble/Balance (Between Left and Right)/Fader (Between Front and Rear)	5
Turning Loudness On/Off	5
Selecting BBE Mode	5
Adjusting Source Signal Level	6
Changing Backlighting Colour	6
Dimmer Control	6
Subwoofer On and Off	7
Sound (Beep) Guide Function	7
Turning Mute Mode On/Off	7
CD Text Scroll Setting	7
Setting the AUX Mode	8
Demonstration	8
Adjusting the built-in Audio Processor	9
Switching the Display Modes	9

Radio Operation

Manual Tuning	10
Automatic Seek Tuning	10
Manual Storing of Station Presets	11
Automatic Memory of Station Presets	11
Tuning to Preset Stations	11
Auto Station Search While Travelling	11

RDS Operation

Setting RDS Reception Mode and Receiving RDS Stations	12
Recalling Preset RDS Stations	12
Receiving RDS Regional (Local) Stations	13
Receiving Traffic Information	13
PTY (Programme Type) Tuning	13
Receiving Traffic Information While Playing CD or Radio	14
Priority PTY (Programme Type)	14
Turning Emergency Alarm On or Off	15
Displaying Radio Text	15

CD Player Operation

Opening and Closing the Movable display	16
Playback	16
Music Sensor (Skip)	17
Fast Forward and Backward	17
Repeat Play	17
M.I.X. (Random Play)	17
Scanning Programmes	17
Displaying the Title/Text	18
Titling Discs	18
Erasing Disc Title	19
Controlling CD Changer (Optional)	19
Searching for Titled Discs (CD Changer only)	20
Multi-Changer Selection	20

Remote Control Operation

Controls on Remote Control	21
Battery Replacement	22

Information

In Case of Difficulty	23
Specifications	25

Installation and Connections

Precautions	26
Installation	27
Connection	28

WARNING

WARNING

This symbol means important instructions. Failure to heed them can result in serious injury or death.

DO NOT OPERATE ANY FUNCTION THAT TAKES YOUR ATTENTION AWAY FROM SAFELY DRIVING YOUR VEHICLE.

Any function that requires your prolonged attention should only be performed after coming to a complete stop. Always stop the vehicle in a safe location before performing these functions. Failure to do so may result in an accident.

KEEP THE VOLUME AT A LEVEL WHERE YOU CAN STILL HEAR OUTSIDE NOISE WHILE DRIVING.

Failure to do so may result in an accident.

MINIMIZE DISPLAY VIEWING WHILE DRIVING.

Viewing the display may distract the driver from looking ahead of the vehicle and cause an accident.

DO NOT DISASSEMBLE OR ALTER.

Doing so may result in an accident, fire or electric shock.

USE THIS PRODUCT FOR MOBILE 12V APPLICATIONS.

Use for other than its designed application may result in fire, electric shock or other injury.

KEEP SMALL OBJECTS SUCH AS BATTERY OUT OF THE REACH OF CHILDREN.

Swallowing them may result in serious injury. If swallowed, consult a physician immediately.

USE THE CORRECT AMPERE RATING WHEN REPLACING FUSES.

Failure to do so may result in fire or electric shock.

DO NOT EXPOSE THIS PRODUCT TO RAIN OR MOISTURE.

Doing so may result in fire or electric shock.

DO NOT BLOCK VENTS OR RADIATOR PANELS.

Doing so may cause heat to build up inside and may result in fire.

CAUTION

This symbol means important instructions. Failure to heed them can result in injury or material property damage.

HALT USE IMMEDIATELY IF A PROBLEM APPEARS.

Failure to do so may cause personal injury or damage to the product. Return it to your authorized Alpine dealer or the nearest Alpine Service Centre for repairing.

DO NOT PLACE HANDS, FINGERS OR FOREIGN OBJECTS IN INSERTION SLOTS OR GAPS.

Doing so may result in personal injury or damage to the product.

PRECAUTIONS

Temperature

Be sure the temperature inside the vehicle is between +60°C (+140°F) and -10°C (+14°F) before turning your unit on.

Moisture Condensation

You may notice the CD playback sound wavering due to condensation. If this happens, remove the disc from the player and wait about an hour for the moisture to evaporate.

Damaged Disc

Do not attempt to play cracked, warped, or damaged discs. Playing a bad disc could severely damage the playback mechanism.

Maintenance

If you have problems, do not attempt to repair the unit yourself. Return it to your Alpine dealer or the nearest Alpine Service Station for servicing.

Never Attempt the Following

Do not grip or pull out the disc while it is being pulled back into the player by the automatic reloading mechanism.

Do not attempt to insert a disc into the unit when the unit power is off.

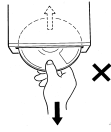

Inserting Discs

Your player accepts only one disc at a time for playback. Do not attempt to load more than one disc.

Make sure the label side is facing up when you insert the disc. Your player will automatically eject any disc that is inserted incorrectly. If the player continues to eject a correctly inserted disc, push the RESET switch with a pointed object such as a ball-point pen.

Playing a disc while driving on a very bumpy road may result in skips, but this will not scratch the disc or damage the player.

New Discs

As a protective measure to prevent the CD from jamming, the CD player will automatically eject discs with irregular surfaces or inserted incorrectly. When a new disc is inserted into the player and ejected after initial loading, using your finger, feel around the inside of the centre hole and outside edge of the disc. If you feel any small bumps or irregularities, this could inhibit proper loading of the disc. To remove the bumps, rub the inside edge of the hole and outside edge of the disc with a ball-point pen or other such instrument, then insert the disc again.

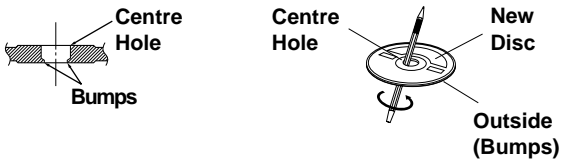

Irregular Shaped Discs

Be sure to use round shape discs only for this unit and never use any special shape discs.

Use of special shape discs may cause damage to the mechanism.

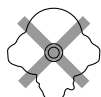

Installation Location

Make sure the CDA-7865R will not be installed in a location subjected to:

- Direct sun and heat
- High humidity and water
- Excessive dust
- Excessive vibrations

Handling the Detachable Front Panel

- Do not expose to rain or water.
- Do not drop or apply shock.

Correct Handling

Do not drop the disc while handling. Hold the disc so you will not leave fingerprints on the surface. Do not affix tape, paper, or gummed labels to the disc. Do not write on the disc.

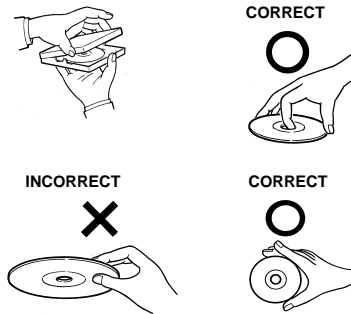

Disc Cleaning

Fingerprints, dust, or soil on the surface of the disc could cause the CD player to skip. For routine cleaning, wipe the playing surface with a clean, soft cloth from the centre of the disc to the outer edge. If the surface is heavily soiled, dampen a clean, soft cloth in a solution of mild neutral detergent before cleaning the disc.



Disc Accessories

There are various accessories available on the market for protecting the disc surface and improving sound quality. However, most of them will influence the thickness and/or diameter of the disc. Using such accessories can cause the disc to be out of standard specifications and may create operational problems. We recommend not using these accessories on discs played in Alpine CD players.

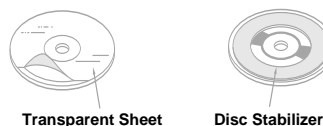

Basic Operation

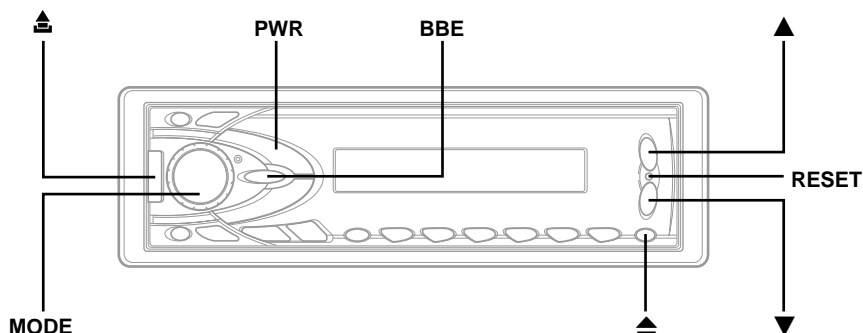

Detaching the Front Panel

- 1 Press the **PWR** (Power) button at least 3 seconds to turn off the power.
- 2 Press the **▲** (Release) button at lower left corner until the front panel pops out.
- 3 Grasp the left side of the front panel and pull it out.

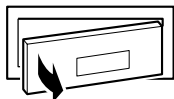

NOTES

- The front panel may become hot in normal usage (especially the connector terminals), this is not malfunction.
- To protect the front panel, place it in the supplied carrying case.

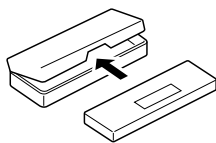

Attaching the Front Panel

- 1 First, insert the right side of the front panel into the main unit. Align the groove on the front panel with the projections on the main unit.
- 2 Push the left side of the front panel until it locks firmly into the main unit.

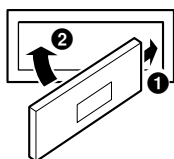

NOTE

Before attaching the front panel, make sure that there is no dirt or dust on the connector terminals and no foreign object between the front panel and the main unit.

Connectable to Remote Control Interface Box

You can operate this unit from the vehicle's control unit when an Alpine Remote Control Interface Box (optional) is connected. For details, contact your Alpine dealer.

Initial System Start-Up

Immediately after installing or applying power to the unit, it should be initialized. Press the **RESET** switch with a ballpoint pen or any other pointed object.



Turning Power On and Off

- 1 Press the **PWR** (Power) button to turn on the unit.

NOTE

The unit can be turned on by pressing any other button except the eject **▲** button.

The volume level gradually increases to the previous level you were listening to before the unit was turned off. Press the **PWR** button for at least 3 seconds to turn off the unit.

NOTE

The very first time the power is turned on, the volume will start from level 12, the BBE will be on in the tuner mode.

Display Angle Adjustment

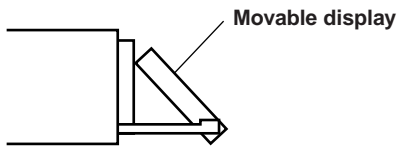

The movable display may be adjusted to 3 different angles depending upon user preference.

- 1 Press the **ANGLE ▲** or **▼** button to adjust the angle of the movable display.

NOTES

- The display will close a half minute after the ignition key is turned to the OFF position.
- The adjusted angle of the display is stored in memory. There is no need to re-adjust the angle when the power is turned back on.

CAUTION

Keep hands (or any other object) away from the display while it is opening or closing to avoid damage or injury. The back of the movable display will get very warm under normal operating conditions. This is not a malfunction. Do not touch.

Adjusting Volume/Bass/Treble/Balance (Between Left and Right)/Fader (Between Front and Rear)

- 1 Press the **MODE** (Audio Control) knob repeatedly to choose the desired mode. Each press changes the modes as follows:

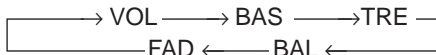

NOTES

- If the **MODE** (Audio Control) knob is not rotated in 5 seconds after selecting the **BASS**, **TREBLE**, **BALANCE**, or **FADER** mode, the unit automatically returns to the **VOLUME** mode.
- When the subwoofer or **BBE** mode is ON, their respective levels may be adjusted.

- 2 Rotate the **MODE** (Audio Control) knob until the desired sound is obtained in each mode.

NOTES

- The settings of the Bass and Treble will be individually memorized for each source (FM, MW (LW) and CD) until the setting is changed. Depending on the connected devices, some functions and display indications do not work.
- When the temperature inside the unit rises, the volume may decrease momentarily. This is not a malfunction.

Turning Loudness On/Off

Loudness introduces a special low- and high-frequency emphasis at low listening levels. This compensates for the ear's decreased sensitivity to bass and treble sound.

- 1 Press and hold the **MODE** (Audio Control) knob for at least 2 seconds to activate or deactivate the loudness mode.

The display shows "LOUDNESS" when the loudness mode is activated.

NOTE

When an external audio processor is connected to this unit, the Loudness function on this unit does not work.

Selecting BBE Mode

The BBE (Barcus Berry Electronics) processor installed in this unit is designed to correct the phase distortion inherent in most loudspeaker designs. Ensuring the phase integrity of the signal driving the speakers improves the accurate reproduction of the sound.

- 1 Press and hold the **BBE** button for at least 2 seconds to turn on and off the BBE mode.
- 2 In BBE mode, press the **MODE** (Audio Control) knob to select the BBE adjusting mode. Each press changes the adjusting mode.
- 3 To change to a desired BBE level, rotate the **MODE** (Audio Control) knob. The BBE level can be changed from +1 to +3.

NOTE

The initial mode is +2.

Basic Operation

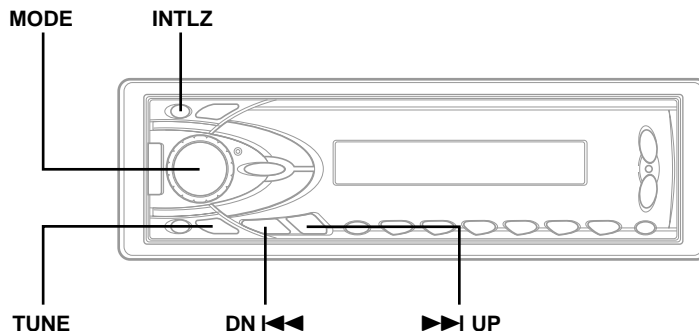

Adjusting Source Signal Level

If the difference in volume level between the CD player and FM radio is too great, adjust the FM signal level as follows.

- 1** Press and hold the **INTLZ** button for at least 2 seconds.
- 2** Press the **▶▶ I UP** button repeatedly to select "FM-LV." Each press of the **▶▶ I UP** button scrolls the modes as follows:
 → FM-LV → REG → PTY31 → AMBER → DIM → SUB → DEMO ← AUX ← SCR ← MUTE ← BEEP ←
- NOTE**
 When you press the **DN I◀◀** button, the display scrolls in the reverse sequence.
- 3** Press the **TUNE** button to select the FM signal level mode. Each press toggles between "FM-LV HI" (High) and "FM-LV LO" (Low).
- 4** Press and hold the **INTLZ** button for at least 2 seconds to activate the normal mode.

Changing Backlighting Colour

- 1** Press and hold the **INTLZ** button for at least 2 seconds.
- 2** Press the **▶▶ I UP** button repeatedly to select "AMBER". Each press of the **▶▶ I UP** button changes the modes as shown:
NOTE
 If you press the **DN I◀◀** button the display scrolls in reverse sequence.
 → FM-LV → REG → PTY31 → AMBER → DIM → SUB → DEMO ← AUX ← SCR ← MUTE ← BEEP ←
- 3** Press the **TUNE** button to toggle the mode between AMBER ON (amber) and AMBER OFF (green).
- 4** Press and hold the **INTLZ** button for at least 2 seconds to set the selected mode.

Dimmer Control

Set the DIMMER control to AUTO to decrease the illumination brightness of the unit with the head lights of the vehicle ON. This mode is useful if you feel the unit's backlighting is too bright at night.

- 1** Press and hold the **INTLZ** button for at least 2 seconds.
- 2** Press the **▶▶ I UP** button repeatedly to select "DIM". Each press of the **▶▶ I UP** button scrolls the modes as shown:
 → FM-LV → REG → PTY31 → AMBER → DIM → SUB → DEMO ← AUX ← SCR ← MUTE ← BEEP ←
- NOTE**
 If you press the **DN I◀◀** button the display scrolls in reverse sequence.
- 3** Press the **TUNE** button to select the Dimmer mode. Each press toggles between DIM AUTO and DIM MANU.
- 4** Press and hold the **INTLZ** button for at least 2 seconds to activate the normal mode.

Subwoofer On and Off

- 1 Press and hold the **INTLZ** button for at least 2 seconds.
- 2 Press the **▶▶I UP** button repeatedly to select "SUB."
Each press of the **▶▶I UP** button changes the modes as shown:
◀ FM-LV → REG → PTY31 → AMBER → DIM → SUB
DEMO ← AUX ← SCR ← MUTE ← BEEP ←
- NOTE**
If you press the **DN◀◀** button the display scrolls in reverse sequence.
- 3 Press the **TUNE** button to toggle mode between SUB-W ON and SUB-W OFF.

If an Ai-NET compatible processor with Subwoofer output is connected:
Press the **TUNE** button after selecting the SUB-W ON mode, and the subwoofer output phase is toggled SUBW NOR (0°) or SUBW REV (180°).
- 4 Press and hold the **INTLZ** button for at least 2 seconds after setting the SUB-W ON.
- 5 Press the **MODE** (Audio Control) knob repeatedly to select the SUB-W mode.
◀ SUB-W → BAS → TRE → BAL →
VOL ← FAD ←
- 6 Rotate **MODE** (Audio Control) knob until the desired sound is obtained in each mode.

Sound (Beep) Guide Function

This function will give audible feedback with varying tones depending upon the button pressed.

- 1 Press and hold the **INTLZ** button for at least 2 seconds.
- 2 Press the **▶▶I UP** button repeatedly to select "BEEP."
Each press of the **▶▶I UP** button changes the modes as shown:
NOTE
If you press the **DN◀◀** button the display scrolls in reverse sequence.
◀ FM-LV → REG → PTY31 → AMBER → DIM → SUB
DEMO ← AUX ← SCR ← MUTE ← BEEP ←
- 3 Press the **TUNE** button to toggle the mode between BEEP ON and BEEP OFF.
NOTE
The initial setting at the factory is BEEP ON.
- 4 Press and hold the **INTLZ** button for at least 2 seconds to set the selected mode.

Turning Mute Mode On/Off

If a device having the interrupt feature is connected, audio will be automatically muted whenever the interrupt signal is received from the device. This function can be turned ON or OFF from the head unit by following procedure below.

- 1 Press and hold the **INTLZ** button for at least 2 seconds.
- 2 Press the **▶▶I UP** button to select the MUTE mode. Each press changes the modes as shown:
◀ FM-LV → REG → PTY31 → AMBER → DIM → SUB
DEMO ← AUX ← SCR ← MUTE ← BEEP ←
- NOTE**
If you press the **DN◀◀** button the display scrolls in reverse sequence.
- 3 Press the **TUNE** button to turn on or off the Mute mode.
Each press toggles between the MUTE ON and OFF modes.
NOTE
The initial setting at the factory is "MUTE ON."
- 4 Press and hold the **INTLZ** button for at least 2 seconds again to return to normal operation.

CD Text Scroll Setting

This CD player has the ability to scroll the disc and track name recorded on CD-Text discs. The scrolling feature will work with names greater than 8 characters.

- 1 Press and hold the **INTLZ** button for at least 2 seconds.
- 2 Press the **▶▶I UP** button repeatedly to select "SCR".
Each press of the **▶▶I UP** button changes the modes as shown:
◀ FM-LV → REG → PTY31 → AMBER → DIM → SUB
DEMO ← AUX ← SCR ← MUTE ← BEEP ←
- NOTE**
If you press the **DN◀◀** button the display scrolls in reverse sequence.
- 3 Press the **TUNE** button to toggle mode between SCR AUTO and MANU.
 - SCROLL AUTO: the display of CD text is scrolled continuously.
 - SCROLL MANUAL: the display is scrolled only when a disc is loaded or when a track is changed.
- 4 When the setting is completed, press and hold the **INTLZ** button for at least 2 seconds to return to the normal mode.
NOTES
 - Initial mode is "SCR MANU".
 - The unit scrolls only CD text names. The disc titles input manually (refer to page 18) cannot be scrolled.

Basic Operation

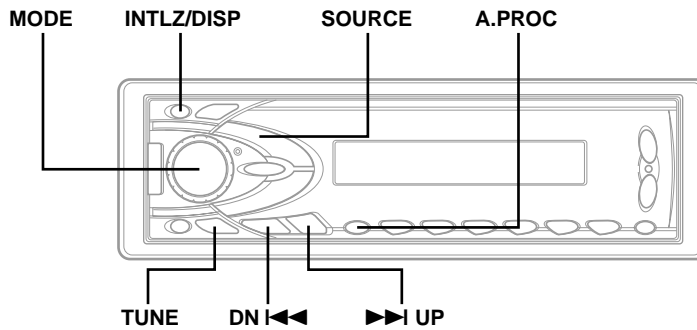

Setting the AUX Mode

You can input TV/video sound by connecting an optional Ai-NET/RCA Interface cable (KCA-121B) to this component.

- 1** Press and hold the **INTLZ** button for at least 2 seconds.
- 2** Press the **▶▶ UP** button repeatedly to select "AUX". Each press of the **▶▶ UP** button changes the modes as shown:

NOTE

If you press the **DN ◀◀** button the display scrolls in reverse sequence.

→ FM-LV → REG → PTY31 → AMBER → DIM → SUB → BEEP
 DEMO ← AUX (AUX Mode Display Setting*) ← SCR ← MUTE ←

* Displayed after AUX ON is set.

- 3** Press the **TUNE** button to toggle the mode between AUX ON and AUX OFF.

NOTES

- The initial setting at the factory is **AUX OFF**.
- You can set the **AUX** mode display by pressing the **DN ◀◀** or **▶▶ UP** button after **AUX ON** is set, select the **AUX** mode display setting, and then press the **TUNE** button.

- 4** Press and hold the **INTLZ** button for at least 2 seconds to return to the normal mode.

- 5** To adjust the volume, etc., first press the **SOURCE** button and select the **AUX** mode, then make the necessary adjustment.

→ TUNER → CD → AUX →

NOTE

When **AUX ON** is selected, you cannot select the changer to be used even for a connected changer.

Demonstration

This unit has the Demonstration feature which simulates the display functions on the display panel.

- 1** Press and hold the **INTLZ** button for at least 2 seconds.
- 2** Press the **▶▶ UP** button to select the DEMO mode. Each press changes the modes as shown:

→ FM-LV → REG → PTY31 → AMBER → DIM → SUB
 DEMO ← AUX ← SCR ← MUTE ← BEEP ←

NOTE

If you press the **DN ◀◀** button the display scrolls in reverse sequence.

- 3** Press the **TUNE** button to turn on or off the DEMO mode. Each press toggles between DEMO ON and DEMO OFF.

If no buttons are pressed 30 seconds after the DEMO mode is turned ON, "DEMO" blinks 3 times in the display. The DEMO mode then begins.

NOTE



The initial setting at the factory is "DEMO OFF."

- 4** Press and hold the **INTLZ** button for at least 2 seconds again to return to normal operation.

Adjusting the built -in Audio Processor

You can change the Bass/Treble Frequency emphasis, High Pass Filter, Low Pass Filter, and Sub Woofer Phase on this unit, so that you can create your favorite sound effects.

1 Press the **A.PROC** button for at least 3 seconds to enter Bass/Treble parameter setting mode.

2 Within 5 seconds, press the **DN**  or **UP**  button repeatedly to select the desired parameter.

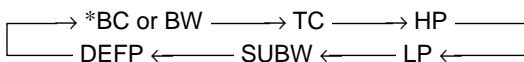

* Each time you press the MODE (Audio Control) knob, the BC and BW change alternately.

3 Press the **MODE** (Audio Control) knob to toggle between the BC and BW.

1. BC (Setting the Bass Frequency):

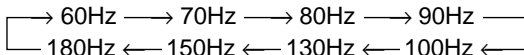

Emphasizes the displayed Bass frequency ranges.

2. BW (Setting the Bass Band Width): (Q-Factor)

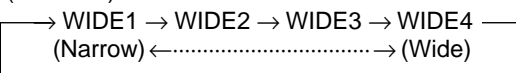

Changes the displayed frequency's band width to narrow or wide.

NOTE

A narrow or wide wave pattern on the display will indicate the selected band width.

3. TC (Setting the Treble Frequency):

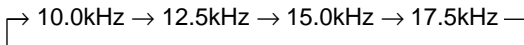

Emphasizes the displayed treble frequency ranges.

4. HP (Setting the High Pass Filter):

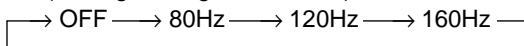

Outputs all frequencies higher than that selected according to your preference.

5. LP (Setting the Low Pass Filter):

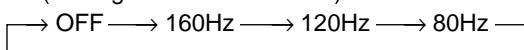

Outputs all frequencies lower than that selected according to your preference. (Only available when using the subwoofer output from this unit.)

6. SUBW (Change the Subwoofer Phase): NOR ↔ REV

You can change the subwoofer phase. (Only available when using the subwoofer output from this unit.)

7. DEFP (Defeat On and Off): ON ↔ OFF

When DEFEAT is turned ON, all items 1 to 6 are set to default values.

When DEFEAT is turned OFF, all items 1 to 6 resume their last set values.

Default values

- BC: 80 Hz
- BW: WIDE1
- TC: 10.0kHz
- HP: OFF
- LP: OFF
- SUBW (Phase): NOR

NOTES

- If you turn the battery power OFF, all settings return to factory default.
- If HP, LP, BC, and TC are all set to ON, depending on the BC and TC settings, you may not be able to reinforce the sound effect.
- Except when the HP and LP is turned OFF, the subwoofer is in monaural mode.
- When the subwoofer is set to OFF, LP mode and change of phase does not work.
- If no buttons are pressed within 5 seconds, the display for setup menu disappears while an ordinary menu appears on the display.

Switching the Display Modes

1 Press the **DISP** (DISPLAY) button to select the desired Display pattern mode.

Each press changes the display patterns.

Pattern	Description
1	Frequency Pattern
2	Normal Pattern (Upward)
3	Peak Value Increasing Pattern
4	Elevator (left/right) Pattern
5	Elevator (up/right) Pattern
6	Warp Pattern
7	Center Division Pattern
8	Scan Display (Repeats from Pattern 1 to Pattern 7 for every 5 seconds endlessly.)
9	Mode Display
10	Silent Display (Spectrum analyzer off)

Radio Operation

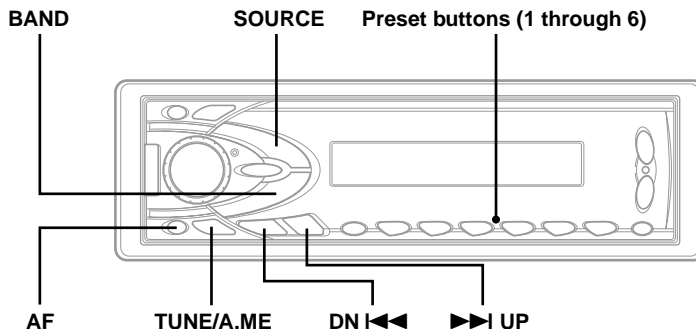

Manual Tuning

- 1 Press the **SOURCE** button until a radio frequency appears in the display.
- 2 Press the **BAND** button repeatedly until the desired radio band is displayed. Each press changes the band:
→ FM1 → FM2 → FM3 → MW → LW
- 3 Press the **TUNE** button repeatedly until "DX SEEK" and "SEEK" disappear from the display.

NOTE

The initial mode is DX SEEK.

- 4 Press the **DN I◀◀** or **▶▶ I UP** button to move downward or upward one step respectively until the desired station frequency is displayed.

NOTE

The ST indicator appears on the display when a Stereo FM station is tuned in.

Automatic Seek Tuning

- 1 Press the **SOURCE** button until a radio frequency appears in the display.
- 2 Press the **BAND** button repeatedly until the desired radio band is displayed. Each press changes the band:
→ FM1 → FM2 → FM3 → MW → LW
- 3 Press the **TUNE** button to illuminate the DX and SEEK indicators in the display. With the DX (Distance) mode activated, both strong and weak stations will be tuned in the Auto-Seek operation. Press again to return to the local mode. The DX indicator will turn off and the SEEK indicator will remain illuminated. Now, only strong stations will be tuned.
- 4 Press the **DN I◀◀** or **▶▶ I UP** button to automatically seek for a station downward or upward respectively. The unit will stop at the next station it finds. Press the same button again to seek the next station.

Manual Storing of Station Presets

- 1 Select the radio band and tune in a desired radio station you wish to store in the preset memory.
- 2 Press and hold any one of the **Preset buttons (1 through 6)** for at least 2 seconds until the station frequency on the display blinks.
- 3 Press the **Preset** button into which you wish to store the station while the frequency display is blinking (within 5 seconds).
The display stops blinking once the station has been memorized. The display shows the band, preset No. with a triangle (△) and station frequency memorized.
- 4 Repeat the procedure to store up to 5 other stations onto the same band.
To use this procedure for other bands, simply select the band desired and repeat the procedure.
A total of 30 stations can be stored in the preset memory (6 stations for each band; FM1, FM2, FM3, MW and LW).

NOTE

If you store a station in a preset memory which already has a station, the current station will be cleared and replaced with the new station.

Automatic Memory of Station Presets

- 1 Press the **SOURCE** button to select the radio mode.
- 2 Press the **BAND** button repeatedly until the desired radio band is displayed.
- 3 Press and hold the **A. ME** button for at least 2 seconds.
The frequency on the display continues to change while the automatic memory is in progress. The tuner will automatically seek and store 6 strong stations in the selected band. They will be stored into presets 1 to 6 buttons in order of signal strength.
When the automatic memory has been completed, the tuner goes to the station stored in the preset location No. 1.

NOTE

If no stations are stored, the tuner will return to the original station you were listening to before the auto memory procedure began.

Tuning to Preset Stations

- 1 Press the **SOURCE** button to select the radio mode.
- 2 Press the **BAND** button repeatedly until the desired band is displayed.
- 3 Press the station **Preset** button that has your desired radio station in memory.
The display shows the band, preset number with a triangle and frequency of the station selected.

Auto Station Search While Travelling

This function will automatically search for up to 12 stations receivable in the region you are in and store them in temporary memory.
Use this function when you are travelling in a region away from home.

- 1 Press the **BAND** button repeatedly until the desired radio band is displayed.
Each press changes the radio bands as follows:
→ FM1 → FM2 → FM3 → MW → LW →
- 2 Press and hold the **AF** button for at least 2 seconds to activate the Travel Search mode. The unit will automatically search and store up to 12 stations (max.) receivable in the region you are travelling.
- 3 To recall a station stored, press the **DN** ◀◀ or ▶▶ **UP** button.
- 4 To deactivate the Travel Search mode, press the **AF** button for at least 2 seconds.

NOTES

- If no stations are stored, the display shows "NO MEMORY."
- When the radio band is changed, the stations stored in memory using this function will be erased.

RDS Operation

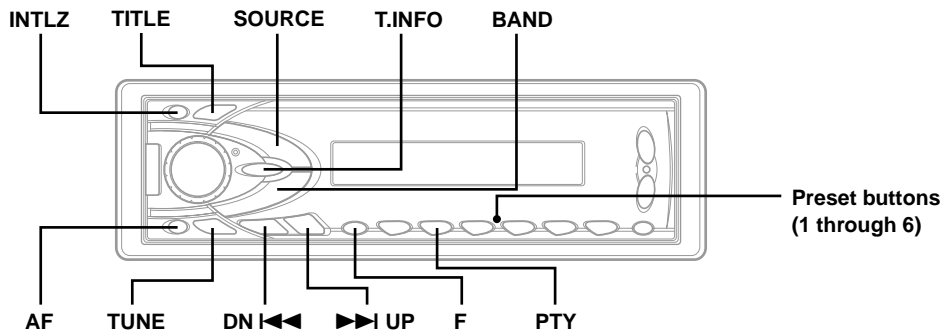

Setting RDS Reception Mode and Receiving RDS Stations

The RDS (Radio Data System) is a radio information system using the 57 kHz subcarrier of regular FM broadcast. The RDS allows you to receive a variety of information such as traffic information, station names, and to automatically re-tune to a stronger transmitter that is broadcasting the same programme.

- 1 Press the **SOURCE** button until a radio frequency appears in the display.
- 2 Press the **AF** button to activate the RDS mode.
- 3 Press the **DN I◀◀** or **▶▶ I UP** button to tune in the desired RDS station.

NOTE

When the **BAND** button is pressed for at least 2 seconds while the **PS** (Programme Service Name) is being displayed, the display shows the station frequency. To show the **PS** (Programme Service Name) in the display, press the **BAND** button for at least 2 seconds again.

When the RDS station signal received has become weak:

AF seek mode, press and hold the **TITLE** button for at least 2 seconds to have the unit automatically seek a stronger station in the **AF** list.

If there is no **AF** station, the display shows "SEEK END."

- 4 Press the **AF** button to deactivate the RDS mode.

Tips

The RDS digital data includes the followings:

PI	Programme Identification
PS	Programme Service Name
AF	List of Alternative Frequencies
TP	Traffic Programme
TA	Traffic Announcement
PTY	Programme Type
EON	Enhanced Other Networks
R.TEXT	Radio Text Information

Recalling Preset RDS Stations

- 1 Press the **AF** button to activate the RDS mode. The display shows "AF" when the RDS mode is activated.
- 2 Press the **1 through 6 buttons** in which your desired RDS station is preset. If the preset station's signal is weak, the unit automatically searches and tunes to a stronger station in the **AF** (Alternative Frequencies) list.
- 3 If the preset station and the stations in the **AF** list cannot be received:

The unit searches again for a station in the **PI** (Programme Identification) list.

If there are still no stations receivable in the area, the unit displays the frequency of the preset station and the preset indicator disappears.

If the signal level of the Regional (Local) station being tuned becomes too weak to receive, press the same preset location button to tune in a Regional station in other district.

NOTE

For presetting the RDS stations, refer to the Radio Operation section. The RDS stations can be preset in the **FM1**, **FM2** and **FM3** bands only.

Receiving RDS Regional (Local) Stations

- 1 Press and hold the **INTLZ** button for at least 2 seconds to activate the setting mode.
- 2 Press the **▶▶ UP** button repeatedly to select "REG" Each press of the **▶▶ UP** button scrolls the modes as shown:
→ FM-LV → REG → PTY31 → AMBER → DIM → SUB
[DEMO ← AUX ← SCR ← MUTE ← BEEP ←]
NOTE
If you press the **DN ◀◀** button the display scrolls in reverse sequence.
- 3 Press the **TUNE** button to turn on or off the REG (Regional) mode.
In the REG OFF mode, the unit automatically keeps receiving the related local RDS station.
- 4 Press and hold the **INTLZ** button for at least 2 seconds to deactivate the setting mode.

Receiving Traffic Information

- 1 Press the **T.INFO** button to activate the Traffic Information mode.
To cancel the Traffic information mode, press the **T.INFO** button again.
- 2 Press the **DN ◀◀** or **▶▶ UP** button to select your desired traffic information station. When a traffic information station is tuned in, the TP indicator lights up.

Traffic information is heard only when it is being broadcast. If traffic information is not being broadcast, the unit is set in the standby mode. When a traffic information broadcast begins, the unit automatically receives it and the display shows "TRF-INFO" for 5 seconds, then returns to the previous display.

When traffic information broadcast is over, the unit will automatically set in the standby mode.

NOTES

- If the traffic information broadcast signal falls below a certain level, the unit remains in the receiving mode for 1 minute. If the signal remains below a certain level for over 1 minute, the "T.INFO" indicator blinks.
- If you do not want to listen to the traffic information being received, lightly press the **T.INFO** button to skip that traffic information message. The **T.INFO** mode will remain in the ON position to receive the next traffic information message.
- If the volume level is changed while receiving traffic information, the changed volume level will be memorized. When traffic information is received next time, the volume level will be automatically adjusted to the level memorized.
- In the **T.INFO** mode, the **SEEK** tuning selects only the TP stations.

PTY (Programme Type) Tuning

- 1 Press the **"F"** button. The **FUNC** indicator will illuminate.
- 2 Press the **PTY** button to activate the PTY mode. The Programme Type of the station being currently received will be displayed for 5 seconds.
 - If there is no receivable PTY broadcast, "NO PTY" will be displayed for 5 seconds.
 - If no RDS station can be received, the display shows "NO PTY."**NOTE**
If no button is pressed within 5 seconds after pressing the **PTY** button, the **PTY** mode will be automatically cancelled.
- 3 Press the **DN ◀◀** and **▶▶ UP** buttons within 5 seconds after activating the **PTY** mode to choose the desired programme type while the **PTY** (programme type) is being displayed. Each press scrolls the programme type by one.

→ LIGHT M → CLASSICS → OTHER M
[-----]
- 4 Press the **PTY** button within 5 seconds after selecting the programme type to start searching for a station in the selected programme type. The chosen programme type indicator blinks during searching and lights when a station is found.

If no station is found, "NO PTY" will be displayed for 5 seconds.
- 5 Press the **"F"** button to activate the normal mode. The **FUNC** indicator will turn off.

NOTE

Operate the unit while the **FUNC** indicator is illuminated.

If no buttons are pressed within 5 seconds, the **FUNC** indicator will turn off.

RDS Operation

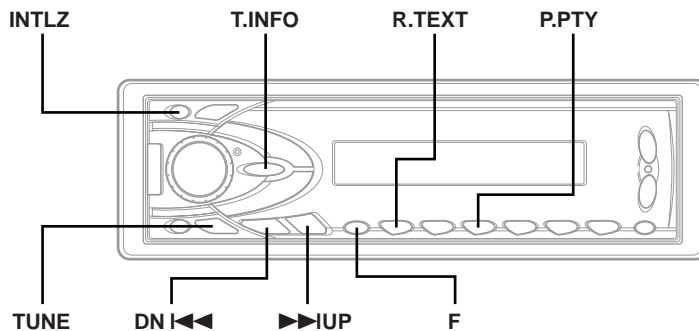

Receiving Traffic Information While Playing CD or Radio

- 1 Press the **T.INFO** button repeatedly until the T.INFO indicator appears in the display.
- 2 Press the **DN** and **UP** buttons to select a traffic information station if necessary.
 - When a traffic information broadcast starts, the unit automatically mutes the CD player or the regular FM broadcast.
 - When the traffic information broadcast finishes, the unit automatically returns to the original source play before the traffic information broadcast began.
 - **When traffic information stations cannot be received:**
 - In the tuner mode:
When the TP signal can no longer be received for over 1 minute, the "T.INFO" indicator blinks.
 - In the CD mode:
When the TP signal can no longer be received, the traffic information station of another frequency will be selected automatically.

NOTE

The receiver is equipped with the EON (Enhanced Other Networks) function in order to keep track of additional alternative frequencies to the AF list. The EON indicator appears while an RDS EON station is being received. If the station being received does not broadcast the traffic information, the receiver automatically tunes in the related station that broadcasts the traffic information when it occurs.

- 3 Press the **T.INFO** button to deactivate the Traffic Information mode. The T.INFO indicator disappears.

Priority PTY (Programme Type)

This function allows presetting of a programme type such as music category, news, etc. You can listen to a programme in the preset programme type as the unit automatically gives priority to the preset programme type when it begins broadcasting, and interrupts the programme you are currently listening. This feature is functional when your unit is set to a mode other than the LW and MW.

- 1 Press the "**F**" button. The FUNC indicator will illuminate.
- 2 Press the **P. PTY** button to activate the PRIORITY PTY mode. "PRIO-PTY" is displayed for 2 seconds and then the programme type for 3 seconds. The initial setting is "NEWS."
NOTE
If no button is pressed within 5 seconds after pressing the P. PTY button, the PRIORITY PTY mode is automatically cancelled.
- 3 Press the **DN** or **UP** button within 5 seconds while "NEWS" is being displayed to choose a desired programme type. Then press **P. PTY** button. The PRIORITY PTY function will activate.

- 4** Press the **P. PTY** button to activate the PRIORITY PTY mode again.
- To change the programme category, perform the step 3.
 - To disable the PRIORITY PTY function, press the **P. PTY** button.

NOTE

In the PRIORITY PTY function, unlike in the T.INFO function, the volume does not increase during operation.

- 5** Press the **"F"** button to activate the normal mode. The FUNC indicator will turn off.

NOTE

*Operate the unit while the FUNC indicator is illuminated.
If no buttons are pressed within 5 seconds, the FUNC indicator will turn off.*

Turning Emergency Alarm On or Off

- 1** Press and hold the **INTLZ** button for at least 2 seconds.
- 2** Press the **▶▶ UP** button repeatedly to select "PTY31" Each press of the **▶▶ UP** button scrolls the modes as shown.
- FM-LV → REG → PTY31 → AMBER → DIM → SUB
 [DEMO ← AUX ← SCR ← MUTE ← BEEP ←]

NOTE

*If you press the **DN ◀◀** button the display scrolls in reverse sequence.*

- 3** Press the **TUNE** button repeatedly to select the PTY31 ON or PTY31 OFF mode.
In the PTY31 ON mode, the unit will show "ALARM" in the display when the unit receives the PTY31 (Emergency Broadcast) signal.
- 4** Press and hold the **INTLZ** button for at least 2 seconds to activate the selected mode.

Displaying Radio Text

Text messages from a radio station can be displayed.

- 1** Tune in a radio station that transmits text messages.
- 2** Press the **"F"** button. The FUNC indicator illuminates.
- 3** Press the **R.TEXT** button to activate the Radio Text mode. The display shows "WAIT" for a few seconds, then starts scrolling the text message. It continues until other operation is performed.
- 4** To cancel the Radio Text mode, press the **R.TEXT** button.
- 5** Press the **"F"** button to return to the normal operation mode. The FUNC indicator disappears from the display.

NOTES

- *If there is no receivable text message or the unit cannot receive a text message properly, the display shows "NO TEXT" for 2 seconds.*
- *Operate the unit while the FUNC indicator is illuminated.
If no buttons are pressed within 5 seconds, the FUNC indicator will turn off.*

CD Player Operation

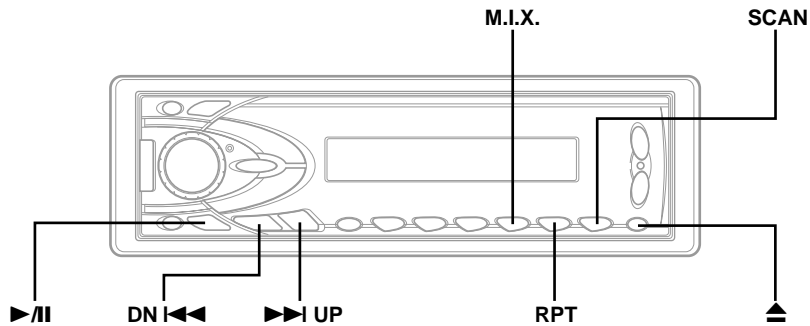

Opening and Closing the Movable display

- 1 Press the ▲ button.
The movable display will open.

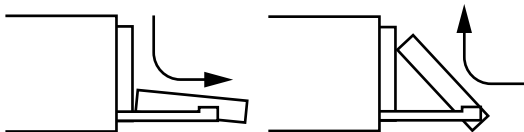

(Movable display fully opened)

To close the movable display, press the ▲ button again.

The movable display will close.

NOTES

- Do not apply shock to the movable display when it is open as it may result in malfunction of the unit.
- The display may be dim during low temperatures and immediately after turning on the power. The brightness will return to normal as time elapses.
- The display will stop at the set angle when closing.

CAUTION

Keep hands (or any other object) away from the display while it is opening or closing to avoid damage or injury. The back of the movable display will get very warm under normal operating conditions. This is not a malfunction. Do not touch.

Playback

- 1 Press the ▲ button.
The movable display will open.

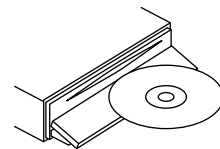

Insert a disc with the label side facing up.

- 2 Insert a disc with the label side facing up.
The disc will be pulled into the unit automatically. The movable display will close and playback will begin.

When a disc is already inserted, press the SOURCE button to switch to the CD mode. The mode will change every time the button is pressed.

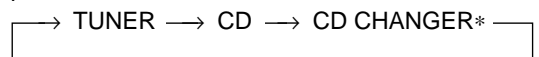

(* Only when the CD changer is connected)

- 3 To pause playback, press the ►|| button. Pressing the ►|| button again will resume playback.

- 4 To eject the disc, press the ▲ button.

NOTES

- Three-inch (8cm) CD's can be used.
- If the CD does not eject, press ▲ button again for at least 3 seconds with the movable display open.
- Only com.pact discs containing the mark shown can be used.



- We cannot fully guarantee the playback of CD-R (CD-Recordable). You cannot playback CD-RW (CD-ReWritable) on this unit.

Music Sensor (Skip)

- 1 Momentarily press the **DN**  button once during CD play to return to the beginning of the current track. If you wish to access the beginning of a track further back, repeatedly press until you reach the desired track.

Press the **▶▶** **UP** button once to advance to the beginning of the next track. If you wish to access the beginning of a track further ahead, press repeatedly until the desired track is reached.

NOTE

The music sensor feature is functional in the play or pause mode.

Fast Forward and Backward

- 1 Press and hold the **DN**  or **▶▶** **UP** button to quickly move backward or forward until you reach the desired section of the track.

Repeat Play

- 1 Press the **RPT**(Repeat) button to play back repeatedly the track being played. The RPT indicator appears and the track will be played repeatedly.

Press the **RPT** button again and select OFF to deactivate the repeat play.

NOTES

- If a CD Changer is connected and the **REPEAT ALL** mode is selected, the unit repeatedly plays back all tracks on the disc selected.

→ REPEAT → REPEAT ALL → (off) →

- In case a 6-disc CD changer is connected:
In CD changer mode, press the "F" button to illuminate the FUNC indicator and go to step 1 within 5 seconds.
- In case a 12-disc CD changer is connected:
In changer mode, press the "F" button twice to illuminate the FUNC indicator and go to step 1 within 5 seconds.

M.I.X. (Random Play)

- 1 Press the **M.I.X.** button in the play or pause mode. The M.I.X. indicator will illuminate and the tracks on the disc will be played back in a random sequence. After all the tracks on the disc have been played back once, the player will begin a new random sequence play until the M.I.X. mode is cancelled.

To cancel M.I.X. play, press the **M.I.X.** button again to turn off the M.I.X.

NOTES

- If a CD Changer equipped with the **ALL M.I.X.** function is connected, **ALL M.I.X.** will also be selectable. In this mode, the tracks on all the CDs in the current magazine will be included in the random playback sequence.

→ M.I.X. → ALL M.I.X. → (off) →

- In case a 6-disc CD changer is connected:
In CD changer mode, press the "F" button to illuminate the FUNC indicator and go to step 1 within 5 seconds.
- In case a 12-disc CD changer is connected:
In changer mode, press the "F" button twice to illuminate the FUNC indicator and go to step 1 within 5 seconds.

Scanning Programmes

- 1 Press the **SCAN** button to activate the Scan mode. The first 10 seconds of each track will be played back in succession.

To stop scanning, press the **SCAN** button and deactivate the Scan mode.

NOTES

- In case a 6-disc CD changer is connected:
In CD changer mode, press the "F" button to illuminate the FUNC indicator and go to step 1 within 5 seconds.
- In case a 12-disc CD changer is connected:
In changer mode, press the "F" button twice to illuminate the FUNC indicator and go to step 1 within 5 seconds.

CD Player Operation

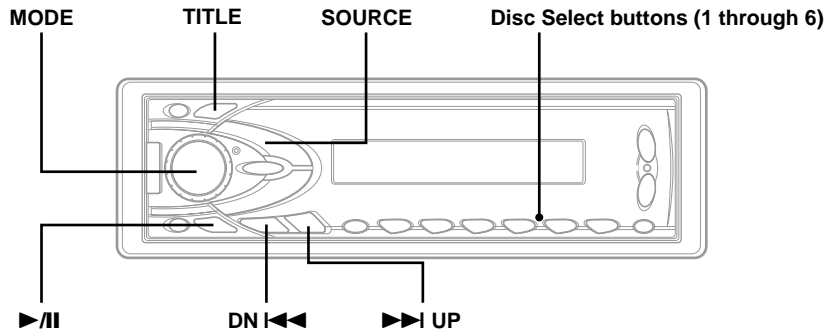

Displaying the Title/Text

It is possible to display the CD title if the title has been previously inputted. For details, see Titling Discs (see this page). Text information, such as the disc name and the track name, will be displayed if playing a CD text compatible disc.

- 1 Press the **TITLE** button.
The mode will change every time the button is pressed.

About "Title" and "Text"

Title: With this device, it is possible to input the CD name (see this page). This inputted name is referred to as a "title."

Text: Text compatible CDs contain text information such as the disc name and track name. Such text information is referred to as "text."

CD/Changer mode:

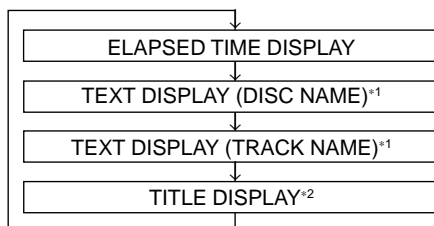

*1 Displayed during playback of text compatible CD. "NO TEXT" will be displayed when the CD is not text compatible.

*2 "-----" will be displayed when the title has not been inputted.

Sample display when text compatible CD

NOTES

- Some characters may not be displayed correctly with this device, depending on the character type.
- The display may not show all the information of the CD Text depending on the CD changer.

Titling Discs

- 1 Press the **TITLE** button and select the title display mode.
For details, see Displaying the Title/Text (see this page).
- 2 Press and hold the **TITLE** button for at least 3 seconds. The first character will blink.
- 3 Rotate the **MODE** (Audio Control) knob to select the desired letter/numeral/symbol available for naming. ("A" for example).
- 4 Press the **MODE** (Audio Control) button to store the first character. The first character will stop blinking and the display will automatically advance to the next character. When that character begins to blink, you may choose the next letter or symbol of your title.

- 5** Repeat the steps 3 and 4 above to complete the titling. Pressing the **MODE** (Audio Control) button after entering the eighth character, automatically stores the title into memory.

When entering a title of less than 8 characters (for example, 3 character title):

After entering 3 characters to complete your title, the 4th character space will be blinking. Go to step 6 to complete the title.

- 6** Press and hold the **TITLE** button for at least 3 seconds to record the title.

NOTES

- The memory capacity for the disc titles is 18. If you try to store beyond the limit, the display will show "FULL DATA." At this point, no more titles can be stored.
- To input a new title, one of the previously inputted titles must first be deleted.
- When you want to erase a title, enter the "☐" symbol into all spaces.
- The CD Changer title length or memory capacity varies depending upon the model being used.
- Removing power from the unit may delete these titles. Use caution when manipulating the power cord.

Erasing Disc Title

- 1** Press the **TITLE** button to select the disc titling mode. Then, press and hold for at least 3 seconds.
- 2** Press and hold the **▶/||** button for at least 2 seconds to activate the title scanning mode. The title in the display will blink.
- 3** Press the **DN ◀◀** or **▶▶ UP** button repeatedly until the disc title you want to erase is displayed.
- 4** Press and hold the **▶/||** button for at least 2 seconds to erase the disc title displayed.
- 5** Press and hold the **TITLE** button for at least 3 seconds to cancel the disc title erasing mode.

NOTE

You cannot erase a CD-TEXT.

Controlling CD Changer (Optional)

An optional 6-disc or 12-disc CD Changer may be connected to the CDA-7865R if it is Ai-NET compatible. With a CD Changer connected to the Ai-NET input of the CDA-7865R, the CD Changer will be controllable from the CDA-7865R.

Using the KCA-400C (the Multi-Changer Switching device) multiple changers can be controlled by the CDA-7865R.

See the Multi-Changer Selection section on page 20 for selecting the CD Changers.

NOTES

- The controls on the CDA-7865R for CD Changer operation are operative only when a CD Changer is connected.
- The "Changer" indicator illuminates in the CD Changer mode.

- 1** Press the **SOURCE** button to activate the CHANGER mode. The display shows the "Changer," disc number and track number.

NOTE

The source indicator varies depending on the connected source.

- 2** Press the **Disc Select buttons (1 through 6)** corresponding to one of the discs loaded in the CD Changer. The selected disc number appears in the display and CD playback starts.

NOTES

- After selecting the desired disc, you can operate in the same way as for the CDA-7865R CD player. For details, please see the CD Operation section.
- If the FUNC indicator is illuminated the Disc Select buttons become nonfunctional.

When a 12-disc CD Changer is connected:

To select discs numbered from 1 to 6, the procedure is the same as for the 6-disc CD Changer. To select discs numbered from 7 to 12, first press the "F" button. This changes the "D" indicator to "d." Then press the desired Preset button. With the "F" button activated, the Preset buttons 1 to 6 will represent discs 7 to 12 respectively.

CD Player Operation

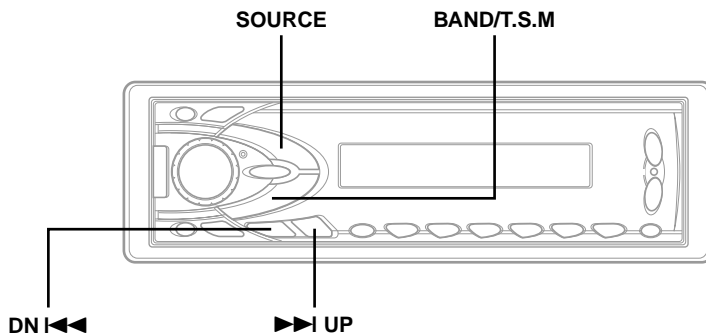

Searching for Titled Discs (CD Changer only)

If a CD is titled, you can do a search for it. (To title CDs, refer to "Titling Discs" on page 18.)

- 1 Press and hold the **T.S.M.** button for at least 2 seconds. The title blinks in the display.
- 2 Press the **DN I<<** or **>>I UP** button to select the desired disc title.
- 3 Press the **T.S.M.** button to play the selected disc. The unit will automatically search for the disc and begin play.
- 4 Press the **T.S.M.** button for at least 2 seconds to cancel the disc searching mode.

NOTE

This function cannot be performed when using a multi-changer switching device.

Multi-Changer Selection

Alpine's Ai-NET system will support up to 6 CD Changers. When operating two or more changers, the KCA-400C (Multi-Changer Switching device) must be used. If you use 1 Switching device, you can connect up to 4 CD Changers. If you use 2 Switching devices, you can connect up to 6 CD Changers.

- 1 Press the **SOURCE** button on the CDA-7865R to activate the CD Changer mode.

Alternatively, press the SOURCE button on the Remote Control (RUE-4185) to activate the CD Changer mode. Proceed to Step 3 below to select the desired CD Changer.

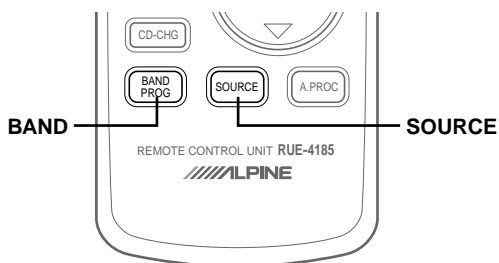

- 2 Press the **BAND** button on the CDA-7865R or the RUE-4185 to activate the CD Changer Selection mode.
- 3 The CD Changer Selection mode remains active for 3 seconds after Step 2 is performed. Press the **BAND** button until the desired CD Changer indicator appears on the display.

NOTE

If the selected CD Changer is not connected, the display will show "NO CHGRX."

Alternatively press the **BAND** button on the Remote Control until the desired changer indicator appears on the display.

- 4 To operate the selected changer, see "CD Operation" section.

Remote Control Operation

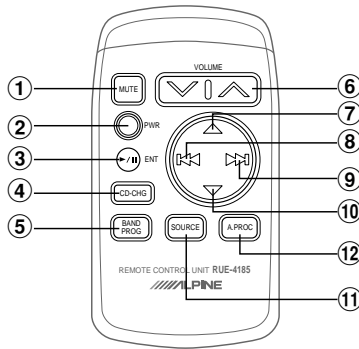

Controls on Remote Control

① Mute Button

Press the button to lower the volume by 20 dB instantly. Press the button again to cancel.

② Power Switch

Press the switch to turn the power on/off.

③ Play/Pause Button

Press the button to switch between the Play and Pause modes for CD.

④ CD Changer Button

Press the button to change to the CD changer operation.

⑤ Band/Programme Button

Radio mode: BAND Button

Press the button and the band will change as shown below.

→ FM1 → FM2 → FM3 → MW → LW

⑥ Volume Adjustment Buttons

To increase the volume level:

Press the ▲ button

To decrease the volume level:

Press the ▼ button

⑦ ▲ Button

Radio mode: Pressing the button will select, in ascending order, stations programmed into the radio's presets as shown below.

→ 1 → 2 ... 6

CD Changer mode: DISC Select (UP) Button

Press the button to select a disc in ascending order.

⑧ ◀◀ Button

Radio mode: SEEK (DN) Button

CD mode: Press the button to go back to the beginning of the current track.

⑨ ▶▶ Button

Radio mode: SEEK (UP) Button

CD mode: Press the button to advance to the beginning of the next track.

⑩ ▼ Button

Radio mode: Pressing the button will select, in descending order, stations programmed into the radio's presets as shown below.

→ 6 → 5 ... 1

CD Changer mode: DISC Select (DN) Button

Press the button to select a disc in descending order.

⑪ Source Button

Press to select the audio source.

⑫ Audio Processor Button**

Press the button to call the external audio processor mode.*

* For the operation of external audio processor, refer to the Owner's Manual of the external audio processor you purchased.

** This button is used in conjunction with an optional Ai-NET processor.

Battery Replacement

Applicable battery: Use two "AAA" sized dry batteries or equivalent.

- 1** Opening the battery cover
Slide out the battery cover while firmly pressing outward.

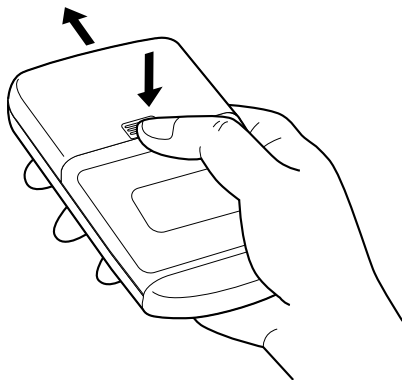

- 2** Replacing the battery
Put the batteries in the case observing the polarities as illustrated.

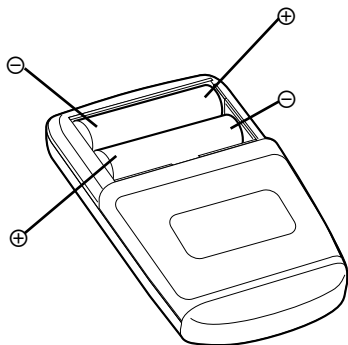

- 3** Closing the cover
Push the cover as illustrated until a click is heard.

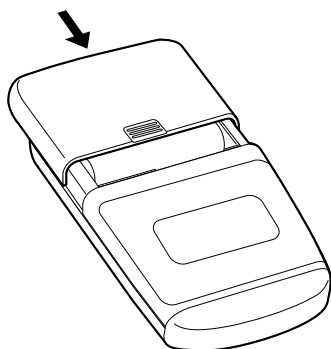

Information

In Case of Difficulty

If you encounter a problem, please review the items in the following checklist. This guide will help you isolate the problem if the unit is at fault. Otherwise, make sure the rest of your system is properly connected or consult your authorized Alpine dealer.

Basic

No function or display.

- Vehicle's ignition is off.
 - If connected following instructions, the unit will not operate with the vehicle's ignition off.
 - Improper power lead connections.
 - Check power lead connections.
 - Blown fuse.
 - Check the fuse on the battery lead of the unit; replace with the proper value if necessary.
 - Internal micro-computer malfunctioned due to interference noise etc.
 - Press the RESET switch with a ball-point pen or other pointed article.
-

Radio

Unable to receive stations.

- No antenna or open connection in cable.
 - Make sure the antenna is properly connected; replace the antenna or cable if necessary.

Unable to tune stations in the seek mode.

- You are in a weak signal area.
 - Make sure the tuner is in the DX mode.
- If the area you are in is a primary signal area, the antenna may not be grounded and connected properly.
 - Check your antenna connections; make sure the antenna is properly grounded at its mounting location.
- The antenna may not be the proper length.
 - Make sure the antenna is fully extended; if broken, replace the antenna with a new one.

Broadcast is noisy.

- The antenna is not the proper length.
 - Extend the antenna fully; replace it if it is broken.
 - The antenna is poorly grounded.
 - Make sure the antenna is grounded properly at its mounting location.
-

CD

CD Player/Changer not functioning.

- Out of operating temperature range +50°C (+120°F) for CD.
 - Allow the vehicle's interior (or trunk) temperature to cool.

CD playback sound is wavering.

- Moisture condensation in the CD Module.
 - Allow enough time for the condensation to evaporate (about 1 hour).

CD insertion not possible.

- A CD is already in the CD player.
 - Eject the CD and remove it.
- The CD is being improperly inserted.
 - Make sure the CD is being inserted following instructions in the CD Player Operation section.

Unable to fast forward or backward the CD.

- The CD has been damaged.
 - Eject the CD and discard it; using a damaged CD in your unit can cause damage to the mechanism.

CD playback sound skips due to vibration.

- Improper mounting of the unit.
 - Securely re-mount the unit.
- Disc is very dirty.
 - Clean the disc.
- Disc has scratches.
 - Change the disc.

CD playback sound skips without vibration.

- Dirty or scratched disc.
 - Clean the disc; damaged disc should be replaced.

Error displays (built-in CD player only)

- Mechanical error
 - Press the ▲ button. After the error indication disappears, insert the disc again. If the above-mentioned solution does not solve the problem, consult your nearest ALPINE dealer.

Information

Indication for CD Changer

HI TEMP

- Protective circuit is activated due to high temperature.
 - The indicator will disappear when the temperature returns to within operation range.
-

ERROR - 01

- Malfunction in the CD Changer.
 - Consult your Alpine dealer. Press the magazine eject button and pull out the magazine. Check the indication. Insert the magazine again. If the magazine cannot be pulled out, consult your Alpine dealer.
 - Magazine ejection not possible.
 - Press the magazine eject button. If the magazine does not eject, consult your Alpine dealer.
-

ERROR - 02

- A disc is left inside the CD Changer.
 - Press the Eject button to activate the eject function. When the CD Changer finishes the eject function, insert an empty CD magazine into the CD Changer to receive the disc left inside the CD Changer.

NO MAGZN

- No magazine is loaded into the CD Changer.
 - Insert a magazine.
-

NO DISC

- No indicated disc.
 - Choose another disc.
-

Specifications

FM TUNER SECTION

Tuning Range	87.5 – 108.0 MHz
Mono Usable Sensitivity	0.7 μ V
Alternate Channel Selectivity	80 dB
Signal-to-Noise Ratio	65 dB
Stereo Separation	35 dB

MW TUNER SECTION

Tuning Range	531 – 1,602 kHz
Sensitivity (IEC Standard)	25.1 μ V/28 dB

LW TUNER SECTION

Tuning Range	153 – 281 kHz
Sensitivity (IEC Standard)	31.6 μ V/30 dB

CD SECTION

Frequency Response	5 – 20,000 Hz (\pm 1 dB)
Wow & Flutter (% WRMS)	Below measurable limits
Total Harmonic Distortion	0.008% (at 1 kHz)
Dynamic Range	95 dB (at 1 kHz)
Signal-to-Noise Ratio	105 dB
Channel Separation	85 dB (at 1 kHz)

REMOTE CONTROL

Battery Type	"AAA" sized dry battery
Battery Quantity	2
Dimensions (W \times H \times D)	56 mm (2-1/4") \times 14 mm (9/16") \times 105 mm (4-1/8")
Weight (without battery)	50 g (1.8 oz)

GENERAL

Power Requirement	14.4 V DC (11–16 V allowable)
Maximum Power Output	60 W \times 4
Output Voltage	4 V/10k ohms
Bass	\pm 14 dB at 60 Hz
Treble	\pm 14 dB at 10 kHz
Weight	1.5 kg (3 lbs. 5 oz)

CHASSIS SIZE

Width	178 mm (7")
Height	50 mm (2")
Depth	155 mm (6-1/8")

NOSEPIECE SIZE

Width	170 mm (6-3/4")
Height	46 mm (1-13/16")
Depth	19 mm (3/4")

Due to continuous product improvement, specifications and design are subject to change without notice.

Installation and Connections

Before installing or connecting the unit, please read the following and pages 2 and 3 of this manual thoroughly for proper use.

Warning

MAKE THE CORRECT CONNECTIONS.

Failure to make the proper connections may result in fire or product damage.

USE ONLY IN CARS WITH A 12 VOLT NEGATIVE GROUND.

(Check with your dealer if you are not sure.) Failure to do so may result in fire, etc.

BEFORE WIRING, DISCONNECT THE CABLE FROM THE NEGATIVE BATTERY TERMINAL.

Failure to do so may result in electric shock or injury due to electrical shorts.

DO NOT ALLOW CABLES TO BECOME ENTANGLED IN SURROUNDING OBJECTS.

Arrange wiring and cables in compliance with the manual to prevent obstructions when driving. Cables or wiring that obstruct or hang up on places such as the steering wheel, gear lever, brake pedals, etc. can be extremely hazardous.

DO NOT SPLICE INTO ELECTRICAL CABLES.

Never cut away cable insulation to supply power to other equipment. Doing so will exceed the current carrying capacity of the wire and result in fire or electric shock.

DO NOT DAMAGE PIPE OR WIRING WHEN DRILLING HOLES.

When drilling holes in the chassis for installation, take precautions so as not to contact, damage or obstruct pipes, fuel lines, tanks or electrical wiring. Failure to take such precautions may result in fire.

DO NOT USE BOLTS OR NUTS IN THE BRAKE OR STEERING SYSTEMS TO MAKE GROUND CONNECTIONS.

Bolts or nuts used for the brake or steering systems (or any other safety-related system), or tanks should NEVER be used for installations or ground connections. Using such parts could disable control of the vehicle and cause fire etc.

KEEP SMALL OBJECTS SUCH AS BOLTS OR SCREWS OUT OF THE REACH OF CHILDREN.

Swallowing them may result in serious injury. If swallowed, consult a physician immediately.

DO NOT INSTALL IN LOCATIONS WHICH MIGHT HINDER VEHICLE OPERATION, SUCH AS THE STEERING WHEEL OR GEARSHIFT.

Doing so may obstruct forward vision or hamper movement etc. and results in serious accident.

Caution

HAVE THE WIRING AND INSTALLATION DONE BY EXPERTS.

The wiring and installation of this unit requires special technical skill and experience. To ensure safety, always contact the dealer where you purchased this product to have the work done.

USE SPECIFIED ACCESSORY PARTS AND INSTALL THEM SECURELY.

Be sure to use only the specified accessory parts. Use of other than designated parts may damage this unit internally or may not securely install the unit in place. This may cause parts to become loose resulting in hazards or product failure.

ARRANGE THE WIRING SO IT IS NOT CRIMPED OR PINCHED BY A SHARP METAL EDGE.

Route the cables and wiring away from moving parts (like the seat rails) or sharp or pointed edges. This will prevent crimping and damage to the wiring. If wiring passes through a hole in metal, use a rubber grommet to prevent the wire's insulation from being cut by the metal edge of the hole.

DO NOT INSTALL IN LOCATIONS WITH HIGH MOISTURE OR DUST.

Avoid installing the unit in locations with high incidence of moisture or dust. Moisture or dust that penetrates into this unit may result in product failure.

Precautions

- Be sure to disconnect the cable from the (-) battery post before installing your CDA-7865R. This will reduce any chance of damage to the unit in case of a short-circuit.
- Be sure to connect the color coded leads according to the diagram. Incorrect connections may cause the unit to malfunction or damage to the vehicle's electrical system.
- When making connections to the vehicle's electrical system, be aware of the factory installed components (e.g. on-board computer). Do not tap into these leads to provide power for this unit. When connecting the CDA-7865R to the fuse box, make sure the fuse for the intended circuit of the CDA-7865R has the appropriate amperage. Failure to do so may result in damage to the unit and/or the vehicle. When in doubt, consult your ALPINE dealer.
- The CDA-7865R uses female RCA-type jacks for connection to other units (e.g. amplifier) having RCA connectors. You may need an adaptor to connect other units. If so, please contact your authorized ALPINE dealer for assistance.
- Be sure to connect the speaker (-) leads to the speaker (-) terminal. Never connect left and right channel speaker cables to each other or to the vehicle body.

IMPORTANT

Please record the serial number of your unit in the space provided below and keep it as a permanent record. The serial number plate is located on the bottom of the unit.

SERIAL NUMBER: _____
INSTALLATION DATE: _____
INSTALLATION TECHNICIAN: _____
PLACE OF PURCHASE: _____

Installation

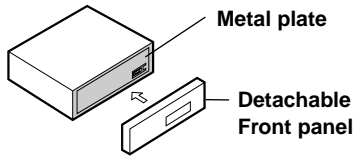

Caution

When you install this unit in your car, do not remove the Detachable Front Panel.

If the Detachable Front Panel is removed during installation, you might press too hard and warp the metal plate that holds it in place.

1

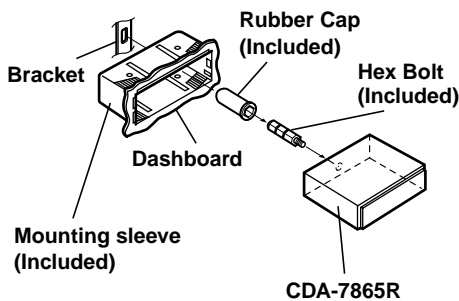

Remove the Detachable Front Panel (refer to page 4). Slide mounting sleeve from main unit (see Removal Procedure below). Slide the mounting sleeve into the dashboard.

2

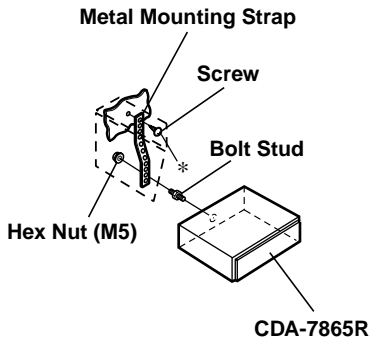

When your vehicle has the Bracket, mount the long hex bolt onto the rear panel of the CDA-7865R and put the Rubber Cap on the hex bolt. If your vehicle does not have the Mounting Support, reinforce the head unit with the metal mounting strap (not supplied). Connect all the leads of the CDA-7865R according to details described in the CONNECTIONS section.

NOTE

For the screw *, provide a proper screw to the chassis installing location.

- 3 Slide the CDA-7865R into the dashboard. When the unit is in place, make sure the locking pins are fully seated in the down position. This can be done by pressing firmly in on the unit while pushing the locking pin down with a small screwdriver. This ensures that the unit is properly locked and will not accidentally come out from the dashboard. Install the Detachable Front Panel.

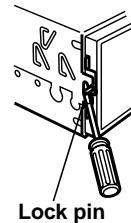

Removal

- 1 Remove the detachable front panel.
- 2 Use a small screwdriver (or similar tool) to push the locking pins to the "up" position (see above drawing). As each pin is unlocked, gently pull out on the unit to make sure it does not re-lock before unlocking the second pin.
- 3 Pull the unit out, keeping it unlocked as you do so.

<JAPANESE CAR>

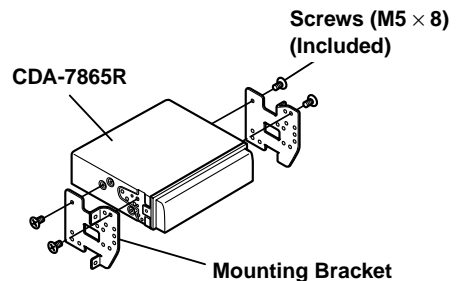
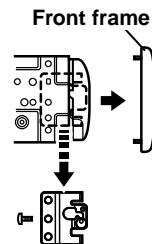

Installation and Connections

Connection

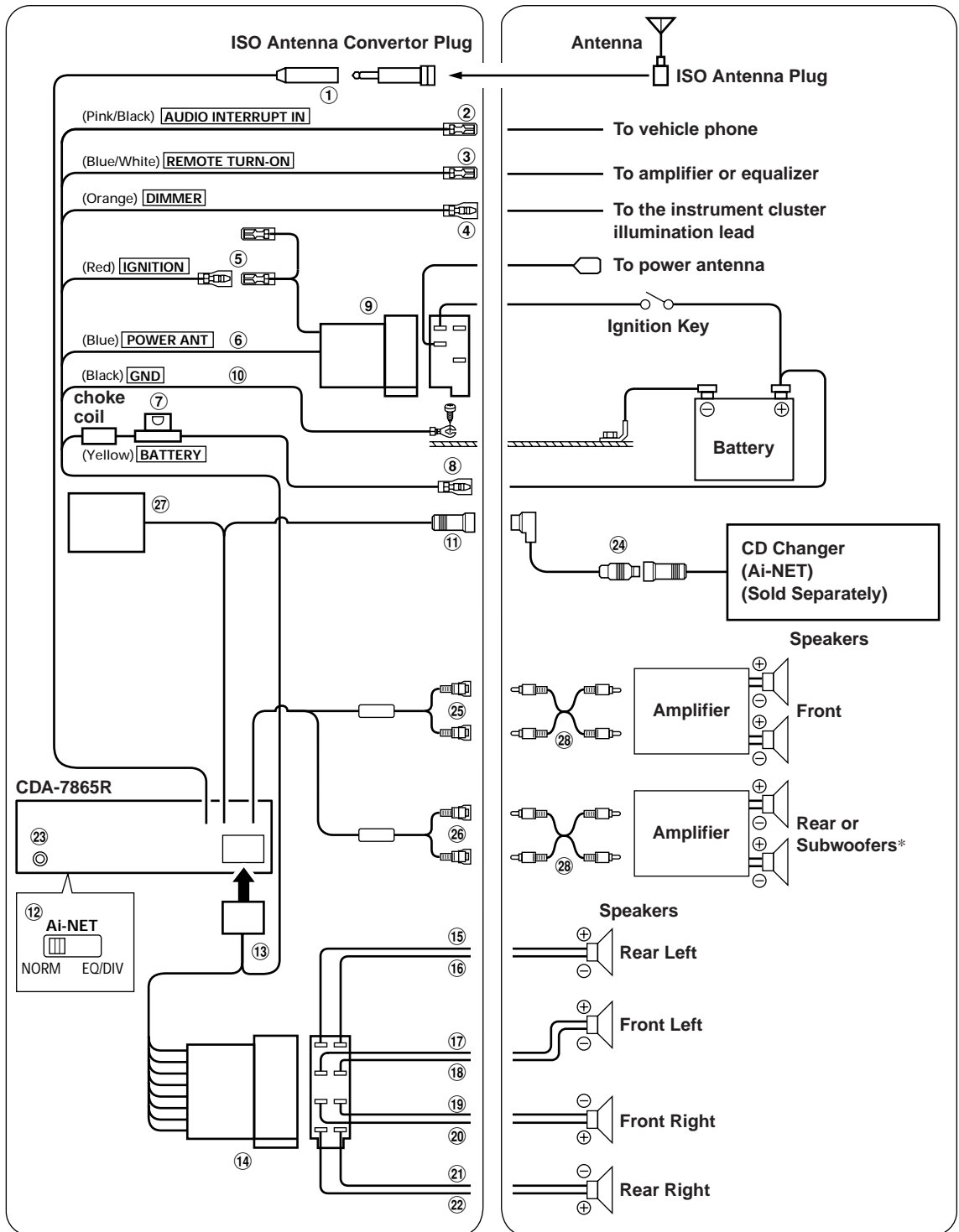

* When Subwoofer is set to OFF: Output is from Rear speakers.
When Subwoofer is set to ON: Output is from Subwoofer.

For details on how to set the Subwoofer to ON/OFF, see "Subwoofer On and Off" on page 7.

- ① **Antenna Receptacle**
Connect to the supplied ISO antenna convertor plug.
- ② **Audio Interrupt In Lead (Pink/Black)**
Connect this lead to the Audio Interface output of a cellular phone which provides ground shorting when a call is received.
- ③ **Remote Turn-On Lead (Blue/White)**
Connect this lead to the remote turn-on lead of your amplifier or signal processor.
- ④ **Dimmer Lead (Orange)**
This lead may be connected to the vehicle's instrument cluster illumination lead. This will enable the vehicle's dimmer control to dim the backlighting of the CDA-7865R.
- ⑤ **Switched Power Lead (Ignition) (Red)**
Connect this lead to an open terminal on the vehicle's fuse box or another unused power source which provides (+) 12V only when the ignition is turned on or in the accessory position.
- ⑥ **Power Antenna Lead (Blue)**
Connect this lead to the +B terminal of your power antenna, if applicable.
- ⑦ **Fuse Holder (20A)**
- ⑧ **Battery Lead (Yellow)**
Connect this lead to the positive (+) post of the vehicle's battery.

For the battery lead and battery connection
Use an extension battery lead (20A)(sold separately) and connect it directly to the positive (+) side of the vehicle's battery.

- ⑨ **ISO Power Supply Connector**
- ⑩ **Ground Lead (Black)**
Connect this lead to a good chassis ground on the vehicle. Make sure the connection is made to bare metal and is securely fastened using the sheet metal screw provided.
- ⑪ **Ai-NET Connector**
Connect this to the output or input connector of other product (CD changer, Equalizer, etc.) equipped with Ai-NET.

- ⑫ **System Switch**
When connecting an equalizer or divider using Ai-NET feature, place this switch in the EQ/DIV position. When no device is connected, leave the switch in the NORM position.

NOTE

Be sure to turn the power off to the unit before changing the switch position.

- ⑬ **Power Supply Connector**
- ⑭ **ISO Connector (Speaker Output)**
- ⑮ **Left Rear (+) Speaker Output Lead (Green)**
- ⑯ **Left Rear (-) Speaker Output Lead (Green/Black)**
- ⑰ **Left Front (+) Speaker Output Lead (White)**
- ⑱ **Left Front (-) Speaker Output Lead (White/Black)**
- ⑲ **Right Front (-) Speaker Output Lead (Grey/Black)**
- ⑳ **Right Front (+) Speaker Output Lead (Grey)**
- ㉑ **Right Rear (-) Speaker Output Lead (Violet/Black)**
- ㉒ **Right Rear (+) Speaker Output Lead (Violet)**
- ㉓ **Remote Control Interface Connector**
To remote control interface box.
- ㉔ **Ai-NET Cable (Included with CD Changer)**
- ㉕ **Front Output RCA Connectors**
RED is right and WHITE is left.
- ㉖ **Rear/Subwoofer Output RCA Connectors**
RED is right and WHITE is left.
- ㉗ **DC/DC Converter**

NOTES

- Do not install the converter at a location subjected to water such as under the floor mat or air conditioner. This may cause a malfunction.
- Do not bundle the DC/DC converter cable with other audio cables. Doing so may induce noise into your system.
- Keep the DC/DC converter away from the Antenna cables and the rear side of the unit, otherwise noise may be generated when receiving radio broadcast.

- ⑳ **RCA Extension Cable (Sold Separately)**

To prevent external noise from entering the audio system.

- Locate the unit and route the leads at least 10cm away from the car harness.
- Keep the battery power leads as far away from other leads as possible.
- Connect the ground lead securely to a bare metal spot (remove the coating if necessary) of the car chassis.
- If you add an optional noise suppressor, connect it as far away from the unit as possible. Your Alpine dealer carries various Alpine noise suppressors, contact them for further information.
- Your Alpine dealer knows best about noise prevention measures so consult your dealer for further information.

Free Manuals Download Website

<http://myh66.com>

<http://usermanuals.us>

<http://www.somanuals.com>

<http://www.4manuals.cc>

<http://www.manual-lib.com>

<http://www.404manual.com>

<http://www.luxmanual.com>

<http://aubethermostatmanual.com>

Golf course search by state

<http://golfingnear.com>

Email search by domain

<http://emailbydomain.com>

Auto manuals search

<http://auto.somanuals.com>

TV manuals search

<http://tv.somanuals.com>