



EN

MP3/WMA CD Receiver

# CDA-9855

# CDA-9853

FR

ES



- **OWNER'S MANUAL**  
Please read before using this equipment.
- **MODE D'EMPLOI**  
Veuillez lire avant d'utiliser cet appareil.
- **MANUAL DE OPERACIÓN**  
Léalo antes de utilizar este equipo.

**ALPINE ELECTRONICS MARKETING, INC.**  
1-1-8 Nishi Gotanda,  
Shinagawa-ku,  
Tokyo 141-0031, Japan  
Phone 03-5496-8231

**ALPINE ELECTRONICS OF AMERICA, INC.**  
19145 Gramercy Place, Torrance,  
California 90501, U.S.A.  
Phone 1-800-ALPINE-1 (1-800-257-4631)

**ALPINE ELECTRONICS OF CANADA, INC.**  
777 Supertest Road, Toronto,  
Ontario M3J 2M9, Canada  
Phone 1-800-ALPINE-1 (1-800-257-4631)

**ALPINE ELECTRONICS OF AUSTRALIA PTY. LTD.**  
161-165 Princes Highway, Hallam  
Victoria 3803, Australia  
Phone 03-8787-1200

**ALPINE ELECTRONICS GmbH**  
Frankfurter Ring 117, 80807 München, Germany  
Phone 089-32 42 640

**ALPINE ELECTRONICS OF U.K. LTD.**  
Alpine House  
Fletchamstead Highway, Coventry CV4 9TW, U.K.  
Phone 0870-33 33 763

**ALPINE ELECTRONICS FRANCE S.A.R.L.**  
(RCS PONTOISE B 338 101 280)  
98, Rue de la Belle Etoile, Z.I. Paris Nord II,  
B.P. 50016, 95945 Roissy Charles de Gaulle  
Cedex, France  
Phone 01-48638989

**ALPINE ITALIA S.p.A.**  
Viale C. Colombo 8, 20090 Trezzano  
Sul Naviglio (MI), Italy  
Phone 02-484781

**ALPINE ELECTRONICS DE ESPAÑA, S.A.**  
Portal de Gamarra 36, Pabellón, 32  
01013 Vitoria (Alava)-APDO 133, Spain  
Phone 945-283588

# Contents

## Operating Instructions

|  |          |
|--|----------|
|  <b>WARNING</b> |          |
| <b>WARNING</b> .....   | <b>3</b> |
| <b>CAUTION</b> .....   | <b>3</b> |
| <b>PRECAUTIONS</b> .....   | <b>3</b> |

|  |          |
|--|----------|
| <b>About the GlideTouch™ Bar Operation</b> ..... | <b>6</b> |
|--|----------|

|   |   |
|---|---|
| <b>Getting Started</b>                              |   |
| Turning Power On and Off .....                      | 7 |
| Initial System Start-Up .....                       | 7 |
| Setting the Time and Calendar (CDA-9855 only) ..... | 7 |
| Setting Time (CDA-9853 only) .....                  | 7 |
| Opening and Closing the Movable Display .....       | 8 |
| Display Tilt Adjustment .....                       | 8 |
| Adjusting Volume .....                              | 8 |
| Lowering Volume Quickly .....                       | 8 |
| Detaching and Attaching the Front Panel .....       | 8 |

|   |    |
|---|----|
| <b>Radio</b>  |    |
| Changing the Radio Frequencies for each Country ..... | 9  |
| Listening to Radio .....                              | 9  |
| Manual Storing of Station Presets .....               | 9  |
| Automatic Memory of Station Presets .....             | 9  |
| Tuning to Preset Stations .....                       | 10 |
| Station Title Search Function .....                   | 10 |
| Frequency Search Function .....                       | 10 |

|  |    |
|--|----|
| <b>CD / MP3 / WMA</b>                              |    |
| Playback .....                                     | 10 |
| Repeat Play .....                                  | 11 |
| M.I.X. (Random Play) .....                         | 12 |
| Scanning Programs .....                            | 12 |
| Searching from CD Text .....                       | 12 |
| File/Folder Name Search (concerning MP3/WMA) ..... | 12 |

|                     |    |
|---------------------|----|
| Quick Search .....  | 13 |
| About MP3/WMA ..... | 13 |

|   |    |
|---|----|
| <b>Sound Setting</b>  |    |
| Adjusting Balance (Between Left and Right)/ Fader (Between Front and Rear)/Defeat ..... | 15 |
| Equalizer Presets .....   | 15 |
| Setting User's EQ mode .....  | 15 |
| Adjusting and Storing the Parametric Equalizer Curve .....                              | 16 |
| Adjusting and Storing the Graphic Equalizer Curve .....                                 | 16 |
| Recalling the Stored Equalizer Curve .....  | 17 |
| About the Crossover .....   | 17 |
| Adjusting and Storing the Crossover Settings .....                                      | 18 |
| Recalling the Stored Crossover Settings .....   | 19 |
| About Time Correction .....   | 19 |
| Setting the Time Correction Unit .....  | 20 |
| Adjusting and Storing the Time Correction .....   | 20 |
| Recalling the Stored Time Correction Settings .....                                     | 21 |
| Setting the MX Mode .....   | 21 |

|  |    |
|--|----|
| <b>Other Functions</b>   |    |
| Displaying the Title/Text .....                                      | 22 |
| Titling Discs/Stations .....   | 24 |
| Erasing Disc Title/Station Title .....                               | 24 |
| Displaying Time .....  | 24 |
| Blackout Mode On and Off (CDA-9855 only) .....                       | 24 |
| Setting Amplifier Link .....   | 25 |
| Displaying the External Amplifier Information .....                  | 25 |
| Setting the Multicolor Illumination (CDA-9855 only) .....            | 26 |
| Changing the Lighting Color of All the Buttons (CDA-9855 only) ..... | 26 |

|                                 |    |
|---------------------------------|----|
| <b>i-Personalize™ Operation</b> |    |
| About i-Personalize™ .....      | 26 |
| Data Downloading .....          | 27 |

## SETUP

### General Setting

|   |    |
|---|----|
| Setting the Clock display (CLOCK MODE)<br>(CDA-9855 only) ..... | 28 |
| Playing MP3/WMA Data (PLAY MODE) .....                          | 28 |
| Sound (Beep) Guide Function .....                               | 28 |
| Turning Mute Mode On/Off .....                                  | 28 |
| Setting Tone Defeat for External Devices .....                  | 28 |
| Setting the AUX Mode (V-Link) .....                             | 28 |
| Setting the External Digital Input .....                        | 28 |
| Connecting to an External Amplifier .....                       | 29 |
| Setting the Steering Position .....                             | 29 |

### Tuner Setting

|                                |    |
|--------------------------------|----|
| Switching the Tuner Mode ..... | 29 |
|--------------------------------|----|

### Audio Setting

|  |    |
|--|----|
| Subwoofer On and Off .....   | 29 |
| Setting the Subwoofer Output .....   | 29 |
| Setting the Subwoofer System .....   | 29 |
| Setting the Response Slope for the High Range<br>Speaker (TW SETUP) .....                                    | 29 |
| Connecting an Optical Digital Compatible<br>Audio Processor and an Ai-NET<br>Non-Compatible DVD Player ..... | 30 |

### Display Setting

|   |    |
|---|----|
| Dimmer Control .....  | 30 |
| Setting the Display Dimmer .....  | 30 |
| Scroll Type Setting .....   | 30 |
| Scroll Setting .....  | 30 |
| Adjusting Display Contrast<br>(CDA-9853 only) .....                       | 30 |
| Switching the Character Font<br>(CDA-9855 only) .....                     | 30 |
| Setting the Temperature Display for the<br>External Amplifier .....       | 30 |
| Setting the Display of the Audio Level Indicator<br>(CDA-9853 only) ..... | 30 |
| Switching the Animation Display Type<br>(CDA-9855 only) .....             | 30 |
| Opening Message ON/OFF Setting<br>(CDA-9855 only) .....                   | 30 |
| Setting of Calendar Display Pattern Switching<br>(CDA-9855 only) .....    | 30 |

### Demo Setting

|                     |    |
|---------------------|----|
| Demonstration ..... | 30 |
|---------------------|----|

## SAT Radio Receiver (Optional)

|  |    |
|--|----|
| Receiving Channels with the SAT Radio<br>Receiver (Optional) ..... | 31 |
| Checking the SAT Radio ID Number .....                             | 31 |
| Storing Channel Presets .....                                      | 31 |
| Receiving Stored Channels .....                                    | 32 |
| Channel/Category Search Function .....                             | 32 |
| Quick Search Function .....  | 32 |
| Changing the Display .....   | 32 |
| Setting the Auxiliary Data Field Display .....                     | 33 |

## iPod™ Operation (Optional)

|                                    |    |
|------------------------------------|----|
| Playback .....                     | 34 |
| Searching for a desired Song ..... | 34 |
| Quick Search .....                 | 35 |
| Random Play Shuffle (M.I.X.) ..... | 35 |
| Repeat Play .....                  | 36 |
| Displaying the Text .....          | 36 |

## Changer (Optional)

|   |    |
|---|----|
| Controlling CD Changer (Optional) .....                   | 37 |
| Playing MP3 Files with the CD Changer<br>(Optional) ..... | 37 |
| Multi-Changer Selection (Optional) .....                  | 37 |

## Remote Control

|                                     |    |
|-------------------------------------|----|
| Controls on Remote Control .....    | 38 |
| Operating the Audio Processor ..... | 38 |
| Battery Replacement .....           | 39 |

## Information

|                             |    |
|-----------------------------|----|
| In Case of Difficulty ..... | 39 |
| Specifications .....        | 42 |

---

## Installation and Connections

|                    |    |
|--------------------|----|
| Warning .....      | 43 |
| Caution .....      | 43 |
| Precautions .....  | 43 |
| Installation ..... | 44 |
| Connections .....  | 45 |

## LIMITED WARRANTY

# Operating Instructions

## WARNING

### WARNING

This symbol means important instructions. Failure to heed them can result in serious injury or death.

#### **DO NOT OPERATE ANY FUNCTION THAT TAKES YOUR ATTENTION AWAY FROM SAFELY DRIVING YOUR VEHICLE.**

Any function that requires your prolonged attention should only be performed after coming to a complete stop. Always stop the vehicle in a safe location before performing these functions. Failure to do so may result in an accident.

#### **KEEP THE VOLUME AT A LEVEL WHERE YOU CAN STILL HEAR OUTSIDE NOISE WHILE DRIVING.**

Failure to do so may result in an accident.

#### **MINIMIZE DISPLAY VIEWING WHILE DRIVING.**

Viewing the display may distract the driver from looking ahead of the vehicle and cause an accident.

#### **DO NOT DISASSEMBLE OR ALTER.**

Doing so may result in an accident, fire or electric shock.

#### **USE ONLY IN CARS WITH A 12 VOLT NEGATIVE GROUND.**

(Check with your dealer if you are not sure.) Failure to do so may result in fire, etc.

#### **KEEP SMALL OBJECTS SUCH AS BATTERIES OUT OF THE REACH OF CHILDREN.**

Swallowing them may result in serious injury. If swallowed, consult a physician immediately.

#### **USE THE CORRECT AMPERE RATING WHEN REPLACING FUSES.**

Failure to do so may result in fire or electric shock.

#### **DO NOT BLOCK VENTS OR RADIATOR PANELS.**

Doing so may cause heat to build up inside and may result in fire.

#### **USE THIS PRODUCT FOR MOBILE 12V APPLICATIONS.**

Use for other than its designed application may result in fire, electric shock or other injury.

#### **DO NOT PLACE HANDS, FINGERS OR FOREIGN OBJECTS IN INSERTION SLOTS OR GAPS.**

Doing so may result in personal injury or damage to the product.

### CAUTION

This symbol means important instructions. Failure to heed them can result in injury or material property damage.

#### **HALT USE IMMEDIATELY IF A PROBLEM APPEARS.**

Failure to do so may cause personal injury or damage to the product. Return it to your authorized Alpine dealer or the nearest Alpine Service Center for repairing.

#### **DO NOT MIX NEW BATTERIES WITH OLD BATTERIES. INSERT WITH THE CORRECT BATTERY POLARITY.**

When inserting the batteries, be sure to observe proper polarity (+ and -) as instructed. Rupture or chemical leakage from the battery may cause fire or personal injury.

#### **KEEP FINGERS AWAY WHILE THE MOTORIZED FRONT PANEL OR MOVING MONITOR IS IN MOTION.**

Failure to do so may result in personal injury or damage to the product.

## PRECAUTIONS

### **Product Cleaning**

Use a soft dry cloth for periodic cleaning of the product. For more severe stains, please dampen the cloth with water only. Anything else has the chance of dissolving the paint or damaging the plastic.

### **Temperature**

Be sure the temperature inside the vehicle is between +60°C (+140°F) and -10°C (+14°F) before turning your unit on.

### **Moisture Condensation**

You may notice the CD playback sound wavering due to condensation. If this happens, remove the disc from the player and wait about an hour for the moisture to evaporate.

### **Damaged Disc**

Do not attempt to play cracked, warped, or damaged discs. Playing a bad disc could severely damage the playback mechanism.

### **Maintenance**

If you have problems, do not attempt to repair the unit yourself. Return it to your Alpine dealer or the nearest Alpine Service Station for servicing.

# PRECAUTIONS

## Never Attempt the Following

Do not grip or pull out the disc while it is being pulled back into the player by the automatic reloading mechanism.

Do not attempt to insert a disc into the unit when the unit power is off.

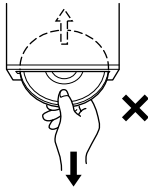

## Inserting Discs

Your player accepts only one disc at a time for playback. Do not attempt to load more than one disc.

Make sure the label side is facing up when you insert the disc. Your player will automatically eject any disc that is inserted incorrectly. If the player continues to eject a correctly inserted disc, push the RESET switch with a pointed object such as a ballpoint pen.

Playing a disc while driving on a very bumpy road may result in skips, but this will not scratch the disc or damage the player.

## New Discs

As a protective measure to prevent the CD from jamming, the CD player will automatically eject discs with irregular surfaces or inserted incorrectly. When a new disc is inserted into the player and ejected after initial loading, using your finger, feel around the inside of the center hole and outside edge of the disc. If you feel any small bumps or irregularities, this could inhibit proper loading of the disc. To remove the bumps, rub the inside edge of the hole and outside edge of the disc with a ballpoint pen or other such instrument, then insert the disc again.

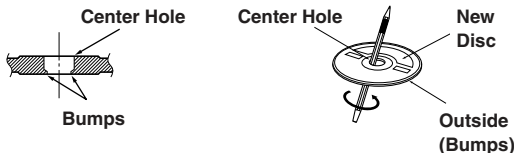

## Irregular Shaped Discs

Be sure to use round shape discs only for this unit and never use any special shape discs.

Use of special shape discs may cause damage to the mechanism.

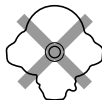

## Installation Location

Make sure the CDA-9855/CDA-9853 will not be installed in a location subjected to:

- Direct sun and heat
- High humidity and water
- Excessive dust
- Excessive vibrations

## Correct Handling

Do not drop the disc while handling. Hold the disc so you will not leave fingerprints on the surface. Do not affix tape, paper, or gummed labels to the disc. Do not write on the disc.

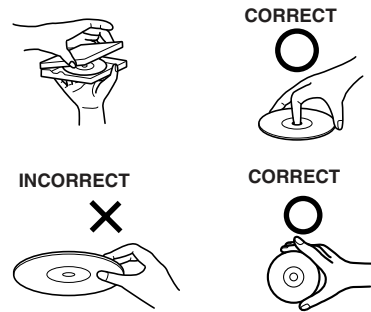

## Disc Cleaning

Fingerprints, dust, or soil on the surface of the disc could cause the CD player to skip. For routine cleaning, wipe the playing surface with a clean, soft cloth from the center of the disc to the outer edge. If the surface is heavily soiled, dampen a clean, soft cloth in a solution of mild neutral detergent before cleaning the disc.



## Disc Accessories

There are various accessories available on the market for protecting the disc surface and improving sound quality. However, most of them will influence the thickness and/or diameter of the disc. Using such accessories can cause the disc to be out of standard specifications and may create operational problems. We recommend not using these accessories on discs played in Alpine CD players.

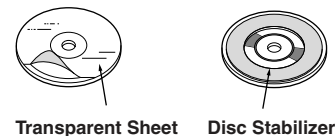

---

## On handling Compact Discs (CD/CD-R/CD-RW)

- Do not touch the surface.
- Do not expose the disc to direct sunlight.
- Do not affix stickers or labels.
- Clean the disc when it is dusty.
- Make sure that there are no bumps around the disc.
- Do not use commercially available disc accessories.

**Do not leave the disc in the car or the unit for a long time. Never expose the disc to direct sunlight.** Heat and humidity may damage the CD and you may not be able to play it again.

## To customers using CD-R/CD-RW

- If a CD-R/CD-RW cannot be played back, make sure the last recording session was closed (finalized).
- Finalize the CD-R/CD-RW if necessary, and attempt playback again.

---

## About media that can be played.

Use only compact discs with the label side showing the CD logo marks below.



If you use unspecified compact discs, correct performance cannot be guaranteed.

You can play CD-Rs (CD-Recordable)/CD-RWs (CD-ReWritable) which have been recorded only on audio devices.

You can also play CD-Rs/CD-RWs containing MP3/WMA formatted audio files.

- Some of the following CDs may not play on this unit:  
Flawed CDs, CDs with fingerprints, CDs exposed to extreme temperatures or sunlight (e.g., left in the car or this unit), CDs recorded under unstable conditions, CDs on which a recording failed or a re-recording was attempted, copy-protected CDs which do not conform to the audio CD industry standard.
- Use discs with MP3/WMA files written in a format compatible with this unit. For details, see page 13-14.

---

*Windows Media and the Windows logo are trademarks, or registered trademarks of Microsoft Corporation in the United States and /or other countries.*

*Apple, the Apple logo and iPod are trademarks of Apple Computer, Inc., registered in the U.S. and other countries.*

# About the GlideTouch™ Bar Operation

## 1 Touch or press the desired position on the GlideTouch bar.

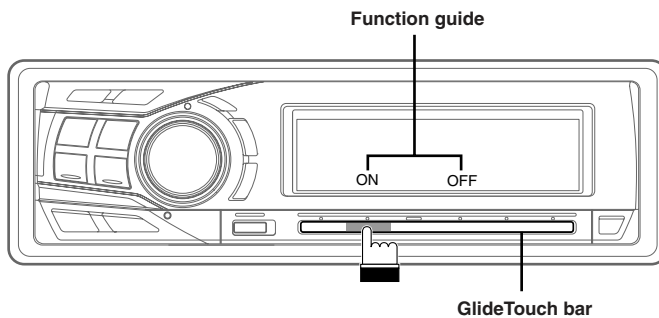

Press any one of the 6 positions on the **GlideTouch bar** to which a function has been assigned in the guide display. For example, to select ON, press the **GlideTouch bar** directly below where ON is indicated in the guide display. The manual expresses this as follows: "Change the setting by pressing the **GlideTouch bar** below either the ON or OFF function indicators."

## 2 Move your finger on the GlideTouch bar to the left or right.

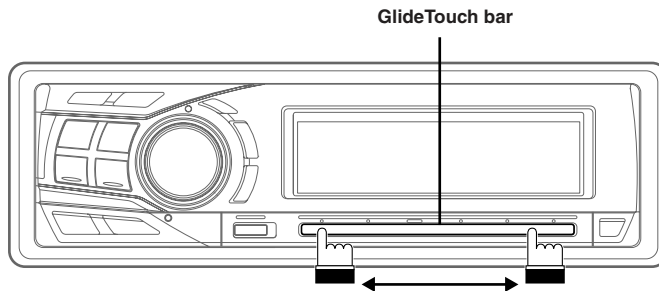

Place your finger on the **GlideTouch bar** and slide it gently to the left or right. Items or lists in the display will change as you move your finger across the **GlideTouch bar**.

To select items on the following page, scroll the page as follows:

- Place and hold your finger on either side of the **GlideTouch bar** for at least 3 seconds.  
When scrolling the page toward the left, place and hold your finger on the left side of the **GlideTouch bar**.  
When scrolling the page toward the right, place and hold your finger on the right side of the **GlideTouch bar**.
- Move your finger quickly on the **GlideTouch bar** toward the side that the page is scrolled.

# Getting Started

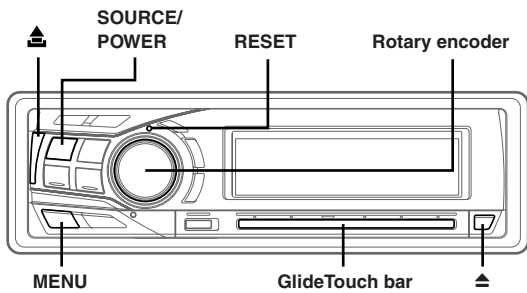

## Turning Power On and Off

Press **SOURCE/POWER** to turn on the unit.

- The unit can be turned on by pressing any other button except **TITLE** (CDA-9853 only) and **eject**.

Press and hold **SOURCE/POWER** for at least 2 seconds to turn off the unit.

- The first time power is turned on, the volume will start from level 12.

## Initial System Start-Up

Be sure to press the **RESET** switch when using the unit for the first time, after installing the CD changer, after changing the car battery, etc.

- 1 Turn off the unit power.
- 2 Press **RESET** with a ball-point pen or similar pointed object.

## Setting the Time and Calendar (CDA-9855 only)

- 1 Press **MENU**.
- 2 Select **SETUP** by sliding your finger on the **GlideTouch bar** to the left or right. Press the **GlideTouch bar** under **SETUP**.  
The main **SETUP** menu is displayed.
- 3 Select **GENERAL** by sliding your finger on the **GlideTouch bar** to the left or right. Press the **GlideTouch bar** under **GENERAL**.  
The **GENERAL SETUP** menu is displayed.
- 4 Select **CLOCK ADJUST** by sliding your finger on the **GlideTouch bar** to the left or right. Press the **GlideTouch bar** under **CLOCK ADJUST**.
- 5 Select "Year" by sliding your finger on the **GlideTouch bar** to the left or right.
- 6 Adjust "Year" by turning the **Rotary encoder**.

- 7 Adjust "Month", "Day", "Hour" and "Minute" by turning the **Rotary encoder** by repeating steps 5 and 6.

- 8 After setting, press and hold **MENU** for at least 2 seconds to return to normal mode.

- To synchronize the clock to another clock/watch or radio time announcement, press and hold the **Rotary encoder** for at least 2 seconds after setting the "hour." Minutes will reset to 00. If the display shows over "30" minutes when you do this, the time will advance one hour.
- If **MENU** is pressed while adjusting or setting the times in the **MENU** mode, the unit will return to the previous selection screen.
- By pressing the **GlideTouch bar** under **RETURN** in the **MENU** mode, the unit will return to the normal mode.
- If no operation is performed for 60 seconds, the unit will return to the normal mode.

## Setting Time (CDA-9853 only)

- 1 Press **MENU**.
  - 2 Select **SETUP** by sliding your finger on the **GlideTouch bar** to the left or right. Press the **GlideTouch bar** under **SETUP**.  
The main **SETUP** menu is displayed.
  - 3 Select **GENERAL** by sliding your finger on the **GlideTouch bar** to the left or right. Press the **GlideTouch bar** under **GENERAL**.  
The **GENERAL SETUP** menu is displayed.
  - 4 Select **CLOCK** by sliding your finger on the **GlideTouch bar** to the left or right. Press the **GlideTouch bar** under **CLOCK**.
  - 5 Select "Hour" by sliding your finger on the **GlideTouch bar** to the left or right.
  - 6 Adjust "Hour" by turning the **Rotary encoder**.
  - 7 Adjust "Minute" by turning the **Rotary encoder** by repeating steps 5 and 6.
  - 8 After setting, press and hold **MENU** for at least 2 seconds to return to normal mode.
- To synchronize the clock to another clock/watch or radio time announcement, press and hold the **Rotary encoder** for at least 2 seconds after setting the "hour." Minutes will reset to 00. If the display shows over "30" minutes when you do this, the time will advance one hour.
  - If **MENU** is pressed while adjusting or setting the times in the **MENU** mode, the unit will return to the previous selection screen.
  - By pressing the **GlideTouch bar** under **RETURN** in the **MENU** mode, the unit will return to the normal mode.
  - If no operation is performed for 60 seconds, the unit will return to the normal mode.



## Opening and Closing the Movable Display

Press **▲**.

The movable display will open.

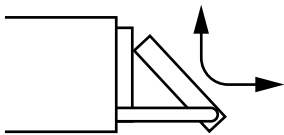

To close the movable display, press **▲** again.

The movable display will close.

- Do not apply shock to the movable display when it is open as it may result in malfunction of the unit.
- The display may be dim during low temperatures and immediately after turning on the power. The brightness will return to normal as time elapses.
- The display will stop at the set tilt angle when closing.

### Caution

Keep hands (or any other object) away from the display while it is opening or closing to avoid damage or injury. The back of the movable display will get very warm under normal operating conditions. This is not a malfunction. Do not touch.

## Display Tilt Adjustment

The movable display may be adjusted to 3 different angles depending upon user preference.

- 1 Press **MENU**.
- 2 Select **TILT (TILT ADJUST)** by sliding your finger on the **GlideTouch bar** to the left or right. Press the **GlideTouch bar** under **TILT (TILT ADJUST)**.
- 3 Touch **UP** or **DOWN** on the **GlideTouch bar** to adjust the display angle.

- Selecting **RETURN** will return to the previous screen.

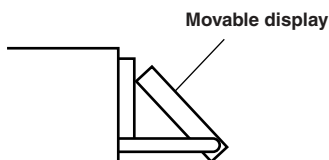

- 4 After setting, press and hold **MENU** for at least 2 seconds to return to normal mode.

- The adjusted tilt angle of the display is stored in memory. There is no need to re-adjust the tilt angle when the power is turned back on.
- If **MENU** is pressed while adjusting or setting the times in the **MENU** mode, the unit will return to the previous selection screen.
- By pressing the **GlideTouch bar** under **RETURN** in the **MENU** mode, the unit will return to the normal mode.

### Caution

Keep hands (or any other object) away from the display while it is opening or closing to avoid damage or injury. The back of the movable display will get very warm under normal operating conditions. This is not a malfunction. Do not touch.

## Adjusting Volume

Turn the **Rotary encoder** until the desired sound is obtained.

## Lowering Volume Quickly

Activating the Audio Mute function will instantly lower the volume level by 20 dB.

Press **MUTE** to activate the **MUTE** mode.

The audio level will decrease by about 20 dB.

Pressing **MUTE** again will bring the audio back to its previous level.

## Detaching and Attaching the Front Panel

### Detaching

- 1 Turn off the unit power.
- 2 Press **▲** (Release) at the upper left side until the front panel pops out.
- 3 Grasp the left side of the front panel and pull it out.

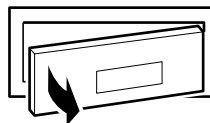

- The front panel may become hot in normal usage (especially the connector terminals on the back of the front panel.) This is not a malfunction.
- To protect the front panel, place it in the supplied carrying case.

### Attaching

- 1 Insert the right side of the front panel into the main unit. Align the groove on the front panel with the projections on the main unit.
- 2 Push the left side of the front panel until it locks firmly into the main unit.

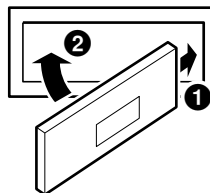

- Before attaching the front panel, make sure that there is no dirt or dust on the connector terminals and no foreign object between the front panel and the main unit.
- Attach the front panel carefully. Hold the panel by its sides to avoid pushing any buttons by mistake.

# Radio

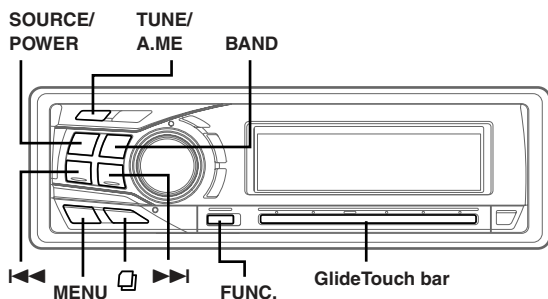

## Changing the Radio Frequencies for each Country

For customers not living in North America, change the radio frequencies as follows.

- 1 Press **MENU**.
- 2 Select **SETUP** by sliding your finger on the **GlideTouch bar** to the left or right. Press the **GlideTouch bar** under **SETUP**.  
The main SETUP menu is displayed.
- 3 Select **TUNER** by sliding your finger on the **GlideTouch bar** to the left or right. Press the **GlideTouch bar** under **TUNER**.  
The TUNER SETUP menu is displayed.
- 4 Select **TUNER AREA** by sliding your finger on the **GlideTouch bar** to the left or right. Press the **GlideTouch bar** under **TUNER AREA**.
- 5 Press the **GlideTouch bar** under **AREA1 (1)** or **AREA2 (2)** in the guide display.  
AREA 1: Radio frequencies for North America  
AREA 2: Other Radio frequencies
- 6 After setting, press and hold **MENU** for at least 2 seconds to return to normal mode.

- The stored radio stations will be cleared every time you change the setting.
- If **MENU** is pressed while adjusting or setting the times in the **MENU** mode, the unit will return to the previous selection screen.
- By pressing the **GlideTouch bar** under **RETURN** in the **MENU** mode, the unit will return to the normal mode.

## Listening to Radio

- 1 Press **SOURCE/POWER** until a radio frequency appears in the display.
- 2 Press **BAND** repeatedly until the desired radio band is displayed.  
FM1 → FM2 → AM → FM1

- 3 Press **TUNE/A.ME** to select the tuning mode.

CDA-9855:  
DX (Distance mode) → LOCAL (Local mode) → MANUAL (Manual mode) → DX

CDA-9853:  
DX SEEK (Distance mode) → SEEK (Local mode) → OFF (Manual mode) → DX SEEK

- The initial mode is Distance mode.

### Distance mode:

Both strong and weak stations will be automatically tuned in (Automatic Seek Tuning).

### Local mode:

Only strong stations will be automatically tuned in (Automatic Seek Tuning).

### Manual mode:

The frequency is manually tuned in steps (Manual tuning).

- 4 Press **◀◀** or **▶▶** to tune in the desired station.

Holding down **◀◀** or **▶▶** will change the frequency continuously.

- The **ST** indicator appears on the display when a stereo FM station is tuned in.
- With the CDA-9855, you can tune the radio station using the **GlideTouch bar**. Press **FUNC.** to select the source operation mode. Press the **GlideTouch bar** under the desired function shown in the function guide display.

## Manual Storing of Station Presets

- 1 Select the radio band and tune in a desired radio station you wish to store in the preset memory.
- 2 Press **FUNC.** to activate the preset mode.  
Source select mode → Preset mode → Source operation mode\* → Source select mode  
\* CDA-9855 only
- 3 Select any one of the preset numbers (1 through 6) by sliding your finger on the **GlideTouch bar** to the left or right. Press and hold the **GlideTouch bar** for at least 2 seconds under the selected preset number.  
The selected station is stored.

- A total of 18 stations can be stored in the preset memory (6 stations for each band; FM1, FM2 and AM).
- If you store a station in a preset memory which already has a station, the current station will be cleared and replaced with the new station.

## Automatic Memory of Station Presets



- 1 Press **BAND** repeatedly until the desired radio band is displayed.
  - 2 Press and hold **TUNE/A.ME** for at least 2 seconds.  
The frequency on the display continues to change while the automatic memory is in progress. The tuner will automatically seek and store 6 strong stations in the selected band. They will be stored into buttons 1 to 6 in order of signal strength.  
When the automatic memory has been completed, the tuner goes to the station stored in preset location no. 1.
- If no stations are stored, the tuner will return to the original station you were listening to before the auto memory procedure began.

## Tuning to Preset Stations

- 1 Press **BAND** repeatedly until the desired band is displayed.
- 2 Press **FUNC.** to activate the preset mode.  
Source select mode → Preset mode → Source operation mode\* → Source select mode  
*\* CDA-9855 only*
- 3 Select any one of the preset numbers (1 through 6) by sliding your finger to the left or right on the **GlideTouch bar**. Press the **GlideTouch bar** under the selected preset number.  
The display shows the band, preset number and frequency of the station selected.



## Station Title Search Function

If the title of a radio station is entered, you can search for that radio station by its title while listening to the currently received radio station.

- 1 Press  in Radio mode to switch to Title Search mode.  
This will set the search mode.
  - 2 Within 10 seconds, select the desired title by sliding your finger to the left or right on the **GlideTouch bar**. Press the **GlideTouch bar** under the selected title.  
The radio station of the selected title is received.
- Title Search mode is canceled by pressing and holding  for at least 2 seconds.
  - If either side of the **GlideTouch bar** is touched and held, the radio stations are scrolled continuously.
  - You can speed up your search by moving your finger quickly on the **GlideTouch bar** to skip radio stations.
  - If a station has no title, "NO TITLE" is displayed for 2 seconds.
  - Any radio station can be searched by the Station Title Search function. The station titles are displayed in the order they were input.

## Frequency Search Function







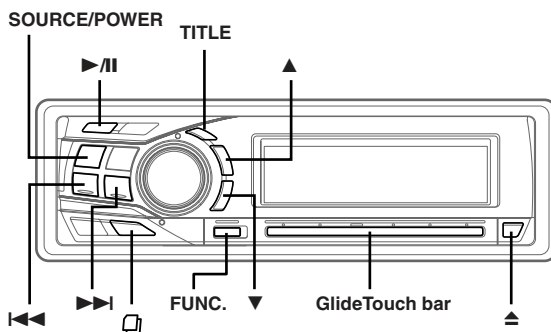



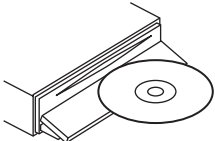



You can search for a radio station by its frequency.

- 1 Press and hold  for at least 2 seconds in Radio mode to activate Frequency Search mode.
  - 2 Within 10 seconds, select the desired frequency by sliding your finger to the left or right on the **GlideTouch bar**. Press the **GlideTouch bar** under the desired frequency.  
The radio station on the frequency selected is received.
- Frequency Search mode is cancelled by pressing and holding  for at least 2 seconds.
  - If either side of the **GlideTouch bar** is touched and held, the frequencies are scrolled continuously.
  - You can speed up your search by moving your finger quickly on the **GlideTouch bar** to skip frequencies.

## CD / MP3 / WMA



## Playback

- 1 Press .  
The movable display will open.
  - 2 Insert a disc with the label side facing up.  
The disc will be pulled into the unit automatically.
- 
- The movable display will close and playback will begin. When a disc is already inserted, press **SOURCE/POWER** to switch to the CD mode.
- The mode will change every time the button is pressed.  
CD → TUNER → CD CHANGER\* → CD
- \* Only when the CD changer is connected*
- 3 While playing back MP3/WMA, press  or  to select the desired folder.  
Pressing and holding  or  will change folders continuously.
  - 4 Press  or  to select the desired track (file).  
**Returning to the beginning of the current track (file):**  
Press .  
**Fast backward :**  
Press and hold .  
**Advancing to the beginning of the next track (file) :**  
Press .  
**Fast forward :**  
Press and hold .
  - 5 To pause playback, press .  
Pressing  again will resume playback.
  - 6 To eject the disc, press .
    - Do not remove a CD during its eject cycle. Do not load more than one disc at a time. A malfunction may result from doing either.
    - If the CD does not eject, press and hold  for at least 2 seconds with the movable display open.

- The CD-player can play discs containing audio data, MP3 data and WMA data.
- A WMA format file that is protected by DRM (Digital Rights Management) cannot be played back on this unit.
- “MP3” is displayed during MP3 playback. (CDA-9853 only)
- “WMA” is displayed during WMA playback. (CDA-9853 only)
- The track display for MP3/WMA data playback is the file numbers recorded on the disc.
- If the HDA-5460 model is connected to the unit, some operations (for example changing the source, selecting the file by holding buttons up or down, etc.), can be carried out on this unit.
- With the CDA-9855, you can return to the beginning of the current track, fast forward/fast reverse and playback/pause using the Glide Touch bar. Press **FUNC.** to select the source operation mode. Press the **GlideTouch bar** under the desired function shown in the function guide display.

### MP3/WMA Play Display

The folder number, file number, sampling rate, and bit rate will be displayed as described below.

#### CDA-9855

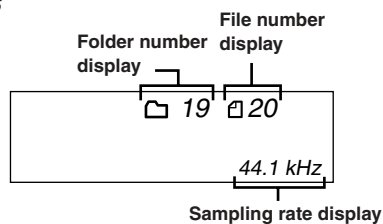

↕ The sampling rate and the bit rate (frame display) are alternately displayed.\*

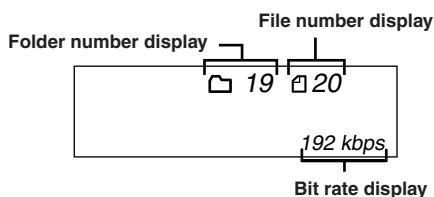

#### CDA-9853

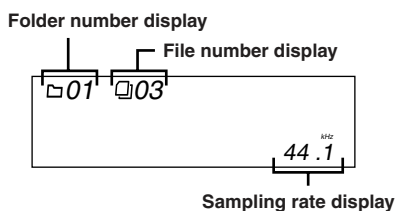

↕ The sampling rate and the bit rate (frame display) are alternately displayed.\*

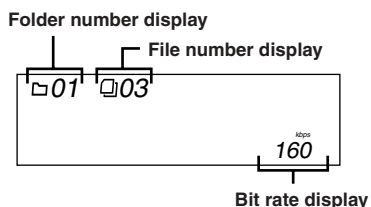

- Press **TITLE** to switch the display. Please see “Displaying the Title/Text” (page 22) for information about display switching.

\* The recording sampling rate and bit rate of the MP3/WMA file are displayed. A WMA file of variable bit rate displays the average bit rate.

## Repeat Play

### 1 Press **FUNC.** to activate the audio function mode.

Source select mode → Audio function mode → Source operation mode\* → Source select mode

\* CDA-9855 only

### 2 Press the **Glide Touch bar** under RPT to select the RPT mode.

The track (file) will be played back repeatedly.

CD mode :

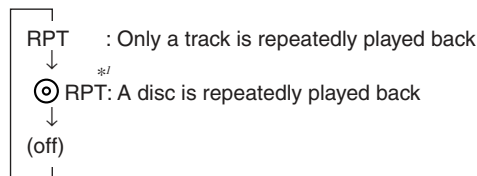

\*1 When a CD changer is connected.

- If REPEAT is set to ON during M.I.X. play in CD changer mode, M.I.X. will apply to the current disc only.

MP3/WMA mode :

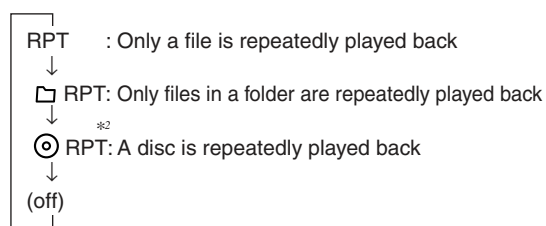

\*2 When an MP3 compatible CD changer is connected.

The RPT mode is canceled by selecting off.

- The function mode you previously recalled can be recalled again if the **GlideTouch bar** is touched.
- If no operation is performed for 10 seconds, the audio function mode turns off.

## M.I.X. (Random Play)

### 1 Press **FUNC.** to activate the audio function mode.

Source select mode → Audio function mode → Source operation mode\* → Source select mode

\* CDA-9855 only

### 2 Press the **GlideTouch** bar under **MIX** to select the **Random Play mode.**

The tracks (files) will be played back in random sequence.

CD mode :

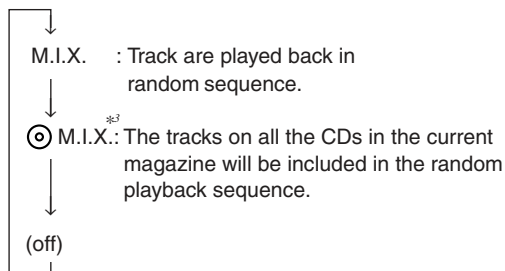

\*3 When a CD changer equipped with the All M.I.X. function is connected.

- If M.I.X. is set to ON during RPT (REPEAT ALL) play in CD changer mode, M.I.X. will apply to the current disc only.

MP3/WMA mode :

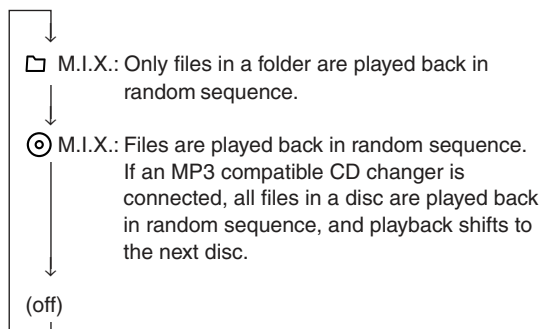

The Random Play mode is canceled by selecting off.

- The function mode you previously recalled can be recalled again if the **GlideTouch** bar is touched.
- If no operation is performed for 10 seconds, the audio function mode turns off.

## Scanning Programs

### 1 Press **FUNC.** to activate the audio function mode.

Source select mode → Audio function mode → Source operation mode\* → Source select mode

\* CDA-9855 only

### 2 Press the **GlideTouch** bar under **SCAN** to select the **Scan mode.**

The first 10 seconds of each of track (file) will be played back in succession.

### 3 If the desired song is found, perform steps 1 and 2 to stop scanning.

- The function mode you previously recalled can be recalled again if the **GlideTouch** bar is touched.
- If no operation is performed for 10 seconds, the audio function mode turns off.

## Searching from CD Text

Tracks can be searched and played using the CD text on the disc. In the case of discs and changers that do not support text, searches can be made using the track numbers.

### 1 Press during play.

This will set the search mode.

### 2 Select the desired track (file) by sliding your finger on the **GlideTouch** bar to the left or right. Press the **GlideTouch** bar under the Text of the desired Track.

This will play the selected track.

- Press and hold for at least 2 seconds in the search mode to cancel. Or, the search mode will be cancelled when an operation has not been performed in 10 seconds.
- CD text search cannot be made during M.I.X. play.
- Tracks are skipped continuously by touching and holding either side of the **GlideTouch** bar.
- You can speed up your search by moving your finger quickly on the **GlideTouch** bar to skip tracks.

## File/Folder Name Search (concerning MP3/WMA)

You can display and search for the folder and file name while listening to the file currently being played back.

### 1 Press in MP3/WMA mode.

### 2 Within 10 seconds, select the Folder search mode or File search mode by sliding your finger on the **GlideTouch** bar to the left or right. Press the **GlideTouch** bar under the desired search mode.

Folder Name Search mode ↔ File Name Search mode

#### Folder Name Search mode

The desired folder is searched from all folders in a disc.

#### File Name Search mode

File is searched from all files in a disc or folder that is selected by folder search.



## Folder Name Search mode

### 3 Within 10 seconds, select the folder to play back by sliding your finger on the **GlideTouch bar** to the left or right. Press **▶/||** to play the selected folder.

The first file in the selected folder is played back.

To search for a file in the selected folder, press the **GlideTouch bar** or **FUNC.** to change to the file search mode.



Refer to "File Name Search mode" for operation.

- Folder Name Search mode is cancelled by pressing and holding  for at least 2 seconds.
- While in Folder Name Search mode, press  to return to the selecting search mode.
- If a disc contains only the root folder, Folder Name Search cannot be made.
- "NO FILE" is displayed for 2 seconds if the folder that is selected by the Folder Name Search mode contains no files.
- "ROOT" is displayed for the root folder that does not have folder name.
- Folder Name search cannot be made during M.I.X. play.
- Folders are skipped continuously by touching and holding either side of the **GlideTouch bar**.
- You can speed up your search by moving your finger quickly on the **GlideTouch bar** to skip folders.

## File Name Search mode

### 3 Within 10 seconds, select the file to play back by sliding your finger on the **GlideTouch bar** to the left or right. Press the **GlideTouch Bar** or **FUNC.** to play the selected file.

The selected file is played back.

- File Name Search mode is cancelled by pressing and holding  for at least 2 seconds.
- While in the File Name Search mode, press  to switch to the previous mode (Folder Search mode or the selecting search mode).
- File Name search cannot be made during M.I.X. play.
- Files are skipped continuously by touching and holding either side of the **GlideTouch bar**.
- You can speed up your search by moving your finger quickly on the **GlideTouch bar** to skip files.

## Quick Search

You can search for tracks (files).

### 1 Press and hold for at least 2 seconds in the **CD/Changer/MP3/WMA mode** to activate Quick Search mode.

### 2 Within 10 seconds, select the track (file) to play back by sliding your finger on the **GlideTouch bar** to the left or right.

The selected track is played back immediately.

- Quick Search mode is cancelled by pressing and holding  for at least 2 seconds.
- Tracks (files) are skipped continuously by touching and holding either side of the **GlideTouch bar**.
- You can speed up your search by moving your finger quickly on the **GlideTouch bar** to skip tracks (files).

## About MP3/WMA

### CAUTION

Except for private use, duplicating audio data (including MP3/WMA data) or distributing, transferring, or copying it, whether for free or for a fee, without permission of the copyright holder is strictly prohibited by the Copyright Act and by international treaty.

### What is MP3?

MP3, whose official name is "MPEG-1 Audio Layer 3," is a compression standard prescribed by the ISO, the International Standardization Organization and MPEG which is a joint activity institution of the IEC.

MP3 files contain compressed audio data. MP3 encoding is capable of compressing audio data at extremely high ratios, reducing the size of music files to as much as one-tenth their original size. This is achieved while still maintaining near CD quality. The MP3 format realizes such high compression ratios by eliminating the sounds that are either inaudible to the human ear or masked by other sounds.

### What is WMA?

WMA, or "Windows Media™ Audio," is compressed audio data. WMA allows you to create music files and store them at higher ratios of compression than MP3 audio data (approx. half original size). This is achieved while still maintaining CD quality sound.

### Method for creating MP3/WMA files

Audio data is compressed by using MP3/WMA specified software. For details on creating MP3/WMA files, refer to the user's manual for that software.

MP3/WMA files that can be played back by this device have the file extension "mp3" / "wma". Files with no extension cannot be played back. (WMA ver. 7. 1, 8 and 9 are supported)

### Supported playback sampling rates and bit rates

#### MP3

Sampling rates : 48 kHz, 44.1 kHz, 32 kHz, 24 kHz, 22.05 kHz, 16 kHz, 12 kHz, 11.025 kHz, 8 kHz

Bit rates: 8 - 320 kbps

#### WMA

Sampling rates : 48 kHz, 44.1 kHz, 32 kHz

Bit rates: 48 - 192 kbps

Note that for sampling rates, this device's frame display (Page 11) may not display correctly.

This device may not play back correctly depending on sampling rates.

### ID3 tags/WMA tags

This device supports ID3 tag v1 and v2, and WMA tag. If tag data is in an MP3/WMA file, this device can display the title (track title), artist name, and album name ID3 tag/WMA tag data.

This device can only display single-byte alphanumeric characters (up to 30 for ID3 tags and up to 15 for WMA tags) and the underscore. For non-supported characters, "NO SUPPORT" is displayed. The tag information may not be correctly displayed, depending on the contents.

### Producing MP3/WMA discs

MP3/WMA files are prepared, then written to a CD-R or CD-RW using CD-R writing software. A disc can hold up to 510 files/folders (including Root Folders). However, the maximum number of folders is 255.

### Media supported

The media that this device can play back are CD-ROMs, CD-Rs, and CD-RWs.

Continued

### Corresponding File Systems

This device supports discs formatted with ISO9660 Level 1 or Level 2.

Under the ISO9660 standard, there are some restrictions to remember.

The maximum nested folder depth is 8 (including the root directory). The number of characters for a folder/file name is limited.

Valid characters for folder/file names are letters A-Z (all caps), numbers 0-9, and '\_' (underscore).

This device also can play back discs in Joliet, Romeo, etc., and other standards that conform to ISO9660. However, sometimes the file names, folder names, etc., are not displayed correctly.

### Formats supported

This device supports CD-ROM XA, Mixed Mode CD, Enhanced CD (CD-Extra) and Multi-Session.

This device cannot correctly play back discs recorded with Track At Once or packet writing.

### Order of files

The unit plays the files in the order that the writing software writes them. Therefore, the playing order may not be the same as the order you input. The playback order of the folders and files is as follows. However, the folder and file playback order differs from the folder no. and file no. indicated on the display.

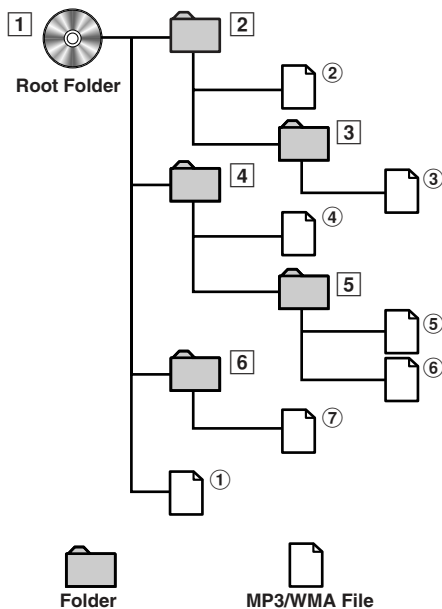

## Terminology

### Bit rate

This is the "sound" compression rate specified for encoding. The higher the bit rate, the higher the sound quality, but also the larger the files.

### Sampling rate

This value shows how many times per second the data is sampled (recorded). For example, music CDs use a sampling rate of 44.1 kHz, so the sound is sampled (recorded) 44,100 times per second. The higher the sampling rate, the higher the sound quality, but also the larger the volume of data.

### Encoding

Converting music CDs, WAVE (AIFF) files, and other sound files into the specified audio compression format.

### Tag

Song information such as track titles, artist names, album names, etc., written into MP3/WMA files.

MP3: ID3 tag

WMA: WMA tag

### Root folder

The root folder is found at the top of the file system. The root folder contains all folders and files.

# Sound Setting

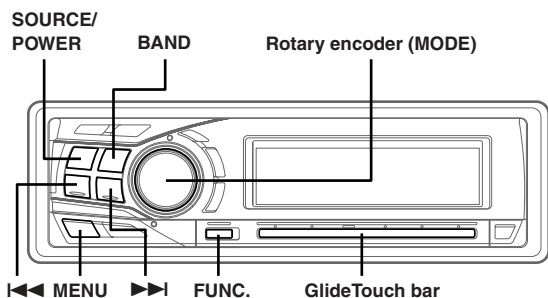

## Adjusting Balance (Between Left and Right)/Fader (Between Front and Rear)/Defeat

- 1 Press the **Rotary encoder (MODE)** repeatedly to choose the desired mode.

Each press changes the modes as follows:

SUBWOOFER\*<sup>†</sup> → BALANCE → FADER → DEFEAT → VOLUME → SUBWOOFER\*<sup>†</sup>

Subwoofer : 0 ~ +15  
Balance : L15 ~ R15  
Fader : R15 ~ F15  
Defeat : ON/OFF  
Volume : 0 ~ 35

Press **◀** or **▶** after selecting the Subwoofer mode, and the subwoofer output phase is switched NORMAL (PHASE 0°) or REVERS (PHASE 180°).

- If the **Rotary encoder (MODE)** is not pressed within 5 seconds after selecting the **BALANCE**, **FADER**, **DEFEAT** or **SUBWOOFER** mode, the unit automatically returns to normal mode.
- If you set the 2WAY/3WAY switch (pages 45 to 47) to 3WAY, you cannot adjust the **FADER** mode.

\*<sup>†</sup> When the subwoofer mode is set to OFF, its level and phase cannot be adjusted.

- 2 Turn the **Rotary encoder (MODE)** until the desired sound is obtained in each mode.

By setting Defeat ON, previously adjusted settings of EQ will return to the factory defaults and MX is turned off.

- Depending on the connected devices, some functions and display indications do not work.

## Equalizer Presets

9 typical equalizer settings are preset at the factory for a variety of musical source material.

- 1 Press **MENU**.
- 2 Select the **Factory's EQ mode** by sliding your finger on the **GlideTouch bar** to the left or right. Press the **GlideTouch bar** under the **Factory's EQ mode**.
- 3 Select the desired equalizer characteristic by sliding your finger on the **GlideTouch bar** to the left or right.

- By selecting **USER'S 1 to 6**, you can recall the stored preset number in "Adjusting and Storing the Graphic Equalizer Curve" (page 16) or "Adjusting and Storing the Parametric Equalizer Curve" (page 16).

- 4 Press and hold **MENU** for at least 2 seconds to return to normal mode.

- This function is inoperable when **DEFEAT** is set to ON (this page).
- If **MENU** is pressed while adjusting or setting the times in the **MENU** mode, the unit will return to the previous selection screen.
- By pressing the **GlideTouch bar** under **RETURN** in the **MENU** mode, the unit will return to the normal mode.

## Setting User's EQ mode

This setting gives you a choice of 5-band parametric, or 7-band graphic equalizer.

- 1 Press **MENU**.
- 2 Select **SETUP** by sliding your finger on the **GlideTouch bar** to the left or right. Press the **GlideTouch bar** under **SETUP**.  
The main **SETUP** menu is displayed.
- 3 Select **AUDIO** by sliding your finger on the **GlideTouch bar** to the left or right. Press the **GlideTouch bar** under **AUDIO**.  
The **AUDIO SETUP** menu is displayed.
- 4 Select **EQ MODE** by sliding your finger on the **GlideTouch bar** to the left or right. Press the **GlideTouch bar** under **EQ MODE**.

- 5 Select **EQ Type** by sliding your finger on the **GlideTouch bar** to the left or right. Press the **GlideTouch bar** under **PEQ** or **GEQ**.

PEQ : 5-band parametric EQ (initial setting)  
GEQ : 7-band graphic EQ

- 6 Press and hold **MENU** for at least 2 seconds to return to normal mode.

- If **MENU** is pressed while adjusting or setting the times in the **MENU** mode, the unit will return to the previous selection screen.
- By pressing the **GlideTouch bar** under **RETURN** in the **MENU** mode, the unit will return to the normal mode.



---

## Adjusting and Storing the Parametric Equalizer Curve

---

You can modify the Equalizer settings to create a response curve more appealing to your personal taste.

To adjust the parametric equalizer curve, set the EQ mode to PEQ. For details, refer to “Setting User’s EQ mode” (page 15).

- 1 Press and hold **MENU** for at least 2 seconds.
- 2 Select the Parametric EQ (User’s EQ) mode by sliding your finger on the **GlideTouch bar** to the left or right.  
Press the **GlideTouch bar** under the Parametric EQ (User’s EQ) mode.
- 3 Press **BAND** to select the band to be adjusted.  
BAND1 → BAND2 → BAND3 → BAND4 → BAND5 → BAND1
- 4 Select the frequency by sliding your finger on the **GlideTouch bar** to the left or right.  
Adjustable frequency bands:  
20Hz to 20kHz (in 1/3 octave steps)
- 5 Adjust the level by turning the **Rotary encoder**.  
Adjustable level: -6 to + 6 dB
- 6 Press **SOURCE/POWER** to set the band width (Q).  
Adjustable band width: 1.0, 1.5, 3.0
- 7 To adjust another band, repeat steps 3 to 6 and adjust all bands.
- 8 When the setting has been completed, press **FUNC.** or the **GlideTouch bar** to activate the preset mode.
- 9 Select any one of the preset numbers (1 through 6) by sliding your finger on the **GlideTouch bar** to the left or right. Press and hold the **GlideTouch bar** under the desire preset for at least 2 seconds to store the adjusted contents.
- 10 After setting, press and hold **MENU** for at least 2 seconds to return to normal mode.

- The frequencies of adjacent bands cannot be adjusted within 4 steps.
- This function is inoperable when DEFEAT is set to ON (page 15).
- If **MENU** is pressed while adjusting or setting the times in the **MENU** mode, the unit will return to the previous selection screen.
- By pressing the **GlideTouch bar** under **RETURN** in the **MENU** mode, the unit will return to the normal mode.
- If no operation is performed in 60 seconds, the unit will return to the normal mode.

---

## Adjusting and Storing the Graphic Equalizer Curve

---

You can modify the equalizer settings to create a response curve more appealing to your personal taste. To adjust the graphic equalizer curve, set the EQ mode to GEQ. For details, refer to “Setting User’s EQ mode” (page 15).

- 1 Press and hold **MENU** for at least 2 seconds.
- 2 Select the Graphic EQ (User’s EQ) mode by sliding your finger on the **GlideTouch bar** to the left or right.  
Press the **GlideTouch bar** under the Graphic EQ (User’s EQ) mode.
- 3 Press **BAND** to select the band to be adjusted.  
BAND1 → BAND2 → BAND3 → BAND4 → BAND5 →  
BAND6 → BAND7 → BAND1
- 4 Adjust the level by turning the **Rotary encoder**.  
Adjustable output level: -6 to + 6 dB
- 5 To adjust another band, repeat steps 3 and 4, then adjust all bands.
- 6 When the setting has been completed, press **FUNC.** or the **GlideTouch bar** to activate the preset mode.
- 7 Select any one of the preset numbers (1 through 6) by sliding your finger on the **GlideTouch bar** to the left or right. Press and hold the **GlideTouch bar** under the desire preset for at least 2 seconds to store the adjusted contents.
- 8 After setting, press and hold **MENU** for at least 2 seconds to return to normal mode.

- This function is inoperable when DEFEAT is set to ON (page 15).
- If **MENU** is pressed while adjusting or setting the times in the **MENU** mode, the unit will return to the previous selection screen.
- By pressing the **GlideTouch bar** under **RETURN** in the **MENU** mode, the unit will return to the normal mode.
- If no operation is performed in 60 seconds, the unit will return to the normal mode.

## Recalling the Stored Equalizer Curve

- 1 Press and hold **MENU** for at least 2 seconds.
- 2 Select the EQ mode by sliding your finger on the **GlideTouch** bar to the left or right. Press the **GlideTouch** bar under the EQ mode.
- 3 Press **FUNC.** or the **GlideTouch** bar to activate the preset mode.
- 4 Select any one of the preset numbers (1 through 6) by sliding your finger on the **GlideTouch** bar to the left or right. Press the **GlideTouch** bar under the desired preset to recall the stored contents.
- 5 Press and hold **MENU** for at least 2 seconds to return to normal mode.

- This function is inoperable when DEFEAT is set to ON (page 15).
- You can recall the adjusted equalizer curve from "Equalizer Presets" (page 15).
- If **MENU** is pressed while adjusting or setting the times in the **MENU** mode, the unit will return to the previous selection screen.
- By pressing the **GlideTouch** bar under **RETURN** in the **MENU** mode, the unit will return to the normal mode.
- If no operation is performed in 60 seconds, the unit will return to the normal mode.

## About the Crossover

### Crossover:

This unit is equipped with an active crossover. The crossover limits the frequencies delivered to the outputs. Each channel is controlled independently. Thus, each speaker pair can be driven by the frequencies for which they have been optimally designed.

The crossover adjusts the HPF (high pass filter) or LPF (low pass filter) of each band, and also the slope (how fast the filter rolls off the highs or lows). Adjustments should be made according to the reproduction characteristics of the speakers. Depending on the speakers, a passive network may not be necessary. If you are unsure about this point, please consult your authorized Alpine dealer.

### 2 way mode

|                                 | Cut-off frequency (1/3 octave steps) |                | Slope                      |                            | Level       |
|---------------------------------|--------------------------------------|----------------|----------------------------|----------------------------|-------------|
|                                 | HPF                                  | LPF            | HPF                        | LPF                        |             |
| <b>Low range speaker</b>        | ----                                 | 20 Hz - 200 Hz | ----                       | FLAT, 6, 12, 18, 24 dB/oct | 0 to -12 dB |
| <b>Rear high range speaker</b>  | 20 Hz - 200 Hz                       | ----           | FLAT, 6, 12, 18, 24 dB/oct | ----                       | 0 to -12 dB |
| <b>Front high range speaker</b> | 20 Hz - 200 Hz                       | ----           | FLAT, 6, 12, 18, 24 dB/oct | ----                       | 0 to -12 dB |

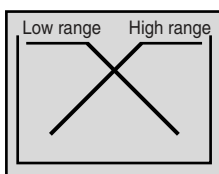

(Different from actual display)

### 3 way mode

|                           | Cut-off frequency (1/3 octave steps) |                | Slope                                      |                            | Level       |
|---------------------------|--------------------------------------|----------------|--|----------------------------|-------------|
|                           | HPF                                  | LPF            | HPF  | LPF                        |             |
| <b>Low range speaker</b>  | ----                                 | 20 Hz - 200 Hz | ----                                       | FLAT, 6, 12, 18, 24 dB/oct | 0 to -12 dB |
| <b>Mid range speaker</b>  | 20 Hz - 200 Hz                       | 20 Hz - 20 kHz | FLAT, 6, 12, 18, 24 dB/oct                 | FLAT, 6, 12, 18, 24 dB/oct | 0 to -12 dB |
| <b>High range speaker</b> | 1 kHz - 20 kHz                       | ----           | FLAT* <sup>1</sup><br>6, 12, 18, 24 dB/oct | ----                       | 0 to -12 dB |

\*<sup>1</sup> Only when selecting USER'S in "Setting the Response Slope for the High Range Speaker (TW SETUP)" (page 29).

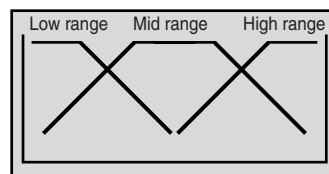

(Different from actual display)

### Level adjusting

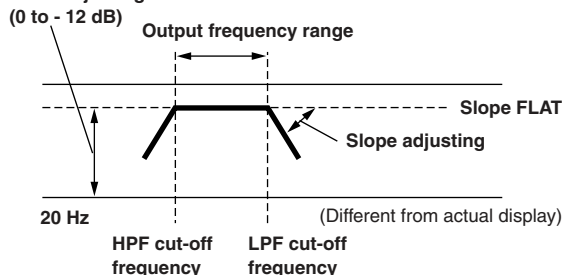

- **HPF (high pass filter):** Cuts the lower frequencies and allows the higher frequencies to pass.
- **LPF (low pass filter):** Cuts the higher frequencies and allows the lower frequencies to pass.
- **Slope:** The level change (in dB) for a frequency change of one octave.
- The higher the slope value, the steeper the slope becomes.
- Adjust the slope to **FLAT** to bypass the HP or LP filters.
- Do not use a tweeter without the HPF on or set to a low frequency, as it may cause damage to the speaker due to the low frequency content.
- You cannot adjust the crossover frequency higher than the HPF or lower than the LPF.
- Adjustment should be made according to the recommended crossover frequency of the connected speakers. Determine the recommended crossover frequency of the speakers. Adjusting to a frequency range outside that recommended may cause damage to the speakers.

For the recommended crossover frequencies of Alpine speakers, refer to the respective Owner's Manual.

We are not responsible for damage or malfunction of speakers caused by using the crossover outside the recommended value.

## Adjusting and Storing the Crossover Settings

Before performing the following procedures, refer to "About the Crossover" (Page 17).

- 1 Press and hold **MENU** for at least 2 seconds.
- 2 Select the Crossover (X-OVER) mode by sliding your finger on the **GlideTouch bar** to the left or right. Press the **GlideTouch bar** under the Crossover (X-OVER) mode.

### 2 WAY System

- 3 Press **BAND** to select the band to be adjusted.  
LOW → MID → HIGH → LOW  
(SUBW) (REAR) (FRONT) (SUBW)
- 4 Select the desired cut-off frequency (Crossover Point) by sliding your finger on the **GlideTouch bar** to the left or right.  
Adjustable frequency bands: 20Hz to 200Hz  
(in 1/3 octave steps)
- 5 Press **SOURCE/POWER** to adjust the slope.  
Adjustable slope: 0 (FLAT), 1 (6dB/oct.), 2 (12dB/oct.)  
3 (18dB/oct.) 4 (24dB/oct.)
- 6 Adjust the output level by turning the **Rotary encoder**.  
Adjustable output level: -12 to 0 dB.
- 7 To adjust another band, repeat steps 3 to 6, then adjust all bands.
- 8 When the setting has been completed, press **FUNC.** or the **GlideTouch bar** to activate the preset mode.
- 9 Select any one of the preset numbers (1 through 6) by sliding your finger on the **GlideTouch bar** to the left or right. Press and hold the **GlideTouch bar** under the desire preset for at least 2 seconds to store the adjusted contents.
- 10 After setting, press and hold **MENU** for at least 2 seconds to return to normal mode.

- If **MENU** is pressed while adjusting or setting the times in the **MENU** mode, the unit will return to the previous selection screen.
- By pressing the **GlideTouch bar** under **RETURN** in the **MENU** mode, the unit will return to the normal mode.
- If no operation is performed in 60 seconds, the unit will return to the normal mode.

### 3 WAY System

- 3 Press **BAND** to select the band to be adjusted.  
LOW → MID-L → MID-H → HIGH → LOW
- 4 Select the desired cut-off frequency (Crossover Point) by sliding your finger on the **GlideTouch bar** to the left or right.  
Adjustable frequency bands:  
LOW: 20Hz to 200Hz (in 1/3 octave steps)  
MID-L: 20Hz to 200Hz (in 1/3 octave steps)  
MID-H: 20Hz to 20kHz (in 1/3 octave steps)  
HIGH: 1kHz to 20 kHz (in 1/3 octave steps)
- 5 Press **SOURCE/POWER** to adjust the slope.  
Adjustable slope: 0 (FLAT)\*, 1 (6dB/oct.), 2 (12dB/oct.)  
3 (18dB/oct.), 4 (24dB/oct.)
- 6 Adjust the output level by turning the **Rotary encoder**.  
Adjustable output level: -12 to 0 dB.
- 7 To adjust another band, repeat steps 3 to 6, then adjust all bands.
- 8 When the setting has been completed, press **FUNC.** or the **GlideTouch bar** to activate the preset mode.
- 9 Select any one of the preset numbers (1 through 6) by sliding your finger on the **GlideTouch bar** to the left or right. Press and hold the **GlideTouch bar** under the desire preset for at least 2 seconds to store the adjusted contents.
- 10 After setting, press and hold **MENU** for at least 2 seconds to return to normal mode.

- If **MENU** is pressed while adjusting or setting the times in the **MENU** mode, the unit will return to the previous selection screen.
- By pressing the **GlideTouch bar** under **RETURN** in the **MENU** mode, the unit will return to the normal mode.
- If no operation is performed in 60 seconds, the unit will return to the normal mode.
- About the 2way/3way system  
You can switch to 2way/3way system mode with the 2way/3way switch on the bottom side of the unit (pages 45 to 47).



When setting to "3 WAY":

The unit can be operated in a 3 way system.

When setting to "F/R/Sub-W":

The unit can be operated in a 2 way system.

## Recalling the Stored Crossover Settings

- 1 Press and hold **MENU** for at least 2 seconds.
- 2 Select the **Crossover (X-OVER)** mode by sliding your finger on the **GlideTouch bar** to the left or right. Press the **GlideTouch bar** under the **Crossover (X-Over)** mode.
- 3 Press **FUNC.** or the **GlideTouch bar** to activate the preset mode.
- 4 Select any one of the preset numbers (1 through 6) by sliding your finger on the **GlideTouch bar** to the left or right. Press the **GlideTouch bar** under the desired preset to recall the stored contents.
- 5 Press and hold **MENU** for at least 2 seconds to return to normal mode.

- If **MENU** is pressed while adjusting or setting the times in the **MENU** mode, the unit will return to the previous selection screen.
- By pressing the **GlideTouch bar** under **RETURN** in the **MENU** mode, the unit will return to the normal mode.

## About Time Correction

The distance between the listener and the speakers in a car vary widely due to the complex speaker placement. This difference in the distances from the speakers to the listener creates a shift in the sounds image and frequency characteristics. This is caused by the time delay between the sound reaching the listener's right versus the left ear. To correct this, the CDA-9855/CDA-9853 is able to delay the audio signal to the speakers closest to the listener. This effectively creates a perception of increased distance for those speakers. The listener can be placed at an equal distance between the left and right speakers for optimum staging.

The adjustment will be made for each speaker in 0.1 ms steps.

### Example 1. Listening Position: Front Left Seat

Adjust the time correction level of the front left speaker to a high value and the rear right to zero or a low value.

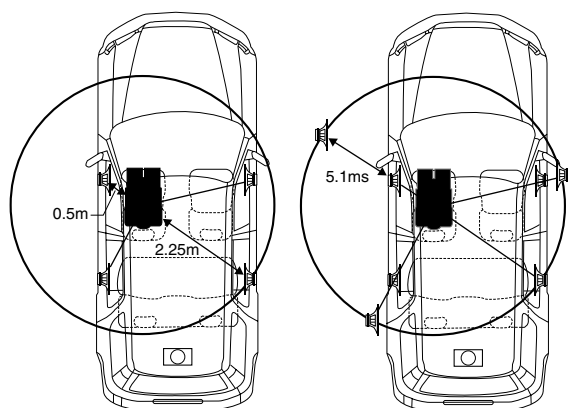

The sound is not balanced because the distance between the listening position and the various speakers is different. The difference in distance between the front left speaker and the rear right speaker is 1.75 m (68-7/8").

Here we calculate the time correction value for the front left speaker in the diagram on the above.

Conditions:

Farthest Speaker – listening position : 2.25 m (88-9/16")

Front left speaker – listening position : 0.5 m (19-11/16")

Calculation:  $L = 2.25 \text{ m} - 0.5 \text{ m} = 1.75 \text{ m}$  (68-7/8")

Time correction =  $1.75 \div 343^{*1} \times 1000 = 5.1$  (ms)

*\*1 Speed of sound: 343 m/s (765 mph) at 20°C*

In other words, giving the front left speaker a time correction value of 5.1 ms makes it seem as if its distance from the listener is the same as the distance to the farthest speaker.

Time correction eliminates the differences in the time required for the sound to reach the listening position.

The time of the front left speaker is corrected by 5.1 ms so that its sound reaches the listening position at the same time as the sound of other speakers.

### Example 2. Listening Position: All Seats

Adjust the time correction level of each speaker to almost the same level.

- 1 Sit in the listening position (driver's seat, etc.) and measure the distance (in meters) between your head and the various speakers.
- 2 Calculate the difference between the distance to the farthest speaker and the other speakers.  
 $L = (\text{distance to farthest speaker}) - (\text{distance to other speakers})$
- 3 Divide the distances calculated for the speakers by the speed of sound (343 m/s (765 mph) at 20°C).  
These values are the time correction values for the different speakers.

**Continued**

Time Difference Table

| Delay Number | Time Difference (ms) | Distance (cm) | Distance (inch) | Delay Number | Time Difference (ms) | Distance (cm) | Distance (inch) |
|--------------|----------------------|---------------|-----------------|--------------|----------------------|---------------|-----------------|
| 0            | 0.0                  | 0.0           | 0.0             | 51           | 5.1                  | 173.4         | 68.3            |
| 1            | 0.1                  | 3.4           | 1.3             | 52           | 5.2                  | 176.8         | 69.7            |
| 2            | 0.2                  | 6.8           | 2.7             | 53           | 5.3                  | 180.2         | 71.0            |
| 3            | 0.3                  | 10.2          | 4.0             | 54           | 5.4                  | 183.6         | 72.4            |
| 4            | 0.4                  | 13.6          | 5.4             | 55           | 5.5                  | 187.0         | 73.7            |
| 5            | 0.5                  | 17.0          | 6.7             | 56           | 5.6                  | 190.4         | 75.0            |
| 6            | 0.6                  | 20.4          | 8.0             | 57           | 5.7                  | 193.8         | 76.4            |
| 7            | 0.7                  | 23.8          | 9.4             | 58           | 5.8                  | 197.2         | 77.7            |
| 8            | 0.8                  | 27.2          | 10.7            | 59           | 5.9                  | 200.6         | 79.1            |
| 9            | 0.9                  | 30.6          | 12.1            | 60           | 6.0                  | 204.0         | 80.4            |
| 10           | 1.0                  | 34.0          | 13.4            | 61           | 6.1                  | 207.4         | 81.7            |
| 11           | 1.1                  | 37.4          | 14.7            | 62           | 6.2                  | 210.8         | 83.1            |
| 12           | 1.2                  | 40.8          | 16.1            | 63           | 6.3                  | 214.2         | 84.4            |
| 13           | 1.3                  | 44.2          | 17.4            | 64           | 6.4                  | 217.6         | 85.8            |
| 14           | 1.4                  | 47.6          | 18.8            | 65           | 6.5                  | 221.0         | 87.1            |
| 15           | 1.5                  | 51.0          | 20.1            | 66           | 6.6                  | 224.4         | 88.4            |
| 16           | 1.6                  | 54.4          | 21.4            | 67           | 6.7                  | 227.8         | 89.8            |
| 17           | 1.7                  | 57.8          | 22.8            | 68           | 6.8                  | 231.2         | 91.1            |
| 18           | 1.8                  | 61.2          | 24.1            | 69           | 6.9                  | 234.6         | 92.5            |
| 19           | 1.9                  | 64.6          | 25.5            | 70           | 7.0                  | 238.0         | 93.8            |
| 20           | 2.0                  | 68.0          | 26.8            | 71           | 7.1                  | 241.4         | 95.1            |
| 21           | 2.1                  | 71.4          | 28.1            | 72           | 7.2                  | 244.8         | 96.5            |
| 22           | 2.2                  | 74.8          | 29.5            | 73           | 7.3                  | 248.2         | 97.8            |
| 23           | 2.3                  | 78.2          | 30.8            | 74           | 7.4                  | 251.6         | 99.2            |
| 24           | 2.4                  | 81.6          | 32.2            | 75           | 7.5                  | 255.0         | 100.5           |
| 25           | 2.5                  | 85.0          | 33.5            | 76           | 7.6                  | 258.4         | 101.8           |
| 26           | 2.6                  | 88.4          | 34.8            | 77           | 7.7                  | 261.8         | 103.2           |
| 27           | 2.7                  | 91.8          | 36.2            | 78           | 7.8                  | 265.2         | 104.5           |
| 28           | 2.8                  | 95.2          | 37.5            | 79           | 7.9                  | 268.6         | 105.9           |
| 29           | 2.9                  | 98.6          | 38.9            | 80           | 8.0                  | 272.0         | 107.2           |
| 30           | 3.0                  | 102.0         | 40.2            | 81           | 8.1                  | 275.4         | 108.5           |
| 31           | 3.1                  | 105.4         | 41.5            | 82           | 8.2                  | 278.8         | 109.9           |
| 32           | 3.2                  | 108.8         | 42.9            | 83           | 8.3                  | 282.2         | 111.2           |
| 33           | 3.3                  | 112.2         | 44.2            | 84           | 8.4                  | 285.6         | 112.6           |
| 34           | 3.4                  | 115.6         | 45.6            | 85           | 8.5                  | 289.0         | 113.9           |
| 35           | 3.5                  | 119.0         | 46.9            | 86           | 8.6                  | 292.4         | 115.2           |
| 36           | 3.6                  | 122.4         | 48.2            | 87           | 8.7                  | 295.8         | 116.6           |
| 37           | 3.7                  | 125.8         | 49.6            | 88           | 8.8                  | 299.2         | 117.9           |
| 38           | 3.8                  | 129.2         | 50.9            | 89           | 8.9                  | 302.6         | 119.3           |
| 39           | 3.9                  | 132.6         | 52.3            | 90           | 9.0                  | 306.0         | 120.6           |
| 40           | 4.0                  | 136.0         | 53.6            | 91           | 9.1                  | 309.4         | 121.9           |
| 41           | 4.1                  | 139.4         | 54.9            | 92           | 9.2                  | 312.8         | 123.3           |
| 42           | 4.2                  | 142.8         | 56.3            | 93           | 9.3                  | 316.2         | 124.6           |
| 43           | 4.3                  | 146.2         | 57.6            | 94           | 9.4                  | 319.6         | 126.0           |
| 44           | 4.4                  | 149.6         | 59.0            | 95           | 9.5                  | 323.0         | 127.3           |
| 45           | 4.5                  | 153.0         | 60.3            | 96           | 9.6                  | 326.4         | 128.6           |
| 46           | 4.6                  | 156.4         | 61.6            | 97           | 9.7                  | 329.8         | 130.0           |
| 47           | 4.7                  | 159.8         | 63.0            | 98           | 9.8                  | 333.2         | 131.3           |
| 48           | 4.8                  | 163.2         | 64.3            | 99           | 9.9                  | 336.6         | 132.7           |
| 49           | 4.9                  | 166.6         | 65.7            |              |                      |               |                 |
| 50           | 5.0                  | 170.0         | 67.0            |              |                      |               |                 |

## Setting the Time Correction Unit

You can change the unit, (ms, cm or inch) of time correction.

- 1 Press **MENU**.
- 2 Select **SETUP** by sliding your finger on the **GlideTouch bar** to the left or right. Press the **GlideTouch bar** under **SETUP**.  
The main **SETUP** menu is displayed.
- 3 Select **DISP (DISPLAY)** by sliding your finger on the **GlideTouch bar** to the left or right. Press the **GlideTouch bar** under **DISP (DISPLAY)**.  
The **DISPLAY SETUP** menu is displayed.
- 4 Select **T.CORR (T.CORR PAR)** by sliding your finger on the **GlideTouch bar** to the left or right. Press the **GlideTouch bar** under **T.CORR (T.CORR PAR)**.
- 5 Select **ms (MS)**, **cm (CM)** or **inch (INCH)** by sliding your finger on the **GlideTouch bar** to the left or right. Press under **ms (MS)**, **cm (CM)** or **inch (INCH)** on the **GlideTouch bar**.
- 6 After setting, press and hold **MENU** for at least 2 seconds to return to normal mode.
  - If **MENU** is pressed while adjusting or setting the times in the **MENU** mode, the unit will return to the previous selection screen.
  - By pressing the **GlideTouch bar** under **RETURN** in the **MENU** mode, the unit will return to the normal mode.

## Adjusting and Storing the Time Correction

Before performing the following procedures, refer to "About Time Correction" (page 19).

- 1 Press and hold **MENU** for at least 2 seconds.
- 2 Select **Time Correction (T.CORR)** mode by sliding your finger on the **GlideTouch bar** to the left or right. Press the **GlideTouch bar** under **Time Correction (T.CORR)**.
- 3 Press **BAND** to select a speaker to be adjusted.  
F-L → F-R → R-L → R-R → SW-L (S-L) → SW-R (S-R) → F-L
- 4 Adjust the time difference (0.0 to 9.9 ms) or distance by sliding your finger on the **GlideTouch bar** to the left or right. Or turn the **Rotary encoder** to adjust the time difference.
- 5 Repeat steps 3 and 4 to set another speaker.
- 6 When the setting has been completed, press **FUNC.** or the **GlideTouch bar** to activate the preset mode.

7 Select any one of the preset numbers (1 through 6) by sliding your finger on the **GlideTouch bar** to the left or right. Press and hold the **GlideTouch bar** under the desired preset for at least 3 seconds to store the adjusted contents.

8 After setting, press and hold **MENU** for at least 2 seconds to return to normal mode.

- If **MENU** is pressed while adjusting or setting the times in the **MENU** mode, the unit will return to the previous selection screen.
- By pressing the **GlideTouch bar** under **RETURN** in the **MENU** mode, the unit will return to the normal mode.
- If no operation is performed in 60 seconds, the unit will return to the normal mode.

## Recalling the Stored Time Correction Settings

1 Press and hold **MENU** for at least 2 seconds.

2 Select the **Time Correction (T.CORR)** mode by sliding your finger on the **GlideTouch bar** to the left or right. Press the **GlideTouch bar** under the **Time Correction (T.CORR)** mode.

3 Press **FUNC.** or the **GlideTouch bar** to activate the preset mode.

4 Select any one of the preset numbers (1 through 6) by sliding your finger on the **GlideTouch bar** to the left or right. Press the **GlideTouch bar** under the desired preset to recall the stored contents.

5 Press and hold **MENU** for at least 2 seconds to return to normal mode.

- If **MENU** is pressed while adjusting or setting the times in the **MENU** mode, the unit will return to the previous selection screen.
- By pressing the **GlideTouch bar** under **RETURN** in the **MENU** mode, the unit will return to the normal mode.

## Setting the MX Mode

MX (Media Xpander) makes vocals or instruments sound distinct regardless of the music source. The FM radio, CD, and MP3, will be able to reproduce the music clearly even in cars with a lot of road noise.

1 Press **MENU**.

2 Select the **MX mode** by sliding your finger on the **GlideTouch bar** to the left or right. Press the **GlideTouch bar** under the **MX mode**.

3 Press the **GlideTouch bar** under **ON** to activate **MX**.

4 After setting, press and hold **MENU** for at least 2 seconds to return to normal mode.

5 Press **SOURCE/POWER** to select the source to which you want to apply **MX (Media Xpander)**.

6 Press and hold **MENU** for at least 2 seconds.

7 Select the **MX mode** by sliding your finger on the **GlideTouch bar** to the left or right. Press the **GlideTouch bar** under the **MX mode**.

8 Select the **MX Level** by sliding your finger on the **GlideTouch bar** to the left or right. Press the **GlideTouch bar** under the desired level or **OFF (Non Effect)**.

### FM (MX level 1 to 3):

The medium to high frequencies become clearer, and produces well balanced sound at all frequencies.

### CD (MX level 1 to 3):

CD mode processes a large amount of data during playback. MX takes advantage of this large data quantity to reproduce a more clear, clean output.

### CMPM/SAT (MX level 1 to 3):

This corrects information that was lost at the time of compression. This reproduces a well-balanced sound close to the original.

### DVD (Video CD)

#### (MOVIE MX level 1 to 2):

The dialogue portion of a video is reproduced more clearly.

#### (DVD MUSIC):

A DVD or Video CD contains a large quantity of data such as music clip. MX uses this data to reproduce the sound accurately.

### AUX (MX level 1):

Choose the **MX mode** (CMPM, MUSIC, or MOVIE) that corresponds to the media connected.

If two external devices are connected, a different **MX mode** for each media can be selected.

9 After setting, press and hold **MENU** for at least 2 seconds to return to normal mode.

- To cancel **MX mode** for all music sources, set **MX** to **OFF** in step 3.
- Each music source, such as **FM radio**, **CD**, and **MP3/WMA** can have its own **MX setting**.
- On disks with both **MP3/WMA** and **CD-DA**, when the source changes from "**MP3/WMA** to **CD-DA**" or "**CD-DA** to **MP3/WMA**", **MX-mode** switching may delay playback slightly.
- Setting to **MX OFF** sets **MX mode** of each music source to **OFF**.
- This function is inoperable when **DEFEAT** is set to **ON**.
- There is no **MX mode** for **AM radio**.
- If an audio processor with the **MX function** (**PXA-H701**, etc.) is connected, its own **MX processing** is applied to the music source. Since the processor **MX settings** may not match the head unit, the audio processor needs to be adjusted. For details, refer to the Owner's Manual of the audio processor.
- "**CMPM**" is applied for **MP3/WMA**, **WAV** and **iPod**.
- "**SAT**" is applied for **XM radio** and **SIRIUS radio**.
- If **MENU** is pressed while adjusting or setting the times in the **MENU** mode, the unit will return to the previous selection screen.
- By pressing the **GlideTouch bar** under **RETURN** in the **MENU** mode, the unit will return to the normal mode.
- If no operation is performed in 60 seconds, the unit will return to the normal mode.

### About the MX indicator display (CDA-9853 only)

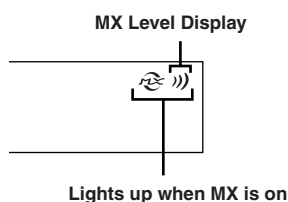

# Other Functions

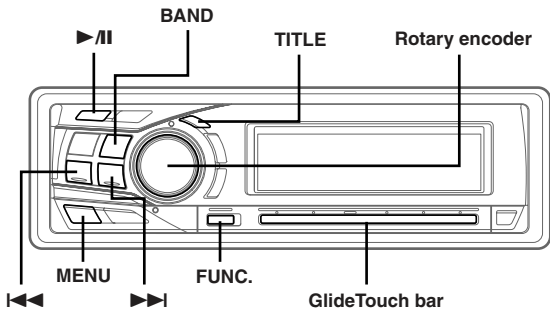

## Displaying the Title/Text

It is possible to display the CD/Station title if the title has been previously inputted ("Titling Discs/Stations" page 24). Text information, such as the disc name and the track name, will be displayed if playing a CD text compatible disc. It is also possible to display the folder name, the file name, and the tag, etc., while playing MP3/WMA files.

### Press **TITLE**.

The display will change every time the button is pressed.

#### The display in Radio mode:

##### CDA-9855

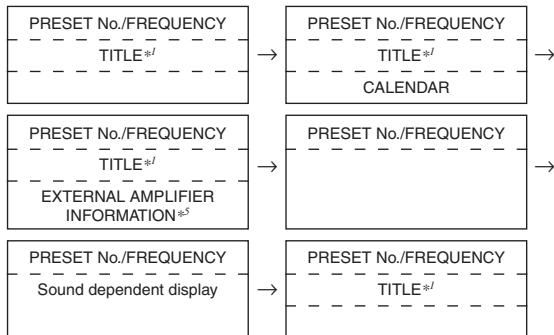

##### CDA-9853

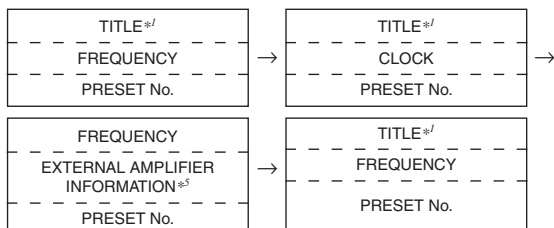

#### The display in CD mode:

##### CDA-9855

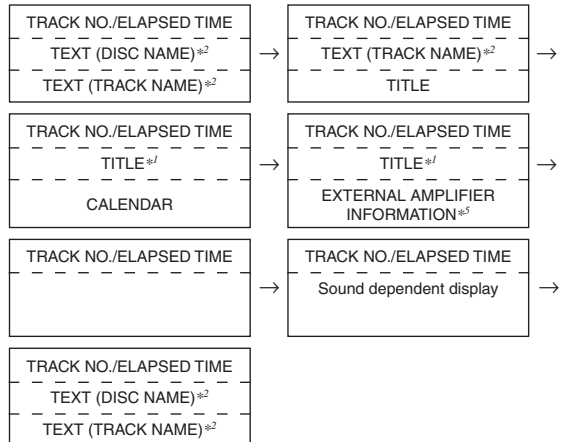

##### CDA-9853

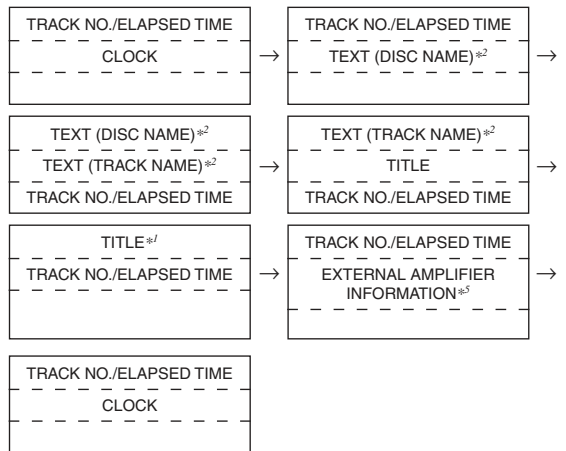

#### The display in MP3/WMA mode:

##### CDA-9855

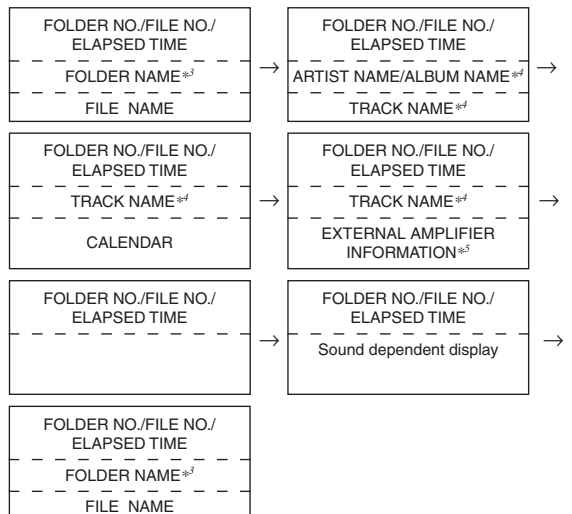

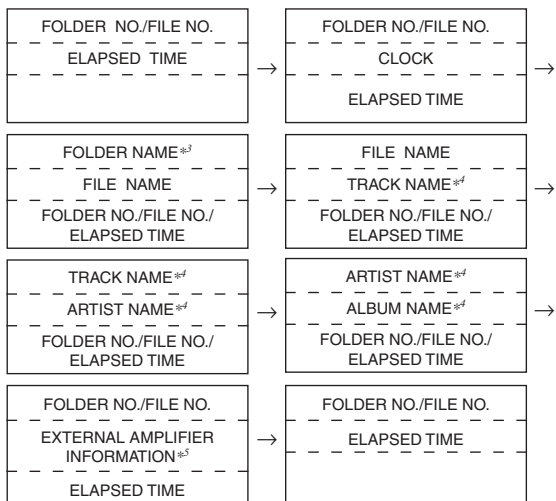

\*<sup>1</sup> TITLE can be input or erased.

\*<sup>2</sup> Displayed during playback of a disc with CD Text.

"NO TEXT" will be displayed when the CD contains no Text data.

\*<sup>3</sup> "ROOT" is displayed for a root folder that does not have a folder name.

\*<sup>4</sup> ID3 tag/WMA tag

If an MP3/WMA file contains ID3 tag/WMA tag information, the ID3 tag/WMA tag information is displayed (e.g., track name, artist name, and album name). All other tag data is ignored.

"NO DATA" will be displayed when an MP3/WMA file contains no ID3 tag/WMA tag information.

\*<sup>5</sup> Only when an external Amplifier Link compatible amplifier is connected. For details, refer to "Displaying the External Amplifier Information" (page 25).

#### About the indicator display (CDA-9853 only)

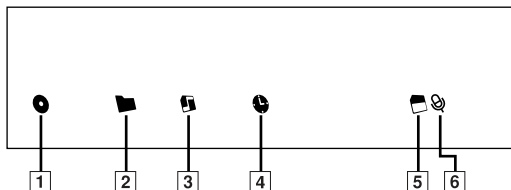

1 This indicator is lit when an album name is displayed.

2 This indicator is lit when a folder name is displayed.

3 This indicator is lit when a file name is displayed.

4 This indicator is lit when the elapsed playback time is displayed below.

5 This indicator is lit when the bit rate and sampling rate are displayed.

6 This indicator is lit when an artist name is displayed.

#### About "Title" and "Text"

##### Title:

With this device, it is possible to input the CD/Station name (page 24). This inputted name is referred to as a "title." You cannot input or display titles on MP3/WMA discs.

##### Text:

Text compatible CDs contain text information such as the disc name and track name. Such text information is referred to as "text."

- Some characters may not be displayed correctly with this device, depending on the character type.
- The CD changer must also be CD Text compatible for the Text information to be displayed.
- When the Scroll Setting (page 30) is set to "MANUAL," press and hold **TITLE** for at least 2 seconds to scroll the Text information only once (TEXT DISPLAY, FOLDER NAME DISPLAY, FILE NAME DISPLAY or TAG DISPLAY mode).
- "NO SUPPORT" is displayed when the desired text information cannot be displayed on this unit.
- If the title was not previously input, "NO TITLE" is displayed.
- The text or tag information may not be correctly displayed, depending on the contents.
- Elapsed time is displayed for 5 seconds in the CD/MP3/WMA mode immediately after changing sources or songs, etc. (CDA-9853 only)



---

## Titling Discs/Stations

---

It is possible to title your favorite CD's or radio stations.  
You cannot input titles on MP3/WMA discs.

- 1 Press TITLE and select the Title Display.**  
For details, see asterisk 1 of "Displaying the Title/Text" (page 22).
- 2 Press and hold TITLE for at least 2 seconds. The first character will blink.**
- 3 Press BAND to select the characters/symbols.**  
Upper case → Lower case → Numeral/Symbol\* → Upper case  
\* Press **◀◀** or **▶▶** to change pages. (CDA-9855 only.)
- 4 Turn the Rotary encoder to select the desired letter/numeral/symbol available for naming.**
- 5 Press Rotary encoder to store the first character.**  
The first character will stop blinking and the display will automatically advance to the next character. When that character begins to blink, you may choose the next letter or symbol of your title.

### Correcting the title (CDA-9855 only)

In the title input mode, press SOURCE/POWER to move the cursor to the input title line. Turn the Rotary encoder to move the cursor to the portion to be corrected. Press SOURCE/POWER again to return to the title input mode, and perform the correction.

- 6 Repeat steps 3 and 5 above to complete the titling.**  
Pressing the Rotary encoder after entering the 8th character (for CDA-9855 16th character) automatically stores the title into memory.

When entering a title of less than 8 or 16 characters (for example, 3 character title):

After entering 3 characters, the 4th character space will be blinking. Go to step 7 to complete the title.

- 7 Press TITLE to record the title.**
  - If you cancel while entering a title, selected characters are not written.
  - You can enter 18 radio station titles (24 for the CDA-9853 model) and 18 CD titles on this unit. If you try to store beyond the limit, the display will show "FULL DATA." At this point, no more titles can be stored. To input a new title, one of the previously inputted titles must first be deleted.
  - The CD Changer title length or memory capacity varies depending upon the model being used.
  - When you want to erase a title, enter a space (and symbol "⏏" for the CDA-9853 model).
  - The operations described in steps 3 to 6 must be made within 10 seconds. The input mode will be canceled if no action is taken for over 10 seconds.

---

## Erasing Disc Title/Station Title

---

- 1 Press TITLE to select the Title Display. Then, press again and hold for at least 2 seconds.**
  - For details, see asterisk 1 of "Displaying the Title/Text" (page 22).
- 2 Within 10 seconds, press and hold ▶/II for at least 2 seconds.**  
The title in the display will blink.
- 3 Within 10 seconds, press ◀◀ or ▶▶ repeatedly until the title you want to erase is displayed.**
- 4 Within 10 seconds, press and hold ▶/II for at least 2 seconds to erase the title displayed.**
- 5 Press TITLE to cancel the title erasing mode.**
  - You cannot erase CD-TEXT.
  - "TITLE NO DATA" ("NO DATA") is displayed for 2 seconds if the title is not input in step 2, or if all titles are erased in step 4.

---

## Displaying Time

---

Press TITLE repeatedly until the time is displayed.

Each press changes the display.  
For details, see "Displaying the Title/Text" (page 22).

- Selecting any tuner or CD function while in the clock priority mode will interrupt the time display momentarily. The function selected will be displayed for about 5 seconds before the time returns to the display.
- When the power is off but the ignition key is on, press TITLE to display the time (CDA-9853 only).

---

## Blackout Mode On and Off (CDA-9855 only)

---

When Blackout mode is turned on, the display will turn off to reduce power consumption. This additional power enhances the sound quality.

Press and hold FUNC. for at least 2 seconds to activate the blackout mode.

The display will turn off.

- If any button on the unit is pressed during the blackout mode, the function will be displayed for 5 seconds to show the operation before returning to Blackout mode.

To cancel Blackout mode, press and hold FUNC. for at least 2 seconds.

## Setting Amplifier Link

When an Amplifier Link compatible amplifier (MRD-M1005 or MRD-M605, etc.) is connected, the amplifier settings are adjustable from the head unit. A maximum of 8 external amplifiers can be adjusted.

- 1 Press and hold **MENU** for at least 2 seconds.
- 2 Select the Amplifier Link (A-LINK) mode by sliding your finger on the **GlideTouch bar** to the left or right. Press the **GlideTouch bar** under the Amplifier Link (A-LINK) mode.
- 3 Select the AMP-ID (AMP-1 to AMP-8) to be adjusted by sliding your finger on the **GlideTouch bar** to the left or right. Press the **GlideTouch bar** under the desired AMP-ID.

The input level mode to be adjusted is activated.

### If a Mono Amplifier is Connected

- 4 Adjust the input level by sliding your finger on the **GlideTouch bar** to the left or right. Press the **GlideTouch bar** under the desired level.

### If a 4ch Amplifier is Connected

- 4 Adjust the input level of CH 1/2 by sliding your finger on the **GlideTouch bar** to the left or right. Press the **GlideTouch bar** under the desired level.
- 5 Adjust the input level of CH 3/4 by sliding your finger on the **GlideTouch bar** to the left or right. Press the **GlideTouch bar** under the desired level.
- 6 When adjustment has been completed, press and hold **MENU** for at least 2 seconds to return to normal mode.

- For details of each of the settings, refer to the Owner's Manual of the external amplifier.
- If amplifier settings are made on the unit, do not then change the setting with the amplifier buttons as the amplifier display may not match the operations of the unit.
- "No Link" is displayed if the amplifier is removed or its power cannot be turned on, etc.
- If multiple amplifiers are connected to this unit, set a different ID on each amplifier. Otherwise the display may flicker.
- External amplifier information display can be changed by pressing **TITLE** while adjusting the input level.
- If the **GlideTouch bar** is pressed and held while adjusting the input level, the amplifier link mode can be switched between lock and unlock.
- If **MENU** is pressed while adjusting or setting the times in the MENU mode, the unit will return to the previous selection screen.
- By pressing the **GlideTouch bar** under RETURN in the MENU mode, the unit will return to the normal mode.
- If no operation is performed in 60 seconds, the unit will return to the normal mode.

## Displaying the External Amplifier Information

When an Amplifier Link compatible amplifier is connected, the amplifier's status (voltage, temperature and fan status) can be shown in the head unit's display.

- 1 Press **TITLE** in the Radio or CD mode to switch the display of the external amplifier information.

- For switching the display, refer to the section "Displaying the Title/Text" (page 22).
- For changing the XM display, refer to the section "Changing the Display" (page 32).
- For changing the iPod display, refer to the section "Displaying the Text" (page 36).

CDA-9855

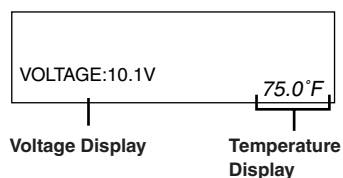

↕ The temperature display and the fan status display are alternately displayed.

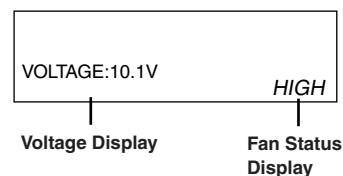

CDA-9853

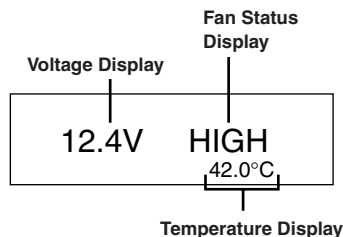

- To switch the display between Celsius and Fahrenheit, refer to page 30.

## Setting the Multicolor Illumination (CDA-9855 only)

You can change the lighting colour of the following four buttons : SOURCE/POWER, BAND, **◀◀** and **▶▶**.

- 1 Press **MENU**.
- 2 Select the Multicolor mode by sliding your finger on the **GlideTouch bar** to the left or right. Press the **GlideTouch bar** under the Multicolor mode.
- 3 Change the color by sliding your finger on the **GlideTouch bar** to the left or right. Press the **GlideTouch bar** under the desired color.

BLUE ↔ GREEN ↔ AMBER ↔ RED ↔ (USER'S\*)

- \* You can also use other colors if they have already been stored in the USER'S presets described below.
- According to the lighting color of the above four buttons, the color of the other buttons also changes. When the color of the four buttons is AMBER/RED, the color of the others is AMBER. When the color of the four buttons is BLUE/GREEN, the others are also GREEN.

### If you want to use colors other than the above

- 4 Turn the **Rotary encoder** to select colors (1 through 512).  
Each press of BAND advances the color number by 30.  
1.....19.....184.....363.....512  
(Red) (Amber) (Green) (Blue)
- 5 Select any one of the preset numbers (1 through 6) by sliding your finger on the **GlideTouch bar** to the left or right. Press the **GlideTouch bar** under the desired preset to store the adjustment.

#### To recall the stored color setting

- 1 Select USER'S 1 through 6 in step 3.  
The stored setting contents are recalled.

- 6 After setting, press and hold **MENU** for at least 2 seconds to return to normal mode.
- If **MENU** is pressed while adjusting or setting the times in the MENU mode, the unit will return to the previous selection screen.
  - By pressing the **GlideTouch bar** under RETURN in the MENU mode, the unit will return to the normal mode.
  - If no operation is performed in 60 seconds, the unit will return to the normal mode.

## Changing the Lighting Color of All the Buttons (CDA-9855 only)

- 1 Press **MENU**.
  - 2 Select the Multicolor mode by sliding your finger on the **GlideTouch bar** to the left or right. Press the **GlideTouch bar** under the Multicolor mode.
  - 3 Press **SOURCE/POWER**.  
The lighting color of all the buttons are changed.  
AMBER ↔ GREEN
  - 4 After setting, press and hold **MENU** for at least 2 seconds to return to normal mode.
- SOURCE/POWER, BAND, **◀◀** and **▶▶** buttons are changed to that which you have set above in "Setting the Multicolor Illumination" (this page).
  - If **MENU** is pressed while adjusting or setting the times in the MENU mode, the unit will return to the previous selection screen.
  - By pressing the **GlideTouch bar** under RETURN in the MENU mode, the unit will return to the normal mode.

# i-Personalize™ Operation

SOURCE/POWER

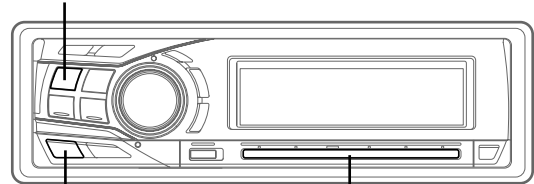

MENU

GlideTouch bar

## About i-Personalize™

You can download data (from Alpine's website) to a CD-R, and download and store the data to the CDA-9855/CDA-9853. To start i-Personalize, access the URL below and follow the on-screen instructions.

<http://www.alpine.com> or <http://www.alpine-usa.com>

#### Downloadable data

|   |   |
|---|---|
| Parametric equalizer or Graphic equalizer | Data is memorized in Preset 6 of the Parametric EQ mode or Graphic EQ mode. |
| Time correction                           | Data is memorized in Preset 6 of the Time Correction mode.                  |
| Crossover                                 | Data is memorized in Preset 6 of the crossover mode.                        |
| Profile (CDA-9855 only)                   | Data is set to the opening display.   |
| Calendar message (CDA-9855 only)          | Data is set to the calendar message.  |

The file name of download data shall be "A\_U\*\*\*\*.MP3."

A\_U\*\*\*\*.MP3

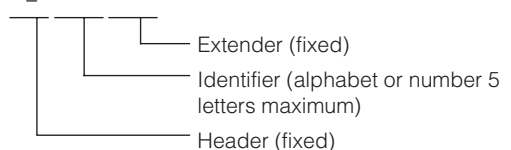

You can create a file name via the website. Do not change a file name once it has been created. Malfunction may result.

- For downloading procedure details, see ALPINE's Web site.
- If the HDA-5460 model is connected to this unit, the HDA-5460 hard disc can be used. Data that has been stored in the hard disc is downloaded by the "Data Downloading" operation to CDA-9855/CDA-9853. For details on how to download data to the hard disc, refer to the Owner's Manual of the HDA-5460 model.
- If an external audio processor is connected, data that is downloaded cannot be used.

## Data Downloading

- 1 Insert the CD-R disc containing the data.  
If the source is not the CD mode, press **SOURCE/POWER** to change to CD mode.
  - 2 Press **MENU**.
  - 3 Select the Download mode by sliding your finger on the **GlideTouch bar** to the left or right. Press the **GlideTouch bar** under the Download mode.
  - 4 Select Download (YES) by pressing the **GlideTouch bar** under Download (YES).  
Data search of the disc starts and the first file name is displayed.
    - If you want to cancel the data search, press the **GlideTouch bar** under CANCEL (NO).
    - If a file is not found by a data search, "No File" is indicated.
    - The "No File" display will automatically disappear if no operation is performed for 5 seconds.
  - 5 Select the file to download by sliding your finger on the **GlideTouch bar** to the left or right. Press the **GlideTouch bar** under the desired file.  
Data downloading starts.
  - 6 When data download is finished successfully, the confirmation screen is displayed (for the CDA-9853 model, each confirmation screen of download data is sequentially displayed), and download finishes.  
Successfully downloaded items are indicated as checked boxes on the confirmation screen.
- PARAMETRIC EQ or Graphic EQ data\***  
The data is memorized in Preset 6 of Parametric EQ mode or Graphic EQ mode. The memorized data settings in Preset 6 (Parametric EQ mode or Graphic EQ mode) are automatically applied.
- X-OVER (Crossover) data**  
The data is memorized in Preset 6 of X-OVER mode. The memorized data settings in Preset 6 (X-OVER mode) are automatically applied.  
You cannot download the data if the setting of the 2WAY/3WAY switch is not suitable for the data.
- TIME CORRECTION data**  
The data is memorized in Preset 6 of the Time correction mode. The memorized data settings in Preset 6 (Time Correction mode) are automatically applied.
- \* If the downloaded parametric EQ or graphic EQ differs from the current EQ mode, Preset 6 setting will not change automatically. Change the EQ mode and recall Preset 6.  
\* If data is downloaded while setting DEFEAT to ON, Preset 6 setting will not change automatically. Recall Preset 6 in the EQ mode.
- 7 Press and hold **MENU** for at least 2 seconds to return to normal mode.
    - When you download the data again, the data is overwritten in Preset 6.
    - If **MENU** is pressed while adjusting or setting the items in the **MENU** mode, the unit will return to the previous selection screen.
    - By pressing the **GlideTouch bar** under RETURN in the **MENU** mode, the unit will return to the normal mode.

## SETUP

You can flexibly customize the unit to suit your own preferences and usage. Choose the SETUP menu from General Setting, Tuner Setting, etc., to select your desired setting.

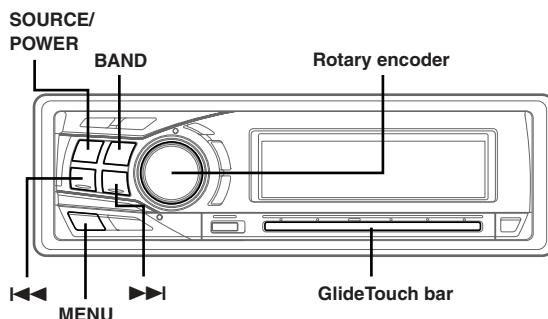

The common operation for SETUP is step 1 to 4 as follows. See down below for further information about each SETUP menu.

- 1 Press **MENU**.
- 2 Select **SETUP** by sliding your finger on the **GlideTouch bar** to the left or right. Press the **GlideTouch bar** under **SETUP**.  
The main SETUP menu is displayed.
- 3 Select the desired item by sliding your finger on the **GlideTouch bar** to the left or right. Press the **GlideTouch bar** under your selection.  
GENERAL ↔ TUNER ↔ AUDIO ↔ DISPLAY ↔ DEMO  
The SETUP menu of the selected item is displayed.
- 4 Select the desired item by sliding your finger on the **GlideTouch bar** to the left or right. Press the **GlideTouch bar** under your selection.

### CDA-9855:

#### GENERAL

CLOCK MODE\*1 ↔ CLOCK ADJUST ↔ PLAY MODE ↔ BEEP ↔ INT MUTE ↔ INT AUDIO ↔ AUX IN ↔ (AUX NAME)\*2 ↔ D-AUX ↔ POWER IC ↔ STEERING ↔ CLOCK MODE\*1

#### TUNER

TUNER MODE ↔ TUNER AREA\*3 ↔ XM ADF\*4 ↔ TUNER MODE

#### AUDIO

SUBWOOFER ↔ SUBW CH ↔ SUBW SYSTEM\*5 ↔ EQ MODE\*6 ↔ TW SETUP\*7 ↔ A.PROC TYPE ↔ SUBWOOFER

#### DISPLAY

DIMMER ↔ DIMMER LEVEL ↔ SCROLL TYPE ↔ TEXT SCROLL ↔ FONT SELECT ↔ A-LINK TEMP\*8 ↔ BGV SELECT ↔ OPENING MSG ↔ CALENDAR ↔ T.CORR\*9 ↔ DIMMER

#### DEMO

DEMO

## CDA-9853:

### **GENERAL**

CLOCK<sup>\*1</sup> ↔ PLAY MODE ↔ BEEP ↔ INT MUTE ↔  
INT AUDIO ↔ AUX IN ↔ (AUX NAME)<sup>\*2</sup> ↔ D-AUX ↔  
POWER IC ↔ STEERING

### **TUNER**

TUNER MODE ↔ TUNER AREA<sup>\*3</sup> ↔ XM ADF<sup>\*4</sup>

### **AUDIO**

SUBWOOFER ↔ SUBW CH ↔ SUBW SYSTEM<sup>\*5</sup> ↔  
EQ MODE<sup>\*6</sup> ↔ TW SETUP<sup>\*7</sup> ↔ AP SELECT

### **DISPLAY**

DIMMER ↔ DIMMER LEV ↔ SCROLL TYPE ↔ TEXT SCROLL  
↔ LCD CONTRAST ↔ A-LINK TEMP<sup>\*8</sup> ↔ AUDIO LEVEL ↔  
T.CORR PAR<sup>\*9</sup>

### **DEMO**

DEMO

<sup>\*1</sup> For the CDA-9855 model, refer to "Setting the Time and Calender (CDA-9855 only)" (page 7). For the CDA-9853 model, refer to "Setting Time (CDA-9853 only)" (page 7).

<sup>\*2</sup> Displayed only when AUX is ON.

<sup>\*3</sup> Refer to "Changing the Radio Frequencies for each Country" (page 9)

<sup>\*4</sup> Refer to "SAT Radio Receiver" section (page 31).

<sup>\*5</sup> Displayed only when SUBWOOFER is ON.

<sup>\*6</sup> Refer to "Setting User's EQ mode" (page 15).

<sup>\*7</sup> Displayed only when the 2WAY/3WAY switch (pages 45 to 47) is set to 3WAY.

This function cannot be selected when an external audio processor is connected.

<sup>\*8</sup> "A-LINK TEMP" is displayed when an Amplifier Link compatible external amplifier is connected.

<sup>\*9</sup> Refer to "Setting the Time Correction Unit" (page 20).

## **5 Change the parameter by pressing the GlideTouch bar under the setting desired.**

## **6 After setting, press and hold MENU for at least 2 seconds to return to normal mode.**

- If MENU is pressed while adjusting or setting the items in the MENU mode, the unit will return to the previous selection screen.
- By pressing the **GlideTouch bar** under RETURN in the MENU mode, the unit will return to the normal mode.
- If no operation is performed in 60 seconds, the unit will return to the normal mode.

## **General Setting**

General is selected on the setup main menu in step 3.

### **Setting the Clock display (CLOCK MODE) (CDA-9855 only)** **AM12:00 (12-hour (Initial setting)) / 00:00 (24-hour)**

You can select the clock display type, 12-hour or 24-hour, depending on your preference.

## **Playing MP3/WMA Data (PLAY MODE)**

**CDA-9855:CD-DA (Initial setting) / CDDA&MP3/WMA**  
**CDA-9853:CDDA (Initial setting) / CDDA&MP3/WMA**

This product can playback CDs containing both CD and MP3/WMA data. However, in some situations (some enhanced CDs), playback may be difficult. For these special cases, you can select playback of CD data only. When a disc contains both CD or the MP3/WMA data, playback starts from the CD data portion of the disc.

CDDA : Only CD data can be played back.  
CDDA&MP3/WMA : Both CD data and MP3/WMA file tracks can be played back.

- Perform this setting before inserting a disc. If a disc has already been inserted, perform the setting after you remove the disc. (If you use an MP3 changer, you have to change discs.)

## **Sound (Beep) Guide Function**

**BEEP ON (Initial setting) / BEEP OFF**

This function will give audible feedback with varying tones depending upon the button pressed.

## **Turning Mute Mode On/Off**

**INT MUTE ON (Initial setting) / INT MUTE OFF**

If a device having the interrupt feature is connected, audio will be automatically muted whenever the interrupt signal is received from the device.

## **Setting Tone Defeat for External Devices**

**INT AUDIO ON / INT AUDIO OFF (Initial setting)**

When inputting external devices to this unit, turning tone defeat on will bypass EQ and MX, i.e., sound for external devices is output at the default setting.

## **Setting the AUX Mode (V-Link)**

**AUX IN ON / AUX IN OFF (Initial setting)**

You can input TV/video sound by connecting an optional Ai-NET/RCA Interface cable (KCA-121B) or Versatile Link Terminal (KCA-410C) to this component.

You can change the AUX name display when AUX ON is set. Select the AUX name by sliding your finger on the **GlideTouch bar** to the left or right. Then press the **GlideTouch bar**.

If the KCA-410C is connected, it is possible to select two AUX names.

- Via KCA-410C, up to 2 external devices with RCA output can be connected. In this case, press **SOURCE/POWER** to select AUX mode and then press **BAND** to select your desired device.

## **Setting the External Digital Input**

**D-AUX ON / D-AUX OFF (Initial setting)**

When an ALPINE Ai-NET compatible digital audio processor (PXA-H510, PXA-H701) and a DVD player (DVE-5207) not compatible with Ai-NET are connected, set D-AUX to ON to enjoy 5.1-channel surround sound.

- After setting D-AUX to ON, make the setting in "Connecting an Optical Digital Compatible Audio Processor and an Ai-NET Non-Compatible DVD Player."
- Press **SOURCE/POWER**, and select the D-AUX mode, and adjust the volume, etc.
- Depending on the connected audio processor, DVD player sound may continue to be output, even though the source is changed to another one. If this occurs, set the DVD player's power to OFF.

## Connecting to an External Amplifier

**POWER-IC ON (Initial setting) / POWER-IC OFF**

When an external amplifier is connected, sound quality can be improved by stopping the power supply of the built-in amplifier.

**POWER-IC OFF** : Use this mode when the front and rear pre-amplifier of the unit are used to drive an external amplifier connected to the speakers. In this setting, the head unit's internal amplifier has no output to drive speakers.

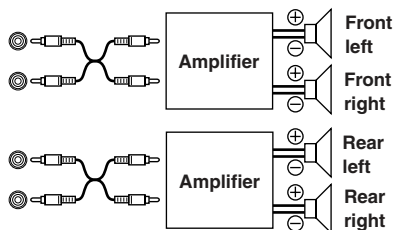

**POWER-IC ON** : The speakers are driven by the built-in amplifier.

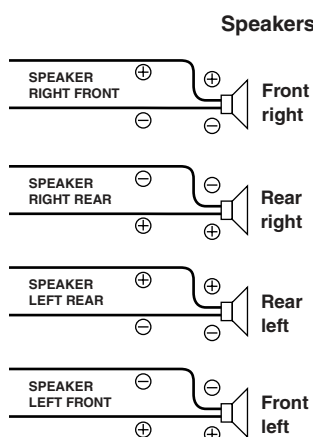

- No sound is produced by the system when the power output is set to OFF.

## Setting the Steering Position

**STEERING RIGHT / STEERING LEFT (Initial setting)**

According to the car's steering position, set to left or right.

- LEFT** : Set to LEFT for a left-hand drive. The right switch has priority when two switches on the GlideTouch bar are pressed.
- RIGHT** : Set to RIGHT for a right-hand drive. The left switch has priority when two switches on the GlideTouch bar are pressed.

## Tuner Setting

Tuner is selected on the setup main menu in step 3.

### Switching the Tuner Mode

**CDA-9855: STABLE / NORMAL (Initial setting) / HiFi**  
**CDA-9853: STABLE / NORMAL (Initial setting) / HI-FI**

This unit incorporates the MAX TUNE PRO for the highest quality tuner audio. Moreover, you can choose between three settings to suit your own personal sound preferences and usage.

- NORMAL** : Standard setting
- HI-FI** : Sound quality priority setting
- STABLE** : Noiseless priority setting

- If you find the sound is very noisy while listening to the tuner in Hi-Fi mode, we recommend you change to Normal mode.

## Audio Setting

Audio is selected on the setup main menu in step 3.

### Subwoofer On and Off

**SUBWOOFER ON (Initial setting) / SUBWOOFER OFF**

When the subwoofer is on, perform the steps below to adjust the subwoofer output phase and level.

- 1 Press the Rotary encoder repeatedly to select the SUBWOOFER mode.  
 SUBWOOFER → BALANCE → FADER → DEFEAT → VOLUME → SUBWOOFER

- If you set the 2WAY/3WAY switch (pages 45 to 47) to 3WAY, you cannot adjust the FADER mode.

- 2 Press ◀◀ or ▶▶.  
 The subwoofer output phase is toggled SUBWOOFER NORMAL (0°) or SUBWOOFER REVERS (180°). To adjust the level, turn the Rotary encoder.

### Setting the Subwoofer Output

**CDA-9855: SUBW CH ST (Initial setting) / MONO**  
**CDA-9853: SUBW CH STEREO (Initial setting) / MONO**

You can set the subwoofer output to stereo or monaural. Make sure to set the correct output for your subwoofer type.

- STEREO** : Subwoofer stereo (L/R) output
- MONO** : Subwoofer monaural output

### Setting the Subwoofer System

**CDA-9855: SUBW SYS1 (Initial setting) / SUBW SYS2**  
**CDA-9853: SUBW SYSTEM1 (Initial setting) / SUBW SYSTEM2**

Select either SYSTEM1 or SYSTEM2 for the desired subwoofer effect.

- SYSTEM1** : Subwoofer level changes according the main volume setting.
- SYSTEM2** : Subwoofer level change is different from the main volume setting. For example, even at low volume settings, the subwoofer is still audible.

### Setting the Response Slope for the High Range Speaker (TW SETUP)

**MAKER'S (Initial setting) / USER'S**

Depending on the response characteristics of the speaker, care should be taken when setting the response slope of the high range speaker to FLAT in 3-way mode (see "Adjusting and Storing the Crossover Settings" on page 18), as speaker damage may result.

- MAKER'S** : As protection from possible speaker damage, FLAT cannot be set for the response slope of the high range speaker in 3-way mode.
- USER'S** : The FLAT setting is possible in 3-way mode.

- A message is displayed when the response slope for the high range speaker is set to FLAT in 3-way mode (CDA-9855 only).

## **Connecting an Optical Digital Compatible Audio Processor and an Ai-NET Non-Compatible DVD Player H510 / OTHER (Initial setting)**

After setting D-AUX to ON in "Setting the External Digital Input," do the following according to the audio processor type:

**H510** : If a PXA-H510 and a DVD player (DVE-5207) not compatible with Ai-NET are connected (using an optical cable), use the H510 setting. Connect the DVD player to the optical digital input (DVD Player) terminal of the processor.

**OTHER** : If an audio processor other than a PXA-H510 and a DVD player (DVE-5207) not compatible with Ai-NET are connected (using an optical cable), use the OTHER setting. Connect the DVD player to the optical digital input (Head unit) terminal of the processor.

- After input selection is completed, turn the ignition off and back on again. Setting of the optical digital input switch is completed.

## **Display Setting**

The display is selected on the setup main menu in step 3.

### **Dimmer Control**

**DIMMER AUTO (Initial setting) / DIMMER MANUAL**

Set the DIMMER control to AUTO to decrease the illumination brightness of the unit with the head lights of the vehicle ON. This mode is useful if you feel the unit's backlighting is too bright at night.

### **Setting the Display Dimmer**

**CDA-9855: DIMMER Level1 (initial setting) / Level2 / Level3**  
**CDA-9853: DIMMER LEV1 (initial setting) / 2 / 3**

In the display Dimmer AUTO setting, three levels are available, the highest level (LEVEL 3) being the dimmest when the car headlights are on.

### **Scroll Type Setting**

**TYPE1 / TYPE2 (Initial setting)**

Two types of scroll can be selected.  
You can select the scroll type you like.

**TYPE1** : The characters scroll right to left, appearing from the right side of the display, one character at a time.

**TYPE2** : The display will show complete words, unless they do not fit in the display at one time. Words hyphenated when necessary and are shown sequentially until the full title has been displayed.

### **Scroll Setting**

**AUTO / MANUAL (Initial setting)**

This CD player can scroll the disc and track names recorded on CD-TEXT discs, as well as the text information of MP3/WMA files, folder names, and tags.

**AUTO** : The CD text information, the text information of folder and file names, and the tags are scrolled automatically.

**MANUAL** : The display is scrolled when a disc is loaded or when a track is changed, etc.

- The unit scrolls CD text names, folder names, file names or tag display. The disc titles input manually (page 24) cannot be scrolled.

## **Adjusting Display Contrast (CDA-9853 only)**

**CONTRAST**

You can adjust the display contrast for better visibility.

You can adjust in a range of - 6 and + 6.

- The initial setting at the factory is "0."

## **Switching the Character Font (CDA-9855 only)**

**TYPE1 (Initial setting) / TYPE2**

Two types of font can be selected.

You can select the font type you like.

## **Setting the Temperature Display for the External Amplifier**

**CDA-9855: A-LINK F (Initial setting) / A-LINK C**

**CDA-9853: AMP TEMP °F (Initial setting) / AMP TEMP °C**

When a separately sold Amplifier Link compatible amplifier is connected, you can set how to display its temperature. You can switch the setting between Fahrenheit and Celsius.

°F : The temperature is displayed in Fahrenheit.

°C : The temperature is displayed in Celsius.

## **Setting the Display of the Audio Level Indicator (CDA-9853 only)**

**AUDIO LV ON (initial setting) / AUDIO LV OFF**

You can set whether the audio level indicator is displayed.

## **Switching the Animation Display Type (CDA-9855 only)**

**TYPE1 (initial setting) / TYPE2 / TYPE3 / OFF**

When the animation display is set in "Displaying the Title/Text" (page 22), you can select your favorite animation display from 3 types.

## **Opening Message ON/OFF Setting (CDA-9855 only)**

**OPENING MSG ON / OPENING MSG OFF (Initial setting)**

You can select whether the opening display is shown or not when power is turned ON. Choose between the standard display pattern and the downloaded Profile data display pattern.

This function is only available if you have already downloaded the profile data.

**OFF mode:** This shows the standard display pattern.

**ON mode:** This shows the downloaded Profile data and the calendar message after data downloading.

## **Setting of Calendar Display Pattern Switching (CDA-9855 only)**

**dd/mm/yyyy (Initial setting) / yyyy/mm/dd**

You can switch the calendar display pattern to be shown when the time is displayed.

yyyy : shows the year

mm : shows the month

dd : shows the day

ex. dd/mm/yyyy → 25/12/2004

## **Demo Setting**

Demo is selected on the setup main menu in step 3.

### **Demonstration**

**DEMO ON / DEMO OFF (Initial setting)**

This unit has a Demonstration feature for the display and sound.

- To quit Demo mode, set to DEMO OFF.

# SAT Radio Receiver (Optional)

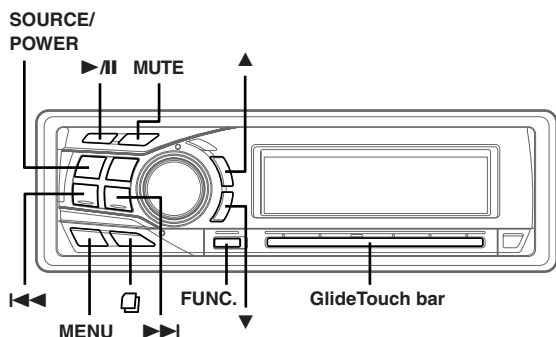

SAT Receiver: XM or SIRIUS Receiver

When an optional XM or SIRIUS Receiver Box is connected via the Ai-NET bus, the following operations may be performed. However, the XM Receiver and SIRIUS Receiver cannot be connected at the same time.

## Receiving Channels with the SAT Radio Receiver (Optional)

### About SAT Radio

Satellite Radio\* is the next generation of audio entertainment, with over 100 digital audio channels. For a small monthly fee, subscribers can hear crystal-clear music, sports, news and talk, coast-to-coast via satellite. For more information, visit XM's website at [www.xmradio.com](http://www.xmradio.com), or SIRIUS' website at [www.sirius.com](http://www.sirius.com).

To receive SAT Radio, the separately sold XMDirect™ or SIRIUS Satellite Radio Tuner and an appropriate Ai-NET Interface Adapter will be required. For details, consult your nearest ALPINE dealer.

\* XM and its corresponding logos are trademarks of XM Satellite Radio Inc.

\* SIRIUS and its corresponding logos are trademarks of SIRIUS Satellite Radio Inc.

• The SAT Receiver controls on the CDA-9855/CDA-9853 are operative only when a SAT Receiver is connected.

**1** Press **SOURCE/POWER** to select XM mode.

**2** Press **BAND** to select XM1, XM2 or XM3.

Each press changes the band:

XM mode:

XM1 → XM2 → XM3 → XM1

SIRIUS mode:

SIRIUS1(SR1) → SIRIUS2(SR2) → SIRIUS3(SR3) →

SIRIUS1(SR1)

**3** Press **▲** or **▼** to select desired category.

**4** Press **◀◀** or **▶▶** to select the desired channel.

Holding down **◀◀** or **▶▶** will change channels continuously.

• When using the optional remote control (RUE-4190), an SAT Radio Channel can be directly called up with the numeric keypad of the remote control.

1 While in XM or SIRIUS Radio mode, enter the Channel number you want to call up with the numeric keypad on the remote control.

2 Press **ENTER** on the remote control within 5 seconds to receive the Channel.

If the channel number is 3 digits, the Channel is automatically received after the channel number is input.

## Checking the SAT Radio ID Number

A unique Radio ID number is required to subscribe to SAT Radio programming. Each third party XM or SIRIUS radio comes with this number.

This number is an 8 character (for XM Radio) or 12 character (for SIRIUS Radio) alphanumeric number. It is printed on a label found on the SAT Receiver.

It can also be displayed on the screen of the CDA-9855/CDA-9853 in the following way.

**1** While receiving band, press **◀◀** or **▶▶** to select channel "0."

The unit alternately displays "RADIO ID" for 2 seconds, then the ID number for 10 seconds.

**2** To cancel the ID number display, set the channel to other than "0."

• You cannot use "O," "S," "I," or "F" for the ID Number (XM radio Receiver only).

• You can check the ID number printed on a label on your third party, SAT Radio Receiver package.

## Storing Channel Presets

**1** Press **BAND** to select the desired band you want to store.

**2** After tuning in the desired channel, press **FUNC.** to activate the preset mode.

**3** Select any one of the preset numbers (1 through 6) by sliding your finger on the **GlideTouch bar** to the left or right. Press and hold the **GlideTouch bar** for at least 2 seconds, under the desired preset to store the channel.

**4** Repeat the procedure to store up to 5 other channels onto the same band.

• To use this procedure for other bands, simply select the band desired and repeat the procedure.

• A total of 18 channels can be stored in the preset memory (6 channels for each band; XM1, XM2 and XM3 or SIRIUS1, SIRIUS2 and SIRIUS3).

• If you store a channel in a preset memory which already has a station, the current channel will be cleared and replaced with the new one.



## Receiving Stored Channels

- 1 Press **BAND** to select the desired band.
- 2 Press **FUNC.** to activate the preset mode.
- 3 Select any one of the preset numbers (1 through 6) by sliding your finger on the **GlideTouch bar** to the left or right. Press the **GlideTouch bar** for under the desired preset to receive the channel.

## Channel/Category Search Function

You can search for programs by Channel No. or Category.

- 1 Press and hold  in XM or SIRIUS mode to select Channel Search mode or Category Search mode.

### Category Search mode



- 2 Within 10 seconds, select your desired Category by sliding your finger on the **GlideTouch bar** to the left or right. Press **▶/||** to receive the selected Category.

To search for a channel in the selected category, press the **GlideTouch bar** or **FUNC.** to change to the Channel search mode. Refer to "Channel Search mode" for operation.

- Search mode is canceled by pressing and holding  for at least 2 seconds in Category Search mode.
- The Category can be scrolled continuously by touching and holding either side of the **GlideTouch bar**.
- You can speed up your search by sliding your finger quickly on the **GlideTouch bar** to skip categories.

### Channel Search mode

- 2 Within 10 seconds, select your desired Channel No. by sliding your finger on the **GlideTouch bar** to the left or right. Press the **GlideTouch bar** for under the desired channel.

- Search mode is canceled by pressing and holding  for at least 2 seconds in Channel Search mode.
- While in Channel Search mode, press **▲** or **▼** to select the another Category.
- While in Channel Search mode, press  to switch to the Category Search mode.
- The Channel can be scrolled continuously by touching and holding either side of the **GlideTouch bar**.
- You can speed up your search by sliding your finger quickly on the **GlideTouch bar** to skip channels.

## Quick Search Function

You can search for all Channels.

- 1 Press and hold  for at least 2 seconds in XM or SIRIUS mode to activate Quick Search mode.
- 2 Within 10 seconds, select your desired channel by sliding your finger on the **GlideTouch bar** to the left or right.

The selected Channel is received.

## Changing the Display

Text information, such as the channel name, artist name/feature, and song/program title, is available with each XM or SIRIUS channel. The unit can display this text information as explained below.

In XM or SIRIUS mode, press **TITLE**.

Each time you press this button, the display changes as shown below.

### CDA-9855

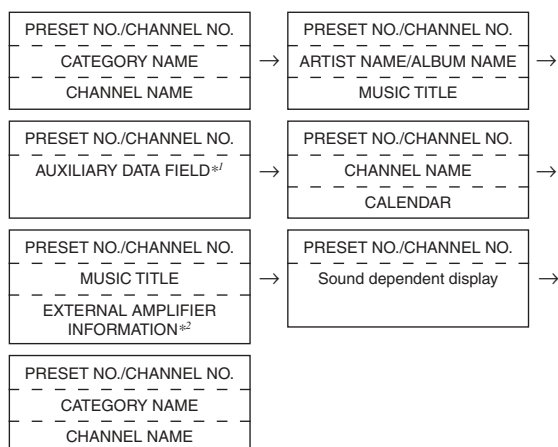

### CDA-9853

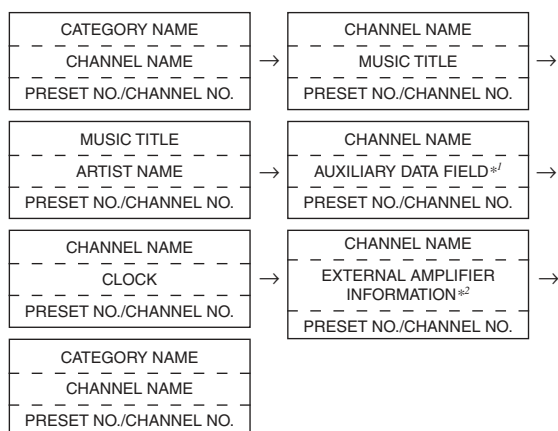

\*1 XM mode only:

When ADF is turned OFF, this information is not displayed (see "Setting the Auxiliary Data Field Display" on page 33).

\*2 Only when an external Amplifier Link compatible amplifier is connected. For details, refer to "Displaying the External Amplifier Information" (page 25).

- When the “Scroll Setting” (page 30) is set to “AUTO,” the display scrolls continuously.  
When the Scroll Setting is set to “MANUAL,” the display scrolls only once after any function is performed (PRESET, BAND, SEARCH, etc.).  
Press and hold **TITLE** for more than 2 seconds to scroll the display manually.
- “Channel Number” and “Clock” displays do not scroll.
- Depending on the model, the display may differ from the one shown above.

## Setting the Auxiliary Data Field Display

The XM Auxiliary Data Field (ADF) display can be switched on or off.

- 1 Press MENU.**
- 2 Select SETUP by sliding your finger on the GlideTouch bar to the left or right. Press the GlideTouch bar under SETUP.**  
The main SETUP menu is displayed.
- 3 Select TUNER by sliding your finger on the GlideTouch bar to the left or right. Press the GlideTouch bar under TUNER.**  
The TUNER SETUP menu is displayed.
- 4 Select XM ADF by sliding your finger on the GlideTouch bar to the left or right. Press the GlideTouch bar under XM ADF.**
- 5 Press the GlideTouch bar under ON or OFF in the Function Guide display.**
- 6 Press and hold MENU for at least 2 seconds to return to the normal mode.**
  - If **MENU** is pressed while adjusting or setting the times in the **MENU** mode, the unit will return to the previous selection screen.
  - By pressing the **GlideTouch bar** under **RETURN** in the **MENU** mode, the unit will return to the normal mode.

# iPod™ Operation (Optional)

SOURCE/  
POWER

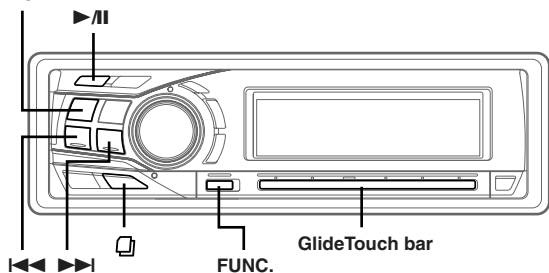

When an iPod™ or iPod™ mini is connected to the optional Alpine Interface adapter for iPod™ (KCA-420i), it can be controlled from the CDA-9855/CDA-9853. However, operation from the iPod is disabled.

- For details, refer to the Owner's Manual of the iPod™ Interface adapter (KCA-420i).
- Refer to the iPod's documentation for a description of its functions.

## Playback

**1 Press SOURCE/POWER to switch to the iPod mode.**

**2 Press ◀◀ or ▶▶ to select the desired song.**

**Return to the beginning of the current song:**

Press ◀◀.

**Fast backward:**

Press and hold ◀◀.

**Advance to the beginning of the next song:**

Press ▶▶.

**Fast forward:**

Press and hold ▶▶.

**3 To pause playback, press ▶/||.**

Pressing ▶/|| again will resume playback.

- If a song is playing on the iPod when it is connected to the adapter, it will continue playing after the connection.
- If using the iPod with a changer, the Versatile Link Terminal (KCA-410C) must be used. In this case, press **BAND** to select the changer mode applicable to the iPod.
- With the CDA-9855, you can return to the beginning of the current track, fast forward/fast reverse and playback/pause. The source operation mode is selected by touching the **Glide Touch bar** under **FUNC.** in the function guide display.

## Searching for a desired Song

An iPod can contain hundreds of songs. By keeping these songs organized in playlists, the CDA-9855/CDA-9853 can use these to ease song searches.

- When *Shuffle (M.I.X.)* is on, the search function cannot be used.

### Searching by Playlist

- 1 Press ◻.**
- 2 Select PLAYLIST by sliding your finger on the GlideTouch bar to the left or right. Press the GlideTouch bar under PLAYLIST.**
- <sup>\*1</sup> **3 Within 10 seconds, select the playlist by sliding your finger on the GlideTouch bar to the left or right.**
- 4 Within 10 seconds, press ▶/|| to play back a selected playlist.**

### To search for a song in the selected playlist

- 1 After selecting the playlist in step 3<sup>\*1</sup>, press the **GlideTouch bar** or **FUNC.** to change to the song search mode of the selected playlist.
  - 2 Within 10 seconds, select a song by sliding your finger on the **GlideTouch bar** to the left or right, then pressing ▶/|| or the **GlideTouch bar**.  
The selected song is played back.
- If you choose "iPod name" of iPod in step 3<sup>\*1</sup> and you press ▶/||, all songs in iPod are played back.
  - The search mode is cancelled by pressing and holding ◻ for at least 2 seconds in the search mode.
  - The playlist can be scrolled continuously by touching and holding either side of the **GlideTouch bar**.
  - You can speed up your search by sliding your finger quickly on the **GlideTouch bar** to skip playlists.

### Searching by artist name

- 1 Press ◻.**
- 2 Select ARTIST by sliding your finger on the GlideTouch bar to the left or right. Press the GlideTouch bar under ARTIST.**
- <sup>\*2</sup> **3 Within 10 seconds, select the artist to be played back by sliding your finger on the GlideTouch bar to the left or right.**
- 4 Within 10 seconds, press ▶/|| to play back all songs of the selected artist.**

## To search for an album of the selected artist

- 1 After selecting the artist in step 3<sup>\*2</sup>, press the **GlideTouch bar** or **FUNC.** to change to the album search mode of the selected artist.
- 2<sup>\*3</sup> Within 10 seconds, select the album to be played back by sliding your finger on the **GlideTouch bar** to the left or right.
- 3 Press **▶/||** to play back all songs of the selected album.

## To search for a song of the selected album

- 1 After selecting the album in step 2<sup>\*3</sup>, press the **GlideTouch bar** or **FUNC.** to change to the song search mode of the selected album.
  - 2 Within 10 seconds, select a song by sliding your finger on the **GlideTouch bar** to the left or right, then pressing **▶/||** or the **GlideTouch bar**.  
The selected song is played back.
- If you choose **ALL** in step 3<sup>\*2</sup>, and you press **▶/||**, all songs in iPod are played back. If you choose **ALL**, and you press the **GlideTouch bar** or **FUNC.**, the **ALBUM** search mode for all artists is activated.
  - If you choose **ALL** in step 2<sup>\*3</sup>, and you press **▶/||**, all songs of the selected artist are played back. If you choose **ALL**, and you press the **GlideTouch bar** or **FUNC.**, the **SONG** search mode for the selected artist is activated.
  - The search mode is cancelled by pressing and holding **□** for at least 2 seconds in the search mode.
  - The artist, album or song can be scrolled continuously by touching and holding either side of the **GlideTouch bar**.
  - You can speed up your search by sliding your finger quickly on the **GlideTouch bar** to skip artists, albums or songs.

## Searching by album name

- 1 Press **□**.
- 2 Select **ALBUM** by sliding your finger on the **GlideTouch bar** to the left or right. Press the **GlideTouch bar** under **ALBUM**.
- 3<sup>\*4</sup> Within 10 seconds, select the album to be played back by sliding your finger on the **GlideTouch bar** to the left or right.
- 4 Within 10 seconds, press **▶/||** to play back all songs of the selected album.

## To search for a song of the selected album

- 1 After selecting the album in step 3<sup>\*4</sup>, press the **GlideTouch bar** or **FUNC.** to change to the song search mode of the selected album.
  - 2 Within 10 seconds, select a song by sliding your finger on the **GlideTouch bar** to the left or right, then pressing **▶/||** or the **GlideTouch bar**.  
The selected song is played back.
- If you choose **ALL** in step 3<sup>\*4</sup>, and you press **▶/||**, the search mode is canceled. If you choose **ALL**, and you press the **GlideTouch bar** or **FUNC.**, the **SONG** search mode for all albums is activated.
  - The search mode is cancelled by pressing and holding **□** for at least 2 seconds in the search mode.
  - The album or song can be scrolled continuously by touching and holding either side of the **GlideTouch bar**.
  - You can speed up your search by sliding your finger quickly on the **GlideTouch bar** to skip albums or songs.

## Quick Search

You can search for songs.

- 1 Press and hold **□** for at least 2 seconds to activate the quick search mode.
- 2 Select the desired song by sliding your finger on the **GlideTouch bar** to the left or right.  
The selected song is played back immediately.

- The search mode is cancelled by pressing and holding **□** for at least 2 seconds in the search mode.
- The songs can be scrolled continuously by touching and holding either side of the **GlideTouch bar**.
- You can speed up your search by sliding your finger quickly on the **GlideTouch bar** to skip songs.
- "Quick Search" ("QUICK SEARCH") is displayed during Quick search.

## Random Play Shuffle (M.I.X.)

The Shuffle function of the iPod is displayed as M.I.X. on the CDA-9855/CDA-9853.

### Shuffle Albums (M.I.X. ALBUM):

Select an album randomly in the iPod, and plays back the songs of the album in sequential order. If a song has been selected in the playlist/artist search mode before selecting Shuffle Album, only the albums within the playlist/artist are selected randomly. The songs of the album are played back sequentially.

### Shuffle Songs (M.I.X. ALL):

All songs in the iPod are played back in random sequence. If a song has been selected in the playlist/artist search mode before selecting Shuffle song, only the songs of the playlist/artist/album are played back randomly.

- 1 Press **FUNC.** to activate the audio function mode.

Source select mode → Audio function mode → Source operation mode\* → Source select mode

\* CDA-9855 only

- 2 Press the **GlideTouch bar** under the **MIX** function in the function guide display.

The songs will be played back in random sequence.



The Random Play mode is canceled by selecting off.

- The function mode you previously recalled can be recalled again if the **GlideTouch bar** is touched.
- If no operation is performed for 10 seconds, the audio function mode turns off.
- For details of the search mode, refer to "Searching for a desired Song" (page 34).
- If a song is selected in the album search mode before selecting Shuffle (M.I.X.), the songs will not play back randomly even when Shuffle album is selected.
- If there is no album in the playlist, Shuffle (M.I.X.) will not function even when Shuffle album is selected.

## Repeat Play

Only Repeat One is available for the iPod.

Repeat One: A single song is repeatedly played back.

### 1 Press **FUNC.** to activate the audio function mode.

Source select mode → Audio function mode → Source operation mode\* → Source select mode

\* CDA-9855 only

### 2 Press the **GlideTouch** bar under the RPT function in the function guide display.

The song will be played back repeatedly.

RPT ↔ (off)  
(Repeat One)

The RPT mode is canceled by selecting off.

- The function mode you previously recalled can be recalled again if the **GlideTouch** bar is touched.
- If no operation is performed for 10 seconds, the audio function mode turns off.
- During repeat playback, no other songs are selectable by pressing **◀◀** or **▶▶**.

\*1 "NO DATA" is displayed if there is no information.

\*2 Only when an external Amplifier Link compatible amplifier is connected. For details, refer to "Displaying the External Amplifier Information" (page 25).

- When the Scroll Setting (page 30) is set to "MANUAL," press and hold **TITLE** for at least 2 seconds to scroll the tag information only once.
- Elapsed time is displayed for 5 seconds immediately after changing sources or songs, etc. (CDA-9853 only)
- Only alphanumeric characters can be displayed.
- When the artist name, album name or song name is set on iTunes, and the amount of characters is increased, songs may not be played back when connected to the adapter. Therefore, a maximum of 250 characters is recommended. The maximum number of characters for the head unit is 64.
- Some characters may not be correctly displayed.
- "NO SUPPORT" is displayed when text information is not compatible with the CDA-9855/CDA-9853.

## Displaying the Text

You can display the tag information of a song in the iPod.

### Press **TITLE**.

Each press changes the display.

#### CDA-9855

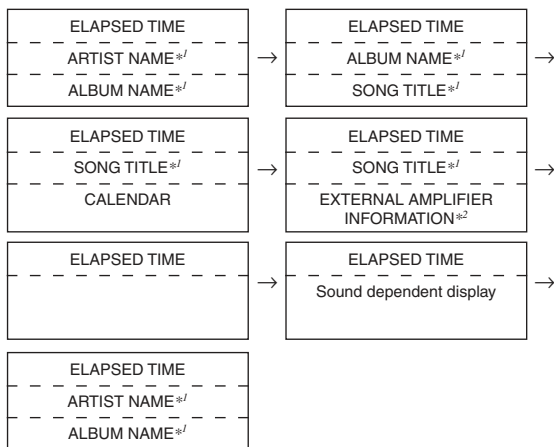

#### CDA-9853

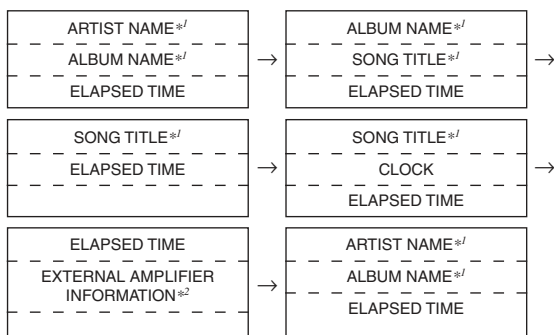

# Changer (Optional)

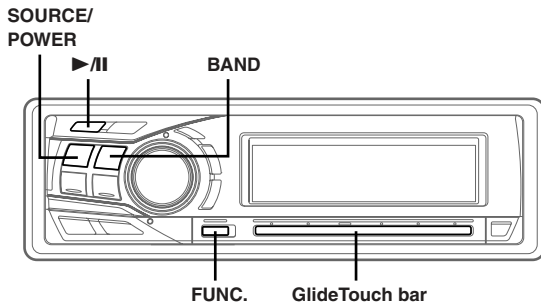

## Controlling CD Changer (Optional)

An optional 6-disc or 12-disc CD Changer may be connected to this unit if it is Ai-NET compatible. With a CD Changer connected to the Ai-NET input of this unit, the CD Changer will be controllable from this unit.

Using the KCA-400C (Multi-Changer Switching device) or the KCA-410C (Versatile Link Terminal) multiple changers can be controlled by this unit.

See "Multi-Changer Selection" on this page for selecting the CD Changers.

- The controls on this unit for CD Changer operation are operative only when a CD Changer is connected.
- The DVD changer (optional) is controllable from this unit as well as the CD changer.

### 1 Press SOURCE/POWER to activate the CHANGER mode.

The display shows the disc number and track number.

- The source indicator varies depending on the connected source.

### 2 Press FUNC. to activate the direct disc recall mode.

Source selection mode ↔ Audio function mode ↔ Direct disc recall mode ↔ Source operation mode\* ↔ Source selection mode

\* CDA-9855 only

### 3 Select a disc (1 to 6) or (1 to 12) by touching the GlideTouch bar and sliding your finger to the left or right. Press the GlideTouch bar under the desired disc.

The selected disc number appears in the display and CD playback starts.

- After selecting the desired disc, you can operate in the same way as for the CD player of this unit.  
For details, please see the CD/MP3/WMA section.

## Playing MP3 Files with the CD Changer (Optional)

If you connect a changer compatible with MP3, you can play CD-ROMs, CD-Rs, and CD-RWs containing MP3 files on this unit.

### 1 Press SOURCE/POWER to switch to the MP3 Changer mode.

### 2 Press FUNC. to activate the direct disc recall mode.

Source selection mode ↔ Audio function mode ↔ Direct disc recall mode ↔ Source operation mode\* ↔ Source selection mode

\* CDA-9855 only

### 3 Select a disc (1 to 6) by touching the GlideTouch bar and sliding your finger to the left or right. Press the GlideTouch bar under the desired disc.

### 4 To pause playback, press ►/II.

Pressing ►/II again will resume playback.

- The unit can play discs containing both audio data and MP3 data.
- For operating MP3 with an MP3 compatible CD Changer, refer to "CD/MP3/WMA" pages 10 to 14.

## Multi-Changer Selection (Optional)

Alpine's Ai-NET system will support up to 6 CD Changers. When operating two or more changers, the KCA-400C (Multi-Changer Switching device) must be used. If you use 1 Switching device, you can connect up to 4 CD Changers. If you use 2 Switching devices, you can connect up to 6 CD Changers. When using KCA-410C (Versatile Link Terminal), you can connect two changers and two external outputs (AUX).

### 1 Press SOURCE/POWER on this unit to activate the CD Changer mode.

Alternatively, press SOURCE on the remote control (RUE-4202) to activate the CD Changer mode.

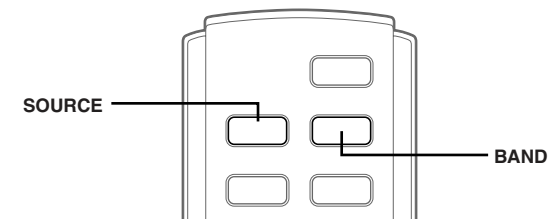

### 2 Press BAND on this unit or the RUE-4202 to activate the CD Changer Selection mode.

The CD Changer Selection mode remains active for a few seconds.

### 3 Press BAND until the desired CD Changer indicator appears on the display.

Alternatively press BAND on the Remote Control until the desired changer indicator appears on the display.

- If the selected CD Changer is not connected, the display will show "NO CHGR."
- To operate the selected changer, see "CD/MP3/WMA" (page 10).
- For further details about the external input (AUX) when using KCA-410C, see "Setting the AUX Mode (V-Link)" on page 28.

# Remote Control

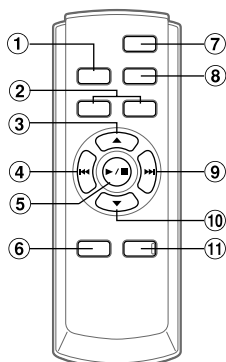

## Controls on Remote Control

- ① **Source Button**  
Press this button to select the audio source.
- ② **Volume Adjustment Buttons**  
To increase the volume level:  
Press the [▲] button  
  
To decrease the volume level:  
Press the [▼] button
- ③ **▲ Button**  
Radio mode: Pressing this button will select, in ascending order, stations programmed into the radio's presets as shown below.  
[1] → [2] ... [6] → [1]  
  
CD Changer mode: DISC Select (UP) button  
Press this button to select a disc in ascending order.  
  
MP3/WMA mode: Folder Select (UP) button. Press this button to select the folder.  
  
MP3 compatible CD changer mode:  
Folder Select (UP) / DISC Select (UP) button  
Press this button to select a folder in ascending order.  
Press and hold this button to select a disc in ascending order.
- ④ **◀◀ DN Button**  
Radio mode: SEEK (DN) Button  
CD mode: Press this button to go back to the beginning of the current track.
- ⑤ **▶/II Button**  
Press this button to switch between the Play and Pause modes for CD.
- ⑥ **Audio Processor Button**  
Each press of the button changes the audio processor mode.  
For details, refer to "Operating the Audio Processor" as shown below.  
Press the button to call the external audio processor mode when the external audio processor is connected.\*<sup>1</sup>
- ⑦ **Power Button**  
Press this button to turn the power on/off.

- ⑧ **Band Button**  
Radio mode: BAND Button  
Press this button and the band will change.  
  
Changer mode: To switch the changer.
- ⑨ **▶▶ UP Button**  
Radio mode: SEEK (UP) button  
CD mode: Press this button to advance to the beginning of the next track.
- ⑩ **▼ Button**  
Radio mode: Pressing this button will select, in descending order, stations programmed into the radio's presets as shown below.  
[6] → [5] ... [1] → [6]  
  
CD Changer mode: DISC Select (DN) button  
Press this button to select a disc in descending order.  
MP3/WMA mode: Press the Folder Select (DN) button.  
Press this button to select the folder.  
  
MP3 compatible CD changer mode:  
Folder Select (DN) / DISC Select (DN) button  
Press this button to select a folder in descending order.  
Press and hold this button to select a disc in descending order.
- ⑪ **Mute Button**  
Press this button to lower the volume by 20 dB instantly.  
Press this button again to cancel.

\*<sup>1</sup> For the operation of external audio processor, refer to the Owner's Manual of the external audio processor you purchased.

## Operating the Audio Processor

- 1 **Press A.PROC to select the mode.**  
Normal mode → EQ mode (Equalizer Presets) → Time Correction mode (Recalling the Stored Time Correction) → Crossover mode (Recalling the Stored Crossover) → Normal mode
- 2 **Press ▲ or ▼ to select the item.**  
EQ mode:  
Select from factory's EQ mode and USER'S 1 to 6.  
  
Time Correction mode/Crossover mode:  
Select from MEMORY 1 through 6.

## Battery Replacement

Applicable battery: Use two "AAA" sized dry batteries or equivalent.

### 1 Opening the battery cover

Slide out the battery cover while firmly pressing in the direction of the arrow.

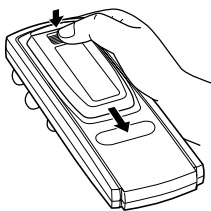

### 2 Replacing the battery

Insert the batteries, observing the polarities as illustrated.

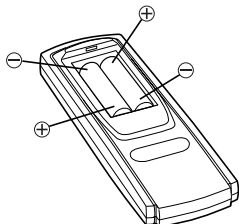

### 3 Closing the cover

Slide the cover as illustrated until a click is heard.

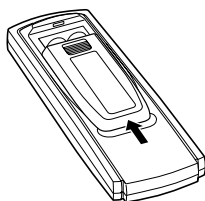

Point the remote control transmitter at the remote control sensor.

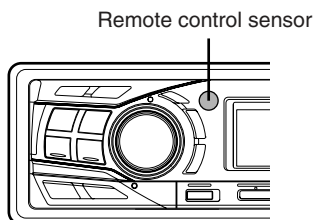

#### Connectable to Steering Remote Control Interface Box

You can operate this unit from the vehicle's control unit when an Alpine Steering Remote Control Interface Box (optional) (for sale in the near future) is connected. For details, contact your Alpine dealer.

## Information

### In Case of Difficulty

If you encounter a problem, please turn the power off, then on again. If the unit is still not functioning normally, please review the items in the following checklist. This guide will help you isolate the problem if the unit is at fault. Otherwise, make sure the rest of your system is properly connected or consult your authorized Alpine dealer.

#### Basic

##### No function or display.

- Vehicle's ignition is off.
  - If connected following instructions, the unit will not operate with the vehicle's ignition off.
- Improper power lead connections.
  - Check power lead connections.
- Blown fuse.
  - Check the fuse of the unit; replace with the proper value if necessary.
- Internal micro-computer malfunctioned due to interference noise etc.
  - Press the RESET switch with a ballpoint pen or other pointed article.

#### Radio

##### Unable to receive stations.

- No antenna or open connection in cable.
  - Make sure the antenna is properly connected; replace the antenna or cable if necessary.

##### Unable to tune stations in the seek mode.

- You are in a weak signal area.
  - Make sure the tuner is in the DX mode.
- If the area you are in is a primary signal area, the antenna may not be grounded and connected properly.
  - Check your antenna connections; make sure the antenna is properly grounded at its mounting location.
- The antenna may not be the proper length.
  - Make sure the antenna is fully extended; if broken, replace the antenna with a new one.

##### Broadcast is noisy.

- The antenna is not the proper length.
  - Extend the antenna fully; replace it if it is broken.
- The antenna is poorly grounded.
  - Make sure the antenna is grounded properly at its mounting location.



## CD

### CD Player/Changer not functioning.

- Out of operating temperature range +50°C (+120°F) for CD.
  - Allow the vehicle's interior (or trunk) temperature to cool.

### CD playback sound is wavering.

- Moisture condensation in the CD Module.
  - Allow enough time for the condensation to evaporate (about 1 hour).

### CD insertion not possible.

- A CD is already in the CD player.
  - Eject the CD and remove it.
- The CD is being improperly inserted.
  - Make sure the CD is being inserted following instructions in the CD Player Operation section.

### Unable to fast forward or backward the CD.

- The CD has been damaged.
  - Eject the CD and discard it; using a damaged CD in your unit can cause damage to the mechanism.

### CD playback sound skips due to vibration.

- Improper mounting of the unit.
  - Securely re-mount the unit.
- The disc is very dirty.
  - Clean the disc.
- The disc has scratches.
  - Change the disc.
- The pick-up lens is dirty.
  - Do not use a commercial available lens cleaner disc. Consult your nearest ALPINE dealer.

### CD playback sound skips without vibration.

- The disc is dirty or scratched.
  - Clean the disc; damaged disc should be replaced.

### Error displays (built-in CD player only)

- Mechanical error
  - Press **▲**. After the error display disappears, insert the disc again. If the above-mentioned solution does not solve the problem, consult your nearest ALPINE dealer.

### CD-R/CD-RW playback not possible

- Close session (finalization) has not been performed.
  - Perform finalization and attempt playback again.

## MP3/WMA

### MP3 or WMA is not played back.

- Writing error occurred. The CD format is not compatible.
  - Make sure the CD has been written in a supported format. Refer to "About MP3/WMA" (page 13-14), then rewrite in the format supported by this device.

## Indication for CD Player

**High Temperature** (CDA-9855)

**HIGH-TEMP** (CDA-9853)

- Protective circuit is activated due to high temperature.
  - The indicator will disappear when the temperature returns to within operation range.

**No Disc** (CDA-9855)

**NO DISC** (CDA-9853)

- No CD is inserted.
  - Insert a CD.
- Although a disc is inserted, "NO DISC" is displayed and the unit does not start to play or eject the disc.
  - Remove the disc by following these steps:
    - 1) Press the **▲** button.  
The movable display will open.
    - 2) Press the **▲** button again for at least 2 seconds while the movable display is open.

**Error** (CDA-9855)

**ERROR** (CDA-9853)

- Mechanism error.
  - 1) Press the **▲** button and eject the CD.  
If not ejecting, consult your Alpine dealer.
  - 2) When the error display remains after ejecting, press the **▲** button again.  
If the error display still does not turn off after pressing the **▲** button for a few times, consult your Alpine dealer.
- When "ERROR" is displayed:  
*If the disc cannot be ejected by pressing **▲**, press the RESET switch (refer to page 7) and press **▲** again.*  
*If the disc still cannot be ejected, consult your Alpine dealer.*

**PROTECT**

- A copy-protected WMA file was played back.
  - You can only play back non-copy-protected files.

**UNSUPPORT**

- The disc is not written in a MP3/WMA supported format.
  - Use a disc written at the MP3/WMA supported format.

## Indication for CD Changer

**High Temperature** (CDA-9855)

**HIGH-TEMP** (CDA-9853)

- Protective circuit is activated due to high temperature.
  - The indicator will disappear when the temperature returns to within operation range.

**Error 01** (CDA-9855)

**ERROR - 01** (CDA-9853)

- Malfunction in the CD Changer.
  - Consult your Alpine dealer. Press the magazine eject button and pull out the magazine. Check the indication. Insert the magazine again. If the magazine cannot be pulled out, consult your Alpine dealer.
- Magazine ejection not possible.
  - Press the magazine eject button. If the magazine does not eject, consult your Alpine dealer.

**Error 02** (CDA-9855)

**ERROR - 02** (CDA-9853)

- A disc is left inside the CD Changer.
  - Press the eject button to activate the eject function. When the CD Changer finishes the eject function, insert an empty CD magazine into the CD Changer to receive the disc left inside the CD Changer.

**No Magazine** (CDA-9855)

**NO MAGAZIN** (CDA-9853)

- No magazine is loaded into the CD Changer.
  - Insert a magazine.

**No Disc** (CDA-9855)

**NO DISC** (CDA-9853)

- No indicated disc.
  - Choose another disc.

## Indication for SAT Receiver Mode

**ANTENNA**

- The XM or SIRIUS antenna is not connected to the XM or SIRIUS radio module.
  - Check whether the XM or SIRIUS antenna cable is attached securely to the XM or SIRIUS radio module.

**UPDATING** (XM mode)

**CALL 888-539-SIRIUS TO SUBSCRIBE** (SIRIUS mode)  
Scrolling display

- Radio is being updated with latest encryption code.
  - Wait until encryption code is being updated. Channels 0 and 1 should function normally.

**NO SIGNAL** (XM mode)

**ACQUIRING SIGNAL** (SIRIUS mode)  
Scrolling display

- XM or SIRIUS signal is too weak at the current location.
  - Wait until the car reaches a location with a stronger signal.

**LOADING** (XM mode)

**ACQUIRING SIGNAL** (SIRIUS mode)  
Scrolling display

- Radio is acquiring audio or program information.
  - Wait until the radio has received the information.

**OFF AIR** (XM mode)

**ACQUIRING SIGNAL** (SIRIUS mode)  
Scrolling display

- The channel currently selected has stopped broadcasting.
  - Select another channel.

**-----**

- The user has selected a channel number that does not exist or is not subscribed to.
  - The unit will revert back to the previously selected channel.
- There is no artist name/feature, song/program title, or additional information associated with the channel at that time.
  - No action needed.

## Indication for iPod Mode

### NO IPOD

- The iPod is not connected.
  - Make sure the iPod is correctly connected.  
Make sure the cable is not bent excessively.
- The iPod's battery remains low.
  - Refer to the iPod's documentation and charge the battery.

### NO FILE

- There are no songs in the iPod.
  - Download songs to the iPod and connect to the CDA-9855/  
CDA-9853.

### Error 01 (CDA-9855)

### ERROR-01 (CDA-9853)

- Communication error
  - Turn the ignition key off, and then set to ACC or ON again.
  - Check the display by reconnecting between the iPod and the adapter, using the iPod cable.

### Error 02 (CDA-9855)

### ERROR-02 (CDA-9853)

- Caused by the iPod Software Version not being compatible with the adapter KCA-420i (sold separately).
  - Refer to the Owner's Manual of the adapter KCA-420i (sold separately) and update the iPod Software Version to be compatible with the adapter KCA-420i (sold separately).

## Specifications

### FM TUNER SECTION

|                               |                                |
|-------------------------------|--------------------------------|
| Tuning Range                  |                                |
| Area 1                        | 87.7-107.9 MHz                 |
| Area 2                        | 87.5-108.0 MHz                 |
| Mono Usable Sensitivity       | 9.3 dBf (0.8 $\mu$ V/75 ohms)  |
| 50 dB Quieting Sensitivity    | 13.5 dBf (1.3 $\mu$ V/75 ohms) |
| Alternate Channel Selectivity | 80 dB                          |
| Signal-to-Noise Ratio         | 80 dB                          |
| Stereo Separation             | 45 dB                          |
| Capture Ratio                 | 2.0 dB                         |

### AM TUNER SECTION

|                            |                    |
|----------------------------|--------------------|
| Tuning Range               |                    |
| Area 1                     | 530-1,710 kHz      |
| Area 2                     | 531-1,602 kHz      |
| Sensitivity (IEC Standard) | 22.5 $\mu$ V/27 dB |

### CD PLAYER SECTION

|                           |                             |
|---------------------------|-----------------------------|
| Frequency Response        | 5 – 20,000 Hz ( $\pm$ 1 dB) |
| Wow & Flutter (% WRMS)    | Below measurable limits     |
| Total Harmonic Distortion | 0.008% (at 1 kHz)           |
| Dynamic Range             | 95 dB (at 1 kHz)            |
| Signal-to-Noise Ratio     | 105 dB                      |
| Channel Separation        | 85 dB (at 1 kHz)            |

### PICKUP

|             |         |
|-------------|---------|
| Wave length | 795 mm  |
| Laser power | CLASS I |

### REMOTE CONTROL

|              |                        |
|--------------|------------------------|
| Battery Type | AAA batteries (2 pcs.) |
| Width        | 42 mm (1-21/32")       |
| Height       | 121 mm (4-25/32")      |
| Depth        | 23 mm (29/32")         |
| Weight       | 50 g (1.8 oz)          |

### GENERAL

|  |  |
|--|--|
| Power Requirement                                      | 14.4 V DC<br>(11–16 V allowable)                     |
| Power Output   | 18 W RMS $\times$ 4*                                 |
| * Primary amplifier ratings per CEA-2006 Standard      |  |
| • Power output: measured at 4 Ohms and $\leq$ 1% THD+N |  |
| • S/N: 80 dBA (reference: 1 W into 4 Ohms)             |  |
| Maximum Pre-Output Voltage                             | 4 V/10 k ohms (CDA-9855)<br>2 V/10 k ohms (CDA-9853) |
| Weight   | 1.6 kg (3 lbs. 8 oz)                                 |

### CHASSIS SIZE

|        |             |
|--------|-------------|
| Width  | 178 mm (7") |
| Height | 50 mm (2")  |
| Depth  | 160 mm (6") |

### NOSEPIECE SIZE

|        |                   |
|--------|-------------------|
| Width  | 170 mm (6-11/16") |
| Height | 46 mm (1-13/16")  |
| Depth  | 19 mm (11/16")    |

- Due to continuous product improvement, specifications and design are subject to change without notice.

# Installation and Connections

Before installing or connecting the unit, please read the following and pages 3 to 5 of this manual thoroughly for proper use.

## Warning

### **MAKE THE CORRECT CONNECTIONS.**

Failure to make the proper connections may result in fire or product damage.

### **USE ONLY IN CARS WITH A 12 VOLT NEGATIVE GROUND.**

(Check with your dealer if you are not sure.) Failure to do so may result in fire, etc.

### **BEFORE WIRING, DISCONNECT THE CABLE FROM THE NEGATIVE BATTERY TERMINAL.**

Failure to do so may result in electric shock or injury due to electrical shorts.

### **DO NOT ALLOW CABLES TO BECOME ENTANGLED IN SURROUNDING OBJECTS.**

Arrange wiring and cables in compliance with the manual to prevent obstructions when driving. Cables or wiring that obstruct or hang up on places such as the steering wheel, gear lever, brake pedals, etc. can be extremely hazardous.

### **DO NOT SPLICE INTO ELECTRICAL CABLES.**

Never cut away cable insulation to supply power to other equipment. Doing so will exceed the current carrying capacity of the wire and result in fire or electric shock.

### **DO NOT DAMAGE PIPE OR WIRING WHEN DRILLING HOLES.**

When drilling holes in the chassis for installation, take precautions so as not to contact, damage or obstruct pipes, fuel lines, tanks or electrical wiring. Failure to take such precautions may result in fire.

### **DO NOT USE BOLTS OR NUTS IN THE BRAKE OR STEERING SYSTEMS TO MAKE GROUND CONNECTIONS.**

Bolts or nuts used for the brake or steering systems (or any other safety-related system), or tanks should NEVER be used for installations or ground connections. Using such parts could disable control of the vehicle and cause fire etc.

### **KEEP SMALL OBJECTS SUCH AS BATTERIES OUT OF THE REACH OF CHILDREN.**

Swallowing them may result in serious injury. If swallowed, consult a physician immediately.

### **DO NOT INSTALL IN LOCATIONS WHICH MIGHT HINDER VEHICLE OPERATION, SUCH AS THE STEERING WHEEL OR GEARSHIFT.**

Doing so may obstruct forward vision or hamper movement etc. and results in serious accident.

## Caution

### **HAVE THE WIRING AND INSTALLATION DONE BY EXPERTS.**

The wiring and installation of this unit requires special technical skill and experience. To ensure safety, always contact the dealer where you purchased this product to have the work done.

### **USE SPECIFIED ACCESSORY PARTS AND INSTALL THEM SECURELY.**

Be sure to use only the specified accessory parts. Use of other than designated parts may damage this unit internally or may not securely install the unit in place. This may cause parts to become loose resulting in hazards or product failure.

### **ARRANGE THE WIRING SO IT IS NOT CRIMPED OR PINCHED BY A SHARP METAL EDGE.**

Route the cables and wiring away from moving parts (like the seat rails) or sharp or pointed edges. This will prevent crimping and damage to the wiring. If wiring passes through a hole in metal, use a rubber grommet to prevent the wire's insulation from being cut by the metal edge of the hole.

### **DO NOT INSTALL IN LOCATIONS WITH HIGH MOISTURE OR DUST.**

Avoid installing the unit in locations with high incidence of moisture or dust. Moisture or dust that penetrates into this unit may result in product failure.

## Precautions

- Be sure to disconnect the cable from the (-) battery post before installing your CDA-9855/CDA-9853. This will reduce any chance of damage to the unit in case of a short-circuit.
- Be sure to connect the color coded leads according to the diagram. Incorrect connections may cause the unit to malfunction or damage to the vehicle's electrical system.
- When making connections to the vehicle's electrical system, be aware of the factory installed components (e.g. on-board computer). Do not tap into these leads to provide power for this unit. When connecting the CDA-9855/CDA-9853 to the fuse box, make sure the fuse for the intended circuit of the CDA-9855/CDA-9853 has the appropriate amperage. Failure to do so may result in damage to the unit and/or the vehicle. When in doubt, consult your ALPINE dealer.
- The CDA-9855/CDA-9853 uses female RCA-type jacks for connection to other units (e.g. amplifier) having RCA connectors. You may need an adaptor to connect other units. If so, please contact your authorized ALPINE dealer for assistance.
- Be sure to connect the speaker (-) leads to the speaker (-) terminal. Never connect left and right channel speaker cables to each other or to the vehicle body.

## IMPORTANT

Please record the serial number of your unit in the space provided below and keep it as a permanent record. The serial number plate is located on the bottom of the unit.

SERIAL NUMBER: \_\_\_\_\_  
INSTALLATION DATE: \_\_\_\_\_  
INSTALLATION TECHNICIAN: \_\_\_\_\_  
PLACE OF PURCHASE: \_\_\_\_\_

# Installation

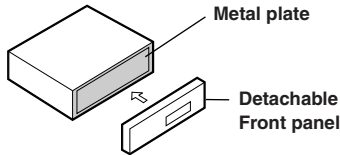

**Caution**

When you install this unit in your car, do not remove the detachable front panel. If the detachable front panel is removed during installation, you might press too hard and warp the metal plate that holds it in place.

**Caution**

Do not block the unit's fan or heat sink, thus preventing air circulation. If blocked, heat will accumulate inside the unit and may cause a fire.

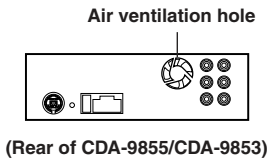

1

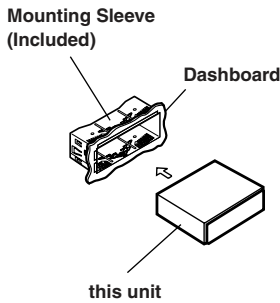

Slide the mounting sleeve into the dashboard.

2

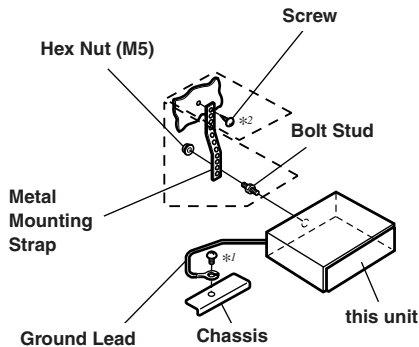

Reinforce the head unit with the metal mounting strap (not supplied). Secure the ground lead of the unit to a clean metal spot using a screw (\*) already attached to the vehicle's chassis.

- For the screw marked “\*2”, use an appropriate screw for the chosen mounting location.

Connect each input lead coming from an amplifier or equalizer to the corresponding output lead coming from the left rear of the CDA-9855/CDA-9853. Connect all other leads of the CDA-9855/CDA-9853 according to details described in the CONNECTIONS section.

- 3 Slide the CDA-9855/CDA-9853 into the dashboard until it clicks. This ensures that the unit is properly locked and will not accidentally come out from the dashboard. Install the detachable front panel.

**Removal**

- 1 Remove the detachable front panel.
- 2 Insert the bracket keys into the slot and through the guides on either side of the unit. The unit can now be removed from the mounting sleeve.

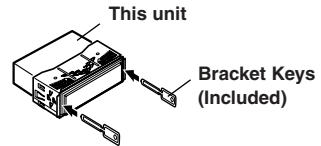

- 3 Pull the unit out, keeping it unlocked as you do so.

<JAPANESE CAR>

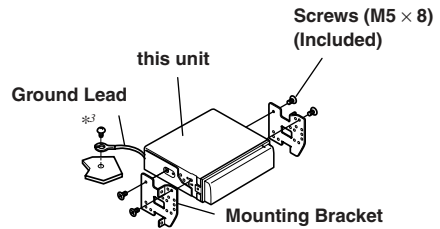
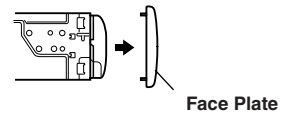

- Secure the ground lead of the unit to a clean metal spot using a screw (\*) already attached to the vehicle's chassis.

# Connections

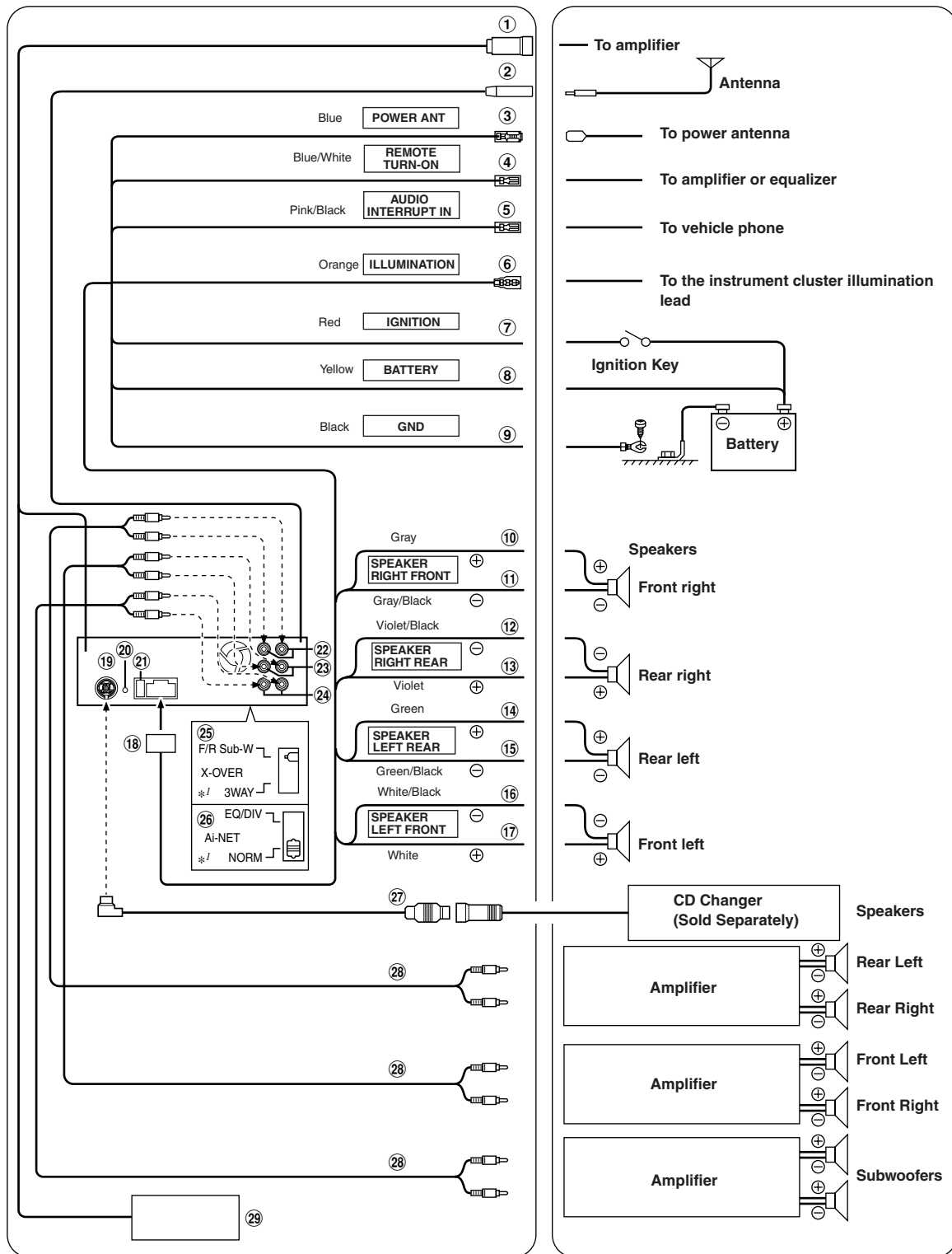

\* / The label is attached on the bottom of the unit.

- ① **Amplifier Link Connector**  
Outputs Amplifier Link control signals.  
Connect this to an external Amplifier Link compatible amplifier, using the (also separately sold) Amplifier Link box KCE-511M.
- ② **Antenna Receptacle**
- ③ **Power Antenna Lead (Blue)**  
Connect this lead to the +B terminal of your power antenna, if applicable.  
  
*This lead should be used only for controlling the vehicle's power antenna. Do not use this lead to turn on an amplifier, or a signal processor, etc.*
- ④ **Remote Turn-On Lead (Blue/White)**  
Connect this lead to the remote turn-on lead of your amplifier or signal processor.
- ⑤ **Audio Interrupt In Lead (Pink/Black)**
- ⑥ **Illumination Lead (Orange)**  
This lead may be connected to the vehicle's instrument cluster illumination lead. This will allow the backlighting of the unit to dim whenever the vehicle's lights are turned on.
- ⑦ **Switched Power Lead (Ignition) (Red)**  
Connect this lead to an open terminal on the vehicle's fuse box or another unused power source which provides (+)12V only when the ignition is turned on or in the accessory position.
- ⑧ **Battery Lead (Yellow)**  
Connect this lead to the positive (+) post of the vehicle's battery.
- ⑨ **Ground Lead (Black)**  
Connect this lead to a good chassis ground on the vehicle. Make sure the connection is made to bare metal and is securely fastened using the sheet metal screw provided.
- ⑩ **Right Front (+) Speaker Output Lead (Gray)**
- ⑪ **Right Front (-) Speaker Output Lead (Gray/Black)**
- ⑫ **Right Rear (-) Speaker Output Lead (Violet/Black)**
- ⑬ **Right Rear (+) Speaker Output Lead (Violet)**
- ⑭ **Left Rear (+) Speaker Output Lead (Green)**
- ⑮ **Left Rear (-) Speaker Output Lead (Green/Black)**
- ⑯ **Left Front (-) Speaker Output Lead (White/Black)**
- ⑰ **Left Front (+) Speaker Output Lead (White)**
- ⑱ **Power Supply Connector**
- ⑲ **Ai-NET Connector**  
Connect this to the output or input connector of another device (CD Changer, Equalizer, INTERFACE ADAPTER FOR iPod™\* etc.) equipped with Ai-NET.
- \* *When connecting iPod, INTERFACE ADAPTER FOR iPod™ (KCA-420i) is required. For details on how to connect, refer to the Owner's Manual of KCA-420i.*  
  
*You can input TV/video sound by connecting an optional Ai-NET/RCA Interface cable (KCA-121B) to this component.*
- ⑳ **Steering Remote Control Interface Connector**  
To steering remote control interface box.
- ㉑ **Fuse Holder (10A)**
- ㉒ **Rear Output RCA Connectors**  
RED is right and WHITE is left.
- ㉓ **Front Output RCA Connectors**  
RED is right and WHITE is left.
- ㉔ **Subwoofer RCA Connectors**  
RED is right and WHITE is left.
- ㉕ **Setting the 3WAY/2 WAY switch**  
Set the 3way/2way switch according to your audio system.
- ㉖ **System Switch**  
When connecting a processor or divider using Ai-NET, place this switch in the EQ/DIV position. When no device is connected, leave the switch in the NORM position.  
  
*Be sure to turn the power off to the unit before changing the switch position.*
- ㉗ **Ai-NET Cable (Included with CD Changer)**
- ㉘ **RCA Extension Cable (sold separately)**
- ㉙ **DC/DC Converter (CDA-9855 only)**
  - *Do not install the converter at a location subjected to water such as under the floor mat or air conditioner. This may cause a malfunction.*
  - *Do not bundle the DC/DC converter cable with other audio cables. Doing so may induce noise into your system.*
  - *Keep the DC/DC converter away from the Antenna cables and the rear side of the unit, otherwise noise may be generated when receiving radio broadcast.*

The X-Over Switch position for a two-way system (frequency range is divided between highs for front/rear and lows for the Subwoofer).

**The position of the X-Over switch : F/R/Sub-W**

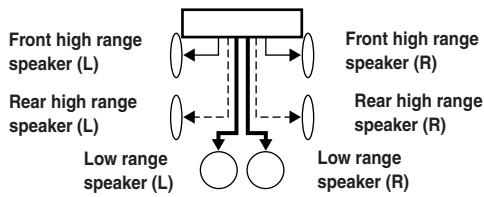

Output of this unit :

————— Front output

----- Rear output

————— SUB-W output

- Use the SUB-W output cord to connect the unit to the low range speaker.
- You can use the built-in amplifier to output the front output/rear output.
- You cannot adjust the fader when set to 3WAY.

The X-Over Switch position for a three-way system whose frequency range is divided among the highs (Front), mids (Rear), and lows (Subwoofer).

**The position of the X-Over switch: 3WAY**

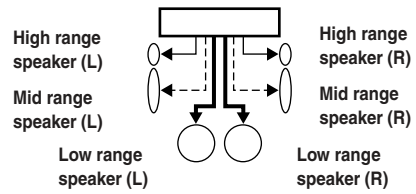

**To prevent noise/interference in the audio system.**

- Locate the unit and route the leads at least 10 cm away from the car harness.
- Keep the battery power leads as far away from other leads as possible.
- Connect the ground lead securely to a bare metal spot (remove any paint, dirt or grease if necessary) of the car chassis.
- If you add an optional noise suppressor, connect it as far away from the unit as possible. Your Alpine dealer carries various noise suppressors, contact them for further information.
- Your Alpine dealer knows best about noise prevention measures so consult your dealer for further information.



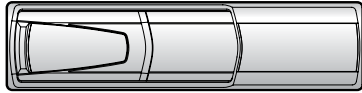

#### **CHA-S634**

- CD changer for CDA-9855/CDA-9853.
- Changeur CD pour CDA-9855/CDA-9853.
- Cambiador de CD para CDA-9855/CDA-9853.

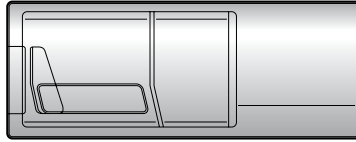

#### **CHA-1214**

- CD changer for CDA-9855/CDA-9853.
- Changeur CD pour CDA-9855/CDA-9853.
- Cambiador de CD para CDA-9855/CDA-9853.

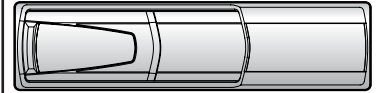

#### **CHM-S630**

## **Alpine CD Changers Give You More!**

### ***More musical selections, more versatility, more convenience.***

The CHA-S634 is a high-performance 6-disc changer with a new M DAC, CD-R/RW PLAY BACK, MP3 PLAY BACK and CD TEXT. The CHA-1214 Ai-NET model holds 12 discs, and the CHM-S630 M-Bus model is a super-compact 6-disc changer with a CD-R/RW PLAY BACK.

## **Changeurs de CD Alpine : vous avez le choix!**

### ***Plus de sélections musicales, plus de souplesse, plus de confort.***

Le modèle CHA-S634 est un changeur 6 disques ultra performant équipé des nouvelles fonctions M DAC, CD-R/RW PLAY BACK, MP3 PLAY BACK et CD TEXT. Le modèle CHA-1214 Ai-NET contient 12 disques. Le modèle CHM-S630 M-Bus est un changeur 6 disques super compact doté de la fonction CD-R/RW PLAY BACK.

## **¡Los cambiadores Alpine de CD le ofrecen más!**

### ***Más selecciones musicales, más versatilidad y más ventajas.***

CHA-S634 es un cambiador de seis discos de alto rendimiento con nuevo M DAC, CD-R/RW PLAY BACK, MP3 PLAY BACK y CD TEXT. El modelo CHA-1214 Ai-NET alberga 12 discos y el modelo CHM-S630 M-Bus es un cambiador de seis discos de tamaño reducido con un CD-R/RW PLAY BACK.



## LIMITED WARRANTY

ALPINE ELECTRONICS OF AMERICA, INC. AND ALPINE OF CANADA INC. ("Alpine"), are dedicated to quality craftsmanship and are pleased to offer this Warranty. We suggest that you read it thoroughly. Should you have any questions, please contact your Dealer or contact Alpine at one of the telephone numbers listed below.

### ● PRODUCTS COVERED:

This Warranty covers Car Audio Products and Related Accessories ("the product"). Products purchased in the Canada are covered only in the Canada. Products purchased in the U.S.A. are covered only in the U.S.A.

### ● LENGTH OF WARRANTY:

This Warranty is in effect for one year from the date of the first consumer purchase.

### ● WHO IS COVERED:

This Warranty only covers the original purchaser of the product, who must reside in the United States, Puerto Rico or Canada.

### ● WHAT IS COVERED:

This Warranty covers defects in materials or workmanship (parts and labor) in the product.

### ● WHAT IS NOT COVERED:

This Warranty does not cover the following:

- ① Damage occurring during shipment of the product to Alpine for repair (claims must be presented to the carrier).
- ② Damage caused by accident or abuse, including burned voice coils caused by over-driving the speaker (amplifier level is turned up and driven into distortion or clipping). Speaker mechanical failure (e.g. punctures, tears or rips). Cracked or damaged LCD panels. Dropped or damaged hard drives.
- ③ Damage caused by negligence, misuse, improper operation or failure to follow instructions contained in the Owner's manual.
- ④ Damage caused by act of God, including without limitation, earthquake, fire, flood, storms or other acts of nature.  
Any cost or expense related to the removal or reinstallation of the product.
- ⑤ Service performed by an unauthorized person, company or association.
- ⑥ Any product which has the serial number defaced, altered or removed.
- ⑦ Any product which has been adjusted, altered or modified without Alpine's consent.
- ⑧ Any product not distributed by Alpine within the United States, Puerto Rico or Canada.
- ⑨ Any product not purchased from an Authorized Alpine Dealer.

### ● HOW TO OBTAIN WARRANTY SERVICE:

- ① You are responsible for delivery of the product to an Authorized Alpine Service Center or Alpine for repair and for payment of any initial shipping charges. Alpine will, at its option, repair or replace the product with a new or reconditioned product without charge. If the repairs are covered by the warranty, and if the product was shipped to an Authorized Alpine Service Center or Alpine, Alpine will pay the return shipping charges.
- ② You should provide a detailed description of the problem(s) for which service is required.

- ③ You must supply proof of your purchase of the product.
- ④ You must package the product securely to avoid damage during shipment. To prevent lost packages it is recommended to use a carrier that provides a tracking service.

### ● HOW WE LIMIT IMPLIED WARRANTIES:

ANY IMPLIED WARRANTIES INCLUDING FITNESS FOR USE AND MERCHANTABILITY ARE LIMITED IN DURATION TO THE PERIOD OF THE EXPRESS WARRANTY SET FORTH ABOVE AND NO PERSON IS AUTHORIZED TO ASSUME FOR ALPINE ANY OTHER LIABILITY IN CONNECTION WITH THE SALE OF THE PRODUCT.

### ● HOW WE EXCLUDE CERTAIN DAMAGES:

ALPINE EXPRESSLY DISCLAIMS LIABILITY FOR INCIDENTAL AND CONSEQUENTIAL DAMAGES CAUSED BY THE PRODUCT. THE TERM "INCIDENTAL DAMAGES" REFERS TO EXPENSES OF TRANSPORTING THE PRODUCT TO THE ALPINE SERVICE CENTER, LOSS OF THE ORIGINAL PURCHASER'S TIME, LOSS OF THE USE OF THE PRODUCT, BUS FARES, CAR RENTALS OR OTHER COSTS RELATING TO THE CARE AND CUSTODY OF THE PRODUCT. THE TERM "CONSEQUENTIAL DAMAGES" REFERS TO THE COST OF REPAIRING OR REPLACING OTHER PROPERTY WHICH IS DAMAGED WHEN THIS PRODUCT DOES NOT WORK PROPERLY. THE REMEDIES PROVIDED UNDER THIS WARRANTY ARE EXCLUSIVE AND IN LIEU OF ALL OTHERS.

### ● HOW STATE/PROVINCIAL LAW RELATES TO THE WARRANTY:

This Warranty gives you specific legal rights, and you may also have other rights which vary from state to state and province to province. In addition, some states/provinces do not allow limitations on how long an implied warranty lasts, and some do not allow the exclusion or limitation of incidental or consequential damages. Accordingly, limitations as to these matters contained herein may not apply to you.

### ● IN CANADA ONLY:

This Warranty is not valid unless your Alpine car audio product has been installed in your vehicle by an Authorized Installation Center, and this warranty stamped upon installation by the installation center.

### ● HOW TO CONTACT CUSTOMER SERVICE:

Should the product require service, please call the following number for your nearest Authorized Alpine Service Center.

**CAR AUDIO 1-800-ALPINE-1 (1-800-257-4631)  
NAVIGATION 1-888-NAV-HELP (1-888-628-4357)**

Or visit our website at; <http://www.alpine-usa.com>

**ALPINE ELECTRONICS OF AMERICA, INC.**, 19145 Gramercy Place, Torrance, California 90501, U.S.A.

**ALPINE ELECTRONICS OF CANADA, INC.**, 777 Supertest Road, Toronto, Ontario M3J 2M9, Canada

Do not send products to these addresses.

Call the toll free telephone number or visit the website to locate a service center.

The Owner's Manual has errors as shown here.

Le mode d'emploi contient les erreurs indiquées ici.

El manual de operación contiene los errores mostrados aquí.

## English

### • Page 31, Checking the SAT Radio ID Number, steps 1 and 2

<Incorrect>

- 1 While receiving band, press **◀◀** or **▶▶** to select channel "0."  
The unit alternately displays "RADIO ID" for 2 seconds, then the ID number for 10 seconds.

- 2 To cancel the ID number display, set the channel to other than "0."

### • Page 32, Channel/Category Search Function, step 1

<Incorrect>

- 1 Press and hold **□** in XM or SIRIUS mode to select Channel Search mode or Category Search mode.

## Français

### • Page 31, Vérification du numéro d'identification de radio SAT, étapes 1 et 2

<Incorrect>

- 1 En mode de réception de la bande, appuyez sur **◀◀** ou **▶▶** pour sélectionner le canal « 0 ».  
L'appareil affiche en alternance « RADIO ID » pendant 2 secondes, puis le numéro d'identification pendant 10 secondes.

- 2 Pour désactiver l'affichage du numéro d'identification, réglez l'appareil sur un autre canal que « 0 ».

### • Page 32, Fonction de recherche par canal/catégorie, étape 1

<Incorrect>

- 1 Appuyez sur **□** en mode XM ou SIRIUS pour sélectionner le mode de recherche par canal ou le mode de recherche par catégorie.

## Español

### • Página 31, Comprobación del número ID de radio SAT, pasos 1 y 2

<Incorrecto>

- 1 Mientras recibe la banda, pulse **◀◀** o **▶▶** para seleccionar el canal "0".  
La unidad muestra alternativamente "RADIO ID" durante 2 segundos y el número de ID durante 10 segundos.

- 2 Para cancelar la presentación del número de ID, ajuste el canal en un número que no sea "0".

### • Página 32, Función de búsqueda por categoría o canal, paso 1

<Incorrecto>

- 1 Pulse **□** en el modo XM o SIRIUS para seleccionar el modo de búsqueda por canal o el modo de búsqueda por categoría.

<Correct>

- 1 While receiving any SAT band, press **◀◀** or **▶▶** to select channel "0" for XM or "255" for SIRIUS Radio.  
For XM, the unit alternately displays "RADIO ID" for 2 seconds, then the ID number for 10 seconds. For SIRIUS Radio, press TITLE twice to display the ID number.

- 2 To cancel the ID number display, set the channel to other than "0" in the XM mode, and in the SIRIUS mode, set the channel to other than "255."

<Correct>

- 1 Press **□** in XM or SIRIUS mode to select Channel Search mode or Category Search mode.

<Correct>

- 1 En mode de réception de la bande SAT, appuyez sur **◀◀** ou **▶▶** pour sélectionner le canal « 0 » sous XM ou « 255 » sous radio SIRIUS.  
Sous XM, l'appareil affiche en alternance « RADIO ID » pendant 2 secondes, puis le numéro d'identification pendant 10 secondes. Pour afficher le numéro d'identification de la radio SIRIUS, appuyez deux fois sur TITLE.

- 2 Pour désactiver l'affichage du numéro d'identification, réglez l'appareil sur un canal autre que « 0 » en mode XM; en mode SIRIUS, réglez sur un canal autre que « 255 ».

<Correct>

- 1 Appuyez sur **□** en mode XM ou SIRIUS pour sélectionner le mode de recherche par canal ou le mode de recherche par catégorie.

<Correcto>

- 1 Mientras recibe cualquier banda SAT, pulse **◀◀** o **▶▶** para seleccionar el canal "0" para XM o el "255" para radio SIRIUS.  
Para XM, la unidad muestra alternativamente "RADIO ID" durante 2 segundos y el número de ID durante 10 segundos. Para radio SIRIUS, pulse TITLE dos veces para mostrar el número de ID.

- 2 Para cancelar la presentación del número de ID, ajuste el canal en un número que no sea "0" en el modo XM, y en el modo SIRIUS, ajuste el canal en número que no sea "255".

<Correcto>

- 1 Pulse **□** en el modo XM o SIRIUS para seleccionar el modo de búsqueda por canal o el modo de búsqueda por categoría.

## English

Please note following corrections of the Owner's Manual.

- Page 22, Displaying the Title/Text

The display in Radio mode :

CDA-9853

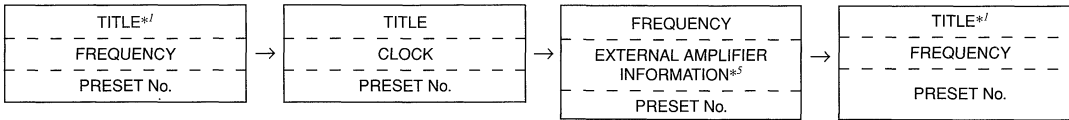

- Page 24, Titling Discs/Stations, Note

You can enter 18 radio station titles (24 for the CDA-9853 model) and 18 CD titles on this unit. If you try to store beyond the limit, the display will show "TITLE FULL DATA" ("FULL DATA"). At this point, no more titles can be stored. To input a new title, one of the previously inputted titles must first be deleted.

- Pages 27 and 28, SETUP, step 4

CDA-9855:

### AUDIO

SUBWOOFER ↔ SUBW SYSTEM\*5 ↔ EQ MODE\*6 ↔ TW SETUP\*7 ↔ A.PROC TYPE ↔ SUBWOOFER

CDA-9853:

### AUDIO

SUBWOOFER ↔ SUBW SYSTEM\*5 ↔ EQ MODE\*6 ↔ TW SETUP\*7 ↔ AP SELECT

- Page 29, Setting the Subwoofer Output

Though "Setting the Subwoofer Output" is described in the SETUP section, the unit is not equipped with this setting.

- Page 30, Scroll Setting

Even when the scroll setting is set to MANUAL with the CDA-9855 while displaying ARTIST NAME/ALBUM NAME, the text information scrolls continuously.

- Page 30, Setting the Temperature Display for the External Amplifier

CDA-9855: A-LINK TEMP °F (Initial setting) / A-LINK TEMP °C

- Page 31, Receiving Channels with the SAT Radio Receiver (Optional), steps 1 and 2

- 1 Press SOURCE/POWER to select SAT Radio mode.
- 2 Press BAND to select between one of the three SAT Radio Preset Bands.

- Page 32, Changing the Display

CDA-9855

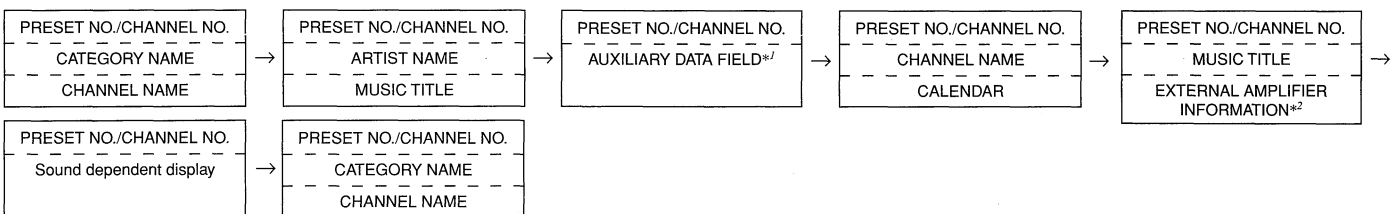

- Page 35, Quick Search

Though "Quick Search" is described in the iPod™ Operation section, this function cannot be used on the unit.

- Page 37, Multi-Changer Selection (Optional), Note

If the selected CD Changer is not connected, the display will show "NO CHANGER" ("NO CHGR").

## Français

Veillez noter les corrections suivants au mode d'emploi.

- Page 22, Affichage du titre/texte

L'affichage en mode Radio :

CDA-9853

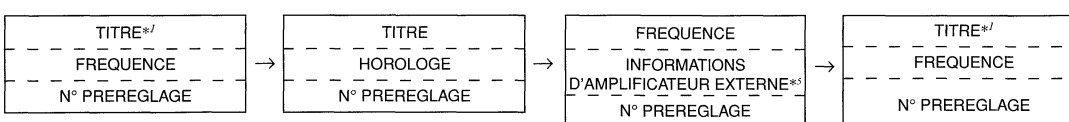

- Page 24, Titrage des disques/stations, Remarque

Vous pouvez saisir 18 noms de station radio (24 sur le modèle CDA-9853) et 18 titres de CD sur cet appareil. Si vous essayez de mémoriser d'autres titres au-delà de cette limite, l'affichage indique « TITLE FULL DATA » (« FULL DATA ») et aucun autre titre ne peut être enregistré. Pour mémoriser un nouveau titre, vous devez d'abord supprimer un des titres existants.

- Pages 27 et 28, SETUP, étape 4

CDA-9855:

### AUDIO

SUBWOOFER ↔ SUBW SYSTEM\*5 ↔ EQ MODE\*6 ↔ TW SETUP\*7 ↔ A.PROC TYPE ↔ SUBWOOFER

CDA-9853:

### AUDIO

SUBWOOFER ↔ SUBW SYSTEM\*5 ↔ EQ MODE\*6 ↔ TW SETUP\*7 ↔ AP SELECT

- Page 29, Réglage de la sortie du subwoofer

Bien que le « Réglage de la sortie du subwoofer » soit décrit à la section REGLAGE, cet appareil n'est pas équipé de cette fonction.

• **Page 30, Réglage du défilement**

Même si le défilement est réglé sur MANUAL au niveau du CDA-9855 en mode d'affichage du NOM DE L'ARTISTE/NOM DE L'ALBUM, les informations textuelles défilent en continu.

• **Page 30, Réglage de l'affichage de la température pour l'amplificateur externe**  
**CDA-9855: A-LINK TEMP °F (Réglage initial) / A-LINK TEMP °C**

• **Page 31, Réception des canaux avec le récepteur de radio SAT (en option), étapes 1 et 2**

- 1 Appuyez sur **SOURCE/POWER** pour sélectionner le mode radio par satellite.
- 2 Appuyez sur la touche **BAND** pour sélectionner une des trois gammes prédéfinies de radios par satellite.

• **Page 32, Modification de l'affichage**

**CDA-9855**

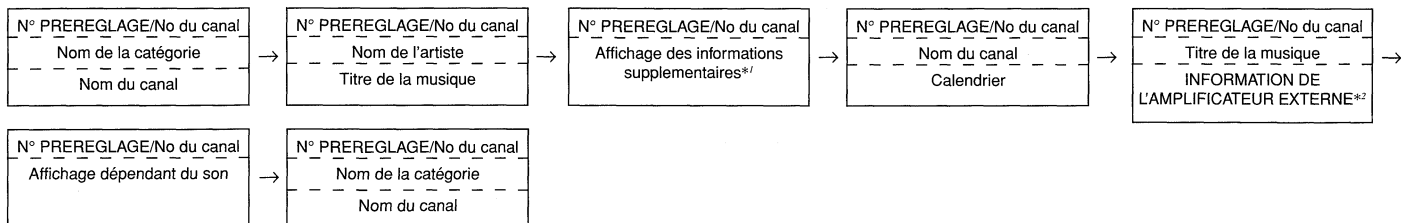

• **Page 35, Recherche rapide**

Même si la fonction « Recherche rapide » est décrite dans la section Utilisation de l'iPod™, elle ne peut pas être utilisée avec cette unité.

• **Page 37, Sélection du multi-changeur (en option), Remarque**

• Si le changeur CD sélectionné n'est pas raccordé, l'affichage indique « NO CHANGER » (« NO CHGR »).

**Español**

Observe las correcciones siguientes del manual de operación.

• **Página 22, Visualización del título/texto**

**Visualizador en modo Radio :**

**CDA-9853**

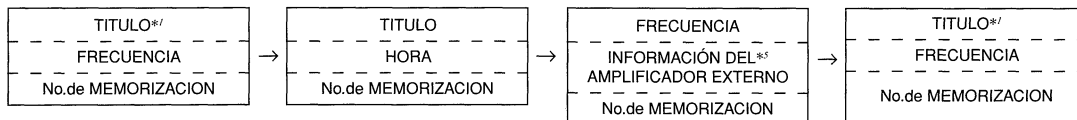

• **Página 24, Asignación de nombre a discos/emisoras, Nota**

• Puede introducir 18 títulos de emisoras de radio (24 en el caso del modelo CDA-9853) y 18 títulos de CD en esta unidad. Si intenta sobrepasar este límite el visualizador mostrara "TITLE FULL DATA" ("FULL DATA"). A partir de ese mensaje no podrá memorizar más título. Para introducir un nuevo título deberá borrar previamente uno de los ya introducidos.

• **Páginas 27 y 28, SETUP (CONFIGURACIÓN), paso 4**

**CDA-9855:**

**AUDIO**

SUBWOOFER ↔ SUBW SYSTEM\*5 ↔ EQ MODE\*6 ↔ TW SETUP\*7 ↔ A.PROC TYPE ↔ SUBWOOFER

**CDA-9853:**

**AUDIO**

SUBWOOFER ↔ SUBW SYSTEM\*5 ↔ EQ MODE\*6 ↔ TW SETUP\*7 ↔ AP SELECT

• **Página 29, Ajuste de la salida del subwoofer**

Aunque el "Ajuste de la salida del subwoofer" se describe en la sección INSTALACIÓN, la unidad no está equipada con este ajuste.

• **Página 30, Ajuste de desplazamiento**

Incluso si el ajuste de desplazamiento está establecido en MANUAL cuando el CDA-9855 muestra NOMBRE DE ARTISTA/NOMBRE DE ÁLBUM, la información del texto se desplaza continuamente.

• **Página 30, Configuración de la visualización de temperatura del amplificador externo**

**CDA-9855: A-LINK TEMP °F (Ajuste inicial) / A-LINK TEMP °C**

• **Página 31, Recepción de los canales con el receptor de radio SAT (Opcional), pasos 1 y 2**

- 1 Pulse **SOURCE/POWER** para seleccionar el modo radio SAT.
- 2 Presione **BAND** para seleccionar una de las tres bandas de radio por satélite memorizadas.

• **Página 32, Cambio de la indicación**

**CDA-9855**

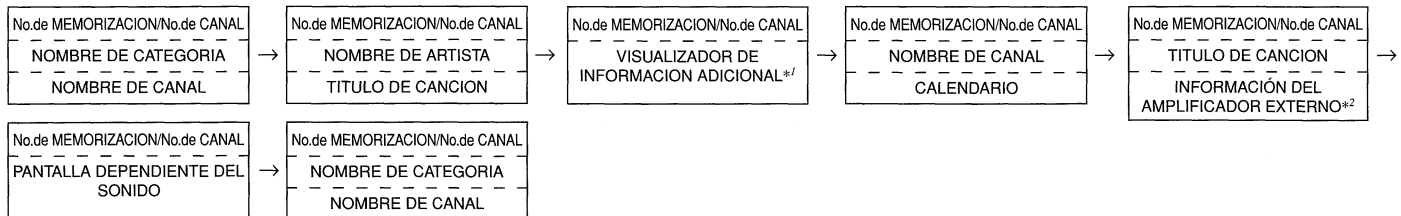

• **Página 35, Búsqueda rápida**

Aunque la función "Búsqueda rápida" se describe en la sección Funcionamiento con iPod™, dicha función no se puede utilizar en la unidad.

• **Página 37, Selección de cambiador múltiple (Opcional), Nota**

• Si el cambiador de discos compactos seleccionado no está conectado, el visualizador mostrará "NO CHANGER" ("NO CHGR").

# ALPINE Customer Care Registration



For easy on-line registration, go to "www.alpine-usa.com/registration"

Thank you for choosing Alpine! Please register your product with us so we can serve you better.

First name: \_\_\_\_\_

Last name: \_\_\_\_\_

Home address: \_\_\_\_\_  
Street address

City \_\_\_\_\_ State/Prov. \_\_\_\_\_ Zip Code \_\_\_\_\_

May we contact you at this address? 1.  Yes 2.  No

Phone number: ( ) \_\_\_\_\_

May we contact you at this number? 1.  Yes 2.  No

E-mail Address: \_\_\_\_\_

May we contact you by e-mail? 1.  Yes 2.  No

Gender 1.  Male 2.  Female

Date of Birth Month: \_\_\_\_\_ Year: \_\_\_\_\_

Marital Status 1.  Single 2.  Married

Which ethnicity best describes yourself:

1.  Caucasian 4.  Asian  
2.  Hispanic 5.  Other \_\_\_\_\_  
3.  African-American

Your highest level of education completed:

1.  High School Student  
2.  High School Graduate  
3.  2 Yr. Degree/Some College  
4.  Completed 4 Yr. College  
5.  Completed Graduate School

Product purchased

1.  Cassette Player 9.  Monitor Controller  
2.  CD Player 10.  Video Monitor  
3.  MD Player 11.  Navigation  
4.  DVD Player 12.  Mobile Mayday  
5.  CD Changer 13.  Video Tape Player  
6.  Amplifier 14.  Processor/Equalizer  
7.  Speaker 15.  Security  
8.  Subwoofer 16.  Other \_\_\_\_\_

Model Number: \_\_\_\_\_

Date of Purchase:  
Month: \_\_\_\_\_ Year: \_\_\_\_\_

If navigation system, which monitor?

1.  Alpine → (Model No.) \_\_\_\_\_  
2.  Other → (Brand Name) \_\_\_\_\_

Purpose of buying this unit?

1.  Addition  
2.  Replacement → \*Previous brand replaced?  
1.  Factory installed  
2.  Alpine  
3.  Other \_\_\_\_\_

Have you purchased Alpine products before?

1.  First time 2.  Two or more times

When you purchased this Alpine unit, did you compare it with other brands?

1.  Yes 2.  No

↓  
(Brand Name) \_\_\_\_\_

Which of the following statements best describes you?

1.  I usually have more electronic equipment than my friends  
2.  I am usually one of the first of my friends to buy the newest electronic equipment  
3.  I usually wait until a product has been out for a while before I purchase it  
4.  I am usually on of the first of my friends to know about the newest car  
5.  I usually know more about cars than my friends

Occupation

1.  Executive/Managerial 6.  Engineering/Technical  
2.  Secretarial/Clerical 7.  Farming/Fishing  
3.  Sales 8.  Retired  
4.  General Labor 9.  Student  
5.  Professional 10.  Other \_\_\_\_\_

Household Income

1.  Less than \$30,000 4.  \$70,000 - \$90,000  
2.  \$30,000 - \$50,000 5.  \$90,000 - \$110,000  
3.  \$50,000 - \$70,000 6.  Over \$110,000

Type of vehicle in which this unit is installed.

Make: \_\_\_\_\_ Model: \_\_\_\_\_

Purchased Year: \_\_\_\_\_ Model Year: \_\_\_\_\_

How was this vehicle purchased?

1.  Bought 2.  Leased

Thank you for your cooperation! We value your privacy. This information will remain confidential with Alpine and its affiliates.

PART NO. 68P04190K01-O

SEAL HERE

SEAL HERE

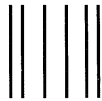

NO POSTAGE  
NECESSARY  
IF MAILED  
IN THE  
UNITED STATES

**BUSINESS REPLY MAIL**  
FIRST CLASS MAIL PERMIT N. 320 TORRANCE, CA.90509

POSTAGE WILL BE PAID BY ADDRESSEE



ALPINE ELECTRONICS OF AMERICA, INC.  
Attention : MARKETING SERVICES  
P.O. Box 2859  
Torrance, CA 90509-9939



## Free Manuals Download Website

<http://myh66.com>

<http://usermanuals.us>

<http://www.somanuals.com>

<http://www.4manuals.cc>

<http://www.manual-lib.com>

<http://www.404manual.com>

<http://www.luxmanual.com>

<http://aubethermostatmanual.com>

Golf course search by state

<http://golfingnear.com>

Email search by domain

<http://emailbydomain.com>

Auto manuals search

<http://auto.somanuals.com>

TV manuals search

<http://tv.somanuals.com>