



EN

CH

# CDA-W560E CDA-W560EG

## CD/CST/DSP RECEIVER

- OWNER'S MANUAL  
Please read before using this equipment.
- 用戶說明書  
使用前請一定閱讀本說明書。



**ALPINE ELECTRONICS MARKETING, INC.**  
1-1-8 Nishi Gotanda,  
Shinagawa-ku,  
Tokyo 141-0031, Japan  
Phone 03-5496-8231

**ALPINE ELECTRONICS OF AMERICA, INC.**  
19145 Gramercy Place, Torrance,  
California 90501, U.S.A.  
Phone 1-800-ALPINE-1 (1-800-257-4631)

**ALPINE ELECTRONICS OF CANADA, INC.**  
7300 Warden Ave., Suite 203, Markham,  
Ontario L3R 9Z6, Canada  
Phone 1-800-ALPINE-1 (1-800-257-4631)

**ALPINE ELECTRONICS OF AUSTRALIA PTY. LTD.**  
6-8 Fiveways Boulevard Keysborough,  
Victoria 3173, Australia  
Phone 03-9769-0000

**ALPINE ELECTRONICS GmbH**  
Kreuzerkamp 7,  
40878 Ratingen, Germany  
Phone 02102-4550

**ALPINE ELECTRONICS OF U.K. LTD.**  
Alpine House  
Fletchamstead Highway, Coventry CV4 9TW, U.K.  
Phone 0870-33 33 763

**ALPINE ELECTRONICS FRANCE S.A.R.L.**  
(RCS PONTOISE B 338 101 280)  
98, Rue de la Belle Etoile, Z.I. Paris Nord II,  
B.P. 50016, 95945 Roissy Charles de Gaulle  
Cedex, France  
Phone 01-48638989

**ALPINE ITALIA S.p.A.**  
Viale C. Colombo 8, 20090 Trezzano  
Sul Naviglio (MI), Italy  
Phone 02-484781

**ALPINE ELECTRONICS DE ESPAÑA, S.A.**  
Portal de Gamarra 36, Pabellón, 32  
01013 Vitoria (Alava)-APDO 133, Spain  
Phone 945-283588

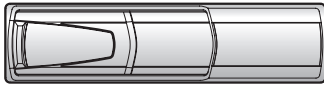

#### **CHA-S634**

- CD changer for CDA-W560E/  
CDA-W560EG.
- 用於 CDA-W560E/CDA-W560EG  
的 CD 換碟機。

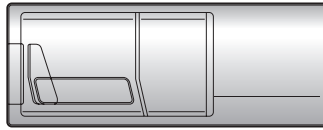

#### **CHA-1214**

- CD changer for CDA-W560E/  
CDA-W560EG.
- 用於 CDA-W560E/CDA-W560EG  
的 CD 換碟機。

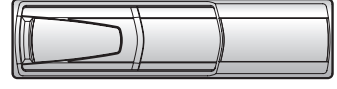

#### **CHM-S630**

## **Alpine CD Changers Give You More!**

### ***More musical selections, more versatility, more convenience.***

The CHA-S634 is a high-performance 6-disc changer with a new M DAC, CD-R/RW PLAY BACK, MP3 PLAY BACK and CD TEXT. The CHA-1214 Ai-NET model holds 12 discs, and the CHM-S630 M-Bus model is a super-compact 6-disc changer with a CD-R/RW PLAY BACK.

## **Alpine CD 換碟器讓您更加滿意！**

### ***更多音樂選項，更多功能性，更佳方便性。***

CHA-S634 是一個帶新型 M DAC, CD-R/RW PLAY BACK, MP3 PLAY BACK 和 CD TEXT 的高性能 6 碟式換碟器。CHA-1214 Ai-NET 型號可裝載 12 張唱碟，CHM-S630 M-Bus 型號是一個帶 CD-R/RW PLAY BACK 的超小型 6 碟式換碟器。

# Contents

The CDA-W560EX model that appears in this Manual represents the CDA-W560E and CDA-W560EG models.

## Operating Instructions



### WARNING

<b>WARNING</b> .....	<b>2</b>
<b>CAUTION</b> .....	<b>2</b>
<b>PRECAUTIONS</b> .....	<b>2</b>



### Basic Operation

Initial System Start-Up .....	5
Turning Power On and Off .....	5
Adjusting Volume/Balance (Between Left and Right)/Fader (Between Front and Rear)/Defeat ....	5
Audio Mute Function .....	5
About SETUP .....	6

## CD Operation

Playback (CD) .....	7
Scanning Programmes .....	7
M.I.X. (Random Play) .....	7
Repeat Play .....	8
Searching from CD Text .....	8
Quick Search .....	8

## MP3/WMA Operation

Playing MP3/WMA Files .....	9
Selecting Folders .....	9
File/Folder Search .....	9
Quick Search .....	10
Playing MP3/WMA Data .....	10
Scanning Programmes .....	10
M.I.X. (Random Play) .....	11
Repeat Play .....	11
About MP3/WMA .....	12

## Cassette Player Operation

Playback (Cassette) .....	14
Manual Reverse .....	14
Dolby B NR (Noise Reduction) .....	14
Repeat Play .....	14
Blank Skip (B.SKIP) .....	15
Scanning Programmes .....	15
Programme Sensor (P.S.) .....	15

## Radio Operation

Listening to Radio .....	16
Manual Storing of Station Presets .....	16
Automatic Memory of Station Presets .....	16
Tuning to Preset Stations .....	17
Station Title Search Function .....	17

## CD Changer Operation (Optional)

Controlling CD Changer .....	17
------------------------------	----

## Title/Text Operation

Displaying the Title/Text .....	18
Titling Discs/Stations .....	19
Scroll Setting .....	19
Erasing Disc Title/Station Title .....	19

## Sound Setting

Setting the MX Mode .....	20
Adjusting the HPF/LPF .....	20
Recalling the Equalizer Curve .....	21
Adjusting and Storing the Equalizer Curve ....	21
About the Time Correction .....	22
Setting the Bass Focus .....	23
Time Correction Adjustment and Storage/Calling .....	24

## Other Functions

Setting Time .....	25
Displaying Time .....	25
Sound Guide Function .....	25
Switching the Tuner Mode .....	26
Dimmer Control .....	26
Adjusting Display Contrast .....	26
Demonstration Function .....	26
Subwoofer On and Off .....	27
Setting the AUX Mode (V-Link) .....	27
Setting Tone Defeat for External Devices .....	27
Turning Mute Mode On/Off .....	27

## Information

In Case of Difficulty .....	28
-----------------------------	----

## Installation and Connections

<b>Warning</b> .....	<b>30</b>
<b>Caution</b> .....	<b>30</b>
<b>Precautions</b> .....	<b>30</b>
Installation .....	31
Connections .....	32
Specifications .....	34

- Dolby noise reduction manufactured under license from Dolby Laboratories Licensing Corporation. "DOLBY" and the double-D symbol are trademarks of Dolby Laboratories Licensing Corporation.
- US and foreign patents licensed from Dolby Laboratories Licensing Corporation.
- Windows Media and the Windows logo are trademarks, or registered trademarks of Microsoft Corporation in the United States and/or other countries.

---

---

# Operating Instructions

## WARNING



### WARNING

This symbol means important instructions. Failure to heed them can result in serious injury or death.

---

#### DO NOT OPERATE ANY FUNCTION THAT TAKES YOUR ATTENTION AWAY FROM SAFELY DRIVING YOUR VEHICLE.

Any function that requires your prolonged attention should only be performed after coming to a complete stop. Always stop the vehicle in a safe location before performing these functions. Failure to do so may result in an accident.

---

#### KEEP THE VOLUME AT A LEVEL WHERE YOU CAN STILL HEAR OUTSIDE NOISE WHILE DRIVING.

Failure to do so may result in an accident.

---

#### MINIMIZE DISPLAY VIEWING WHILE DRIVING.

Viewing the display may distract the driver from looking ahead of the vehicle and cause an accident.

---

#### DO NOT DISASSEMBLE OR ALTER.

Doing so may result in an accident, fire or electric shock.

---

#### USE THIS PRODUCT FOR MOBILE 12V APPLICATIONS.

Use for other than its designed application may result in fire, electric shock or other injury.

---

#### KEEP SMALL OBJECTS SUCH AS BATTERIES OUT OF THE REACH OF CHILDREN.

Swallowing them may result in serious injury. If swallowed, consult a physician immediately.

---

#### USE THE CORRECT AMPERE RATING WHEN REPLACING FUSES.

Failure to do so may result in fire or electric shock.

---

#### DO NOT PLACE HANDS, FINGERS OR FOREIGN OBJECTS IN INSERTION SLOTS OR GAPS.

Doing so may result in personal injury or damage to the product.



### CAUTION

This symbol means important instructions. Failure to heed them can result in injury or material property damage.

---

#### HALT USE IMMEDIATELY IF A PROBLEM APPEARS.

Failure to do so may cause personal injury or damage to the product. Return it to your authorized Alpine dealer or the nearest Alpine Service Center for repairing.



## PRECAUTIONS

---

#### Temperature

Be sure the temperature inside the vehicle is between +60°C (+140°F) and -10°C (+14°F) before turning your unit on.

---

#### Moisture Condensation

You may notice the Disc playback sound wavering due to condensation. If this happens, remove the disc from the player and wait about an hour for the moisture to evaporate.

---

#### Damaged Disc

Do not attempt to play cracked, warped, or damaged discs. Playing a bad disc could severely damage the playback mechanism.

---

#### Maintenance

If you have problems, do not attempt to repair the unit yourself. Return it to your Alpine dealer or the nearest Alpine Service Station for servicing.

---

### Never Attempt the Following

Do not grip or pull out the disc while it is being pulled back into the player by the automatic reloading mechanism.

Do not attempt to insert a disc into the unit when the unit power is off.

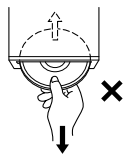

---

### Inserting Discs

Your player accepts only one disc at a time for playback. Do not attempt to load more than one disc.

Make sure the label side is facing up when you insert the disc.

Your player will automatically eject any disc that is inserted incorrectly. If the player continues to eject a correctly inserted disc, push the Reset switch with a pointed object such as a ballpoint pen.

Playing a disc while driving on a very bumpy road may result in skips, but this will not scratch the disc or damage the player.

---

### New Discs

As a protective measure to prevent the CD from jamming, the CD player will automatically eject discs with irregular surfaces or inserted incorrectly. When a new disc is inserted into the player and ejected after initial loading, using your finger, feel around the inside of the centre hole and outside edge of the disc. If you feel any small bumps or irregularities, this could inhibit proper loading of the disc. To remove the bumps, rub the inside edge of the hole and outside edge of the disc with a ballpoint pen or other such instrument, then insert the disc again.



---

### Irregular Shaped Discs

Be sure to use round shape discs only for this unit and never use any special shape discs.

Use of special shape discs may cause damage to the mechanism.



---

### Tape Slack

Check and make sure any slack in the tape is taken up before inserting the tape into the unit. A loose tape can get caught in the mechanism and cause damage to the unit and the tape itself.

Tighten the tape by inserting a pencil or a similar instrument into the spindle hole and turn until all the slack has been taken up.

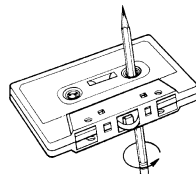

---

### Excessively Thin Tape

C-120 type cassette tapes are not recommended for use in automobile tape players.

---

### Precision Tape Mechanism

Prevent any foreign objects from entering the cassette opening as the precision mechanism and tape head may be damaged.

Never play dirty or dusty tapes – they can damage the tape head.

---

### Tape Head Cleaning

Periodic cleaning (approximately every 20 hours of use) of the tape head with a wet type head-cleaning cassette tape (available at audio stores) is necessary for best performance.

---

### Fuse Replacement

When replacing the fuse(s), the replacement must be of the same amperage as shown on the fuse holder. If the fuse blows more than once, carefully check all electrical connections for shorted circuitry. Also have your vehicle's voltage regulator checked.

---

### Installation Location

Make sure the CDA-W560EX will not be installed in a location subjected to:

- Direct sun and heat
- High humidity and water
- Excessive dust
- Excessive vibrations

---

## Correct Handling

Do not drop the disc while handling. Hold the disc so you will not leave fingerprints on the surface. Do not affix tape, paper, or gummed labels to the disc. Do not write on the disc.

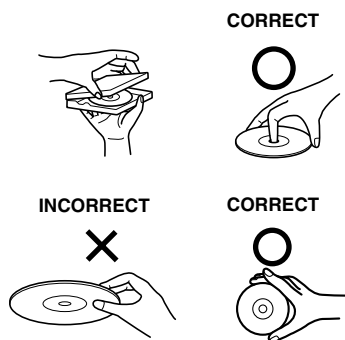

---

## Disc Cleaning

Fingerprints, dust, or soil on the surface of the disc could cause the CD player to skip. For routine cleaning, wipe the playing surface with a clean, soft cloth from the centre of the disc to the outer edge. If the surface is heavily soiled, dampen a clean, soft cloth in a solution of mild neutral detergent before cleaning the disc.



---

## Disc Accessories

There are various accessories available on the market for protecting the disc surface and improving sound quality. However, most of them will influence the thickness and/or diameter of the disc. Using such accessories can cause the disc to be out of standard specifications and may create operational problems. We recommend not using these accessories on discs played in Alpine CD players.

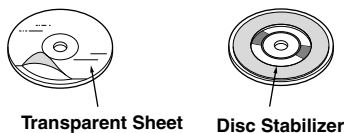

---

## On handling Compact Discs (CD/CD-R/CD-RW)

- Do not touch the surface.
- Do not expose the disc to direct sunlight.
- Do not affix stickers or labels and do not write on the surface.
- Clean the disc when it is dusty.
- Make sure that there are no bumps around the disc.
- Do not use commercially available disc accessories.

**Do not leave the disc in the car or the unit for a long time. Never expose the disc to direct sunlight.** Heat and humidity may damage the CD and you may not be able to play it again.

## To customers using CD-R/CD-RW

- If a CD-R/CD-RW cannot be played back, make sure the last recording session was closed (finalized).
- Finalize the CD-R/CD-RW if necessary, and attempt playback again.

---

## About media that can be played with the CDA-W560EX.

Use only compact discs with the label side showing the CD logo marks below.



If you use unspecified compact discs, correct performance cannot be guaranteed.

You can play CD-Rs (CD-Recordable)/CD-RWs (CD-ReWritable) for audio use on this unit. You can also play CD-Rs/CD-RWs containing MP3/WMA formatted audio files.

- Some of the following CDs may not play on this unit:
  - Flawed CDs, CDs with fingerprints, CDs exposed to extreme temperatures or sunlight (e.g., left in the car or this unit), CDs recorded under unstable conditions, CDs on which a recording failed or a re-recording was attempted, copy-protected CDs which do not conform to the audio CD industry standard.
- Use discs with MP3/WMA files written in a format compatible with this unit. For details, see page 12-13.

# Basic Operation

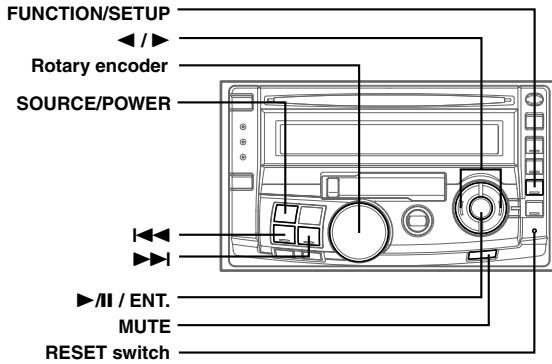

## Initial System Start-Up

Be sure to press the RESET switch when using the unit for the first time, after installing the CD changer, etc., or after changing the car battery.

- 1 Make sure that the power of the unit is off. If it is on, press and hold **SOURCE/POWER** for at least 3 seconds to turn off the unit.
- 2 Press the **RESET** switch with a ballpoint pen, or any other pointed object.



## Turning Power On and Off

Press **SOURCE/POWER** to turn on the unit.

- The unit can be turned on by pressing any other button except **CD**, **CST** and **TITLE**.

Press and hold **SOURCE/POWER** for at least 3 seconds to turn off the unit.

- Controllable with Remote Control (CDA-W560E only)  
This unit can be controlled with an optional Alpine remote control. For details, consult your Alpine dealer.
- Point the optional remote control transmitter at the remote control sensor.

Remote control sensor

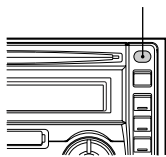

## Adjusting Volume/Balance (Between Left and Right)/Fader (Between Front and Rear)/Defeat

- 1 Press **Rotary encoder** repeatedly to choose the desired mode.

Each press changes the modes as follows:

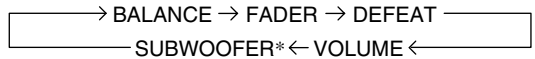

Volume : 0 ~ 35  
Subwoofer: 0 ~ +15  
Balance : L15 ~ R15  
Fader : R15 ~ F15

Press **Left Arrow** or **Right Arrow** after selecting the Subwoofer mode, and the subwoofer output phase is toggled NORMAL (PHASE 0°) or REVERSE (PHASE 180°).

- If **Rotary encoder** is not pressed within 5 seconds after selecting the **BALANCE**, **FADER**, **DEFEAT** or **SUBWOOFER** mode, the unit automatically returns to the **VOLUME** mode.
- \* When the subwoofer mode is **OFF**, its level cannot be adjusted.

- 2 Turn the **Rotary encoder** until the desired sound is obtained in each mode.

By setting Defeat ON, previously adjusted settings of EQ will return to the factory defaults, and MX will be turned off.

- Depending on the connected devices, some functions and display indications do not work.

## Audio Mute Function

Activating this function will instantly lower the volume level by 20 dB.

Press **MUTE** to activate the **MUTE** mode.

The audio level will decrease by about 20 dB.

Pressing **MUTE** again will bring the audio back to its previous level.

## About SETUP

This unit is equipped with various SETUP functions which allow you to change the settings to suit your own preferences. One such function is "Scroll Setting" which sets the scrolling display of the disc text, etc.

### 1 Press **FUNCTION/SETUP** to select **SETUP** mode.

(CD/Cassette mode)

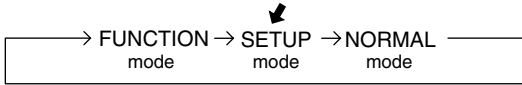

(Radio mode)

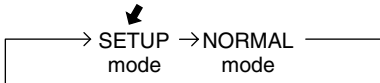

### 2 Press **◀** or **▶** to select from among the various setting modes. See the table at right.

### 3 Press **▶/II / ENT.** to make the setting.

### 4 When the setting is completed, press **FUNCTION/SETUP** to return to the normal mode.

(CD/Cassette mode)

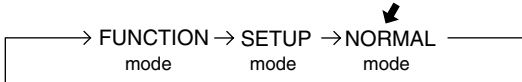

(Radio mode)

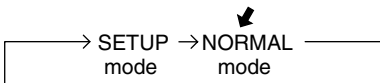

Setting Item	Reference Page	Settings Details
TUNER mode selection	26	TUNER <b>NORMAL</b> /HI-FI/ STABLE
Display brightness adjustment	26	DIMMER <b>AUTO</b> /MANUAL
Subwoofer ON/OFF	27	SUBW. <b>ON</b> /OFF
MP3 playback data setting	10	<b>CD-DA ONLY</b> /CD-DA & MP3/WMA
Operation sound setting	25	BEEP <b>ON</b> /OFF
Scrolling setting	19	SCROLL <b>AUTO</b> /MANUAL
External interrupt setting	27	INT MUTE <b>ON</b> /OFF
Defeat setting for external interrupts	27	INT AUDIO <b>ON</b> /OFF
External input setting	27	AUX IN <b>ON</b> /OFF
Display contrast adjustment	26	CONTRAST <b>±0</b>
Demo ON/OFF	26	DEMO <b>ON</b> /OFF

**Bold** portions are the initial setting positions.



# CD Operation

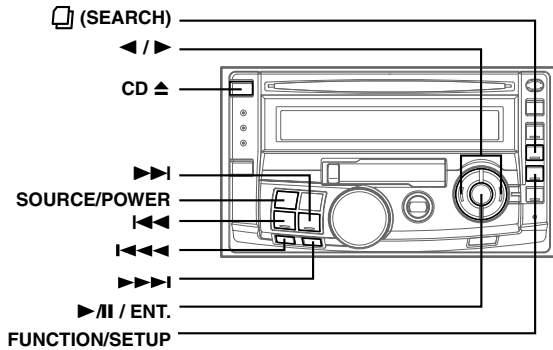

## Playback (CD)

- 1 Insert a disc with the label side facing up.  
The disc will be pulled into the unit automatically.

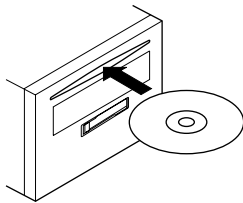

- Do not attach adapters to CD singles (8 cm) as it may cause malfunction of the unit.
- When a disc is already inserted, press **SOURCE/POWER** to switch to CD mode. Playback starts.

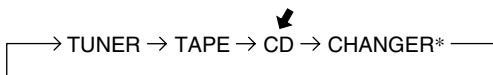

(\* Only when the changer is connected)

- 2 Press **◀**, **▶** or **◀▶**, **▶▶** to select the desired track.

### Returning to the beginning of the current track:

Press **◀◀** or **◀◀◀**.

### Fast backward:

Press and hold **◀◀**.

### Advancing to the beginning of the next track:

Press **▶▶** or **▶▶▶**.

### Fast forward:

Press and hold **▶▶**.

- 3 Press **▶/II / ENT.** to pause playback.  
Press **▶/II / ENT.** again to start playback.

- 4 Press **CD ▲** to eject the disc.  
Be sure to remove the disc after ejecting.

- Do not remove a CD during its eject cycle. Do not load more than one disc at a time. A malfunction may result from doing either.
- In the CD/Changer mode, pressing "BAND" will switch the disc mode.

## Scanning Programmes

The first 10 seconds of each track will be played back in succession.

- 1 Press **FUNCTION/SETUP** to select the **FUNCTION** mode.



- 2 Press **◀** or **▶** to select **SCAN** mode, then press **▶/II / ENT.**

The mode that is blinking at the centre of the display is the selected mode.

- 3 Press **◀** or **▶** to select **ON**, then press **▶/II / ENT.**

→ **ON** **OFF**

- When you have found a desired track for listening, switch the function **OFF** with the above procedure.
- The **FUNCTION** mode will be cancelled when an operation has not been performed in 10 seconds.

## M.I.X. (Random Play)

The tracks on the disc will be played back in random sequence.

- 1 Press **FUNCTION/SETUP** to select the **FUNCTION** mode.

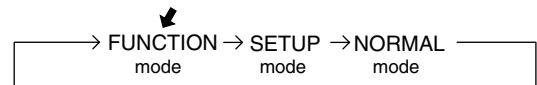

- 2 Press **◀** or **▶** to select **M.I.X.** mode, then press **▶/II / ENT.**

The mode that is blinking at the centre of the display is the selected mode.

- 3 Press **◀** or **▶** to select **M.I.X. ONE** or **M.I.X. ALL**, then press **▶/II / ENT.**

The mode that is blinking is the selected mode.

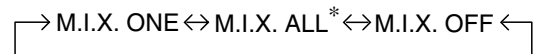

\* In changer modes supporting **M.I.X. ALL** (Changers supporting MP3 are not supported in **M.I.X. ALL**)

- 4 To cancel, select **M.I.X. OFF** with the above procedure.

- The **FUNCTION** mode will be cancelled when an operation has not been performed in 10 seconds.
- Changer Mode
  - Specifying "M.I.X. ONE" will play all the tracks of the disc in random order.
  - Specifying "M.I.X. ALL" will (randomly) play track by track while changing between discs. (Only for changers that support M.I.X. ALL.)
  - Specifying "M.I.X. ONE" while playing "RPT ALL" will start M.I.X. play of the current disc.

## Repeat Play

The track will be played repeatedly.

- 1 Press **FUNCTION/SETUP** to select the **FUNCTION** mode.

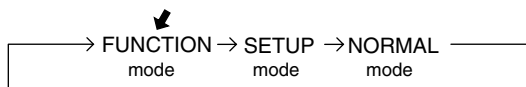

- 2 Press **◀** or **▶** to select **REPEAT** mode, then press **▶/II / ENT..**  
The mode that is blinking at the centre of the display is the selected mode.

- 3 Press **◀** or **▶** to select **RPT ONE** or **RPT ALL**, then press **▶/II / ENT..**  
The mode that is blinking is the selected mode.



\* In changer mode

\*\* "REPEAT" is displayed in CD mode and "RPT" is displayed in changer mode.

- 4 To cancel, select **RPT OFF** with the above procedure.
- The **FUNCTION** mode will be cancelled when an operation has not been performed in 10 seconds.
  - **Changer Mode**
    - Specifying "RPT ALL" serves to play the disc repeatedly.
    - Setting "RPT ALL" to ON during M.I.X. play will start M.I.X. play of the current disc.

## Searching from CD Text

Tracks can be searched and played from among CD text. In the case of discs and changers that do not support text, searches can be made from the track numbers.

- 1 Press **SEARCH** during play.  
This will set the search mode.

- 2 Press **◀** or **▶** to select the desired track, then press **▶/II / ENT..**  
This will play the selected track.

- Press **SEARCH** in the search mode to cancel. Or, the search mode will be cancelled when an operation has not been performed in 10 seconds.
- CD text search cannot be made during M.I.X. play.

## Quick Search

You can search for tracks.

Press and hold **◀◀◀** or **▶▶▶** to select the desired track (track number).

The selected track is played back immediately.

- Holding down **◀◀◀** or **▶▶▶** causes the track numbers to change continuously and removing your finger starts playing that track.

# MP3/WMA Operation

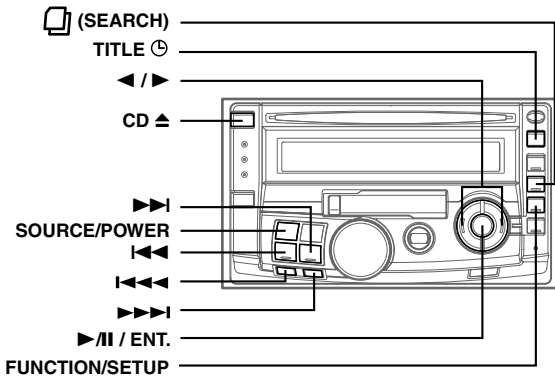

## Playing MP3/WMA Files

The CDA-W560EX includes a built-in MP3/WMA decoder. You can play CD-ROMs, CD-Rs, and CD-RWs containing MP3/WMA files on this decoder. Use a format compatible with this unit.

For further information about playing or storing MP3/WMA files, refer to pages 12 – 13 before using the decoder.

- 1 **Insert a disc containing an MP3 or WMA file with the label side facing up.**

The disc will be pulled into the unit automatically.

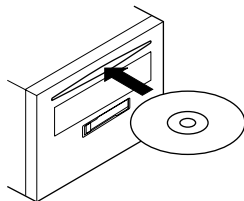

- Do not attach adapters to CD singles (8 cm) as it may cause malfunction of the unit.
- When a disc is already inserted, press **SOURCE/POWER** to switch to the CD mode.

The mode will change every time the button is pressed.

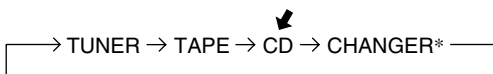

(\* Only when the CD changer is connected)

- 2 Press **Left Arrow**, **Right Arrow** or **Left Arrow**, **Right Arrow** to select the desired track (file).

**Returning to the beginning of the current track (file):**

Press **Left Arrow** or **Left Arrow**.

**Fast backward:**

Press and hold **Left Arrow**.

**Advancing to the beginning of the next track (file):**

Press **Right Arrow** or **Right Arrow**.

**Fast forward:**

Press and hold **Right Arrow**.

- 3 Press **PAUSE/ENTER** to pause playback.  
Press **PAUSE/ENTER** again to start playback.

- 4 Press **CD Eject** to eject the disc.  
Be sure to remove the disc after ejecting.

- Do not remove a CD during its eject cycle. Do not load more than one disc at a time. A malfunction may result from doing either.
- The unit can play discs containing both audio data and MP3/WMA data.
- The track display for MP3/WMA data playback is the track numbers recorded on the disc.

## Selecting Folders

Press **Left Arrow** or **Right Arrow** to select the former or latter folder.

- When using a changer that supports MP3, press **FOLDER/PRESET** and then perform the operation within 15 seconds.

## File/Folder Search

Files can be searched and played from among the folders on the disc.

- 1 Press **(SEARCH)** while playing MP3/WMA to set the folder search mode.

- 2 Press **Left Arrow** or **Right Arrow** to select the desired folder, then press **PAUSE/ENTER**.  
This will set the file search mode.

- 3 Press **Left Arrow** or **Right Arrow** to select the desired file, then press **PAUSE/ENTER**.  
This will play the selected file.

- Press **(SEARCH)** in the search mode to cancel. Or, the search mode will be cancelled when an operation has not been performed in 10 seconds.
- Folder or file searches cannot be made during M.I.X. play.
- "NO FILE" is displayed for 2 seconds if the folder that is selected by the Folder Search mode contains no files.
- "-----" is displayed for the root folder.

## Quick Search

You can search for tracks (files).

**Press and hold** ◀◀◀ or ▶▶▶ **to select the desired track (file number).**

The selected track is played back immediately.

- Holding down ◀◀◀ or ▶▶▶ causes the files to change continuously and removing your finger starts playing that track.

### MP3/WMA Play Display

The folder number, file number, sampling rate, and bit rate will be displayed as described below.

Folder number display    File number display

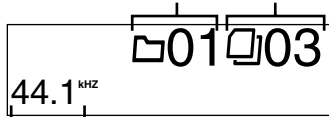

Sampling rate display



The sampling rate and the bit rate (frame display) are alternately displayed.

Folder number display    File number display

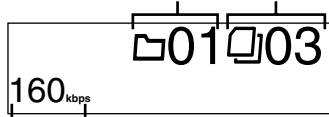

Bit rate display

As the root folder number is displayed as 1, when there is no file in the root folder, the first folder is displayed as 2 and played back.

- Press **TITLE** ⊕ to switch the display. Please see “Displaying the Title/Text” (on Page 18) for information about display switching.

## Playing MP3/WMA Data

This product can playback CDs containing both CD and MP3/WMA data. However, in some situations (some enhanced CDs), playback may be difficult. For these special cases, you can select playback of CD data only. When a disc contains both CD or the MP3/WMA data, playback starts from the CD data portion of the disc.

**1 Press FUNCTION/SETUP to select the SETUP mode\*.**

\* See “About SETUP” on Page 6.

**2 Press ◀ or ▶ to select the CD-DA mode.**

**3 Press ▶/II / ENT. to set the disc selection range.**

**CD-DA ONLY** ↔ **CD-DA & MP3/WMA**  
(Initial setting)

**4 After completing the setting, press FUNCTION/SETUP to return to the normal mode.**

- Perform this setting before inserting a disc. If a disc has already been inserted, perform the setting after you remove the disc. (If you use an MP3 changer, you have to change discs.)

## Scanning Programmes

The first 10 seconds of each track (file) will be played back in succession.

**1 Press FUNCTION/SETUP to select the FUNCTION mode.**

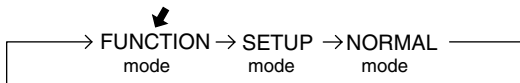

**2 Press ◀ or ▶ to select the SCAN mode, then press ▶/II / ENT..**

The mode that is blinking at the centre of the display is the selected mode.

**3 Press ◀ or ▶ to select ON, then press ▶/II / ENT..**

→ **ON**    **OFF**

- When you have found a desired track for listening, switch the function OFF with the above procedure.
- The FUNCTION mode will be cancelled when an operation has not been performed in 10 seconds.

## M.I.X. (Random Play)

The tracks (files) on the disc will be played back in random sequence.

- 1 Press **FUNCTION/SETUP** to select the **FUNCTION** mode.

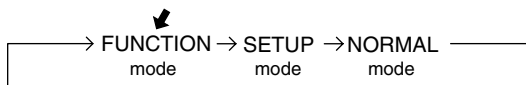

- 2 Press **◀** or **▶** to select the **M.I.X. mode**, then press **▶/II / ENT.**.

The mode that is blinking at the centre of the display is the selected mode.

- 3 Press **◀** or **▶** to select **M.I.X. ONE** or **M.I.X. FLDR**, then press **▶/II / ENT.**.

The mode that is blinking at the centre of the display is the selected mode.

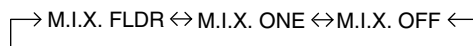

M.I.X. FLDR: Only files in a folder are played back in random sequence.

M.I.X. ONE : Files in a disc are played back in random sequence.

If an MP3 compatible CD changer is connected, all files in a disc are played back in random sequence, and playback shifts to the next disc.

- 4 To cancel, select **M.I.X. OFF** with the above procedure.

- The **FUNCTION** mode will be cancelled when an operation has not been performed in 10 seconds.

## Repeat Play

The track (file) will be played repeatedly.

- 1 Press **FUNCTION/SETUP** to select the **FUNCTION** mode.

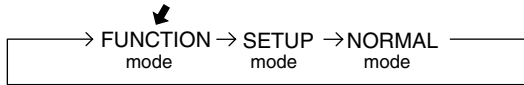

- 2 Press **◀** or **▶** to select the **REPEAT mode**, then press **▶/II / ENT.**.

The mode that is blinking at the centre of the display is the selected mode.

- 3 Press **◀** or **▶** to select the **RPT mode**, then press **▶/II / ENT.**.

The mode that is blinking at the centre of the display is the selected mode.

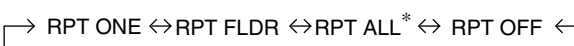

(\* When an MP3 compatible CD changer is connected.)

RPT ONE : Only a file is repeatedly played back

RPT FLDR : Only files in a folder are repeatedly played back

RPT ALL : A disc is repeatedly played back

- 4 To cancel, select **RPT OFF** with the above procedure.

- The **FUNCTION** mode will be cancelled when an operation has not been performed in 10 seconds.

## About MP3/WMA

### CAUTION

*Except for private use, duplicating audio data (including MP3/WMA data) or distributing, transferring, or copying it, whether for free or for a fee, without permission of the copyright holder is strictly prohibited by the Copyright Act and by international treaty.*

### What is MP3?

MP3, whose official name is "MPEG Audio Layer 3," is a compression standard prescribed by the ISO, the International Standardization Organization and MPEG which is a joint activity institution of the IEC.

MP3 files contain compressed audio data. MP3 encoding is capable of compressing audio data at extremely high ratios, reducing the size of music files to as much as one-tenth their original size. This is achieved while still maintaining near CD quality. The MP3 format realizes such high compression ratios by eliminating the sounds that are either inaudible to the human ear or masked by other sounds.

### What is WMA?

WMA, or "Windows Media™ Audio," is compressed audio data.

WMA allows you to create music files and store them at higher ratios of compression than MP3 audio data (approx. half original size). This is achieved while still maintaining CD quality sound.

### Method for creating MP3/WMA files

Audio data is compressed by using MP3/WMA specified software. For details on creating MP3/WMA files, refer to the user's manual for that software.

MP3/WMA files that can be played back by this device have the file extension "mp3" / "wma". Files with no extension cannot be played back. (WMA ver. 7.1 and 8 are supported)

### Supported playback sampling rates and bit rates

#### MP3

Sampling rates: 48 kHz, 44.1 kHz, 32 kHz, 24 kHz, 22.05 kHz, 16 kHz, 12 kHz, 11.025 kHz, 8 kHz

Bit rates: 8 - 320 kbps

#### WMA

Sampling rates: 48 kHz, 44.1 kHz, 32 kHz, 24 kHz, 22.05 kHz

Bit rates: 32 - 192 kbps

Note that for sampling rates, this device's frame display (Page 10) may not display correctly.

This device may not play back correctly depending on sampling rates.

### ID3 tags/WMA tags

This device supports ID3 tag v1 and v2, and WMA tag.

If tag data is in an MP3/WMA file, this device can display the title (track title), artist name, and album name ID3 tag/WMA tag data.

This device can only display single-byte alphanumeric characters and the underscore (up to 30 characters, and up to 15 characters for WMA). For non-supported characters, "NO SUPPORT" is displayed.

### Producing MP3/WMA discs

MP3/WMA files are prepared, then written to a CD-R or CD-RW using CD-R writing software. A disc can hold up to 510 files/folders (including Root Folders).

### Media supported

The media that this device can play back are CD-ROMs, CD-Rs, and CD-RWs.

### Corresponding File Systems

This device supports discs formatted with ISO9660 Level 1 or Level 2.

Under the ISO9660 standard, there are some restrictions to remember.

The maximum nested folder depth is 8 (including the root directory). File/folder names are limited to 31 characters (including the extension).

Valid characters for folder/file names are letters A-Z (all caps), numbers 0-9, and '\_' (underscore).

This device also can play back discs in Joliet, Romeo, etc., and other standards that conform to ISO9660. However, sometimes the file names, folder names, etc., are not displayed correctly.

### Formats supported

This device supports CD-ROM XA, Mixed Mode CD, Enhanced CD (CD-Extra) and Multi-Session.

This device cannot correctly play back discs recorded with Track At Once or packet writing.

### Order of tracks

The unit plays the files in the order that the writing software writes them. Therefore, the playing order may not be the same as the order you input. The playback order of the folders and files is as follows. However, the folder and file playback order differs from the folder no. and file no. indicated on the display.

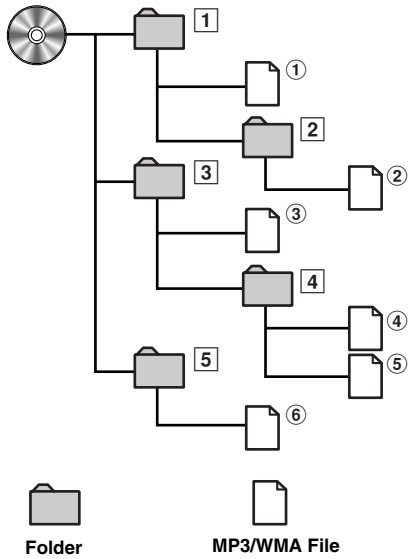

## Terminology

### Bit rate

This is the "sound" compression rate specified for encoding. The higher the bit rate, the higher the sound quality, but also the larger the files.

### Sampling rate

This value shows how many times per second the data is sampled (recorded). For example, music CDs use a sampling rate of 44.1 kHz, so the sound is sampled (recorded) 44,100 times per second. The higher the sampling rate, the higher the sound quality, but also the larger the volume of data.

### Encoding

Converting music CDs, WAVE (AIFF) files, and other sound files into the specified audio compression format.

### Tag

Song information such as track titles, artist names, album names, etc., written into MP3/WMA files.

MP3: ID3 tag

WMA: WMA tag

### Root folder

The root folder is found at the top of the file system. The root folder contains all folders and files.

# Cassette Player Operation

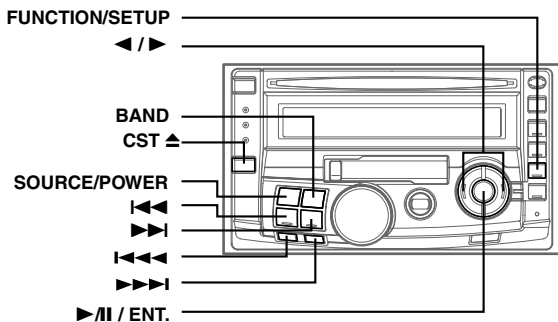

## Playback (Cassette)

### 1 Insert a cassette tape into the slot with the open side facing right.

The player automatically starts tape playback and the display shows "TAPE" and the tape side being played (  $\Delta$  or  $\nabla$  ).

When the end of the tape is reached, the player automatically reverses the tape direction and plays the other side of the tape.

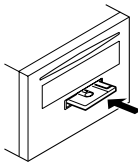

- When power is turned off, the full-logic mechanism will automatically switch to the PAUSE mode. This protects the tape from being deformed by the pinch-rollers if left for long periods.
- Auto Metal  
When a metal cassette tape is inserted, the player automatically adjusts the equalization for metal or any other high bias tape for optimum sound.
- When a cassette tape is already inserted, press SOURCE/POWER to switch to cassette mode. Playback starts.

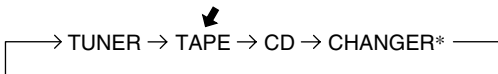

(\* Only when the changer is connected)

### 2 Press $\lll$ or $\ggg$ to fast rewind or forward the tape respectively.

The tape side indicator (  $\Delta$  or  $\nabla$  ) blinks and  $\gg$  or  $\ll$  moves indicating the direction of the tape.

When the end of the tape is reached in the fast rewind mode, the player stops automatically and begins playing from the beginning of the same side.

When the end of the tape is reached in the fast forward mode, the player stops automatically and begins playing from the beginning of the opposite side.

### 3 Press $\ggg$ during forwarding to stop fast forwarding and resume tape play. Press $\lll$ during rewinding to stop rewinding and resume tape play.

The tape side indicator stops blinking.

### 4 Press $\text{II}$ / ENT. to pause playback.

Press  $\text{II}$  / ENT. again to start playback.

### 5 Press CST $\blacktriangle$ to eject the cassette tape.

## Manual Reverse

Press **BAND** during tape play to change the direction of play.

The tape side indicators (  $\Delta$  and  $\nabla$  ) change to show which side of the cassette is being played.

## Dolby B NR (Noise Reduction)

Insert a Dolby B NR encoded tape.

### 1 Press FUNCTION/SETUP to select the FUNCTION mode.



### 2 Press $\ll$ or $\gg$ to select NR. B mode, then press $\text{II}$ / ENT..

The mode that is blinking at the centre of the display is the selected mode.

The display shows the "N.R.". The tape noise is reduced in the Dolby NR mode when a Dolby B NR encoded tape is played.

### 3 Press $\ll$ or $\gg$ to select ON, then press $\text{II}$ / ENT..

$\rightarrow$  ON OFF

### 4 To cancel, select NR. B OFF with the above procedure.

- The FUNCTION mode will be cancelled when an operation has not been performed in 10 seconds.

## Repeat Play

The current programme will be played repeatedly.

### 1 Press FUNCTION/SETUP to select the FUNCTION mode.

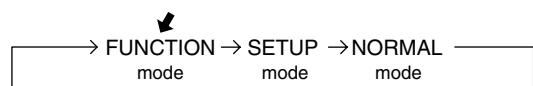

### 2 Press $\ll$ or $\gg$ to select REPEAT mode, then press $\text{II}$ / ENT..

The mode that is blinking at the centre of the display is the selected mode.



**3** Press ◀ or ▶ to select ON, then press ▶/II / ENT..

→ ON OFF

**4** To cancel, select REPEAT OFF with the above procedure.

- The FUNCTION mode will be cancelled when an operation has not been performed in 10 seconds.

## Blank Skip (B.SKIP)

Blank sections on the tape lasting 15 seconds or more are skipped.

**1** Press **FUNCTION/SETUP** to select the **FUNCTION mode**.

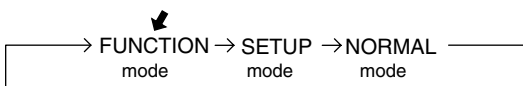

**2** Press ◀ or ▶ to select B.SKIP mode, then press ▶/II / ENT..

The mode that is blinking at the centre of the display is the selected mode.

**3** Press ◀ or ▶ to select ON, then press ▶/II / ENT..

→ ON OFF

**4** To cancel, select B.SKIP OFF with the above procedure.

- The FUNCTION mode will be cancelled when an operation has not been performed in 10 seconds.

## Scanning Programmes

The first 10 seconds of each programme on the tape will be played back in succession.

**1** Press **FUNCTION/SETUP** to select the **FUNCTION mode**.

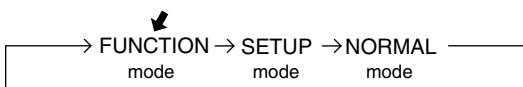

**2** Press ◀ or ▶ to select SCAN mode, then press ▶/II / ENT..

The mode that is blinking at the centre of the display is the selected mode.

**3** Press ◀ or ▶ to select ON, then press ▶/II / ENT..

→ ON OFF

- The SCAN operation cannot detect blank sections of less than 4 seconds.
- When you have found a desired track for listening, switch the function OFF with the above procedure.
- The FUNCTION mode will be cancelled when an operation has not been performed in 10 seconds.

## Programme Sensor (P.S.)

**1** Press I◀◀◀ once during tape play to return to the beginning of the current selection being played.

If you wish to return to the beginning of a selection further back, press repeatedly until the number of selections you would like to skip is shown in the display.

The display will show PS-1 with the first press and will increase by one with each successive press up to PS-9. The tape indicator will blink showing the direction of your search.

**2** Press ▶▶▶I once during tape play to advance to the beginning of the next selection.

If you wish to advance to the beginning of a selection further ahead, press repeatedly until the number of selections you would like to skip is shown in the display. The display will show PS+1 with the first press and will increase by one with each successive press up to PS+9. The tape indicator will blink showing the direction of your search during searching operation.

- The programme sensor feature is functional in the tape play mode only.
- You can advance to the 9th (max.) programme or return to the 8th (max.) programme.

# Radio Operation

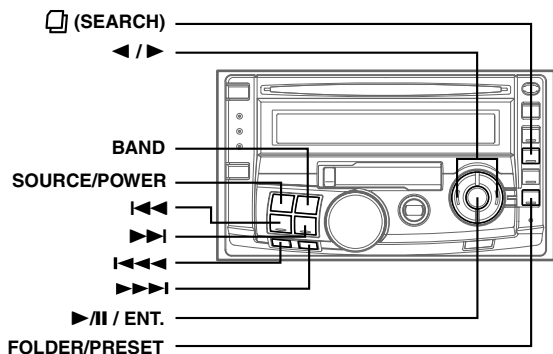

## Listening to Radio

- 1 Press **SOURCE/POWER** to select the **TUNER** mode.

The aerial will extend when the TUNER mode is set. (Only on cars equipped with a power aerial.)

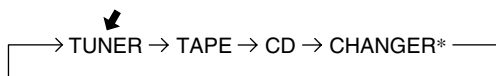

(\* Only when the changer is connected)

- 2 Press **BAND** to select the band.

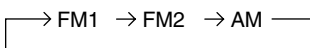

- 3 Press **◀◀◀**, **▶▶▶** or **◀◀◀▶▶▶** to search for a desired broadcast station (frequency).

**◀◀◀▶▶▶**: Manual mode  
Press and hold to change the frequency continuously.

**◀◀◀▶▶▶**: Local mode (SEEK)

**◀◀◀▶▶▶**: Distance mode (DX SEEK)  
(Press and hold)

- **Manual mode:**  
The frequency is manually tuned in steps (Manual tuning).
- **Local mode:**  
Only strong stations will be automatically tuned in (Automatic Seek Tuning).
- **Distance mode:**  
Both strong and weak stations will be automatically tuned in (Automatic Seek Tuning).

## Manual Storing of Station Presets

- 1 See "Listening to Radio" and set the frequency to that of the desired broadcast station.

- 2 Press **FOLDER/PRESET** and within 10 seconds press **◀** or **▶**, select **→ P-MEMO** mode, and press **▶/II / ENT.**

**→ P-MEMO A-MEMO**

- 3 Within 10 seconds press **◀** or **▶**, select the number (1 to 6) that you would like to store, and press **▶/II / ENT.**

The blinking display will change to steady and the broadcast station will be stored.

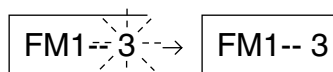

- A total of 18 stations can be stored in the preset memory (6 stations for each band; FM1, FM2 and AM).
- If you store a station in a preset memory which already has a station, the current station will be cleared and replaced with the new station.

## Automatic Memory of Station Presets

- 1 Press **BAND** to display the band you wish to receive.

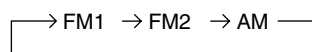

- 2 Press **FOLDER/PRESET** and within 10 seconds press **◀** or **▶**, select **→ A-MEMO** mode, and press **▶/II / ENT.**

**P-MEMO → A-MEMO**

The tuner will automatically seek and store 6 strong stations in the selected band. They will be stored into buttons 1 to 6 in order of signal strength. When the automatic memory has been completed, the tuner goes to the station stored in preset location no. 1.

- If no stations are stored, the tuner will return to the original station you were listening to before the auto memory procedure began.

## Tuning to Preset Stations

- 1 Press **BAND** to select the band.

→ FM1 → FM2 → AM →

- 2 Press **◀** or **▶** to select the preset number. The selected broadcast station will be received.

FM1- 1 87.50 MHz

Preset number display

(Display of the received broadcast station stored in preset numbers "1" to "6".)

- The *ST* indicator appears on the display when a stereo FM station is tuned in.

## Station Title Search Function

If titles for radio stations are entered, you can search for a radio station from its title.

- 1 Press **SEARCH** in **TUNER** mode to switch to **Title Search mode**.

The first title input blinks in the display.

- 2 Press **◀** or **▶** to select the desired title within 10 seconds.

- 3 Press **▶/II / ENT.** to receive the frequency of the selected title.

- Title Search mode will be cancelled by pressing **SEARCH** or if an operation has not been performed in 10 seconds.
- If a station has no title, "NO TITLE" is displayed for 2 seconds.

## CD Changer Operation (Optional)

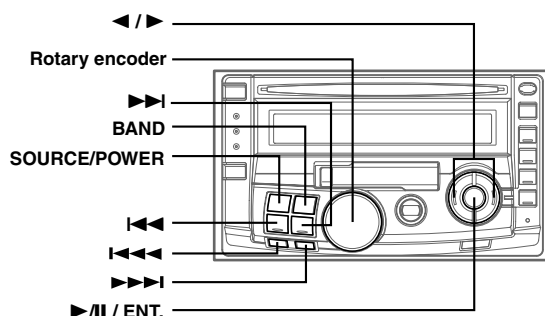

## Controlling CD Changer

- 1 Press **SOURCE/POWER** to set the changer mode.

→ TUNER → TAPE → CD → CHANGER\* →

(\* Only when the changer is connected)

- 2 When selecting the disc number, press **◀** or **▶** to select the desired disc.

- 3 Press **◀◀**, **▶▶** or **◀◀◀**, **▶▶▶** to select the track for listening.

- 4 Turn the **Rotary encoder** and adjust the volume (0 to 35).

- 5 Press **▶/II / ENT.** to pause playback.  
Press **▶/II / ENT.** again to start playback.

- Changer operation can be controlled in the same way as the built-in CD or MP3. (Please see Pages 7 to 13.)
- Pressing **BAND** in the CD/Changer mode will change the disc mode.
- This unit uses the Versatile Link Terminal (KCA-410C) and allows product selection by pressing **BAND** when 2 changers or other equipment is connected.

# Title/Text Operation

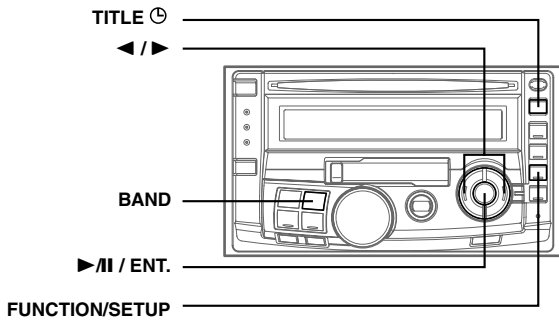

## Displaying the Title/Text

It is possible to display the Disc/Station title if the title has been previously inputted. For details, see "Titling Discs/Stations" (page 19). Text information, such as the disc name and the track name, will be displayed if playing a CD text discs with the title inputted. It is also possible to display the folder name, the file name, and the tag, etc. while playing MP3/WMA files.

### Press TITLE .

The mode will change every time the button is pressed.

#### About "Title" and "Text"

**Title:** With this device, it is possible to input the CD/Station name (refer to page 19). This inputted name is referred to as a "title."

**Text:** Text compatible CDs contain text information such as the disc name and track name. Such text information is referred to as "text."

Radio mode:

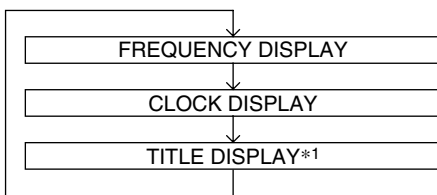

CD mode:

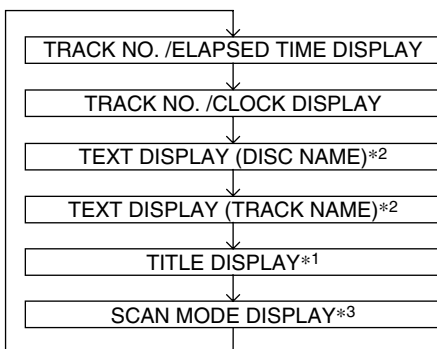

MP3/WMA mode:

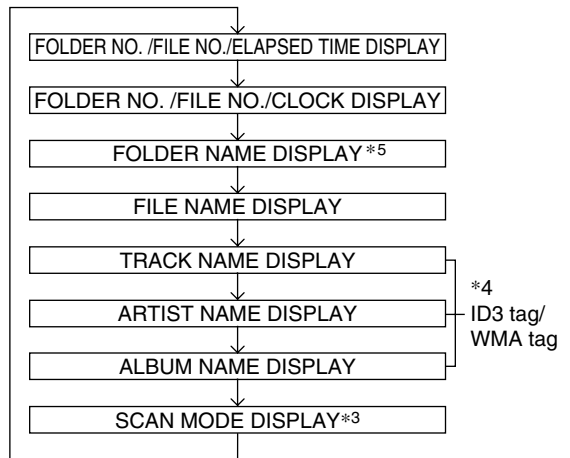

\*1 If the title was not previously input, "NO TITLE" is displayed.

\*2 Displayed during playback of a disc with CD Text. "NO TEXT" will be displayed when the CD contains no Text data.

\*3 SCAN mode... Scrolls through the text information below.  
CD: TEXT (disc name, track name)

MP3/WMA: TAG (track name, artist name, album name), FOLDER NAME, FILE NAME

\*4 If an MP3/WMA file contains ID3 tag/WMA tag information, the ID3 tag/WMA tag information is displayed. (track name, artist name, and album name). All other tag data is ignored. "NO DATA" will be displayed if an MP3/WMA file contains no ID3 tag/WMA tag information.

\*5 Root folders are displayed as "-----".

- Some characters may not be displayed correctly with this device, depending on the character type.
- The CD changer must also be CD Text compatible for the Text information to be displayed.
- When the Scroll Setting (refer to page 19) is set to "SCROLL MANUAL," press and hold TITLE for at least 3 seconds to scroll the Text information only once (TEXT DISPLAY, FOLDER NAME DISPLAY, FILE NAME DISPLAY or TAG DISPLAY mode).
- "NO SUPPORT" is displayed when the desired text information cannot be displayed on this unit.

### About Indicator Display

When the title/text is being displayed, the indicator "▼" of each mode lights as follows:

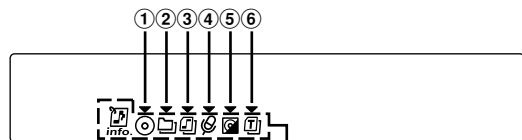

This indicator is constantly lit.

Indicator/ Mode	CD Mode	MP3/WMA Mode	TUNER Mode
①	Title being displayed	—	—
②	—	Folder name being displayed	—
③	—	File name being displayed	—
④	—	Artist name* being displayed	—
⑤	Text (Disc name) being displayed	Album name* being displayed	—
⑥	Text (Track name) being displayed	Track name* being displayed	Title being displayed

\* Tag information

## Titling Discs/Stations

It is possible to title your favourite CD's or radio stations.  
You cannot input titles on MP3/WMA discs.

### 1 Press **TITLE** to select the title display mode.

For details, see Displaying the Title/Text (page 18).

### 2 Press and hold **TITLE** for at least 3 seconds.

The first character will blink.

### 3 Press **BAND** to select the characters/symbols.

→ Upper case → Lower case → Numeral/Symbol

### 4 Press **◀** or **▶** to select the desired letter/numeral/symbol available for naming.

### 5 Press **▶/II / ENT.** to store the first character.

The first character will stop blinking and the display will automatically advance to the next character. When that character begins to blink, you may choose the next letter or symbol of your title.

### 6 Repeat the steps 3 and 5 above to complete the titling. Pressing **▶/II / ENT.** after entering the 10th character, automatically stores the title into memory.

When entering a title of less than 10 characters (for example, 3 character title):

After entering 3 characters to complete your title, the 4th character space will be blinking. Go to step 7 to complete the title.

## 7 Press **TITLE** to record the title.

- You can enter 24 radio station titles and 18 CD titles on this unit. If you try to store beyond the limit, the display will show "FULL DATA." At this point, no more titles can be stored.
- Up to 8 characters are allowed for CD changer titles. The number of titles allowed depends on the CD Changer model.
- To input a new title, one of the previously inputted titles must first be deleted.
- When you want to erase a title, enter the "⏏" symbol into all spaces.
- The operations described in steps 3 to 6 must be made within 10 seconds. The input mode will be cancelled if no action is taken for over 10 seconds.
- Removing power from the unit may delete these titles. Use caution when manipulating the power cord.

## Scroll Setting

### 1 Press **FUNCTION/SETUP** to select the **SETUP mode**\*.

\* See "About SETUP" on Page 6.

### 2 Press **◀** or **▶** to select the **SCROLL mode**.

### 3 Press **▶/II / ENT.** to switch the scroll setting.

**SCROLL AUTO** ↔ **SCROLL MANUAL**  
(Initial setting)

### 4 After completing the setting, press **FUNCTION/SETUP** to return to the normal mode.

- Scrolling is available only for CD text, folder names, file names, and tag information.
- When set to AUTO, scrolling is displayed repeatedly.

## Erasing Disc Title/Station Title

### 1 Press **TITLE** to select the title display mode.

### 2 Press and hold **TITLE** for at least 3 seconds.

The first character of the title will blink.

### 3 Press and hold **▶/II / ENT.** for at least 2 seconds.

The first stored title will blink.

### 4 Press **◀** or **▶** repeatedly until the title you want to erase is displayed.

### 5 Press and hold **▶/II / ENT.** for at least 2 seconds to erase the title displayed.

### 6 Press **TITLE** to cancel the title erasing mode.

- You cannot erase CD-TEXT.
- The operations described in steps 3 to 6 must be made within 10 seconds. The mode will be cancelled if no action is taken for over 10 seconds.
- "NO DATA" is displayed for 2 seconds if the title is not inputted in step 3, or if all titles are erased in step 5.

# Sound Setting

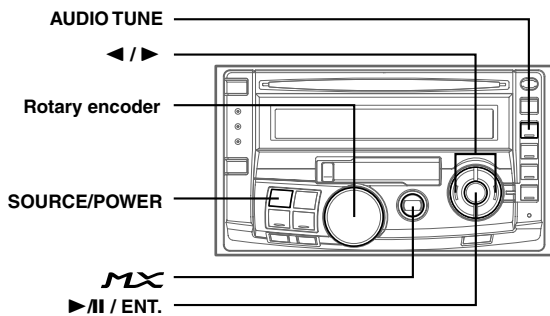

## Setting the MX Mode

MX (Media Xpander) makes vocals or instruments sound distinct regardless of the music source. The FM radio, CD, and MP3/WMA, will be able to reproduce the music clearly even in cars with a lot of road noise.

- 1 Press **MX** to select MX ON.
- 2 Press **SOURCE/POWER** to select the source you want to MX (Media Xpander)-correct.
- 3 Press and hold **MX** for at least 2 seconds to select the MX mode.
- 4 Turn the **Rotary encoder** within 15 seconds to select your preferred mode or OFF.

### FM (MX level 1 to 3):

The medium to high frequencies become more clear, and produces well balanced sound in all the bands.

### CD (MX level 1 to 3):

CD mode processes a large quantity of data. This data is used to reproduce the sound cleanly by making use of the data quantity.

### MP3/WMA (MX level 1 to 3):

This corrects information that was omitted at the time of compression. This reproduces a well-balanced sound close to the original.

### DVD (Video CD) (MX level 1 to 2):

The dialogue portion of the video is reproduced more clearly.

### DVD (CD) (MX level 1):

This disk contains a large quantity of data such as music clip. MX uses this data to reproduce the sound accurately.

### AUX (MX level 1):

Choose the MX mode (MP3, MUSIC, or MOVIE) that corresponds to the media connected.

- 5 After setting, press the **Rotary encoder** to return to the normal mode.

- To cancel MX mode for all music sources, press the MX button to turn MX OFF in Step 1.
- MX mode is automatically cancelled if no buttons are pressed within 15 seconds.
- Each music source, such as radio, CD, and MP3/WMA can have its own MX setting.
- On disks with both MP3/WMA and CD-DA, when the source changes from "MP3/WMA to CD-DA" or "CD-DA to MP3/WMA", the MX-mode switching process may take a little time before a piece is played due to.
- This function is inoperable when DEFEAT is ON (See Page 5).

## Adjusting the HPF/LPF

The High and Low Pass Filters on this unit can be adjusted to suit your personal taste.

- 1 Press **AUDIO TUNE**.
- 2 Press **◀** or **▶** within 15 seconds, select HPF or LPF adjustment mode, and then press **▶/II / ENT.** to set.

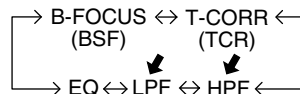

- The LPF function is only available when the subwoofer output from this unit is set to ON.

- 3 Press **◀** or **▶** within 15 seconds, select the frequency, and press **▶/II / ENT.**

### 1. HPF (Setting the High Pass Filter):

FLAT (OFF) ↔ 80Hz ↔ 120Hz ↔ 160Hz

Outputs all frequencies higher than that selected according to your preference.

### 2. LPF (Setting the Low Pass Filter):

FLAT (OFF) ↔ 80Hz ↔ 120Hz ↔ 160Hz

Outputs all frequencies lower than that selected according to your preference.

(Only available when using the subwoofer output from this unit.)

- 4 After completing the setting, press **AUDIO TUNE** to return to the normal mode.

- If no buttons are pressed within 15 seconds, the bass engine menu returns to the normal mode.
- Except when the HPF and LPF is turned OFF, the subwoofer is in monaural mode.

## Recalling the Equalizer Curve

**1 Press AUDIO TUNE.**

**2 Press ◀ or ▶ within 15 seconds, select the EQ mode, and press ►/II / ENT..**

The mode that is blinking at the centre of the display is the selected mode.

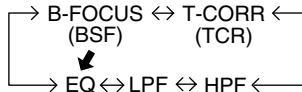

**3 Press ◀ or ▶ within 15 seconds, select the SELECT mode, and press ►/II / ENT..**

The mode that is blinking at the centre of the display is the selected mode.

**4 Press ◀ or ▶ within 15 seconds, select the desired equalizer characteristics, and press ►/II / ENT. to set.**

The mode that is blinking at the centre of the display is the selected mode.

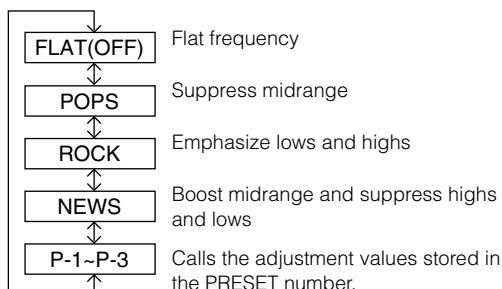

**5 Press AUDIO TUNE to return to the normal mode.**

## Adjusting and Storing the Equalizer Curve

**1 Press AUDIO TUNE.**

**2 Press ◀ or ▶ within 15 seconds, select the EQ mode, and press ►/II / ENT..**

The mode that is blinking at the centre of the display is the selected mode.

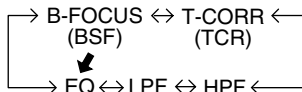

**3 Press ◀ or ▶ within 15 seconds, select the ADJUST mode, and press ►/II / ENT..**

The mode that is blinking at the centre of the display is the selected mode.

**4 Press ◀ or ▶ within 15 seconds to adjust the LOW level (1 to 9)\*, then press ►/II / ENT. to set.**

**5 Repeat Step 4 to set another band.**

LOW → MID-LOW → MID-HIGH → HIGH  
(60Hz) (150Hz) (2.5kHz) (10kHz)

**6 When finished with the settings, press ◀ or ▶, select EXIT, and press ►/II / ENT..**

The mode that is blinking at the centre of the display is the selected mode.

- Selection of CONTINUE will cause a return to the ADJUST mode.
- Selection of P-MEMORY will set the storage mode of the adjustment values.  
(See "Storing Adjustment Contents")

**7 Press AUDIO TUNE to return to the normal mode.**

- This function is inoperable when DEFEAT is ON (See Page 5).
- Please give consideration to the frequency response of the connected speakers when making adjustments.

\* The level can be adjusted to  $\pm 12$ dB with 3dB steps.

"Level 9: +12dB" ←-----→ "Level 7: +6dB" ←-----→ "Level 5: 0dB (FLAT)" ←-----→ "Level 3: -6dB" ←-----→ "Level 1: -12dB"

## Storing Adjustment Contents

**1 Following above-mentioned Step 6 within 15 seconds, press ◀ or ▶ to select P-MEMORY, then press ►/II / ENT..**

The mode that is blinking at the centre of the display is the selected mode.

**2 Press ◀ or ▶ within 15 seconds, select one of "PRESET 1" to "PRESET 3", and press ►/II / ENT..**

This will store the adjusted contents in the selected PRESET number.

**3 Press AUDIO TUNE to return to the normal mode.**

- The contents stored in presets 1 to 3 will be maintained even when the unit is reset or the battery power cable is disconnected.
- The stored contents can be called using the "Recalling the Equalizer Curve" operation.

## About the Time Correction

The distance between the listener and the speakers in a car vary widely due to the special conditions of the mobile environment. This difference in the distances from the speakers to the listener creates a shift in the sounds image and frequency characteristics. This is caused by the time delay between the sound reaching the listener's right versus the left ear.

To correct this, the CDA-W560EX is able to delay the audio signal to the speakers closest to the listener. This effectively creates a perception of increased distance for those speakers. The listener can be placed at an equal distance between the left and right speakers for optimum staging.

The adjustment will be made for each speaker in a step of 0.1 ms.

### Example 1. Listening Position: Front Left Seat

Adjust the time correction level of the front left speaker to a high value and the rear right to zero or a low value.

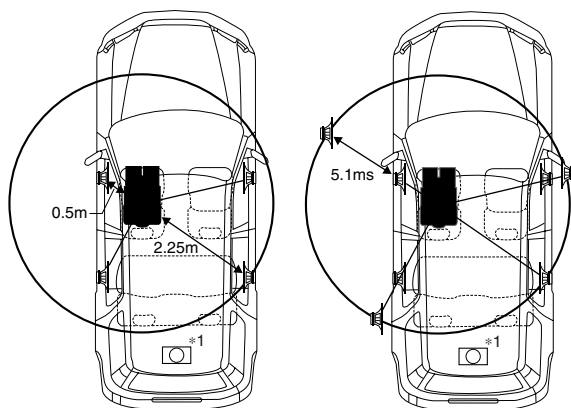

#### Tips

##### \*1 Subwoofer speaker.

You cannot change the Time Correction value for the subwoofer, but you can set the subwoofer's apparent position to the front by adjusting the Time Correction value of the front and rear speakers. For details, refer to the "Tips" on page 23.

Here we calculate the time correction value for the front left speaker in the diagram at the left.

#### Conditions:

Farthest Speaker – listening position: 2.25 m (88-9/16")  
Front left speaker – listening position: 0.5 m (19-11/16")  
Calculation:  $L = 2.25 \text{ m} - 0.5 \text{ m} = 1.75 \text{ m}$  (68-7/8")  
Time correction =  $1.75 \div 343^{*2} \times 1000 = 5.1$  (ms)

\*2 Speed of sound: 343 m/s (765 mph) at 20°C

In other words, giving the front left speaker a time correction value of 5.1 ms makes it seem as if the distance to the front left speaker is the same as the distance to the farthest speaker.

The sound is not balanced because the distance between the listening position and the various speakers is different. The difference in distance between the front left speaker and the rear right speaker is 1.75 m (68-7/8").

Time correction eliminates the differences in the time required for the sound to reach the listening position.

The time of the front left speaker is corrected by 5.1 ms so that its sound reaches the listening position at the same time as the sound of other speakers.

### Example 2. Listening Position: All Seats

Adjust the time correction level of each speaker to almost the same level.

- 1 Sit in the listening position (driver's seat, etc.) and measure the distance (in meters) between your head and the various speakers.**
- 2 Calculate the difference between the distance to the farthest speaker and the other speakers.**  
 $L = (\text{distance to farthest speaker}) - (\text{distance to other speakers})$
- 3 Divide the distances calculated for the speakers by the speed of sound (343 m/s (765 mph) at 20°C).**  
These values are the time correction values for the different speakers.



## Setting the Bass Focus

The time difference between the front-rear/left-right speakers, can be adjusted at the same time. With an initial delay of 0.1 ms for each of the 0 to 99 steps, audible time correction can be done.

### 1 Press **AUDIO TUNE**.

### 2 Press **◀** or **▶** within 15 seconds, select the **Bass Focus setting mode**, and press **▶/II / ENT.**

The mode that is blinking at the centre of the display is the selected mode.

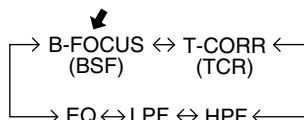

### 3 Press **◀** or **▶** within 15 seconds to adjust the front (left and right) speaker steps, then press **▶/II / ENT.** to set.

### 4 Repeat Step 3 and set another (speaker) channel.

Front (Left/Right) Speakers → Left (Front/Rear) Speakers → Right (Front/Rear) Speakers → Rear (Left/Right) Speakers

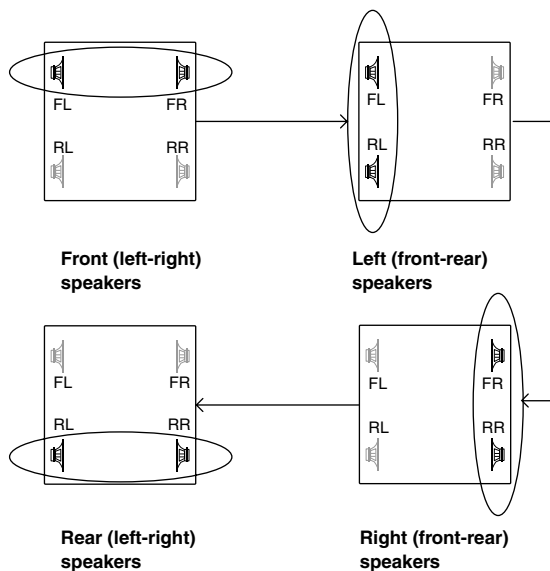

### 5 When finished with the settings, press **◀** or **▶**, select **EXIT**, and press **▶/II / ENT.**

Selection of CONTINUE will cause a return to the Bass Focus adjustment mode.

### 6 Press **AUDIO TUNE** and return to the normal mode.

- Any manual time correction adjustments will also affect corrections made in Bass Focus.
- Time Correction mode is automatically cancelled if no buttons are pressed within 15 seconds.

### Example of Steps 3 and 4 Setting

- (1) After entering corrections for the front (left and right) speakers in STEP 15, the time difference is 1.5 ms for both front-left and front-right speakers.

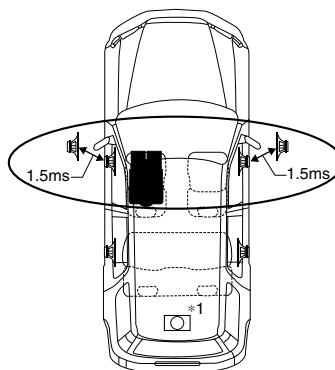

- (2) After entering corrections for the left (front and rear) speakers in STEP 15, the time difference becomes 3.0 ms\*2 for the front left speaker and 1.5 ms for the left rear speaker.

\*2 Because the time difference was already set to 1.5 ms for the front left speaker in STEP 1, the additional correction in STEP 15 makes the time difference of the front left speaker 3.0 ms.

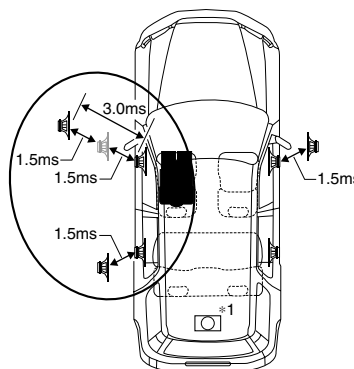

#### Tips

##### \*1 Subwoofer speaker.

Delay (press **◀** or **▶**) the audio signal to the front (left and right) speakers to make the apparent position of the subwoofer to be at the front. In doing this, the apparent position between the front (left and right) speakers and subwoofer will appear equal to the driver. After performing above, you can change the positions of left and right speakers by delaying the time.

## Time Difference Table

Number of Steps	Time Difference (ms)	Number of Steps	Time Difference (ms)	Number of Steps	Time Difference (ms)
0	0.0	14	1.4	28	2.8
1	0.1	15	1.5	29	2.9
2	0.2	16	1.6	30	3.0
3	0.3	17	1.7	31	3.1
4	0.4	18	1.8	32	3.2
5	0.5	19	1.9	33	3.3
6	0.6	20	2.0	34	3.4
7	0.7	21	2.1	35	3.5
8	0.8	22	2.2	36	3.6
9	0.9	23	2.3	37	3.7
10	1.0	24	2.4	38	3.8
11	1.1	25	2.5	39	3.9
12	1.2	26	2.6	40 - 98	4.0 - 9.8
13	1.3	27	2.7	99	9.9

## Time Correction Adjustment and Storage/Calling

Before performing the following procedures, refer to "About the Time Correction" (page 22).

### 1 Press **AUDIO TUNE**.

### 2 Press **◀** or **▶** within 15 seconds, select the time correction adjustment mode, and press **▶/II / ENT.**

The mode that is blinking at the centre of the display is the selected mode.

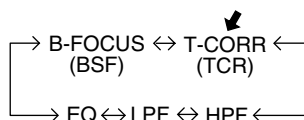

### 3 Press **◀** or **▶** within 15 seconds, select the **ADJUST** mode, and press **▶/II / ENT.**

The mode that is blinking at the centre of the display is the selected mode.

### 4 Press **◀** or **▶** within 15 seconds to adjust the time correction value (0.0 to 9.9) of the first speaker (F-L), then press **▶/II / ENT.** to set.

### 5 Repeat Step 4 and set another speaker.

F-L → F-R → R-L → R-R

### 6 When finished with the settings, press **◀** or **▶**, select **EXIT**, and press **▶/II / ENT.**

The mode that is blinking at the centre of the display is the selected mode.

- Selection of **CONTINUE** will cause a return to the time correction adjustment mode.
- Selection of **P-MEMORY** will set the storage mode of the adjustment value. (See "Storing the Adjustment Contents".)

### 7 Press **AUDIO TUNE** to return to the normal mode.

- The adjustment value in the time correction adjustment is also reflected in the **Bass Focus** mode.

## Storing the Adjustment Contents

### 1 Following Step 6 mentioned on the left within 15 seconds, press **◀** or **▶** to select **P-MEMORY**, then press **▶/II / ENT.**

The mode that is blinking at the centre of the display is the selected mode.

### 2 Press **◀** or **▶** within 15 seconds, select one of "PRESET 1" to "PRESET 6," and press **▶/II / ENT.**

This will store the adjusted contents in the selected PRESET number.

### 3 Press **AUDIO TUNE** to return to the normal mode.

- The contents stored in presets 1 to 6 will be maintained even when the unit is reset or the battery power cable is disconnected.

## Calling the Stored Time Correction Value

### 1 Following Step 3 mentioned on the left, press **◀** or **▶**, select the **SELECT** mode, and press **▶/II / ENT.**

The mode that is blinking at the centre of the display is the selected mode.

### 2 Press **◀** or **▶** within 15 seconds, select one of "PRESET 1" to "PRESET 6," and press **▶/II / ENT.**

This will call the stored adjustment contents.

# Other Functions

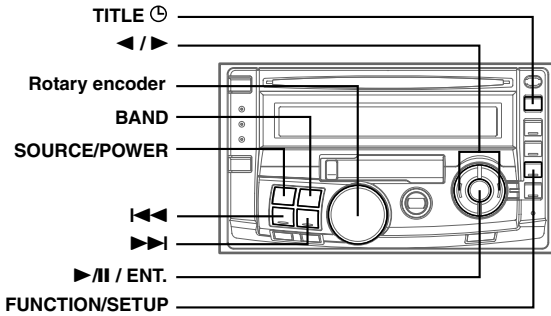

(MP3/WMA mode)

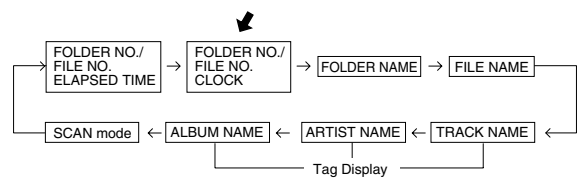

(Cassette mode)

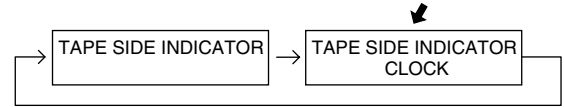

- Selecting any tuner, CD or cassette, etc. function while in the clock priority mode will interrupt the time display momentarily. The function selected will be displayed for about 5 seconds before the time returns to the display.
- When the power is off but the ignition key is on, press **TITLE** (with a clock icon) to display the time.

## Setting Time

- 1 Press **TITLE** (with a clock icon) repeatedly to set the time display mode. Then press and hold **TITLE** (with a clock icon) for at least 3 seconds. The time will blink and there will be entry to the adjustment mode.

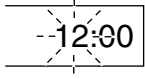

- 2 Press **◀** or **▶** within 5 seconds and adjust "Hours." Once "Hours" has been adjusted, press **▶/II / ENT.**
- 3 Press **◀** or **▶** within 5 seconds and adjust "Minutes." Once "Minutes" has been adjusted, press **▶/II / ENT.**

- The time can be adjusted in any mode (CD, cassette, radio, changer, etc.).
- To coordinate the time with a time signal, after the "Hours" setting press and hold **▶/II / ENT.** and the minutes display will be set to 00. When the display is beyond ":30," press and hold **▶/II / ENT.** and the "Hours" will advance.

## Displaying Time

Press **TITLE** (with a clock icon) repeatedly to select the time display mode.

(Radio mode)

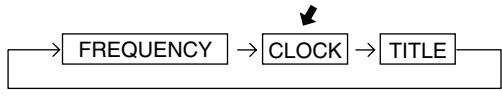

(CD mode)

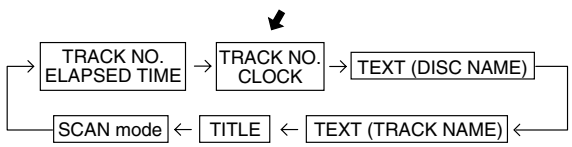

## Sound Guide Function

This function will give audible feedback with varying tones depending upon the button pressed.

- 1 Press **FUNCTION/SETUP** to select the **SETUP mode\***.  
\* See "About SETUP" on Page 6.
- 2 Press **◀** or **▶** to select the **BEEP mode**.
- 3 Press **▶/II / ENT.** to switch the **BEEP mode**.  
**BEEP ON** ↔ **BEEP OFF**  
(Initial setting)
- 4 After completing the setting, press **FUNCTION/SETUP** to return to the normal mode.

---

## Switching the Tuner Mode

---

This unit incorporates the MAX TUNE SQ for the highest quality tuner audio. Moreover, you can choose between three settings to suit your own personal sound preferences and usage.

- 1 Press **FUNCTION/SETUP** to select the **SETUP mode\***.  
\* See "About SETUP" on Page 6.
- 2 Press **◀** or **▶** to select the **TUNER mode**.
- 3 Press **▶/II / ENT.** to switch the **TUNER (FM) setting**.

→ NORMAL → HI-FI → STABLE ←  
(Initial setting)

NORMAL: Standard setting  
HI-FI: Sound quality priority setting  
STABLE: Noiseless priority setting

- 4 After completing the setting, press **FUNCTION/SETUP** to return to the normal mode.

- If you find the sound is very noisy while listening to the tuner in HI-FI mode, we recommend you change to Normal mode.

---

## Dimmer Control

---

Set the DIMMER control to AUTO to decrease the illumination brightness of the unit with the head lights of the vehicle ON. This mode is useful if you feel the unit's backlighting is too bright at night.

- 1 Press **FUNCTION/SETUP** to select the **SETUP mode\***.  
\* See "About SETUP" on Page 6.
- 2 Press **◀** or **▶** to select the **DIMMER mode**.
- 3 Press **▶/II / ENT.** to switch the **DIMMER setting**.  
**DIMMER AUTO ↔ DIMMER MANUAL**  
(Initial setting)
- 4 After completing the setting, press **FUNCTION/SETUP** to return to the normal mode.

- This will function only when the illumination cable of this unit is connected.

---

## Adjusting Display Contrast

---

You can adjust the display contrast for better visibility.

- 1 Press **FUNCTION/SETUP** to select the **SETUP mode\***.  
\* See "About SETUP" on Page 6.
- 2 Press **◀** or **▶** to select the **CONTRAST mode**.
- 3 Press **▶/II / ENT.** or turn the **Rotary encoder** to adjust the contrast.  
Adjustment is possible over levels -6 to +6.  
**CONTRAST ±0**  
(Initial setting)
- 4 After completing the setting, press **FUNCTION/SETUP** to return to the normal mode.

---

## Demonstration Function

---

This unit has a Demonstration feature which simulates the display and sound functions.

- 1 Press **FUNCTION/SETUP** to select the **SETUP mode\***.  
\* See "About SETUP" on Page 6.
- 2 Press **◀** or **▶** to select the **DEMO mode**.
- 3 Press **▶/II / ENT.** to set **DEMO ON**.  
↓  
**DEMO ON ↔ DEMO OFF**  
(Initial setting)
- 4 After completing the setting, press **FUNCTION/SETUP** and return to the normal mode.  
When the demonstration mode is used, be sure to cancel it when finished.

# External Device

## Subwoofer On and Off

- 1 Press **FUNCTION/SETUP** to select the **SETUP mode\***.  
\* See "About SETUP" on Page 6.
- 2 Press **◀** or **▶** to select the **SUBW. ON** or **OFF mode**.
- 3 Press **▶/II / ENT.** to set **SUBW. ON**.  
↓  
**SUBW. ON** ↔ **SUBW. OFF**  
(Initial setting)
- 4 After completing the setting, press **FUNCTION/SETUP** to return to the normal mode.
- 5 Press **Rotary encoder** to select the **SUBW. mode**.  
↓  
→ SUBW. → BALANCE → FADER  
← VOLUME ← DEFEAT ←  
  
Press **◀◀** or **▶▶** after selecting the Subwoofer mode, and the subwoofer output phase is toggled "NORMAL (PHASE 0°)" or "REVERSE (PHASE 180°)."
- 6 Turn the **Rotary encoder** within 5 seconds and adjust the level (0 to +15) of the subwoofer.
  - Once the mode is selected, failure to perform an operation within 5 seconds will result in cancellation of the adjustment mode.
  - The subwoofer output is a monaural output.

## Setting the AUX Mode (V-Link)

You can input TV/video sound by connecting an optional Ai-NET/ RCA Interface cable (KCA-121B) or Versatile Link Terminal (KCA-410C) to this component.

- 1 Press **FUNCTION/SETUP** to select the **SETUP mode\***.  
\* See "About SETUP" on Page 6.
- 2 Press **◀** or **▶** to select the **AUX IN mode**.
- 3 Press **▶/II / ENT.** to set to **ON**.  
↓  
**AUX IN OFF** ↔ **AUX IN ON**  
(Initial setting)
  - After setting **AUX IN** to **ON**, use **◀** or **▶** to select the **AUX display selection**, then press **▶/II / ENT.** which will allow setting of the **AUX mode "display."**
- 4 When the setting is completed, press **FUNCTION/SETUP** to return to the normal mode.

- 5 Press **SOURCE/POWER** to select the **AUX (external input) mode**.

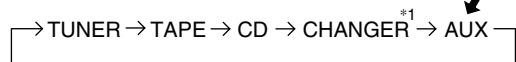

(\*1: Only when the changer is connected)

- When using the Versatile Link Terminal (KCA-410C), you can connect two external inputs. To select the mode, press **BAND** on the unit.

## Setting Tone Defeat for External Devices

When inputting external devices to this unit, turning tone defeat on will bypass EQ and MX, i.e., sound for external devices is output at the default setting.

- 1 Press **FUNCTION/SETUP** to select the **SETUP mode\***.  
\* See "About SETUP" on Page 6.
- 2 Press **◀** or **▶** to select the **INT AUDIO mode**.
- 3 Press **▶/II / ENT.** to set **INT AUDIO ON**.  
↓  
**INT AUDIO OFF** ↔ **INT AUDIO ON**  
(Initial setting)
- 4 When the setting is completed, press **FUNCTION/SETUP** to return to the normal mode.

## Turning Mute Mode On/Off

If a device having the interrupt feature is connected, audio will be automatically muted whenever the interrupt signal is received from the device. This function can be turned ON or OFF from the head unit by following procedure below.

- 1 Press **FUNCTION/SETUP** to select the **SETUP mode\***.  
\* See "About SETUP" on Page 6.
- 2 Press **◀** or **▶** to select the **INT MUTE mode**.
- 3 Press **▶/II / ENT.** to set **INT MUTE OFF**.  
↓  
**INT MUTE ON** ↔ **INT MUTE OFF**  
(Initial setting)
- 4 When the setting is completed, press **FUNCTION/SETUP** to return to the normal mode.

# Information

## In Case of Difficulty

If you encounter a problem, please review the items in the following checklist. This guide will help you isolate the problem if the unit is at fault. Otherwise, make sure the rest of your system is properly connected or consult your authorized Alpine dealer.

### Basic

#### No function or display.

- Vehicle's ignition is off.
  - If connected following instructions, the unit will not operate with the vehicle's ignition off.
- Improper power lead connections.
  - Check power lead connections.
- Blown fuse.
  - Check the fuse on the battery lead of the unit; replace with the proper value if necessary.
- Internal micro-computer malfunctioned due to interference noise etc.
  - Press the Reset switch with a ballpoint pen or other pointed article.

### Radio

#### Unable to receive stations.

- No aerial or open connection in cable.
  - Make sure the aerial is properly connected; replace the aerial or cable if necessary.

#### Unable to tune stations in the seek mode.

- You are in a weak signal area.
  - Make sure the tuner is in the DX mode.
- If the area you are in is a primary signal area, the aerial may not be grounded and connected properly.
  - Check your aerial connections; make sure the aerial is properly grounded at its mounting location.
- The aerial may not be the proper length.
  - Make sure the aerial is fully extended; if broken, replace the aerial with a new one.

#### Broadcast is noisy.

- The aerial is not the proper length.
  - Extend the aerial fully; replace it if it is broken.
- The aerial is poorly grounded.
  - Make sure the aerial is grounded properly at its mounting location.

### CD

#### CD Player/Changer not functioning.

- Out of operating temperature range +50°C (+120°F) for CD.
  - Allow the vehicle's interior (or trunk) temperature to cool.

#### CD playback sound is wavering.

- Moisture condensation in the CD Module.
  - Allow enough time for the condensation to evaporate (about 1 hour).

#### CD insertion not possible.

- A CD is already in the CD player.
  - Eject the CD and remove it.
- The CD is being improperly inserted.
  - Make sure the CD is being inserted following instructions in the CD Player Operation section.

#### Unable to fast forward or backward the CD.

- The CD has been damaged.
  - Eject the CD and discard it; using a damaged CD in your unit can cause damage to the mechanism.

#### CD playback sound skips due to vibration.

- Improper mounting of the unit.
  - Securely re-mount the unit.
- Disc is very dirty.
  - Clean the disc.
- Disc has scratches.
  - Change the disc.
- The pick-up lens is dirty.
  - Do not use a commercial available lens cleaner disc. Consult your nearest ALPINE dealer.

#### CD playback sound skips without vibration.

- Dirty or scratched disc.
  - Clean the disc; damaged disc should be replaced.

#### Error displays (built-in CD player only)

- Mechanical error
  - Press **CD** . After the error indication disappears, insert the disc again. If the above-mentioned solution does not solve the problem, consult your nearest ALPINE dealer.

#### CD-R/CD-RW playback not possible

- Close session (finalization) has not been performed.
  - Perform finalization and attempt playback again.

### MP3/WMA

#### MP3 or WMA is not played back.

- Writing error occurred. The CD format is not compatible.
  - Make sure the CD has been written in a supported format. Refer to "About MP3/WMA" (pages 12 to 13), then rewrite in the format supported by this device.

## Cassette

### Tape playback sounds dull.

- The tape head needs cleaning.
  - Clean the tape head.
- Incorrect Dolby NR in use.
  - Check Dolby NR switch setting.

## Indication for CD Head Unit





### HIGH-TEMP

- Protective circuit is activated due to high temperature.
  - The indicator will disappear when the temperature returns to within operation range.

### NO DISC

- No CD is inserted.
  - Insert a CD.

### ERROR

- Mechanism error.
  - 1) Press CD  to eject the CD.
    - If not ejecting, consult your Alpine dealer.
  - 2) When the error indication remains after ejecting, press CD  again.
    - If the error indication still does not turn off after pressing CD  for a few times, consult your Alpine dealer.
- When the "ERROR" is displayed:  
*In case that the disc cannot be ejected by pressing CD , press the Reset switch (refer to page 5) and press CD  again.  
If not ejecting, consult your Alpine dealer.*

### PROTECT

- A copy-protected WMA file was played back.
  - You can only play back non-copy-protected files.

### UNSUPPORT

- The disc is not written in a MP3/WMA supported format.
  - Use a disc written at the MP3/WMA supported format.

## Indication for CD Changer

### HIGH-TEMP

- Protective circuit is activated due to high temperature.
  - The indicator will disappear when the temperature returns to within operation range.

### ERROR-01

- Malfunction in the CD Changer.
  - Consult your Alpine dealer. Press the magazine eject button and pull out the magazine.  
Check the indication. Insert the magazine again.  
If the magazine cannot be pulled out, consult your Alpine dealer.
- Magazine ejection not possible.
  - Press the magazine eject button. If the magazine does not eject, consult your Alpine dealer.

### ERROR-02

- A disc is left inside the CD Changer.
  - Press the Eject button to activate the eject function. When the CD Changer finishes the eject function, insert an empty CD magazine into the CD Changer to receive the disc left inside the CD Changer.

### NO MAGZINE

- No magazine is loaded into the CD Changer.
  - Insert a magazine.

### NO DISC

- No indicated disc.
  - Choose another disc.

# Installation and Connections

For installation and connections to the CDA-W560EG, consult the dealer from whom you purchased it.

Before installing or connecting the unit, please read the following and pages 2 to 4 of this manual thoroughly for proper use.

## Warning

### MAKE THE CORRECT CONNECTIONS.

Failure to make the proper connections may result in fire or product damage.

### USE ONLY IN CARS WITH A 12 VOLT NEGATIVE GROUND.

(Check with your dealer if you are not sure.) Failure to do so may result in fire, etc.

### BEFORE WIRING, DISCONNECT THE CABLE FROM THE NEGATIVE BATTERY TERMINAL.

Failure to do so may result in electric shock or injury due to electrical shorts.

### DO NOT ALLOW CABLES TO BECOME ENTANGLED IN SURROUNDING OBJECTS.

Arrange wiring and cables in compliance with the manual to prevent obstructions when driving. Cables or wiring that obstruct or hang up on places such as the steering wheel, gear lever, brake pedals, etc. can be extremely hazardous.

### DO NOT SPLICE INTO ELECTRICAL CABLES.

Never cut away cable insulation to supply power to other equipment. Doing so will exceed the current carrying capacity of the wire and result in fire or electric shock.

### DO NOT DAMAGE PIPE OR WIRING WHEN DRILLING HOLES.

When drilling holes in the chassis for installation, take precautions so as not to contact, damage or obstruct pipes, fuel lines, tanks or electrical wiring. Failure to take such precautions may result in fire.

### DO NOT USE BOLTS OR NUTS IN THE BRAKE OR STEERING SYSTEMS TO MAKE GROUND CONNECTIONS.

Bolts or nuts used for the brake or steering systems (or any other safety-related system), or tanks should NEVER be used for installations or ground connections. Using such parts could disable control of the vehicle and cause fire etc.

### DO NOT INSTALL IN LOCATIONS WHICH MIGHT HINDER VEHICLE OPERATION, SUCH AS THE STEERING WHEEL OR GEARSHIFT.

Doing so may obstruct forward vision or hamper movement etc. and results in serious accident.

### DO NOT BLOCK VENTS OR RADIATOR PANELS.

Doing so may cause heat to build up inside and may result in fire.

## Caution

### HAVE THE WIRING AND INSTALLATION DONE BY EXPERTS.

The wiring and installation of this unit requires special technical skill and experience. To ensure safety, always contact the dealer where you purchased this product to have the work done.

### USE SPECIFIED ACCESSORY PARTS AND INSTALL THEM SECURELY.

Be sure to use only the specified accessory parts. Use of other than designated parts may damage this unit internally or may not securely install the unit in place. This may cause parts to become loose resulting in hazards or product failure.

### ARRANGE THE WIRING SO IT IS NOT CRIMPED OR PINCHED BY A SHARP METAL EDGE.

Route the cables and wiring away from moving parts (like the seat rails) or sharp or pointed edges. This will prevent crimping and damage to the wiring. If wiring passes through a hole in metal, use a rubber grommet to prevent the wire's insulation from being cut by the metal edge of the hole.

### DO NOT INSTALL IN LOCATIONS WITH HIGH MOISTURE OR DUST.

Avoid installing the unit in locations with high incidence of moisture or dust. Moisture or dust that penetrates into this unit may result in product failure.

## Precautions

- Be sure to disconnect the cable from the (-) battery post before installing your CDA-W560E. This will reduce any chance of damage to the unit in case of a short-circuit.
- Be sure to connect the colour coded leads according to the diagram. Incorrect connections may cause the unit to malfunction or damage to the vehicle's electrical system.
- When making connections to the vehicle's electrical system, be aware of the factory installed components (e.g. on-board computer). Do not tap into these leads to provide power for this unit. When connecting the CDA-W560E to the fuse box, make sure the fuse for the intended circuit of the CDA-W560E has the appropriate amperage. Failure to do so may result in damage to the unit and/or the vehicle. When in doubt, consult your ALPINE dealer.
- The CDA-W560E uses female RCA-type jacks for connection to other units (e.g. amplifier) having RCA connectors. You may need an adaptor to connect other units. If so, please contact your authorized ALPINE dealer for assistance.
- Be sure to connect the speaker (-) leads to the speaker (-) terminal. Never connect left and right channel speaker cables to each other or to the vehicle body.

### IMPORTANT

Please record the serial number of your unit in the space provided below and keep it as a permanent record. The serial number plate is located on the bottom of the unit.

SERIAL NUMBER: \_\_\_\_\_  
INSTALLATION DATE: \_\_\_\_\_  
INSTALLATION TECHNICIAN: \_\_\_\_\_  
PLACE OF PURCHASE: \_\_\_\_\_



## Installation

### Caution concerning the installation location

- 1 Before installing, check to make sure that the taking out and inserting of the disc will not interfere with operation of the gear shift.

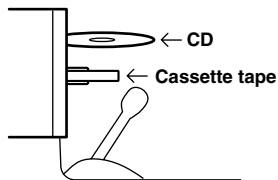

### 2 Angle of installation

Install at an angle of between horizontal and 35°. Note that installing at an angle outside of this range will result in a loss of performance and possibly damage.

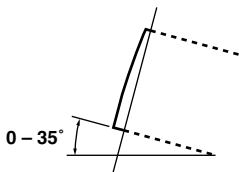

## Installation

Secure the ground lead of the unit to a clean metal spot using a screw (\*) already attached to the car's chassis.

Attach the Original Mounting Bracket to each side of the CDA-W560E, using the screws supplied with CDA-W560E.

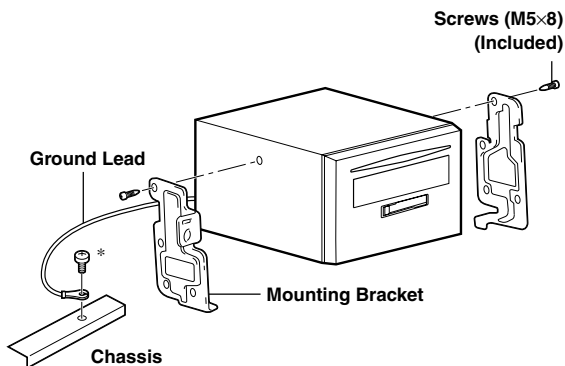

# Connections

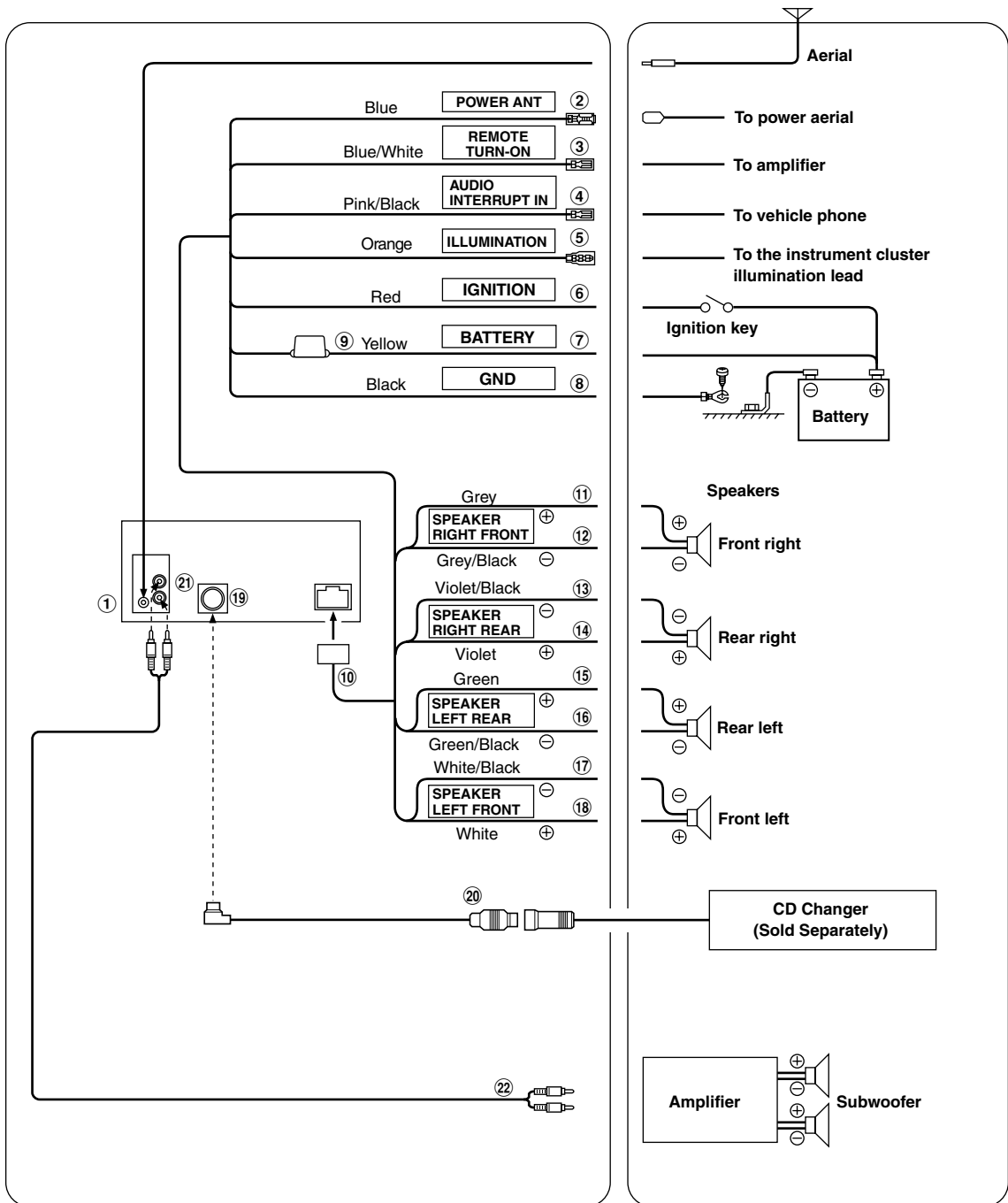

• For details on how to set the Subwoofer to ON/OFF, see "Subwoofer On and Off" on page 27.

- ① **Aerial Receptacle**
- ② **Power Aerial Lead (Blue)**  
Connect this lead to the +B terminal of your power aerial, if applicable.
- *This lead should be used only for controlling the vehicle's power aerial. Do not use this lead to remote-turn on an amplifier or a signal processor, etc.*
- ③ **Remote Turn-On Lead (Blue/White)**  
Connect this lead to the remote turn-on lead of your amplifier.
- ④ **Audio Interrupt In Lead (Pink/Black)**
- ⑤ **Illumination Lead (Orange)**  
This lead may be connected to the vehicle's instrument cluster illumination lead. This will allow the backlighting of the CDA-W560E to dim whenever the vehicle's lights are turned on.
- ⑥ **Switched Power Lead (Ignition) (Red)**  
Connect this lead to an open terminal on the vehicle's fuse box or another unused power source which provides (+)12V only when the ignition is turned on or in the accessory position.
- ⑦ **Battery Lead (Yellow)**  
Connect this lead to the positive (+) post of the vehicle's battery.
- ⑧ **Ground Lead (Black)**  
Connect this lead to a good chassis ground on the vehicle. Make sure the connection is made to bare metal and is securely fastened using the sheet metal screw provided.
- ⑨ **Fuse Holder (10A)**
- ⑩ **Power Supply Connector**
- ⑪ **Right Front (+) Speaker Output Lead (Grey)**
- ⑫ **Right Front (-) Speaker Output Lead (Grey/Black)**
- ⑬ **Right Rear (-) Speaker Output Lead (Violet/Black)**
- ⑭ **Right Rear (+) Speaker Output Lead (Violet)**
- ⑮ **Left Rear (+) Speaker Output Lead (Green)**
- ⑯ **Left Rear (-) Speaker Output Lead (Green/Black)**
- ⑰ **Left Front (-) Speaker Output Lead (White/Black)**
- ⑱ **Left Front (+) Speaker Output Lead (White)**
- ⑲ **Ai-NET Connector**  
Connect this to the output or input connector of other product (CD Changer, etc.) equipped with Ai-NET.
- *You can input TV/video sound by connecting an optional Ai-NET/ RCA Interface cable (KCA-121B) to this component.*
- ⑳ **Ai-NET Cable (Included with CD Changer)**
- ㉑ **Subwoofer RCA Connectors**  
RED is right and WHITE is left.
- ㉒ **RCA Extension Cable (Sold Separately)**

**To prevent external noise from entering the audio system.**

- Locate the unit and route the leads at least 10 cm away from the car harness.
- Keep the battery power leads as far away from other leads as possible.
- Connect the ground lead securely to a clean, bare metal spot (remove any paint, grease or dirt if necessary) of the car chassis.
- If you add an optional noise suppressor, connect it as far away from the unit as possible. Your Alpine dealer carries various noise suppressors. Contact them for further information.
- Your Alpine dealer knows best about noise prevention measures so consult your dealer for further information.

# Specifications

## **FM TUNER SECTION**

Tuning Range	87.5 – 108.0 MHz
Mono Usable Sensitivity	9.3 dBf (0.8 $\mu$ V/75 ohms)
50 dB Quieting Sensitivity	13.5 dBf (1.3 $\mu$ V/75 ohms)
Alternate Channel Selectivity	80 dB
Signal-to-Noise Ratio	80 dB
Stereo Separation	45 dB

## **AM TUNER SECTION**

Tuning Range	531 – 1,602 kHz
Sensitivity (IEC Standard)	22.5 $\mu$ V/27 dB

## **CD PLAYER SECTION**

Frequency Response	5 – 20,000 Hz ( $\pm$ 1 dB)
Wow & Flutter (% WRMS)	Below measurable limits
Dynamic Range	93 dB (at 1 kHz)
Signal-to-Noise Ratio	105 dB
Channel Separation	85 dB (at 1 kHz)

## **TAPE PLAYER SECTION**

Tape Speed	1-7/8 ips (4.8 cm/sec) $\pm$ 0.7%
Wow & Flutter	0.06% WRMS
Signal-to-Noise Ratio	
With Dolby B-TYPE NR	68 dB
Without Dolby NR	60 dB
Frequency Response	
With Alpine Test Tape	30-20,000Hz

## **GENERAL**

Power Requirement	14.4 V DC (11–16 V allowable)
Power Output	18 W RMS $\times$ 4*
* Primary amplifier ratings per CEA-2006 Standard	
• Power output: measured at 4 Ohms and $\leq$ 1% THD+N	
• S/N: 80 dBA (reference: 1 W into 4 Ohms)	
Maximum Pre-Output Voltage	2V/10 k ohms
Weight	2.2 kg (4 lbs. 14 oz)

## **CHASSIS SIZE**

Width	178 mm (7")
Height	100 mm (3-15/16")
Depth	160 mm (6-1/4")

## **NOSEPIECE SIZE**

Width	170 mm (6-11/16")
Height	96 mm (3-3/4")
Depth	28 mm (1-1/8")

- Due to continuous product improvement, specifications and design are subject to change without notice.

## Free Manuals Download Website

<http://myh66.com>

<http://usermanuals.us>

<http://www.somanuals.com>

<http://www.4manuals.cc>

<http://www.manual-lib.com>

<http://www.404manual.com>

<http://www.luxmanual.com>

<http://aubethermostatmanual.com>

Golf course search by state

<http://golfingnear.com>

Email search by domain

<http://emailbydomain.com>

Auto manuals search

<http://auto.somanuals.com>

TV manuals search

<http://tv.somanuals.com>