



EN

CH

CDM-7854E CDE-7853E

FM/AM Compact Disc Receiver

- OWNER'S MANUAL
Please read before using this equipment.
- 用戶說明書
使用本設備之前，一定請先閱讀。

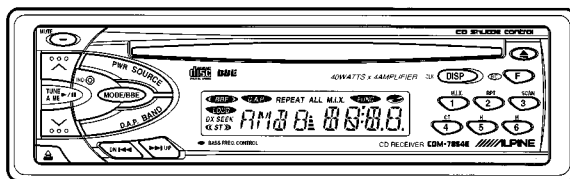

(CDM-7854E)

ALPINE ELECTRONICS, INC.
Tokyo office: 1-1-8 Nishi Gotanda,
Shinagawa-ku,
Tokyo 141-8501, Japan
Tel.: (03) 3494-1101

ALPINE ELECTRONICS OF AMERICA, INC.
19145 Gramercy Place, Torrance,
California 90501, U.S.A.
Tel.: 1-800-ALPINE-1 (1-800-257-4631)

ALPINE ELECTRONICS OF CANADA, INC.
Suite 203, 7300 Warden Ave. Markham,
Ontario L3R 9Z6, Canada
Tel.: 1-800-ALPINE-1 (1-800-257-4631)

ALPINE ELECTRONICS OF AUSTRALIA PTY. LTD.
6-8 Fiveways Boulevard Keysborough,
Victoria 3173, Australia
Tel.: (03) 9769-0000

ALPINE ELECTRONICS GmbH
Kreuzerkamp 7-11 40878 Ratingen, Germany
Tel.: 02102-45 50

ALPINE ITALIA S.p.A.
Via C. Colombo 8, 20090 Trezzano Sul Naviglio
MI, Italy
Tel.: 02-48 47 81

ALPINE ELECTRONICS FRANCE S.A.R.L.
(RCS PONTOISE B 338 101 280)
98, Rue De La Belle Etoile, Z.I. Paris Nord II
B.P. 50016 F-95945, Roissy, Charles De Gaulle
Cedex, France
Tel.: 01-48 63 89 89

ALPINE ELECTRONICS OF U.K., LTD.
13 Tanners Drive, Blakelands, Milton Keynes
MK14 5BU, U.K.
Tel.: 01908-61 15 56

ALPINE ELECTRONICS DE ESPAÑA, S.A.
Portal De Gamarra 36, Pabellón 32
01013 Vitoria (Alava)-Apdo. 133, Spain
Tel.: 34-45-283588

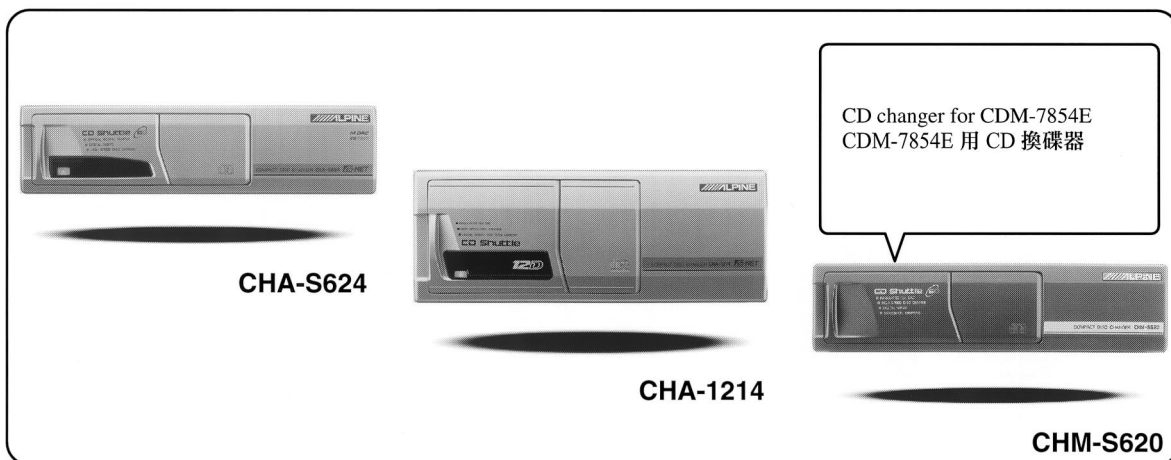

Alpine CD Changers Give You More!

More musical selections, more versatility, more convenience.

An Alpine CD Changer adds more musical choices to your sound system. All models can be controlled from Alpine head units and deliver excellent sound quality. The CHA-S624 is a high-performance 6-disc changer with a new M DAC, Ai-NET compatibility, Optical Digital Output, 150 Disc Title Memory and CD TEXT. The CHA-1214 Ai-NET model holds 12 discs, and the CHM-S620 M-Bus model is a super-compact 6-disc changer.

Alpine CD 換碟器讓您更加滿意！

更多音樂選項，更多功能性，更佳方便性。

Alpine CD 換碟器增添了更多樂聲系統選項。所有的型號都能從 Alpine 主機加以控制而產生極佳音質的音響。CHA-S624 是一個高性能，具新型 MDAC，Ai-NET 兼容的 6 碟式換碟器。可作光頻數字輸出、150 唱碟標題存儲和 CD TEXT。CHA-1214 Ai-NET 型號保持 12 張唱碟，而 CHM-S620M-Bus 型號是一個超小型的 6 碟式換碟器。

Contents

Operating Instructions

WARNING

| | |
|-------------------|---|
| WARNING | 2 |
| CAUTION | 2 |
| PRECAUTIONS | 2 |

Basic Operation

| | |
|--|---|
| Detaching the Front Panel | 4 |
| Attaching the Front Panel | 4 |
| Initial System Start-Up | 4 |
| Turning Power On and Off | 4 |
| Subwoofer On and Off (CDM-7854E only) | 5 |
| Adjusting Volume/Bass/Treble/ Balance (Between Left and Right)/ Fader (Between Front and Rear) | 5 |
| Turning Loudness On/Off (CDE-7853E only) . | 5 |
| Audio Mute Function | 5 |
| BBE Mode On/Off (CDM-7854E only) | 5 |
| Setting Bass Frequency | 5 |
| Displaying Time | 6 |
| Setting Time | 6 |

Radio Operation

| | |
|--|---|
| Manual Tuning | 7 |
| Automatic Seek Tuning | 7 |
| Manual Storing of Station Presets | 8 |
| Automatic Memory of Station Presets | 8 |
| Storing into Direct Access Preset (D.A.P.) Band | 9 |
| Tuning to Preset Stations | 9 |

CD Player Operation

| | |
|---|----|
| Inserting/Ejecting Disc | 10 |
| Normal Play and Pause | 10 |
| Music Sensor (Skip)..... | 10 |
| Fast Forward and Backward | 10 |
| Repeat Play | 11 |
| M.I.X. (Random Play) | 11 |
| Scanning Programmes | 11 |
| Controlling CD Changer (Optional) (CDM-7854E only) | 11 |

Information

| | |
|-----------------------------|----|
| In Case of Difficulty | 12 |
| Specifications | 13 |

Installation and Connections

| | |
|--------------------|----|
| Warning | 14 |
| Caution | 14 |
| Precautions | 14 |
| Installation | 15 |
| Connections | 16 |

WARNING

WARNING

The exclamation point within an equilateral triangle and "WARNING" are intended to alert the user to the presence of important operating instructions.
Failure to heed the instructions will result in severe injury or death.

DO NOT DISASSEMBLE OR ALTER.

Doing so may lead to accident, fire or electric shock.

KEEP SMALL ARTICLES OUT OF THE REACH OF CHILDREN.

If swallowed, consult a physician immediately.

USE THE CORRECT AMPERE RATING WHEN REPLACING FUSES.

Failure to do so may result in fire or electric shock.

HALT USE IMMEDIATELY IF A PROBLEM APPEARS.

When problems occur such as a lack of sound or video, foreign objects inside the unit, smoke coming out, or noxious odors, stop use immediately and contact the dealer where you bought the equipment. Failure to do so may result in an accident or injury.

DO NOT OPERATE THE EQUIPMENT OR LOOK AT THE SCREEN WHILE DRIVING THE VEHICLE.

Operating the equipment may distract the driver from looking ahead of the vehicle and cause accident. Always stop the vehicle in a safe location before operating this equipment.

DO NOT RAISE THE VOLUME EXCESSIVELY.

Keep the volume at a level where you can still hear outside noises while driving. Driving while unable to hear outside noises could be the cause of accident.

DO NOT USE THIS EQUIPMENT FOR PURPOSES OTHER THAN STATED FOR THE VEHICLE.

Failure to do so may result in electric shock or injury.

DO NOT PLACE FOREIGN OBJECTS IN INSERTION SLOTS OR GAPS.

Do not insert hands, fingers or foreign objects in the disc or cassette insertion slots, or in gaps during monitor startup/storage. Doing so may result in personal injury or damage to the equipment.

CAUTION

The exclamation point within an equilateral triangle and "CAUTION" are intended to alert the user to the presence of important operating instructions.
Failure to heed the instructions can result in injury or material damage.

DO NOT BLOCK VENTS OR RADIATOR PANELS.

Blocking them may cause heat to build up inside and may result in fire.

STOP THE VEHICLE IF UNIT OPERATION MIGHT INTERFERE WITH DRIVING.

PRECAUTIONS

Temperature

Be sure the temperature inside the vehicle is between +60°C (+140°F) and -10°C (+14°F) before turning your unit on.

Moisture Condensation

You may notice the CD playback sound wavering due to condensation. If this happens, remove the disc from the player and wait about an hour for the moisture to evaporate.

Damaged Disc

Do not attempt to play cracked, warped, or damaged discs. Playing a bad disc could severely damage the playback mechanism.

Maintenance

If you have problems, do not attempt to repair the unit yourself. Return it to your Alpine dealer or the nearest Alpine Service Station for servicing.

Never Attempt the Following

Do not grip or pull out the disc while it is being pulled back into the player by the automatic reloading mechanism.

Do not attempt to insert a disc into the unit when the unit power is off.

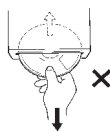

Inserting Discs

Your player accepts only one disc at a time for playback. Do not attempt to load more than one disc.

Make sure the label side is facing up when you insert the disc. Your player will automatically eject any disc that is inserted incorrectly. If the player continues to eject a correctly inserted disc, push the Reset switch (located behind the detachable front panel) with a pointed object such as a ball-point pen.

Playing a disc while driving on a very bumpy road may result in skips, but this will not scratch the disc or damage the player.

New Discs

As a protective measure to prevent the CD from jamming, the CD player will automatically eject discs with irregular surfaces or inserted incorrectly. When a new disc is inserted into the player and ejected after initial loading, using your finger, feel around the inside of the centre hole and outside edge of the disc. If you feel any small bumps or irregularities, this could inhibit proper loading of the disc. To remove the bumps, rub the inside edge of the hole and outside edge of the disc with a ball-point pen or other such instrument, then insert the disc again.

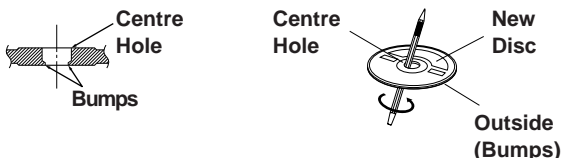

Irregular Shaped Discs

Be sure to use round shape discs only for this unit and never use any special shape discs.

Use of special shape discs may cause damage to the mechanism.



Installation Location

Make sure the CDM-7854E/CDE-7853E will not be installed in a location subjected to:

- Direct sun and heat
- High humidity and water
- Excessive dust
- Excessive vibrations

Handling the Detachable Front Panel

- Do not expose to rain or water.
- Do not drop or apply shock.

Correct Handling

Do not drop the disc while handling. Hold the disc so you will not leave fingerprints on the surface. Do not affix tape, paper, or gummed labels to the disc. Do not write on the disc.

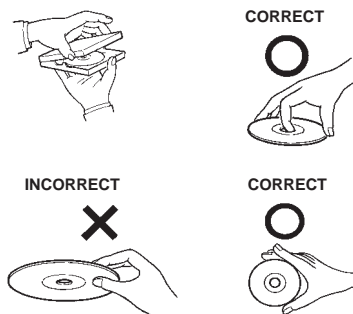

Disc Cleaning

Fingerprints, dust, or soil on the surface of the disc could cause the CD player to skip. For routine cleaning, wipe the playing surface with a clean, soft cloth from the centre of the disc to the outer edge. If the surface is heavily soiled, dampen a clean, soft cloth in a solution of mild neutral detergent before cleaning the disc.



Disc Accessories

There are various accessories available on the market for protecting the disc surface and improving sound quality. However, most of them will influence the thickness and/or diameter of the disc. Using such accessories can cause the disc to be out of standard specifications and may create operational problems. We recommend not using these accessories on discs played in Alpine CD players.



Basic Operation

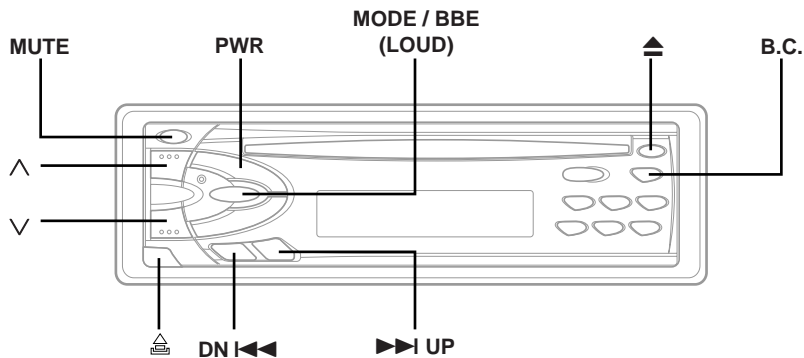

Detaching the Front Panel

- 1 Press the **PWR** (Power) button for more than 3 seconds to turn off the power.
- 2 Press the  (Release) button at lower left corner until the front panel pops out.
- 3 Grasp the left side of the front panel and pull it out.

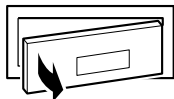

NOTES

- The front panel may become hot in normal usage (especially the connector terminals), this is not malfunction.
- To protect the front panel, place it in the supplied carrying case.

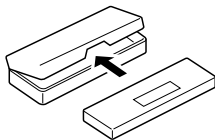

Attaching the Front Panel

- 1 First, insert the right side of the front panel into the main unit. Align the 2 small holes on the front panel with the 2 projections on the main unit.
- 2 Push the left side of the front panel until it locks firmly into the main unit.

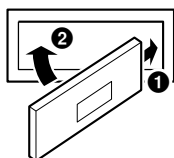

NOTE

Before attaching the front panel, make sure that there is no dirt or dust on the connector terminals and no foreign object between the front panel and the main unit.

Initial System Start-Up

Immediately after installing or applying power to the unit, it should be initialized. To do this, first, remove the detachable front panel. Behind the front panel, to the right of the connector, there is a small hole. Using a pencil or other pointed object, press the red reset switch mounted behind this hole to complete the initialization procedure.

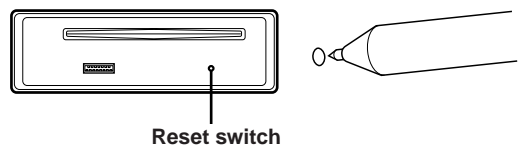

Turning Power On and Off

- 1 Press the **PWR** (Power) button to turn on the unit.

NOTE

The unit can be turned on by pressing any other button except the eject  button.

The volume level gradually increases to the previous level you were listening to before the unit was turned off. Press the PWR button for more than 3 seconds to turn off the unit.

NOTE

The very first time the power is turned on, the volume will start from level 12, the BBE will be on in the tuner mode*, and the LOUD function will be on**.

* CDM-7854E only.

** CDE-7853E only.

Subwoofer On and Off (CDM-7854E only)

- 1 Press and hold the **▲** (Eject) button for at least 3 seconds.
With each press, subwoofer is toggled On or Off.

NOTES

- Initial mode is "Subwoofer OFF."
- Set to "Subwoofer OFF" unless the subwoofer is used.
- When the subwoofer is turned on, the subwoofer output level can be adjusted. For more details, refer to the Adjusting Volume/Bass/Treble/Balance/Fader.

Adjusting Volume/Bass/Treble/Balance (Between Left and Right)/Fader (Between Front and Rear)

- 1 Press the **MODE** button repeatedly to choose the desired mode.
Each press changes the modes as follows:

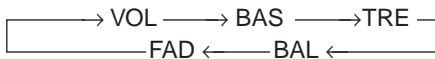

NOTES

- If the **∨** or **∧** button is not pressed in 5 seconds after selecting the **BASS**, **TREBLE**, **BALANCE**, or **FADER** mode, the unit automatically sets in the **VOLUME** mode.
 - When the subwoofer is set to **ON**, the level of the subwoofer can be adjusted (CDM-7854E only).
- 2 Press the **∨** and **∧** buttons until the desired sound is obtained in each mode.

NOTE

The settings of the Bass and Treble will be individually memorized for each source (FM, AM and CD) until the setting is changed. Depending on the connected devices, some functions and display indications do not work.

Turning Loudness On/Off (CDE-7853E only)

Loudness introduces a special low- and high-frequency emphasis at low listening levels. This compensates for the ear's decreased sensitivity to bass and treble sound.

- 1 Press and hold the **LOUD** button for at least 2 seconds to activate or deactivate the loudness mode.
The display shows "LOUD" when the loudness mode is activated.

Audio Mute Function

Activating this function will instantly lower the volume level by 20 dB.

- 1 Press the **MUTE** button to activate the MUTE mode. The audio level will decrease by about 20 dB.
Pressing the MUTE button again will bring the audio back to its previous level.

BBE Mode On/Off (CDM-7854E only)

The BBE (Barcus Berry Electronics) processor installed in this unit is designed to correct the phase distortion inherent in most loudspeaker designs. Ensuring the phase integrity of the signal driving the speakers improves the accurate reproduction of the sound.

- 1 Press and hold the **BBE** button for at least 2 seconds to turn on the BBE mode.
Each press toggles between the BBE on and off modes.

Setting Bass Frequency

The bass control centre frequency can be set at 60, 80, 100 or 200 Hz.

- 1 Press and hold the **B.C.** (Bass Control) button for at least 3 seconds to turn on the bass control settings.
- 2 Press the **DN** **◀◀** or the **▶▶** **UP** button to select the desired Bass centre frequency.
Each press changes the centre frequency as follows: 60 Hz, 80 Hz, 100 Hz and 200 Hz.

NOTE

If no buttons are pressed within 5 seconds, the bass control settings will be turned off automatically.

- 3 Press the **B.C.** (Bass Control) button for more than 3 seconds to turn off the bass control settings.

Basic Operation

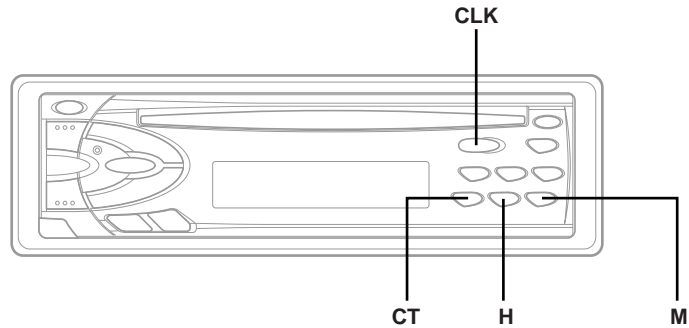

Displaying Time

- 1 Press the **CLK** (clock) button repeatedly until the clock time is displayed.
Each press changes the modes as follows:

Radio mode.

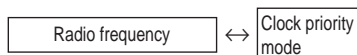

CD Player/Changer(CDM-7854E only) modes

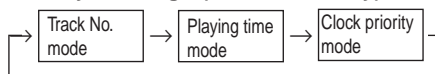

Setting Time

- 1 While the clock time is displayed, press and hold the **CLK** (clock) button for at least 3 seconds.
The time indication will begin to blink.
- 2 Press the **CT** button while the time indication is blinking to set seconds to "0".
- 3 Press the **"H"** button to adjust the hours while the time indication is blinking.
- 4 Press the **"M"** button to adjust the minutes while the time indication is blinking.
The time indication will stop blinking 5 seconds after the last adjustment. The time will automatically be set.

Radio Operation

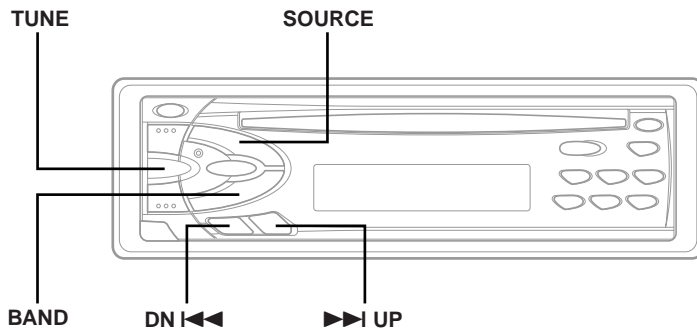

Manual Tuning

- 1 Press the **SOURCE** button until a radio frequency appears in the display.
- 2 Press the **BAND** button repeatedly until the desired radio band is displayed. Each press changes the band:

→ F1 → F2 → AM →

- 3 Press the **TUNE** button repeatedly until "DX SEEK" and "SEEK" disappear from the display.

NOTE

The initial mode is DX SEEK.

- 4 Press the **DN I<<<** or **>>> I UP** button to move downward or upward one step respectively until the desired station frequency is displayed.

NOTE

The ST indicator appears on the display when a Stereo FM station is tuned in.

Automatic Seek Tuning

- 1 Press the **SOURCE** button until a radio frequency appears in the display.
- 2 Press the **BAND** button repeatedly until the desired radio band is displayed. Each press changes the band:

→ F1 → F2 → AM →

- 3 Press the **TUNE** button to illuminate the DX and SEEK indicators in the display. With the DX (Distance) mode activated, both strong and weak stations will be tuned in the Auto-Seek operation. Press again to return to the local mode. The DX indicator will turn off and the SEEK indicator will remain illuminated. Now, only strong stations will be tuned.
- 4 Press the **DN I<<<** or **>>> I UP** button to automatically seek for a station downward or upward respectively. The unit will stop at the next station it finds. Press the same button again to seek the next station.

Radio Operation

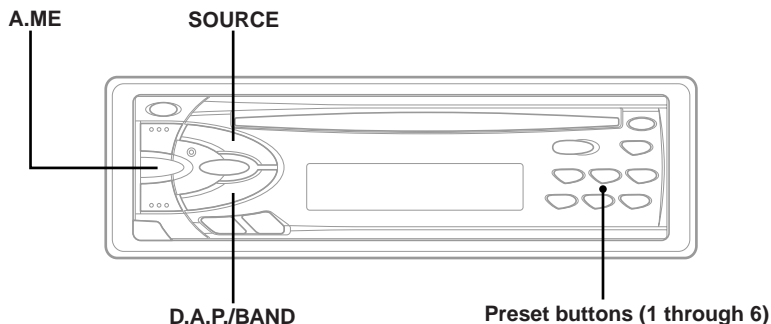

Manual Storing of Station Presets

- 1 Select the radio band and tune in a desired radio station you wish to store in the preset memory.
- 2 Press and hold any one of the **Preset buttons (1 through 6)** for at least 2 seconds until the station frequency on the display blinks.
- 3 Press the **Preset** button into which you wish to store the station while the frequency display is blinking (within 5 seconds). The display stops blinking once the station has been memorized. The display shows the band, preset No. with a triangle (\triangle) and station frequency memorized.
- 4 Repeat the procedure to store up to 5 other stations onto the same band. To use this procedure for other bands, simply select the band desired and repeat the procedure. A total of 24 stations can be stored in the preset memory (6 stations for each band; FM1, FM2, AM and D.A.P.).

NOTE

If you store a station in a preset memory which already has a station, the current station will be cleared and replaced with the new station.

Automatic Memory of Station Presets

- 1 Press the **SOURCE** button to select the radio mode.
- 2 Press the **BAND** button repeatedly until the desired radio band is displayed.
- 3 Press and hold the **A. ME** button for at least 2 seconds. The frequency on the display continues to change while the automatic memory is in progress. The tuner will automatically seek and store 6 strong stations in the selected band. They will be stored into presets 1 to 6 buttons in order of signal strength. When the automatic memory has been completed, the tuner goes to the station stored in the preset location No. 1.

NOTE

If no stations are stored, the tuner will return to the original station you were listening to before the auto memory procedure began.

Storing into Direct Access Preset (D.A.P.) Band

A combination of radio stations in any band (up to 6 stations) can be manually preset into the D.A.P. band.

- 1 Press and hold the **D.A.P.** button for more than 2 seconds until the D.A.P. indicator appears.

Press the **BAND** button to select FM or AM.

The selected band will be displayed.

To memorize stations onto the D.A.P. band, follow the steps for the Automatic or Manual Storing of Station Presets section above.

NOTE

This function can be used together with the Automatic Memory Preset.

To cancel the D.A.P. mode, press and hold the D.A.P. button for more than 2 seconds. The D.A.P. indicator will turn off.

Tuning to Preset Stations

- 1 Press the **SOURCE** button to select the radio mode.
- 2 Press the **BAND** button repeatedly until the desired band is displayed.

To select the D.A.P. band, press and hold the D.A.P. button for more than 2 seconds until the D.A.P. indicator appears in the display.
- 3 Press the station preset button that has your desired radio station in memory.

The display shows the band, preset number with a triangle and frequency of the station selected.

CD Player Operation

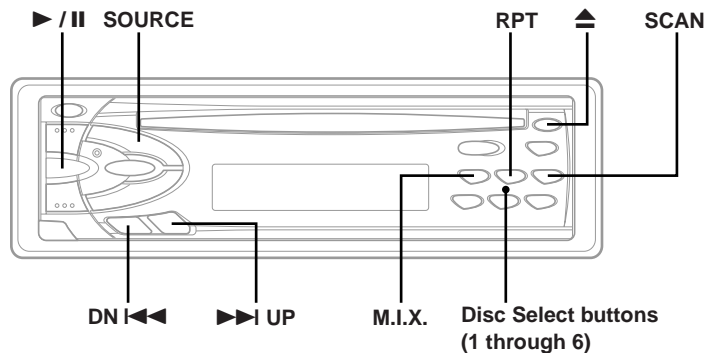

Inserting/Ejecting Disc

- 1 Insert a CD half way into the slot with the label side facing up. The player automatically draws the disc into the disc compartment.

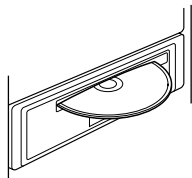

The Disc indicator appears to show that a disc is loaded.

NOTE

Three-inch (8cm) CD's can be used.

- 2 Press the ▲(Eject) button when you want to eject the CD.

NOTES

- If the CD is not removed for several seconds after it has been ejected, the player automatically draws the CD into the compartment to protect the CD.
- Only compact discs containing the mark shown can be used.



- We cannot fully guarantee the playback of CD-R (CD-Recordable). You cannot playback CD-RW (CD-ReWritable) on this unit.

Normal Play and Pause

- 1 Insert a CD. The CD player begins playback from the first track on the disc.

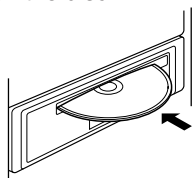

The display shows the track number and elapsed time of the track being played. When the last track is played back the player returns to the first track and begins playback from that point.

If a CD is already loaded in the CD player, press the SOURCE button to select the CD mode.

- 2 Press the ►|| button to temporarily stop CD playback. To resume playback, press the ►|| button again.

Music Sensor (Skip)

- 1 Momentarily press the DN I<<< button once during CD play to return to the beginning of the current track. If you wish to access the beginning of a track further back, repeatedly press until you reach the desired track.

Press the ►►I UP button once to advance to the beginning of the next track. If you wish to access the beginning of a track further ahead, press repeatedly until the desired track is reached.

NOTE

The music sensor feature is functional in the play or pause mode.

Fast Forward and Backward

- 1 Press and hold the DN I<<< or ►►I UP button to quickly move backward or forward until you reach the desired section of the track.

Repeat Play

- 1 Press the **RPT**(Repeat) button to play back repeatedly the track being played.
The RPT indicator appears and the track will be played repeatedly.

Press the RPT button again and select OFF to deactivate the repeat play.

NOTE

If a CD Changer is connected and the RPT ALL mode is selected, the unit repeatedly plays back all tracks on the disc selected (CDM-7854E only).

→ REPEAT → REPEAT ALL → OFF →

NOTE

In case a 6-disc CD changer is connected (CDM-7854E only):

Press the "F" button to illuminate the "FUNC" indicator and go to step 1.

M.I.X. (Random Play)

- 1 Press the **M.I.X.** button in the play or pause mode.
The M.I.X. indicator will illuminate and the tracks on the disc will be played back in a random sequence. After all the tracks on the disc have been played back once, the player will begin a new random sequence play until the M.I.X. mode is cancelled.

To cancel M.I.X. play, press the M.I.X. button again to turn off the M.I.X.

NOTE

In case a 6-disc CD changer is connected (CDM-7854E only):

Press the "F" button to illuminate the "FUNC" indicator and go to step 1.

Scanning Programmes

- 1 Press the **SCAN** button to activate the Scan mode.
The first 10 seconds of each track will be played back in succession.

To stop scanning, press the SCAN button and deactivate the Scan mode.

NOTE

In case a 6-disc CD changer is connected (CDM-7854E only):

Press the "F" button to illuminate the "FUNC" indicator and go to step 1.

Controlling CD Changer (Optional) (CDM-7854E only)

If an optional Alpine 6-disc CD Changer is connected to the 8-pin DIN connector (M-Bus) of the CDM-7854E, you can control the CD changer using the CDM-7854E.

NOTE

The CD controls on the CDM-7854E for the CD changer operation are functional only when the CD Changer is interconnected with the CDM-7854E.

- 1 Press the **SOURCE** button to activate the changer mode.
The display shows the disc number and track number.
- 2 Press the **Disc Select buttons (1 through 6)** corresponding to one of the discs loaded in the CD Changer. The selected disc number appears in the display and CD playback starts.

NOTES

- *After selecting the desired disc, you can operate in the same way as for the CDM-7854E CD player. For details, please see the CD Player Operation section.*
- *If the "FUNC" indicator is illuminated the Disc Select buttons become nonfunctional.*

Information

In Case of Difficulty

If you encounter a problem, please review the items in the following checklist. This guide will help you isolate the problem if the unit is at fault. Otherwise, make sure the rest of your system is properly connected or consult your authorized Alpine dealer.

Basic

No function or display.

- Vehicle's ignition is off.
 - If connected following instructions, the unit will not operate with the vehicle's ignition off.
 - Improper power lead connections.
 - Check power lead connections.
 - Blown fuse.
 - Check the fuse on the battery lead of the unit; replace with the proper value if necessary.
 - Internal micro-computer malfunctioned due to interference noise etc.
 - Press the Reset button with a ball-point pen or other pointed article.
-

Radio

Unable to receive stations.

- No antenna or open connection in cable.
 - Make sure the antenna is properly connected; replace the antenna or cable if necessary.

Unable to tune stations in the seek mode.

- You are in a weak signal area.
 - Make sure the tuner is in the DX mode.
- If the area you are in is a primary signal area, the antenna may not be grounded and connected properly.
 - Check your antenna connections; make sure the antenna is properly grounded at its mounting location.
- The antenna may not be the proper length.
 - Make sure the antenna is fully extended; if broken, replace the antenna with a new one.

Broadcast is noisy.

- The antenna is not the proper length.
 - Extend the antenna fully; replace it if it is broken.
 - The antenna is poorly grounded.
 - Make sure the antenna is grounded properly at its mounting location.
-

CD

CD Player/Changer not functioning.

- Out of operating temperature range +50°C (+120°F) for CD.
 - Allow the vehicle's interior (or trunk) temperature to cool.

CD playback sound is wavering.

- Moisture condensation in the CD Module.
 - Allow enough time for the condensation to evaporate (about 1 hour).

CD insertion not possible.

- A CD is already in the CD player.
 - Eject the CD and remove it.
- The CD is being improperly inserted.
 - Make sure the CD is being inserted following instructions in the CD Player Operation section.

Unable to fast forward or backward the CD.

- The CD has been damaged.
 - Eject the CD and discard it; using a damaged CD in your unit can cause damage to the mechanism.

CD playback sound skips due to vibration.

- Improper mounting of the unit.
 - Securely re-mount the unit.
- Disc is very dirty.
 - Clean the disc.
- Disc has scratches.
 - Change the disc.

CD playback sound skips without vibration.

- Dirty or scratched disc.
 - Clean the disc; damaged disc should be replaced.

Error displays (built-in CD player only)

- Mechanical error
 - Press the ▲ button. After the error indication disappears, insert the disc again. If the above-mentioned solution does not solve the problem, consult your nearest ALPINE dealer.

Indication for CD Changer

---H

- Protective circuit is activated due to high temperature.
 - The indicator will disappear when the temperature returns to within operation range.

E - 01

- Malfunction in the CD Changer.
 - Consult your Alpine dealer. Press the magazine eject button and pull out the magazine. Check the indication. Insert the magazine again. If the magazine cannot be pulled out, consult your Alpine dealer.
- Magazine ejection not possible.
 - Press the magazine eject button. If the magazine does not eject, consult your Alpine dealer.

- No magazine is loaded into the CD Changer.
 - Insert a magazine.

T-----

- No indicated disc.
 - Choose another disc.

EEEE

- Misconnection or disconnection of CD Changer.
 - Check connection between CD Changer and control unit.

Specifications

FM TUNER SECTION

| | |
|-------------------------------|--------------------------------|
| Tuning Range | 87.5 – 108 MHz |
| Mono Usable Sensitivity | 9.3 dBf (0.8 μ V/75 ohms) |
| 50 dB Quieting Sensitivity | 13.5 dBf (1.3 μ V/75 ohms) |
| Alternate Channel Selectivity | 80 dB |
| Signal-to-Noise Ratio | 65 dB |
| Stereo Separation | 35 dB |

AM TUNER SECTION

| | |
|----------------------------|--------------------|
| Tuning Range | 531 – 1,602 kHz |
| Sensitivity (IEC Standard) | 22.5 μ V/27 dB |

CD PLAYER SECTION

| | |
|---------------------------|-----------------------------|
| Frequency Response | 5 – 20,000 Hz (\pm 1 dB) |
| Wow & Flutter (% WRMS) | Below measurable limits |
| Total Harmonic Distortion | 0.008% (at 1 kHz) |
| Dynamic Range | 95 dB (at 1 kHz) |
| Signal-to-Noise Ratio | 105 dB |
| Channel Separation | 85 dB (at 1 kHz) |

GENERAL

| | |
|----------------------------|----------------------------------|
| Power Requirement | 14.4 V DC (11–16 V allowable) |
| Maximum Power Output | 40 W \times 4 |
| Maximum Pre-Output Voltage | 2 V/10 k ohms |
| Bass | \pm 14 dB at 30 Hz |
| Treble | \pm 14 dB at 10 kHz |
| Weight | 1.5 kg (3 lbs. 5 oz) |

CHASSIS SIZE

| | |
|--------|-----------------|
| Width | 178 mm (7") |
| Height | 50 mm (2") |
| Depth | 155 mm (6-1/8") |

NOSEPIECE SIZE

| | |
|--------|------------------|
| Width | 170 mm (6-3/4") |
| Height | 46 mm (1-13/16") |
| Depth | 18 mm (11/16") |

Due to continuous product improvement, specifications and design are subject to change without notice.

Installation and Connections

Before installing or connecting the unit, please read the following and pages 2 and 3 of this manual thoroughly for proper use.

Warning

USE ONLY VEHICLES WITH A 12 VOLT NEGATIVE (-) GROUND.

Check with your dealer if you are not sure. Failure to do so may result in fire or electric shock.

BEFORE WIRING, DISCONNECT THE CABLE FROM THE NEGATIVE (-) BATTERY TERMINAL.

Failure to do so may result in electric shock or injury due to electrical shorts.

DO NOT CUT AWAY THE WIRE SHEATH AND USE POWER FOR OTHER EQUIPMENT.

Doing so may exceed the current carrying capacity of the wire and result in fire or electric shock.

DO NOT INSTALL IN LOCATIONS WHICH MIGHT HINDER VEHICLE OPERATION OR CREATE HAZARDS FOR VEHICLE OCCUPANTS.

Doing so may obstruct forward vision or hamper movement.

DO NOT CONTACT, DAMAGE OR OBSTRUCT PIPES, FLUID LINES OR WIRING WHEN DRILLING HOLES.

Failure to take such precautions may result in fire or cause an accident or injuries.

DO NOT USE NUTS OR BOLTS IN THE BRAKE SYSTEM WHEN MAKING INSTALLATION OR GROUND CONNECTIONS.

Never use safety-related parts such as bolts or nuts in the steering or brake systems or tanks to make wiring installations or ground connections. Using such parts could disable control of the vehicle and cause brake failure, other accident or injury.

MAKE THE CORRECT CONNECTIONS.

Failure to do so may cause fire or accident to occur.

ARRANGE THE WIRING SO IT IS NOT CRIMPED OR PINCHED.

Route the cables and wiring so as not to be crimped by moving parts or make contact with sharp or pointed spots which might damage the wiring. Failure to do so may cause failure of unit or vehicle.

HAVE THE WIRING AND INSTALLATION DONE BY EXPERTS.

The wiring and installation of this unit requires special technical skill and experience. To ensure safety, always contact the dealer where you purchased this unit to have the work done.

Caution

USE SPECIFIED ACCESSORY PARTS AND INSTALL THEM SECURELY.

Use of other than designated parts may damage this unit internally or may not securely install the unit in place as parts that come loose may create hazards.

DO NOT INSTALL IN LOCATIONS WITH HIGH MOISTURE OR DUST.

A high incidence of moisture or dust that penetrates into this unit may cause smoke or fire.

Precautions

- Be sure to disconnect the cable from the (-) battery post before installing your CDM-7854E/CDE-7853E. This will reduce any chance of damage to the unit in case of a short-circuit.
- Be sure to connect the color coded leads according to the diagram. Incorrect connections may cause the unit to malfunction or damage to the vehicle's electrical system.
- When making connections to the vehicle's electrical system, be aware of the factory installed components (e.g. on-board computer). Do not tap into these leads to provide power for this unit. When connecting the CDM-7854E/CDE-7853E to the fuse box, make sure the fuse for the intended circuit of the CDM-7854E/CDE-7853E has the appropriate amperage. Failure to do so may result in damage to the unit and/or the vehicle. When in doubt, consult your ALPINE dealer.
- The CDM-7854E/CDE-7853E uses female RCA-type jacks for connection to other units (e.g. amplifier) having RCA connectors. You may need an adaptor to connect other units. If so, please contact your authorized ALPINE dealer for assistance.
- Be sure to connect the speaker (-) leads to the speaker (-) terminal. Never connect left and right channel speaker cables to each other or to the vehicle body.

IMPORTANT

Please record the serial number of your unit in the space provided below and keep it as a permanent record. The serial number plate is located on the bottom of the unit.

SERIAL NUMBER: _____
INSTALLATION DATE: _____
INSTALLATION TECHNICIAN: _____
PLACE OF PURCHASE: _____

Installation

1

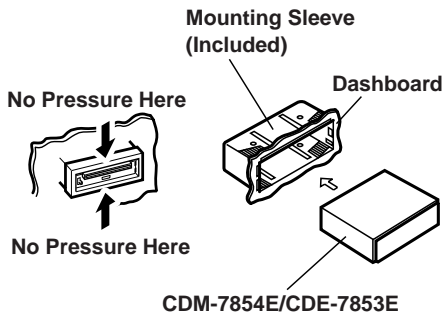

Remove the Detachable Front Panel (refer to page 4). Slide mounting sleeve from main unit (see "Removal" on this page). Slide the mounting sleeve into the dashboard.

NOTE

Please examine the installation. Make certain that no external pressure is applied to either the top of the unit or the removable nosepiece.

2

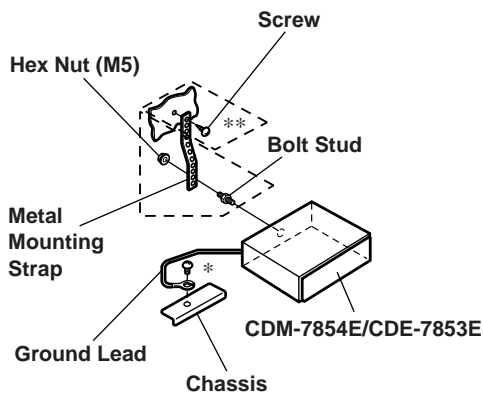

Reinforce the head unit with the metal mounting strap (not supplied). Secure the ground lead of the unit to a clean metal spot using a screw (*) already attached to the vehicle's chassis.

NOTE

For the screw marked **, use an appropriate screw for the chosen mounting location.

Connect each input lead coming from an amplifier or equalizer to the corresponding output lead coming from the left rear of the CDM-7854E/CDE-7853E. Connect all other leads of the CDM-7854E/CDE-7853E according to details described in the CONNECTIONS section.

3

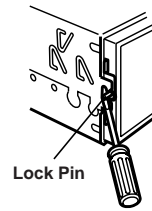

Slide the CDM-7854E/CDE-7853E into the dashboard. When the unit is in place, make sure the locking pins are fully seated in the down position. This can be done by pressing firmly in on the unit while pushing the locking pin down with a small screwdriver. This ensures that the unit is properly locked and will not accidentally come out from the dashboard. Install the Detachable Front Panel.

Removal

- 1 Remove the DETACHABLE FRONT PANEL.
- 2 Use a small screwdriver (or similar tool) to push the locking pins to the "up" position (see above drawing). As each pin is unlocked, gently pull out on the unit to make sure it does not re-lock before unlocking the second pin.
- 3 Pull the unit out, keeping it unlocked as you do so.

<JAPANESE CAR>

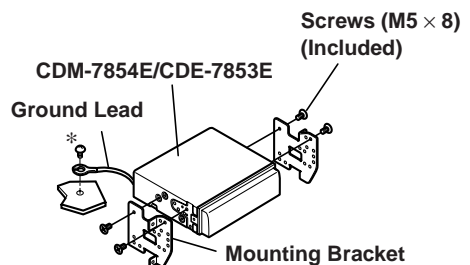
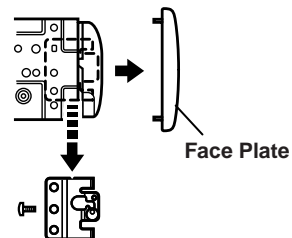

NOTE

Secure the ground lead of the unit to a clean metal spot using a screw (*) already attached to the vehicle's chassis.

Installation and Connections

Connections

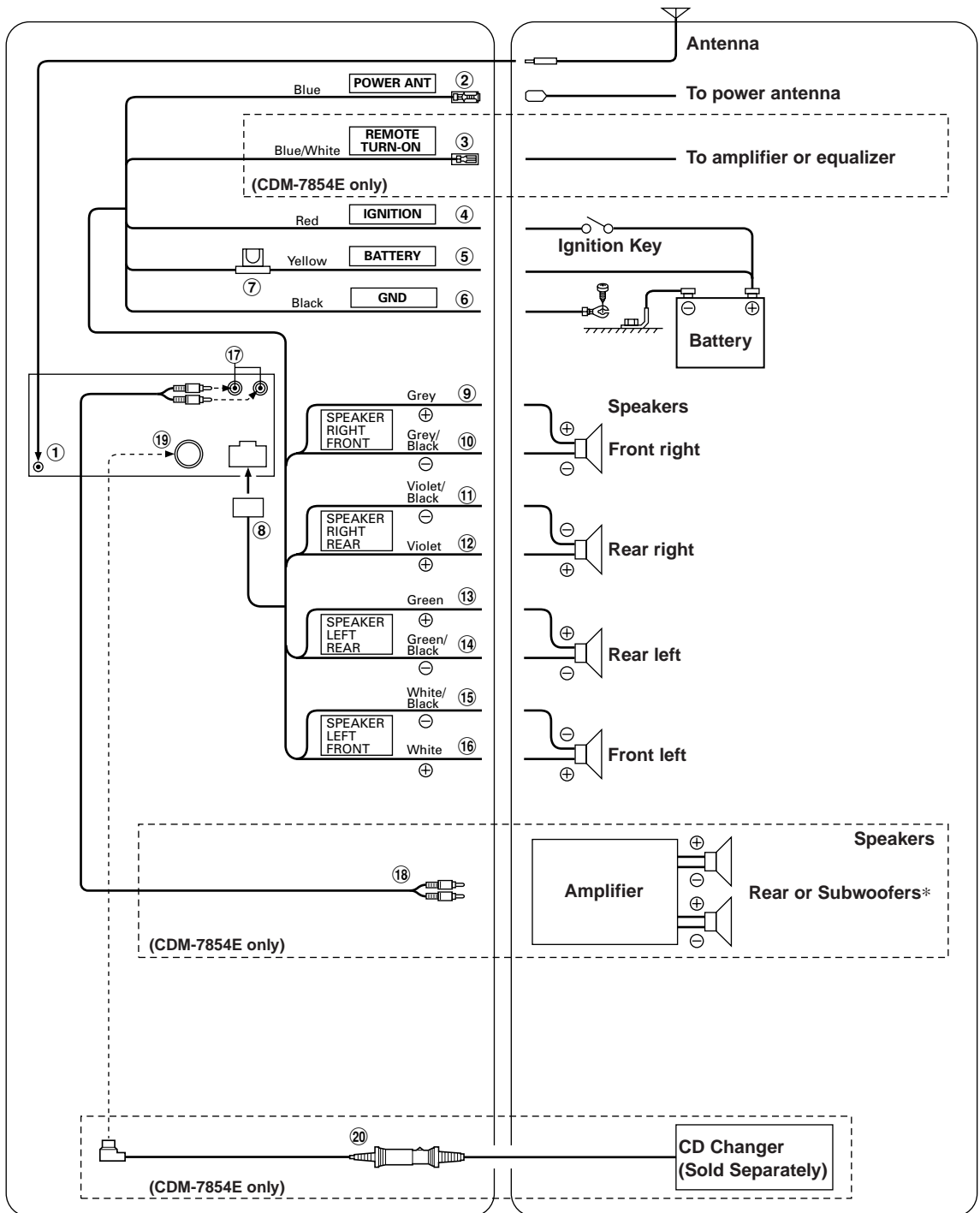

* When Subwoofer is set to OFF: Output is from Rear speakers.
When Subwoofer is set to ON: Output is from Subwoofer.

For details on how to set the Subwoofer to ON/OFF, see "Subwoofer On and Off" on page 5.

- ① Antenna Receptacle
- ② Power Antenna Lead (Blue)
Connect this lead to the +B terminal of your power antenna, if applicable.
- ③ Remote Turn-On Lead (Blue/White) (CDM-7854E only)
Connect this lead to the remote turn-on lead of your amplifier or signal processor.
- ④ Switched Power Lead (Ignition) (Red)
Connect this lead to an open terminal on the vehicle's fuse box or another unused power source which provides (+)12V only when the ignition is turned on or in the accessory position.
- ⑤ Battery Lead (Yellow)
Connect this lead to the positive (+) post of the vehicle's battery.
- ⑥ Ground Lead (Black)
Connect this lead to a good chassis ground on the vehicle. Make sure the connection is made to bare metal and is securely fastened using the sheet metal screw provided.
- ⑦ Fuse Holder (15A)
- ⑧ Power Supply Connector
- ⑨ Right Front (+) Speaker Output Lead (Grey)
- ⑩ Right Front (-) Speaker Output Lead (Grey/Black)
- ⑪ Right Rear (-) Speaker Output Lead (Violet/Black)
- ⑫ Right Rear (+) Speaker Output Lead (Violet)
- ⑬ Left Rear (+) Speaker Output Lead (Green)
- ⑭ Left Rear (-) Speaker Output Lead (Green/Black)
- ⑮ Left Front (-) Speaker Output Lead (White/Black)
- ⑯ Left Front (+) Speaker Output Lead (White)
- ⑰ Rear/Subwoofer RCA Connectors (CDM-7854E only)
RED is right and WHITE is left.
- ⑱ RCA Extension Cable (Sold Separately)
- ⑲ DIN Connector (CDM-7854E only)
Connect this to the DIN connector on the CD Changer.
- ⑳ DIN Extension Cable (Sold Separately)

NOTE

Older Alpine CD Changer came with standard, straight type DIN connectors. In installations where an L-type connector would simplify installation, the Alpine 491002 Adaptor can be used (Sold Separately).

To prevent external noise from entering the audio system.

- Locate the unit and route the leads at least 10cm away from the car harness.
- Keep the battery power leads as far away from other leads as possible.
- Connect the ground lead securely to a bare metal spot (remove the coating if necessary) of the car chassis.
- If you add an optional noise suppressor, connect it as far away from the unit as possible. Your Alpine dealer carries various Alpine noise suppressors, contact them for further information.
- Your Alpine dealer knows best about noise prevention measures so consult your dealer for further information.

Free Manuals Download Website

<http://myh66.com>

<http://usermanuals.us>

<http://www.somanuals.com>

<http://www.4manuals.cc>

<http://www.manual-lib.com>

<http://www.404manual.com>

<http://www.luxmanual.com>

<http://aubethermostatmanual.com>

Golf course search by state

<http://golfingnear.com>

Email search by domain

<http://emailbydomain.com>

Auto manuals search

<http://auto.somanuals.com>

TV manuals search

<http://tv.somanuals.com>