



EN

FR

ES

MP3 CD Receiver
CDE-9846



FM/AM CD Receiver
CDE-9842



- **OWNER'S MANUAL**
Please read before using this equipment.
- **MODE D'EMPLOI**
Veuillez lire avant d'utiliser cet appareil.
- **MANUAL DE OPERACIÓN**
Léalo antes de utilizar este equipo.

ALPINE ELECTRONICS MARKETING, INC.
1-1-8 Nishi Gotanda,
Shinagawa-ku,
Tokyo 141-0031, Japan
Phone 03-5496-8231

ALPINE ELECTRONICS OF AMERICA, INC.
19145 Gramercy Place, Torrance,
California 90501, U.S.A.
Phone 1-800-ALPINE-1 (1-800-257-4631)

ALPINE ELECTRONICS OF CANADA, INC.
777 Superstest Road, Toronto,
Ontario M3J 2M9, Canada
Phone 1-800-ALPINE-1 (1-800-257-4631)

ALPINE ELECTRONICS OF AUSTRALIA PTY. LTD.
161-165 Princes Highway, Hallam
Victoria 3803, Australia
Phone 03-8787-1200

ALPINE ELECTRONICS GmbH
Frankfurter Ring 117, 80807 München, Germany
Phone 089-32 42 640

ALPINE ELECTRONICS OF U.K. LTD.
Alpine House
Fletchamstead Highway, Coventry CV4 9TW, U.K.
Phone 0870-33 33 763

ALPINE ELECTRONICS FRANCE S.A.R.L.
(RCS PONTOISE B 338 101 280)
98, Rue de la Belle Etoile, Z.I. Paris Nord II,
B.P. 50016, 95945 Roissy Charles de Gaulle
Cedex, France
Phone 01-48638989

ALPINE ITALIA S.p.A.
Viale C. Colombo 8, 20090 Trezzano
Sul Naviglio (MI), Italy
Phone 02-484781

ALPINE ELECTRONICS DE ESPAÑA, S.A.
Portal de Gamarra 36, Pabellón, 32
01013 Vitoria (Alava)-APDO 133, Spain
Phone 945-283588

ALPINE ELECTRONICS (BENELUX) GmbH
Leuvensesteenweg 510-B6,
1930 Zaventem, Belgium
Phone 02-725-13 15

Contents

Operating Instructions

WARNING

WARNING 2

CAUTION 2

PRECAUTIONS 2

Getting Started

Turning Power On and Off 5

Detaching and Attaching the Front Panel 5

Initial System Start-Up 5

Adjusting Volume 5

Lowering Volume Quickly 5

Radio

Changing the Radio Frequencies for each

Country (CDE-9846 only) 6

Listening to Radio 6

Manual Storing of Station Presets 6

Automatic Memory of Station Presets 7

Tuning to Preset Stations 7

CD/MP3

Playback 8

Repeat Play 9

M.I.X. (Random Play) 9

Scanning Programs 9

Searching CD Text (CDE-9846 only) 9

File/Folder Name Search (concerning MP3)
(CDE-9846 only) 10

Quick Search (CDE-9846 only) 10

About MP3 (CDE-9846 only) 10

Sound Setting

Adjusting Bass/Treble/Balance (Between Left
and Right)/Fader (Between Front and Rear)/

Defeat 12

Setting the Bass Control 12

Setting the Treble Control 13

Turning Loudness On/Off 13

Other Functions

Displaying the Title/Text 14

Titling Discs/Radio Stations 15

Erasing Disc Title/Radio Station Title 15

Displaying Time 15

Setting Time 15

SETUP

Sound Customizing

Subwoofer On and Off 16

Visual Customizing (CDE-9846 only)

Dimmer Control (CDE-9846 only) 16

Scroll Type Setting (CDE-9846 only) 16

Scroll Setting (CDE-9846 only) 16

MP3 (CDE-9846 only)

Playing MP3 Data (CDE-9846 only) 17

External Device

Connecting to an External Amplifier 17

Information

In Case of Difficulty 18

Specifications 19

Installation and Connections

Warning 20

Caution 20

Precautions 20

Installation 21

Connections 22

LIMITED WARRANTY

Operating Instructions

WARNING

WARNING

This symbol means important instructions. Failure to heed them can result in serious injury or death.

DO NOT OPERATE ANY FUNCTION THAT TAKES YOUR ATTENTION AWAY FROM SAFELY DRIVING YOUR VEHICLE.

Any function that requires your prolonged attention should only be performed after coming to a complete stop. Always stop the vehicle in a safe location before performing these functions. Failure to do so may result in an accident.

KEEP THE VOLUME AT A LEVEL WHERE YOU CAN STILL HEAR OUTSIDE NOISE WHILE DRIVING.

Failure to do so may result in an accident.

MINIMIZE DISPLAY VIEWING WHILE DRIVING.

Viewing the display may distract the driver from looking ahead of the vehicle and cause an accident.

DO NOT DISASSEMBLE OR ALTER.

Doing so may result in an accident, fire or electric shock.

USE ONLY IN CARS WITH A 12 VOLT NEGATIVE GROUND.

(Check with your dealer if you are not sure.) Failure to do so may result in fire, etc.

KEEP SMALL OBJECTS SUCH AS BATTERIES OUT OF THE REACH OF CHILDREN.

Swallowing them may result in serious injury. If swallowed, consult a physician immediately.

USE THE CORRECT AMPERE RATING WHEN REPLACING FUSES.

Failure to do so may result in fire or electric shock.

DO NOT BLOCK VENTS OR RADIATOR PANELS.

Doing so may cause heat to build up inside and may result in fire.

USE THIS PRODUCT FOR MOBILE 12V APPLICATIONS.

Use for other than its designed application may result in fire, electric shock or other injury.

DO NOT PLACE HANDS, FINGERS OR FOREIGN OBJECTS IN INSERTION SLOTS OR GAPS.

Doing so may result in personal injury or damage to the product.

CAUTION

This symbol means important instructions. Failure to heed them can result in injury or material property damage.

HALT USE IMMEDIATELY IF A PROBLEM APPEARS.

Failure to do so may cause personal injury or damage to the product. Return it to your authorized Alpine dealer or the nearest Alpine Service Center for repairing.

PRECAUTIONS

Product Cleaning

Use a soft dry cloth for periodic cleaning of the product. For more severe stains, please dampen the cloth with water only. Anything else has the chance of dissolving the paint or damaging the plastic.

Temperature

Be sure the temperature inside the vehicle is between +60°C (+140°F) and -10°C (+14°F) before turning your unit on.

Moisture Condensation

You may notice the CD playback sound wavering due to condensation. If this happens, remove the disc from the player and wait about an hour for the moisture to evaporate.

Damaged Disc

Do not attempt to play cracked, warped, or damaged discs. Playing a bad disc could severely damage the playback mechanism.

Maintenance

If you have problems, do not attempt to repair the unit yourself. Return it to your Alpine dealer or the nearest Alpine Service Station for servicing.

PRECAUTIONS

Never Attempt the Following

Do not grip or pull out the disc while it is being pulled back into the player by the automatic reloading mechanism.

Do not attempt to insert a disc into the unit when the unit power is off.

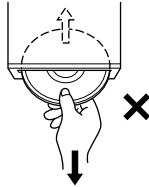

Inserting Discs

Your player accepts only one disc at a time for playback. Do not attempt to load more than one disc.

Make sure the label side is facing up when you insert the disc. "ERROR" will be displayed on your player if you insert a disc incorrectly. If "ERROR" continues to be displayed even though the disc has been inserted correctly, push the RESET switch with a pointed object such as a ballpoint pen.

Playing a disc while driving on a very bumpy road may result in skips, but this will not scratch the disc or damage the player.

New Discs

As a protective measure to prevent the CD from jamming, "ERROR" will be displayed if discs with irregular surface are inserted or inserted incorrectly. When a new disc is inserted into the player and ejected after initial loading, using your finger, feel around the inside of the center hole and outside edge of the disc. If you feel any small bumps or irregularities, this could inhibit proper loading of the disc. To remove the bumps, rub the inside edge of the hole and outside edge of the disc with a ballpoint pen or other such instrument, then insert the disc again.

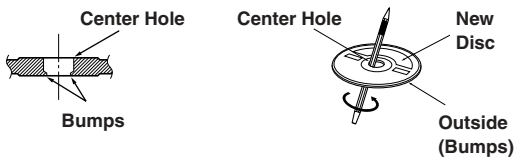

Irregular Shaped Discs

Be sure to use round shape discs only for this unit and never use any special shape discs.

Use of special shape discs may cause damage to the mechanism.

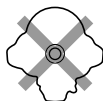

Installation Location

Make sure the CDE-9846/CDE-9842 will not be installed in a location subjected to:

- Direct sun and heat
- High humidity and water
- Excessive dust
- Excessive vibrations

Correct Handling

Do not drop the disc while handling. Hold the disc so you will not leave fingerprints on the surface. Do not affix tape, paper, or gummed labels to the disc. Do not write on the disc.

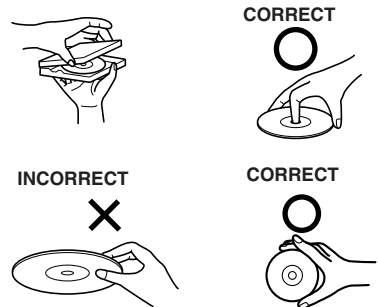

Disc Cleaning

Fingerprints, dust, or soil on the surface of the disc could cause the CD player to skip. For routine cleaning, wipe the playing surface with a clean, soft cloth from the center of the disc to the outer edge. If the surface is heavily soiled, dampen a clean, soft cloth in a solution of mild neutral detergent before cleaning the disc.



Disc Accessories

There are various accessories available on the market for protecting the disc surface and improving sound quality. However, most of them will influence the thickness and/or diameter of the disc. Using such accessories can cause the disc to be out of standard specifications and may create operational problems. We recommend not using these accessories on discs played in Alpine CD players.

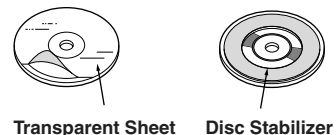

Continued

On handling Compact Discs (CD/CD-R/CD-RW)

- Do not touch the surface.
- Do not expose the disc to direct sunlight.
- Do not affix stickers or labels.
- Clean the disc when it is dusty.
- Make sure that there are no bumps around the disc.
- Do not use commercially available disc accessories.

Do not leave the disc in the car or the unit for a long time. Never expose the disc to direct sunlight. Heat and humidity may damage the CD and you may not be able to play it again.

To customers using CD-R/CD-RW

- If a CD-R/CD-RW cannot be played back, make sure the last recording session was closed (finalized).
- Finalize the CD-R/CD-RW if necessary, and attempt playback again.

About media that can be played.

The following table shows which discs can be played on which models.

	CD	CD-TEXT	MP3
CDE-9846	○	○	○
CDE-9842	○		

Use only compact discs with the label side showing the CD logo marks below.



(CDE-9846 only)

If you use unspecified compact discs, correct performance cannot be guaranteed.

You can play CD-Rs (CD-Recordable)/CD-RWs (CD-ReWritable) which have been recorded only on audio devices.

You can also play CD-Rs/CD-RWs containing MP3 formatted audio files.

- Some of the following CDs may not play on this unit:
Flawed CDs, CDs with fingerprints, CDs exposed to extreme temperatures or sunlight (e.g., left in the car or this unit), CDs recorded under unstable conditions, CDs on which a recording failed or a re-recording was attempted, copy-protected CDs which do not conform to the audio CD industry standard.
- Use discs with MP3 files written in a format compatible with this unit. For details, see pages 10-11.

-
- *“MPEG Layer-3 audio coding technology licensed from Fraunhofer IIS and Thomson”*
 - *“Supply of this product only conveys a license for private, non-commercial use and does not convey a license nor imply any right to use this product in any commercial (i.e. revenue-generation) real time broadcasting (terrestrial, satellite, cable and/or any other media), broadcasting/streaming via internet, intranets and/or other networks or in other electronic content distribution systems, such as pay-audio or audio-on-demand applications. An independent license for such use is required. For details, please visit <http://www.mp3licensing.com>.”*

Getting Started

CDE-9846

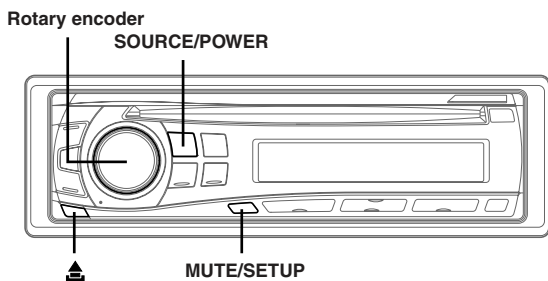

CDE-9842

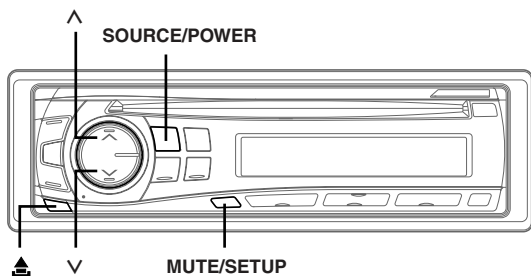

Turning Power On and Off

Press **SOURCE/POWER** to turn on the unit.

- The unit can be turned on by pressing any other button except eject and **TITLE/**.

Press and hold **SOURCE/POWER** for at least 2 seconds to turn off the unit.

- The first time power is turned on, the volume will start from level 12.

Detaching and Attaching the Front Panel

Detaching

- 1 Turn off the unit power.
- 2 Press (Release) at the lower left side until the front panel pops out.
- 3 Grasp the left side of the front panel and pull it out.



- The front panel may become hot in normal usage (especially the connector terminals on the back of the front panel). This is not a malfunction.
- To protect the front panel, place it in the supplied carrying case.

Attaching

- 1 Insert the right side of the front panel into the main unit. Align the groove on the front panel with the projections on the main unit.
- 2 Push the left side of the front panel until it locks firmly into the main unit.

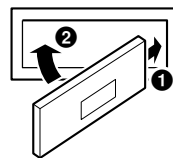

- Before attaching the front panel, make sure that there is no dirt or dust on the connector terminals and no foreign object between the front panel and the main unit.
- Attach the front panel carefully, holding the sides of the front panel to avoid pushing buttons by mistake.

Initial System Start-Up

Be sure to press the **RESET** switch when using the unit for the first time, after changing the car battery, etc.

- 1 Turn off the unit power.
- 2 Remove the detachable front panel.
- 3 Press **RESET** with a ballpoint pen or similar pointed object.

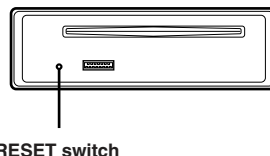

Adjusting Volume

Turn the **Rotary encoder** (CDE-9846 only) or press **▲** and **V** (CDE-9842 only) until the desired sound is obtained.

Lowering Volume Quickly

Activating the Audio Mute function will instantly lower the volume level by 20 dB.

Press **MUTE/SETUP** to activate the **MUTE** mode. The audio level will decrease by about 20 dB.

Pressing **MUTE/SETUP** again will bring the audio back to its previous level.

Radio

CDE-9846

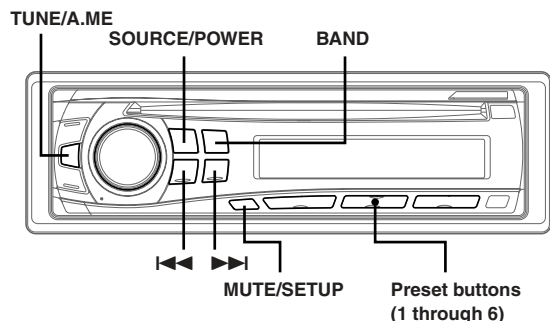

CDE-9842

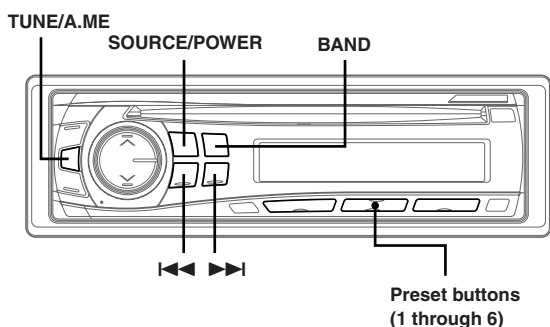

Changing the Radio Frequencies for each Country (CDE-9846 only)

For customers not living in North America, change the radio frequencies as follows.

- 1 Press and hold **MUTE/SETUP** for at least 2 seconds to select the **SETUP** mode.
- 2 Select the "AREA" mode by pressing **◀◀** or **▶▶**.
- 3 Choose either **AREA 1** or **AREA 2** by pressing **BAND**.

AREA 1: Radio frequencies for North America
AREA 2: Other Radio frequencies

- 4 Pressing and holding **MUTE/SETUP** for at least 2 seconds will return to normal mode.

- The stored radio stations will be cleared every time you change the setting.

Listening to Radio

- 1 Press **SOURCE/POWER** until a radio frequency appears in the display.

- 2 Press **BAND** repeatedly until the desired radio band is displayed.

F1 (FM1) → F2 (FM2) → AM → F1 (FM1)

- 3 Press **TUNE/A.ME** to select the tuning mode.

DX SEEK (Distance mode) → SEEK (Local mode) → OFF (Manual mode) → DX SEEK

- The initial mode is Distance mode.

Distance mode:

Both strong and weak stations will be automatically tuned in (Automatic Seek Tuning).

Local mode:

Only strong stations will be automatically tuned in (Automatic Seek Tuning).

Manual mode:

The frequency is manually tuned in steps (Manual tuning).

- 4 Press **◀◀** or **▶▶** to tune in the desired station.

Holding down **◀◀** or **▶▶** will change the frequency continuously.

- The **ST** indicator appears on the display when a stereo FM station is tuned in.

Manual Storing of Station Presets

- 1 Select the radio band and tune in a desired radio station you wish to store in the preset memory.

- 2 Press and hold, for at least 2 seconds, any one of the **preset buttons (1 through 6)** that you want to store the station on.

The selected station is stored.

The display shows the band, preset number and station frequency memorized.

- A total of 18 stations can be stored in the preset memory (6 stations for each band; FM1, FM2 and AM).
- If you store a station in a preset memory which already has a station, the current station will be cleared and replaced with the new station.

Automatic Memory of Station Presets

- 1 Press **BAND** repeatedly until the desired radio band is displayed.**
- 2 Press and hold **TUNE/A.ME** for at least 2 seconds.**

The frequency on the display continues to change while the automatic memory is in progress. The tuner will automatically seek and store 6 strong stations in the selected band. They will be stored into buttons 1 to 6 in order of signal strength.

When the automatic memory has been completed, the tuner goes to the station stored in preset location No.1.

 - *If no stations are stored, the tuner will return to the original station you were listening to before the auto memory procedure began.*

Tuning to Preset Stations

- 1 Press **BAND** repeatedly until the desired band is displayed.**
- 2 Press any one of the station preset buttons (1 through 6) that has your desired radio station in memory.**

The display shows the band, preset number and frequency of the station selected.

CD/MP3

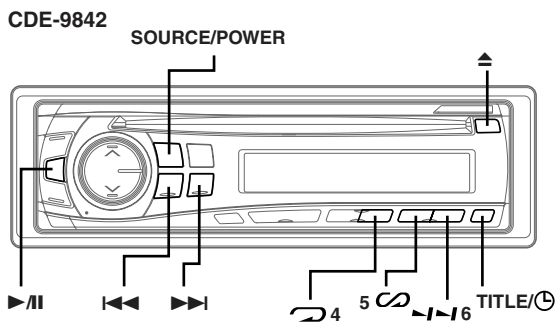
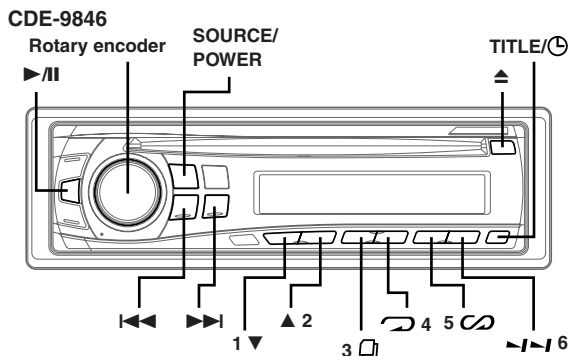

Playback

The following table shows which discs can be played on which models.

	CD	CD-TEXT	MP3
CDE-9846	○	○	○
CDE-9842	○		

1 Insert a disc with the label side facing up.

The disc will be pulled into the unit automatically.

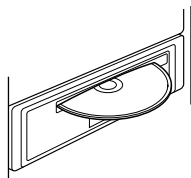

When a disc is already inserted, press SOURCE/POWER to switch to the CD mode.

The mode will change every time the button is pressed.

TUNER → CD → TUNER

2 CDE-9846: While playing back MP3, press 1 ▼ or ▲ 2 to select the desired folder.

Pressing and holding 1 ▼ or ▲ 2 will change folders continuously.

3 Press I◀◀ or ▶▶I to select the desired track (file).

Returning to the beginning of the current track (file):

Press I◀◀.

Fast backward:

Press and hold I◀◀.

Advancing to the beginning of the next track (file):

Press ▶▶I.

Fast forward:

Press and hold ▶▶I.

4 To pause playback, press ▶/II.

Pressing ▶/II again will resume playback.

5 To eject the disc, press ▲.

- Do not remove a CD during its eject cycle. Do not load more than one disc at a time. A malfunction may result from doing either.
- If the CD does not eject, press and hold ▲ for at least 2 seconds.

CDE-9846 (compatible with MP3):

- The CD-player can play discs containing audio data and MP3 data.
- The track display for MP3 data playback is the file numbers recorded on the disc.

MP3 Play Display

The folder number and file number will be displayed as described below.

CDE-9846:

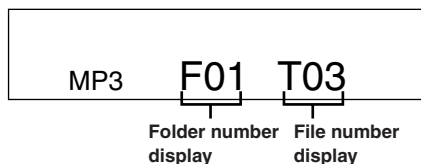

- If the folder number or file number are three digits, "F" or "T" is not displayed.
- Press TITLE/Ⓢ to switch the display. Please see "Displaying the Title/Text" (page 14) for information about display switching.

Repeat Play

Press **4** to play back repeatedly the track being played.

The track (file) will be played repeatedly.

Press **4** again and select OFF to deactivate repeat play.

CD mode :

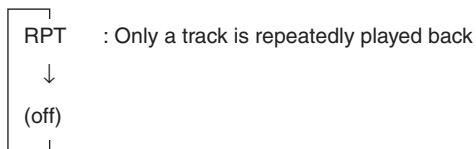

MP3 mode (CDE-9846 only):

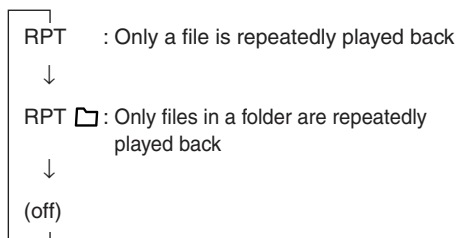

M.I.X. (Random Play)

Press **5** in the play or pause mode.

The tracks (files) on the disc will be played back in random sequence.

To cancel M.I.X. play, press **5** again.

CD mode :

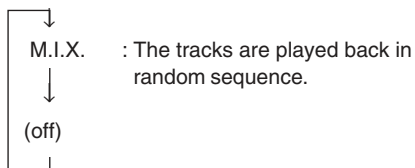

MP3 mode (CDE-9846 only):

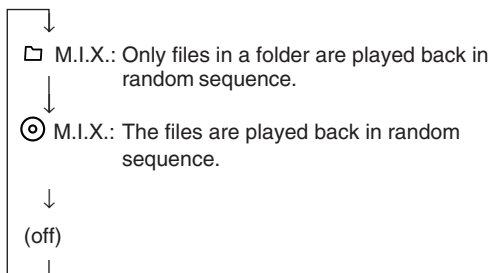

Scanning Programs

Press **6** to activate the Scan mode.

The first 10 seconds of each track (file) will be played back in succession.

To stop scanning, press **6** again and deactivate the Scan mode.

Searching CD Text (CDE-9846 only)

Tracks can be searched and played by using the CD text on the disc.

In the case of discs that do not support text, searches can be made by using the track numbers.

1 Press **3** during play.

This will set the search mode.

2 Turn the **Rotary encoder** to select the desired track, then press the **Rotary encoder**.

This will play the selected track.

- Press and hold **3** for at least 2 seconds in the search mode to cancel. Or, the search mode will be canceled when an operation has not been performed in 10 seconds.
- CD text search cannot be made during M.I.X. play.



File/Folder Name Search (concerning MP3) (CDE-9846 only)

You can display and search for the folder and file name while listening to the file currently being played back.

- 1 Press **3**  to select File Name Search mode or Folder Name Search mode in MP3 mode.



File Name Search mode

- 2 Press **1**  or **▲ 2** to select another Folder.
- 3 Select the desired file by turning the **Rotary encoder** within **10 seconds**.
- 4 Press the **Rotary encoder** to play back the selected file.

- File Name Search mode is canceled by pressing and holding **3**  for at least 2 seconds.
- While in File Name Search mode, press **3**  to switch to Folder Name Search mode.
- File Name search cannot be made during M.I.X. play.



Folder Name Search mode

- 2 Turn the **Rotary encoder** within **10 seconds** to select the desired folder.
- 3 Press the **Rotary encoder** to play back the first file in the selected folder.

- Search mode is canceled by pressing and holding **3**  for at least 2 seconds in Folder Name Search mode.
- While in Folder Name Search mode, press **3**  to switch to File Name Search mode.
- "NO FILE" is displayed for 2 seconds if the folder that is selected by the Folder Name Search mode contains no files.
- "ROOT" is displayed for the root folder which does not have folder name.
- Folder Name search cannot be made during M.I.X. play.

Quick Search (CDE-9846 only)

You can search for tracks (files).

- 1 Press and hold **3**  for at least 2 seconds in the CD/MP3 mode to activate Quick Search mode.
 - 2 Turn the **Rotary encoder** within **10 seconds** to select a desired track (file).
The selected track is played back immediately.
- Search mode is canceled by pressing and holding **3**  for at least 2 seconds in Quick Search mode.

About MP3 (CDE-9846 only)

CAUTION

Except for private use, duplicating audio data (including MP3 data) or distributing, transferring, or copying it, whether for free or for a fee, without permission of the copyright holder is strictly prohibited by the Copyright Act and by international treaty.

What is MP3?

MP3, whose official name is "MPEG-1 Audio Layer 3," is a compression standard prescribed by the ISO, the International Standardization Organization and MPEG which is a joint activity institution of the IEC.

MP3 files contain compressed audio data. MP3 encoding is capable of compressing audio data at extremely high ratios, reducing the size of music files to as much as one-tenth their original size. This is achieved while still maintaining near CD quality. The MP3 format realizes such high compression ratios by eliminating the sounds that are either inaudible to the human ear or masked by other sounds.

Method for creating MP3 files

Audio data is compressed by using MP3 specified software. For details on creating MP3 files, refer to the user's manual for that software.

MP3 files that can be played back by this device have the file extension "mp3". Files with no extension cannot be played back.

Supported playback sampling rates and bit rates

MP3

Sampling rates: 48 kHz, 44.1 kHz, 32 kHz, 24 kHz, 22.05 kHz, 16 kHz, 12 kHz, 11.025 kHz, 8 kHz
Bit rates: 8 - 320 kbps

Note that for sampling rates, this device's frame display (page 14) may not display correctly.

This device may not play back correctly depending on sampling rates.

ID3 tags

This device supports ID3 tag v1 and v2.

If tag data is in an MP3 file, this device can display the title (track title), artist name, and album name ID3 tag data.

This device can only display single-byte alphanumeric characters (up to 30 for ID3 tags) and the underscore. For non-supported characters, "NO SUPRT" is displayed. The tag information may not be correctly displayed, depending on the contents.

Producing MP3 discs

MP3 files are prepared, then written to a CD-R or CD-RW using CD-R writing software. A disc can hold up to 510 files/folders (including Root Folders). However, the maximum number of folders is 255.

Media supported

The media that this device can play back are CD-ROMs, CD-Rs, and CD-RWs.

Corresponding File Systems

This device supports discs formatted with ISO9660 Level 1 or Level 2.

Under the ISO9660 standard, there are some restrictions to remember.

The maximum nested folder depth is 8 (including the root directory). The number of file/folder name characters is limited.

Valid characters for folder/file names are letters A-Z (all caps), numbers 0-9, and '_' (underscore).

This device also can play back discs in Joliet, Romeo, etc., and other standards that conform to ISO9660. However, sometimes the file names, folder names, etc., are not displayed correctly.

Formats supported

This device supports CD-ROM XA, Mixed Mode CD, Enhanced CD (CD-Extra) and Multi-Session.

This device cannot correctly play back discs recorded with Track At Once or packet writing.

Order of files

The unit plays the files in the order that the writing software writes them. Therefore, the playing order may not be the same as the order you input. The playback order of the folders and files is shown in the illustration. The folder and file playback order may differ from the folder and file number indicated in the display.

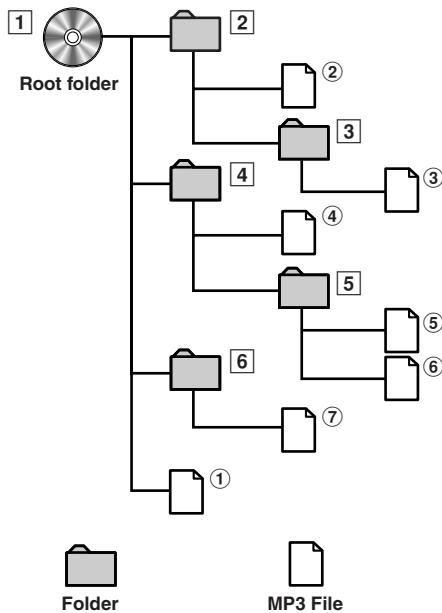

Terminology

Bit rate

This is the "sound" compression rate specified for encoding. The higher the bit rate, the higher the sound quality, but also the larger the files.

Sampling rate

This value shows how many times per second the data is sampled (recorded). For example, music CDs use a sampling rate of 44.1 kHz, so the sound is sampled (recorded) 44,100 times per second. The higher the sampling rate, the higher the sound quality, but also the larger the volume of data.

Encoding

Converting music CDs, WAVE (AIFF) files, and other sound files into the specified audio compression format.

Tag

Song information such as track titles, artist names, album names, etc., written into MP3 files.

MP3: ID3 tag

Root folder

The root folder is found at the top of the file system. The root folder contains all folders and files.

Sound Setting

CDE-9846

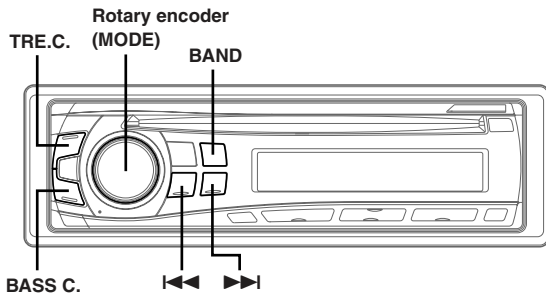

CDE-9842

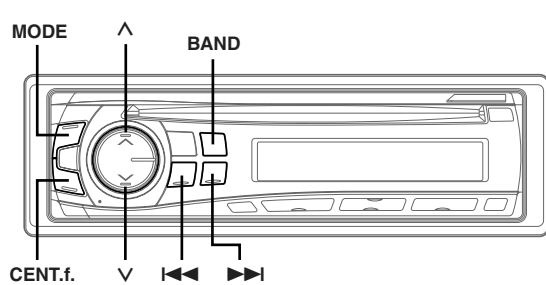

Adjusting Bass/Treble/Balance (Between Left and Right)/Fader (Between Front and Rear)/Deaf

1 Press the Rotary encoder (MODE) (CDE-9846 only) or press MODE (CDE-9842 only) repeatedly to choose the desired mode.

Each press changes the mode as follows:

BASS LV → TRE LV → SUBW* → BALANCE → FADER → DEFT → VOLUME → BASS LV

Bass level : -7 ~ +10
 Treble level : -7 ~ +7
 Subwoofer : 0 ~ +15
 Balance : L15 ~ R15
 Fader : R15 ~ F15
 Deaf : ON/OFF
 Volume : 0 ~ 35

- If the **Rotary encoder** is not pressed within 5 seconds after selecting the **BASS LV**, **TRE LV**, **BALANCE**, **FADER**, **DEFT** or **SUBW** mode, the unit automatically returns to normal mode.

* When the subwoofer mode is set to **OFF**, its level cannot be adjusted.

2 Turn the Rotary encoder (MODE) (CDE-9846 only) or press ^ and v (CDE-9842 only) until the desired sound is obtained in each mode.

By setting Deaf ON, previously adjusted settings of Bass level and Treble level will return to the factory defaults.

Setting the Bass Control

You can change the bass frequency emphasis to create your own tonal preference.

1 Press BASS C. (CDE-9846 only) or press CENT.f. (CDE-9842 only) to select the Bass (bass center frequency) Control mode.

CDE-9846:
 BASS LV ↔ normal

CDE-9842:
 BASS LV → TRE LV → normal mode → BASS LV

2-1 Setting the bass center frequency:
 Press ◀◀ or ▶▶ to select the desired bass center frequency.

60Hz ↔ 80Hz ↔ 100Hz ↔ 120Hz ↔ 60Hz

The displayed bass frequency is emphasized.

2-2 Setting the bass band width (Q-Factor):
 Press BAND to select the desired bass band width.

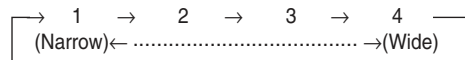

Change the boosted bass band width to wide or narrow. A wide setting will boost a wide range of frequencies above and below the center frequency. A narrower setting will boost only frequencies near the center frequency.

2-3 Setting the bass level:
 Turn the **Rotary encoder** (CDE-9846 only) or press ^ and v (CDE-9842 only) to select the desired bass level (-7~+10).

You can emphasize or weaken the bass frequency.

- If no operation is performed within 15 seconds, the bass control setting will be turned off automatically.
- The bass level settings will be individually memorized for each source (FM, AM, CD, etc.) until the setting is changed. The bass frequency and bass band width settings adjusted for one source are effective for all other sources (FM, AM, CD etc.).
- This function is inoperable when **DEFT** is set to **ON**.

Setting the Treble Control

You can change the Treble Frequency emphasis to create your own tonal preference.

1 Press **TRE.C.** (CDE-9846 only) or press **CENT.f.** (CDE-9842 only) to select the Treble (treble center frequency) Control mode.

CDE-9846:
TRE LV ↔ normal mode

CDE-9842:
BASS LV → TRE LV → normal mode → BASS LV

2-1 Setting the treble Center frequency: Press **◀◀** or **▶▶** to select the desired treble center frequency.

7.5kHz ↔ 10.0kHz ↔ 12.5kHz ↔ 15.0kHz

The displayed Treble frequency is emphasized.

2-2 Setting the treble level: Turn the **Rotary encoder** (CDE-9846 only) or press **▲** and **▼** (CDE-9842 only) to select the desired treble level (-7~+7).

You can emphasize the treble frequency.

- If no operation is performed within 15 seconds, the treble control setting will be turned off automatically.
- The treble level settings will be individually memorized for each source (FM, AM, CD, etc.) until the setting is changed. The Treble frequency settings adjusted for one source are effective for all other sources (FM, AM, CD, etc.).
- This function is inoperable when DEFT is set to ON.

Turning Loudness On/Off

Loudness introduces a special low- and high-frequency emphasis at low listening levels. This compensates for the ear's decreased sensitivity to bass and treble sound.

Press and hold the **Rotary encoder** (CDE-9846 only) or press and hold **MODE** (CDE-9842 only) for at least 2 seconds to activate or deactivate the loudness mode.

The display shows "LD" when the loudness mode is activated.

Other Functions

CDE-9846

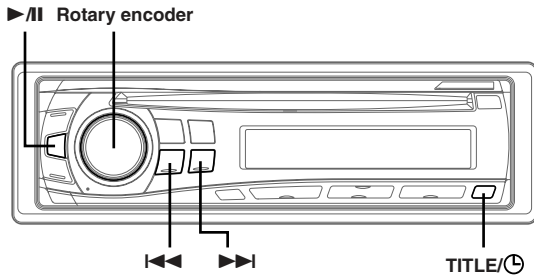

CDE-9842

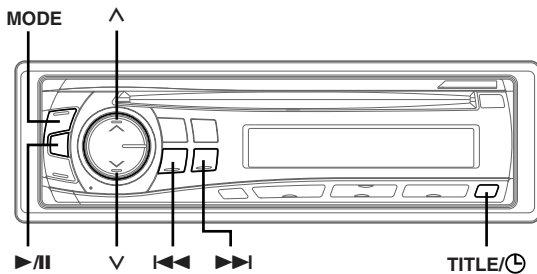

Displaying the Title/Text

The following table shows which discs can be played on which models.

	CD	CD-TEXT	MP3
CDE-9846	○	○	○
CDE-9842	○		

It is possible to display the CD title if the title has been previously inputted ("Titling Discs" page 15). Text information, such as the disc name and the track name, will be displayed if playing a CD text compatible disc. It is also possible to display the folder name, the file name, and the tag, etc., while playing MP3 files.

Press **TITLE/Ⓢ**.

The display will change every time the button is pressed.

The display in Radio mode:

FREQUENCY → CLOCK → TITLE → FREQUENCY

The display in CD mode:

CDE-9846
 TRACK NO./ELAPSED TIME → TRACK NO./CLOCK →
 TEXT (DISC NAME)*¹ → TEXT (TRACK NAME)*¹ → TITLE →
 TRACK NO./ELAPSED TIME

CDE-9842
 TRACK NO./ELAPSED TIME → TRACK NO./CLOCK → TITLE
 → TRACK NO./ELAPSED TIME

The display in MP3 mode:

CDE-9846
 FILE NO./ELAPSED TIME → FOLDER NO./FILE NO. →
 FILE NO./CLOCK → FOLDER NAME*¹ → FILE NAME →
 ARTIST NAME*² → ALBUM NAME*² → TRACK NAME*² →
 FRAME*³ → FILE NO./ELAPSED TIME

*¹ Displayed during playback of a disc with CD Text.

"NO TEXT" will be displayed when the CD contains no Text data.

*² ID3 tag

If an MP3 file contains ID3 tag information, all the ID3 tag information is displayed (e.g., track name, artist name, and album name). All other tag data is ignored.

"NO DATA" will be displayed when an MP3 file contains no ID3 tag information.

*³ The recording sampling rate and bit rate of the MP3 file are displayed. The VBR (Variable Bit rate) file displays the average bit rate.

*⁴ "ROOT" is displayed for the folder name of the root folder which does not have folder name.

About the indicator display

When displaying Title/Text, the following indicators are lit according to the mode.



Indicator/Mode	CD Mode	MP3 Mode	TUNER MODE
	While displaying Title	—	—
	—	While displaying Folder Name* ²	—
	—	While displaying File Name* ²	—
	—	While displaying Artist Name* ¹ / ²	—
	While displaying Text* ² (Disc Name)	While displaying Album Name* ¹ / ²	—
	While displaying Text* ² (Track Name)	While displaying Track Name* ¹ / ²	While displaying Title

*¹ Tag information.

*² Apply only to the CDE-9846.

About "Title" and "Text"

Title:

With this device, it is possible to input the CD and radio station name (this page). This inputted name is referred to as a "title."

You cannot input or display titles on MP3 discs.

Text:

Text compatible CDs contain text information such as the disc name and track name. Such text information is referred to as "text."

- Some characters may not be displayed correctly with this device, depending on the character type.
- When the Scroll Setting (page 16) is set to "SCR MANU" for CDE-9846, press and hold **TITLE/⊕** for at least 2 seconds to scroll the Text information only once (TEXT DISPLAY, FOLDER NAME DISPLAY, FILE NAME DISPLAY or TAG DISPLAY mode).
- "NO SUPRT" is displayed when the desired text information cannot be displayed on this unit.
- If the title was not previously input, "NO TITLE" is displayed.
- The text or tag information may not be correctly displayed, depending on the contents.

Titling Discs/Radio Stations

It is possible to title your favourite CDs or radio stations.

You cannot input titles for MP3 discs.

- 1 Press **TITLE/⊕** and select the Title Display.**
For details, see "Displaying the Title/Text" (page 14).
- 2 Press and hold **TITLE/⊕** for at least 2 seconds. The first character will blink.**
- 3 Turn the Rotary encoder (CDE-9846 only) or press **▲** and **▼** (CDE-9842 only) to select the desired letter/numeral/symbol available for naming.**
- 4 Press the Rotary encoder (CDE-9846 only) or press **MODE** (CDE-9842 only) to store the first character.**
The first character will stop blinking and the display will automatically advance to the next character. When that character begins to blink, you may choose the next letter or symbol of your title.
- 5 Repeat steps 3 and 4 above to complete the titling.**
Pressing the Rotary encoder (CDE-9846 only) or press **MODE** (CDE-9842 only) after entering the 8th character automatically stores the title into memory.

When entering a title of less than 8 characters (for example, 3 character title):
After entering 3 characters, the 4th character space will be blinking. Go to step 6 to complete the title.
- 6 Press **TITLE/⊕** to record the title.**
 - If you cancel while entering a title, selected characters are not written.
 - You can enter 18 CD titles and 24 radio station titles on this unit. If you try to store beyond the limit, the display will show "FULL DATA." At this point, no more titles can be stored. To input a new title, one of the previously inputted titles must first be deleted.
 - When you want to erase a title, enter the "⊞" symbol into all spaces.
 - The operations described in steps 3 to 5 must be made within 10 seconds. The input mode will be canceled if no action is taken for over 10 seconds.

Erasing Disc Title/Radio Station Title

- 1 Press **TITLE/⊕** to select the Title Display. Then, press again and hold for at least 2 seconds.**
- 2 Press and hold **▶/II** for at least 2 seconds.**
The title in the display will blink.
- 3 Press **◀◀** or **▶▶** repeatedly until the title you want to erase is displayed.**
- 4 Press and hold **▶/II** for at least 2 seconds to erase the title displayed.**
- 5 Press **TITLE/⊕** to cancel the title erasing mode.**
 - You cannot erase CD-TEXT.
 - "NO DATA" is displayed for 2 seconds if the title is not input in step 2, or if the title is erased in step 4.

Displaying Time

Press **TITLE/⊕** repeatedly until the time is displayed.

Each press changes the display.

For details, see "Displaying the Title/Text" (page 14).

- Selecting any tuner or CD function while in the clock priority mode will interrupt the time display momentarily. The function selected will be displayed for about 5 seconds before the time returns to the display.
- When the power is off but the ignition key is on, press **TITLE/⊕** to display the time.

Setting Time

- 1 In the Clock priority mode, press and hold **TITLE/⊕** for at least 2 seconds while the time is displayed.**
The time indication will blink.
- 2 Turn the Rotary encoder (CDE-9846 only) or press **▲** and **▼** (CDE-9842 only) to adjust the hours while the time indication is blinking.**
- 3 When the hour has been adjusted, press the Rotary encoder (CDE-9846 only) or press **MODE** (CDE-9842 only).**
- 4 Turn the Rotary encoder (CDE-9846 only) or press **▲** and **▼** (CDE-9842 only) to adjust the minutes while the time indication is blinking.**
The time is automatically set 5 seconds after the minute adjustment. The time can also be manually set by pressing the Rotary encoder (CDE-9846 only) or press **MODE** (CDE-9842 only).
 - To synchronize the clock to another clock/watch or radio time announcement, press and hold the **Rotary encoder** (CDE-9846 only) or press and hold **MODE** (CDE-9842 only) for at least 2 seconds after setting the "hour." Minutes will reset to 00. If the display shows over "30" minutes when you do this, the time will advance one hour.

SETUP

You can flexibly customize the unit to suit your own preferences and usage. From the SETUP menu, choose from Sound Customizing, Visual Customizing, etc., to make your desired settings.

CDE-9846

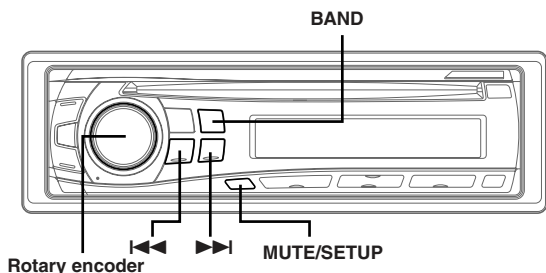

CDE-9842

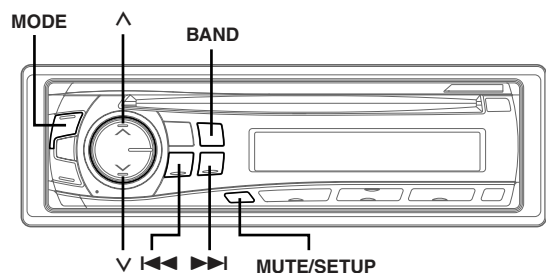

A typical SETUP procedure is shown in steps 1 to 4 as follows. See below for further information about each SETUP menu.

1 Press and hold **MUTE/SETUP** for at least 2 seconds.

SETUP mode is activated.

2 Press **◀◀** or **▶▶** to select the desired SETUP menu.

(e.g. Select SUBW)

CDE-9846

DIM → SUBW → CD-DA / CDDA/MP3 → SCR TYPE → SCR → PWR → AREA* → DIM

* Refer to "Changing the Radio Frequencies for each Country" (page 6).

CDE-9842

SUBW → PWR → SUBW

3 Press **BAND** to change the setting.

(e.g. Select SUBW ON or SUBW OFF.)

4 Press **MUTE/SETUP** for at least 2 seconds again.

The display returns to normal mode.

Sound Customizing

Subwoofer On and Off

SUBW ON (Initial setting) / SUBW OFF

When the subwoofer is on, perform the steps below to adjust the subwoofer output level.

- 1 Press the **Rotary encoder** (CDE-9846 only) or press **MODE** (CDE-9842 only) repeatedly to select the SUBW mode.

BASS LV → TRE LV → SUBW* → BALANCE → FADER → DEFT → VOLUME → BASS LV

- 2 To adjust the level, turn the **Rotary encoder** (CDE-9846 only) or press **▲** and **▼** (CDE-9842 only).

* When the subwoofer mode is set to OFF, its level cannot be adjusted.

Visual Customizing (CDE-9846 only)

Dimmer Control (CDE-9846 only)

CDE-9846:

DIM AUTO (Initial setting) / DIM MANU

Set the DIM control to AUTO to decrease the illumination brightness of the unit with the head lights of the vehicle ON. This mode is useful if you feel the unit's button lighting is too bright at night.

Scroll Type Setting (CDE-9846 only)

TYPE1 (Initial setting) / TYPE2

Choose from two scrolling methods.

Select the type you prefer.

Scroll Setting (CDE-9846 only)

CDE-9846:

SCR AUTO / SCR MANU (Initial setting)

This CD player can scroll the disc and track names recorded on CD-TEXT discs, as well as the text information of MP3 files, folder names, and tags.

- | | |
|----------|--|
| SCR AUTO | : The CD text information, the text information of folder and file names, and the tags are scrolled automatically. |
| SCR MANU | : The display is scrolled only when a disc is loaded or when a track is changed, etc. |

• The unit scrolls CD text names, folder names, file names or tag display. The disc titles input manually (page 15) cannot be scrolled.

MP3 (CDE-9846 only)

Playing MP3 Data (CDE-9846 only)

CDE-9846:

CD-DA (Initial setting) / CDDA/MP3

This product can playback CDs containing both CD and MP3 data. However, in some situations (some enhanced CDs), playback may be difficult. For these special cases, you can select playback of CD data only. When a disc contains both CD or the MP3 data, playback starts from the CD data portion of the disc.

- CD-DA : Only CD data can be played back.
- CDDA/MP3 : Both CD data and MP3 file tracks can be played back.

- Perform this setting before inserting a disc. If a disc has already been inserted, perform the setting after you remove the disc.

External Device

Connecting to an External Amplifier

PWR ON (Initial setting) / PWR OFF

When an external amplifier is connected, sound quality can be improved by stopping the power supply of the built-in amplifier.

- PWR OFF : Use this mode when the pre-amplifier of the unit are used to drive an external amplifier connected to the speakers. In this setting, the head unit's internal amplifier has no output to drive speakers.

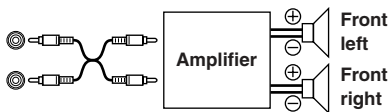

PWR ON : The speakers are driven by the built-in amplifier.

Speakers

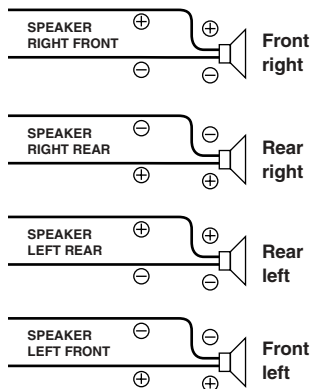

- No sound is produced by the system when the power output is set to OFF.

Information

In Case of Difficulty

If you encounter a problem, please turn the power off, then on again. If the unit is still not functioning normally, please review the items in the following checklist. This guide will help you isolate the problem if the unit is at fault. Otherwise, make sure the rest of your system is properly connected or consult your authorized Alpine dealer.

Basic

No function or display.

- Vehicle's ignition is off.
 - If connected following instructions, the unit will not operate with the vehicle's ignition off.
- Improper power lead (Red) and battery lead (Yellow) connections.
 - Check power lead and battery lead connections.
- Blown fuse.
 - Check the fuse of the unit; replace with the proper value if necessary.
- Internal micro-computer malfunctioned due to interference noise etc.
 - Press the RESET switch with a ballpoint pen or other pointed article.

Radio

Unable to receive stations.

- No antenna or open connection in cable.
 - Make sure the antenna is properly connected; replace the antenna or cable if necessary.

Unable to tune stations in the seek mode.

- You are in a weak signal area.
 - Make sure the tuner is in the DX mode.
- If the area you are in is a primary signal area, the antenna may not be grounded and connected properly.
 - Check your antenna connections; make sure the antenna is properly grounded at its mounting location.
- The antenna may not be the proper length.
 - Make sure the antenna is fully extended; if broken, replace the antenna with a new one.

Broadcast is noisy.

- The antenna is not the proper length.
 - Extend the antenna fully; replace it if it is broken.
- The antenna is poorly grounded.
 - Make sure the antenna is grounded properly at its mounting location.

CD

CD Player not functioning.

- Out of operating temperature range +50°C (+120°F) for CD.
 - Allow the vehicle's interior (or trunk) temperature to cool.

CD playback sound is wavering.

- Moisture condensation in the CD Module.
 - Allow enough time for the condensation to evaporate (about 1 hour).

CD insertion not possible.

- A CD is already in the CD player.
 - Eject the CD and remove it.
- The CD is being improperly inserted.
 - Make sure the CD is being inserted following instructions in the CD Player Operation section.

Unable to fast forward or backward the CD.

- The CD has been damaged.
 - Eject the CD and discard it; using a damaged CD in your unit can cause damage to the mechanism.

CD playback sound skips due to vibration.

- Improper mounting of the unit.
 - Securely re-mount the unit.
- The disc is very dirty.
 - Clean the disc.
- The disc has scratches.
 - Change the disc.
- The pick-up lens is dirty.
 - Do not use a commercially available lens cleaner disc. Consult your nearest Alpine dealer.

CD playback sound skips without vibration.

- The disc is dirty or scratched.
 - Clean the disc; damaged disc should be replaced.

Error displays (built-in CD player only)

- Mechanical error
 - Press ▲. After the error indication disappears, insert the disc again. If the above-mentioned solution does not solve the problem, consult your nearest Alpine dealer.

CD-R/CD-RW playback not possible

- Close session (finalization) has not been performed.
 - Perform finalization and attempt playback again.

MP3 (CDE-9846 only)

MP3 is not played back.

- Writing error occurred. The CD format is not compatible.
 - Make sure the CD has been written in a supported format. Refer to "About MP3" (pages 10-11), then rewrite in the format supported by this device.

* CDE-9846 is compatible with MP3.

Audio

The sound is not output from the speakers.

- Unit has no output signal of the internal amplifier.
 - PWR-IC is switched to "ON" (page 17).

Indication for CD Player

HI TEMP

- Protective circuit is activated due to high temperature.
 - The indication will disappear when the temperature returns to normal operating range.

NO DISC

- No CD is inserted.
 - Insert a CD.
- Although a disc is inserted, "NO DISC" is displayed and the unit does not start to play or eject the disc.
 - Remove the disc by following these steps:
 - Press the **▲** button again for at least 2 seconds.
 - If the disc still does not eject, consult your Alpine dealer.

ERROR

- Mechanism error.
 - 1) Press the **▲** button and eject the CD.
 - If not ejecting, consult your Alpine dealer.
 - 2) When the error indication remains after ejecting, press the **▲** button again.
 - If the error indication still does not turn off after pressing the **▲** button for a few times, consult your Alpine dealer.
- When "ERROR" is displayed:
 - If that the disc cannot be ejected by pressing **▲**, press the RESET switch (refer to page 5) and press **▲** again.
 - If the disc still cannot be ejected, consult your Alpine dealer.
- The disc is not compatible with the unit.
 - Insert a disc which is compatible with the unit.

UNSUPPORT

(CDE-9846 only)

- The disc is not written in a MP3 supported format.
 - Use a disc written at the MP3 supported format.

Specifications

FM TUNER SECTION

Tuning Range	87.7 – 107.9 MHz**
Mono Usable Sensitivity	9.3 dBf (0.8 μ V/75 ohms)
50 dB Quieting Sensitivity	13.5 dBf (1.3 μ V/75 ohms)
Alternate Channel Selectivity	80 dB
Signal-to-Noise Ratio	65 dB
Stereo Separation	35 dB
Capture Ratio	2.0 dB

AM TUNER SECTION

Tuning Range	530 – 1,710 kHz**
Sensitivity (IEC Standard)	22.5 μ V/27 dB

CD PLAYER SECTION

Frequency Response	5 – 20,000 Hz (\pm 1 dB)
Wow & Flutter (% WRMS)	Below measurable limits
Total Harmonic Distortion	0.008% (at 1 kHz)
Dynamic Range	95 dB (at 1 kHz)
Signal-to-Noise Ratio	105 dB
Channel Separation	85 dB (at 1 kHz)

PICKUP

Wave length	795 nm
Laser power	CLASS I

GENERAL

Power Requirement	14.4 V DC (11–16 V allowable)
Power Output	16 W RMS \times 4*
* Primary amplifier ratings per CEA-2006 Standard	
• Power output: measured at 4 Ohms and \leq 1% THD+N	
• S/N: 80 dBA (reference: 1 W into 4 Ohms)	
Bass	+20 dB/-14 dB at 100 Hz
Treble	\pm 14 dB at 10 kHz
Maximum Pre-Output Voltage	2 V/10 k ohms
Weight	1.6 kg (3 lbs. 8 oz)

CHASSIS SIZE

Width	178 mm (7")
Height	50 mm (2")
Depth	160 mm (6-1/4")

NOSEPIECE SIZE

Width	170 mm (6-3/4")
Height	46 mm (1-13/16")
Depth	18 mm (11/16")

- Due to continuous product improvement, specifications and design are subject to change without notice.

** CDE-9846:

When you choose "AREA 2" in the section "Changing the Radio Frequencies for each Country" (page 6), the tuning range is as follows.

FM : 87.5 - 108.0 MHz

AM : 531 - 1,602 kHz

Installation and Connections

Before installing or connecting the unit, please read the following and pages 2 to 4 of this manual thoroughly for proper use.

Warning

MAKE THE CORRECT CONNECTIONS.

Failure to make the proper connections may result in fire or product damage.

USE ONLY IN CARS WITH A 12 VOLT NEGATIVE GROUND.

(Check with your dealer if you are not sure.) Failure to do so may result in fire, etc.

BEFORE WIRING, DISCONNECT THE CABLE FROM THE NEGATIVE BATTERY TERMINAL.

Failure to do so may result in electric shock or injury due to electrical shorts.

DO NOT ALLOW CABLES TO BECOME ENTANGLED IN SURROUNDING OBJECTS.

Arrange wiring and cables in compliance with the manual to prevent obstructions when driving. Cables or wiring that obstruct or hang up on places such as the steering wheel, gear lever, brake pedals, etc. can be extremely hazardous.

DO NOT SPLICE INTO ELECTRICAL CABLES.

Never cut away cable insulation to supply power to other equipment. Doing so will exceed the current carrying capacity of the wire and result in fire or electric shock.

DO NOT DAMAGE PIPE OR WIRING WHEN DRILLING HOLES.

When drilling holes in the chassis for installation, take precautions so as not to contact, damage or obstruct pipes, fuel lines, tanks or electrical wiring. Failure to take such precautions may result in fire.

DO NOT USE BOLTS OR NUTS IN THE BRAKE OR STEERING SYSTEMS TO MAKE GROUND CONNECTIONS.

Bolts or nuts used for the brake or steering systems (or any other safety-related system), or tanks should NEVER be used for installations or ground connections. Using such parts could disable control of the vehicle and cause fire etc.

DO NOT INSTALL IN LOCATIONS WHICH MIGHT HINDER VEHICLE OPERATION, SUCH AS THE STEERING WHEEL OR GEARSHIFT.

Doing so may obstruct forward vision or hamper movement etc. and results in serious accident.

Caution

HAVE THE WIRING AND INSTALLATION DONE BY EXPERTS.

The wiring and installation of this unit requires special technical skill and experience. To ensure safety, always contact the dealer where you purchased this product to have the work done.

USE SPECIFIED ACCESSORY PARTS AND INSTALL THEM SECURELY.

Be sure to use only the specified accessory parts. Use of other than designated parts may damage this unit internally or may not securely install the unit in place. This may cause parts to become loose resulting in hazards or product failure.

ARRANGE THE WIRING SO IT IS NOT CRIMPED OR PINCHED BY A SHARP METAL EDGE.

Route the cables and wiring away from moving parts (like the seat rails) or sharp or pointed edges. This will prevent crimping and damage to the wiring. If wiring passes through a hole in metal, use a rubber grommet to prevent the wire's insulation from being cut by the metal edge of the hole.

DO NOT INSTALL IN LOCATIONS WITH HIGH MOISTURE OR DUST.

Avoid installing the unit in locations with high incidence of moisture or dust. Moisture or dust that penetrates into this unit may result in product failure.

Precautions

- Be sure to disconnect the cable from the (-) battery post before installing your CDE-9846/CDE-9842. This will reduce any chance of damage to the unit in case of a short-circuit.
- Be sure to connect the color coded leads according to the diagram. Incorrect connections may cause the unit to malfunction or damage to the vehicle's electrical system.
- When making connections to the vehicle's electrical system, be aware of the factory installed components (e.g. on-board computer). Do not tap into these leads to provide power for this unit. When connecting the CDE-9846/CDE-9842 to the fuse box, make sure the fuse for the intended circuit of the CDE-9846/CDE-9842 has the appropriate amperage. Failure to do so may result in damage to the unit and/or the vehicle. When in doubt, consult your Alpine dealer.
- The CDE-9846/CDE-9842 uses female RCA-type jacks for connection to other units (e.g. amplifier) having RCA connectors. You may need an adaptor to connect other units. If so, please contact your authorized Alpine dealer for assistance.
- Be sure to connect the speaker (-) leads to the speaker (-) terminal. Never connect left and right channel speaker cables to each other or to the vehicle body.

IMPORTANT

Please record the serial number of your unit in the space provided below and keep it as a permanent record. The serial number plate is located on the bottom of the unit.

SERIAL NUMBER: _____
INSTALLATION DATE: _____
INSTALLATION TECHNICIAN: _____
PLACE OF PURCHASE: _____

Installation

Accessory List

- Head unit 1
- Power cable 1
- Mounting sleeve 1
- Carrying case 1
- Bracket 2
- Screw (M5 × 8) 4
- Owner's Manual 1 set

Note:

The main unit must be mounted within 35 degrees of the horizontal plane, back to front.

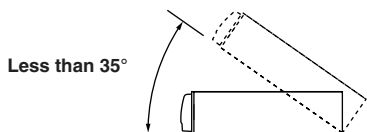

1

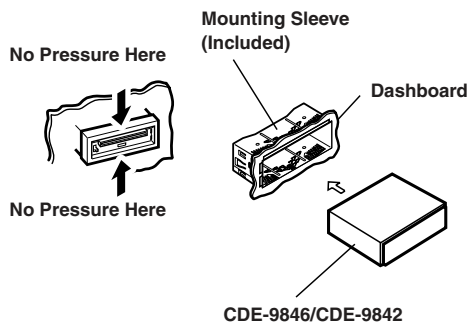

Remove the Detachable Front Panel (refer to page 5). Slide mounting sleeve from main unit. (see "Removal" on this page). Slide the mounting sleeve into the dashboard.

- Please examine the installation. Make certain that no external pressure is applied to either the top of the unit or the removable nosepiece.

2

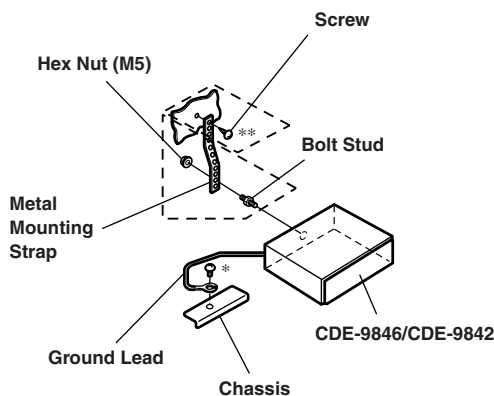

Reinforce the head unit with the metal mounting strap (not supplied). Secure the ground lead of the unit to a clean metal spot using a screw (*) already attached to the vehicle's chassis.

- For the screw marked **, use an appropriate screw for the chosen mounting location.

Connect each input lead coming from an amplifier or equalizer to the corresponding output lead coming from the left rear of the CDE-9846/CDE-9842. Connect all other leads of the CDE-9846/CDE-9842 according to details described in the CONNECTION section.

- 3 Slide the CDE-9846/CDE-9842 into the dashboard until it clicks. This ensures that the unit is properly locked and will not accidentally come out from the dashboard. Install the Detachable Front Panel.

Removal

- 1 Remove the DETACHABLE FRONT PANEL.
- 2 Insert the brackets into the back, along the guides on either side of the unit. The unit can now be removed from the mounting sleeve.

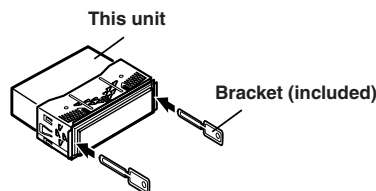

- 3 Pull the unit out, keeping it unlocked as you do so.

<JAPANESE CAR>

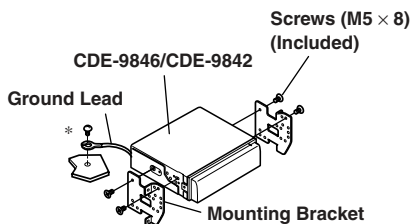
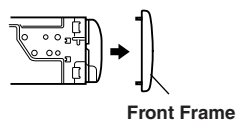

- Secure the ground lead of the unit to a clean metal spot using a screw (*) already attached to the vehicle's chassis.

Connections

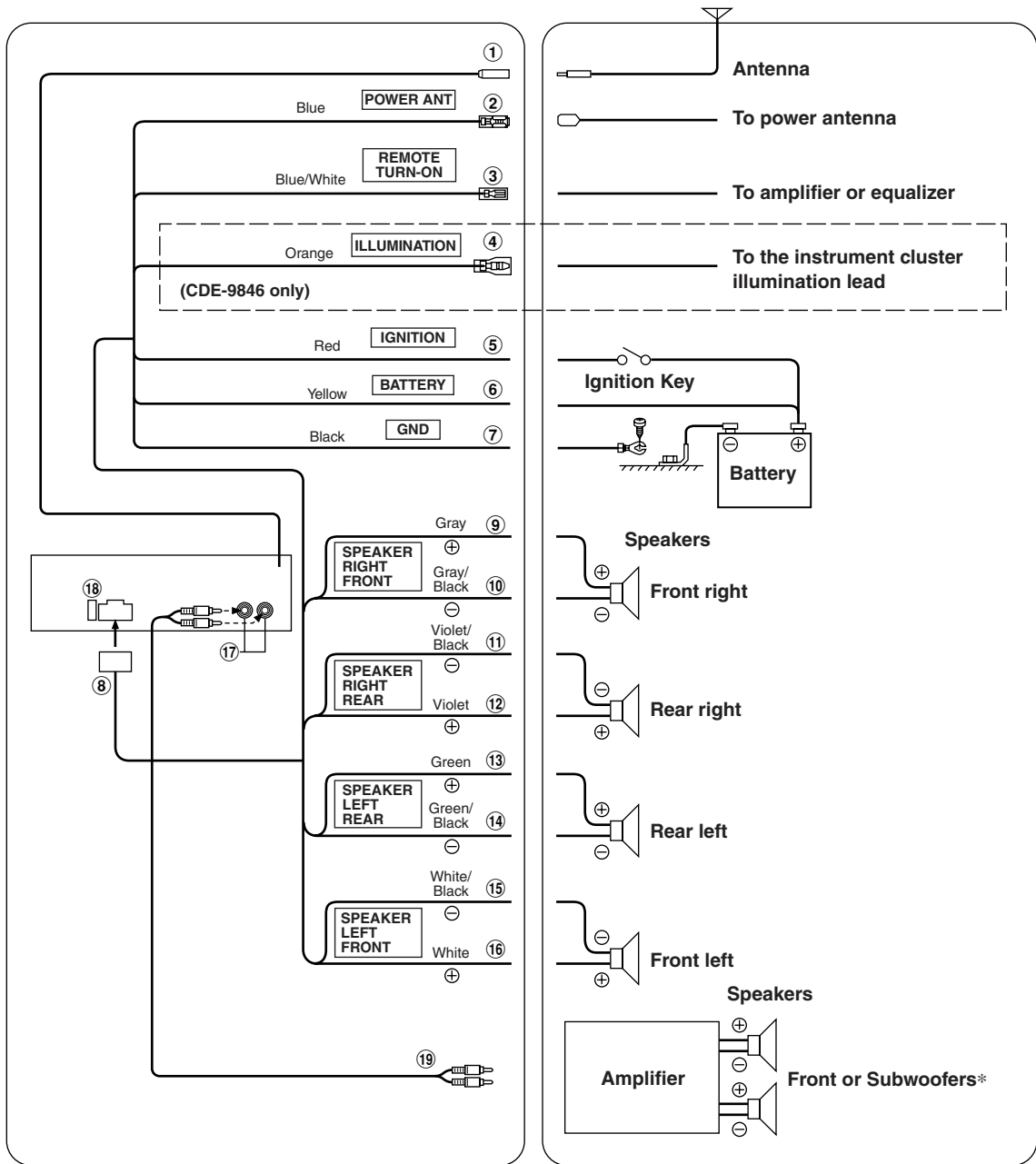

* When Subwoofer is set to OFF: Output is from Front speakers.
 When Subwoofer is set to ON: Output is from Subwoofer.

For details on how to set the Subwoofer to ON/OFF, see "Subwoofer On and Off" on page 16.

- ① Antenna Receptacle
- ② Power Antenna Lead (Blue)
Connect this lead to the +B terminal of your power antenna, if applicable.
- ③ Remote Turn-On Lead (Blue/White)
Connect this lead to the remote turn-on lead of your amplifier or signal processor.
- ④ Illumination Lead (Orange) (CDE-9846 only)
This lead may be connected to the vehicle's instrument cluster illumination lead. This will allow the backlighting of the unit to dim whenever the vehicle's lights are turned on.
- ⑤ Switched Power Lead (Ignition) (Red)
Connect this lead to an open terminal on the vehicle's fuse box or another unused power source which provides (+)12V only when the ignition is turned on or in the accessory position.
- ⑥ Battery Lead (Yellow)
Connect this lead to the positive (+) post of the vehicle's battery.
- ⑦ Ground Lead (Black)
Connect this lead to a good chassis ground on the vehicle. Make sure the connection is made to bare metal and is securely fastened using the sheet metal screw provided.
- ⑧ Power Supply Connector
- ⑨ Right Front (+) Speaker Output Lead (Gray)
- ⑩ Right Front (-) Speaker Output Lead (Gray/Black)
- ⑪ Right Rear (-) Speaker Output Lead (Violet/Black)
- ⑫ Right Rear (+) Speaker Output Lead (Violet)
- ⑬ Left Rear (+) Speaker Output Lead (Green)
- ⑭ Left Rear (-) Speaker Output Lead (Green/Black)
- ⑮ Left Front (-) Speaker Output Lead (White/Black)
- ⑯ Left Front (+) Speaker Output Lead (White)
- ⑰ Front/Subwoofer Output RCA Connectors
RED is right and WHITE is left.
- ⑱ Fuse Holder (10A)
- ⑲ RCA Extension Cable (Sold Separately)

To prevent external noise from entering the audio system.

- Locate the unit and route the leads at least 10cm away from the car harness.
- Keep the battery power leads as far away from other leads as possible.
- Connect the ground lead securely to a bare metal spot (remove any paint, dirt or grease if necessary) of the car chassis.
- If you add an optional noise suppressor, connect it as far away from the unit as possible. Your Alpine dealer carries various Alpine noise suppressors, contact them for further information.
- Your Alpine dealer knows best about noise prevention measures so consult your dealer for further information.



LIMITED WARRANTY

ALPINE ELECTRONICS OF AMERICA, INC. AND ALPINE OF CANADA INC. ("Alpine"), are dedicated to quality craftsmanship and are pleased to offer this Warranty. We suggest that you read it thoroughly. Should you have any questions, please contact your Dealer or contact Alpine at one of the telephone numbers listed below.

●PRODUCTS COVERED:

This Warranty covers Car Audio Products and Related Accessories ("the product"). Products purchased in the Canada are covered only in the Canada. Products purchased in the U.S.A. are covered only in the U.S.A.

●LENGTH OF WARRANTY:

This Warranty is in effect for one year from the date of the first consumer purchase.

●WHO IS COVERED:

This Warranty only covers the original purchaser of the product, who must reside in the United States, Puerto Rico or Canada.

●WHAT IS COVERED:

This Warranty covers defects in materials or workmanship (parts and labor) in the product.

●WHAT IS NOT COVERED:

This Warranty does not cover the following:

- ① Damage occurring during shipment of the product to Alpine for repair (claims must be presented to the carrier).
- ② Damage caused by accident or abuse, including burned voice coils caused by over-driving the speaker (amplifier level is turned up and driven into distortion or clipping). Speaker mechanical failure (e.g. punctures, tears or rips). Cracked or damaged LCD panels. Dropped or damaged hard drives.
- ③ Damage caused by negligence, misuse, improper operation or failure to follow instructions contained in the Owner's manual.
- ④ Damage caused by act of God, including without limitation, earthquake, fire, flood, storms or other acts of nature.
Any cost or expense related to the removal or reinstallation of the product.
- ⑤ Service performed by an unauthorized person, company or association.
- ⑥ Any product which has the serial number defaced, altered or removed.
- ⑦ Any product which has been adjusted, altered or modified without Alpine's consent.
- ⑧ Any product not distributed by Alpine within the United States, Puerto Rico or Canada.
- ⑨ Any product not purchased from an Authorized Alpine Dealer.

●HOW TO OBTAIN WARRANTY SERVICE:

- ① You are responsible for delivery of the product to an Authorized Alpine Service Center or Alpine for repair and for payment of any initial shipping charges. Alpine will, at its option, repair or replace the product with a new or reconditioned product without charge. If the repairs are covered by the warranty, and if the product was shipped to an Authorized Alpine Service Center or Alpine, Alpine will pay the return shipping charges.
- ② You should provide a detailed description of the problem(s) for which service is required.

- ③ You must supply proof of your purchase of the product.
- ④ You must package the product securely to avoid damage during shipment. To prevent lost packages it is recommended to use a carrier that provides a tracking service.

●HOW WE LIMIT IMPLIED WARRANTIES:

ANY IMPLIED WARRANTIES INCLUDING FITNESS FOR USE AND MERCHANTABILITY ARE LIMITED IN DURATION TO THE PERIOD OF THE EXPRESS WARRANTY SET FORTH ABOVE AND NO PERSON IS AUTHORIZED TO ASSUME FOR ALPINE ANY OTHER LIABILITY IN CONNECTION WITH THE SALE OF THE PRODUCT.

●HOW WE EXCLUDE CERTAIN DAMAGES:

ALPINE EXPRESSLY DISCLAIMS LIABILITY FOR INCIDENTAL AND CONSEQUENTIAL DAMAGES CAUSED BY THE PRODUCT. THE TERM "INCIDENTAL DAMAGES" REFERS TO EXPENSES OF TRANSPORTING THE PRODUCT TO THE ALPINE SERVICE CENTER, LOSS OF THE ORIGINAL PURCHASER'S TIME, LOSS OF THE USE OF THE PRODUCT, BUS FARES, CAR RENTALS OR OTHERS COSTS RELATING TO THE CARE AND CUSTODY OF THE PRODUCT. THE TERM "CONSEQUENTIAL DAMAGES" REFERS TO THE COST OF REPAIRING OR REPLACING OTHER PROPERTY WHICH IS DAMAGED WHEN THIS PRODUCT DOES NOT WORK PROPERLY. THE REMEDIES PROVIDED UNDER THIS WARRANTY ARE EXCLUSIVE AND IN LIEU OF ALL OTHERS.

●HOW STATE/PROVINCIAL LAW RELATES TO THE WARRANTY:

This Warranty gives you specific legal rights, and you may also have other rights which vary from state to state and province to province. In addition, some states/provinces do not allow limitations on how long an implied warranty lasts, and some do not allow the exclusion or limitation of incidental or consequential damages. Accordingly, limitations as to these matters contained herein may not apply to you.

●IN CANADA ONLY:

This Warranty is not valid unless your Alpine car audio product has been installed in your vehicle by an Authorized Installation Center, and this warranty stamped upon installation by the installation center.

●HOW TO CONTACT CUSTOMER SERVICE:

Should the product require service, please call the following number for your nearest Authorized Alpine Service Center.

**CAR AUDIO 1-800-ALPINE-1 (1-800-257-4631)
NAVIGATION 1-888-NAV-HELP (1-888-628-4357)**

Or visit our website at: <http://www.alpine-usa.com>

ALPINE ELECTRONICS OF AMERICA, INC., 19145 Gramercy Place, Torrance, California 90501, U.S.A.

ALPINE ELECTRONICS OF CANADA, INC., 777 Supertest Road, Toronto, Ontario M3J 2M9, Canada

Do not send products to these addresses.

Call the toll free telephone number or visit the website to locate a service center.



NO POSTAGE
NECESSARY
IF MAILED
IN THE
UNITED STATES



POSTAGE WILL BE PAID BY ADDRESSEE

ATTENTION MARKETING SERVICES
ALPINE ELECTRONICS OF AMERICA INC
PO BOX 2859
TORRANCE CA 90509-9939

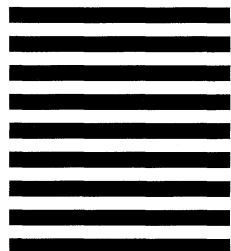

ALPINE Customer Care Registration



For easy on-line registration, go to "www.alpine-usa.com/registration"

Thank you for choosing Alpine! Please register your product with us so we can serve you better.

First name: _____

Last name: _____

Home address: _____
Street address

City _____ State/Prov. _____ Zip Code _____

May we contact you at this address? 1. Yes 2. No

Phone number: () _____

May we contact you at this number? 1. Yes 2. No

E-mail Address: _____

May we contact you by e-mail? 1. Yes 2. No

Gender 1. Male 2. Female

Date of Birth Month: _____ Year: _____

Marital Status 1. Single 2. Married

Which ethnicity best describes yourself:

- 1. Caucasian
- 2. Hispanic
- 3. African-American
- 4. Asian
- 5. Other _____

Your highest level of education completed:

- 1. High School Student
- 2. High School Graduate
- 3. 2 Yr. Degree/Some College
- 4. Completed 4 Yr. College
- 5. Completed Graduate School

Product purchased

- 1. Cassette Player
- 2. CD Player
- 3. MD Player
- 4. DVD Player
- 5. CD Changer
- 6. Amplifier
- 7. Speaker
- 8. Subwoofer
- 9. Monitor Controller
- 10. Video Monitor
- 11. Navigation
- 12. Mobile Mayday
- 13. Video Tape Player
- 14. Processor/Equalizer
- 15. Security
- 16. Other _____

Model Number: _____

Serial Number: _____

Date of Purchase: Month: _____ Year: _____

If navigation system, which monitor?

- 1. Alpine → (Model No.) _____
- 2. Other → (Brand Name) _____

Purpose of buying this unit?

- 1. Addition
- 2. Replacement → *Previous brand replaced?
 - 1. Factory installed
 - 2. Alpine
 - 3. Other _____

Have you purchased Alpine products before?

- 1. First time
- 2. Two or more times

When you purchased this Alpine unit, did you compare it with other brands?

- 1. Yes
- 2. No

(Brand Name) _____

Which of the following statements best describes you?

- 1. I usually have more electronic equipment than my friends
- 2. I am usually one of the first of my friends to buy the newest electronic equipment
- 3. I usually wait until a product has been out for a while before I purchase it
- 4. I am usually one of the first of my friends to know about the newest car
- 5. I usually know more about cars than my friends

Occupation

- 1. Executive/Managerial
- 2. Secretarial/Clerical
- 3. Sales
- 4. General Labor
- 5. Professional
- 6. Engineering/Technical
- 7. Farming/Fishing
- 8. Retired
- 9. Student
- 10. Other _____

Household Income

- 1. Less than \$30,000
- 2. \$30,000 - \$50,000
- 3. \$50,000 - \$70,000
- 4. \$70,000 - \$90,000
- 5. \$90,000 - \$110,000
- 6. Over \$110,000

Type of vehicle in which this unit is installed.

Make: _____ Model: _____

Purchased Year: _____ Model Year: _____

How was this vehicle purchased?

- 1. Bought
- 2. Leased

SEAL HERE

SEAL HERE

Thank you for your cooperation! We value your privacy. This information will remain confidential with Alpine and its affiliates.

Customer Care Registration is for Product registration.
Failure to complete and return this card does not diminish your warranty rights.

PART NO. 68P04190K01-A

Free Manuals Download Website

<http://myh66.com>

<http://usermanuals.us>

<http://www.somanuals.com>

<http://www.4manuals.cc>

<http://www.manual-lib.com>

<http://www.404manual.com>

<http://www.luxmanual.com>

<http://aubethermostatmanual.com>

Golf course search by state

<http://golfingnear.com>

Email search by domain

<http://emailbydomain.com>

Auto manuals search

<http://auto.somanuals.com>

TV manuals search

<http://tv.somanuals.com>