



Mobile Multimedia Station

IVA-D310



MP3 MLX



- **OWNER'S MANUAL**
Please read before using this equipment.
- **MODE D'EMPLOI**
Veuillez lire avant d'utiliser cet appareil.
- **MANUAL DE OPERACIÓN**
Léalo antes de utilizar este equipo.

ALPINE ELECTRONICS MARKETING, INC.
1-1-8 Nishi Gotanda,
Shinagawa-ku,
Tokyo 141-0031, Japan
Phone 03-5496-8231

ALPINE ELECTRONICS OF AMERICA, INC.
19145 Gramercy Place, Torrance,
California 90501, U.S.A.
Phone 1-800-ALPINE-1 (1-800-257-4631)

ALPINE ELECTRONICS OF CANADA, INC.
777 Supertest Road, Toronto,
Ontario M3J 2M9, Canada
Phone 1-800-ALPINE-1 (1-800-257-4631)

ALPINE ELECTRONICS OF AUSTRALIA PTY. LTD.
6-8 Fiveways Boulevard Keysborough,
Victoria 3173, Australia
Phone 03-9769-0000

ALPINE ELECTRONICS GmbH
Frankfurter Ring 117,
80807 München, Germany
Phone 089-32 42 640

ALPINE ELECTRONICS OF U.K. LTD.
Alpine House
Fletchamstead Highway, Coventry CV4 9TW, U.K.
Phone 0870-33 33 763

ALPINE ELECTRONICS FRANCE S.A.R.L.
(RCS PONTOISE B 338 101 280)
98, Rue de la Belle Etoile, Z.I. Paris Nord II,
B.P. 50016, 95945 Roissy Charles de Gaulle
Cedex, France
Phone 01-48638989

ALPINE ITALIA S.p.A.
Viale C. Colombo 8, 20090 Trezzano
Sul Naviglio (MI), Italy
Phone 02-484781

ALPINE ELECTRONICS DE ESPAÑA, S.A.
Portal de Gamarra 36, Pabellón, 32
01013 Vitoria (Alava)-APDO 133, Spain
Phone 945-283588

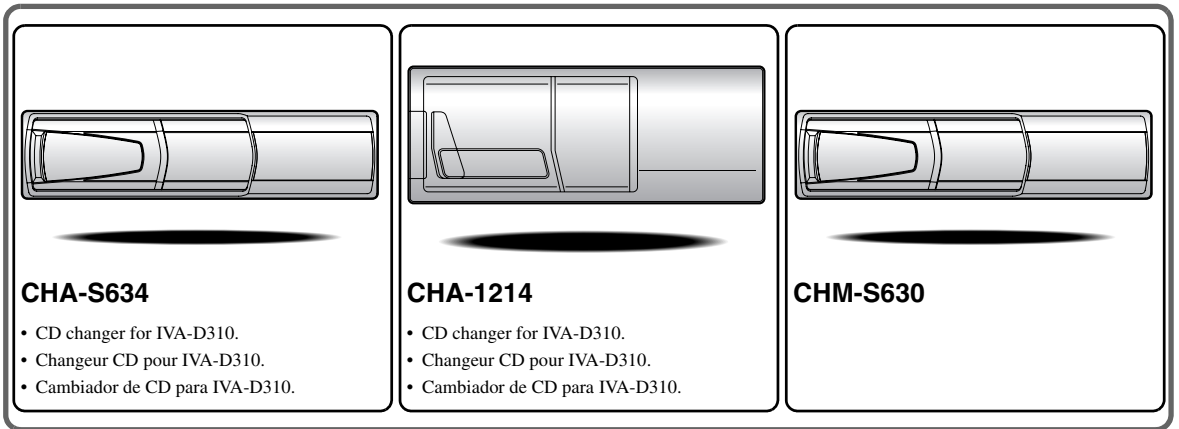

Alpine CD Changers Give You More!

More musical selections, more versatility, more convenience.

The CHA-S634 is a high-performance 6-disc changer with a new M DAC, CD-R/RW PLAY BACK, MP3 PLAY BACK and CD TEXT. The CHA-1214 Ai-NET model holds 12 discs, and the CHM-S630 M-Bus model is a super-compact 6-disc changer with a CD-R/RW PLAY BACK.

Changeurs de CD Alpine : vous avez le choix!

Plus de sélections musicales, plus de souplesse, plus de confort.

Le modèle CHA-S634 est un changeur 6 disques ultra performant équipé des nouvelles fonctions M DAC, CD-R/RW PLAY BACK, MP3 PLAY BACK et CD TEXT. Le modèle CHA-1214 Ai-NET contient 12 disques. Le modèle CHM-S630 M-Bus est un changeur 6 disques super compact doté de la fonction CD-R/RW PLAY BACK.

¡Los cambiadores Alpine de CD le ofrecen más!

Más selecciones musicales, más versatilidad y más ventajas.

CHA-S634 es un cambiador de seis discos de alto rendimiento con nuevo M DAC, CD-R/RW PLAY BACK, MP3 PLAY BACK y CD TEXT. El modelo CHA-1214 Ai-NET alberga 12 discos y el modelo CHM-S630 M-Bus es un cambiador de seis discos de tamaño reducido con un CD-R/RW PLAY BACK.

Contents

Operating Instructions

WARNING

WARNING	5
CAUTION	5
PRECAUTIONS	5
Discs Playable on This Unit	7

Getting Started

Location of Controls	10
Detaching and Attaching the Front Panel	10
Initial System Start-Up	11
Turning Power On or Off	11
Opening/Closing the Monitor	11
Adjusting the Monitor Viewing Angle	11
Moving the Monitor to be Flat	12
Adjusting the Volume	12
Lowering Volume Quickly	12
How to view the Display	12
Touch button operation	12
Recalling the Source	12
Shortcut Screen	13
Displaying the Numeric Keypad	
Input Screen	13
Dual-Screen Display	14

Radio

Listening to the Radio	14
Manual Storing of Station Presets	15
Automatic Memory of Station Presets	15
Tuning to Preset Stations	15

CD/MP3/WMA

Playback	16
Repeat Play	16
M.I.X. (Random Play)	16
Selecting Folders	
(concerning MP3/WMA)	16
About MP3/WMA	17

DVD/Video CD

Playing DVD/Video CD	18
To display the DVD mode screen	19
If a menu screen appears	19
Displaying the Top Menu Screen	
(DVD only)	20
Displaying the Menu Screen (DVD only) ...	20
Displaying the Menu Operation Mode Screen	
(DVD only)	20
Turning the PBC Function ON or OFF	
(Video CD only)	20
Stopping Playback (PRE STOP)	20
Stopping Playback	20
Fast-forwarding/Fast-reversing	20
Finding the Beginnings of Chapters or	
Tracks	21
Playing Still Frames (Pausing)	21
Forward/reverse frame-by-frame Playback	21
Slow Motion Playback	21
Chapter/Track/Title Repeat Playback	21
Searching by Title Number (DVD only)	21
Searching Directly by Chapter or	
Track Number	22
Switching the Angle (DVD only)	22
Switching the Audio Tracks	22
Switching the Subtitles (Subtitle Language)	
(DVD only)	22
Switching from the disc menu	23
Displaying the Disc Status for	
DVD/Video CD	23

Other Useful Features

Adjusting the Audio	23
Search Function	24
Rear Entertainment Function	25
Switching the function of	
the remote sensor	25
Switching Display Modes	25
Switching the Visual Source Only	
(Simultaneous Function)	26
Cancelling the Simultaneous Function	26
Blackout Mode On and Off	26
Setting VISUALIZER	26
Setting the Visual Effect	26

Monitor Setting

Monitor Setting Operation	27
Selecting the Monitor Position	27
Setting Automatic Opening/Closing of the Monitor	27

Setup

DVD Setup

DVD Setup Operation	27
Setting of the Menu Language	28
Setting of the Audio Language	28
Setting of the Subtitle Language	28
Changing the Country Code Setting	28
Setting the Rating Level (Parental Lock)	29
Changing the Digital Output Setting	29
Setting the Downmix Mode	31
Setting the TV Screen Setting	31

GENERAL Setup

General Setup Operation	31
Displaying the Time	32
Setting the Time	32
Setting Daylight Saving Time	32
Demonstration Function	32
Sound (Beep) Guide Function	32
Setting the Scroll	32
Setting the Sound Quality of the Tuner	32
Setting the Auxiliary Data Field Display	32
Playing MP3/WMA Data	32
Adjusting the Dimmer of Button Lighting at Night	32

SYSTEM Setup

System Setup Operation	33
Setting the External Device Interrupt Mode	33
Setting the Interrupt Icon Display	33
Setting the Navigation Mode	33
Setting the Navigation Interruption	33
Setting the VISUALIZER Mode Display ...	34
Setting the AUX Mode	34
Naming External Devices	34
Adjusting the External Input Audio Level	34
Setting of the External Monitor Output	34
Setting of the Rear Camera	34
Setting the VISUAL Touch Button	34
Optical Digital Input Selection for an External Audio Processor	35

Setting the Digital Output	35
----------------------------------	----

DISPLAY Setup

Display Setup Operation	35
Setting the Brightness of the Backlighting	35
Adjusting the Minimum Level of Backlight	36
Switching Background Textures	36
Setting Automatic Background Textures	36
Setting the Font Type	36
Switching the Font Back Display Color	36
Turning the Touch Panel Vibration ON or OFF	36
Adjusting the Touch Panel	36

i-Personalize™

Media Xpander Function

Setting the MX mode	37
---------------------------	----

Bass Engine Function

Setting the Bass Engine	37
Selecting Bass Max EQ mode (Maker's setting)	38
Adjusting and Storing/Recalling the Parametric EQ	38
About the Time Correction	39
Adjustment and Storing/Recalling of Time Correction	39
Adjusting and Storing/Recalling the Bass Focus	40
Adjustment and Storing/Recalling of the Built-in Crossover	41
Subwoofer On and Off	42

VISUAL EQ™

Visual EQ Setting Operation	42
Selecting the VISUAL EQ Mode (Maker's setting)	42
Adjusting Brightness	42
Adjusting Color of Picture	42
Adjusting Tint of Picture	42
Adjusting Image Contrast	42
Adjusting Picture Quality	43
Storing VISUAL EQ	43

Data Download

About SOUND SETUP/BACKGROUND
 Download 43
 Data Downloading 43
 Downloading the
 MY BACKGROUND data 44

Setting AMP Link (Optional)

Recalling the Display of the External Amplifier
 Setting and Status (Option) 44
 AMP Link Lock Function 44

External Audio Processor (Optional)

Adjustment Procedure for Dolby Surround ... 45
 Setting the Speakers 46
 Set MX Mode of the External
 Audio Processor 46
 X-OVER Adjustment 46
 Performing Time Correction Manually
 (TCR) 47
 Phase Switching 48
 Graphic Equalizer Adjustments 48
 Parametric Equalizer Adjustments 49
 Setting Bass Sound Control 50
 Setting Bass Compressor 50
 Setting Bass Focus 50
 Speaker Setup 50
 Setting of Dolby 5.1ch 51
 Adjusting the acoustic image 51
 Mixing bass sound to the rear channel 51
 Achieving powerful high volume sound 51
 Adjusting the speaker levels 51
 Adjusting the DVD Level 51
 Storing Settings in the Memory 52
 Getting out the Preset Memory 52
 Using the Pro Logic II Mode 52
 Linear PCM Setting 53

Navigation System (Optional)

Switching the Navigation Screen
 (Optional) 53

Auxiliary Device (Optional)

Operating Auxiliary Devices (Optional) 54

Changer (Optional)

Controlling CD Changer (Optional) 54
 Multi-Changer Selection (Optional) 55

HDD Player Operation (Optional)

Listening to Music of HDD 55

SAT Radio Receiver (Optional)

Receiving Channels with the SAT Receiver
 (Optional) 56
 Tuning in to Categorized Programs 56
 Changing the Display 56
 Checking the SAT Radio ID Number 56
 Storing Channel Presets 57
 Receiving Stored Channels 57
 Displaying the Category/Channel Name Title
 List 57
 Selecting the Channel directly 57

iPod™ (Optional)

Playback 58
 Searching for a desired Song 58
 Searching by Playlist 58
 Searching by artist name 58
 Searching by album name 58
 Random Play Shuffle (M.I.X.) 59
 Repeat Play 59

About Subdisplay Indications

About Subdisplay Indications 59

Remote Control

Controls on Remote Control 60
 When Using the Remote Control 61
 Battery Replacement 62

Information

About DVDs 62
 Terminology 63
 List of Language Codes 64
 List of Country Codes 65
 In Case of Difficulty 67
 Specifications 71

Installation and Connections

WARNING

Warning	72
Caution	72
Precautions	72
Installation	73
Connections (IVA-D310 Wiring Diagram)	76
System Example	78

LIMITED WARRANTY

Operating Instructions

WARNING



WARNING

This symbol means important instructions. Failure to heed them can result in serious injury or death.

INSTALL THE PRODUCT CORRECTLY SO THAT THE DRIVER CANNOT WATCH TV/VIDEO UNLESS THE VEHICLE IS STOPPED AND THE EMERGENCY BRAKE IS APPLIED.

It is dangerous (and illegal in many states) for the driver to watch TV/Video while driving a vehicle. Installing this product incorrectly enables the driver to watch TV/Video while driving. This may cause a distraction, preventing the driver from looking ahead, thus causing an accident. The driver or other people could be severely injured.

DO NOT WATCH VIDEO WHILE DRIVING.

Watching the video may distract the driver from looking ahead of the vehicle and cause an accident.

DO NOT OPERATE ANY FUNCTION THAT TAKES YOUR ATTENTION AWAY FROM SAFELY DRIVING YOUR VEHICLE.

Any function that requires your prolonged attention should only be performed after coming to a complete stop. Always stop the vehicle in a safe location before performing these functions. Failure to do so may result in an accident.

KEEP THE VOLUME AT A LEVEL WHERE YOU CAN STILL HEAR OUTSIDE NOISE WHILE DRIVING.

Failure to do so may result in an accident.

MINIMIZE DISPLAY VIEWING WHILE DRIVING.

Viewing the display may distract the driver from looking ahead of the vehicle and cause an accident.

DO NOT DISASSEMBLE OR ALTER.

Doing so may result in an accident, fire or electric shock.

USE ONLY IN CARS WITH A 12 VOLT NEGATIVE GROUND.

(Check with your dealer if you are not sure.) Failure to do so may result in fire, etc.

KEEP SMALL OBJECTS SUCH AS BATTERIES OUT OF THE REACH OF CHILDREN.

Swallowing them may result in serious injury. If swallowed, consult a physician immediately.

USE THE CORRECT AMPERE RATING WHEN REPLACING FUSES.

Failure to do so may result in fire or electric shock.

DO NOT BLOCK VENTS OR RADIATOR PANELS.

Doing so may cause heat to build up inside and may result in fire.

USE THIS PRODUCT FOR MOBILE 12V APPLICATIONS.

Use for other than its designed application may result in fire, electric shock or other injury.

DO NOT PLACE HANDS, FINGERS OR FOREIGN OBJECTS IN INSERTION SLOTS OR GAPS.

Doing so may result in personal injury or damage to the product.



CAUTION

This symbol means important instructions. Failure to heed them can result in injury or material property damage.

HALT USE IMMEDIATELY IF A PROBLEM APPEARS.

Failure to do so may cause personal injury or damage to the product. Return it to your authorized Alpine dealer or the nearest Alpine Service Center for repairing.

KEEP FINGERS AWAY WHILE THE MOTORIZED FRONT PANEL OR MOVING MONITOR IS IN MOTION.

Failure to do so may result in personal injury or damage to the product.

DO NOT MIX NEW BATTERIES WITH OLD BATTERIES. INSERT WITH THE CORRECT BATTERY POLARITY.

When inserting the batteries, be sure to observe proper polarity (+ and -) as instructed. Rupture or chemical leakage from the battery may cause fire or personal injury.



PRECAUTIONS

Product Cleaning

Use a soft dry cloth for periodic cleaning of the product. For more severe stains, please dampen the cloth with water only. Anything else has the chance of dissolving the paint or damaging the plastic.

Temperature

Be sure the temperature inside the vehicle is between +45°C (+113°F) and 0°C (+32°F) before turning your unit on.

Moisture Condensation

You may notice the disc playback sound wavering due to condensation. If this happens, remove the disc from the player and wait about an hour for the moisture to evaporate.

Damaged Disc

Do not attempt to play cracked, warped, or damaged discs. Playing a bad disc could severely damage the playback mechanism.

Maintenance

If you have problems, do not attempt to repair the unit yourself. Return it to your Alpine dealer or the nearest Alpine Service Station for servicing.

Never Attempt the Following

Do not grip or pull out the disc while it is being pulled back into the player by the automatic reloading mechanism.

Do not attempt to insert a disc into the unit when the unit power is off.

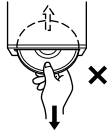

Inserting Discs

Your player accepts only one disc at a time for playback. Do not attempt to load more than one disc.

Make sure the label side is facing up when you insert the disc. Your player will automatically eject any disc that is inserted incorrectly. If the player continues to eject a correctly inserted disc, push the RESET switch with a pointed object such as a ballpoint pen. Playing a disc while driving on a very bumpy road may result in skips, but this will not scratch the disc or damage the player.

Irregular Shaped Discs

Be sure to use round shaped discs only for this unit and never use any special shaped discs.

Use of special shaped discs may cause damage to the mechanism.



New Discs

As a protective measure to prevent the disc from jamming, the DVD player will automatically eject discs with irregular surfaces or inserted incorrectly. When a new disc is inserted into the player and ejected after initial loading, using your finger, feel around the inside of the center hole and outside edge of the disc. If you feel any small bumps or irregularities, this could inhibit proper loading of the disc. To remove the bumps, rub the inside edge of the hole and outside edge of the disc with a ball-point pen or other such instrument, then insert the disc again.

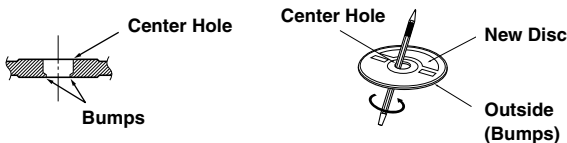

Installation Location

Make sure the IVA-D310 will not be installed in a location subjected to:

- Direct sun and heat
- High humidity and water
- Excessive dust
- Excessive vibrations

Correct Handling

Do not drop the disc while handling. Hold the disc so you will not leave fingerprints on the surface. Do not affix tape, paper, or gummed labels to the disc. Do not write on the disc.

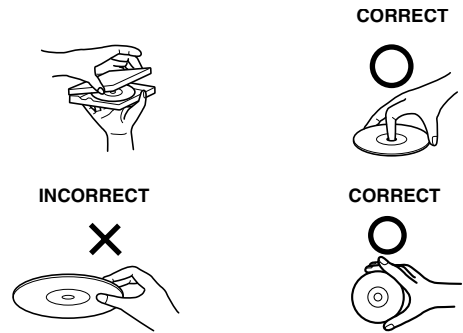

Disc Cleaning

Fingerprints, dust, or soil on the surface of the disc could cause the DVD player to skip. For routine cleaning, wipe the playing surface with a clean, soft cloth from the center of the disc to the outer edge. If the surface is heavily soiled, dampen a clean, soft cloth in a solution of mild neutral detergent before cleaning the disc.



Disc Accessories

There are various accessories available on the market for protecting the disc surface and improving sound quality. However, most of them will influence the thickness and/or diameter of the disc. Using such accessories can cause operational problems. We recommend not using these accessories on discs played in Alpine DVD players.

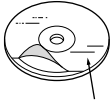

Transparent Sheet

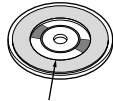

Disc Stabilizer

Handling the Detachable Front Panel

- Do not expose to rain or water.
 - Do not drop or subject to shock.
-
- After turning the system off, a slight ghost of the image will remain temporarily. This is an effect peculiar to LCD technology and is normal.
 - In cold temperature conditions, the screen may lose contrast temporarily. After a short warm-up period, it will return to normal.

Alpine products equipped with the Ai-NET bus, connected to the IVA-D310, can be operated from the IVA-D310. Depending on the products connected, the functions and displays will vary. For details, consult your Alpine dealer.

Operation of some of the functions of this unit is very complex. Because of this, it was deemed necessary to place these functions into a special screen. This will restrict operation of these functions to times when the vehicle is parked. This ensures the focus of the driver's attention will be on the road and not on the IVA-D310. This has been done for the safety of the driver and passengers. Audio Processor Adjustments cannot be made if the car is moving. The car must be parked and the parking brake must be engaged for the procedure described in the Owner's Manual to be valid. The warning "CAN'T OPERATE WHILE DRIVING," will be displayed if any attempts are made to perform these operations while driving.

Discs Playable on This Unit

Playable Discs

The discs listed below can be played on this unit.

	Mark (logo)	Recorded content	Disc size	Max. playing time
DVD Video		Audio + Video (Moving pictures)	12 cm*	One-sided disc Approx. 4 hours
			8 cm	Two-sided disc Approx. 8 hours
Video CD		Audio + Video (Moving pictures)	12 cm	Approx. 74 Minutes
			8 cm	Approx. 20 Minutes
Music CD		Audio	12 cm	Approx. 74 Minutes
			8 cm (CD single)	Approx. 20 Minutes

* Two-layer DVD disc compatible

Discs that cannot be played

DVD-ROMs, DVD-RAMs, DVD + Rs, DVD + RWs, CD-ROMs (excluding MP3/WMA files), photo CDs, etc.

DVD region number (playable region number)

This DVD player will play any disc whose region number is 1 (or All). DVDs with a region number other than those listed below, cannot be played on this DVD player.



Video CDs

This DVD head unit is compatible with playback control (PBC) compatible video CDs (version 2.0).

“PBC” is a function by which you can use menu screens recorded on the disc to find the scene you want to watch and view various types of information in dialog style.

Using compact discs (CD/CD-R/CD-RW)

If you use unspecified compact discs, correct performance cannot be guaranteed.

You can play CD-Rs (CD-Recordable)/CD-RWs (CD-ReWritable) which have been recorded only on audio devices. You can also play CD-Rs/CD-RWs containing MP3/WMA formatted audio files.

- Some of the following discs may not play on this unit:
Flawed discs, discs with fingerprints, discs exposed to extreme temperatures or sunlight (e.g., left in the car or this unit), discs recorded under unstable conditions, discs on which a recording failed or a re-recording was attempted, copy-protected CDs which do not conform to the audio CD industry standard.
- Use discs with MP3/WMA files written in a format compliant with this unit. For details, see pages 17 and 18.

To customers using CD-R/CD-RW

- If a CD-R/CD-RW cannot be played back, make sure the last recording session was closed (finalized).
- Finalize the CD-R/CD-RW if necessary, and attempt playback again.

Tips for making your own CDs

The IVA-D310 plays DVD Video, Video CD, Audio CD and has a built in MP3/WMA decoder.

The following information is designed to help you create your own music CDs (either Audio CD or MP3/WMA encoded CD-R/RW files).

What is the difference between an Audio and MP3/WMA CD?

An Audio CD is the same format as the commercial CDs you buy in the store (also known as CD-DA). MP3 (MPEG-1 Audio Layer 3)/WMA (Windows Media Audio) is a data file that uses a compression scheme to reduce the size of the music file.*

Hybrid Audio CD and Data (MP3/WMA) CD-R/RW discs:

The IVA-D310 can read either sector on the disc. Choose CD-DA to play the CD audio section or MP3/WMA to play the MP3/WMA section.*

Multisession CD-R/RW:

Once a recording has been stopped, this is considered one session. If the disc is not closed (finalized), additional data may be added. Once this additional data has been recorded, this becomes a “multisession” CD. The IVA-D310 can only read multisession DATA Formatted discs (MP3/WMA files - Not Audio CD files).

Properly formatted MP3/WMA Discs:

Use ISO9660 formatting to insure proper playback. You may use standard ISO naming Level 1 (8.3 DOS standard), Level 2 (32 characters) or Joliet (Windows or Macintosh long filenames) file naming conventions*.

*Please consult the Owner’s manual for additional information.

On handling compact discs (CD/CD-R/CD-RW)

- Do not touch the surface.
- Do not expose the disc to direct sunlight.
- Do not affix stickers or labels.
- Clean the disc when it is dusty.
- Make sure that the disc is smooth and flat.
- Do not use commercially available disc accessories.

Do not leave the disc in the car or the unit for a long time. Never expose the disc to direct sunlight.

Heat and humidity may damage the disc and you may not be able to play it again.

Using DVD-Rs/DVD-RWs

- This unit is compatible only with discs recorded in the DVD-Video mode.
Discs recorded in the DVD-VR mode cannot be played back.
- Note that discs not finalized (processed to enable to play on playback-only DVD players) cannot be played on this DVD player.
- Some discs may not play back, depending on the recording device. (This unit has a copy protection function. Discs copied illegally will not be played back. Some files recorded by a software using an improper recording system may be recognized as illegally copied.)
- In the following cases, the disc may not play on this unit: discs recorded by certain DVD recorders, certain irregular discs, flawed discs, dirty discs, when the pickup lens of this DVD player is dirty, or when moisture condensation has occurred inside the unit.
- Be sure to follow all cautions included with your DVD-Rs/DVD-RWs discs.
- Do not put stickers, seals, or tape on the label side of DVD-Rs/DVD-RWs.
- Compared to the regular discs, DVD-Rs/DVD-RWs are more affected by heat, moisture, and direct sunlight. If left in a car, etc., damage may occur and it might not play on this unit.

Disc terminology

Title

If titles are programmed for the DVD, these are the largest units of division of the information recorded on the disc.

Chapter

Each Title may also be divided into smaller divisions, called chapters. These can be specific scenes or musical selections.

- *This product incorporates copyright protection technology that is protected by method claims of certain U.S. patents and other intellectual property rights owned by Macrovision Corporation and other rights owners. Use of this copyright protection technology must be authorized by Macrovision Corporation, and is intended for home and other limited viewing uses only unless otherwise authorized by Macrovision Corporation. Reverse engineering or disassembly is prohibited.*
- **Manufactured under license from Dolby Laboratories.** “Dolby,” “Pro Logic” and the double-D symbol are trademarks of Dolby Laboratories.
- “DTS” and “DTS2.0 + Digital Out” are trademarks of Digital Theater Systems, inc.
- **Windows Media and the Windows logo are trademarks, or registered trademarks of Microsoft Corporation in the United States and/or other countries.**
- **Apple, the Apple logo and iPod are trademarks of Apple Computer, Inc., registered in the U.S. and other countries.**

Getting Started

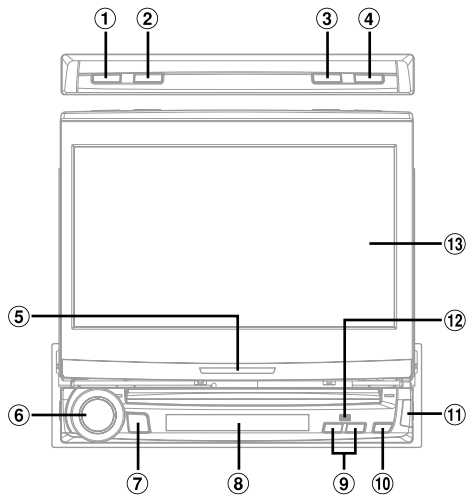

Compatibility with Factory Steering Wheel Radio Controls

If your vehicle has steering wheel controls for the radio, an optional steering wheel control interface may be available to connect to your Alpine radio. For details, contact your Alpine dealer.

Location of Controls

- ① **BAND button**
Radio mode: Changes the band.
Visual source (except navigation screen): Changes the display mode.
- ② **MUTE button**
Turns the MUTE mode ON or OFF.
- ③ **FLAT/SUB DISP. button**
Press to set the open monitor to the flat position. Press and hold for at least 2 seconds to change the display to the subdisplay (Clock ↔ Normal mode for each mode).
- ④ **OPEN/CLOSE button**
Opens and closes the monitor.
- ⑤ **Action Indicator**
The indicator is constantly lit, other than for the following indications.
 - The indicator blinks when closing the monitor.
 - The indicator is turned off when the dimmer (monitor display brightness) is set to ON, and is also turned off according to the brightness of the car when the dimmer is set to AUTO.
 - The indicator slowly blinks when the backlighting (BLACK OUT function) is set to OFF.
 - The indicator blinks in the voice guidance mode when an ALPINE navigation system is connected.
- ⑥ **Rotary encoder**
Adjust the volume by turning to the left or right.
If pressed, the audio adjusting screen is displayed.
- ⑦ **SOURCE/POWER button**
Turns the power on. Press and hold for at least 2 seconds to turn the power off.
Recalls the source selection screen.

- ⑧ **Subdisplay**
Refer to "About Subdisplay Indications" (pages 59 and 60).
- ⑨ **TILT DN/UP button**
Monitor open: The angle of the raised monitor is adjustable between 40° and 105°. If the button is pressed and held, the angle continuously changes.
Monitor closed: Pressing the UP/DN button recalls the radio's presets. Pressing the UP/DOWN button changes the track, file or chapter of a disc. Pressing and holding this button advances or reverses the track, file or chapter of a disc. (the same operation is possible for an optional changer, if connected).
- ⑩ **▲ button**
Ejects a disc.
- ⑪ **▲ button**
Use this button to remove the front panel.
- ⑫ **Remote Sensor**
Point the supplied remote control transmitter towards the remote sensor within a range of 2 meters.
- ⑬ **Monitor**

About the expression of buttons in this Owner's Manual

- The buttons on this unit are expressed in bold (e.g. **SOURCE/POWER**). The touch buttons on the display are expressed in bold with [] (e.g. [**SOURCE**]).
- This Owner's Manual explains mainly the function of touch buttons, when a touch button and a unit button have the same function.

Detaching and Attaching the Front Panel

Detaching

- 1 Turn off the unit power.
- 2 Press **▲** (Release) at the lower right side until the front panel pops out.
- 3 Grasp the right side of the front panel, lift it up slightly then pull it out.

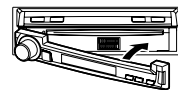

- The front panel may become hot in normal usage (especially the connector terminals on the back of the front panel.) This is not a malfunction.
- To protect the front panel, place it in the supplied carrying case.

Attaching

Attach the front panel squarely onto the main unit until it clicks.

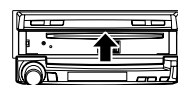

- Before attaching the front panel, make sure that there is no dirt or dust on the connector terminals and no foreign object between the front panel and the main unit.
- Attach the front panel carefully, holding the sides of the front panel to avoid pushing buttons by mistake.

Initial System Start-Up

Immediately after installing or applying power to the unit, it should be initialized. To do this, first, remove the detachable front panel. Behind the front panel, to the left of the connector, there is a small hole. Using a pencil or other pointed object, press the reset switch mounted behind this hole to complete the initialization procedure.



- Any of the buttons does not function while the monitor is closing by reset.

Turning Power On or Off

Some of this unit's functions cannot be performed while the vehicle is in motion. Be sure to stop your vehicle in a safe location and apply the parking brake, before attempting these operations.

1 Press **SOURCE/POWER** to turn on the unit.

- The unit can be turned on by pressing any button on the unit except **OPEN/CLOSE**, **FLAT**, **TILT DN/UP** (when monitor is opened) and **▲** (Eject).

2 Press and hold **SOURCE/POWER** for at least 2 seconds to turn off the unit.

- The IVA-D310 draws minimal current even when its power switch is turned off. If the switched power (ignition) lead of the IVA-D310 is connected directly to the positive (+) post of the vehicle's battery, the battery may be discharged. If this lead is unswitched, it must be disconnected from the battery post should the vehicle be left unused for an extended period of time.

An SPST (Single-Pole, Single-Throw) switch (sold separately) can be added to simplify this procedure. Then, you can simply place it in the OFF position when you leave the vehicle. Turn the SPST switch back ON before using the IVA-D310. For connecting the SPST switch, refer to the "Connection Diagram of SPST Switch (Sold Separately)" (page 75).

- Some operation of the unit cannot be performed while the vehicle is in motion. In this case, be sure to first stop your vehicle and apply the parking brake, then perform the operation.

Opening/Closing the Monitor

1 Press **OPEN/CLOSE**.

The unit beeps 3 times and opens the monitor automatically.

2 Press **OPEN/CLOSE**.

The unit beeps 3 times and closes the monitor automatically.

- Opening/closing the monitor should never be performed manually. It may cause a malfunction.
- The monitor's angle is set to 90 degrees at the factory. Depending on the car, the monitor may hit the dashboard when opened. The monitor will not hit the dashboard when opening. For adjusting the monitor, refer to "Adjusting the Monitor Viewing Angle" (page 11). Even when the vehicle's battery power is removed, the adjusted monitor angle remains stored in memory.
- The IVA-D310 is a precision device. With gentle handling, its unique capabilities can be enjoyed for a long time.
- If the monitor touches anything while it is being opened (or closed), the monitor will beep and stop opening (or closing) immediately. Should this occur, remove the obstacle and press and hold **OPEN/CLOSE** again to lower the monitor.
- When the movable monitor is opened, do not place any object on the monitor and be careful not to bump or apply any pressure to the monitor while it is open. This can cause damage to the mechanism.
- In low ambient temperature conditions, the display may be dark for a short period of time immediately after the power is turned on. Once the LCD has warmed up, the display returns to normal.
- For your safety, some operation of the unit cannot be performed while the vehicle is in motion. In this case, first stop the vehicle and engage the parking brake, then perform the operation.

Adjusting the Monitor Viewing Angle

Adjust the monitor's angle for better visibility.

Press TILT DN and UP to adjust the monitor's angle so the screen will be in the best viewing position.

Pressing the buttons produces a beep and changes the screen angle between 40 and 105 degrees.

- By pressing **TILT DN** or **UP** and holding, the angle changes continuously.
- If the monitor touches an obstacle while the angle is being adjusted the unit stops the screen immediately.
- The screen color will vary when viewed at certain angles. Adjust the screen angle for the best viewing position.
- If the voltage of the vehicle's battery power is low, the screen may blink when the screen angle is changed. This is normal and not a malfunction.

Moving the Monitor to be Flat

When you want to operate some function on the car (air conditioner, etc.) which is hidden by the raised monitor, use this function.

1 When the monitor is open, press **FLAT**.

The monitor moves to the flat position.

2 Press **FLAT** again.

The monitor returns to the previous angle.

- The monitor returns to the previous angle 10 seconds after being moved to the flat position.
- If an excessive force is added to the monitor when the monitor is flat, putting an object on the back of the monitor for example, it may cause a malfunction.

Adjusting the Volume

Adjust the volume by turning the **Rotary encoder**.

Volume: 0 - 35

Lowering Volume Quickly

Activating this function will instantly lower the volume level by 20 dB.

Press **MUTE** to activate the **MUTE mode**.

The audio level decreases by about 20 dB.

Pressing **MUTE** again brings the audio back to its previous level.

How to view the Display

Touch button operation

The display unit is equipped with tactile feedback (PULSETOUCH™).

What is the tactile feedback (PULSETOUCH™) ?

When you touch a button graphic in the display, you will feel a mild vibration and click on the display panel surface. This feedback enables you to easily identify action areas in the display.

- Be sure to touch the button lightly with the pad of your finger on the display to protect the display.
- If you touch a button and there is no reaction, remove your finger from the display once, and try again.

About the expression of touch buttons in this Owner's Manual

- Display buttons in this manual are shown in bold with [] (e.g. **[SOURCE]**).
- This Owner's Manual explains mainly the function of touch buttons, when a touch button and a unit button have the same function.

Recalling the Source

Here is an example explanation for the Radio mode display on how to recall a source.

1 Touch **[SOURCE]** on the main screen.

The source selection screen is displayed.

Display example for source selection screen



① Changes to main source screen

② Displays source modes that can be selected (The kind of source modes that are displayed varies depending on connection and setting)

2 Touch **[RADIO]**.

The screen changes to the Radio mode main display.

Main screen example for Radio mode

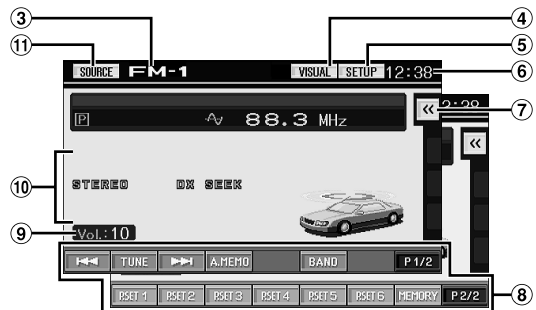

③ Displays the source name, such as radio band, etc., that is selected

④ Changes to VISUAL selection screen

⑤ Changes to SETUP selection screen

⑥ Displays time

⑦ Displays shortcut menu screen (see pages 13)

⑧ Function Guide:

The function guide display varies depending on each source.

The contents of the function guide change by touching [P1/2]* or [P1/3]* on the function guide, and many other operations can be performed.

⑨ Displays volume level

⑩ Working state indicator

⑪ Changes to the source selection screen (to Step 1 screen)

* Display may vary depending on the connected devices.

- When an optional DVD player or DVD changer compatible with Ai-NET is connected, AUX 1 appears as "EXT.DVD" or "DVD CHG" on the display.
- When both the optional DVD player and DVD changer compatible with Ai-NET are connected, AUX 1 appears as "DVD-1" and AUX 2 as "DVD-2" on the display (When the optional expansion box VPE-S431 is connected).
- When i-Personalize and OTHER SETUP are selected, these operations may only be carried out after the car is parked.

3 The screen changes to another source by touching [SOURCE] on the main source screen.

- The screen can be changed to the VISUAL selection screen by touching [VISUAL].
Set to VISUAL in "Setting the VISUAL Touch Button" (page 34).
- The screen can be changed to the SETUP selection screen by touching [SETUP].
- After 5 seconds of each operation in the visual mode, the screen changes to the visual screen only.
To display the source selection screen, touch the display panel, then touch [CONTROL] on the screen. The source selection screen appears by touching [SOURCE] on the changed main source screen.

Shortcut Screen

In the main source display, shortcuts for set up of Media Xpander, Bass MAX EQ, Visual EQ, and DOLBY PLII can be shown and their settings can be made directly.

1 Touch [<<] on the far right of the main source screen.

The shortcut menu screen is displayed. (Displayed when DEFEAT is set to OFF. However, visual EQ is displayed, regardless of turning DEFEAT ON or OFF.)

2 Touch a desired setup menu.

MX (Media Xpander):

Selects the MX mode of the currently displayed audio source.

Visual EQ:

Selectable when the visual source mode is turned on.

DOLBY PLII:

Displayed when an external audio processor is connected.

Bass Max EQ:

Allows choosing any desired mode. (This function cannot be set when an external audio processor is connected. The setting can be carried out on the audio processor.)

Display example for shortcut menu screen



The shortcut menu screen closes by touching this area.

The setup screen is displayed by touching one of these modes.



Display example for setup screen

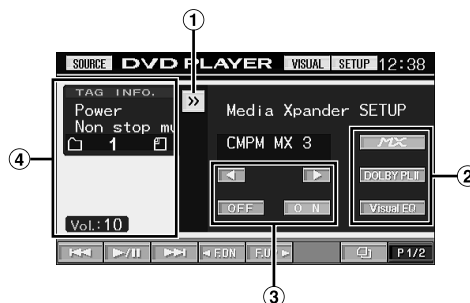

- ① Close the Shortcut menu screen by touching [>>].
- ② The screen changes to the setup screen mode by touching another mode.
- ③ Your desired setting can be made by using operation buttons.
- ④ The shortcut menu screen closes by touching this area.

Displaying the Numeric Keypad Input Screen

The numeric keypad input screen is displayed when the DVD mode is selected for searching a title or chapter, and for entering a country code or password for the DVD setup item, and also when selecting a channel number in the SAT Radio mode.

- 1 Touch [10KEY] on the main source screen.
- 2 Touch the desired numeric key.

Display example for numeric keypad

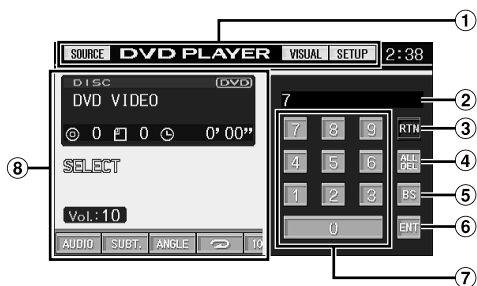

- ① Operation buttons of this area can be used while displaying the numeric keypad input screen.
- ② Input screen area
- ③ Closes numeric keypad input screen
- ④ All input numbers will be deleted
- ⑤ Previous number will be deleted
- ⑥ Input number is confirmed
- ⑦ Numeric keypad
- ⑧ The numeric keypad input screen closes when the area is touched while displayed.

3 Touch [ENT] to confirm your entry.

Dual-Screen Display

The connected AMP Link-compatible external amplifier can be displayed in dual-screen on the main source screen.

- 1 Touch [VISUAL] on the main source screen.
The VISUAL selection screen appears.
To make the setting, set to "Setting the VISUAL Touch Button" (page 34).
- 2 Touch [DUAL SCREEN].
The main source screen is restored showing the dual-screen display.

Display example for the dual-screen

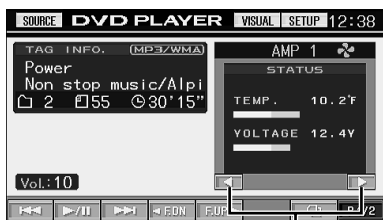

Changes the AMP display for the connected amplifier.

- 3 Touch [VISUAL] to cancel the dual-screen display.
The VISUAL selection screen appears.
- 4 Touch [NORMAL].
The normal screen will be restored.

Radio

Display example for Radio main screen



- ① [SOURCE] button: Refer to page 12
- ② [VISUAL] button: Displays the VISUAL selection screen
- ③ [SETUP] button: Displays the SETUP selection screen
- ④ [<<<] button: Refer to page 13
- Ⓐ Displays the preset number/frequency.

Listening to the Radio

- 1 Touch [SOURCE] on the main source screen.
The source selection screen is displayed.
- 2 Touch [RADIO].
The radio mode is activated and the display changes to the Radio Mode screen.
- 3 Touch [BAND] to select the desired radio band.
Each press changes the bands as follows:
FM-1 → FM-2 → AM → FM-1
- 4 Touch [TUNE] to choose the tuning mode.
Each touch changes the tuning mode display.
Distance → Local → Manual → Distance

 - There are two modes you can select for auto tuning, DX and Local:
 - DX (Distance) mode (with DX SEEK indicator ON); Both strong and weak stations will be tuned in.
 - Local mode (with SEEK indicator ON); Only strong stations will be tuned in. The initial setting is DX.
- 5 Touch [<<<<], [>>>>] or [<<<], [>>>] to change the radio frequency up or down respectively.
When the button is touched and held, the frequency changes continuously until the button is released.
When a stereo FM station is tuned in, the STEREO indicator appears in the display.

Manual Storing of Station Presets

- 1 Tune in a desired radio station you wish to store in the preset memory by manual or automatic seek tuning.
- 2 Touch **[P1/2]** to change the function guide.
- 3 Touch **[MEMORY]**.
- 4 Touch any one of the preset buttons **[P.SET 1]** through **[P.SET 6]** within 5 seconds.
The selected station is stored.
- 5 Repeat the procedure to store up to 5 other stations onto the same band.
To use this procedure for other bands, simply select the band desired and repeat the procedure.

A total of 18 stations can be stored in the preset memory (6 stations for each band; FM1, FM2 or AM).

- If a preset memory has already been set in the same preset number; it will be cleared and the new station will be memorized.

Automatic Memory of Station Presets

The tuner can automatically seek and store 6 strong stations in the selected band in order of signal strength.

After selecting the desired band, touch **[A.MEMO]**.

The tuner automatically seeks and stores 6 strong stations into [P.SET 1] to [P.SET 6] in order of signal strength.

When the automatic storing has been completed, the tuner goes to the station stored in [P.SET 1].

- If no stations are stored, the tuner will return to the original station you were listening to before the automatic storing procedure began.

Tuning to Preset Stations

You can tune in the preset stations in memory on each band using the preset number.

- 1 After selecting the desired band, touch **[P1/2]** to change the function guide.
- 2 Touch any one of the preset buttons **[P.SET 1]** through **[P.SET 6]** that has a station stored to it.
The preset station is received.

CD/MP3/WMA

Display example for MP3/WMA main screen

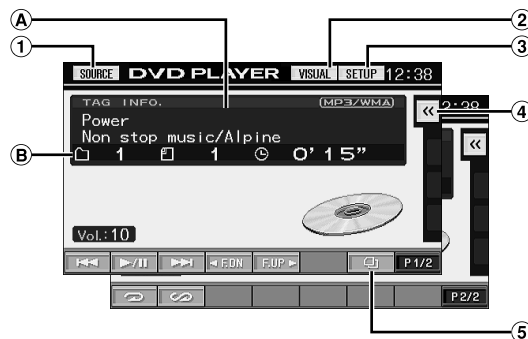

- ① **[SOURCE]** button: Refer to page 12
- ② **[VISUAL]** button: Displays the VISUAL selection screen
- ③ **[SETUP]** button: Displays the SETUP selection screen
- ④ **[<<]** button: Refer to page 13
- ⑤ **[]** button: Refer to page 24

A CD:

Displays track text*¹ in the upper line.
Displays Disc Text*¹ in the lower line.

MP3/WMA:

After displaying the file name in the upper line, the track name is displayed if there is ID3 tag information.

After displaying the folder name, the album name/artist name are displayed if there is ID3 tag information.

B CD:

Displays the track number/disc number*²/elapsed time.

MP3/WMA:

Displays the folder number/file number/disc number*³/ elapsed playback time

*¹ Displayed when a CD text disc is inserted.

*² Displayed when a CD changer is connected.

*³ Displayed when an MP3 compatible CD changer is connected.

Playback

1 Touch [SOURCE] on the main source screen.

The source selection screen is displayed.

2 Touch [DVD PLAYER].

The display shows the DVD player mode screen.

When a CD/MP3/WMA is inserted into the DISC SLOT of the IVA-D310, with the label side facing up, the unit starts to play the CD/MP3/WMA.

3 Touch [◀◀] or [▶▶] to select the desired track (file).

Returning to the beginning of the current track (file):

Touch [◀◀].

Fast backward :

Touch and hold [◀◀].

Advancing to the beginning of the next track (file) :

Touch [▶▶].

Fast forward :

Touch and hold [▶▶].

To pause playback

Touch [▶/||].

Touching [▶/||] again will resume playback.

To eject the disc

Press ▲.

- The IVA-D310 models include a built-in MP3/WMA unit. You can play CD-ROMs, CD-Rs, and CD-RWs containing MP3/WMA files on this unit. Use the format compliant with this unit. For further information about playing or storing MP3/WMA files, refer to pages 17 and 18 before using the unit.
- A WMA format file that is protected by DRM (Digital Rights Management) cannot be played back on this unit.
- The unit can play discs containing both audio data and MP3/WMA data.
- The MP3/WMA indicator is lit during MP3/WMA playback.
- The track display for CD audio data playback is the track numbers recorded on the disc.
- Three-inch (8cm) CD's can be used.
- "Playing MP3/WMA Data" is mentioned on page 32 "GENERAL Setup."
- When an MP3/WMA disc is played, it sometimes takes a few moment until it starts.
- Touch [□] to activate the search mode. For operations, refer to "Search Function" on page 24. However, the search mode function does not work in the CD changer mode.
- The playback time may not be correctly displayed when a VBR (Variable Bit Rate) recorded file is played back.
- If about 15 seconds passes without removing the disc after pressing ▲, the disc is automatically inserted into the unit. In this case, start playback by touching [▶/||] since the unit has been paused.

Repeat Play

Touch [↺] to play back repeatedly the track currently being played.

The track (file) will be played repeatedly.

Touch [↺] again and select OFF to deactivate Repeat play.

<Monitor display>

CD: RPT → RPT DISC*¹ → (off) → RPT

MP3/WMA:

- 1 Touch [P1/2]*³ to change the function guide.
- 2 Touch [↺] and select the desired Repeat play.

<Monitor display>

RPT → RPT FLDR*² → RPT DISC*¹ → (off) → RPT

*¹ If a CD Changer or an MP3 compatible CD changer is connected and the RPT DISC mode is selected, the unit repeatedly plays back all tracks (files) on the disc selected.

*² Only files in a folder are repeatedly played back.

*³ Display may vary depending on the connected devices.

M.I.X. (Random Play)

Touch [∞] during playback.

The tracks (files) on the disc will be played back in a random sequence.

To cancel M.I.X. play, touch [∞].

<Monitor display>

CD: M.I.X. → M.I.X. ALL*¹ → (off) → M.I.X.

MP3/WMA:

- 1 Touch [P1/2]*⁴ to change the function guide.
- 2 Touch [∞] and select the desired M.I.X. play.

<Monitor display>

M.I.X. FLDR*³ → M.I.X.*² → (off) → M.I.X. FLDR*³

*¹ If a CD Changer equipped with the M.I.X. ALL function is connected, M.I.X. ALL will also be selectable.

In this mode, the tracks on all the CDs in the current magazine will be included in the random playback sequence.

*² If an MP3 compatible CD changer is connected, all files in a disc are played back in random sequence, and playback shifts to the next disc.

*³ Only files in a folder are played back in random sequence in the M.I.X. FLDR mode.

*⁴ Display may vary depending on the connected devices.

Selecting Folders (concerning MP3/WMA)

Touch [F.DN] or [F.UP] to select the folder.

About MP3/WMA

CAUTION

Except for private use, duplicating audio data (including MP3/WMA data) or distributing, transferring, or copying it, whether for free or for a fee, without permission of the copyright holder is strictly prohibited by the Copyright Act and by international treaty.

What is MP3?

MP3, whose official name is "MPEG-1 Audio Layer 3," is a compression standard prescribed by the ISO, the International Standardization Organization and MPEG which is a joint activity institution of the IEC.

MP3 files contain compressed audio data. MP3 encoding is capable of compressing audio data at extremely high ratios, reducing the size of music files to as much as one-tenth their original size. This is achieved while still maintaining near CD quality. The MP3 format realizes such high compression ratios by eliminating the sounds that are either inaudible to the human ear or masked by other sounds.

What is WMA?

WMA, or "Windows Media™ Audio," is compressed audio data. WMA allows you to create music files and store them at higher ratios of compression than MP3 audio data (approx. half original size). This is achieved while still maintaining CD quality sound.

Method for creating MP3/WMA files

Audio data is compressed by using MP3/WMA specified software. For details on creating MP3/WMA files, refer to the user's manual for that software. MP3/WMA files that can be played back by this device have the file extension "mp3" / "wma". Files with no extension cannot be played back. (WMA ver. 7.1 and 8 are supported)

Supported playback sampling rates and bit rates

MP3

Sampling rates: 32 kHz ~ 48 kHz

Bit rates: 32 - 320 kbps

WMA

Sampling rates: 32 kHz ~ 48 kHz

Bit rates: 32 - 320 kbps

This device may not play back correctly depending on sampling rates or bit rates.

ID3 tags/WMA tags

If tag data is in an MP3/WMA file, this device can display the title (track title), artist name, and album name ID3 tag/WMA tag data (maximum 128 characters).

This device can only display single-byte alphanumeric characters and the underscore. For non-supported characters, "NO SUPPORT" is displayed.

The number of characters may be limited, or not correctly displayed, depending on the tag information.

Producing MP3/WMA discs

MP3/WMA files are prepared, then written to a CD-R or CD-RW using CD-R writing software. A disc can hold up to 1024 files/256 folders (including Root Folders).

Depending on the structure of the folders or files, it may take time to read a disc. In this case, it is recommended to decrease the number of folders or files.

Media supported

The media that this device can play back are CD-ROMs, CD-Rs and CD-RWs.

Corresponding File Systems

This device supports discs formatted with ISO9660 Level 1 or Level 2.

Under the ISO9660 standard, there are some restrictions to remember.

The maximum nested folder depth is 8 (including the root directory). The number of characters for a folder/file name is limited.

Valid characters for folder/file names are letters A-Z (all caps), numbers 0-9, and '_' (underscore).

This device also can play back discs in Joliet, Romeo, etc., and other standards that conform to ISO9660. However, sometimes the file names, folder names, etc., are not displayed correctly.

Formats supported

This device supports CD-ROM, CD-ROM XA, Mixed Mode CD, Enhanced CD (CD-Extra) and Multi-Session.

This device cannot correctly play back discs recorded with Track At Once or packet writing.

Order of files

The unit plays the files in the order that the writing software writes them. Therefore, the playing order may not be the same as the order you input. The playback order of the folders and files is as follows. However, the folder and file playback order differs from the folder no. and file no. indicated on the display.

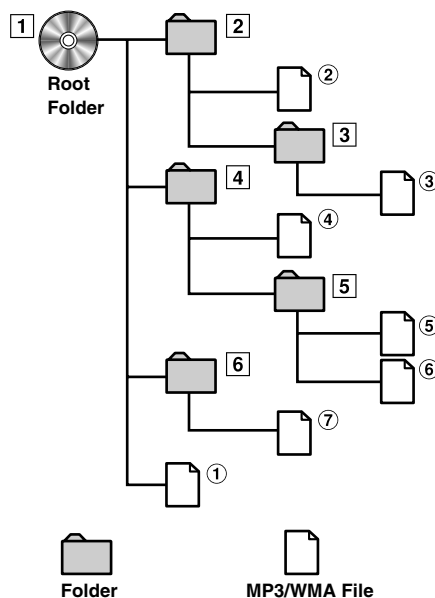

Terminology

Bit rate

This is the “sound” compression rate specified for encoding. The higher the bit rate, the higher the sound quality, but also the larger the files.

Sampling rate

This value shows how many times per second the data is sampled (recorded). For example, music CDs use a sampling rate of 44.1 kHz, so the sound is sampled (recorded) 44,100 times per second. The higher the sampling rate, the higher the sound quality, but also the larger the volume of data.

Encoding

Converting music CDs, WAVE (AIFF) files, and other sound files into the specified audio compression format.

Tag

Song information such as track titles, artist names, album names, etc., written into MP3/WMA files.

MP3: ID3 tag

WMA: WMA tag

Root folder

The root folder is found at the top of the file system. The root folder contains all folders and files.

DVD/Video CD

Display example for DVD main screen

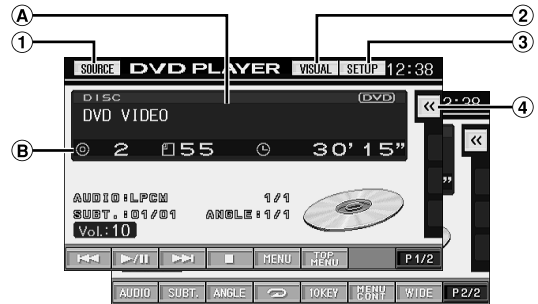

- ① [SOURCE] button: Refer to page 12
 - ② [VISUAL] button: Displays the VISUAL selection screen
 - ③ [SETUP] button: Displays the SETUP selection screen
 - ④ [<<] button: Refer to page 13
 - Ⓐ Displays the disc (DVD VIDEO, VIDEO CD) being played back.
 - Ⓑ Displays the title number/chapter number/elapsed playback time for a DVD.
Displays the track number/elapsed playback time for a video CD (When PBC is turned off).
- Some operations cannot be carried out depending on the disc or playback screen.
 - Displays of the function guide [P1/2], etc., may vary depending on the connected device(s).

Playing DVD/Video CD

IVA-D310 has a built-in DVD player. When an optional Alpine DVD/video CD/CD player (or DVD changer) is connected to the IVA-D310, you can control it from the IVA-D310. (except some operations)

⚠ WARNING

It is dangerous (and illegal in many states) for the driver to watch the DVD/TV/Video while driving the vehicle. The driver may be distracted from looking ahead and an accident could occur.

Install the IVA-D310 correctly so that the driver cannot watch DVD/TV/Video unless the vehicle is stopped and the emergency brake is applied.

If the IVA-D310 is not installed correctly, the driver will be able to watch the DVD/TV/Video while driving the vehicle and may be distracted from looking ahead causing an accident. The driver or other people could be severely injured.

To display the DVD mode screen

To watch a video source, your vehicle must be parked with the ignition key in the ACC or ON position. To do this, follow the procedure below.

- 1 Push the foot brake to bring your vehicle to a complete stop at a safe location. Engage the parking brake.
 - 2 Keep pushing the foot brake and release the parking brake once then engage it again.
 - 3 While the parking brake is being engaged the second time, release the foot brake.
- For automatic transmission vehicles, place the transmission lever in the Park position.

Now, the locking system for the DVD mode operation has been released. Engaging the parking brake can reactivate the DVD mode, as long as the car's ignition has not been turned off. It is not necessary to repeat the above procedure (1 through 3), of "To display the DVD mode screen."

Each time the ignition is turned OFF, perform the procedure of "To display the DVD mode screen."

- If you try to activate the auxiliary device while driving, the display will show the warning-**PICTURE OFF FOR YOUR SAFETY**.

⚠ Caution

- **Not all functions will operate for every DVD. See the individual DVD's instructions for details on the features supported.**
- **Fingerprints on a disc may adversely affect playback. If a problem occurs, remove the disc and check for fingerprints on the playback side. Clean the disc if necessary.**
- **If you switch the power or Ignition Key OFF or change sources during playback, playback will continue where you left off when you resume playback.**
- **If you try to perform an invalid operation (based on the type of disc being played), the following mark is displayed on the monitor screen: ⓪**

- **Play Position Memory Function**
Even if you turn power off or switch the Ignition Key to OFF during playback or change the source, playback will continue from the point where playback stopped when the power is turned ON again.

1 Touch [SOURCE] on the main source screen.

The source selection screen is displayed.

2 Touch [DVD PLAYER].

The display shows the DVD player mode screen.

Insert a disc with the label side facing up. The unit starts to play the disc.

When an optional Alpine DVD player is connected:

Insert a disc into the DVD/video CD/CD player, the player starts playing.

- The operation screen changes to the visual screen in the DVD or video CD mode for 5 seconds after an operation has been performed. Touch the display panel to display the operation screen again.
- The display mode can be changed by touching [WIDE]. For operation, see "Switching Display Modes" on page 25.

To eject the disc

Press ▲.

- The reverse side of a double-sided DVD will not be played automatically.
Remove the disc, turn it over, and reinsert it.
- DO NOT insert discs containing maps for the navigation system. Doing so could result in damage.
- Refer also to "DVD Setup" (pages 27 to 31).
- Be sure the remote input lead is connected to the remote output lead of this unit when a DVD changer or DVD player is connected. If not correctly connected, touch operation cannot be performed.
- To return to the previous screen during video CD playback, touch [◀] after touching [PI/2] of the function guide. However, the function may vary depending on the disc.
- If about 15 seconds passes without removing the disc after pressing ▲, the disc is automatically inserted into the unit. In this case, start playback by touching [▶/||] since the unit has stopped.

If a menu screen appears

On DVDs and Video CDs with playback control (PBC), menu screens may appear automatically. If this happens, perform the operation described below to start playback.

Direct Menu Operations (DVD only)

- 1 Touch the DVD menu directly.
 - Some operations cannot be performed depending on the disc.

Menu Operations (DVD only)

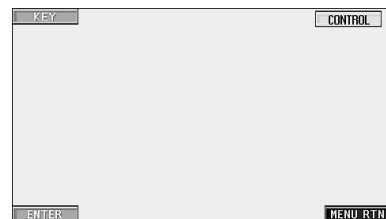

- 1 Touch [KEY].
The menu operation mode will be displayed.

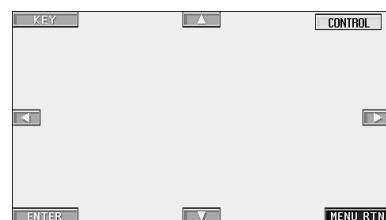

Touch [MENU RTN] to return to the previous display.

- 2 Select a desired menu item by touching [▲], [▼], [◀] or [▶].
- 3 Touch [ENTER] to confirm the selected item.

Numeric Keypad Input Operations (DVD)

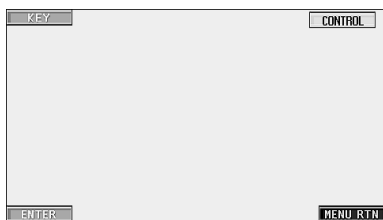

- 1 Touch [KEY].
The menu operation mode appears.
- 2 Touch [KEY] again.
The numeric keypad input mode screen appears.

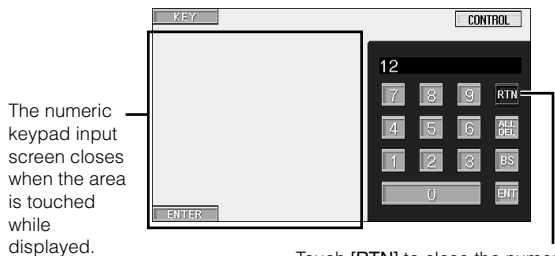

Touch [RTN] to close the numeric keypad input screen.

- 3 Touch a desired number.
- 4 Touch [ENT] on the numeric keypad mode screen to confirm your selection.

Numeric Keypad Input Operations (Video CD)

When PBC is turned OFF, the menu screen is not displayed. Turn it ON to display the screen (See "Turning the PBC Function ON or OFF (Video CD only)" on page 20).

- 1 Touch [P1/2] in the video CD mode to change the function guide.
- 2 Touch [10KEY].
The numeric keypad is displayed.
- 3 Touch and input a desired number.
- 4 Touch [ENT] to confirm.

Displaying the Top Menu Screen (DVD only)

When a DVD contains two or more titles, the top menu screen appears.

Touch [TOP MENU] on the DVD mode main screen.

The top menu screen appears.

- To perform necessary operations, see "If a menu screen appears" on page 19 and 20.

Displaying the Menu Screen (DVD only)

With a DVD having two or more menus, a menu screen will appear for the programs available, in addition to the main programs.

Touch [MENU] on the DVD mode main screen.

The menu screen appears.

- To perform necessary operations, see "If a menu screen appears" on page 19 and 20.

Displaying the Menu Operation Mode Screen (DVD only)

- 1 Touch [P1/2] on the DVD mode main screen.
The function guide changes.

- 2 Touch [MENU CONT].
The menu operation mode screen appears.

- For further operation, see "If a menu screen appears" on pages 19 and 20.

Turning the PBC Function ON or OFF (Video CD only)

The following describes how to turn a video CD equipped PBC (playback control) on or off.

Touch [PBC] on the video CD mode main screen.

Touching [PBC] sequentially turns the PBC on and off.

Stopping Playback (PRE STOP)

Press the stop button during playback to stop playback. That position is stored in the memory.

- 1 Touch [■] once during playback.
"PRE STOP" is displayed.

- 2 Touch [▶/||] in the PRE STOP mode.
Playback starts from the position at which it was stopped.

- For some discs, the position at which playback was stopped may not be accurate.

Stopping Playback

Touch [■] twice or touch and hold [■] for at least 2 seconds during playback.

"STOP" is displayed, and playback stops.

- Playback starts from the beginning when [▶/||] is touched while playback is stopped.

Fast-forwarding/Fast-reversing

- 1 During playback, touch [◀◀] (Fast-reverse) or [▶▶] (fast-forward).

When touched and held for more than 1 second, the disc is forwarded/reversed at double speed. When held for 5 more seconds or longer, the disc is forwarded/reversed at 8 times the normal speed.

- 2 Stop touching [◀◀] or [▶▶] to return to normal playback.

- No sound is played back during 8 times fast-forwarding/fast-reversing, or video CD fast-forwarding/fast-reversing.
- Subtitles are not usually displayed during 8 times fast-forwarding/fast-reversing in the DVD mode. However, they may be displayed, depending on the disc.
- For DVDs and video CDs with playback control (PBC), the menu screen may reappear during fast-forwarding/fast-reversing.

Finding the Beginnings of Chapters or Tracks

During playback, touch [◀◀] or [▶▶].

The chapter/track switches each time the button is touched, and playback of the selected chapter/track starts.

- ▶▶: Touch this to start playback from the beginning of the following chapter or track.
- ◀◀: Touch this to start playback from the beginning of the current chapter or track.

- Some DVDs do not have chapters.
- Be sure to turn PBC off before starting the search (See "Turning the PBC Function ON or OFF (Video CD only)" on page 20).

Supplementary explanation

"Chapters" are divisions of movies or musical selections on DVDs.

"Tracks" are divisions of movies or musical selections on video and music CDs.

Playing Still Frames (Pausing)

1 During playback, touch [▶/||].

2 Touch [▶/||] to resume playback.

- No sound is played during the still frame mode.
- The image or sound may stop temporarily when playback starts from the pause mode. This is not a malfunction.

Forward/reverse frame-by-frame Playback

1 In the pause mode, touch [▶▶] or [◀◀].

The picture advances or reverses by one frame each time the button is touched.

2 Touch [▶/||] to return to normal mode.

- No sound is output during forward/reverse frame-by-frame playback.
- Reverse frame-by-frame cannot be carried out on the video CD.

Slow Motion Playback

1 When [▶▶] or [◀◀] is touched and held while in the pause mode, the 1/8th speed slow motion playback mode is set.

When held in for 5 more seconds, the slow motion speed switches to 1/2 the normal speed.

2 Stop touching [▶▶] or [◀◀] to pause, and touch [▶/||] to playback.

- No sound is played during slow motion playback.
- Reverse slow motion playback is not available on the video CD.
- 1/2, 1/8 are approximate speeds. The actual speed differs from disc to disc.

Chapter/Track/Title Repeat Playback

Use this function to play the disc's titles, chapters or tracks repeatedly.

DVD

1 During playback, touch [P1/2].

2 Touch [↺] on the main unit.

The repeat mode switches every time the button is touched.

<Monitor display>

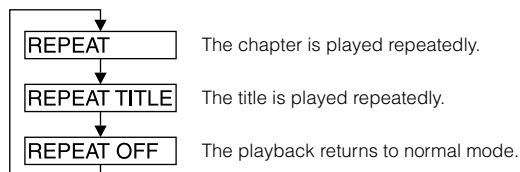

- Display may vary depending on the connected devices.
- The REPEAT OFF mode is always turned off when [REPEAT] is touched and held for at least 2 seconds.

Video CD

1 During playback, touch [P1/2].

2 During playback, touch [↺] on the main unit.

The repeat mode switches every time the button is touched.

<Monitor display>

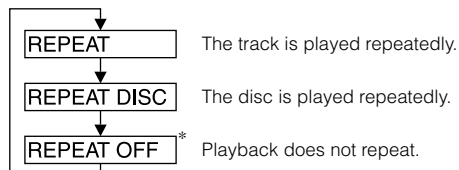

* Displayed only in the changer mode.

- Display may vary depending on the connected devices.
- The track/disc repeat modes cannot be used on video CDs with playback control (PBC). These modes can be carried out after turning PBC off. See "Turning the PBC Function ON or OFF (Video CD only)" on page 20.
- For some discs it is not possible to switch the repeat mode.
- Step 1 is not necessary when a DVD changer or DVD player is connected.

Searching by Title Number (DVD only)

Use this function to easily find positions on the DVD using the DVD's titles.

1 Touch [P1/2] while playback is stopped.

The function guide appears.

2 Touch [10KEY].

The numeric keypad input mode screen appears.

3 Enter a desired title by touching its title number.

See page 20 for operation of the numeric keypad.

4 Confirm your selection by touching [ENT].

Playback will start from the title number selected.

- This function cannot be used on discs on which no title numbers are recorded.
- Playback starts from the beginning of the chapter/track number in the state of PRE STOP.
- Some disc may not accept any operation.

Searching Directly by Chapter or Track Number

Use this function to easily move to the beginnings of the chapters or tracks on the disc.

1 Touch [P1/2] in any mode other than stop mode.

The function guide will appear.

2 Touch [10KEY].

The numeric keypad input mode screen will appear.

3 Touch and enter the chapter or track number you want to play.

See page 20 for operation of the numeric keypad.

4 Touch [ENT] to confirm your selection.

Playback will start from the selected chapter or track.

- This function is not available for a disc on which chapters or tracks are not stored.

Switching the Angle (DVD only)

On DVDs in which scenes have been filmed from multiple angles, the angle can be switched during playback.

1 During playback, touch [P1/2].

The function guide changes.

2 Touch [ANGLE].

The angle switches between the angles recorded on the disc every time the button is touched.

- Some time may be required for the angle to change.
- Depending on the disc, the angle may switch in one of two ways.
 - Seamless: The angle switches smoothly.
 - Non-seamless: When the angle is switched, a still picture is displayed first, after which the angle switches.

Switching the Audio Tracks

DVDs can have up to 8 different audio tracks. These alternate tracks can be switched during playback.

1 During playback, touch [P1/2].

2 Touch [AUDIO].

The sound switches between the alternate audio tracks recorded on the disc every time the button is touched.

- The alternate track selected becomes the default setting every time the power is turned on or the disc is replaced. If the disc does not include that track, the disc's default language is selected instead.
- Not all discs will allow changing the alternate audio tracks during playback. In these cases, select audio tracks from the DVDs menu.
- There may be a delay before the selected alternate track begins to play.

Video CDs with multiplex audio

1 During playback, touch [P1/2].

The function guide changes.

2 Touch [AUDIO].

The left and right channels will be output as shown in the figure below, each time the button is touched.

<Monitor display>

AUDIO L/R → AUDIO L/L → AUDIO R/R → AUDIO L/R

Switching the Subtitles (Subtitle Language) (DVD only)

With DVDs on which multiple subtitle languages are recorded, the subtitle language can be switched during playback; moreover, subtitles can be hidden.

1 During playback, touch [P1/2].

The function guide changes.

2 Touch [SUBT.].

Touching this button repeatedly selects sequentially the subtitle languages recorded on the disc, and then turns the subtitles OFF.

- There may be a delay before the selected subtitle appears.
- Not all discs will allow changing the subtitles during playback. In these cases, select subtitles from the DVDs menu.
- The subtitle language selected becomes the default setting every time the power is turned on or the disc is replaced. If the disc does not include that language, the disc's default language is selected instead. However, the subtitle language may differ depending on the disc.
- For some discs, the subtitles will be displayed even when this is set to off. However, the subtitle language may differ depending on the disc.

Switching from the disc menu

For some discs, the audio language, angle and subtitles can be switched from the disc menu.

- 1 Touch **[MENU]** or **[TOP MENU]** to display the menu.
- 2 Select an item to confirm it.
See "If a menu screen appears" on pages 19-20.

Displaying the Disc Status for DVD/Video CD

Use the procedure described below to display the status (title number, chapter number, etc.) of the currently playing DVD or of the currently playing video CD (track number, etc.) on the monitor.

- 1 **During playback, touch the display panel.**
The operation menu screen is displayed.
- 2 Touch **[CONTROL]** within 5 seconds.
The display status is displayed for 5 seconds.

Other Useful Features

Adjusting the Audio

Press the **Rotary encoder** on the unit.

The display changes to the Audio Adjustment screen.

Display Example for Audio Adjustment Screen

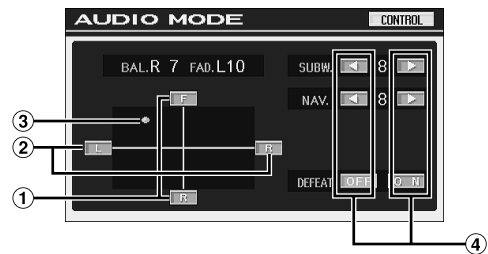

- ① Adjust the volume of the front and rear speakers by touching **[F]** or **[R]**.
 - ② Adjust the volume of the left and right speakers by touching **[L]** or **[R]**.
 - ③ Determine your desired setting value by touching and moving **[O]**.
 - ④ Touches **[◀]**, **[▶]** or **[ON]**, **[OFF]** to adjust to your preference.
- Touch **[AUDIO MODE]** on the **SETUP** selection screen to change to the Audio Adjustment screen.
 - Touching **[CONTROL]** will change to the main source screen.

Adjusting the Balance

Touch **[L]** or **[R]** to adjust the sound volume of the left and right speakers.

Setting range: L15 to R15

Adjusting the Fader

Touch **[F]** or **[R]** to adjust the volume of the front and rear speakers.

Setting range: F15 to R15

Adjusting the Subwoofer Level

Touch **[◀]** or **[▶]** of **SUBW.** to adjust the subwoofer output.

Setting range: 0 to 15

- The level adjustment becomes available when 0° or 180° is set in "Subwoofer On and Off" (page 42).

Adjusting NAV. LEVEL

Touch **[◀]** or **[▶]** of **NAV.** to adjust the volume of navigation interruption.

Setting range: 0 to 15

- This adjustment becomes available when **NAV.MIX** is turned on in "Setting the Navigation Interruption" (page 33).
- The setting navigation interruption is not displayed if an external audio processor not compatible with **NAV.MIX** is connected.

Turning defeat ON or OFF

Touch [ON] or [OFF] of DEFEAT to set to ON or OFF.

If you set the defeat to ON, MX is turned OFF and EQ is returned to the initial setting.

Adjusting the Balance/Fader Directly

Touch and move [○] to a desired setting.

Or touch a desired setting range, and [○] will move to that location.

Touch [L] or [R] of Balance and [F] or [R] of Fader for fine-tuning.

Search Function

1 Touch [] on the function guide while in the CD or MP3/WMA mode.

Search list screen is displayed.

Select a desired track or folder.

Touch [▶] for direct playback.

When a hierarchical list is prepared, [>>] will be displayed. Touch [>>] to display the respective hierarchy list screens.

Display Example for Search Screen



- 1 [>>] is displayed if there is a hierarchical list.
- 2 Select directly by touching [▶], and its Track (or folder/file) is played back.
- 3 Scroll the list one paragraph at a time by touching [▲] or [▼].
- 4 Touch and slide up or down to scroll the list backwards or forwards.
- 5 Touch [RETURN] to return to the previous list screen.

- The search function does not work on the DVD, video CD or CD changer.
- A folder list is displayed only during MP3/WMA playback when the DVD player (DVA-5210) or changer compatible with MP3 is connected.

Internal CD player mode

- 1 The track list* screen appears.
 - * If the CD is text compatible only.
- 2 Touch [▶] of a desired track text*.
The selected track will be played back.
 - "TRACK" is displayed in the track text list if there is no text on the disc.

Internal MP3/WMA Player/external MP3-compatible DVD Player/Changer Mode

- 1 The folder list screen appears.
Select a desired folder and then touch [>>].
([>>] appears only when a file is present in the selected folder.)
The file list screen is displayed.
 - Touch [▶] to play back the folder directly.
- 2 Touch [▶] of a desired file name.
The selected file will be played back.

Rear Entertainment Function

The rear entertainment function independently routes different sources to the front and the rear inside a car. For example, while listening to the radio or other audio source in the front, DVD can be enjoyed in the rear with the optional rear monitor and headphones.

1 Touch [SETUP] on the main source screen.

The SETUP selection screen is displayed.

2 Touch [REAR SELECT].

Rear Select display appears.

- This function cannot be used when MONITOR OUT 1 or 2 is set to OFF in the SYSTEM SETUP.

3 Touch the desired source such as visual (auxiliary input, built-in DVD) to select.

REAR.1: External monitor which is connected to AUX OUT of the tuner box on this unit. (If the optional expansion box (VPE-S431) is not connected), or an external monitor is connected to AUX OUT1 of the optional expansion box (VPE-S431).

REAR.2*: External monitor which is connected to AUX OUT 2 of the optional expansion box (VPE-S431)

- * REAR.2 is not displayed if only an external monitor is connected. The setting screen is displayed for REAR.2 if the external monitor is connected to the optional expansion box (VPE-S431).
- Touch [OFF] to cancel the rear entertainment function.
- When the "Setting the AUX Mode" (page 34) is set to OFF, the auxiliary source is not displayed.

Switching the function of the remote sensor

For remote control operation, the remote sensor of the external device (monitor, etc.) can be switched, as you prefer.

4 Touch [FRONT], [REAR 1] or [REAR 2].

The monitor which has a priority to the remote control operation is changed.

FRONT: The remote sensor of this unit is effective.

REAR1: The remote sensor of the external monitor connected to AUX OUT of the tuner box of this unit, or the optional expansion box (VPE-S431) is effective, and the remote control can operate only the source selected for the terminals.

REAR2: The remote sensor of the external monitor connected to AUX OUT of the optional expansion box (VPE-S431) is effective, and the remote control can operate only the source selected for the terminals.

- The sensor of the touch panel rear monitor has priority over the sensor of the remote control, if the rear monitor (connected to the Alpine touch panel rear monitor via the Monitor control lead) is touched, regardless of the remote control sensor switch setting. Note, however, that the sensor of the remote control that has been set takes priority if it has been 5 seconds since last touching the panel.
- When an optional DVD changer or DVD player is connected, and the remote control sensor is set to REAR1 or REAR2, some touch button operations ([■] STOP, etc.) cannot be performed. In this case, set the remote control sensor to FRONT.

Switching Display Modes

After carrying out the steps 1 to 3 of "To display the DVD mode Screen" explained on page 27, perform the operation described below.

While your vehicle is parked, touch [WIDE] on the visual source screen.

Each touch changes the display modes as follows:

MODE 1 → MODE 2 → MODE 3 → MODE 1
(WIDE) (CINEMA) (NORMAL) (WIDE)

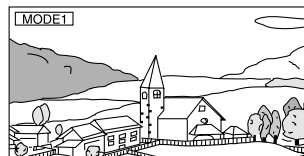

In Mode 1 (Wide), the monitor displays a normal picture wider to fit in a wide-screen monitor by evenly stretching out the picture horizontally.

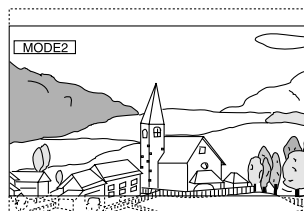

In Mode 2 (Cinema), the monitor displays a normal picture by stretching out the picture horizontally and vertically. This mode is good for displaying a cinema type picture at the 16 : 9 ratio.

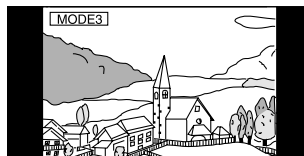

In Mode 3 (Normal), the monitor displays a normal picture at the center of the screen with a vertical black band at each side.

Switching the Visual Source Only (Simultaneous Function)

You can watch the video portion of another source while listening to the current source.

- After carrying out the steps 1 to 3 of “To display the DVD mode Screen” explained on page 27, perform the operation described below.

- 1 Touch [VISUAL] on the audio source screen.**
The VISUAL selection screen appears.
- 2 Touch a desired visual source.**
The visual source is switched to the selected one.

Canceling the Simultaneous Function

- 1 Touch the visual screen to display the main control.**
 - 2 Touch [CONTROL].**
 - 3 Touch [VISUAL] within 5 seconds.**
The VISUAL selection screen appears.
 - 4 Touch [NORMAL].**
The simultaneous function is canceled.
- To make the setting, set to “Setting the VISUAL Touch Button” (page 34).
 - If a DVD player is connected, you can receive the DVD picture/sound.
DVD player (DVA-5205) or DVD changer (DHA-S680) is connected:
Press and hold **V.OUT** on the remote control supplied with the DVD player or DVD changer for more than 2 seconds. The picture and sound of the DVD will be output.
The DVA-5210 is connected:
Press **V.OUT** on the remote control (included with the DVA-5210) to output DVD picture/sound.
 - The simultaneous function cannot be used when the Audio source is in the navigation mode.
When NAV is set in “Setting the VISUAL Touch Button” (page 34), only the navigation screen can be recalled.

Blackout Mode On and Off

When Blackout mode is turned on, the monitor display will turn off to reduce power consumption.

This additional power enhances the sound quality.

- 1 Touch [VISUAL] on the main source screen.**
The VISUAL selection screen is displayed.
 - 2 Touch [OFF].**
The backlit-display portion goes out.
 - 3 Touch [OFF] again to cancel the display backlight.**
- To make the setting, set to “Setting the VISUAL Touch Button” (page 34).
 - If any button on the unit is pressed during Blackout mode, the function will be displayed for 5 seconds to show the operation before returning to Blackout mode.
 - While the backlighting is turned off, the function indicator blinks during navigation voice interruption.

Setting VISUALIZER

This setting is available when the expansion box (VPE-S431) is connected.

- 1 Touch [VISUAL] on the main source screen.**
The VISUAL selection screen is displayed.
- 2 Touch [VISUALIZER].**
The Visualizer setting screen is displayed. If you do not touch any button for 5 seconds, the operating display buttons, [CONTROL] etc., will disappear.
- 3 Touch the screen (visual screen only) after the operating display has disappeared.**
The VISUALIZER setup mode is displayed.
- 4 Set ON/OFF by touching [ON] or [OFF] of VISUALIZER within 5 seconds.**

MODE1 to

MODE6 / OFF: Recalls the maker's setting mode on the expansion box (VPE-S431).

SCAN: Displays the pattern of MODE1 to MODE6 repeatedly.

Canceling the Visualizer Function:

Touch [NORMAL] on the VISUAL selection screen.

- To make the setting, set to “Setting the VISUAL Touch Button” (page 34).
- This setting is enabled when OFF is selected for “Setting the Visual Effect” (page 26) and ON is selected for, “Setting the VISUALIZER Mode Display” (page 34).

Setting the Visual Effect

This setting becomes available when the expansion box (VPE-S431) is connected.

- 1 Touch [VISUAL] on the visual main source screen.**
The VISUAL selection screen is displayed.
- 2 Touch [VISUALIZER].**
The Visualizer setting screen is displayed. If you do not touch any button for 5 seconds, the operating display buttons, [CONTROL] etc., will disappear.
- 3 Touch the screen (visual screen only) after the operation display has disappeared.**
The VISUALIZER setup screen appears.
- 4 Select “ON” by touching [◀] or [▶] of V.EFFECT within 5 seconds.**

ON: Turns on the function for enhancing visual effects when connected to two or more external monitors.

Set to OFF to cancel.

- To make the setting, set to “Setting the VISUAL Touch Button” (page 34).
- V.EFFECT is not displayed when the audio main source is selected.
- When the visual effect is set to ON, the rear monitor source cannot be changed from the unit.
- This setting may not be performed while driving.

Monitor Setting

Monitor Setting Operation

Following Steps 1 to 4 describe the common procedures for operating the MONITOR setting function. For details of the setting function items, refer to descriptions of respective items.

- 1 Touch [SETUP] on the main source screen.**
The SETUP selection screen is displayed.
- 2 Touch [MONITOR].**
The MONITOR screen appears.
- 3 Touch [◀] or [▶] of the desired item to change its setting.**

Setting items:

SLIDE / MONITOR O/C (OPEN/CLOSE)

- 4 Touch [RETURN] to return to the previous screen.**
Touch [CONTROL] to return to the main source screen that was displayed before the setup operation was started.

Selecting the Monitor Position

The monitor can be set in 2 positions.

Setting item: SLIDE

Setting content: BACK / FRONT

BACK: Slides the display backwards.

FRONT: Slides the display forwards.

- If the monitor is forcibly pushed or pulled, you may not be able to set the monitor angle or position. In this case, press OPEN/CLOSE to close the monitor once, and then open the monitor again.*

Setting Automatic Opening/Closing of the Monitor

Setting item: MONITOR O/C (OPEN / CLOSE)

Setting content: MANUAL / FULL / CLOSE

MANUAL: The monitor is manually opened or closed by pressing OPEN/CLOSE.

FULL: The monitor automatically opens and closes when the ignition key is turned to the "ACC" or "ON/OFF" position.

CLOSE: The monitor automatically closes when the ignition key is turned OFF.

Setup

DVD Setup

DVD Setup Operation

To display the DVD mode screen:

To watch a video source, your vehicle must be parked with the ignition key in the ACC or ON position. To do this, follow the procedure below.

- 1 Bring your vehicle to a complete stop at a safe location. Engage the parking brake.
- 2 Keep pushing the foot brake and release the parking brake once then engage it again.
- 3 When the parking brake is engaged for the second time, release the foot brake.

- *For automatic transmission vehicles, place the transmission lever in the Park position.*

Now, the locking system for the DVD mode operation has been released. Engaging the parking brake can reactivate the DVD mode, as long as the car's ignition has not been turned off. It is not necessary to repeat the above procedure (1 through 3), of "To display the DVD mode screen."
Each time the ignition is turned OFF, perform the procedure of "To display the DVD mode screen."

The DVD Setup operation can be carried out after removing the disc from the unit or when playback of the disc has stopped.

The following steps 1 to 5 are common operations to each

"Setting item" of DVD Setup. Refer to each section for details.

- 1 Touch [SETUP] on the main source screen.**
The SETUP selection screen is displayed.
- 2 Touch [OTHER SETUP].**
The OTHER SETUP screen appears.
- 3 Touch [≫] of DVD SETUP.**
The DVD setup screen appears.
- 4 Touch [◀] or [▶], etc., of the desired item to change its setting.**

Setting items:

MENU LANGUAGE / AUDIO LANGUAGE / SUBT. LANGUAGE / COUNTRY CODE / PARENTAL / DIGITAL OUT MODE / DOWNMIX MODE / TV SCREEN

Display example for DVD setup screen

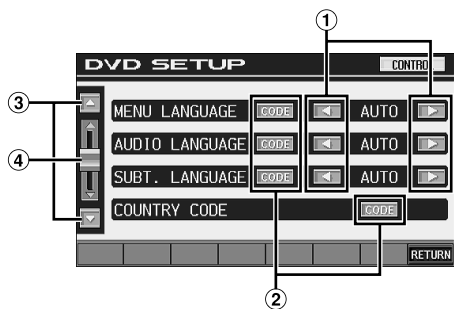

- ① Touch [◀] or [▶] to set a desired language.
- ② Touch [CODE] to display the numeric keypad screen.
- ③ Touch [▲] or [▼] to scroll a setting item list by one paragraph.
- ④ Touch and slide up or down to scroll the list backwards or forwards.

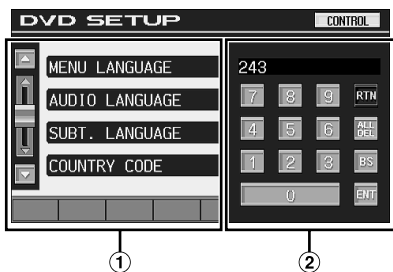

- ① The numeric keypad input screen closes when the area is touched while displayed.
- ② **Numeric keypad input screen**
The numeric keypad is used if you want to play back in a language other than that displayed, or to input your parental lock password, etc.

5 Touch [RETURN] to return to the previous screen.

Touch [CONTROL] to return to the main source screen that was displayed before the setup operation was started.

- Immediately after changing the settings of DVD mode (while the system is writing data automatically) do not turn the ignition key (engine key) to OFF.
Otherwise, the settings may not be changed.

Changing the language setting

The audio language, subtitle language and menu language can be set according to your preferences.

Once set, this becomes the default language. This function is convenient when you always want to listen in English. (The language setting is not effective on some discs. If not, the default language is set from the factory.)

- When the settings are changed, the old settings are overwritten. Make a note of the current settings before making changes. The memory is cleared when the vehicle's battery is disconnected.
- To temporarily change the language of the current disc, either do so from the DVD menu or by using the operation described in the section "Switching the Audio Tracks" (page 22).
- If the disc does not include the selected language, the disc's default language is set.

Setting of the Menu Language

Set the language used for the menus (title menu, etc.).

Setting item: MENU LANGUAGE

Setting contents: AUTO / ENGLISH / GERMAN / FRENCH / JAPANESE

- When "AUTO" is selected, the primary menu language among the recorded ones is played.

Setting of the Audio Language

Set the audio language produced from the speakers.

Setting item: AUDIO LANGUAGE

Setting contents: AUTO / ENGLISH / GERMAN / FRENCH / JAPANESE

- When "AUTO" is selected, the primary audio language among the recorded ones is played.

Setting of the Subtitle Language

Set the language of the subtitles displayed on the screen.

Setting item: SUBT. LANGUAGE

Setting contents: AUTO / ENGLISH / GERMAN / FRENCH / JAPANESE

- When "AUTO" is selected, the primary subtitle language among the recorded ones is played.

To play in a language other than those displayed

- 1 Touch [CODE].
The numeric keypad screen is displayed.
- 2 Touch the 4-digit numeral of the language number.
As for the language number, refer to "List of Language Codes" (page 64).
- 3 Touch [ENT] to memorize the number.

Changing the Country Code Setting

Set the country number of which you want to set the rating level (Parental lock).

Setting item: COUNTRY CODE

Setting content: CODE

- When the settings are changed, the old settings are overwritten. Make a note of the current settings before making changes. The settings are not cleared even when the vehicle's battery is disconnected.

- 1 Touch [CODE].
- 2 Touch [ALL DEL] or [BS].
Delete the displayed country number.
- 3 Touch the 4-digit country code.
As for the country number, refer to "List of Country Codes" (pages 65 and 66).
- 4 Touch [ENT] to memorize the code.

Setting the Rating Level (Parental Lock)

This function can help restrict the viewing of movies to children of appropriate age levels only.

Setting item: PARENTAL

Setting content: INPUT

- When the settings are changed, the old settings are overwritten. Make a note of the current settings before making changes. The memory is cleared when the vehicle's battery is disconnected.
- On unrated DVDs, playback will not be restricted even if the rating level is set.
- If you want to play back DVD software with the parental lock feature and its use is currently restricted, change the rating level and the country number in order to play back the DVD.
- Once set, this rating level remains in memory until changed. To enable playback of discs of higher rating levels or to cancel the parental lock, the setting must be changed.
- Not all DVDs provide a Parental Lock feature. If you are unsure about a DVD, play it first to confirm. Do not leave DVDs accessible to young children for whom you deem them inappropriate.
 - 1 Touch [INPUT].
The numeric keypad screen is displayed.
 - 2 Touch the numeric keypad to input a 4-digit password.
The initial number is 1111.
Input number are displayed as "*".
 - 3 Touch [ENT] to memorize the number.
The PARENTAL screen appears.

Set the rating level of PARENTAL

- 4 Touch [ON] of PARENTAL to turn on.
- 5 Touch [◀] or [▶] of PARENTAL LEVEL to select the rating level (1 to 8).
Select "OFF" to cancel the parental lock or if you do not want to set a rating level. The smaller the number, the higher the rating level.
- 6 Touch [RETURN] to return to the previous screen.

Changing the password

- 4 Touch [INPUT] of PASSWORD CHANGE.
The numeric keypad screen is displayed.
- 5 Touch the input screen to enter a new 4-digit password
 - Keep a note of the number somewhere safe in case you should forget it.
- 6 Touch [ENT] to memorize the number.
- 7 Touch [RETURN] to return to the previous screen.

Changing the rating level temporarily

Some discs may request that you change the rating level set in the default settings during playback. In this case, the message appears on the monitor screen "PARENTAL LEVEL CHANGE OK? [YES] [NO]."

If this screen appears, change the level as follows:

- **To change parental level and play, touch [YES].**
When [YES] is touched, the numeric keypad input screen is displayed. Input the 4-digit password in "Setting the Rating Level (Parental Lock)" you set, then touch [ENT].
- **To play without changing the parental level, touch [NO].**
(When [NO] is touched, playback will be at the parental level set in "Setting the Rating Level (Parental Lock).")

Changing the Digital Output Setting

Use the following procedure to set the digital audio signal output from the IVA-D310.

Setting item: DIGITAL OUT MODE

Setting contents: AUTO / LPCM

- AUTO:** The digital output is switched automatically according to the type of audio signals being played.
Be sure to select "AUTO" when you want to connect a digital audio processor and play Dolby Digital audio.
"AUTO" is the factory setting.
- LPCM:** The audio signals recorded on the disc are converted to 48 kHz/16 bit (for DVDs) or 44.1 kHz (for video CDs and CDs) linear PCM audio signals for output.

Audio output/Optical digital audio output

Disc	Audio recording format		Digital output setting	Optical digital audio output (when a digital audio processor is connected)	Analog audio output (Ai-NET, RCA output)
DVD	DTS		AUTO	DTS Elementary Stream	OK
			LPCM	LPCM Encode 2ch Down mix (44.1kHz or 48kHz/16bit)	OK
	Dolby Digital		AUTO	Dolby Digital	OK
			LPCM	LPCM (48kHz/16bit)	OK
	Linear PCM	48kHz/16bit	AUTO or LPCM	LPCM (48kHz/16bit)	OK
		48kHz/20bit	AUTO or LPCM	LPCM (48kHz/16bit)	OK
		48kHz/24bit	AUTO or LPCM	LPCM (48kHz/16bit)	OK
		96kHz/16bit	AUTO or LPCM	LPCM (48kHz/16bit)	OK
		96kHz/20bit	AUTO or LPCM	LPCM (48kHz/16bit)	OK
		96kHz/24bit	AUTO or LPCM	LPCM (48kHz/16bit)	OK
	MPEG2		AUTO or LPCM	LPCM (44.1kHz or 48kHz/16bit)	OK
Video CD	MPEG1		AUTO or LPCM	LPCM (44.1kHz)	OK
CD	Linear PCM		AUTO or LPCM	LPCM (44.1kHz)	OK
	DTS		AUTO	DTS Elementary Stream	OK
LPCM			LPCM Encode 2ch Down mix (44.1kHz/16bit)	OK	
MP3	MPEG Audio Layer3 Bit Rate: 32kbps~320kbps	32kHz/16bit	AUTO or LPCM	LPCM Encode 2ch (32kHz/16bit)	OK
		44.1kHz/16bit	AUTO or LPCM	LPCM Encode 2ch (44.1kHz/16bit)	OK
		48kHz/16bit	AUTO or LPCM	LPCM Encode 2ch (48kHz/16bit)	OK
WMA	Windows Media™ Audio Bit Rate: 32kbps~320kbps	32kHz/16bit	AUTO or LPCM	LPCM Encode 2ch (32kHz/16bit)	OK
		44.1kHz/16bit	AUTO or LPCM	LPCM Encode 2ch (44.1kHz/16bit)	OK
		48kHz/16bit	AUTO or LPCM	LPCM Encode 2ch (48kHz/16bit)	OK

Setting the Downmix Mode

This function applies to Dolby Digital, DTS stream sound.

Setting item: DOWNMIX MODE

Setting contents: SURROUND/STEREO

SURROUND: Surround compatible Downmix

STEREO: Stereo Downmix

Setting the TV Screen Setting

Use the procedure described below to modify the output screen according to the type of TV monitor (rear monitor) being used. This setting can also be applied for the IVA-D310.

If the rear monitor is not connected, the screen setting is 16:9.

Setting item: TV SCREEN

Setting contents: 4:3 LB / 4:3 PS / 16:9

- For some discs, the picture may not be set to the selected screen size. (For details, refer to the explanation on the disc's jacket.)

4:3 LETTER BOX:

Select this when connected to a conventional 4:3 size (normal TV aspect ratio) monitor. There may be black stripes visible at the top and bottom of the screen (when playing a 16 : 9 size movie). The width of these stripes will depend upon the original aspect ratio of the theatrical release of the movie.



4:3 PAN-SCAN:

Select this when connected to a conventional 4:3 size monitor. The picture will fill the entire TV screen. However, due to the mismatch in aspect ratio, parts of the movie at the extreme left and right sides will not be visible (when playing a 16 : 9 size movie).



16:9 WIDE:

Select this when connected to a wide screen TV. This is the factory setting.



GENERAL Setup

General Setup Operation

To display the General mode screen:

To watch a video source, your vehicle must be parked with the ignition key in the ACC or ON position. To do this, follow the procedure below.

- 1 Bring your vehicle to a complete stop at a safe location. Engage the parking brake.
- 2 Keep pushing the foot brake and release the parking brake once then engage it again.
- 3 When the parking brake is engaged for the second time, release the foot brake.

- For automatic transmission vehicles, place the transmission lever in the Park position.

Now, the locking system for the General mode operation has been released. Engaging the parking brake can reactivate the General mode, as long as the car's ignition has not been turned off. It is not necessary to repeat the above procedure (1 through 3), of "To display the General mode screen."

Each time the ignition is turned OFF, perform the procedure of "To display the General mode screen."

The following steps 1 to 5 are common operations to each "Setting item" of GENERAL Setup. Refer to each section for details.

- 1 Touch **[SETUP]** on the main source screen.
The SETUP selection screen is displayed.
- 2 Touch **[OTHER SETUP]**.
The OTHER SETUP screen appears.
- 3 Touch **[>>]** of GENERAL SETUP.
The GENERAL setup screen appears.
- 4 Touch **[OFF], [ON] or [◀], [▶], etc.,** of the desired item to change its setting.

Setting items:

CLOCK / CLOCK ADJUST / DAYLIGHT SAVING TIME / DEMONSTRATION / BEEP / AUTO SCROLL / FM CONDITION / ADF* / PLAY MODE / LED DIMMER LEVEL

* Displayed only when XM Satellite Radio Receiver is connected.

- 5 Touch **[RETURN]** to return to the previous screen.
Touch **[CONTROL]** to return to the main source screen that was displayed before the setup operation was started.
- Immediately after changing the settings of General Mode (While the system is writing data automatically) do not turn the ignition key (engine key) to OFF.
Otherwise, the settings may not be changed.

Displaying the Time

The clock indication on the monitor display is turned on or off respectively.

Setting item: CLOCK
Setting content: OFF / ON

Setting the Time

Setting item: CLOCK ADJUST
Further setting items : HOUR / MINUTE / TIME ADJUST
Setting content: 1-12 / 0-59 / RESET

HOUR: Adjust the hour.
MINUTE: Adjust the minute.
RESET: If the clock shows less than 30 minutes past, the minute will be ": 00"; more than 30, the hour advances.

- The clock-adjusting mode is canceled when the power is turned off, when [RETURN] or [CONTROL] is touched.
- If this setting is carried out, it is also applied for the clock in the subdisplay displayed.

Setting Daylight Saving Time

Setting item: DAYLIGHT SAVING TIME
Setting content: OFF / ON

ON: Place the Summer Time mode ON. The time advances by one hour.
OFF: Return to the ordinary time.

Demonstration Function

This unit is equipped with a demonstration function capable of showing basic operations of respective sources on the monitor display.

Setting item: DEMONSTRATION
Setting content: OFF / ON

ON: Turns on the demonstration mode to show the basic operations.
OFF: Turns off the demonstration mode.

- The demonstration operation is automatically repeated until the function is turned off.

Sound (Beep) Guide Function

Setting item: BEEP
Setting content: OFF / ON

ON: Activate the Sound Guide mode.
OFF: Deactivate the Sound Guide mode. The sound guide beep will not be produced when a button on the unit is pressed.

- A beep always sounds when opening or closing the monitor, regardless of this setting.

Setting the Scroll

Scroll display is available if CD text, folder name, file name or tag information is entered.

Setting item: AUTO SCROLL
Setting content: OFF / ON

ON: Turns on the AUTO scroll mode. Scroll display is repeated as long as the mode is turned on.
OFF: Turns off the AUTO scroll mode.
Scroll display is done once as a track is changed.

- Scroll display of the song, artist and album name is enabled when iPod is connected.

Setting the Sound Quality of the Tuner

The IVA-D310 incorporates the MAX TUNE SQ for the highest quality tuner audio. Moreover, you can choose between 3 settings to suit your own personal sound preferences and usage.

Setting item: FM CONDITION
Setting content: NORMAL / HI-FI / STABLE

NORMAL: Standard setting
HI-FI: Sound quality priority setting
STABLE: Noiseless priority setting

Setting the Auxiliary Data Field Display

This display can be used only when the optional XM Satellite Radio Receiver is connected.

Setting item: ADF
Setting content: OFF/ON

ON: The Auxiliary Data Field is displayed in the XM mode.
OFF: The Auxiliary Data Field is not displayed.

Playing MP3/WMA Data

When using discs containing both audio data and MP3/WMA data.

Setting item: PLAY MODE
Setting content: CD / MP3

CD: Plays only the audio data on discs containing both audio data and MP3/WMA data.
MP3: Plays only the MP3/WMA files on discs containing both audio data and MP3/WMA data.

- Remove the disc from this unit before setting.
- When an MP3-compatible CD changer is used, this setting cannot be applied.

Adjusting the Dimmer of Button Lighting at Night

You can adjust the brightness of the button lighting at night with the dimmer.

Setting item: LED DIMMER LEVEL
Setting level: -2 to +2

- The adjustment is available when ON or AUTO is set in "Setting the Brightness of the Backlighting" (page 35).

SYSTEM Setup

System Setup Operation

To display the System mode screen:

To watch a video source, your vehicle must be parked with the ignition key in the ACC or ON position. To do this, follow the procedure below.

- 1 Brake to bring your vehicle to a complete stop at a safe location. Engage the parking brake.
- 2 Keep pushing the foot brake and release the parking brake once then engage it again.
- 3 When the parking brake is engaged for the second time, release the foot brake.

- For automatic transmission vehicles, place the transmission lever in the Park position.

Now, the locking system for the System mode operation has been released. Engaging the parking brake can reactivate the System mode, as long as the car's ignition has not been turned off. It is not necessary to repeat the above procedure (1 through 3), of "To display the System mode screen."
Each time the ignition is turned OFF, perform the procedure of "To display the System mode screen."

The following steps 1 to 5 are common operations to each "Setting item" of SYSTEM Setup. Refer to each section for details.

- 1 Touch **[SETUP]** on the main source screen.
The SETUP selection screen is displayed.
- 2 Touch **[OTHER SETUP]**.
The OTHER SETUP screen appears.
- 3 Touch **[>>]** of **SYSTEM SETUP**.
The SYSTEM setup screen appears.
- 4 Touch **[◀], [▶]** or **[OFF], [ON], etc.**, of the desired item to change its setting.

Setting items:

IN INT. MUTE / IN INT. ICON / NAV. IN / NAV. MIX / VISUALIZER* / AUX IN-1 / AUX IN-2* / AUX IN-3* / MONITOR OUT-1 / MONITOR OUT-2* / CAMERA IN / VISUAL KEY / A. PROC TYPE / OPTICAL OUT

* Displayed when the external expansion box VPE-S431 is connected.

- 5 Touch **[RETURN]** to return to the previous screen.
Touch **[CONTROL]** to return to the main source screen that was displayed before the setup operation was started.
- Immediately after changing the settings of System Mode (While the system is writing data automatically) do not turn the ignition key (engine key) to OFF.
Otherwise, the settings may not be changed.

Setting the External Device Interrupt Mode

If an Alpine Ai-NET Auxiliary Input Adapter (KCA-801B) is connected to the IVA-D310, an Auxiliary Source will be allowed to interrupt the current audio source. For example, you can listen to a portable MP3 player through your car audio system even with a CD changer connected and playing. The CD changer will automatically mute when switched to the AUX Input. For further details on how to use the Alpine KCA-801B, see your authorized Alpine dealer.

Setting item: IN INT. MUTE

Setting content: OFF / ON

- OFF: The volume level can be adjusted in Interrupt mode.
- ON: Sound will not be output. The icon that is set in "Setting the Interrupt Icon Display" is displayed.

- The auxiliary device being connected must have an Interrupt wire with a negative trigger for this function to operate automatically. Otherwise, a separate switch needs to be added to switch it manually.

Setting the Interrupt Icon Display

The unit can display the icon of an external device, such as a telephone, whenever a phone call comes in to tell you there is a phone call.

Setting item: IN INT. ICON

Setting content: INT / TEL

- INT: The INT icon appears on the display.
- TEL: When the external device (telephone) sends the interrupt signal, the telephone icon appears on the display.

Setting the Navigation Mode

When you connect an optional navigation equipment, set it to ON.

Setting item: NAV. IN

Setting contents: OFF / ON

- ON: Navigation source is displayed.
- OFF: Navigation source is not displayed. The settings related to the navigation can not be changed from this unit.

Setting the Navigation Interruption

With an Alpine navigation system connected to the IVA-D310, the voice guidance of the navigation system will be mixed with the radio or CD play.

Setting item: NAV.MIX

Setting content: OFF / ON

- OFF: The navigation interruption mode is turned off.
- ON: The navigation interruption mode is on.

To adjust the navigation interruption volume level, the adjustment for NAV. LEVEL can be performed in "Adjusting the Audio" on page 23 after setting to ON.

- The audio volume during the navigation guide can be set by adjusting the audio volume while the navigation guide continues. When the navigation guide finishes, the previous audio volume and the previous screen are restored. For exception, if the navigation cuts in when the audio volume is lower than the setting level, the audio volume during the navigation guide is reset the current listening volume. (When the navigation guide cuts in, the audio volume does not increase.)
- This setting is effective when NAV.IN of SYSTEM list screen is ON.
- When PXA-H510 or PXA-H900 is connected, NAV.MIX value set in this unit does not affect PXA-H510 or PXA-H900.

Setting the VISUALIZER Mode Display

Select this display when displaying the source names of VISUALIZER on the VISUAL selection screen.

Note that this setting is enabled only when the optional expansion box (VPE-S431) is connected.

Setting item: VISUALIZER

Setting contents: OFF / ON

OFF: "VISUALIZER" and source names are not displayed on the VISUAL selection screen.

ON: "VISUALIZER" and source names are displayed on the VISUAL selection screen.

- Switching on or off cannot be done if ON is set in "Setting the Visual Effect" (page 26).

Setting the AUX Mode

Setting item: AUX IN-1, 2, 3

Setting content: OFF / ON

OFF: AUX source is not displayed.

ON: AUX source is displayed.

- OFF is not displayed when the optional DVD player or DVD changer is connected.
- When OFF is selected, the settings related to AUX cannot be changed from this unit.
- When either a DVD player or DVD changer compatible with Ai-NET is connected to AUX IN 1, EXT.DVD is displayed on the source selection screen. When both are connected, DVD-1 is displayed for AUX IN 1, and DVD-2 is displayed for AUX IN 2.
- AUX IN 2,3 is displayed when the external expansion box (VPE-S431) is connected.

Naming External Devices

When more than one external device is connected, you can name each (up to 3) as you like. After setting to ON in "Setting the AUX Mode," touch any one of the [>>>] buttons of AUX IN 1 through 3, then this setting may be carried out.

Setting items: NAME

Setting contents: AUX / VCR / GAME-1,2 / TV / NAV. / EXT. DVD*

- The selected source name is displayed instead of AUX source name. When a source is selected, the Function Guide of AUX mode appears.
 - Only AUX IN-3 MODE can be named "NAV." When AUX mode is selected, "NAV." is displayed as the source name. This setting is recommended if you view the navigation screen on the rear monitor. However, it is available only when the Alpine navigation system (except RGB navigation) is connected.
 - Only when an Alpine TV tuner is connected, can you operate the displayed function guide from this unit.
- * "EXT.DVD" is displayed on the source selection screen when a DVD player is connected, and "DVD-1-3" is displayed on the source selection screen when the NAME setting is set to "EXT.DVD" on more than one AUX (included when an external Ai-NET compatible DVD player is connected).

Adjusting the External Input Audio Level

After setting to ON in "Setting the AUX Mode," touch any one of the [>>>] buttons of AUX IN 1 through 3, then this setting may be carried out.

Setting item: LEVEL

Setting content: LOW / HIGH

LOW: Decreases the external input audio level

HIGH: Increases the external input audio level

Setting of the External Monitor Output

Set it to ON when you use the rear entertainment function (page 25).

Setting items: MONITOR OUT-1, 2

Setting contents: OFF / ON

ON: By setting the connected external monitor to ON, the remote control will be usable.

OFF: When either MONITOR OUT 1 or 2 is set to OFF, only one monitor can be set by the rear enter function. When both MONITOR OUT 1 and 2 are set to OFF, REAR SELECT, which is displayed on the SYSTEM selection screen, cannot be used.

- The setting to "MONITOR OUT-2" can be made if optional expansion box VPE-S431 is connected.
- Switching on or off cannot be done if ON is set in "Setting the Visual Effect" (page 26).

Setting of the Rear Camera

When the rear camera is connected, rear pictures are output on the screen.

Setting item: CAMERA IN

Setting contents: OFF / ON

ON: Even if the shift lever is not set to reverse (R), the rear pictures are output by selecting the CAMERA source.

OFF: The CAMERA source is not displayed on the VISUAL selection screen.

- By shifting to reverse (R), the rear pictures are output. This function is effective when the reverse wire is properly connected.
- To apply the setting, set to VISUAL "Setting the VISUAL Touch Button" (page 34).

Setting the VISUAL Touch Button

Setting item: VISUAL KEY

Setting content: VISUAL / NAV.

NAV.: Switches directly to the navigation screen by touching [VISUAL]. (Only when an Alpine optional RGB Navigation is connected.)

VISUAL: Recalls the VISUAL Select screen by touching [VISUAL].

Optical Digital Input Selection for an External Audio Processor

Make sure "OPTICAL OUT" is ON in "Setting the Digital Output" (page 35) before switching this setting.

Setting item: A.PROC TYPE

Setting contents: PXA-H510 / OTHER

- OTHER:** When connecting any audio processor via an optical digital cable except the PXA-H510. Connect the optical digital input connector with the connector for the Head unit.
- PXA-H510:** When connecting PXA-H510. Connect the optical digital input connector with the connector for the DVD.

- After input selection is completed, turn ignition OFF and back ON again. Your setting of the optical digital input switch is completed.

Setting the Digital Output

To connect an audio processor using the optical digital output, set to "ON" by the following procedure.

Setting item: OPTICAL OUT

Setting contents: OFF / ON

- Afterwards, set ACC to OFF once, then turn it ON again. The setting of Digital Output is decided.

DISPLAY Setup

Display Setup Operation

To display the Display mode screen:

To watch a video source, your vehicle must be parked with the ignition key in the ACC or ON position. To do this, follow the procedure below.

- 1 Bring your vehicle to a complete stop at a safe location. Engage the parking brake.
- 2 Keep pushing the foot brake and release the parking brake once then engage it again.
- 3 When the parking brake is engaged for the second time, release the foot brake.

- For automatic transmission vehicles, place the transmission lever in the Park position.

Now, the locking system for the Display mode operation has been released. Engaging the parking brake can reactivate the Display mode, as long as the car's ignition has not been turned off. It is not necessary to repeat the above procedure (1 through 3), of "To display the Display mode screen."

Each time the ignition is turned OFF, perform the procedure of "To display the Display mode screen."

The following steps 1 to 5 are common operations to each "Setting item" of DISPLAY Setup. Refer to each section for details.

- 1 Touch **[SETUP]** on the main source screen.
The SETUP selection screen is displayed.

- 2 Touch **[OTHER SETUP]**.
The OTHER SETUP screen appears.

- 3 Touch **[>>]** of **DISPLAY SETUP**.
The DISPLAY setup screen appears.

- 4 Touch **[◀], [▶]** or **[OFF], [ON], etc.**, of the desired item to change its setting.

Setting items:

DIMMER / DIMMER LOW LEVEL / BACKGROUND / AUTO BACKGROUND / FONT TYPE / BASE COLOR / PULSETOUCH / SCREEN ALIGNMENT

- 5 Touch **[RETURN]** to return to the previous screen.
Touch **[CONTROL]** to return to the main source screen that was displayed before the setup operation was started.

- Immediately after changing the settings of Display Mode (While the system is writing data automatically) do not turn the ignition key (engine key) to OFF.
Otherwise, the settings may not be changed.

Setting the Brightness of the Backlighting

Backlighting is provided by a fluorescent light built into the liquid crystal panel. The illumination control adjusts the brightness of the backlighting based on the car ambient lighting for easier viewing.

Setting item: DIMMER

Setting content: OFF / ON / AUTO

- OFF:** Deactivate Auto Dimmer mode to keep the background illumination of the monitor bright.
- ON:** Keep the background illumination of the monitor dark.
- AUTO:** Adjust the brightness of the background illumination of the monitor automatically to the brightness of the car interior.

- When ON or AUTO is set, the setting is also applied for the button lighting in "Adjusting the Dimmer of Button Lighting at Night" (page 32).

Adjusting the Minimum Level of Backlight

You can adjust the brightness of the backlight (LOW). This function could be used, for instance, to change the screen brightness while travelling at night.

Setting item: DIMMER LOW LEVEL
Setting content: -15 to +15

You can adjust the level between MIN (-15) and MAX (+15). When it reaches the minimum or maximum point, the display shows "MIN" or "MAX" respectively.

Switching Background Textures

You have a choice of background textures you can set.

Setting item: BACKGROUND
Setting content: MODE1 / MODE2

- This operation can be carried out after removing the disc from the unit or when playback of the disc has stopped.
- Wallpapers downloaded from "Downloading the MY BACKGROUND data" (page 44) are recalled.
- When you select a source other than the built-in disc on this unit, and the built-in disc is selected on the rear monitor connected to the unit, background textures cannot be displayed on the unit.
- When an error message is displayed (ERROR, HI-TEMP, etc.), background textures selected by this setting cannot be displayed on the unit.

Setting Automatic Background Textures

The background texture will automatically change each time the ignition key is turned off and turned back on again.

Setting item: AUTO BACKGROUND
Setting content: OFF / ON

- ON: Turn on the Auto Background Texture Scroll mode.
The background textures will scroll when the ignition key is turned off once and turned back on again as follows:
MODE1 ↔ MODE2
- OFF: Turn off the Auto Background Texture Scroll mode.

- Wallpapers downloaded from "Downloading the MY BACKGROUND data" (page 44) are recalled.

Setting the Font Type

You can choose a character (text and tag information, etc.) font type for the main display.

Setting item: FONT TYPE
Setting content: FONT 1 / FONT 2

- FONT1: Selects bold characters.
FONT2: Selects round characters.

Switching the Font Back Display Color

You can choose from 5 different display colors for the font back (source title, shortcut display, etc.).

Setting item: BASE COLOR
Setting contents: MODE 1 to MODE 5

Turning the Touch Panel Vibration ON or OFF

You can turn the touch panel's vibration ON or OFF during operation.



Setting item: PULSETOUCH
Setting content: OFF / ON

- OFF: Turns off vibration during operation.
ON: Turns on vibration during operation.

Adjusting the Touch Panel

Adjustment becomes necessary when the display position on the LCD and the touch position on the touch panel do not match.

Setting item: SCREEN ALIGNMENT
Setting content:  / RESET

- 1 Touch [] of SCREEN ALIGNMENT.
The adjustment screen appears.
- 2 Accurately touch the  mark provided in the lower left corner of the screen.
The screen changes to the adjustment screen.
- 3 Accurately touch the  mark provided in the upper right corner of the screen.
This completes adjustment, and returns to the DISPLAY setup mode screen.

- If you have touched a location other than the  mark, touch [RESET] to restore the adjustment screen to the initial setting.
- If you touch [RETURN] on the adjustment screen, no adjustment is done and the DISPLAY setup screen is restored.

i-Personalize™

Media Xpander Function

Setting the MX mode

To display the i-Personalize mode screen:

To watch a video source, your vehicle must be parked with the ignition key in the ACC or ON position. To do this, follow the procedure below.

- 1 Bring your vehicle to a complete stop at a safe location. Engage the parking brake.
- 2 Keep pushing the foot brake and release the parking brake once then engage it again.
- 3 When the parking brake is engaged for the second time, release the foot brake.

- For automatic transmission vehicles, place the transmission lever in the Park position.

Now, the locking system for the i-Personalize mode operation has been released. Engaging the parking brake can reactivate the i-Personalize mode, as long as the car's ignition has not been turned off. It is not necessary to repeat the above procedure (1 through 3), of "To display the i-Personalize mode screen." Each time the ignition is turned OFF, perform the procedure of "To display the i-Personalize mode screen."

MX (Media Xpander) makes vocals or instruments sound distinct regardless of the music source. The radio, CD, and MP3, will be able to reproduce the music clearly even in cars with a lot of road noise.

- 1 Touch **[SETUP]** on the source main screen.
The SETUP selection screen is displayed.
- 2 Touch **[i-Personalize]**.
The screen changes to the i-Personalize.
- 3 Touch **[OFF]** or **[ON]** of **MEDIA XPANDER** to turn **MX ON** or **OFF**.
OFF: MX mode is canceled for all music sources.
ON: The selected MX mode is turned on.
- 4 After setting to ON, touch **[>>]**.
The screen changes to the Media Xpander setting screen.
- 5 Touch **[◀]** or **[▶]** of the desired **MX mode**.
The level of the audio source can be adjusted.

MX CD (OFF, CD MX 1 to 3)

The large quantity of uncompressed CD data is processed to reproduce the sound with more clarity.

MX COMPRESS MEDIA (OFF, CMPM MX 1 to 3) / MX SAT (OFF, SAT MX 1 to 3)

This corrects information that was omitted at the time of compression. This reproduces a well-balanced sound close to the original.

MX FM (OFF, FM MX 1 to 3)

The medium to high frequencies become more clear, and produces well balanced sound in all the bands.

MX DVD (OFF, MOVIE MX 1 to 2)

The dialog portion of the video is reproduced more clearly.

(DVD MUSIC)

This disk contains a large quantity of data such as a music clip. MX uses this data to reproduce the sound accurately.

MX AUX 1 to 3 (OFF, CMPM MX, MOVIE MX, MUSIC MX)

Choose the MX mode (CMPM, MUSIC, or MOVIE) that corresponds to the media connected.

6 Touch **[RETURN]** to return to the previous screen.

- When OFF is selected, MX effect of each MX mode will be off.
- Each music source, such as radio, CD and MP3 can have its own MX setting.
- AUX is displayed when ON is selected in "Setting the AUX Mode" (page 34).
- MX mode does not function for AM radio, NAV. mode when MX is ON.
- MX COMPRESS MEDIA is applied for MP3/WMA, MMD, iPod.
- If the unit is connected to an audio processor with the MX function, such as PXA-H700, etc., the MX processing can be applied to the audio processor. In this case the audio processor needs to be adjusted. For details, refer to the Owner's Manual of the audio processor.
- This function is inoperable when Defeat is set to ON.
- The MX setting function is applied for Pre-out output.

Bass Engine Function

Setting the Bass Engine

The following steps 1 to 6 are common operations to each "Setting item" of bass engine Setup. Refer to each section for details.

- 1 Touch **[SETUP]** on the source main screen.
The SETUP selection screen is displayed.
- 2 Touch **[i-Personalize]**.
The i-Personalize screen appears.
- 3 Touch **[>>]** of **BASS ENGINE**.
The screen changes to the Bass Engine setting screen.
- 4 Touch **[◀]**, **[▶]** or **[>>]** of the desired **Bass Engine setting item**.

Setting items

BASS MAX EQ / P-EQ / BASS FOCUS / T.CORR
(TIME CORRECTION) / X-OVER / SUBWOOFER

- 5 Touch **[◀]**, **[▶]** or the adjusted screen of the selected setting item, and change the setting.

- When setting is complete, storing in memory is recommended.

- 6 Touch **[RETURN]**.
The screen returns to the previous one.

Selecting Bass Max EQ mode (Maker's setting)

10 typical equalizer settings are preset at the factory for a variety of musical source material.

Setting item: BASS MAX EQ

Setting contents: FLAT / ROCK / POPS / JAZZ / ELECTRIC / HIPHOP / EASY / COUNTRY / CLASSIC / NEWS / CUSTOM*

* Contents that are adjusted in parametric EQ.

Adjusting and Storing/Recalling the Parametric EQ

The frequency bands of the graphic equalizer are fixed. This makes it very difficult to correct for undesired peaks and dips at specific frequencies. The parametric equalizer's center frequency can be tuned to these specific frequencies. Then, the bandwidth (Q) and level are fine-tuned, independently, to make the necessary corrections. The parametric equalizer function is an advanced tool for serious audiophiles.

Setting item: P-EQ

- 1 Touch [>>] of P-EQ.
The screen changes to the P-EQ screen to be adjusted.
- 2 Adjust the desired band.

P-EQ adjustment screen example

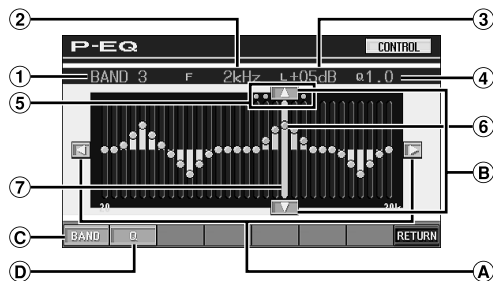

- 1 Displays the band currently selected
- 2 Displays the center frequency of the band currently selected
- 3 Displays the band level currently selected
- 4 Displays the bandwidth (Q) of the band currently selected
- 5 Variable range of center frequency of the band currently selected
- 6 Active point: displays the center frequency and level position of the band currently selected
- 7 Active bar: displayed the variable range of the band level currently selected with an orange bar

Adjusting the Frequency

- Ⓐ Touch [◀] or [▶], and adjust the selected band frequency.

Center Frequency

HIGH : 10kHz, 12.5kHz, 15kHz
 MID-HIGH : 500Hz, 700Hz, 1kHz, 2kHz, 4kHz, 6kHz
 MID-LOW : 100Hz, 150Hz, 200Hz
 LOW : 40Hz, 60Hz, 90Hz

Adjusting the Level

- Ⓑ Touch [▲] or [▼], and adjust the selected band level.

Level: -12 ~ +12

Selecting the Band

- Ⓒ The band (BAND1 through BAND4) changes each time the [BAND] is touched.
 The variable range of the active bar and the center frequency moves according to the band.

BAND1 : LOW
 BAND2 : MID-LOW
 BAND3 : MID-HIGH
 BAND4 : HIGH

- Touching outside the range for a selected band will move the active bar to a band where the touched position can be adjusted.

Setting the Bandwidth

- Ⓓ The bandwidth changes each time [Q] is touched.

HIGH : 1.0 (Bandwidth setting for HIGH is not available.)
 MID-HIGH : 1.0, 2.0, 3.0
 MID-LOW : 1.0, 1.5, 2.0
 LOW : 1.0, 2.0, 3.0

Adjusting the Level/Frequency Directly

Move to a desired position by touching the active point and change the setting contents. Or, move the active point to the desired position by touching where you wish to move it.

- If you set the parametric EQ, BASS MAX EQ setting content is set to "CUSTOM."
- 3 Touch [RETURN] to return to the previous screen.

Storing Adjusted Contents

The following operation is performed after Step 3 above.

- 4 Touch [MEMORY] on the BASS ENGINE screen.
- 5 Within 5 seconds, touch any one of preset buttons [P.SET 1] through [P.SET 6].
 The adjusted contents are stored on the P.SET number you touch.

- The stored contents on the P.SET number remain undeleted despite a following reset operation or disconnection of the battery power cord.
- Adjusted/set contents of each setting item in Bass Engine can be stored in the preset buttons (1 through 6).

Recalling the Adjusted and Stored Contents

Following operation is performed after Step 3 above.

- 4 Touch any one of [P.SET 1] to [P.SET 6] on the BASS ENGINE screen.
 Recall the adjusted and stored contents.

- This function is inoperable when Defeat is set to ON.

About the Time Correction

The distance between the listener and the speakers in a car vary widely due to the special conditions of the mobile environment. This difference in the distances from the speakers to the listener creates a shift in the sounds image and frequency characteristics. This is caused by the time delay between the sound reaching the listener's right versus left ear. To correct this, the IVA-D310 is able to delay the audio signal to the speakers closest to the listener. This effectively creates a perception of increased distance for those speakers. The listener can be placed at an equal distance between the left and right speakers for optimum staging. The adjustment will be made for each speaker in a step of 0.1 ms.

Example 1. Listening Position: Front Left Seat

Adjust the time correction level of the front left speaker to a high value and the rear right to zero or a low value.

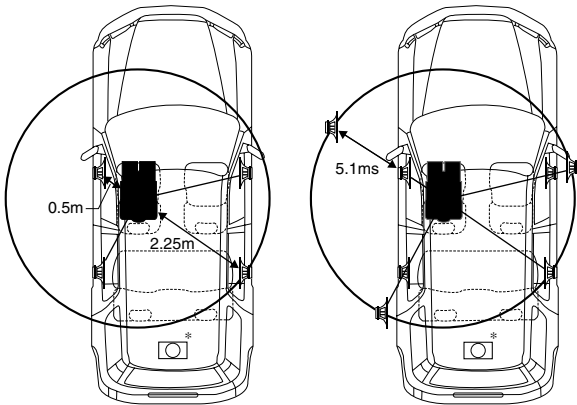

Tips

* Subwoofer speaker

You cannot change the time correction value for the subwoofer, but you can set the subwoofer's apparent position to the front by adjusting the time correction value of the front and rear speakers.

For details, refer to the "Tips" on page 41.

Here we calculate the time correction value for the front left speaker in the diagram above.

Conditions:

Farthest Speaker – listening position: 2.25 m (88-9/16")

Front left speaker – listening position: 0.5 m (19-11/16")

Calculation: $L = 2.25 \text{ m} - 0.5 \text{ m} = 1.75 \text{ m} (68\text{-}7/8\text{'})$

Time correction = $1.75 \div 343 \times 1000 = 5.1 \text{ (ms)}$

** Speed of sound: 343 m/s (765 mph) at 20°C

The sound is not balanced because the distance between the listening position and the various speakers is different. The difference in distance between the front left speaker and the rear right speaker is 1.75 m (68-7/8").

Time correction eliminates the differences in the time required for the sound to reach the listening position.

The time of the front left speaker is corrected by 5.1 ms so that its sound reaches the listening position at the same time as the sound of other speakers.

In other words, giving the front left speaker a time correction value of 5.1 ms makes it seem as if the distance to the front left speaker is the same as the distance to the farthest speaker.

Example 2. Listening Position: All Seats

Adjust the time correction level of each speaker to almost the same level.

- 1 Sit in the listening position (driver's seat, etc.) and measure the distance (in meters) between your head and the various speakers.
- 2 Calculate the difference between the distance to the farthest speaker and the other speakers.
 $L = (\text{distance to farthest speaker}) - (\text{distance to other speakers})$
- 3 Divide the distances calculated for the speakers by the speed of sound (343 m/s (765 mph) at 20°C). These values are the time correction values for the different speakers.

Adjustment and Storing/Recalling of Time Correction

Before performing the following procedures, refer to "About the Time Correction" (page 39).

Setting item: T.CORR (TIME CORRECTION)

Setting contents: 0.0 - 9.9

- 1 Touch [\gg] of T.CORR.
The screen changes to the T.CORR. setup screen.
- 2 Touch [\blacktriangleleft] or [\blacktriangleright] of the desired speaker to adjust the time correction value (0.0 to 9.9).
- 3 Repeat Step 2 above to set another speaker.
- 4 Touch [RETURN] to return to the previous screen.

• The setting contents which have been set in "Time Correction" are applied for the Bass Focus mode.

• The time correction adjusting function can be applied for Pre-out output.

Storing the Adjusted Contents

The storing/recalling of time correction operation is performed after Step 4 above.

- 5 Touch [MEMORY] on the BASS ENGINE screen.
- 6 Within 5 seconds, touch any one of preset buttons [P.SET 1] through [P.SET 6].
The adjusted contents will be stored on the preset number you touch.

• The stored contents on the P.SET number remain undeleted despite a reset operation or disconnection of the battery power cord.

• Adjusted/set contents of each setting item in Bass Engine can be stored in the preset buttons (1 through 6).

Recalling the Stored Time Correction Setting

The storing/recalling of time correction operation is performed after Step 4 above.

- 5 Touch any one of [P.SET 1] to [P.SET 6] on the BASS ENGINE screen.
The stored adjusting contents will be recalled.

Adjusting and Storing/Recalling the Bass Focus

The time difference between the front-rear/left-right speakers, can be adjusted at the same time. With an initial delay of 0.1 ms for each of the 0 to 99 steps, audible time correction can be done.

Setting item: BASS FOCUS

Setting contents: 0-99

- 1 Touch [>>>] of BASS FOCUS.
The screen changes to the BASS FOCUS setup screen.
 - 2 Set the delay number in the front and rear as well as on the right and left by touching either button [◀] or [▶] of the front, rear, right and left speakers.
 - 3 Repeat the Step 2 above to set another channel (speaker).
 - 4 Touch [RETURN] to return to the previous screen.
- Any manual time correction adjustments will also affect corrections made for bass focus.

Storing Adjusted Contents

The following operation is performed after Step 4 above.

- 5 Touch [MEMORY] on the BASS ENGINE screen.
 - 6 Within 5 seconds, touch any one of preset buttons [P.SET 1] through [P.SET 6].
The adjusted contents are stored on the P.SET number you touch.
- The stored contents on the P.SET number remain undeleted despite a following reset operation or disconnection of the battery power cord.
 - Adjusted/set contents of each setting item in Bass Engine can be stored in the preset buttons (1 through 6).

Recalling the Adjusted and Stored Contents

Following operation is performed after Step 4 above.

- 5 Touch any one of [P.SET 1] to [P.SET 6] on the BASS ENGINE screen.
Recall the adjusted and stored contents.

Time Difference Table

Number of Steps	Time Difference (ms)	Distance cm (inch)	Number of Steps	Time Difference (ms)	Distance cm (inch)
0	0.0	0.0	51	5.1	174.9 (68-7/8")
1	0.1	3.4 (1-3/8")	52	5.2	178.4 (70-1/4")
2	0.2	6.9 (2-3/4")	53	5.3	181.8 (71-9/16")
3	0.3	10.3 (4-1/16")	54	5.4	185.2 (72-7/8")
4	0.4	13.7 (5-3/8")	55	5.5	188.7 (74-1/4")
5	0.5	17.2 (6-13/16")	56	5.6	192.1 (75-5/8")
6	0.6	20.6 (8-1/8")	57	5.7	195.5 (77")
7	0.7	24.0 (9-7/16")	58	5.8	198.9 (78-5/16")
8	0.8	27.4 (10-13/16")	59	5.9	202.4 (79-11/16")
9	0.9	30.9 (12-3/16")	60	6.0	205.8 (81")
10	1.0	34.3 (13-1/2")	61	6.1	209.2 (82-3/8")
11	1.1	37.7 (14-13/16")	62	6.2	212.7 (83-3/4")
12	1.2	41.2 (16-1/4")	63	6.3	216.1 (85-1/16")
13	1.3	44.6 (17-9/16")	64	6.4	219.5 (86-3/8")
14	1.4	48.0 (18-7/8")	65	6.5	223.0 (87-3/4")
15	1.5	51.5 (20-1/4")	66	6.6	226.4 (89-1/8")
16	1.6	54.9 (21-5/8")	67	6.7	229.8 (90-1/2")
17	1.7	58.3 (22-15/16")	68	6.8	233.2 (91-13/16")
18	1.8	61.7 (24-1/4")	69	6.9	236.7 (93-3/16")
19	1.9	65.2 (25-5/8")	70	7.0	240.1 (94-1/2")
20	2.0	68.6 (27")	71	7.1	243.5 (95-7/8")
21	2.1	72.0 (28-3/8")	72	7.2	247.0 (97-1/4")
22	2.2	75.5 (29-11/16")	73	7.3	250.4 (98-9/16")
23	2.3	78.9 (31-1/16")	74	7.4	253.8 (99-7/8")
24	2.4	82.3 (32-3/8")	75	7.5	257.3 (101-1/4")
25	2.5	85.8 (33-3/4")	76	7.6	260.7 (102-5/8")
26	2.6	89.2 (35-1/8")	77	7.7	264.1 (104")
27	2.7	92.6 (36-7/16")	78	7.8	267.5 (105-5/16")
28	2.8	96.0 (37-3/4")	79	7.9	271.0 (106-11/16")
29	2.9	99.5 (39-13/16")	80	8.0	274.4 (108-1/16")
30	3.0	102.9 (40-1/2")	81	8.1	277.8 (109-3/8")
31	3.1	106.3 (41-7/8")	82	8.2	281.3 (110-3/4")
32	3.2	109.8 (43-1/4")	83	8.3	284.7 (112-1/16")
33	3.3	113.2 (44-9/16")	84	8.4	288.1 (113-1/16")
34	3.4	116.6 (45-7/8")	85	8.5	291.6 (114-3/4")
35	3.5	120.1 (47-5/16")	86	8.6	295.0 (116-1/8")
36	3.6	123.5 (48-5/8")	87	8.7	298.4 (117-1/2")
37	3.7	126.9 (49-15/16")	88	8.8	301.8 (118-13/16")
38	3.8	130.3 (51-5/16")	89	8.9	305.3 (120-3/16")
39	3.9	133.8 (52-11/16")	90	9.0	308.7 (121-1/2")
40	4.0	137.2 (54")	91	9.1	312.1 (122-7/8")
41	4.1	140.6 (55-3/8")	92	9.2	315.6 (124-1/4")
42	4.2	144.1 (56-3/4")	93	9.3	319.0 (125-9/16")
43	4.3	147.5 (58-1/16")	94	9.4	322.4 (126-7/8")
44	4.4	150.9 (59-3/8")	95	9.5	325.9 (128-5/16")
45	4.5	154.4 (60-3/4")	96	9.6	329.3 (129-5/8")
46	4.6	157.8 (62-1/8")	97	9.7	332.7 (131")
47	4.7	161.2 (63-7/16")	98	9.8	336.1 (132-5/16")
48	4.8	164.6 (64-3/4")	99	9.9	339.6 (133-11/16")
49	4.9	168.1 (66-3/16")			
50	5.0	171.5 (67-1/2")			

Example of Bass Focus Setting

- 1 After entering corrections for the front (left and right) speakers in STEP 15, the time difference is 1.5 ms for both front-left and front-right speakers.

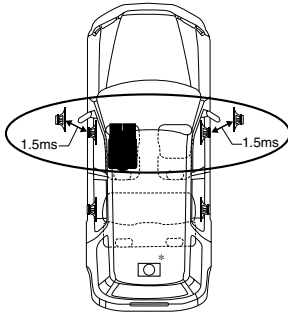

- 2 After entering corrections for the left (front and rear) speakers in STEP 15, the time difference becomes 3.0 ms** for the front left speaker and 1.5 ms for the left rear speaker.

** Because the time difference was already set to 1.5 ms for the front left speaker in STEP 1, the additional correction in STEP 15 makes the time difference of the front left speaker 3.0 ms.

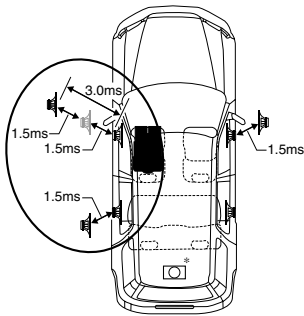

Tips

* Subwoofer speaker

Delay (turn the rotary encoder) the audio signal to the front (left and right) speakers to make the apparent position of the subwoofer to be at the front. In doing this, the apparent position between the front (left and right) speakers and subwoofer will appear equal to the driver. After performing above, you can change the positions of left and right speakers by delaying the time.

Adjustment and Storing/Recalling of the Built-in Crossover

The High and Low Pass Filters on this unit can be adjusted to suit your personal taste.

Setting item: X-OVER

- 1 Touch [➤] of X-OVER.
The screen changes to the X-OVER screen to be adjusted.
- 2 Adjust the crossover to your preference.

X-OVER (LPF) adjustment screen example

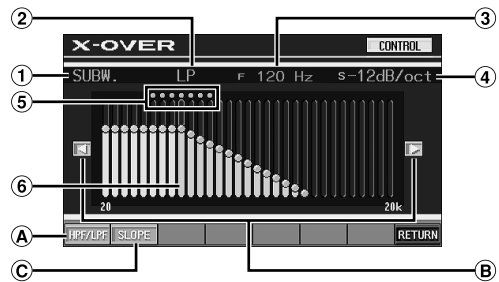

- ① Displays the speaker to be adjusted
When adjusting HPF: FRONT/REAR
When adjusting LPF: SUBBW.
- ② Displays the selected HP or LP
- ③ Displays the cut-off frequency currently selected
- ④ Displays the slope range of currently selected HPF or LPF
- ⑤ Variable range of selected cut-off frequency
- ⑥ Active bar: displays the position of the cut-off frequency currently selected with an orange bar

Switching between HPF and LPF

- A HPF/LPF changes each time [HPF/LPF] is touched.

HPF: Outputs all frequencies higher than that selected according to your preference.

LPF: Outputs all frequencies lower than that selected according to your preference.
(Only available when using the subwoofer output from this unit.)

- Except when the HPF and LPF is turned OFF, the subwoofer is in monaural mode.

Selecting the Cut-Off Frequency

- B Touch [◀] or [▶], then select the cut-off frequency (crossover point).

Setting frequency: 80Hz, 120Hz, 160Hz

Adjusting the Slope

- C Touch [SLOPE], then adjust the HPF or LPF slope.
Setting slope: OFF, -12dB/oct

Adjusting Cut-off Frequency Directly

Touching the variable range of the cut-off frequency moves the cut-off frequency to the touched position.

- 3 Touch [RETURN] to return to the Previous screen.

Storing the Adjusted Contents

Following operation is performed after Step 3 above.

- 4 Touch [MEMORY] on the BASS ENGINE screen.
- 5 Within 5 seconds, touch any one of preset buttons [P.SET 1] through [P.SET 6].
The adjusted contents will be stored on the preset number you touch.

- The stored contents on the P.SET number remain undeleted despite a reset operation or disconnection of the battery power cord.
- Adjusted/set contents of each setting item in Bass Engine can be stored in the preset buttons (1 through 6).

Recalling the Stored Adjusting Contents

Following operation is performed after Step 3 above.

- 4 Touch any one of [P.SET 1] to [P.SET 6] on the BASS ENGINE screen.
The stored adjusting contents will be recalled.

Subwoofer On and Off

Setting item: SUBWOOFER

Setting contents: OFF / 0° / 180°

- OFF: Subwoofer output is off.
- 0°: Subwoofer output is on, and the phase is 0°.
- 180°: Subwoofer output is on, and the phase is 180°.

- The setting of "Subwoofer On and Off" can be stored in the preset buttons (1 through 6).

VISUAL EQ™

Visual EQ Setting Operation

The following steps 1 to 6 are common operations to each "Setting item" of VISUAL EQ setting. Refer to each section for details

- 1 Touch **[SETUP]** on the main source screen.
The SETUP selection screen is displayed.
- 2 Touch **[i-Personalize]**.
The i-Personalize setup screen appears.
- 3 Touch **[>>]** of **VISUAL EQ**.
VISUAL EQ screen appears.
- 4 Select a desired setting item by touching **[▲]** or **[▼]**.

Setting items:

VISUAL EQ* ↔ BRIGHT ↔ COLOR* ↔ TINT* ↔ CONTRAST
↔ SHARP* ↔ USER MEMORY*

- * The setting is available in the visual source mode. (except navigation screen)

- 5 Change the setting on the selected item by touching its **[◀]** or **[▶]**.
- 6 Touch **[RETURN]** to return to the previous screen.
Touch **[CONTROL]** to return to the main source screen that was displayed before the setup operation was started.

Selecting the VISUAL EQ Mode (Maker's setting)

You can select a mode suitable for the subject image.

Setting item: VISUAL EQ

Setting contents: OFF (FLAT) / NIGHT M. / SOFT / SHARP / CONTRAST / P-1 / P-2

- OFF (FLAT): Initial Setting
- NIGHT M.: Suitable for movies in which dark scenes frequently appear.

- SOFT: Suitable for CGs and animated films.
- SHARP: Suitable for old movies where images are not clearly shown.
- CONTRAST: Suitable for recent movies.
- P-1: Recalls the VISUAL EQ mode being stored on preset No.P-1 from "Storing VISUAL EQ" (page 43).
- P-2: Recalls the VISUAL EQ mode being saved on preset No.P-2 from "Storing VISUAL EQ" (page 43).

- To return to the initial setting after selecting any one of the setting contents (NIGHT M. to CONTRAST) and adjusting a desired brightness, picture tint, etc., set this function to OFF.
- If your desired brightness, picture tint, etc., are adjusted after selecting any one of the setting contents (NIGHT M. to CONTRAST), "CUSTOM" is displayed.

Adjusting Brightness

Setting item: BRIGHT

Setting content: -15 ~ +15

You can adjust the brightness between MIN (-15) and MAX (+15). When it reaches the minimum or maximum point, the display shows "MIN" or "MAX" respectively.

- When any NIGHT M. to CONTRAST setting item is selected, the brightness is automatically adjusted according to the car's interior brightness if AUTO is set in "Setting the Brightness of the Backlighting" (page 35).

Adjusting Color of Picture

Setting item: COLOR

Setting content: -15 ~ +15

You can adjust the color between MIN (-15) and MAX (+15). When it reaches the minimum or maximum point, the display shows "MIN" or "MAX" respectively.

- Color adjustment can be made only in the navigation, DVD, Video CD, AUX1 and AUX2 modes.
- Color adjustment cannot be made if a Navigation system with the RGB feature is connected.

Adjusting Tint of Picture

Setting item: TINT

Setting content: G15 ~ R15

Adjust the color from G15 to R15. "G MAX" or "R MAX" is displayed at the maximum of each color.

- Tint adjustment can be made only in the navigation, DVD, Video CD, AUX1 and AUX2 modes.
- Tint adjustment cannot be made if a Navigation system with the RGB feature is connected.

Adjusting Image Contrast

Setting item: CONTRAST

Setting content: -15 to +15

Adjustment of contrast is done in the range of -15 to +15. "HIGH" and "LOW" appear as the maximum and minimum values specified.

- When any NIGHT M. to CONTRAST setting item is selected, image contrast is automatically adjusted according to the car's interior brightness if AUTO is set in "Setting the Brightness of the Backlighting" (page 35).

Adjusting Picture Quality

Setting item: SHARP

Setting content: -15 to +15

Adjustment of picture quality is done in the range of -15 to +15. "HARD" and "SOFT" appear as the maximum and minimum values specified.

- Picture quality adjustment can be made only in the navigation, DVD, Video CD, AUX1 and AUX2 modes.
- Picture quality adjustment cannot be made if a Navigation system with the RGB feature is connected.

Storing VISUAL EQ

You can store the settings made for "Adjusting Image Brightness, Tint, Depth, Picture Quality and Contrast."

Setting item: USER MEMORY

Setting content: P-1 / P-2

- 1 After completing "Adjusting Brightness, Tint, Depth, Picture Quality, and Contrast" (page 42), touch [◀] or [▶] of USER MEMORY and then select preset No. [P-1] or [P-2] to which the settings are to be stored.
 - 2 After selecting a preset No., touch [WRITE]. The adjusted VISUAL EQ mode is stored by the above operations.
- You can recall the VISUAL EQ mode stored here from P-1 or P-2 of "Selecting the VISUAL EQ Mode (Maker's setting)" (page 42).

Data Download

About SOUND SETUP/BACKGROUND Download

You can download data (from Alpine's website) to a CD-R/CD-RW (data is written in the root folder) or HDD*¹, and store the data to the IVA-D310.

To start SOUND SETUP/BACKGROUND download, access the URL below and follow the on-screen instructions.

<http://www.alpine.com> or <http://www.alpine-europe.com> or <http://www.alpine.com.au>

*¹ When the optional HDA-5460 is connected, only SOUND SETUP is applied.

Downloadable data

Parametric equalizer	Data is memorized in Preset 6 of the Parametric EQ Mode.
Time correction	Data is memorized in Preset 6 of the Time Correction Mode.
Crossover	Data is memorized in Preset 6 of the crossover mode.
Subwoofer	Subwoofer phase setting is memorized in Preset 6.

The file name of download data shall be "A_U*****.MP3"

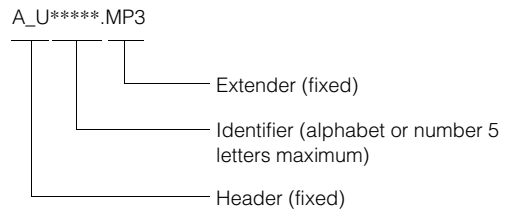

You can create a file name via the website. Do not change a file name once it has been created. Malfunction may result.

- For details about procedures of download, see ALPINE's Web site.
- If an external audio processor is connected, data that is downloaded cannot be used.

Data Downloading

1 Insert the CD-R/CD-RW disc containing the data.

- If the optional HDA-5460 is connected, steps 2 to 7 can be performed after the data has downloaded removable hard disc. The MM DRIVER main source screen can then be selected on this unit.
- If audio data is contained in a CD-R/CD-RW, set to "MP3" in "Playing MP3/WMA Data" (page 32).

2 Touch [SETUP].

The SETUP selection screen appears.

3 Touch [i-Personalize].

The i-Personalize screen appears.

4 Touch [≫] of DATA DOWNLOAD.

5 Touch [≫] of SOUND SETUP.

The unit starts searching the disc for data. When the data search has completed, the Data Download file selection screen is displayed.

- If a file is not found by the data search, "NO FILE" is indicated.

6 Touch [≫] of file which is to be downloaded.

Data downloading starts.

When data has been successfully downloaded, the confirmation screen is displayed for 5 seconds, and the screen returns to the file selection screen.

PARAMETRIC EQ data

The data is memorized in Preset 6 of Parametric EQ mode. The memorized data settings in Preset 6 (Parametric EQ mode) are automatically applied.

X-OVER (Crossover) data

The data is memorized in Preset 6 of X-OVER mode. The memorized data settings in Preset 6 (X-OVER mode) are automatically applied.

TIME CORRECTION data

The data is memorized in Preset 6 of the Time correction mode. The memorized data settings in Preset 6 (Time Correction mode) are automatically applied.

Subwoofer data

The data is memorized in preset 6 of the Subwoofer mode. The memorized data settings in preset 6 (Subwoofer) are automatically applied.

7 Touch [RETURN] to return to the previous screen.

Touch [CONTROL] to return to the main source screen which was previously set.

- When you download the data again, the data is overwritten in Preset 6.

Downloading the MY BACKGROUND data

1 Insert the CD-R/CD-RW disc containing the data you need.

After sensing the disc, the DATA DOWNLOAD screen is displayed.

2 Touch [◀] or [▶] of MY BACKGROUND, then select USERS1 or USERS2.

The selected wallpaper can be changed.

3 Touch [≫] of MY BACKGROUND.

Data search of the disc starts. After completing the data search, the file selection screen of Data Download is displayed.

4 Touch [▲] or [▼] to select the desired file name.

5 Touch [MEMORY].

Data download starts.

When data downloading has completed correctly, the screen returns to the DATA DOWNLOAD screen.

6 Touching [RETURN] returns to the previous screen.

Touching [CONTROL] returns to the earlier main source screen.

- If data is newly downloaded, the data overwrites the previous data.
- If the battery power cable is removed, the downloaded data is memorized.
- You can recall a wallpaper in "Switching Background Textures" (page 36), or "Setting Automatic Background Textures" (page 36).
- When download has completed, remove the disc.

Setting AMP Link (Optional)

Recalling the Display of the External Amplifier Setting and Status (Option)

When an external amplifier (MRV-F545, MRV-F345, MRD-M1005, MRD-M605) is connected, you can set it from this unit. Up to eight amplifiers can be set.

- If amplifier settings are made on the unit, do not then change the setting with the amplifier buttons, as the amplifier display may not match the operation of the unit.
- To make the setting, set to "Setting the VISUAL Touch Button" (page 34).

1 Touch [VISUAL] on the main source screen.

The VISUAL selection screen appears.

2 Touch [AMP STATUS].

The AMP status screen is displayed.

AMP status screen display example

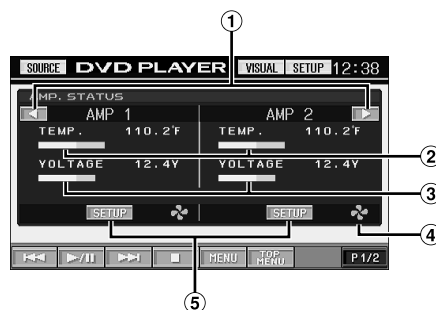

- ① Turns pages
- ② Temperature (°F)
- ③ Voltage (V)
- ④ Lights up when FAN is activated
- ⑤ Selected AMP Setup screen appears.

3 Touch [SETUP] on the AMP status screen.

The screen changes to the AMP SETUP screen of the selected AMP.

4 Set the desired setting mode by touching [◀] or [▶].

Setting mode: AMP DISPLAY

Setting contents: TEMP.(C)/TEMP.(F)/VOLT./SCAN

Displays the indication you set on the connected amplifier.

Setting mode: INPUT GAIN (monaural amplifier connected),
INPUT GAIN CH1/2, CH3/4 (4CH amplifier connected)

Setting contents: 0.1V to 8V (monaural amplifier connected)
0.2V to 4V (4CH amplifier connected)

5 To set another amplifier, touch [RETURN], and repeat steps 3 and 4.

6 To cancel the AMP status screen, touch [VISUAL].

The VISUAL screen appears.

7 Touch [NORMAL].

The screen returns to the normal screen.

AMP Link Lock Function

This setting has a function that prevents accidental adjustment of the INPUT GAIN in order to prevent speaker damage.

1 Touch and hold [RETURN] for at least 3 seconds on the AMP SETUP screen.

The LOCK mode is turned on, and the setting mode for INPUT GAIN becomes inactive when the AMP SETUP screen is displayed, and "LOCK" is displayed in the setting content next time.

To be functional the setting mode for INPUT GAIN, the LOCK mode is canceled by touching and holding [RETURN] for at least 3 seconds on the AMP SETUP screen.

External Audio Processor (Optional)

When an external audio processor is connected to this unit, you can operate it from this unit. Some audio processors may not be operated. When PXA-H510 or PXA-H900 is connected, some of the operations may not be performed from this unit. In this case, operate them in the connected product. Explanations below is the case when PXA-H700 or PXA-H701 is connected for example.

Refer also to the operating instructions of the connected audio processor.

- The adjustments or settings performed on the connected audio processor cannot be operated properly from this unit.
- The setting "Setting the Speakers", "Setting Bass Sound Control", and "Graphic Equalizer Adjustments" are not available if the MRA-D550 is connected. Also, the setting content differs between the PXA-H700 and PXA-H701.

To display the Audio processor mode screen:

To watch a video source, your vehicle must be parked with the ignition key in the ACC or ON position. To do this, follow the procedure below.

- 1 Bring your vehicle to a complete stop at a safe location. Engage the parking brake.
- 2 Keep pushing the foot brake and release the parking brake once then engage it again.
- 3 When the parking brake is engaged for the second time, release the foot brake.

- For automatic transmission vehicles, place the transmission lever in the Park position.

Now, the locking system for the Audio processor mode operation has been released. Engaging the parking brake can reactivate the Audio processor mode, as long as the car's ignition has not been turned off. It is not necessary to repeat the above procedure (1 through 3), of "To display the Audio processor mode screen."

Each time the ignition is turned OFF, perform the procedure of "To display the Audio processor mode screen."

Adjustment Procedure for Dolby Surround

Make the adjustments described below in order to reproduce Dolby Digital and DTS sound with greater accuracy.

Adjustment procedure

- 1 Speaker Setup (page 50)**
(Turning the speakers to be used on and off and setting their response)
- 2 Adjusting the speaker levels (page 51)**
(Adjusting the signal output level to the various speakers)
- 3 Mixing bass sound to the rear channel (page 51)**
(Achieving smooth sound in the rear seat by mixing the front audio signals with the rear speaker signals)
- 4 Adjusting the acoustic image (page 51)**
(Adjusting the acoustic image to achieve a sound as if the centre speaker were directly in front of the listener)
- 5 Achieving powerful high volume sound (page 51)**
(Achieving energetic sound with even greater power, like the sound in a movie theater)
- 6 Adjusting the DVD Level (page 51)**
(Adjust the volume (signal level) in the Dolby Digital, Pro Logic II, DTS and PCM modes.)
- 7 Storing Settings in the Memory (page 52)**
(Storing all the settings and adjustments made on the IVA-D310 (not only the above settings/adjusts) in the memory)

In case of combining the Automatic adjustments etc.

We recommend to make the Automatic adjustments before the Dolby Surround adjustments.

Setting the Speakers

- 1 **Check that Defeat mode is off (page 23-24).**
- 2 **Touch [SETUP] on the main source screen.**
The SETUP selection screen is displayed.
- 3 **Touch [i-Personalize].**
The i-Personalize screen appears.
- 4 **Touch [>>] of A.PROCESSOR.**
The A.PROC list screen appears.
- 5 **Touch [>>] of SPEAKER SELECT.**
The SPEAKER SELECT screen appears.
- 6 **Set the connected speaker by touching the respective [◀], [▶] or [ON], [OFF] button.**
FRONT1: OFF/FULL (Full Range)/TW (Tweeter)
FRONT2: OFF/ON
REAR: OFF/ON
CENTER: OFF/ON
SUBWOOFER: OFF/MONO/STEREO
- 7 **Touch [RETURN] to return to the previous screen.**
 - Set the speaker which is not connected to OFF.
 - Settings above can be carried out even when the speaker is set to OFF in "Speaker Setup" (page 50).
 - To use the subwoofer in MONO with PXA-H700 or PXA-H701 connected, connect the subwoofer to the subwoofer output terminal of PXA-H700 or PXA-H701.

Set MX Mode of the External Audio Processor

Before performing the operations below, set MX (Media Xpander) mode of the PXA-H700 to "AUTO" when the PXA-H700 is connected.

- 1 **Check that Defeat mode is off.**
- 2 **Touch [SETUP] on the main source screen.**
The SETUP selection screen appears.
- 3 **Touch [i-Personalize].**
The i-Personalize screen will appear.
- 4 **Select ON or OFF of MX by touching [ON] or [OFF] of MEDIA XPANDER.**
OFF: Turns off the MX effect of every music source.
ON: Turns on the specified MX mode.
- 5 **Touch [>>] after setting to ON.**
The Media Xpander setup screen appears.

6 Touch [◀] or [▶] of the desired MX mode.

- Music source (such as radio broadcasts and CDs, excluding AM radio) level can be set.

MX CD (OFF, CD MX 1 to 3)

CD mode processes a large quantity of data. This data is used to reproduce the sound clearly by making use of the data quantity.

MX COMPRESS MEDIA (OFF, CMPM MX 1 to 3) / MX SAT (OFF, SAT MX 1 to 3)

This corrects information that was omitted at the time of compression. This reproduces a well-balanced sound close to the original.

MX FM (OFF, FM MX 1 to 3)

The medium to high frequencies become more clear, and produces well balanced sound in all the bands.

MX DVD (OFF, MOVIE MX 1 to 2)

The dialog portion of the video is reproduced more clearly.

(DVD MUSIC)

This disk contains a large quantity of data such as music clip. MX uses this data to reproduce the sound accurately.

MX AUX 1 to 3 (OFF, CMPX MX, MOVIE MX, MUSIC MX)

Choose the MX mode (MP3, MUSIC, or MOVIE) that corresponds to the media connected.

7 Touch [RETURN] to return to the previous screen.

- The contents of MX set here is reflected to PXA-H700 or PXA-H701.
- When OFF is selected, MX effect of each MX mode will be OFF.
- Each music source, such as radio, CD, and MP3 can have its own MX setting.
- MX mode does not function when MX is ON for AM radio.
- MX COMPRESS MEDIA is applied for MP3/WMA, MMD.

X-OVER Adjustment

- 1 **Check that Defeat mode is off.**
- 2 **Touch [SETUP] on the main source screen.**
The SETUP selection screen appears.
- 3 **Touch [i-Personalize].**
The i-Personalize screen will appear.
- 4 **Touch [>>] of A.PROCESSOR.**
The A.PROC list screen appears.
- 5 **Touch [◀] or [▶] of X-OVER to select L/R or L+R.**
L/R: Different adjustment values can be set for the left and right channels.
L+R: Sets the same adjustment values for the left and right channels.
- 6 **Touch [>>] of X-OVER.**
- 7 **Touch [>>] of the speaker to be adjusted.**
The screen changes to the X-OVER screen to be adjusted.

8 Adjust the crossover to your preference.

X-OVER (LPF) adjustment screen example

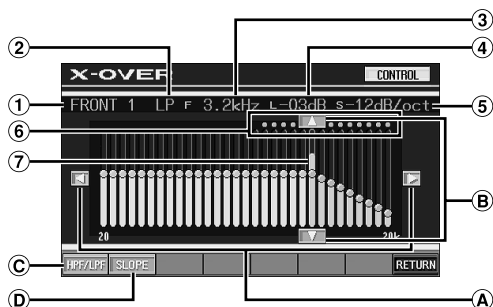

- ① Displays the speaker (channel) currently selected
- ② Displays the HP or LP selected
- ③ Displays the cut-off frequency currently selected
- ④ Displays the level of HPF or LPF currently selected
- ⑤ Displays the slope range of HPF or LPF currently selected
- ⑥ Variable range of selected cut-off frequency
- ⑦ Displays the variable range of the cut-off frequency level currently selected with an orange bar.

Selecting the Cut-Off Frequency

- A Touch [◀] or [▶], then select the cut-off frequency (crossover point).
The adjustable bandwidth differs depending on the speaker (channel).

Adjusting the Level

- B Touch [▲] or [▼], then adjust the HPF or LPF level.

Switching between HPF and LPF

- C HPF/LPF changes each time [HPF/LPF] is touched.
 - HPF: Outputs all frequencies higher than that selected according to your preference.
 - LPF: Outputs all frequencies lower than that selected according to your preference.
(Only available when using the subwoofer output from this unit.)

Adjusting the Slope

- D Touch [SLOPE], then adjust the HPF or LPF slope.

Adjusting Level/Cut-off Frequency Directly

Touching the variable range of the level/cut-off frequency moves the level/cut-off frequency to the touched position.

- If [CANCEL] is displayed while [LOADING] is touched, or an operation is carried out on the connected audio processor, loading is stopped and the setting contents (created before stopping) are displayed.
- Loading time may take longer depending on the setting content. This is not a malfunction.

9 Touch [RETURN] to return to the previous screen.

- When the speaker is set to the "OFF" mode, the X-OVER for that speaker cannot be set. Refer to "Setting the Speakers" (page 46).
- Check the playback frequencies of the connected speakers before adjusting.
- In order to protect the speakers, there is no OFF setting for the subwoofer low pass filter (the slope remains the same).
- The H.P.F. filter cannot be set to OFF (slope OFF) if Tweeter is selected for FRONT1. Or, only the subwoofer is adjustable if STEREO is selected for the subwoofer.

Performing Time Correction Manually (TCR)

Because of the particular conditions inside the vehicle, there can be major differences in the distances between the various speakers and the listening position. It is possible to calculate the optimum correction values and eliminate the time error at the listening position yourself using this function.

- 1 Check that Defeat mode is off.
- 2 Sit in the listening position (the driver's seat, for example) and measure the distance (in meters) between your head and the various speakers.
- 3 Calculate the difference in distance between the farthest speaker and the other speakers.

$$L = (\text{distance of farthest speaker}) - (\text{distance of other speakers})$$

- 4 Divide the distances calculated for the different speakers by the speed of sound (343 m/s temperature 20°C).

This value is the time correction value for the various speakers.

Concrete examples

Calculating the time correction value for the front left speaker on the diagram below.

Conditions:

Distance between farthest speaker and listening position:
2.25 m (88-3/4")

Distance between front left speaker and listening position:
0.5 m (20")

Calculation:

$$L = 2.25 \text{ m (88-3/4")} - 0.5 \text{ m (20")} = 1.75 \text{ m (68-3/4")}$$

$$\text{Compensation time} = 1.75 \div 343 \times 1000 = 5.1 \text{ (ms)}$$

In other words, setting the time correction value for the front left speaker to 5.1 (ms) sets a virtual distance matching the distance to the farthest speaker.

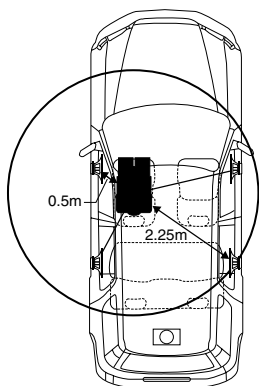

The sound is uneven because the distance between the listening position and the different speakers is different. The difference in the distance between the front left and rear right speakers is 1.75 meters (68-3/4").

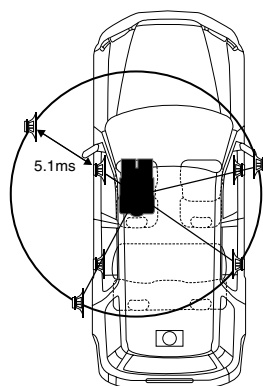

Time correction eliminates the difference between the time required for the sound from the different speakers to reach the listening position. Setting the time correction of the front left speaker to 5.1 ms makes it possible to coordinate the distance from the listening position to the speaker.

- 5 Touch **[SETUP]** on the main source screen.
The SETUP selection screen appears.
 - 6 Touch **[i-Personalize]**.
The i-Personalize screen appears.
 - 7 Touch **[>>]** of **A.PROCESSOR**.
The A.PROC list screen is displayed.
 - 8 Touch **[◀]** or **[▶]** of **T.CORR**.
Select L/R or L+R.
L/R: Different adjustment values can be set for the left and right channels.
L+R: Sets the same adjustment values for the left and right channels.
 - 9 Touch **[>>]** of **T.CORR**.
The T.CORR adjustment screen appears.
 - 10 Adjust the time correction value (0.0 ~ 20.0ms) of a desired speaker by touching the respective **[◀]** or **[▶]** button. (1 step = 0.05ms)
 - 11 Touch **[RETURN]** to return to the previous screen.
- When the speaker is set to the "OFF" mode, the TCR for that speaker cannot be set. Refer to "Setting the Speakers" (page 46).
 - The adjustment value for FRONT2 (Speakers) which is adjusted in time correction, is also applied to the front speakers in "Setting Bass Focus" (page 50).
 - The adjustment (AUTO TCR) cannot be automatically set on this unit.

Phase Switching

- 1 Make sure that the defeat is turned off (page 23-24).
- 2 Touch **[SETUP]** on the main source screen.
The SETUP selection screen is displayed.
- 3 Touch **[i-Personalize]**.
The i-Personalize screen appears.
- 4 Touch **[>>]** of **A.PROCESSOR**.
The A.PROC list screen is displayed.
- 5 Touch **[>>]** of **PHASE**.
The PHASE adjustment screen appears.
- 6 Switch the phase (0° or 180°) by touching **[◀]** or **[▶]** of the desired speaker.
- 7 Touch **[RETURN]** to return to the previous screen.

Graphic Equalizer Adjustments

The graphic equalizer allows you to modify the sound using 31 bands each for the front (left and right), rear (left and right) and center speakers. An additional 10 bands are available for the subwoofer. This allows you to customize the sound to suit your taste.

- 1 Check that the Defeat mode is off.
- 2 Touch **[SETUP]** on the main source screen.
The SETUP selection screen appears.
- 3 Touch **[i-Personalize]**.
The i-Personalize screen will appear.
- 4 Touch **[>>]** of **A.PROCESSOR**.
The A.PROC list screen appears.
- 5 Select **L/R** or **L+R** by touching **[◀]** or **[▶]** of **G-EQ**.
L/R: Different adjustment values can be set for the left and right channels.
L+R: Sets the same adjustment values for the left and right channels.
When parametric EQ is adjusted, this setting will be turned off.
- 6 Touch **[>>]** of **G-EQ**.
The G-EQ list screen appears.
- 7 Touch **[>>]** of the desired speaker (channel).
The G-EQ adjustment screen appears.
- 8 Adjust the G-EQ to your preference.

G-EQ adjustment screen example

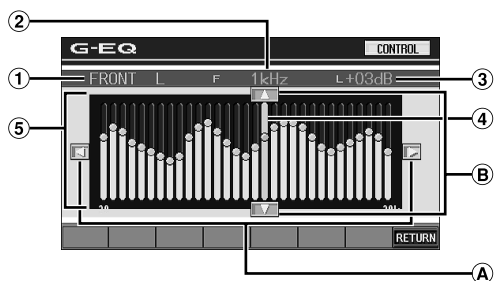

- ① Displays the speaker (channel) currently selected
- ② Displays the selected frequency
- ③ Displays the frequency level currently selected
- ④ Active bar: Displays the variable range of the frequency level currently selected with an orange bar
- ⑤ Setting variable range

Adjusting the Frequency

- Ⓐ Touch [◀] or [▶] to adjust the frequency.

Adjusting the Level

- Ⓑ Touch [▲] or [▼] to adjust the level.

Creating the Curve Directly

Touching any position in the setting variable range moves the active bar to the touched position. Or, touching and creating a curve in the setting variable range immediately displays the new curve.

- If [CANCEL] is displayed while [LOADING] is touched, or an operation is carried out on the connected audio processor, loading is stopped and the setting contents (created before stopping) are displayed.
- Loading time may take longer depending on the setting content. This is not a malfunction.

9 Touch [RETURN] to return to the previous screen.

- When the speaker is set to the "OFF" mode, the graphic equalizer for that speaker cannot be set. Refer to "Setting the Speakers" (page 46).
- Check the playable frequency ranges of the connected speakers before making the equalizer adjustments. If the speaker's playable frequency range is 55 Hz to 30 kHz, for example, adjusting the 40 Hz or 20 Hz band has no effect. Additionally, you may overload and damage the speakers.
- When graphic EQ is adjusted, the adjustment for parametric EQ becomes ineffective.

Parametric Equalizer Adjustments

The frequency bands of the graphic equalizer are fixed. This makes it very difficult to correct for undesired peaks and dips at specific frequencies. The parametric equalizer's center frequency can be tuned to these specific frequencies. Then, the bandwidth (Q) and level are fine-tuned, independently, to make the necessary corrections. The parametric equalizer function is an advanced tool for serious audiophiles.

1 Check that Defeat mode is off.

2 Touch [SETUP] on the main source screen.

The SETUP selection screen appears.

3 Touch [i-Personalize].

The i-Personalize screen will appear.

4 Touch [≫] of A.PROCESSOR.

The A.PROC list screen appears.

5 Select L/R or L+R by touching [◀] or [▶] of P-EQ.

L/R: Different adjustment values can be set for the left and right channels.

L+R: Sets the same adjustment values for the left and right channels.

When graphic EQ is adjusted, this setting will be turned off.

6 Touch [≫] of P-EQ.

The P-EQ list screen appears.

7 Touch [≫] of the desired speaker (channel).

The P-EQ adjustment screen appears.

8 Adjust the P-EQ to your preference.

P-EQ adjustment screen example

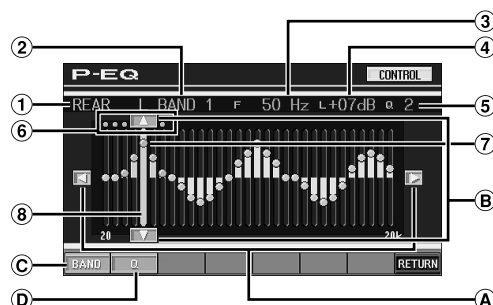

- ① Displays the speaker (channel) currently selected
- ② Displays the currently selected band
- ③ Displays the center frequency of the band currently selected
- ④ Displays the band level currently selected
- ⑤ Displays the bandwidth (Q) of the band currently selected
- ⑥ Variable range of the center frequency of the selected band
- ⑦ Active point: displays the position of the center frequency and level of the band currently selected
- ⑧ Active bar: displayed the variable range of the band level currently selected

Adjusting the Frequency

- Ⓐ Touch [◀] or [▶], then adjust the frequency of the selected band.

Adjusting the Level

- Ⓑ Touch [▲] or [▼], then adjust the level of the selected band.

Selecting the Band

- Ⓒ The band (BAND1 through BAND5) changes each time [BAND] is touched.
The active bar and the variable range of the center frequency move according to the band.
- *Touching outside the variable range for a selected band moves the active bar to a band where the touched position can be adjusted.*

Setting the Bandwidth

- Ⓓ The bandwidth changes each time [Q] is touched.

Adjusting the Level/Frequency Directly

Move to a desired position by touching the active point and change the setting contents. Or, move the active point to the desired position by touching where you wish to move it.

- *Downloading is stopped, and the setting contents (created before stopping by touching [CANCEL] in the display during the download, or operating the connected audio processor) are displayed.*
- *Loading time may take longer depending on the setting content. This is not a malfunction.*

9 Touch [RETURN] to return to the previous screen.

- *When the speaker is set to the "OFF" mode, the parametric equalizer for that speaker cannot be set. Refer to "Setting the Speakers" (page 46).*
- *It is not possible to adjust the frequencies of adjacent bands within 7 steps.*
- *Check the playable frequency ranges of the connected speakers before making the equalizer adjustments. If the speaker's playable frequency range is 55 Hz to 30 kHz, for example, adjusting the 40 Hz or 20 Hz band has no effect. Additionally, you may overload and damage the speakers.*
- *When the parametric EQ is adjusted, the adjustment for graphic EQ becomes ineffective.*

Setting Bass Sound Control

1 Make sure that the defeat is turned off (page 23-24).

2 Touch [SETUP] on the main source screen. The SETUP selection screen is displayed.

3 Touch [i-Personalize]. The i-Personalize screen appears.

4 Touch [>>] of A.PROCESSOR. The A.PROC list is displayed.

5 Touch [>>] of BASS SOUND CONT. The Bass Sound Cont. screen appears.

Setting Bass Compressor

You can adjust the sound of low frequencies as desired.

6 Touch [◀] or [▶] of BASS COMP. to select the desired mode.

Bass sound is emphasized more as the mode is sequentially switched as MODE1 → 2 → 3, offering you vivid low frequencies.

Select OFF when the setting is not necessary.

Touch [RETURN] to return to the previous screen.

Setting Bass Focus

Using the previously specified delay number (time difference) allows you to set a time difference between the front-rear/left-right speakers. Namely, it enables a time correction based on your preference. With an initial delay of 0.05 ms for each of the 0 to 400 steps, audible time correction can be achieved.

6 Set the delay number in the front and rear, and on the right and left of the desired speaker by touching the respective [◀] or [▶] button.

- *Any setting in Bass Focus is applied in time correction, too.*
- *Touch [RETURN] to return to the previous screen.*

Speaker Setup

The PXA-H700 or PXA-H701 can be set according to the playable frequency range of your speakers.

Check the playable frequency range of the speakers (not including the subwoofer) before performing this operation to verify whether the speakers can play low frequencies (of about 80 Hz or less).

- *Avoid stopping, pausing, switching the disc, cueing, fast-forwarding or switching the audio channel of this unit while making this adjustment. The setting is canceled if Decode mode is switched.*

1 Check that Defeat mode is off.

2 Touch [SETUP] on the main source screen. The SETUP selection screen appears.

3 Touch [i-Personalize]. The i-Personalize screen will appear.

4 Touch [>>] of A.PROCESSOR. The A.PROC list screen appears.

5 Touch [>>] of SPEAKER SETUP. The adjusting screen of SPEAKER SETUP appears.

6 Select the speaker characteristic by touching [◀], [▶] or [ON], [OFF] of the desired speaker setting.

OFF*¹: When no speaker is connected.

SMALL: When a speaker that cannot play low frequencies (80 Hz or less) is connected.

LARGE*²: When a speaker that can play low frequencies (80 Hz or less) is connected.

*¹ It is not possible to set the front speakers to "OFF".

*² If the front speakers are set to "SMALL", the rear and center speakers cannot be set to "LARGE".

- *If the center speaker is turned "OFF" the center channel's audio signals are added to the audio signals output from the front speakers.*
- *If you set the speaker response to "OFF," also set the speaker setting to "OFF." (page 46)*
- *Perform the setup for all the speakers ("Front," "Center," "Rear" and "Subwoofer"). If not, the sound may not be balanced.*
- *When center is set to "OFF", the setting is ineffective even if center is set with this function.*
- *Through changing the settings on each speaker, a change in the output of the other speakers may occur due to the setting requirements.*
- *When using the PRO LOGIC II, if the rear speaker is set to "LARGE", then there will be no output from the subwoofer.*

Setting of Dolby 5.1ch

- 1 Check that Defeat mode is off.**
- 2 Touch [SETUP] on the main source screen.**
The SETUP selection screen appears.
- 3 Touch [i-Personalize].**
The i-Personalize screen will appear.
- 4 Touch [>>] of A.PROCESSOR.**
The A.PROC list screen appears.
- 5 Touch [>>] of DOLBY 5.1 CH SETUP.**
The DOLBY 5.1CH SETUP display appears.
Set the items below as you desire.

Adjusting the acoustic image

In most installations, the center speaker must be placed directly between the front passenger and driver. Using this function, the center channel information is distributed to the left and right speakers. This creates an acoustic image simulating a center speaker directly in front of each listener. Adjusting the center width in PL II MUSIC (see "Using the Pro Logic II Mode," page 52), makes this function ineffective.

- Avoid stopping, pausing, switching the disc, cueing, fast-forwarding or switching the audio channel of this unit while making this adjustment. The setting is canceled if the Decode mode is switched.*
 - Touch [◀] or [▶] of BI-PHANTOM to adjust the level.
The level can be adjusted within the range of -5 to +5. The higher the level, the more the position of the center speaker is shifted to the sides.
 - The BI-PHANTOM function is turned off by touching [OFF].
- This adjustment is effective when the setting of the center speaker to SMALL or LARGE in the speaker setup settings.*
- This adjustment is ineffective when the speaker is set to CENTER OFF in "Setting the Speakers" (page 46).*

Mixing bass sound to the rear channel

This function mixes the front channel audio signals to the audio signals output from the rear speakers, improving the sound in the vehicle's rear seat.

- Avoid stopping, pausing, switching the disc, cueing, fast-forwarding or switching the audio channel of this unit while making this adjustment. The setting is canceled if the Decode mode is switched.*
 - Touch [◀] or [▶] of REAR MIX to adjust the level.
The level can be adjusted in five steps: -6, -3, 0, +3 and +6. The higher the level, the more bass is output from the rear speakers. (The effect differs according to the software (DVD, etc.)
The REAR MIX function is turned off by touching [OFF].
- This adjustment is ineffective when the rear speaker setup setting is set to "OFF"*
- For linear PCM signals, the voice is output from the rear speaker regardless of the REAR FILL and REAR MIX setting.*

Achieving powerful high volume sound

With Dolby Digital, the dynamic range is compressed so that powerful sound can be achieved at regular volume levels. This compression can be canceled to achieve an energetic sound with even greater power, like the sound in a movie theater.

This function works only in the Dolby Digital mode.

Touch [◀] or [▶] of LISTENING MODE to select STD or MAX.

STD: For powerful sound at regular volume levels

MAX: For powerful sound at high volumes

- Keep the volume to a level at which sounds outside the vehicle can still be heard.*

Adjusting the speaker levels

The test tones help to make the volume adjustments of the different speakers. When levels are equal, a strong sense of presence can be heard from the different speakers at the listening position.

- Avoid stopping, pausing, switching the disc, cueing, fast-forwarding or switching the audio channel of this unit while making this adjustment. The setting is canceled if the decode mode is switched.*
 - Touch [ON] of OUTPUT LEVEL.
Test tone output is repeated for each of the different speaker channels. They will be repeated in the order shown below.
If no operation is performed for 2 seconds, the channel switches to the next channel.
Left → Center → Right → Right Surround →
Left surround → Left
 - While the test tone is being produced from the speakers, touch [◀] or [▶] of OUTPUT LEVEL balance the output from all the speakers.
 - The adjustment range for the different speakers is -10 dB - +10 dB.
 - Adjust based on the front speakers.
- If a speaker is set to off mode, that speaker's level adjustment cannot be made.
Refer to "Speaker Setup" (page 50).*

Adjusting the DVD Level

The volume (signal level) for Dolby Digital, Dolby PL II, DTS and PCM modes can be set.

- Avoid stopping, pausing, switching the disc, cueing, fast-forwarding or switching the audio channel of this unit while making this adjustment. The setting is canceled if the Decode mode is switched.*

- 1 Check that Defeat mode is off.**
- 2 Touch [SETUP] on the main source screen.**
The SETUP selection screen appears.
- 3 Touch [i-Personalize].**
The i-Personalize screen will appear.
- 4 Touch [>>] of A.PROCESSOR.**
The A.PROC list screen appears.
- 5 Touch [>>] of DVD LEVEL.**
The DVD LEVEL list screen appears.

6 Adjust the level by touching [◀] or [▶] of the desired adjusting mode.

The level can be adjusted in the range of -5 to +5.

Storing Settings in the Memory

Adjustment or setting contents can be stored.

Contents that can be stored vary depends on the audio processor used.

- 1 Check that Defeat mode is off (page 23-24).
- 2 Touch [MEMORY] on the A.PROC list display.
- 3 Within 5 seconds, touch any one of the preset buttons [P.SET 1] through [P.SET 6] on the A.PROC list screen.

The setting contents are stored.

- The stored contents will not be deleted even when the battery power cord is detached.

Getting out the Preset Memory

- 1 Check that Defeat mode is off.
- 2 Touch any one of the preset buttons [P.SET 1] through [P.SET 6] on the A.PROC list display to select the preset memory.

- It takes a few moment to get out the preset memory.

Using the Pro Logic II Mode

Pro Logic processing can be conducted on the music signals recorded on two channels to achieve Dolby Pro Logic II surround sound. For two-channel Dolby Digital and DTS signals, there is also a "REAR FILL" function for outputting the signals of the front channel to the rear channel.

- 1 Check that Defeat mode is off.
- 2 Touch [SETUP] on the main source screen.
The SETUP selection screen appears.
- 3 Touch [i-Personalize].
The i-Personalize screen will appear.
- 4 Touch [➤] of A.PROCESSOR.
The A.PROC list screen appears.
- 5 Touch [➤] of DOLBY PLII.
The DOLBY PLII adjusting screen appears.
- 6 Touch [◀] or [▶] of DOLBY PLII to select the desired mode.

PL II MOVIE: Suits the stereo TV shows and all programs encoded in Dolby Surround. It improves the sound field directivity to near that of discrete 5.1-channel sound.

PL II MUSIC: Can be used for all stereo music recordings, and provides a wide, deep sound field.

REAR FILL: Depending on the input signals, the sound may only be output from the front speakers. In this case, the "REAR FILL" function can be used to output signals from the rear speakers as well.

OFF: Turns DOLBY PL II function to OFF.

If PL II MUSIC is selected, the center width can be adjusted with following operations.

This function offers the optimum vocal position by adjusting the center channel position between the center speaker and the L/R speaker. (The adjustments established in "Adjusting the acoustic image" (page 51) are ineffective while this function is activated.)

Touch [◀] or [▶] of CENTER WIDTH CONT to adjust the level.

The level can be adjusted between 0 to 7. When the level increases, the center channel position moves from the center speaker position to both sides.

Touch [OFF] of CENTER WIDTH CONT to turn off the center width control.

- This adjustment is effective when the setting of the center speaker is SMALL or LARGE in the speaker setup settings.
- Avoid stopping, pausing, switching the disc, cueing, fast-forwarding or switching the audio channel of this unit while making this adjustment. The setting is canceled if the Decode mode is switched.
- This adjustment is ineffective when the speaker is set to CENTER OFF in "Setting the Speakers" (page 46).
- This function only works with two-channel signals. This operation is ineffective when 5.1-channel DTS or Dolby Digital signals are input.
- If the setting of REAR FILL is made when REAR MIX is ON, sound is unchanged in the rear fill setting because REAR MIX is given priority during 2 channel decoder other than linear PCM.
- For linear PCM signals, the voice is output from the rear speaker regardless of the REAR FILL and REAR MIX setting.
- Touching [RETURN] will return to the previous screen.

Linear PCM Setting

The output when playing discs recorded in linear PCM can be set to 2 or 3 channels.

- 1 Check that Defeat mode is off.**
- 2 Touch [SETUP] on the main source screen.**
The SETUP selection screen appears.
- 3 Touch [i-Personalize].**
The i-Personalize screen will appear.
- 4 Touch [>>] of A.PROCESSOR.**
The A.PROC list screen appears.
- 5 Touch [◀] or [▶] of PCM MODE to select 2 CH or 3 CH.**

2CH: 2ch output (L/R)

3CH: 3ch output (L/R/CENTER)

- *This adjustment is ineffective when the speaker is set to CENTER OFF in "Setting the Speakers" (page 46).*

Navigation System (Optional)

Switching the Navigation Screen (Optional)

If an optional Alpine Navigation System is connected to the IVA-D310, the Navigation screen can be displayed on this unit.

- 1 Touch [SOURCE] on the main source screen.**
The source screen appears on the display.
 - 2 Touch [NAV].**
The Navigation screen is displayed.
The operation is possible with the supplied navigation remote control.
For navigation operation, refer to the Owner's Manual of the navigator.
- *While the Navigation selection mode is being selected in "Setting the VISUAL Touch Button" (page 34), the navigation mode will be directly activated.*
 - *If the Navigation mode menu is not displayed on the main menu screen, set NAV. IN to on by following "Setting the Navigation Mode" (page 33).*
 - *When the Navigation System is on, the audio and visual navigation cuts in.*
 - *For operation, if a navigation system with touch panel operation is connected, refer to the Owner's Manual of the navigation system.*

Auxiliary Device (Optional)

Operating Auxiliary Devices (Optional)

To operate your devices connected to the AUX terminals on the rear panel of IVA-D310, follow the procedure described below.

WARNING

It is dangerous (and illegal in many states) for the driver to watch the TV/Video while driving the vehicle. The driver may be distracted from looking ahead and an accident could occur.

Install the IVA-D310 correctly so that the driver cannot watch TV/Video unless the vehicle is stopped and the emergency brake is applied.

If the IVA-D310 is not installed correctly, the driver will be able to watch the TV/Video while driving the vehicle and may be distracted from looking ahead and cause an accident. The driver or other people could be severely injured.

To activate your auxiliary devices:

To watch a video source, your vehicle must be parked with the ignition key in the ACC or ON position. To do this, follow the procedure below.

- 1 Bring your vehicle to a complete stop at a safe location. Engage the parking brake.
- 2 Keep pushing the foot brake and release the parking brake once then engage it again.
- 3 When the parking brake is engaged for the second time, release the foot brake.

- For automatic transmission vehicles, place the transmission lever in the Park position.

Now, the locking system for the AUX mode operation has been released. Engaging the parking brake can reactivate the AUX mode, as long as the car's ignition has not been turned off. It is not necessary to repeat the above procedure (1 through 3), of "To activate your auxiliary devices." Each time the ignition is turned OFF, perform the procedure of "To activate your auxiliary devices."

- If you try to activate the auxiliary device while driving, the display will show the warning-**PICTURE OFF FOR YOUR SAFETY**.

1 Touch [SOURCE] on the main source screen.

The source screen appears on the display.

2 Touch [AUX]*.

The external input screen is displayed.

* AUX-1 to AUX-3 are displayed if the external input devices (maximal 3) are connected, or the name which is given as the source name in "Naming External Devices" on page 34 is displayed.

- If the AUX mode is not displayed on the main menu, set AUX IN to ON by following "Setting the AUX Mode" (page 34).
- The display mode changes by touching [WIDE].
For operation, refer to "Switching Display Modes" on page 25.

Changer (Optional)

Controlling CD Changer (Optional)

An optional 6-disc or 12-disc CD Changer may be connected to the IVA-D310 if it is Ai-NET compatible. With a CD Changer connected to the Ai-NET input of the IVA-D310, the CD Changer will be controllable from the IVA-D310.

If you connect a changer compatible with MP3, you can play CD-ROMs, CD-Rs, and CD-RWs containing MP3 files on the IVA-D310.

Using the KCA-410C (Versatile Link Terminal) multiple changers can be controlled by the IVA-D310.

See the Multi-Changer Selection section for selecting the CD Changers (explained on page 55).

1 Touch [SOURCE] on the main source screen.

2 Touch [CD CHG].

The display changes to the CD changer mode screen.

When a 6 Disc CD Changer is connected;

- 1 Touch [P1/2]*.

The Function Guide display appears.

* When an MP3 compatible CD changer or DVD changer is connected, touch repeatedly until the disc number is displayed.

- 2 Touch any one of the select buttons [DISC 1] through [DISC 6].

DISC 1 through DISC 6 select the discs from the first disc to 6th disc.

When an MP3 compatible CD changer is connected;

- 1 Touch [P1/3] twice to change the Function Guide display.
- 2 Touch any one of the select buttons [DISC 1] through [DISC 6].

DISC 1 through DISC 6 select the discs from the first disc to 6th disc.

When a 12-Disc CD Changer is connected;

You can select the disc numbers 1 to 6 in the same manner as for 6-disc Changer.

Touch [P1/3] twice to select disc numbers 7 to 12.

The function guide display changes so that DISC 7 through DISC 12 represent disc numbers 7 to 12.

- After selecting the desired disc, you can operate in the same way as for the CD player. For details, see the CD/MP3/WMA section.
- When an MP3 compatible CD changer is connected, the unit can play discs containing both audio data and MP3 data.
- The DVD changer (optional) is controllable from the IVA-D310 as well as the CD changer.

Multi-Changer Selection (Optional)

When using KCA-410C (Versatile Link Terminal), you can connect two changers.

- 1** In changer mode, touch **[CHG SEL]** or press **BAND** on the unit to select the next changer (connected CD changers only) .
 - 2** To operate the selected changer, see “CD/MP3/WMA” section.
- To operate the selected changer, see “CD/MP3/WMA” (pages 15 and 18).

HDD Player Operation (Optional)

Listening to Music of HDD

This device is controllable from the unit when Alpine HDD player is connected.

- 1** Touch **[SOURCE]** on the main source screen.
The source selection screen appears.
- 2** Touch **[MM DRIVER]**.
The MM DRIVER mode main screen appears.
- 3** Select the desired music by touching **[◀◀]** or **[▶▶]**.
Searching: Touch **[◀◀]** or **[▶▶]**.
Fast-forward/reverse: Touch and hold **[◀◀]** or **[▶▶]**.
- 4** Touch **[▶ / ||]** to temporarily stop the music currently playing.
Touch **[▶ / ||]** again to resume the play.

SAT Radio Receiver (Optional)

SAT Receiver: XM or SIRIUS Receiver

When an optional XM or SIRIUS Receiver Box is connected via the Ai-NET bus, the following operations may be performed. However, the XM Receiver and SIRIUS Receiver cannot be connected at the same time.

Receiving Channels with the SAT Receiver (Optional)

About SAT Radio

Satellite Radio* is the next generation of audio entertainment, with over to 100 digital channels. For a small monthly fee, subscribers can hear crystal-clear music, sports, news and talk, coast-to-coast via satellite. For more information, visit XM's website at www.xmradio.com, and SIRIUS' website at www.sirius.com.

To receive SAT Radio, the separately sold XMDirect™ or SIRIUS Satellite Radio Tuner and an appropriate Ai-Net Interface Adapter will be required. For details, consult you nearest ALPINE dealer.

- * XM and its corresponding logos are trademarks of XM Satellite Radio Inc.
- * SIRIUS and its corresponding logos are trademarks of SIRIUS Satellite Radio Inc.

- The SAT Receiver controls on the IVA-D310 are operative only when a SAT Receiver is connected.

1 Touch [SOURCE] on the main source screen.
The source selection screen is displayed.

2 Touch [XM] or [SIRIUS].
The XM or SIRIUS main screen display appears.

3 Touch [BAND] to select the desired band.

XM radio:

XM-1 → XM-2 → XM-3 → XM-1

SIRIUS radio:

SIRIUS-1 → SIRIUS-2 → SIRIUS-3 → SIRIUS-1

4 Touch [NO./NAME] to select the channel number tuning.
Each time it is pressed, the tuning mode is changed.
channel number tuning ↔ channel name tuning

5 Touch [◀ CH NO.] / [CH NO. ▶] or [◀ CH NAME] or [CH NAME ▶] to select the desired channel.
Holding either button down will change channels continuously.

Tuning in to Categorized Programs

You can listen to programs categorized to the same group one after another.

In the XM or SIRIUS mode, touch [◀ CAT DN] or [CAT UP ▶] to select a desired category.

The first channel of the selected category is tuned.

- If the desired category program is not found, the selected category is displayed for 5 seconds, then the receiving program is restored.

Changing the Display

Text information, such as the channel name, artist name/feature, and song/program title, is available with each XM or SIRIUS channel. The unit can display this text information as explained below.

Touch [INFO.] on the XM or SIRIUS mode main screen.
Each time you touch this button, the display changes as shown below.

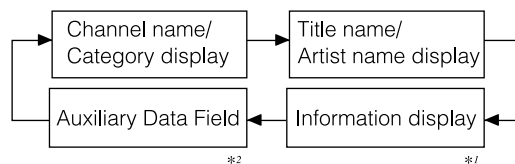

*1 Channel number, category, title name, etc., are displayed in one screen.

*2 XM mode only: The information display appears when ON is set in "Setting the Auxiliary Data Field Display" (page 32).

- Auxiliary Data Field is not displayed in the dual screen.

Checking the SAT Radio ID Number

A unique Radio ID number is required to subscribe to SAT Radio programming. Each third party XM or SIRIUS radio comes with this number.

XM Radio:

This number is an 8 character alphanumeric number. It is printed on a label found on the SAT Receiver.

SIRIUS Radio:

This number is a 12 character alphanumeric number. It is printed on a label found on the SAT Receiver.

It can also be displayed on the screen of the IVA-D310 in the following way.

1 While receiving SAT Radio, touch [◀ CH NO.] or [CH NO. ▶] to select channel '0.'

2 The unit displays the ID number.

3 To cancel the ID number display, change the channel.

- You cannot use "O," "S," "I," or "F" for the ID Number. (XM radio Receiver only)
- You can check the ID number printed on a label on your third party, SAT Radio Receiver package.

Storing Channel Presets

- 1 Touch **[P1/3]** after selecting a desired band.
The Function Guide is switched.
- 2 Touch **[MEMORY]**.
- 3 Touch any one of the preset buttons **[P.SET 1]** through **[P.SET 6]** within 5 seconds into which you want to store the channel. The selected channel is stored.
- 4 Repeat the procedure to store up to 5 other channels onto the same band.

To use this procedure for other bands, simply select the desired band and repeat the procedure.

A total of 18 channels can be stored in the preset memory (6 channels for each band; XM1, XM2 and XM3 or SIRIUS1, SIRIUS2 and SIRIUS3).

- If you store a channel in a preset already being used, the current channel will be replaced with the new one.

Receiving Stored Channels

- 1 Touch **[P1/3]** after selecting a desired band.
The Function Guide is switched.
- 2 Touch any one of the preset buttons **[P.SET 1]** through **[P.SET 6]** that has your desired satellite channel in memory.

Displaying the Category/Channel Name Title List

- 1 In XM or SIRIUS mode, touch **[□]**.
The category title list is displayed.

Screen example for category search list



- 1 The list scrolls one paragraph at a time by touching **[▲]** or **[▼]**.
- 2 Touch **[▶]** to receive the selected category channel directly.

- 3 **[>>]** is displayed if there is a hierarchical list.
Touch **[>>]** to change the channel name search screen of the selected category.
- 4 Category UP/DOWN can directly be performed.
- 5 The list scrolls forwards or backwards by touching the slide switch and moving it up or down.

Screen example for channel name search list

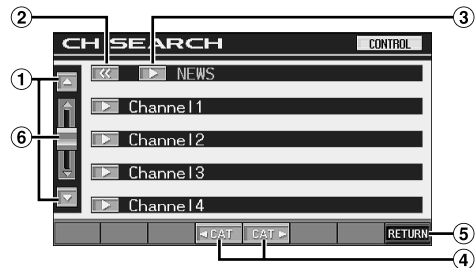

- 1 The list scrolls one paragraph at a time by touching **[▲]** or **[▼]**.
 - 2 Returns to the category search list.
 - 3 The selected channel is received.
 - 4 Changes the category
 - 5 The selected category on the channel name search screen is displayed at the top of the search list screen.
 - 6 The list scrolls forwards or backwards by touching the slide switch and moving it up or down.
- 2 Touch **[▶]** of the selected Category or Channel name.
The channel in the selected category is tuned.

Selecting the Channel directly

You can directly select the channel number on the display of the numeric keypad.

- 1 Touch **[P1/3]** twice in the XM or SIRIUS mode.
The function guide appears.
- 2 Touch **[10KEY]**.
The numeric keypad input screen is displayed.
- 3 Touch to input the channel number.
- 4 Touch **[ENT]**.
The selected channel is received.

iPod™ (Optional)

An iPod™ or iPod™ mini can be controlled from the IVA-D310, when connected to an optional Alpine Interface Adapter for iPod™ (KCA-420i). While connected to the IVA-D310, operation from the iPod™ is no longer possible.

- For details, refer to the Owner's Manual of the connected adapter (KCA-420i).
- For each function, refer to the iPod's documentation.

Playback

1 Touch [SOURCE] on the main source screen.
The source selection screen is displayed.

2 Touch [iPod].
The display shows the iPod mode screen.

3 Touch [◀◀] or [▶▶] to select the desired song.

Return to the beginning of the current song:

Touch [◀◀].

Fast backward:

Touch and hold [◀◀].

Advance to the beginning of the next song:

Touch [▶▶].

Fast forward:

Touch and hold [▶▶].

4 To pause playback, touch [▶/||].
Touching [▶/||] again will resume playback.

- If a song is playing on the iPod when it is connected to the IVA-D310, it will continue playing after the connection.
- If using the iPod with a changer, the Versatile Link Terminal (KCA-410C) must be used. In this case, touch [CHG SEL] on the iPod mode main screen to select the changer mode applicable to the iPod.
- Only ISO8859-1 can be displayed.
- If the artist, album or song name, created in iTunes, has too many characters, songs may not be played back when connected to the adapter. Therefore, a maximum of 250 characters is recommended. The maximum number of characters for the head unit is 64 (64 byte).
- Some characters may not be correctly displayed.
- "NO SUPPORT" is displayed when text information is not compatible with the IVA-D310.

Searching for a desired Song

An iPod can contain hundreds to thousands of songs. By keeping these songs organized in smaller playlists, the IVA-D310 has the ability to ease song searches.

- The maximum number of playlists, artists or albums that can be searched is 511. The maximum number of searches for a song is 255.

Searching by Playlist

1 Touch [🔍].
The search mode is activated, and the search list screen appears.

2 Touch [➤] of PLAYLIST SEARCH.
The PLAYLIST search screen is displayed.

3 Select the desired playlist.

To play back the playlist directly

- 1 Touch [▶] next to the playlist.
The selected playlist is played back repeatedly.

To search for a song in the playlist

- 1 Touch [➤] of the selected playlist.
The SONG search screen of the selected playlist is displayed.
- 2 Touch [▶] next to the desired song.
The selected song is played back.

Searching by artist name

1 Touch [🔍].
The search mode is activated, and the search list screen appears.

2 Touch [➤] of ARTIST SEARCH.
The ARTIST search screen is displayed.

3 Select the desired artist.

To play back the artist directly

- 1 Touch [▶] next to the artist's name.
Songs by the selected artist are played back.

- Touching [▶] of ALL will play back from the beginning of all songs.
- Touching [➤] of ALL will change the ALBUM search screen.

To search for the album of an artist

- 1 Touch [➤] of the selected artist.
The ALBUM search screen of the selected artist is displayed.
- 2 Touch [▶] next to the desired album's name.
Songs in the selected album are played back.

- Touching [▶] of ALL will play back the first song of the selected artist.
- Touching [➤] of ALL will change the SONG search screen of the selected artist.

To search for a song in the album of an artist

- 1 Touch [➤] of the desired album in "To search for the album of an artist" in step 2.
The SONG search screen of the selected album is displayed.
- 2 Touch [▶] next to the desired song's name.
The selected song is played back.

Searching by album name

1 Touch [🔍].
The search mode is activated, and the search list screen appears.

2 Touch [➤] of ALBUM SEARCH.
The ALBUM search screen is displayed.

3 Select the desired album name.

To play back the album directly

- 1 Touch [▶] next to the album's name.
Songs in the selected album are played back.
- Touching [▶] of ALL will play back from the beginning of all songs.
 - Touching [≫] of ALL will change the SONG search screen.

To search for a song in an album

- 1 Touch [≫] of the selected album name.
The SONG search screen of the selected album is displayed.
- 2 Touch [▶] next to the desired song's name.
The selected song is played back.

Random Play Shuffle (M.I.X.)

The Shuffle function of the iPod is displayed as M.I.X. on the IVA-D310.

Shuffle Albums:

Select an album randomly in the iPod, and plays back the songs of the album in sequential order. If a song has been selected in the playlist/artist search mode before selecting Shuffle Album, only the albums within the playlist/artist are selected randomly. The songs of the album are played back sequentially.

Shuffle Songs:

All songs in the iPod are played back in random sequence. If a song has been selected in the playlist/artist search mode before selecting Shuffle song, only the songs of the playlist/artist/album are played back randomly.

1 Touch [∞].

The songs will be played back in random sequence.

→ M.I.X. ALBUMS → M.I.X. SONGS → (off)
(Shuffle Albums) (Shuffle Songs)

2 To cancel M.I.X. play, touch [∞].

- For details of the search mode, refer to "Searching for a desired Song" (page 58).
- If a song is selected in the album search mode before selecting Shuffle (M.I.X.), the songs will not play back randomly even when Shuffle album is selected.
- If there is no album in the playlist, Shuffle (M.I.X.) will not function even when Shuffle album is selected.
- The M.I.X. mode is canceled when iPod or iPod mini is removed or the ignition key is turned off.

Repeat Play

Only Repeat One is available for the iPod.

Repeat One: A single song is repeatedly played back.

1 Touch [↺].

The file will be played repeatedly.

RPT ↔ (off)
(Repeat One) (Repeat the list being played back)

2 To cancel repeat play, touch [↺].

- During repeat playback, no other songs are selectable by touching [◀◀] or [▶▶].
- The repeat mode is canceled when iPod or iPod mini is removed or the ignition key is turned off.

About Subdisplay Indications

About Subdisplay Indications

Indication example in the CD mode

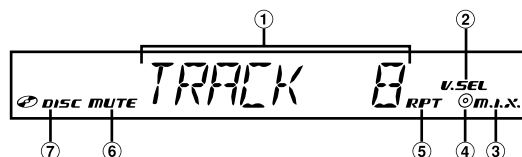

- ① Indicates the track number
- ② Lights up when the simultaneous function is on
- ③ Lights up when M.I.X. is active
- ④ Lights up when M.I.X. ALL/RPT DISC is on (only when the changer M.I.X. ALL or RPT DISC mode is on)
- ⑤ Lights up when RPT is active
- ⑥ Lights up when MUTE is on
- ⑦ Lights up when a disc is inserted

- After displaying the track number, while playing back a disc compatible with CD text, the track text is displayed (up to 8 digits).

Indication example in the MP3/WMA mode

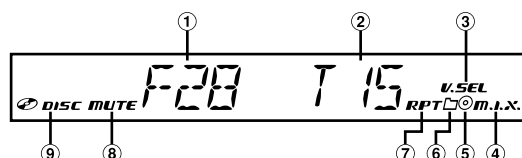

- ① Indicates the folder number
- ② Indicates the file number
- ③ Lights up when the simultaneous function is on
- ④ Lights up when M.I.X. is active
- ⑤ Lights up when RPT DISC is on (changer mode only)
- ⑥ Lights up when M.I.X. /RPT folder is selected
- ⑦ Lights up when RPT is active
- ⑧ Lights up when MUTE is on
- ⑨ Lights up when a disc is inserted

- After displaying the folder or file number, if there is tag information, the song name is displayed (up to 8 digits).

Indication example in the DVD mode

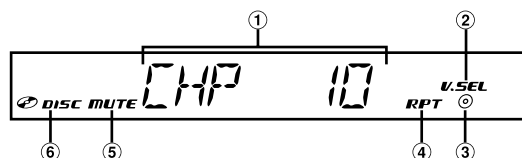

- ① Indicates the chapter number
- ② Lights up when the simultaneous function is on
- ③ Lights up when RPT title is on
- ④ Lights up when RPT chapter is active
- ⑤ Lights up when MUTE is on
- ⑥ Lights up when a disc is inserted

Indication example in the Video CD mode

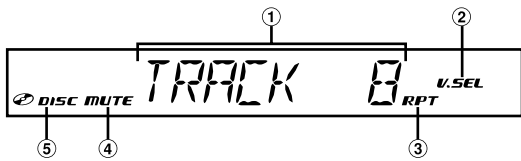

- ① Indicates the track number
- ② Lights up when the simultaneous function is on
- ③ Lights up when RPT is active
- ④ Lights up when MUTE is on
- ⑤ Lights up when a disc is inserted

• When PBC is turned on, "PBC ON" is displayed.

Indication example in the FM radio mode

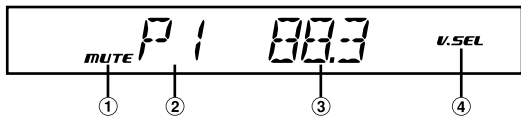

- ① Lights up when MUTE is on
- ② Indicates preset number for 2 seconds
- ③ Indicates the selected frequency
- ④ Lights up when the simultaneous function is on

• Song information, etc., may not be correctly displayed.
 • The display may differ depending on the connected device(s).

Remote Control

Controls on Remote Control

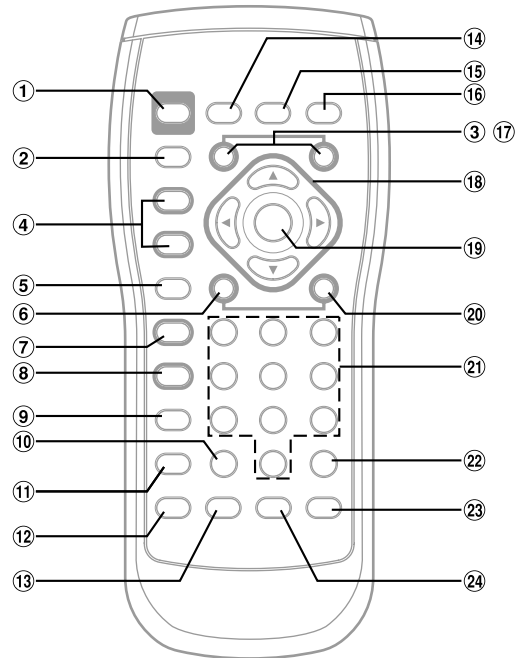

- ① **PWR button**
Turns the power ON and OFF.
- ② **SRC Button**
Selects the audio source.
- ③ **DN Button**
Radio mode: Selects, in descending order, stations programmed into the radio's presets.
MP3/WMA mode:
Folder Select (DN) Button selects the folder.
Changer mode:
DISC Select (DN) Button selects a disc in descending order.
- ④ **VOLUME ▲ / ▼ Button**
Increase or decreases the volume level.
- ⑤ **RETURN Button**
DVD/Video CD (PBC ON) mode: Returns to the previous display. (Does not return in some discs.)
- ⑥ **◀◀ button**
Radio mode: SEEK (DN) button
CD /Changer mode:
Press the button to go back to the beginning of the current track. Press and hold to fast reverse.
MP3/WMA mode:
Press the button to go back to the beginning of the current file. Press and hold to fast reverse.

- DVD/Video CD:
- Move to the desired position on the disc.
 - During playback, press and hold for more than 1 second to reverse the disc at double speed. Hold for more than 5 seconds to reverse the disc at 8 times the normal speed.
- DVD mode:
- When pressed and held in while in the pause mode, the disc is played in reverse slow motion at 1/8th the normal speed. When held in for 5 more seconds, the reverse slow motion speed switches to 1/2 the normal speed.
 - The picture is reversed by one frame each time the button is pressed in the pause mode.
- 7 **▶/|| Button**
- Radio mode: Chooses the tuning mode. By pressing it more than 2 seconds, Automatic Memory will be operated.
- Disc mode: Switches between play and pause.
- *SEARCH Button: Not used.*
- 8 **■ button**
- Performs stop.
- DVD/Video CD:
- Pressing once stops the PRE stop; Pressing twice sets stop.
- 9 **MENU Button**
- DVD mode: Shows the menu display.
- Video CD mode:
- Turns PBC ON or OFF. (for Video CD with PBC functions)
- 10 **CLR Button**
- Removes numbers (one character at a time) that have been selected and input.
- Press and hold for 2 seconds. All the characters which were selected and input are erased.
- 11 **DISP/TOP M. Button**
- DVD/Video CD mode:
- Shows playback status.
- DVD mode: By pressing more than 2 seconds, shows the top menu display.
- 12 **SETUP Button**
- Not used.
- 13 **AUDIO Button**
- DVD/Video CD mode: Switches audio.
- 14 **BAND Button**
- Radio mode: Changes the band.
- Changer mode:
- Switches the disc mode. (when an optional KCA-410C is connected)
- 15 **A.PROC Button**
- Press the button to call the Bass engine setting screen.
- 16 **MUTE Button**
- Lowers the volume by 20 dB instantly. Press the button again to cancel.
- By pressing the button for more than 2 seconds, the monitor opens or closes.
- 17 **UP Button**
- Radio mode: Selects, in ascending order, stations programmed into the radio's presets.
- MP3/WMA mode:
- Folder Select (UP) Button to selects the folder.
- Changer mode:
- DISC Select (UP) Button selects a disc in ascending order.
- 18 **▲, ▼, ◀, ▶**
- DVD mode: Selects an item displayed in the screen.
- 19 **ENT. Button**
- Enters the selected item.
- 20 **▶▶ button**
- Radio mode: SEEK (UP) button
- CD/Changer mode:
- Press the button to advance to the beginning of the next track. Press and hold to fast forward.
- MP3/WMA mode:
- Press the button to advance to the beginning of the next file. Press and hold to fast forward.
- DVD/Video CD:
- Move to the desired position on the disc.
 - During playback, press and hold for more than 1 second to forward the disc at double speed. Hold for more than 5 seconds to forward the disc at 8 times the normal speed.
 - When pressed and held in while in the pause mode, the disc is played in slow motion at 1/8th the normal speed. When held in for 5 more seconds, the slow motion speed switches to 1/2 the normal speed.
 - The picture is forwarded by one frame each time the button is pressed in the pause mode.
- 21 **Numeric Keypad**
- Inputs numbers.
- 22 **MONITOR Button**
- Not used.
- 23 **ANGLE Button**
- DVD mode: Switches the angle of the picture.
- 24 **SUBTITLE button**
- DVD mode: Switches the subtitle.
- *The SETUP operation of the unit cannot be carried out from the remote control.*
 - *Some operations may not be possible depending on the disc.*

When Using the Remote Control

- **Point the remote control at the remote sensor within about 2 meters.**
- **It may not be possible to operate the remote control if the remote control sensor is exposed to direct sunlight.**
- **The remote control is a small, lightweight precision device. To avoid damage, short battery life, operational errors and poor response, observe the following.**
 - **Do not subject the remote control to excessive shock.**
 - **Do not put in a trouser pocket.**
 - **Keep away from food, moisture and dirt.**
 - **Do not place in direct sunshine.**

Battery Replacement

Battery type: CR2025 battery or equivalent.

1 Opening the battery case

Slide out the battery cover while firmly pressing in the direction of the arrow.

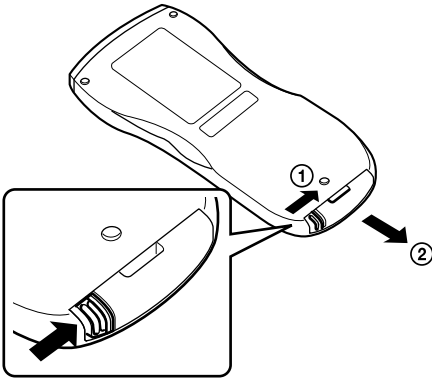

2 Replacing the battery

Put the battery in the case with the (+) indication upward as shown in the illustration.

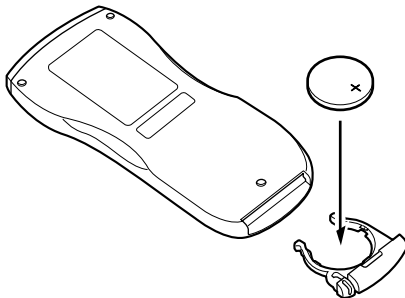

- Placing a battery in backwards way may cause a malfunction.

3 Closing the cover

Slide the cover as illustrated until a click is heard.

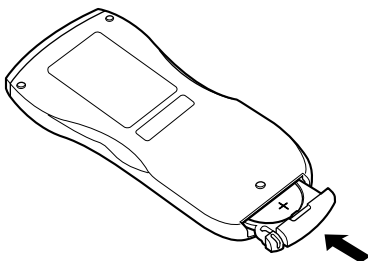

Warning

DO NOT OPERATE ANY FUNCTION THAT TAKES YOUR ATTENTION AWAY FROM SAFELY DRIVING YOUR VEHICLE.

Any function that requires your prolonged attention should only be performed after coming to a complete stop. Always stop the vehicle in a safe location before performing these functions. Failure to do so may result in an accident.

Information

About DVDs

Music CDs and DVDs have grooves (tracks) in which the digital data is recorded. The data is represented as microscopic pits recorded into the track – these pits are read by a laser beam to play the disc. On DVDs, the density of the tracks and pits is twice that of CDs, so DVDs can contain more data in less space.

CDs

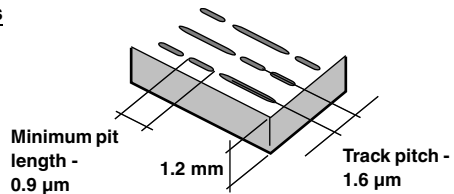

DVDs

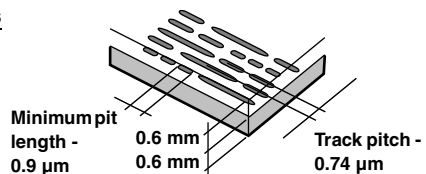

A 12 cm disc can contain one movie or about four hours of music.

In addition, DVDs provide sharp picture quality with vivid colors thanks to a horizontal resolution of over 500 lines (compared to less than 300 for VHS tape). With the addition of an optional, digital audio processor (PXA-H900/PXA-H510/PXA-H700, etc.), you can recreate the power and presence of a movie theater with Dolby Digital 5.1-channel Surround.

In addition, DVDs offer a variety of functions.

Multiple audio* (page 22)

Movies can be recorded in up to eight languages. The desired language can be selected from the unit.

Subtitles function* (page 22)

Movies can include subtitles in up to 32 languages. The desired subtitle language can be selected from the unit.

Multi angle function* (page 22)

When the DVD contains a movie shot from multiple angles, the desired angle can be selected from the unit.

Multi story function*

With this function, a single movie includes various story lines. You can select different story lines to view various versions of the same movie.

Operation differs from disc to disc. Story line selection screens including instructions appear during the movie. Just follow the instructions.

* The functions audio languages, subtitle languages, angles, etc., differ from disc to disc. For details, refer to the disc's instructions.

Terminology

Dolby Digital

Dolby Digital is a digital audio compression technology developed by Dolby Laboratories that allows large quantities of audio data to be efficiently recorded on discs. It is compatible with audio signals from mono (1 channel) all the way up to 5.1-channel surround sound. The signals for the different channels are completely independent, and since the sound is high quality digital there is no loss of sound quality.

* *The separately sold digital audio processor (PXA-H510/PXA-H900/PXA-H700, etc.) is required to enjoy full 5.1-channel surround sound.*

The IVA-D310 performs Dolby Digital decoding when it outputs analog audio signals, it just happens to be 2-channel audio not 5.1-channel.

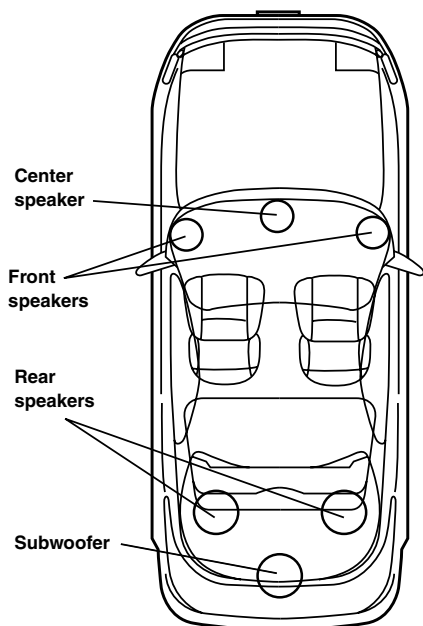

**Speaker layout for enjoying
Dolby Digital sound/dts sound**

DTS

This is a home-use digital sound format of the DTS Sound System. This is a high quality sound system, developed by Digital Theater Systems, Inc. for use in movie theaters. DTS has six independent sound tracks. The theater presentation is fully realized in the home and other settings. DTS is the abbreviation for Digital Theater System.

* *To enjoy DTS surround sound you need the separately sold DTS digital audio processor (PXA-H900/PXA-H700, etc.). The DVD video software must also have a DTS sound track.*

The IVA-D310 has a built-in DTS 2-channel audio decoder. Analog audio outputs are available.

Dolby Pro Logic

Dolby Pro Logic is the technology used to decode programs encoded in Dolby Surround. Pro logic decoding will provide you with four channels of sound (front left/right, center and monaural rear surround) from a 2-channel (stereo) source.

* *The separately sold digital audio processor (PXA-H510/PXA-H900) is required to enjoy Dolby Pro Logic surround sound.*

Dolby Pro Logic II

Dolby Pro Logic II plays 2-channel sources in 5 channels over the entire frequency range.

This is done with an advance, high sound quality matrix surround decoder which draws out the spatial properties of the original recording without adding any sounds to or changing the sound of the source.

* *The separately sold digital audio processor (PXA-H700, etc.) is required to enjoy Dolby Pro Logic II surround sound.*

Linear PCM audio (LPCM)

LPCM is a signal recording format used for music CDs. Whereas music CDs are recorded at 44.1 kHz/16 bits, DVDs are recorded at 48 kHz/16 bits to 96 kHz/24 bits, thereby achieving higher sound quality than music CDs.

Rating levels (parental lock)

This is a function of the DVD for restricting the viewing age as stipulated by laws in different countries. The way in which viewing is restricted differs from DVD to DVD. Sometimes the DVD cannot be played at all, other times certain scenes are skipped, and other times certain scenes are replaced with other scenes.

List of Language Codes

(For details, see page 28.)

Abbreviation	Code	Language	Abbreviation	Code	Language	Abbreviation	Code	Language
AA	6565	Afar	IE	7369	Interlingue	RN	8278	Kirundi
AB	6566	Abkhazian	IK	7375	Inupiak	RO	8279	Romanian
AF	6570	Afrikaans	IN	7378	Indonesian	RU	8285	Russian
AM	6577	Amharic	IS	7383	Icelandic	RW	8287	Kinyarwanda
AR	6582	Arabic	IT	7384	Italian	SA	8365	Sanskrit
AS	6583	Assamese	IW	7387	Hebrew	SD	8368	Sindhi
AY	6589	Aymara	JA	7465	Japanese	SG	8371	Sangho
AZ	6590	Azerbaijani	JI	7473	Yiddish	SH	8372	Serbo-Croatian
BA	6665	Bashkir	JW	7487	Javanese	SI	8373	Singhalese
BE	6669	Byelorussian	KA	7565	Georgian	SK	8375	Slovak
BG	6671	Bulgarian	KK	7575	Kazakh	SL	8376	Slovenian
BH	6672	Bihari	KL	7576	Greenlandic	SM	8377	Samoan
BI	6673	Bislama	KM	7577	Cambodian	SN	8378	Shona
BN	6678	Bengali, Bangla	KN	7578	Kannada	SO	8379	Somali
BO	6679	Tibetan	KO	7579	Korean	SQ	8381	Albanian
BR	6682	Breton	KS	7583	Kashmiri	SR	8382	Serbian
CA	6765	Catalan	KU	7585	Kurdish	SS	8383	Siswati
CO	6779	Corsican	KY	7589	Kirghiz	ST	8384	Sesotho
CS	6783	Czech	LA	7665	Latin	SU	8385	Sundanese
CY	6789	Welsh	LN	7678	Lingala	SV	8386	Swedish
DA	6865	Danish	LO	7679	Laothian	SW	8387	Swahili
DE	6869	German	LT	7684	Lithuanian	TA	8465	Tamil
DZ	6890	Bhutani	LV	7686	Latvian, Lettish	TE	8469	Telugu
EL	6976	Greek	MG	7771	Malagasy	TG	8471	Tajik
EN	6978	English	MI	7773	Maori	TH	8472	Thai
EO	6979	Esperanto	MK	7775	Macedonian	TI	8473	Tigrinya
ES	6983	Spanish	ML	7776	Malayalam	TK	8475	Turkmen
ET	6984	Estonian	MN	7778	Mongolian	TL	8476	Tagalog
EU	6985	Basque	MO	7779	Moldavian	TN	8478	Setswana
FA	7065	Persian	MR	7782	Marathi	TO	8479	Tonga
FI	7073	Finnish	MS	7783	Malay	TR	8482	Turkish
FJ	7074	Fiji	MT	7784	Maltese	TS	8483	Tsonga
FO	7079	Faroese	MY	7789	Burmese	TT	8484	Tatar
FR	7082	French	NA	7865	Nauru	TW	8487	Twi
FY	7089	Frisian	NE	7869	Nepali	UK	8575	Ukrainian
GA	7165	Irish	NL	7876	Dutch	UR	8582	Urdu
GD	7168	Scots Gaelic	NO	7879	Norwegian	UZ	8590	Uzbek
GL	7176	Galician	OC	7967	Occitan	VI	8673	Vietnamese
GN	7178	Guarani	OM	7977	(Afan) Oromo	VO	8679	Volapuk
GU	7185	Gujarati	OR	7982	Oriya	WO	8779	Wolof
HA	7265	Hausa	PA	8065	Punjabi	XH	8872	Xhosa
HI	7273	Hindi	PL	8076	Polish	YO	8979	Yoruba
HR	7282	Croatian	PS	8083	Pashto, Pushto	ZH	9072	Chinese
HU	7285	Hungarian	PT	8084	Portuguese	ZU	9085	Zulu
HY	7289	Armenian	QU	8185	Quechua			
IA	7365	Interlingua	RM	8277	Rhaeto-Romance			

List of Country Codes

(For details, see page 28.)

Abbreviation	Code	Country	Abbreviation	Code	Country	Abbreviation	Code	Country
AD	6568	Andorra	CK	6775	Cook Islands	GR	7182	Greece
AE	6569	United Arab Emirates	CL	6776	Chile	GS	7183	South Georgia and the South Sandwich Islands
AF	6570	Afghanistan	CM	6777	Cameroon	GT	7184	Guatemala
AG	6571	Antigua and Barbuda	CN	6778	China	GU	7185	Guam
AI	6573	Anguilla	CO	6779	Colombia	GW	7187	Guinea-Bissau
AL	6576	Albania	CR	6782	Costa Rica	GY	7189	Guyana
AM	6577	Armenia	CU	6785	Cuba	HK	7275	Hong Kong
AN	6578	Netherlands Antilles	CV	6786	Cape Verde	HM	7277	Heard Island and McDonald Islands
AO	6579	Angola	CX	6788	Christmas Island	HN	7278	Honduras
AQ	6581	Antarctica	CY	6789	Cyprus	HR	7282	Croatia
AR	6582	Argentina	CZ	6790	Czech Republic	HT	7284	Haiti
AS	6583	American Samoa	DE	6869	Germany	HU	7285	Hungary
AT	6584	Austria	DJ	6874	Djibouti	ID	7368	Indonesia
AU	6585	Australia	DK	6875	Denmark	IE	7369	Ireland
AW	6587	Aruba	DM	6877	Dominica	IL	7376	Israel
AZ	6590	Azerbaijan	DO	6879	Dominican Republic	IN	7378	India
BA	6665	Bosnia and Herzegovina	DZ	6890	Algeria	IO	7379	British Indian Ocean Territory
BB	6666	Barbados	EC	6967	Ecuador	IQ	7381	Iraq
BD	6668	Bangladesh	EE	6969	Estonia	IR	7382	Iran, Islamic Republic of
BE	6669	Belgium	EG	6971	Egypt	IS	7383	Iceland
BF	6670	Burkina Faso	EH	6972	Western Sahara	IT	7384	Italy
BG	6671	Bulgaria	ER	6982	Eritrea	JM	7477	Jamaica
BH	6672	Bahrain	ES	6983	Spain	JO	7479	Jordan
BI	6673	Burundi	ET	6984	Ethiopia	JP	7480	Japan
BJ	6674	Benin	FI	7073	Finland	KE	7569	Kenya
BM	6677	Bermuda	FJ	7074	Fiji	KG	7571	Kyrgyzstan
BN	6678	Brunei Darussalam	FK	7075	Falkland Islands	KH	7572	Cambodia
BO	6679	Bolivia	FM	7077	Micronesia, Federated States of	KI	7573	Kiribati
BR	6682	Brazil	FO	7079	Faroe Islands	KM	7577	Comoros
BS	6683	Bahamas	FR	7082	France	KN	7578	Saint Kitts and Nevis
BT	6684	Bhutan	GA	7165	Gabon	KP	7580	Korea, Democratic People's Republic of
BV	6686	Bouvet Island	GB	7166	United Kingdom	KR	7582	Korea, Republic of
BW	6687	Botswana	GD	7168	Grenada	KW	7587	Kuwait
BY	6689	Belarus	GE	7169	Georgia	KY	7589	Cayman Islands
BZ	6690	Belize	GF	7170	French Guiana	KZ	7590	Kazakstan
CA	6765	Canada	GH	7172	Ghana	LA	7665	Lao People's Democratic Republic
CC	6767	Cocos (Keeling) Islands	GI	7173	Gibraltar	LB	7666	Lebanon
CD	6768	Congo, the Democratic Republic of the	GL	7176	Greenland	LC	7667	Saint Lucia
CF	6770	Central African Republic	GM	7177	Gambia	LI	7673	Liechtenstein
CG	6771	Congo	GN	7178	Guinea	LK	7675	Sri Lanka
CH	6772	Switzerland	GP	7180	Guadeloupe	LR	7682	Liberia
CI	6773	Cote d'Ivoire	GQ	7181	Equatorial Guinea	LS	7683	Lesotho

Abbreviation	Code	Country	Abbreviation	Code	Country	Abbreviation	Code	Country
LT	7684	Lithuania	PA	8065	Panama	TD	8468	Chad
LU	7685	Luxembourg	PE	8069	Peru	TF	8470	French Southern Territories
LV	7686	Latvia	PF	8070	French Polynesia	TG	8471	Togo
LY	7689	Libyan Arab Jamahiriya	PG	8071	Papua New Guinea	TH	8472	Thailand
MA	7765	Morocco	PH	8072	Philippines	TJ	8474	Tajikistan
MC	7767	Monaco	PK	8075	Pakistan	TK	8475	Tokelau
MD	7768	Moldova, Republic of	PL	8076	Poland	TM	8477	Turkmenistan
MG	7771	Madagascar	PM	8077	Saint Pierre and Miquelon	TN	8478	Tunisia
MH	7772	Marshall Islands	PN	8078	Pitcairn	TO	8479	Tonga
MK	7775	Macedonia, The former Yugoslav Republic of	PR	8082	Puerto Rico	TP	8480	East Timor
ML	7776	Mali	PT	8084	Portugal	TR	8482	Turkey
MM	7777	Myanmar	PW	8087	Palau	TT	8484	Trinidad and Tobago
MN	7778	Mongolia	PY	8089	Paraguay	TV	8486	Tuvalu
MO	7779	Macau	QA	8165	Qatar	TW	8487	Taiwan, Province of China
MP	7780	Northern Mariana Islands	RE	8269	Reunion	TZ	8490	Tanzania, United Republic of
MQ	7781	Martinique	RO	8279	Romania	UA	8565	Ukraine
MR	7782	Mauritania	RU	8285	Russian Federation	UG	8571	Uganda
MS	7783	Montserrat	RW	8287	Rwanda	UM	8577	United States Minor Outlying Islands
MT	7784	Malta	SA	8365	Saudi Arabia	US	8583	United States
MU	7785	Mauritius	SB	8366	Solomon Islands	UY	8589	Uruguay
MV	7786	Maldives	SC	8367	Seychelles	UZ	8590	Uzbekistan
MW	7787	Malawi	SD	8368	Sudan	VA	8665	Holy See (Vatican City State)
MX	7788	Mexico	SE	8369	Sweden	VC	8667	Saint Vincent and the Grenadines
MY	7789	Malaysia	SG	8371	Singapore	VE	8669	Venezuela
MZ	7790	Mozambique	SH	8372	Saint Helena	VG	8671	Virgin Island, British
NA	7865	Namibia	SI	8373	Slovenia	VI	8673	Virgin Islands, U.S
NC	7867	New Caledonia	SJ	8374	Svalbard and Jan Mayen	VN	8678	Viet Nam
NE	7869	Niger	SK	8375	Slovakia	VU	8685	Vanuatu
NF	7870	Norfolk Island	SL	8376	Sierra Leone	WF	8770	Wallis and Futuna
NG	7871	Nigeria	SM	8377	San Marino	WS	8783	Samoa
NI	7873	Nicaragua	SN	8378	Senegal	YE	8969	Yemen
NL	7876	Netherlands	SO	8379	Somalia	YT	8984	Mayotte
NO	7879	Norway	SR	8382	Suriname	YU	8985	Yugoslavia
NP	7880	Nepal	ST	8384	Sao Tome and Principe	ZA	9065	South Africa
NR	7882	Nauru	SV	8386	El Salvador	ZM	9077	Zambia
NU	7885	Niue	SY	8389	Syrian Arab Republic	ZW	9087	Zimbabwe
NZ	7890	New Zealand	SZ	8390	Swaziland			
OM	7977	Oman	TC	8467	Turks and Caicos Islands			

In Case of Difficulty

If you encounter a problem, please turn the power off, then on again. If the unit is still not functioning normally, please review the items in the following checklist. This guide will help you isolate the problem if the unit is at fault. Otherwise, make sure the rest of your system is properly connected, or then consult your authorized Alpine dealer.

Basic

No function or display.

- Vehicle's ignition is off.
 - If connected according to the instructions, the unit will not operate with the vehicle's ignition off.
- Improper power lead connections.
 - Check power lead connections.
- Blown fuse.
 - Check the fuse on the battery lead of the unit; replace with the proper value if necessary.
- Internal micro-computer malfunctioned due to interference noise, etc.
 - Press the RESET switch with a ballpoint pen or other pointed article.
- Blackout mode is activated.
 - Cancel Blackout mode.

No sound or unnatural sound.

- Incorrect setting of volume/balance/fader controls.
 - Readjust the controls.
- Connections are not properly or securely made.
 - Check the connections and firmly connect.

Screen not displayed.

- Brightness control is set at the minimum position.
 - Adjust the Brightness control.
- Temperature in the vehicle is too low.
 - Increase the vehicle's interior temperature to operation temperature range.
- Connections to the DVD, CD player, navigation system are not securely made.
 - Check the connections and firmly connect.

Movement of displayed picture is abnormal.

- Temperature in the vehicle is too high.
 - Allow the vehicle's interior temperature to cool.

Unclear or noisy display.

- Fluorescent plate is worn out.
 - Replace the fluorescent plate.

Navigation system inoperative.

- Connections to the navigation system are incorrect.
 - Check the connections with the navigation system and connect the cables correctly and firmly.

The remote control is inoperative.

- The remote control sensor setting of "Rear Entertainment Function" is not set to this unit.
 - Set for this unit.

Unclear picture display.

- Fluorescent tube is exhausted.
 - Replace the fluorescent tube*.

* The fluorescent tube replacement is not free of charge even within the warranty period, for the tube is an article of consumption.

Radio

Unable to receive stations.

- No antenna, or open connection in the antenna cable.
 - Make sure the antenna is properly connected; replace the antenna or cable if necessary.

Unable to tune stations in the seek mode.

- You are in a weak signal area.
 - Make sure the tuner is in DX mode.
- If the area you are in is a primary signal area, the antenna may not be grounded and connected properly.
 - Check your antenna connections; make sure the antenna is properly grounded at its mounting location.
- The antenna may not be the proper length.
 - Make sure the antenna is fully extended; if broken, replace the antenna with a new one.

Broadcast is noisy.

- The antenna is not the proper length.
 - Extend the antenna fully; replace it if it is broken.
- The antenna is poorly grounded.
 - Make sure the antenna is grounded properly at its mounting location.
- The station signal is weak and noisy.
 - If above solution does not work, tune in another station.

CD/MP3/WMA/DVD/Video CD

Disc playback sound is wavering.

- Moisture condensation in the disc Module.
 - Allow enough time for the condensation to evaporate (about 1 hour).

Disc insertion not possible.

- A disc is already in the DVD player.
 - Eject the disc and remove it.
- The disc is being improperly inserted.
 - Make sure the disc is being inserted following the instructions in the CD (MP3/WMA/DVD/Video CD) Player Operation section.

Unable to fast forward or backward the disc.

- The disc has been damaged.
 - Eject the disc and discard it; using a damaged disc in your unit can cause damage to the mechanism.

Disc playback sound skips due to vibration.

- Improper mounting of the unit.
 - Securely re-mount the unit.
- Disc is very dirty.
 - Clean the disc.
- Disc has scratches.
 - Change the disc.
- The pick-up lens is dirty.
 - Do not use a commercial available lens cleaner disc. Consult your nearest ALPINE dealer.

Disc playback sound skips without vibration.

- Dirty or scratched disc.
 - Clean the disc; damaged disc should be replaced.

CD-R/CD-RW playback not possible.

- Close session (finalization) has not been performed.
 - Perform finalization and attempt playback again.

Error displays

- Mechanical error
 - Press ▲. After the error indication disappears, insert the disc again. If the above-mentioned solution does not solve the problem, consult your nearest ALPINE dealer.

MP3/WMA is not played back.

- Writing error occurred. The CD format is not compatible.
 - Make sure the CD has been written in a supported format. Refer to "About MP3/WMA" (pages 17 and 18), then rewrite in the format supported by this device.

Unit does not operate.

- Monitor's power is not turned on.
 - Turn on the monitor's power.
- Condensation.
 - Wait a while (about 1 hour) for the condensation to dry.

No picture is produced.

- Monitor's mode is not switched to the mode you want to see.
 - Switch to the mode you want to see.
- Monitor's parking brake lead is not connected.
 - Connect the monitor's parking brake lead and set the parking brake.
(For details, refer to the monitor's instructions.)
- Monitor's parking brake is not set.
 - Connect the monitor's parking brake lead and set the parking brake.
(For details, refer to the monitor's instructions.)

Playback does not start.

- Disc is loaded upside-down.
 - Check the disc and load it with the labeled side facing upward.
- Disc is dirty.
 - Clean the disc.
- A disc not able to playback with this unit is loaded.
 - Check if the disc is able to be played back.
- Parental lock is set.
 - Cancel the parental lock or change the rating level.

Picture is unclear or noisy.

- Disc is being fast-forwarded or fast-reversed.
 - The picture may be slightly disturbed, but this is normal.
- Vehicle's battery power is weak.
 - Check the battery power and wiring.
(The unit may malfunction if the battery power is under 11 volts with a load applied.)
- Monitor's fluorescent tube is worn.
 - Replace the monitor's fluorescent tube.

Image stops sometimes.

- Disc is scratched.
 - Replaced with a non-scratched disc.

Indication for CD/MP3/WMA

HI-TEMP

- Protective circuit is activated due to high temperature.
 - The indicator will disappear when the temperature returns to within operation range.
 - Leave the power OFF until the temperature decreases and then turn the power ON again.

NO DISC

- No disc is inserted.
 - Insert a disc.
- Although a disc is inserted, "NO DISC" is displayed and the unit does not start to play or eject the disc.
 - Remove the disc by following these steps:
Press ▲ for at least 3 seconds.

LOADING ERROR

EJECT ERROR

- Mechanism error.
 - 1) Press ▲ and eject the disc.
If not ejecting, consult your Alpine dealer.
 - 2) When the error indication remains after ejecting, press ▲ again.
If the error indication still does not turn off after pressing ▲ for a few times, consult your Alpine dealer.

DISC ERROR

- Scratched disc, contaminated disc/poor recording/disc incompatible with this unit.
 - Press ▲.
 - Change the disc.

Indication for DVD/Video CD

NO DISC

- No disc is inserted.
 - Insert a disc.
- Although a disc is inserted, "NO DISC" is displayed and the unit does not start to play or eject the disc.
 - Remove the disc by following these steps:
 - Press ▲ for at least 3 seconds.



- Remote control operation is not possible.
 - For some discs or playing modes, certain operations are not possible. This is not a malfunction.

HI-TEMP

- Protective circuit is activated to high temperature.
 - The indicator will disappear when the temperature returns to within operation range.
 - Leave the power OFF until the temperature decreases and then turn the power ON again.

REGIONAL CODE VIOLATION

- Disc does not match regional code number.
 - Load a disc that matches the regional code number.

VIDEO SIGNAL SYSTEM IS NOT CORRECT

- PAL disc is loaded.
 - Load an NTSC disc

LOADING ERROR

EJECT ERROR

- Mechanism error.
 - 1) Press ▲ and eject the disc.
 - If not ejecting, consult your Alpine dealer.
 - 2) When the error indication remains after ejecting, press ▲ again.
 - If the error indication still does not turn off after pressing ▲ for a few times, consult your Alpine dealer.

DISC ERROR

- Scratched disc, contaminated disc/poor recording/disc incompatible with this unit.
 - Press ▲.
 - Change the disc.

STOP OR EJECT DISC BEFORE USING DVD-SETUP

- The DVD setup operation was attempted while playback of a disc is not stopped.
 - Stop playback of the disc or eject the disc before the DVD setup operation.

Indication for CD changer

HI-TEMP

- Protective circuit is activated due to high temperature.
 - The indicator will disappear when the temperature returns to within operation range.

ERROR01

- Malfunction in the CD Changer.
 - Consult your Alpine dealer. Press the magazine eject button and pull out the magazine.
 - Check the indication. Insert the magazine again.
 - If the magazine cannot be pulled out, consult your Alpine dealer.
- Magazine ejection not possible.
 - Press the magazine eject button. If the magazine does not eject, consult your Alpine dealer.

ERROR02

- A disc is left inside the CD Changer.
 - Press the Eject button to activate the eject function. When the CD Changer finishes the eject function, insert an empty CD magazine into the CD Changer to receive the disc left inside the CD Changer.

NO MAGAZINE

- No magazine is loaded into the CD Changer.
 - Insert a magazine.

NO DISC

- No indicated disc.
 - Choose another disc.

Indication for SAT Receiver Mode

ANTENNA

- The XM or SIRIUS antenna is not connected to the XM or SIRIUS radio module.
 - Check whether the XM or SIRIUS antenna cable is attached securely to the XM or SIRIUS radio module.
-

UPDATING

(XM mode)

CALL 888-539-SIRIUS TO SUBSCRIBE

(SIRIUS mode)

- Radio is being updated with latest encryption code.
 - Wait until encryption code is being updated. Channels 0 and 1 should function normally.
-

NO SIGNAL

(XM mode)

ACQUIRING SIGNAL

(SIRIUS mode)

- XM or SIRIUS signal is too weak at the current location.
 - Wait until the car reaches a location with a stronger signal.
-

LOADING

(XM mode)

ACQUIRING SIGNAL

(SIRIUS mode)

- Radio is acquiring audio or program information.
 - Wait until the radio has received the information.
-

OFF AIR

(XM mode)

ACQUIRING SIGNAL

(SIRIUS mode)

- The channel currently selected has stopped broadcasting.
 - Select another channel.
-

- The user has selected a channel number that does not exist or is not subscribed to.
 - The unit will revert back to the previously selected channel.
- There is no artist name/feature, song/program title, or additional information associated with the channel at that time.
 - No action needed.

Indication for iPod Mode

NO iPod

- The iPod is not connected.
 - Make sure the iPod is correctly connected.
 - Make sure the cable is not bent excessively.
 - The iPod's battery remains low.
 - Refer to the iPod's documentation and charge the battery.
-

NO SONG

- There are no songs in the iPod.
 - Download songs to the iPod and connect to the IVA-D310.
-

ERROR01

- Communication error
 - Turn the ignition key off, and then set to ACC or ON again.
 - Check the display by reconnecting between the iPod and the adapter, using the iPod cable.
-

ERROR02

- Caused by the iPod Software Version not being compatible with the optional adapter KCA-420i.
 - Refer to the Owner's Manual of the optional adapter KCA-420i, and update the iPod Software Version to be compatible with the optional adapter KCA-420i.

Specifications

MONITOR SECTION

Screen Size	7.0"
LCD Type	Transparent type TN LCD
Operation System	TFT active matrix
Number of Picture Elements	336,960 pcs. (1,440 × 234)
Effective Number of Picture Elements	99.99% or more
Illumination System	Cold cathode fluorescent tube

FM TUNER SECTION

Tuning Range	87.7 – 107.9 MHz
Mono Usable Sensitivity	9.3 dBf (0.8 μ V/75 ohms)
50 dB Quieting Sensitivity	13.5 dBf (1.3 μ V/75 ohms)
Alternate Channel Selectivity	80 dB
Signal-to-Noise Ratio	80 dB
Stereo Separation	45 dB
Capture Ratio	2.0 dB

AM TUNER SECTION

Tuning Range	530 – 1,710 kHz
Usable Sensitivity	22.5 μ V/27.0 dB

CD/DVD SECTION

Frequency Response	5 – 20,000 Hz
Wow & Flutter (% WRMS)	Below measurable limits
Total Harmonic Distortion	0.008% (at 1 kHz)
Dynamic Range	95 dB (at 1 kHz)
Channel Separation	85 dB (at 1 kHz)
Signal system	NTSC
Horizontal resolution	500 lines or greater
Video output level	1Vp-p (75 ohms)
Video S/N ratio	DVD: 60 dB
Audio S/N ratio	More than 105 dB

PICKUP

Wave length	
DVD:	665 nm
CD:	785 nm
Laser power	CLASS II

GENERAL

Power Requirement	14.4 V DC (11–16 V allowable)
Operating temperature	+32°F to +113°F (0°C to + 45°C)
Power Output	18 W RMS × 4* * Primary amplifier ratings per CEA-2006 Standard • Power output: measured at 4 Ohms and \leq 1% THD+N • S/N: 80 dBA (reference: 1 W into 4 Ohms)
Output Voltage	2,000 mV/10k ohms
Weight	(Monitor Section) 2.2 kg (4 lbs. 14 oz) (Tuner Section) 1.2 kg (2 lbs. 10 oz)
Audio output level	
Preout (Front, Rear):	2V/10k ohms (max.)
Preout (Subwoofer):	2V/10k ohms (max.)
Auxout:	1.2V/10k ohms
Ai-NET:	850 mV

CHASSIS SIZE (Monitor section)

Width	178 mm (7")
Height	50 mm (2")
Depth	165 mm (6-1/2")

CHASSIS SIZE (Tuner section)

Width	275 mm (10-13/16")
Height	40 mm (1-9/16")
Depth	170 mm (6-3/4")

- Due to continuous product improvement, specifications and design are subject to change without notice.
- The LCD panel is manufactured using an extremely high precision manufacturing technology. Its effective pixel ratio is over 99.99%. This means that there is a possibility that 0.01% of the pixels could be either always ON or OFF.

CAUTION

CAUTION-Laser radiation when open, DO NOT STARE INTO BEAM

(Bottom side of Monitor player)

Installation and Connections

Before installing or connecting the unit, please read the following and pages 5 to 7 of this manual thoroughly for proper use.

Warning

MAKE THE CORRECT CONNECTIONS

Failure to make the proper connections may result in fire or product damage.

USE ONLY IN CARS WITH A 12 VOLT NEGATIVE GROUND.

(Check with your dealer if you are not sure.) Failure to do so may result in fire, etc.

BEFORE WIRING, DISCONNECT THE CABLE FROM THE NEGATIVE BATTERY TERMINAL.

Failure to do so may result in electric shock or injury due to electrical shorts.

DO NOT ALLOW CABLES TO BECOME ENTANGLED IN SURROUNDING OBJECTS.

Arrange wiring and cables in compliance with the manual to prevent obstructions when driving. Cables or wiring that obstruct or hang up on places such as the steering wheel, gear lever, brake pedals, etc. can be extremely hazardous.

DO NOT SPLICE INTO ELECTRICAL CABLES.

Never cut away cable insulation to supply power to other equipment. Doing so will exceed the current carrying capacity of the wire and result in fire or electric shock.

DO NOT DAMAGE PIPE OR WIRING WHEN DRILLING HOLES.

When drilling holes in the chassis for installation, take precautions so as not to contact, damage or obstruct pipes, fuel lines, tanks or electrical wiring. Failure to take such precautions may result in fire.

DO NOT USE BOLTS OR NUTS IN THE BRAKE OR STEERING SYSTEMS TO MAKE GROUND CONNECTIONS.

Bolts or nuts used for the brake or steering systems (or any other safety-related system), or tanks should NEVER be used for installations or ground connections. Using such parts could disable control of the vehicle and cause fire etc.

KEEP SMALL OBJECTS SUCH AS BOLTS OR SCREWS OUT OF THE REACH OF CHILDREN.

Swallowing them may result in serious injury. If swallowed, consult a physician immediately.

DO NOT INSTALL IN LOCATIONS WHICH MIGHT HINDER VEHICLE OPERATION, SUCH AS THE STEERING WHEEL OR GEARSHIFT.

Doing so may obstruct forward vision or hamper movement etc. and results in serious accident.

Caution

HAVE THE WIRING AND INSTALLATION DONE BY EXPERTS.

The wiring and installation of this unit requires special technical skill and experience. To ensure safety, always contact the dealer where you purchased this product to have the work done.

USE SPECIFIED ACCESSORY PARTS AND INSTALL THEM SECURELY.

Be sure to use only the specified accessory parts. Use of other than designated parts may damage this unit internally or may not securely install the unit in place. This may cause parts to become loose resulting in hazards or product failure.

ARRANGE THE WIRING SO IT IS NOT CRIMPED OR PINCHED BY A SHARP METAL EDGE.

Route the cables and wiring away from moving parts (like the seat rails) or sharp or pointed edges. This will prevent crimping and damage to the wiring. If wiring passes through a hole in metal, use a rubber grommet to prevent the wires insulation from being cut by the metal edge of the hole.

DO NOT INSTALL IN LOCATIONS WITH HIGH MOISTURE OR DUST.

Avoid installing the unit in locations with high incidence of moisture or dust. Moisture or dust that penetrates into this unit may result in product failure.

Precautions

- Be sure to disconnect the cable from the (-) battery post before installing your IVA-D310. This will reduce any chance of damage to the unit in case of a short-circuit.
- Be sure to connect the color coded leads according to the diagram. Incorrect connections may cause the unit to malfunction or damage to the vehicle's electrical system.
- When making connections to the vehicle's electrical system, be aware of the factory installed components (e.g. on-board computer). Do not tap into these leads to provide power for this unit. When connecting the IVA-D310 to the fuse box, make sure the fuse for the intended circuit of the IVA-D310 has the appropriate amperage. Failure to do so may result in damage to the unit and/or the vehicle. When in doubt, consult your ALPINE dealer.
- The IVA-D310 uses female RCA-type jacks for connection to other units (e.g. amplifier) having RCA connectors. You may need an adaptor to connect other units. If so, please contact your authorized ALPINE dealer for assistance.
- Be sure to connect the speaker (-) leads to the speaker (-) terminal. Never connect left and right channel speaker cables to each other or to the vehicle body.
- The Display must be completely retracted in the casing when installing. If it is not, problems may occur.
- When installing in automobiles, make sure the Display can open/close without coming in contact with the gear shift.

IMPORTANT

Please record the serial number of your unit in the space provided below and keep it as a permanent record. The serial number plate is located on the bottom of the unit.

SERIAL NUMBER: _____
INSTALLATION DATE: _____
INSTALLATION TECHNICIAN: _____
PLACE OF PURCHASE: _____

Installation

Installing the Monitor

Installation Location

Before deciding on the mounting location, check that opening and closing the display will not hamper gear shifting in that position.

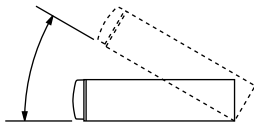

- Install at an angle of within 30 degrees from the horizontal.
- The monitor's angle is set to 90 degrees at the factory. Depending on the car, the monitor may hit the dashboard when opened. The monitor's angle can be adjusted and stored in memory so that the monitor will not hit the dashboard when opening. For adjusting the monitor, refer to "Adjusting the Monitor Viewing Angle" on page 11. Even when the vehicle's battery power is removed, the adjusted monitor angle remains stored in memory.

1

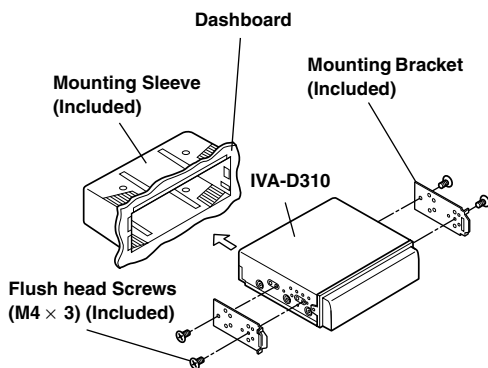

Slide the mounting sleeve into the dashboard. Install the supplied bracket on the monitor.

- Make sure to use the supplied Flush head screw (M4 x 3) to install the monitor.
If you use another screw to install the monitor, it may cause a malfunction.

2

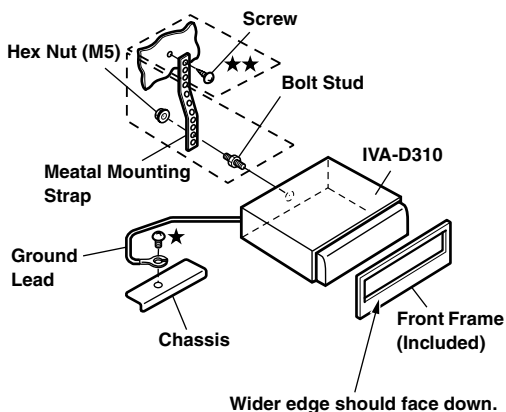

Reinforce the monitor unit with a metal mounting strap (not supplied). Secure the ground lead of the unit to a clean metal spot using a screw (★) already attached to the vehicle's chassis.

- For the screw marked ★ ★, use an appropriate screw for the chosen mounting location.

Connect each input lead coming from an amplifier or equalizer to the corresponding output lead coming from the left rear of the IVA-D310. Connect all other leads of the IVA-D310 according to details described in the Connections section.

3

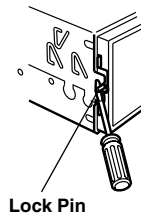

Slide the IVA-D310 into the dashboard. When the unit is in place, make sure the locking pins are fully seated in the down position. This can be done by pressing firmly in on the unit while pushing the locking pin down with a small screwdriver. This ensures that the unit is properly locked and will not accidentally come out from the dashboard. Install the supplied Front Frame.

Removal

1. Use a small screwdriver (or similar tool) to push the locking pins to the "up" position (see Step 3). As each pin is unlocked, gently pull out on the unit to make sure it does not re-lock before unlocking the second pin.
2. Pull the unit out, keeping it unlocked as you do so.

< JAPANESE CAR >

To install using the vehicle's standard bracket.

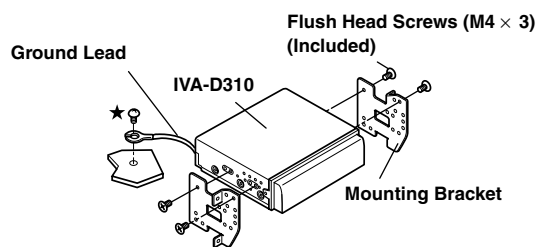

- Make sure to use the supplied flush head screw (M4 x 3) to install the monitor.
If you use another screw to install the monitor, it may cause a malfunction. However, only if you cannot install with the flush head screws (M4 x 3), use the supplied screw (M4 x 6).

Installing the Tuner Box

Caution

Do not block the unit's fan or heat sink, thus preventing air circulation. If blocked, heat will accumulate inside the unit and may cause a fire.

Air ventilation hole

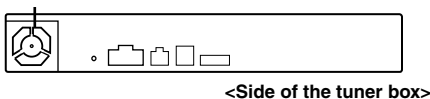

When mounting with Velcro fasteners

When mounting the tuner with the Velcro fasteners, be sure to choose a flat location.

Do not hang the unit from the bottom of the dashboard or rear deck with the Velcro fasteners.

- 1 Remove the Protective paper and attach two pieces of Velcro fastener to the bottom of the Tuner.

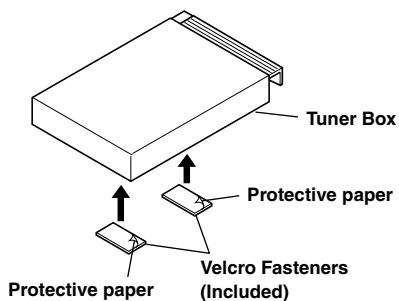

- 2 Check the position, and then fix the Tuner to the floor carpet.

When mounting with Screws

When mounting the tuner with the screws, be sure to choose a flat location.

When making holes, be careful not to scratch any pipes or wires.

- 1 Connect the bracket to both the flanks of the tuner with the supplied pan screws (M4 × 8).

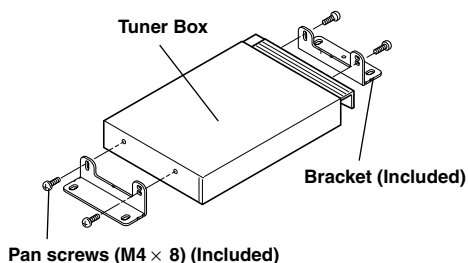

- 2 Install the tuner on the floor with the supplied flange-head tapping screws (M4 × 14).

Flange-head tapping screws (M4 × 14) (Included)

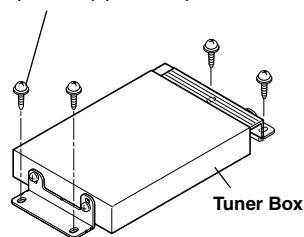

Installing the DC/DC Converter

Install the DC/DC Converter on the floor with the supplied flange-head tapping screws (M4 × 14).

Flange-head tapping screws (M4 × 14) (Included)

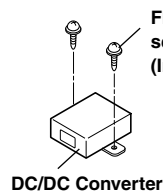

Parking Brake Lead Connection

If necessary, use a pinch connector to connect the foot brake lead, parking brake lead, etc.

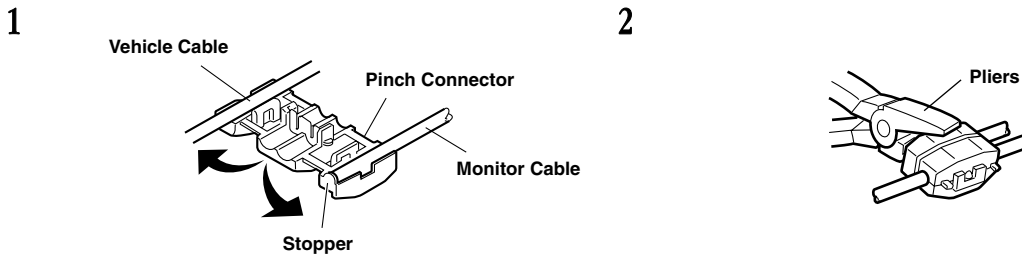

Foot Brake Lead / Parking Brake Lead Connection

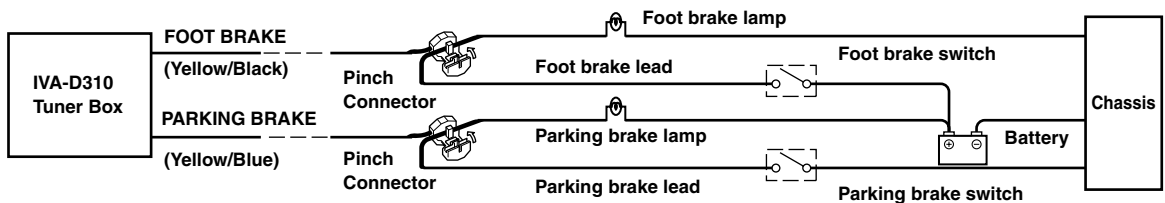

Connection Diagram of SPST Switch (Sold Separately)

(If the ACC power supply is not available)

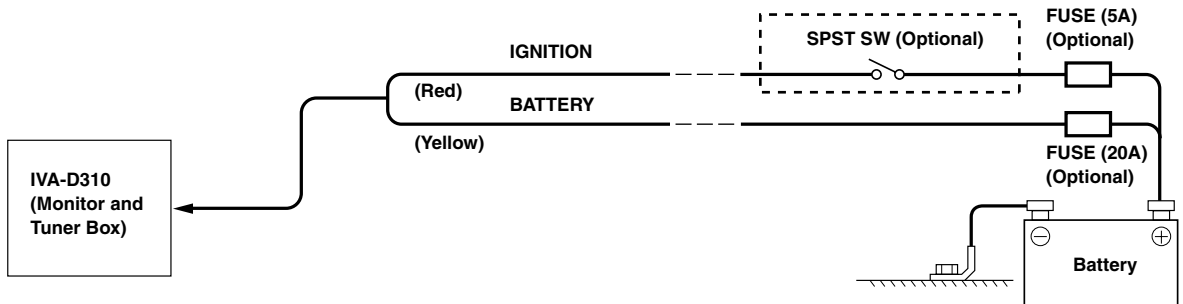

- If your vehicle has no ACC power supply, add an SPST (Single-Pole, Single-Throw) switch (sold separately) and fuse (sold separately).
- The diagram and the fuse amperage shown above are in the case when IVA-D310 is used individually.
- If the switched power (ignition) lead of the IVA-D310 is connected directly to the positive (+) post of the vehicle's battery, the IVA-D310 draws some current (several hundred milliamperes) even when its switch is placed in the OFF position and the battery may be discharged.

To prevent external noise from entering the audio system.

- Locate the unit and route the leads at least 10 cm away from the car harness.
- Keep the battery power leads as far away from other leads as possible.
- Connect the ground lead securely to a bare metal spot (remove any paint, dirt or grease if necessary) of the car chassis.
- If you add an optional noise suppressor, connect it as far away from the unit as possible. Your Alpine dealer carries various noise suppressors, contact them for further information.
- Your Alpine dealer knows best about noise prevention measures so consult your dealer for further information.

Connections (IVA-D310 Wiring Diagram)

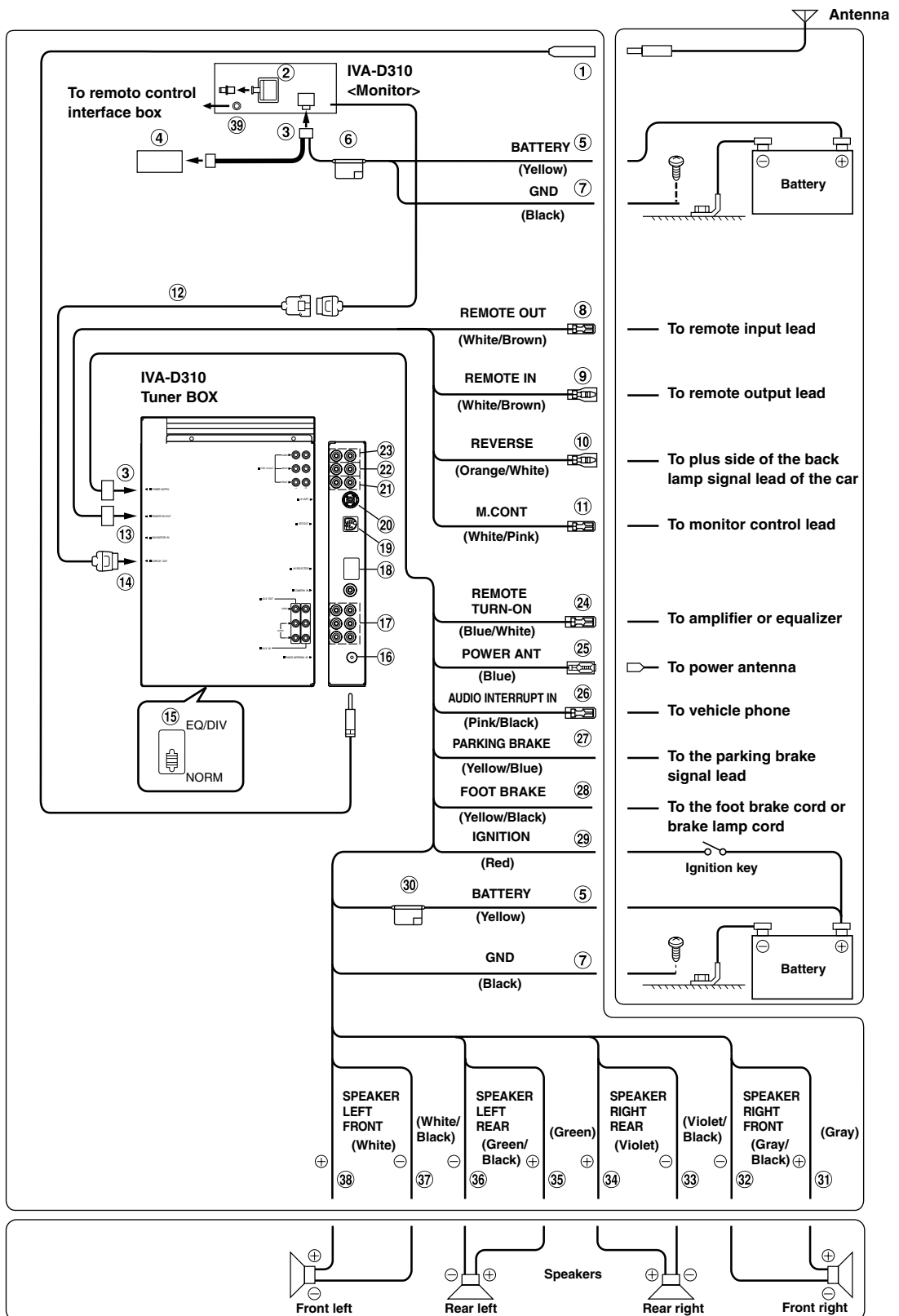

• Set the system switch to "NORM" when only a changer is connected (when the Ai-NET compatible equalizer is not used).

- ① **Antenna Extension Cable**
- ② **Digital Output Terminal (Optical)**
Use when combining fiber digital input compatible products.
- ③ **Power Supply Connector**
- ④ **DC/DC Converter**
 - Do not install the converter at a location subjected to water such as under the floor mat or air conditioner. This may cause a malfunction.
 - Do not bundle the DC/DC converter cable with other audio cables. Also, do not install the cables directly next to the unit. Doing so may induce noise into your system.
 - Keep the DC/DC converter away from the Antenna cables and the rear side of the unit, otherwise noise may be generated when receiving radio broadcast.
- ⑤ **Battery Lead (Yellow)**
Connect this lead to the positive (+) post of the vehicle's battery.
- ⑥ **Fuse Holder (10A)**
- ⑦ **Ground Lead (Black)**
Connect this lead to a good chassis ground on the vehicle. Make sure the connection is made to bare metal and is securely fastened using the sheet metal screw provided.
- ⑧ **Remote Control Output Lead (White/Brown)**
Connect this lead to the remote control input lead. This lead outputs the controlling signals from the remote control.
- ⑨ **Remote Control Input Lead (White/Brown)**
Connect the external Alpine product to the remote control output lead.
- ⑩ **Reverse Lead (Orange/White)**
Use only when a back-up camera is connected. Connect to the plus side of the car's reverse lamp that lights when the transmission is shifted into reverse (R). Switches the video picture to the back-up camera. This is linked with putting the car into reverse (R).
- ⑪ **Monitor Control Lead (White/Pink)**
Connect this to the Monitor Control Lead of the touch panel-compatible rear monitor.
- ⑫ **Monitor Extension Cable (Included)**
- ⑬ **Remote IN/OUT Terminal**
- ⑭ **Display Output Terminal**
- ⑮ **System Switch**
When connecting an equalizer or divider using Ai-NET feature, place this switch in the EQ/DIV position. When no device is connected, leave the switch in the NORM position.
 - Be sure to turn the power off to the unit before changing the switch position.
- ⑯ **Antenna Receptacle**
- ⑰ **AUX Input Terminals/AUX Output Terminals**
If these terminals are connected to the optional expansion box (VPE-S431), the AUX input and output terminals are not used on this unit. Connect AUX IN 1, 2 and 3, and the AUX OUT 1 and 2 terminals of the expansion box (VPE-S431) to the external device(s).
- ⑱ **AV Select Connector**
When this connector is connected to the optional expansion box (VPE-S431), connect this to the HEAD UNIT terminal of VPE-S431.
- ⑲ **Ext. Output Connector**
If this connector is connected to the optional Amplifier Link compatible monaural Amplifier, connect this to the optional Amplifier Link Box, and output the Amplifier Link control signal.
- ⑳ **Ai-NET Connector**
Connect this to the output or input connector of other product (CD changer, Equalizer, iPod adapter*, etc.) equipped with Ai-NET.
 - * If you connect to iPod, you need the optional adapter (KCA-420i). For details on connection, refer to the Owner's Manual of the KCA-420i.
- ㉑ **Front input/output Terminal**
Use when connecting an amplifier or Equalizer.
- ㉒ **Rear input/output Terminal**
Use when connecting an amplifier or Equalizer.
- ㉓ **Subwoofer output Terminal**
Connect the input lead of an amplifier for the subwoofer to this terminal.
- ㉔ **Remote Turn-On Lead (Blue/White)**
Connect this lead to the remote turn-on lead of your amplifier or signal processor.
- ㉕ **Power Antenna Lead (Blue)**
Connect this lead to the +B terminal of your power antenna, if applicable.
- ㉖ **Audio Interrupt In Lead (Pink/Black)**
- ㉗ **Parking Brake Lead (Yellow/Blue)**
Connect this lead to the power supply side of the parking brake switch to transmit the parking brake status signals to the IVA-D310.
- ㉘ **Foot Brake Lead (Yellow/Black)**
Connect to the vehicle's foot brake lead or brake lamp lead.
- ㉙ **Switched Power Lead (Ignition) (Red)**
Connect this lead to an open terminal on the vehicle's fuse box or another unused power source which provides (+) 12V only when the ignition is turned on or in the accessory position.
- ㉚ **Fuse Holder (10A)**
- ㉛ **Right Front (+) Speaker Output Lead (Gray)**
- ㉜ **Right Front (-) Speaker Output Lead (Gray/Black)**
- ㉝ **Right Rear (-) Speaker Output Lead (Violet/Black)**
- ㉞ **Right Rear (+) Speaker Output Lead (Violet)**
- ㉟ **Left Rear (+) Speaker Output Lead (Green)**
- ㊱ **Left Rear (-) Speaker Output Lead (Green/Black)**
- ㊲ **Left Front (-) Speaker Output Lead (White/Black)**
- ㊳ **Left Front (+) Speaker Output Lead (White)**
- ㊴ **Remote Control Interface Connector**
Connect to the remote control interface box.

System Example

Connect the Ai-NET compatible audio processor (Fiber digital compatible), Navigation system, DVD player and changer.

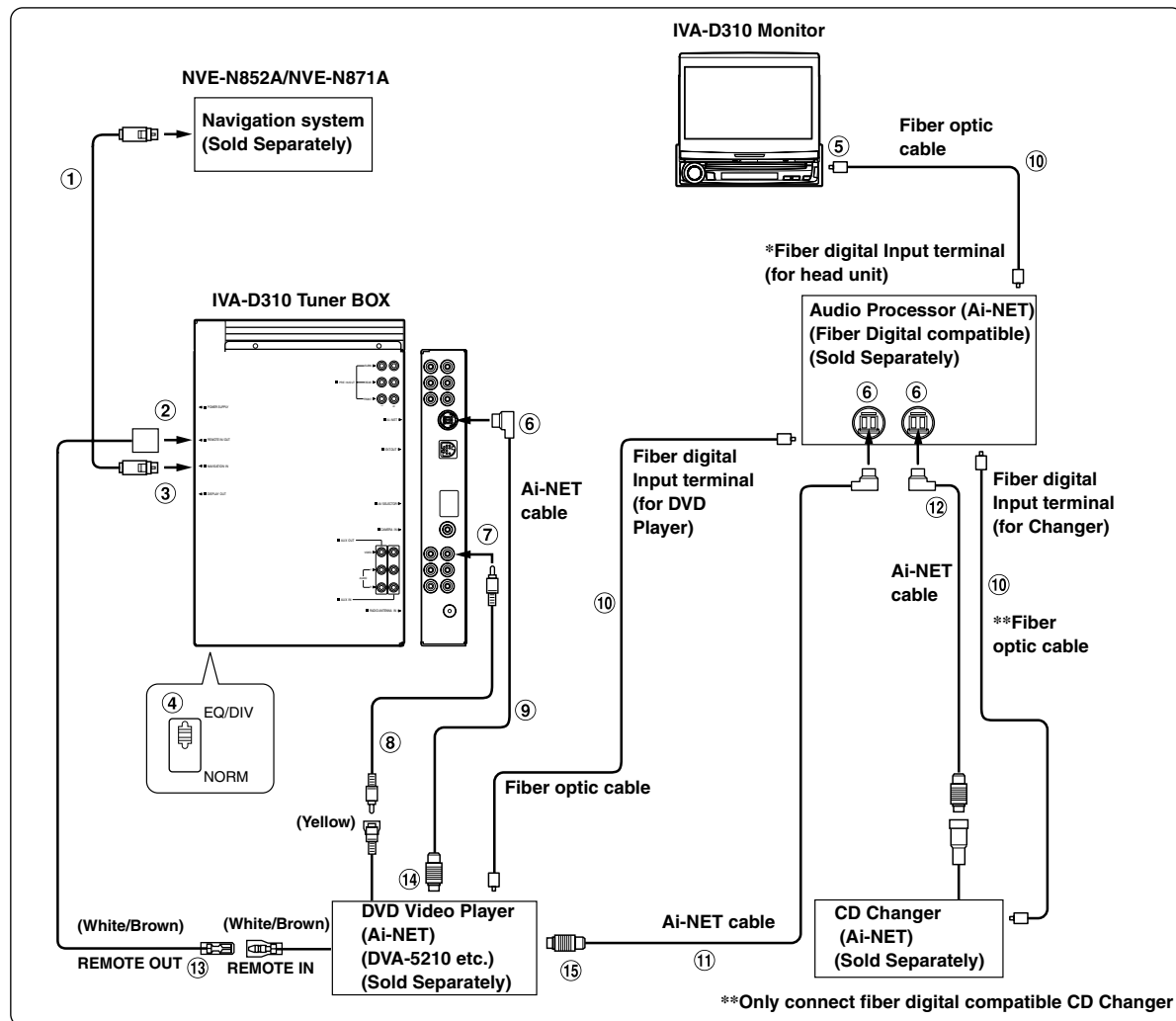

- When the fiber digital compatible product is connected, it is necessary to set the mode of this unit. Refer to "Setting the Digital Output" (page 35) and set to ON. Then refer to "Optical Digital Input Selection for an External Audio Processor" (page 35) and switch the setting.
- * When connecting with PXA-H510 :
 - Connect the fiber digital input terminal to the DVD.
 - IVA-D310, DVA-5200, DVA-5205 or DVA-5210 cannot be connected simultaneously when fiber digital is in use.
- When the NVA-N751AS is connected for the Navigation System, use the RGB conversion cable KWE-503N (Sold separately).

Please observe the following when using Fiber Optic Cable.

- Do not coil the Fiber Optic Cable smaller than a 30 mm radius.
- Do not place anything on top of the Fiber Optic Cable.

- ① **RGB Cable (Included with NVE-N852A, not included with NVE-N871A)**
- ② **Remote IN/OUT Terminal**
- ③ **RGB Input Terminal**
Connect this to the RGB output terminal of the Navigation System.
- ④ **System Switch**
When connecting an equalizer or divider using Ai-NET feature, place this switch in the EQ/DIV position. When no device is connected, leave the switch in the NORM position.
 - *Be sure to turn the power off to the unit before changing the switch position.*
- ⑤ **Digital Output Terminal**
- ⑥ **Ai-NET Connector**
Connect this to the output or input connector of other product equipped with Ai-NET.
- ⑦ **AUX Video Input (AUX1) Terminal**
Connect the video output lead of a DVD video player or DVD changer to this terminal.
- ⑧ **RCA Extension Cable (Included with DVD video player)**
- ⑨ **Ai-NET Cable (Included with DVD video player)**
- ⑩ **Fiber optic Cable (Sold Separately)**
- ⑪ **Ai-NET Cable (Included with Audio Processor)**
- ⑫ **Ai-NET Cable (Included with CD Changer)**
- ⑬ **Remote Control Output Lead (White/Brown)**
Connect this lead to the remote control input lead. This lead outputs the controlling signals from the remote control.
- ⑭ **To Ai-NET Connector (Gray)**
- ⑮ **To Ai-NET Connector (Black)**

When Connecting External Equipment

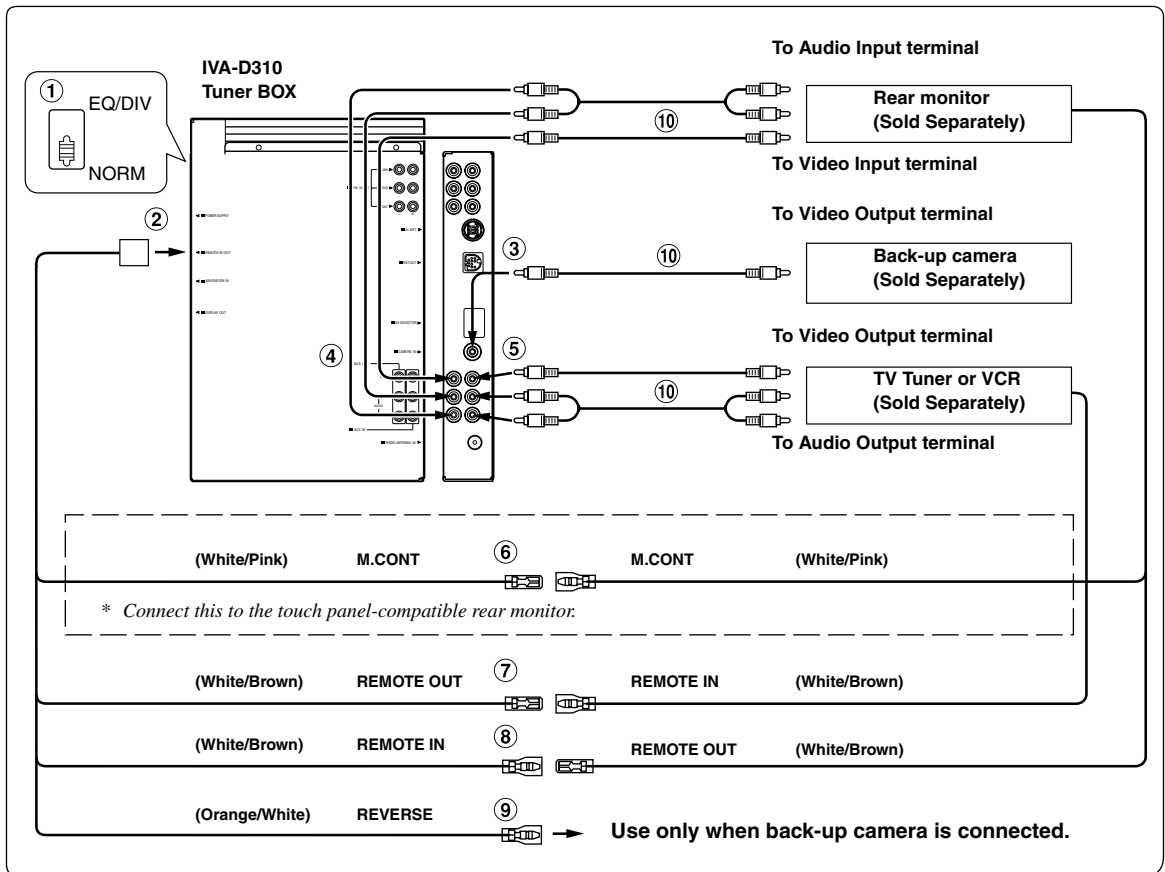

① System Switch

When connecting an equalizer or divider using Ai-NET feature, place this switch in the EQ/DIV position. When no device is connected, leave the switch in the NORM position.

- Be sure to turn the power off to the unit before changing the switch position.

② Remote IN/OUT Terminal

③ CAMERA Input Terminal

Use when connecting a back-up camera.

④ AUX Video/Audio Output Terminal

Use when connecting an optional monitor etc.

⑤ AUX Video/Audio Input Terminal

⑥ Monitor Control Lead (White/Pink)

Connect this to the Monitor Control Lead of the touch panel-compatible rear monitor.

⑦ Remote Control Output Lead (White/Brown)

Connect this lead to the remote control input lead. This lead outputs the controlling signals from the remote control.

⑧ Remote Control Input Lead (White/Brown)

⑨ Connect to the plus side of the car's reverse lamp which lights when the transmission is shifted into reverse (R).

Switches the video picture to the back-up camera. This is linked to putting the car into reverse (R).

⑩ RCA Extension Cable (Sold separately)

Connect an expansion box (VPE-S431), DVD Player, DVD Changer or the Touch Panel-compatible Monitor.

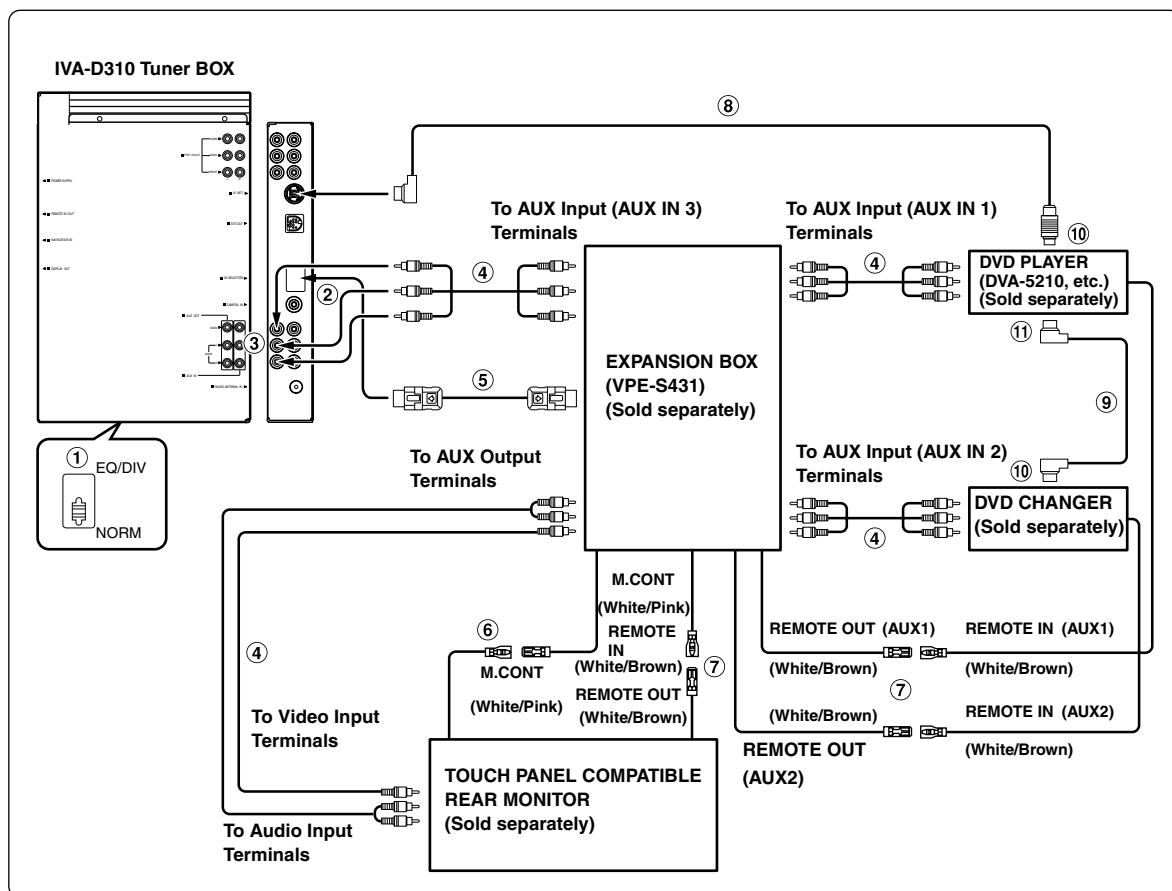

- If the expansion box (VPE-S431) is connected to either a DVD video player or DVD changer, connect this to AUX IN 1. If this is connected to AUX IN 2, remote control operation will not be possible. If both are to be connected, connect the DVD video player to AUX IN 1, and the DVD changer to AUX IN 2.

① System Switch

When connecting an equalizer or divider using Ai-NET feature, place this switch in the EQ/DIV position. When no device is connected, leave the switch in the NORM position.

- Be sure to turn the power off to the unit before changing the switch position.

② To AV Selector Terminal

③ AUX Video/Audio Output Terminal

④ RCA Extension Cable (Sold separately)

⑤ AV Selector Cable (Included with VPE-S431)

⑥ Monitor Control Lead (White/Pink)

Connect this to the Monitor Control Lead of the touch panel-compatible rear monitor.

⑦ Remote Control Output Lead (White/Brown)

Connect this lead to the remote control input lead. This lead outputs the controlling signals from the remote control.

⑧ Ai-NET Cable (Included with DVD video player)

⑨ Ai-NET Cable (Included with DVD changer)

⑩ To Ai-NET Connector (Black)

⑪ To Ai-NET Connector (Gray)



LIMITED WARRANTY

ALPINE ELECTRONICS OF AMERICA, INC. AND ALPINE OF CANADA INC. ("Alpine"), are dedicated to quality craftsmanship and are pleased to offer this Warranty. We suggest that you read it thoroughly. Should you have any questions, please contact your Dealer or contact Alpine at one of the telephone numbers listed below.

● PRODUCTS COVERED:

This Warranty covers Car Audio Products and Related Accessories ("the product"). Products purchased in the Canada are covered only in the Canada. Products purchased in the U.S.A. are covered only in the U.S.A.

● LENGTH OF WARRANTY:

This Warranty is in effect for one year from the date of the first consumer purchase.

● WHO IS COVERED:

This Warranty only covers the original purchaser of the product, who must reside in the United States, Puerto Rico or Canada.

● WHAT IS COVERED:

This Warranty covers defects in materials or workmanship (parts and labor) in the product.

● WHAT IS NOT COVERED:

This Warranty does not cover the following:

- ① Damage occurring during shipment of the product to Alpine for repair (claims must be presented to the carrier).
- ② Damage caused by accident or abuse, including burned voice coils caused by over-driving the speaker (amplifier level is turned up and driven into distortion or clipping). Speaker mechanical failure (e.g. punctures, tears or rips). Cracked or damaged LCD panels. Dropped or damaged hard drives.
- ③ Damage caused by negligence, misuse, improper operation or failure to follow instructions contained in the Owner's manual.
- ④ Damage caused by act of God, including without limitation, earthquake, fire, flood, storms or other acts of nature.
Any cost or expense related to the removal or reinstallation of the product.
- ⑤ Service performed by an unauthorized person, company or association.
- ⑥ Any product which has the serial number defaced, altered or removed.
- ⑦ Any product which has been adjusted, altered or modified without Alpine's consent.
- ⑧ Any product not distributed by Alpine within the United States, Puerto Rico or Canada.
- ⑨ Any product not purchased from an Authorized Alpine Dealer.

● HOW TO OBTAIN WARRANTY SERVICE:

- ① You are responsible for delivery of the product to an Authorized Alpine Service Center or Alpine for repair and for payment of any initial shipping charges. Alpine will, at its option, repair or replace the product with a new or reconditioned product without charge. If the repairs are covered by the warranty, and if the product was shipped to an Authorized Alpine Service Center or Alpine, Alpine will pay the return shipping charges.
- ② You should provide a detailed description of the problem(s) for which service is required.

- ③ You must supply proof of your purchase of the product.
- ④ You must package the product securely to avoid damage during shipment. To prevent lost packages it is recommended to use a carrier that provides a tracking service.

● HOW WE LIMIT IMPLIED WARRANTIES:

ANY IMPLIED WARRANTIES INCLUDING FITNESS FOR USE AND MERCHANTABILITY ARE LIMITED IN DURATION TO THE PERIOD OF THE EXPRESS WARRANTY SET FORTH ABOVE AND NO PERSON IS AUTHORIZED TO ASSUME FOR ALPINE ANY OTHER LIABILITY IN CONNECTION WITH THE SALE OF THE PRODUCT.

● HOW WE EXCLUDE CERTAIN DAMAGES:

ALPINE EXPRESSLY DISCLAIMS LIABILITY FOR INCIDENTAL AND CONSEQUENTIAL DAMAGES CAUSED BY THE PRODUCT. THE TERM "INCIDENTAL DAMAGES" REFERS TO EXPENSES OF TRANSPORTING THE PRODUCT TO THE ALPINE SERVICE CENTER, LOSS OF THE ORIGINAL PURCHASER'S TIME, LOSS OF THE USE OF THE PRODUCT, BUS FARES, CAR RENTALS OR OTHER COSTS RELATING TO THE CARE AND CUSTODY OF THE PRODUCT. THE TERM "CONSEQUENTIAL DAMAGES" REFERS TO THE COST OF REPAIRING OR REPLACING OTHER PROPERTY WHICH IS DAMAGED WHEN THIS PRODUCT DOES NOT WORK PROPERLY. THE REMEDIES PROVIDED UNDER THIS WARRANTY ARE EXCLUSIVE AND IN LIEU OF ALL OTHERS.

● HOW STATE/PROVINCIAL LAW RELATES TO THE WARRANTY:

This Warranty gives you specific legal rights, and you may also have other rights which vary from state to state and province to province. In addition, some states/provinces do not allow limitations on how long an implied warranty lasts, and some do not allow the exclusion or limitation of incidental or consequential damages. Accordingly, limitations as to these matters contained herein may not apply to you.

● IN CANADA ONLY:

This Warranty is not valid unless your Alpine car audio product has been installed in your vehicle by an Authorized Installation Center, and this warranty stamped upon installation by the installation center.

● HOW TO CONTACT CUSTOMER SERVICE:

Should the product require service, please call the following number for your nearest Authorized Alpine Service Center.

**CAR AUDIO 1-800-ALPINE-1 (1-800-257-4631)
NAVIGATION 1-888-NAV-HELP (1-888-628-4357)**

Or visit our website at; <http://www.alpine-usa.com>

ALPINE ELECTRONICS OF AMERICA, INC., 19145 Gramercy Place, Torrance, California 90501, U.S.A.

ALPINE ELECTRONICS OF CANADA, INC., 7300 Warden Ave., Suite 203, Markham, Ontario L3R 9Z6, Canada
Do not send products to these addresses.

Call the toll free telephone number or visit the website to locate a service center.

Free Manuals Download Website

<http://myh66.com>

<http://usermanuals.us>

<http://www.somanuals.com>

<http://www.4manuals.cc>

<http://www.manual-lib.com>

<http://www.404manual.com>

<http://www.luxmanual.com>

<http://aubethermostatmanual.com>

Golf course search by state

<http://golfingnear.com>

Email search by domain

<http://emailbydomain.com>

Auto manuals search

<http://auto.somanuals.com>

TV manuals search

<http://tv.somanuals.com>