



Mobile Media Station

IVA-W502E



MP3 AAC



- OWNER'S MANUAL
Please read before using this equipment.
- 使用手冊
請在使用本設備之前先閱讀使用手冊。

ALPINE ELECTRONICS MARKETING, INC.
1-1-8 Nishi Gotanda,
Shinagawa-ku,
Tokyo 141-0031, Japan
Phone 03-5496-8231

ALPINE ELECTRONICS OF AMERICA, INC.
19145 Gramercy Place, Torrance,
California 90501, U.S.A.
Phone 1-800-ALPINE-1 (1-800-257-4631)

ALPINE ELECTRONICS OF CANADA, INC.
777 Supertest Road, Toronto,
Ontario M3J 2M9, Canada
Phone 1-800-ALPINE-1 (1-800-257-4631)

ALPINE ELECTRONICS OF AUSTRALIA PTY. LTD.
161-165 Princes Highway, Hallam
Victoria 3803, Australia
Phone 03-8787-1200

ALPINE ELECTRONICS GmbH
Frankfurter Ring 117, 80807 München, Germany
Phone 089-32 42 640

ALPINE ELECTRONICS OF U.K. LTD.
Alpine House
Fletchamstead Highway, Coventry CV4 9TW, U.K.
Phone 0870-33 33 763

ALPINE ELECTRONICS FRANCE S.A.R.L.
(RCS PONTOISE B 338 101 280)
98, Rue de la Belle Etoile, Z.I. Paris Nord II,
B.P. 50016, 95945 Roissy Charles de Gaulle
Cedex, France
Phone 01-48638989

ALPINE ITALIA S.p.A.
Viale C. Colombo 8, 20090 Trezzano
Sul Naviglio (MI), Italy
Phone 02-484781

ALPINE ELECTRONICS DE ESPAÑA, S.A.
Portal de Gamarra 36, Pabellón, 32
01013 Vitoria (Alava)-APDO 133, Spain
Phone 945-283588

ALPINE ELECTRONICS (BENELUX) GmbH
Leuvensesteenweg 510-B6,
1930 Zaventem, Belgium
Phone 02-725-13 15

Contents

Operating Instructions

WARNING

WARNING	4
CAUTION	4
PRECAUTIONS	5
Discs Playable on This Unit	6

Getting Started

Accessory List	10
Location of Controls	10
Turning Power On or Off	10
Inserting / Ejecting a Disc	11
Adjusting the Monitor Viewing Angle	11
Adjusting the Volume	11
Lowering Volume Quickly	11
How to view the Display	11
Soft button operation	11
Recalling the Source	11
Displaying the Numeric Keypad Input Screen	12
Selecting the Display Style	13

Radio

Listening to the Radio	13
Presetting Stations Manually	14
Presetting Stations Automatically	14
Tuning to Preset Stations	14

CD/MP3/WMA/AAC

Playback	15
Repeat Play	15
M.I.X. (Random Play)	15
Selecting Folders (concerning MP3/WMA/AAC)	15
About MP3/WMA/AAC	16

DVD/Video CD

Playing a Disc	18
To display the DVD mode screen	18
If a menu screen appears	18

Displaying the Top Menu Screen	19
Displaying the Menu Screen	19
Displaying the Menu Operation Mode Screen	19
Searching by Programme	20
Searching by Playlist	20
Stopping Playback (PRE STOP)	20
Stopping Playback	20
Fast-forwarding/Fast-reversing	20
Finding the Beginnings of Chapters/Tracks/ Files	20
Playing Still Frames (Pausing)	21
Forward/reverse frame-by-frame Playback	21
Slow Motion Playback	21
Selecting Programme (SKIP)	21
Selecting Playlist (SKIP)	21
Selecting Folders	21
Repeat Playback	21
Searching by Title/Group/Programme/Playlist/ Folder Number	22
Searching Directly by Chapter, Track or File Number	22
Switching the Angle	23
Scroll to Move the Page Forward or Back	23
Switching the Audio Tracks	23
Switching the Subtitles (Subtitle Language)	23
Switching from the disc menu	24
Displaying the Disc Status for DVD/ Video CD	24
About DivX®	24

Other Useful Features

Adjusting the Audio	24
Search Function	25
Rear Entertainment Function	26
Switching Display Modes	26
Switching the Visual Source Only (Simultaneous Function)	26
Cancelling the Simultaneous Function	27
Blackout Mode On and Off	27

Setup

DVD Setup

DVD Setup Operation	27
Changing the language setting	28
Setting of the Menu Language	28
Setting of the Audio Language	28
Setting of the Subtitle Language	28
Changing the Country Code Setting	28
Setting the Rating Level (Parental Lock)	29
Changing the Digital Output Setting	29
Setting the Downmix Mode	31
Setting the TV Screen Mode	31
Setting of the Bonus Code	31
Setting of the DVD-Audio Playback Mode	31
Playing MP3/WMA/AAC Data (FILE PLAY MODE)	31
Setting the compressed File Playback Data	31
Displaying DivX [®] Disc Information	32
Setting the Video CD Play Mode	32

DISPLAY Setup

Display Setup Operation	32
Setting the Brightness of the Backlighting	33
Adjusting the Minimum Level of Backlight	33
Switching Background Textures	33
Setting Automatic Background Textures	33
Switching the Font Back Display Colour	33
Adjusting the Touch Panel	33

GENERAL Setup

General Setup Operation	34
Displaying the Time	34
Setting the Time	34
Demonstration Function	34
Sound (Beep) Guide Function	34
Setting the Scroll	34
Adjusting the Dimmer of Button Lighting at Night	34

SYSTEM Setup

System Setup Operation	35
Setting the External Device Interrupt Mode	35
Setting the Interrupt Icon Display	35
Switching the function of the remote sensor	35
Setting the Rear Camera Input	36
Setting the Navigation Mode	36

Setting the Navigation Interruption	36
Setting the AUX Mode	36
Adjusting the External Input Audio Level	36
Switching the Visual Input Signal System	36
Setting the Picture Output	36
Setting the Bluetooth Connection (BLUETOOTH IN)	37
Setting the USB Adapter to ON/OFF	37
Setting the VISUAL Soft Button	37
Setting the OPTION Button on the Unit	37
Setting the Digital Output	37
Setting the AUX+ Mode	37
Adjusting the AUX+ Audio Level	37

L.L.C. (Linear Luminance Control) SETUP

L.L.C. Setting Operation	38
Picture Quality Darkness Adjustment Function (L.L.C.)	38
Selecting the VISUAL EQ Mode (Maker's setting)	38
Adjusting Brightness	38
Adjusting Colour of Picture	38
Adjusting Tint of Picture	38
Adjusting Image Contrast	39
Adjusting Picture Quality	39
Storing VISUAL EQ	39

Data Download

Downloading the BACKGROUND data	39
---------------------------------------	----

External Audio Processor (Optional)

Adjustment Procedure for Dolby Surround	40
Setting the A.PROCESSOR	41
Storing Settings in the Memory	46
Calling up the Preset Memory	46

IMPRINT Operation (Optional)

Changing MultEQ mode	46
Adjusting Sound Setting in Manual Mode	47
Equalizer Presets (F-EQ)	47
Setting the Response Slope for the High Range Speaker (TW SETUP)	47
Setting the MX Level (MEDIA XPANDER)	47
Adjusting the Parametric Equalizer Curve (P-EQ)	48
Adjusting the Graphic Equalizer Curve (G-EQ)	48
Setting the Time Correction Unit (T.CORR PARAMETER)	48

Adjusting the Time Correction (T. CORR)	48
Adjusting the Crossover Settings (X-OVER)	49
Storing Settings in the Memory	49
Calling up the Preset Memory	50
Setting the Subwoofer	50
Adjusting the Subwoofer Level	50
Setting the Subwoofer System	50
Setting the Subwoofer Phase	50
Setting the Subwoofer Channel	50
About Time Correction	50
About the Crossover	51
About IMPRINT	52

Navigation System (Optional)

Switching the Navigation Screen (Optional)	53
---	----

Auxiliary Device (Optional)

Operating Auxiliary Devices (Optional)	54
--	----

TUE-T200DVB Operation (Optional)

Operating the TUE-T200DVB (Optional)	54
--	----

Changer (Optional)

Controlling CD Changer (Optional)	55
Multi-Changer Selection (Optional)	55

USB Adapter Operation (Optional)

Controlling USB (Optional)	56
----------------------------------	----

USB Memory (Optional)

BANK Function (USB memory only)	56
Playback	57
Repeat Play	57
Random Play Shuffle (M.I.X.)	57
Searching for a desired Song	57
Searching by artist name	58
Selecting Playlist/Artist/Album/Genre/ Composer	58
Select the desired Folder (Folder up/down)	58
Creating the playlist from the Artist/Album information of the current song	58
About MP3/WMA/AAC File of USB Memory	58

iPod® (Optional)

Playback	59
Searching for a desired Song	59
Searching by artist name	59
Direct Search Function	60
Selecting Playlist/Artist/Album/Genre/Composer/ Category	60
Random Play Shuffle (M.I.X.)	60
Repeat Play	61

Information

About DVDs	61
Terminology	62
List of Language Codes	63
List of Country Codes	64
In Case of Difficulty	66
Specifications	70

Installation and Connections

Warning	71
Caution	71
Precautions	71
Installation	72
Connection Diagram of SPST Switch (Sold Separately)	74
Connections	75
System Example	78

Operating Instructions

WARNING



WARNING

This symbol means important instructions. Failure to heed them can result in serious injury or death.

INSTALL THE PRODUCT CORRECTLY SO THAT THE DRIVER CANNOT WATCH TV/VIDEO UNLESS THE VEHICLE IS STOPPED AND THE EMERGENCY BRAKE IS APPLIED.

It is dangerous for the driver to watch TV/Video while driving a vehicle. Installing this product incorrectly enables the driver to watch TV/Video while driving. This may cause a distraction, preventing the driver from looking ahead, thus causing an accident. The driver or other people could be severely injured.

DO NOT WATCH VIDEO WHILE DRIVING.

Watching the video may distract the driver from looking ahead of the vehicle and cause an accident.

DO NOT OPERATE ANY FUNCTION THAT TAKES YOUR ATTENTION AWAY FROM SAFELY DRIVING YOUR VEHICLE.

Any function that requires your prolonged attention should only be performed after coming to a complete stop. Always stop the vehicle in a safe location before performing these functions. Failure to do so may result in an accident.

KEEP THE VOLUME AT A LEVEL WHERE YOU CAN STILL HEAR OUTSIDE NOISES WHILE DRIVING.

Excessive volume levels that obscure sounds such as emergency vehicle sirens or road warning signals (train crossings, etc.) can be dangerous and may result in an accident. LISTENING AT LOUD VOLUME LEVELS IN A CAR MAY ALSO CAUSE HEARING DAMAGE.

MINIMIZE DISPLAY VIEWING WHILE DRIVING.

Viewing the display may distract the driver from looking ahead of the vehicle and cause an accident.

DO NOT DISASSEMBLE OR ALTER.

Doing so may result in an accident, fire or electric shock.

USE ONLY IN CARS WITH A 12 VOLT NEGATIVE GROUND.

(Check with your dealer if you are not sure.) Failure to do so may result in fire, etc.

KEEP SMALL OBJECTS SUCH AS BATTERIES OUT OF THE REACH OF CHILDREN.

Swallowing them may result in serious injury. If swallowed, consult a physician immediately.

USE THE CORRECT AMPERE RATING WHEN REPLACING FUSES.

Failure to do so may result in fire or electric shock.

DO NOT BLOCK VENTS OR RADIATOR PANELS.

Doing so may cause heat to build up inside and may result in fire.

USE THIS PRODUCT FOR MOBILE 12V APPLICATIONS.

Use for other than its designed application may result in fire, electric shock or other injury.

DO NOT PLACE HANDS, FINGERS OR FOREIGN OBJECTS IN INSERTION SLOTS OR GAPS.

Doing so may result in personal injury or damage to the product.



CAUTION

This symbol means important instructions. Failure to heed them can result in injury or material property damage.

HALT USE IMMEDIATELY IF A PROBLEM APPEARS.

Failure to do so may cause personal injury or damage to the product. Return it to your authorized Alpine dealer or the nearest Alpine Service Centre for repairing.

KEEP FINGERS AWAY WHILE THE MOTORIZED FRONT PANEL OR MOVING MONITOR IS IN MOTION.

Failure to do so may result in personal injury or damage to the product.

PRECAUTIONS

Product Cleaning

Use a soft dry cloth for periodic cleaning of the product. For more severe stains, please dampen the cloth with water only. Anything else has the chance of dissolving the paint or damaging the plastic.

Temperature

Be sure the temperature inside the vehicle is between +45°C (+113°F) and 0°C (+32°F) before turning your unit on.

Moisture Condensation

You may notice the disc playback sound wavering due to condensation. If this happens, remove the disc from the player and wait about an hour for the moisture to evaporate.

Damaged Disc

Do not attempt to play cracked, warped, or damaged discs. Playing a bad disc could severely damage the playback mechanism.

Maintenance

If you have problems, do not attempt to repair the unit yourself. Return it to your Alpine dealer or the nearest Alpine Service Station for servicing.

Never Attempt the Following

Do not grip or pull out the disc while it is being pulled back into the player by the automatic reloading mechanism.

Do not attempt to insert a disc into the unit when the unit power is off.

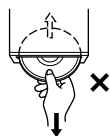

Inserting Discs

Your player accepts only one disc at a time for playback. Do not attempt to load more than one disc.

Make sure the label side is facing up when you insert the disc. "DISC ERROR" will be displayed on your player if you insert a disc incorrectly. If "DISC ERROR" continues to be displayed even though the disc has been inserted correctly, push the RESET switch with a pointed object such as a ballpoint pen.

Playing a disc while driving on a very bumpy road may result in skips, but this will not scratch the disc or damage the player.

Irregular Shaped Discs

Be sure to use round shaped discs only for this unit and never use any special shaped discs.

Use of special shaped discs may cause damage to the mechanism.



New Discs

To prevent the CD from jamming, "DISC ERROR" is displayed if discs with irregular surfaces are inserted or if discs are inserted incorrectly. When a new disc is ejected immediately after initial loading, use your finger to feel around the inside of the centre hole and outside edge of the disc. If you feel any small bumps or irregularities, this could inhibit proper loading of the disc. To remove the bumps, rub the inside edge of the hole and outside edge of the disc with a ballpoint pen or other such instrument, then insert the disc again.

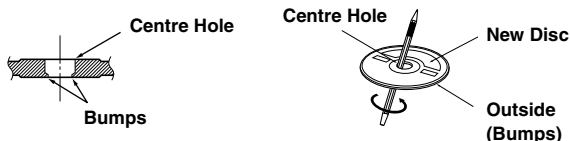

Installation Location

Make sure the IVA-W502E will not be installed in a location subjected to:

- Direct sun and heat
- High humidity and water
- Excessive dust
- Excessive vibrations

Correct Handling

Do not drop the disc while handling. Hold the disc so you will not leave fingerprints on the surface. Do not affix tape, paper, or gummed labels to the disc. Do not write on the disc.

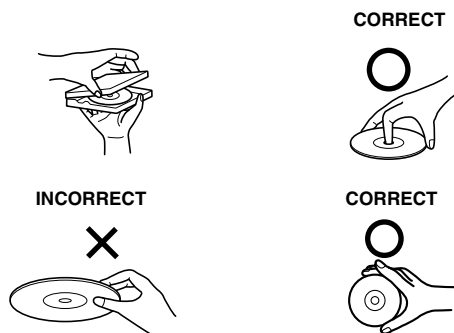

Disc Cleaning

Fingerprints, dust, or soil on the surface of the disc could cause the DVD player to skip. For routine cleaning, wipe the playing surface with a clean, soft cloth from the centre of the disc to the outer edge. If the surface is heavily soiled, dampen a clean, soft cloth in a solution of mild neutral detergent before cleaning the disc.



Disc Accessories

There are various accessories available on the market for protecting the disc surface and improving sound quality. However, most of them will influence the thickness and/or diameter of the disc. Using such accessories can cause operational problems. We recommend not using these accessories on discs played in Alpine DVD players.

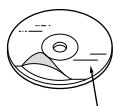

Transparent Sheet

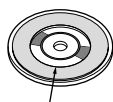

Disc Stabilizer

- After turning the system off, a slight ghost of the image will remain temporarily. This is an effect peculiar to LCD technology and is normal.
- In cold temperature conditions, the screen may lose contrast temporarily. After a short warm-up period, it will return to normal.

Alpine products equipped with the Ai-NET bus, connected to the IVA-W502E, can be operated from the IVA-W502E. Depending on the products connected, the functions and displays will vary. For details, consult your Alpine dealer.

Operation of some of the functions of this unit is very complex. Because of this, it was deemed necessary to place these functions into a special screen. This will restrict operation of these functions to times when the vehicle is parked. This ensures the focus of the driver's attention will be on the road and not on the IVA-W502E. This has been done for the safety of the driver and passengers. Audio Processor Adjustments cannot be made if the car is moving. The car must be parked and the parking brake must be engaged for the procedure described in the Owner's Manual to be valid. The warning "CAN'T OPERATE WHILE DRIVING" will be displayed if any attempts are made to perform these operations while driving.

- *The IVA-W502E draws minimal current even when its power switch is turned off. If the switched power (ignition) lead of the IVA-W502E is connected directly to the positive (+) post of the vehicle's battery, the battery may be discharged.*
An SPST (Single-Pole, Single-Throw) switch (sold separately) can be added to simplify this procedure. Then, you can simply place it in the OFF position when you leave the vehicle. Turn the SPST switch back ON before using the IVA-W502E. For connecting the SPST switch, refer to the "(If the ACC power supply is not available)" (page 74). If the power (ignition) lead is unswitched, it must be disconnected from the battery post should the vehicle be left unused for an extended period of time.

Discs Playable on This Unit

Playable Discs

The discs listed below can be played on this unit.

	Mark (logo)	Recorded Content	Disc size
DVD Video		Audio + Video	12 cm*
			8 cm
DVD Audio		Audio + Video	12 cm*
			8 cm
Video CD		Audio + Video	12 cm
			8 cm
Music CD		Audio	12 cm
			8 cm (CD single)
DivX®		Audio + Video	12 cm
			8 cm

* Two-layer DVD disc compatible

The formatted discs listed below can be played on this unit.

	CD-R/ CD-RW	DVD-R/ DVD-RW	DVD+R/ DVD+RW
CD Format	○		
MP3 Format ("mp3")	○	○	○
WMA Format ("wma")	○	○	○
AAC Format ("aac", "m4a")	○	○	○
DVD Video Format		○	○
DVD-VR Format		○	
DivX Format ("avi", "divx")	○	○	○
Video CD Format	○		

- Discs that are not finalised cannot be played back.

Discs that cannot be played

DVD-ROMs, DVD-RAMs, CD-ROMs (excluding MP3/WMA/AAC files), photo CDs, etc.

DualDisc

This unit is not compatible with DualDisc.

Using a DualDisc may cause unit malfunction, and may cause disc damage when the disc is inserted/ejected.

DVD region number (playable region number)

Refer to the attached card, "TO CUSTOMERS" for the playable DVD region number for this DVD player.

Video CDs

This DVD head unit is compatible with playback control (PBC) compatible Video CDs (version 2.0).

"PBC" is a function by which you can use menu screens recorded on the disc to find the scene you want to watch and view various types of information in dialog style.

Using compact discs (CD/CD-R/CD-RW)

If you use unspecified compact discs, correct performance cannot be guaranteed.

You can play CD-Rs (CD-Recordables)/CD-RWs (CD-ReWritables) which have been recorded only on audio devices. You can also play CD-Rs/CD-RWs containing MP3/WMA/AAC formatted audio files.

- Some of the following discs may not play on this unit:
Flawed discs, discs with fingerprints, discs exposed to extreme temperatures or sunlight (e.g., left in the car or this unit), discs recorded under unstable conditions, discs on which a recording failed or a re-recording was attempted, copy-protected CDs which do not conform to the audio CD industry standard.
- Use discs with MP3/WMA/AAC files written in a format compliant with this unit. For details, see pages 16 and 17.

To customers using CD-R/CD-RW

- If a CD-R/CD-RW cannot be played back, make sure the last recording session was closed (finalised).
- Finalise the CD-R/CD-RW if necessary, and attempt playback again.

Tips for making your own CDs

The IVA-W502E plays DVD Video, DVD Audio, Video CD, Audio CD and has a built in MP3/WMA/AAC decoder.

The following information is designed to help you create your own music CDs (either Audio CD or MP3/WMA/AAC encoded CD-R/RW files).

What is the difference between an Audio and MP3/WMA/AAC CD?

An Audio CD is the same format as the commercial CDs you buy in the store (also known as CD-DA). MP3 (MPEG-1 Audio Layer 3)/WMA (Windows Media Audio)/AAC (Advanced Audio Coding) is a data file that uses a compression scheme to reduce the size of the music file*.

Hybrid Audio CD and Data (MP3/WMA/AAC) CD-R/RW discs:

The IVA-W502E can read either sector on the disc. Choose CD-DA to play the CD audio section or MP3/WMA/AAC to play the MP3/WMA/AAC section*.

Multisession CD-R/RW:

Once a recording has been stopped, this is considered one session. If the disc is not closed (finalised), additional data may be added. Once this additional data has been recorded, this becomes a "multisession" CD. The IVA-W502E can only read multisession DATA Formatted discs (MP3/WMA/AAC files - Not Audio CD files).

Properly formatted MP3/WMA/AAC Discs:

Use ISO9660 formatting to insure proper playback. You may use standard ISO naming Level 1 (8.3 DOS standard), Level 2 (32 characters) or Joliet (Windows or Macintosh long filenames) file naming conventions*.

* Please consult the Owner's manual for additional information.

On handling compact discs (CD/CD-R/CD-RW)

- Do not touch the surface.
- Do not expose the disc to direct sunlight.
- Do not affix stickers or labels.
- Clean the disc when it is dusty.
- Make sure that the disc is smooth and flat.
- Do not use commercially available disc accessories.

Do not leave the disc in the car or the unit for a long time. Never expose the disc to direct sunlight.

Heat and humidity may damage the disc and you may not be able to play it again.

Using DVD-Rs/DVD-RWs/DVD+Rs/DVD+RWs

- This unit is compatible with discs recorded in the standard DVD-Video and DVD-VR (DVD-R/DVD-RW only) formats.
- Note that discs not finalised (processed to enable to play on playback-only DVD players) cannot be played on this DVD player.
- Some discs may not play back, depending on the recording device and disc format.
- Discs or files utilizing copy protection, may not be playable.
- Some recording systems may not properly format copied files to enable proper playback.
- In the following cases, the disc may not play on this unit: discs recorded by certain DVD recorders, certain irregular discs, flawed discs, dirty discs, when the pickup lens of this DVD player is dirty, or when moisture condensation has occurred inside the unit.
- Be sure to follow all cautions included with your DVD-Rs/DVD-RWs/DVD+Rs/DVD+RWs discs.
- Do not put stickers, seals, or tape on the label side of DVD-Rs/DVD-RWs/DVD+Rs/DVD+RWs.
- Compared to the regular discs, DVD-Rs/DVD-RWs/DVD+Rs/DVD+RWs are more affected by heat, moisture, and direct sunlight. If left in a car, etc., damage may occur and it might not play on this unit.
- The operable temperature range for disc playback is as follows:
DVD-R/DVD-RW: -25 ~ +70°C
DVD+R/DVD+RW: +5 ~ +55°C

Disc terminology

Title

If titles are programmed for the DVD, these are the largest units of division of the information recorded on the disc.

Chapter

Each Title may also be divided into smaller divisions, called chapters. These can be specific scenes or musical selections.

Protecting the USB connector

- Only an iPod, USB memory or Portable audio player can be connected to the USB connector on this unit. Correct performance using other USB products cannot be guaranteed.
- If the USB connector is used, be sure to use only the supplied connector cable with the unit. A USB hub is not supported.
- Depending on the connected USB memory device, the unit may not function or some functions may not be performed.
- The audio file format that can be played back on the unit is MP3/WMA/AAC.
- Artist/song name, etc., can be displayed, however characters may not be correctly displayed.



CAUTION

Alpine accepts no responsibility for lost data, etc., even if data, etc., is lost while using this product.

On Handling USB Memory

- This unit can control a memory storage device that supports the USB Mass Storage Class (MSC) protocol. Playable audio file formats are MP3, WMA and AAC.
- USB memory function is not guaranteed. Use USB memory according to the terms of agreement. Read the USB memory Owner's Manual thoroughly.
- Avoid usage or storage in the following locations:
 - Anywhere in the car exposed to direct sunlight or high temperatures.
 - Anywhere the possibility of high humidity or corrosive substances are present.
- Fix the USB memory in a location where driver operation will not be hindered.
- USB memory may not function correctly at high or low temperature.
- Use only certified USB memory. Note that even certified USB memory, may not function correctly depending on its type or state.
- Depending on the settings of the USB memory type, memory state or encoding software, the unit may not play back or display properly.
- Files protected by DRM (Digital Rights Management), cannot be played back on this unit. These include AAC formatted files purchased from the iTunes Store and WMA or other files with some form of copyright protection.
- USB memory may take time to start playback. If there is a particular file other than audio in the USB memory, it may take considerable time before the file is played back or searched.
- The unit can play back "mp3," "wma" or "m4a" file extensions.
- Do not add the above extensions to a file other than audio data. This non-audio data will not be recognised. The resulting playback may contain noise that can damage speakers and/or amplifiers.
- It is recommended to back up important data on a personal computer.
- Do not remove the USB device while playback is in progress. Change SOURCE to something other than USB, then remove the USB device to prevent possible damage to its memory.

On Handling Portable audio player

- The unit can control a Portable audio player with the USB interface. Playable audio file formats are MP3 and WMA.
- Portable audio player function is not guaranteed. Use Portable audio player according to the terms of agreement. Read the Portable audio player Owner's Manual thoroughly.
- Avoid usage or storage in the following locations:
 - Anywhere in the car exposed to direct sunlight or high temperatures.
 - Anywhere the possibility of high humidity or corrosive substances are present.
- Fix the Portable audio player in a location where driver operation will not be hindered.
- Portable audio player may not function correctly at high or low temperature.
- Depending on the settings of the Portable audio player type, memory state or encoding software, the unit may not play back or display properly.

- If the Portable audio player has an MSC/MTP setting, set to MTP.
- A Portable audio player in which data is stored by USB Mass Storage may not be playable on the unit.
- Depending on the Portable audio player settings, USB Mass Storage may be supported. For setting, refer to the Owner's Manual of the player.
- The unit can play back MP3/WMA files synchronized by Windows Media Player (Ver. 10 or 11), and are then forwarded to the player. The "mp3" or "wma" extensions are playable.
- If data is not synchronized by Windows Media Player and is forwarded in another way, the unit may not be able to correctly play back the files.
- WMDRM10 is supported by the unit.
- A file that is copy-protected (copyright protection) cannot be played back.
- It is recommended to back up important data on a personal computer.
- Do not remove the USB device while playback is in progress. Change SOURCE to something other than USB, then remove the USB device to prevent possible damage to its memory.

-
- *This product incorporates copyright protection technology that is protected by U.S. patents and other intellectual property rights. Use of this copyright protection technology must be authorized by Macrovision, and is intended for home and other limited viewing uses only unless otherwise authorized by Macrovision. Reverse engineering or disassembly is prohibited.*
 - **Manufactured under license from Dolby Laboratories. Dolby and the double-D symbol are trademarks of Dolby Laboratories.**
 - **Manufactured under license under U.S. Patent #'s: 5,451,942; 5,956,674; 5,974,380; 5,978,762; 6,487,535 & other U.S. and worldwide patents issued & pending. DTS and DTS 2.0 + Digital Out are registered trademarks and the DTS logos and Symbol are trademarks of DTS, Inc. © 1996-2007 DTS, Inc. All Rights Reserved.**
 - **Windows Media and the Windows logo are trademarks, or registered trademarks of Microsoft Corporation in the United States and/or other countries.**
 - **iPod is a trademark of Apple Inc., registered in the U.S. and other countries.**
 - **"MPEG Layer-3 audio coding technology licensed from Fraunhofer IIS and Thomson."**
 - **"Supply of this product only conveys a license for private, non-commercial use and does not convey a license nor imply any right to use this product in any commercial (i.e. revenue-generation) real time broadcasting (terrestrial, satellite, cable and/or any other media), broadcasting/streaming via internet, intranets and/or other networks or in other electronic content distribution systems, such as pay-audio or audio-on-demand applications. An independent license for such use is required. For details, please visit <http://www.mp3licensing.com>"**
 - **Audyssey MultEQ XT is a registered trademark of Audyssey Laboratories Inc.**
 - **L.L.C. (Linear Luminance Control) uses technology provided by  Apical Limited, U.K.**

Getting Started

Accessory List

• Head unit	1
• Power cable.....	1
• Mounting sleeve	1
• Bracket key.....	2
• Flush Head Screw (M5x8)	6
• Screw (M5x8)	8
• Face plate.....	1
• Mounting Position Seal	2
• Pre OUT Cable	1
• AUX I/O Cable	1
• Owner's Manual	1 set

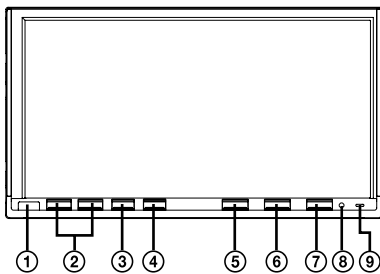

Optional Remote Control Interface Box

This unit is operable using the vehicle's secondary radio controls. An Alpine Remote Control Interface Box (optional) is required. For details, contact your Alpine dealer.

Location of Controls

- 1 Remote Sensor**
Point the optional remote control transmitter towards the remote sensor within a range of 2 meters.
- 2 ∨/∧ button**
Press to adjust the volume.
- 3 MUTE button**
Lowers the volume by 20 dB instantly. Press the button again to cancel.
- 4 * (OPTION) button**
Press to recall the setting which is set in "Setting the VISUAL Soft Button" (page 37).
If "V.SEL" is set, the VISUAL SETUP screen will be recalled.
If "TEL" is set, the TEL Bluetooth screen will be recalled (when the optional Bluetooth Box is connected).
- 5 IMPRINT/AUDIO button**
Press to recall the IMPRINT operation screen (When the optional IMPRINT audio processor (PXA-H100) is connected).
Pressing and holding for at least 2 seconds will recall the AUDIO SETUP screen.
- 6 SOURCE/⏻ button**
Turns the power on. Press and hold for at least 2 seconds to turn the power off.
Recalls the SOURCE selection screen.

- 7 OPEN button**
Ejects a disc.
If the disc does not eject after pressing **OPEN**, press and hold **OPEN** for at least 3 seconds.
- 8 RESET switch**
Be sure to press the RESET switch when using the unit for the first time, after installing the CD changer, after changing the car battery, etc.
Turn off the unit power, press RESET with a ballpoint pen or similar pointed object.
- 9 DISC indicator**
Lights when a disc is inserted into the unit.

About the button descriptions used in this Owner's Manual

- The buttons found on the face of the unit are expressed in bold (e.g. **SOURCE/⏻**). The buttons found on the touch-screen display are shown in bold within brackets, [] (e.g. [**SOURCE**]).
- This Owner's Manual explains mainly the function of soft buttons, when a soft button and a unit button have the same function.

Turning Power On or Off

Some of this unit's functions cannot be performed while the vehicle is in motion. Be sure to stop your vehicle in a safe location and apply the parking brake, before attempting these operations.

- 1 Press SOURCE/⏻ to turn on the unit.**
 - The unit can be turned on by pressing any button on the unit except **OPEN**.
- 2 Press and hold SOURCE/⏻ for at least 2 seconds to turn off the unit.**
 - Some operation of the unit cannot be performed while the vehicle is in motion. In this case, be sure to first stop your vehicle and apply the parking brake, then perform the operation.
 - The IVA-W502E is a precision device. With gentle handling, its unique capabilities can be enjoyed for a long time.

Inserting / Ejecting a Disc

Insert the disc

Press **OPEN**.

The movable monitor will open. Insert a disc into the Disc slot part.

Inserting a disc will close the monitor automatically.

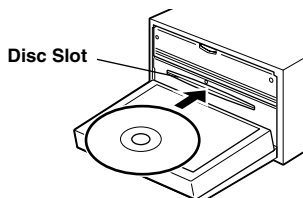

Eject the disc

Press **OPEN** again.

Disc is ejected.

- Do not apply shock to the movable monitor when it is open as it may result in malfunction of the unit.
- The monitor may be dim during low temperature and immediately after turning on the power. The brightness will return to normal as time elapses.
- The monitor will stop at the set tilt angle when closing.

CAUTION

Keep hands (or any other object) away from the monitor while it is opening or closing to avoid damage or injury. The back of the movable monitor will get very warm under normal operating conditions. This is not a malfunction. Do not touch.

Adjusting the Monitor Viewing Angle

Adjust the monitor's angle for better visibility.

- 1 Touch [SETUP] for the selected source on the main screen.**
The SETUP selection screen is displayed.
- 2 Touch [DISPLAY SETUP].**
- 3 Touch [▼] or [▲] of TILT to adjust the desired monitor angle.**
Pressing the buttons changes the screen angle by 5 stages.
- 4 Touch [↶] to return to the previous screen.**
 - This function is adjustable while driving.
 - If the monitor touches an obstacle while the angle is being adjusted, the unit stop the screen immediately.
 - The screen colour will vary when viewed at certain angles. Adjust the screen angle for the best viewing position.
 - If the voltage of the vehicle's battery power is low, the screen may blink when the screen angle is changed. This is normal and not a malfunction.
 - Touching and holding [↶] for at least 2 seconds will change to the main source screen.

Adjusting the Volume

Adjust the volume by pressing **∨** or **∧**.

Volume decreases/increases continuously by pressing and holding **∨** or **∧**.

Volume: 0 - 35

Lowering Volume Quickly

Activating the Audio Mute function will instantly lower the volume level by 20 dB.

Press **MUTE** to activate the MUTE mode.

The audio level will decrease by about 20 dB.

Pressing **MUTE** again will bring the audio back to its previous level.

How to view the Display

Soft button operation

- Be sure to touch the button lightly with the pad of your finger on the display to protect the display.
- If you touch a button and there is no reaction, remove your finger from the display, and try again.

About the button descriptions used in this Owner's Manual

- Soft buttons, ones found in the display, are shown in bold enclosed in brackets, [] (e.g. [SOURCE]).
- Whenever a soft button and a head unit button have the same function, the explanations in this Owner's Manual will describe the function of the soft button.

Recalling the Source

Here is an example explanation for the Radio mode display on how to recall a source.

- 1 Touch [SOURCE] on the main screen.**
The SOURCE selection screen is displayed.

Display example for SOURCE selection screen

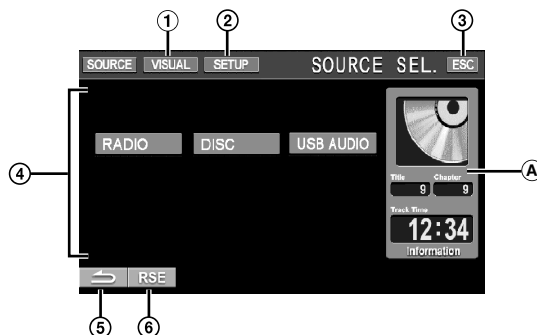

- ① Changes to VISUAL selection screen. Set to VISUAL in "Setting the VISUAL Soft Button" (on page 37).
- ② Changes to SETUP selection screen.
- ③ Changes to main source screen.
- ④ Displays source modes that can be selected (The kind of source modes that are displayed varies depending on connection and setting).

- ⑤ Returns to the previous screen.
- ⑥ Changes to the REAR selection screen when "Setting the Picture Output" (page 36) is set to ON.
- Ⓐ The information about the current source. e.g. The DISC image, Track NO. and Track time will be displayed in DISC mode.

2 Touch [RADIO].

The screen changes to the Radio mode main display.

Display example for FM Radio main screen

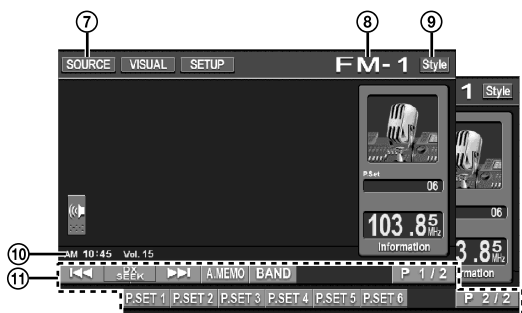

- ⑦ Changes to the SOURCE selection screen (to Step 1 screen)
- ⑧ Displays the source name, such as radio band, etc., that is selected
- ⑨ Changes the display style, refer to "Selecting the Display Style" (on page 13).
- ⑩ Displays time and volume level
- ⑪ Function Guide:
The function guide display varies depending on each source.
The contents of the function guide change by touching [P1/2]*, [P1/3]* or [P1/4]* on the function guide, and many other operations can be performed.

* Display may vary depending on the connected devices.

3 Touch [SOURCE] on the main source screen to change to another source screen, and select the desired source from the SOURCE selection screen.

- After 5 seconds of each operation in the visual mode, the screen changes to the visual screen only.
To display the main source screen, touch the display panel, then touch [ESC] on the screen. The SOURCE selection screen appears by touching [SOURCE] on the changed main source screen.

Displaying the Numeric Keypad Input Screen

The numeric keypad input screen is displayed when the DVD mode is selected for searching a title or chapter. It can also be used for entering a country code or password for DVD setup.

1 Touch [10KEY] on the main source screen.

2 Touch the desired numeric key.

Display example for numeric keypad

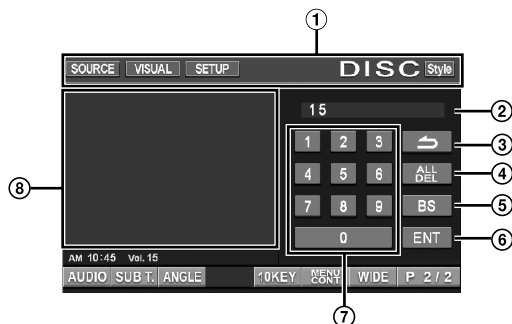

- ① Operation buttons of this area can be used while displaying the numeric keypad input screen.
- ② Input screen area
- ③ Closes numeric keypad input screen
- ④ All input numbers will be deleted
- ⑤ Previous number will be deleted
- ⑥ Input number is confirmed
- ⑦ Numeric keypad
- ⑧ The numeric keypad input screen closes when the area is touched while displayed.

3 Touch [ENT] to confirm your entry.

Selecting the Display Style

You can change the style of display by touching [Style] in normal mode of every source.

Style 1 (Initial) ↔ Style 2

Display example for iPod main screen



- ① Changes to the L .L .C. adjustment screen (Only for visual source) directly, refer to page 38.
- ② Changes to the Bass*¹, Treble*¹ and Subwoofer*² Level adjustment screen
When an optional external audio processor with the MEDIA XPANDER function is connected to this unit and Defeat is set to OFF, MEDIA XPANDER level may be also adjusted directly.
 - If the optional IMPRINT audio processor (PXA-H100) is connected, MultEQ must also be set to OFF to adjust the MEDIA XPANDER directly.

*¹ Adjustment cannot be performed when DEFEAT is set to ON (page 25).

*² Adjustment cannot be performed when SUBWOOFER is set to OFF (page 25).

- ③ Displays the next 5 songs' name (Only for the USB AUDIO and iPod mode).



- Ⓐ Displays the image of the current source.
 - If the playing song contains artwork, the artwork can be displayed in Ⓐ (Only for USB AUDIO*³ and iPod*⁴ mode).

*³ USB memory is connected by using USB connector and only JPEG or BMP (565 formatted only) pictures that are smaller than 80KB can be displayed.

*⁴ iPod is connected by using the USB connector.

Radio

Display example for FM Radio main screen

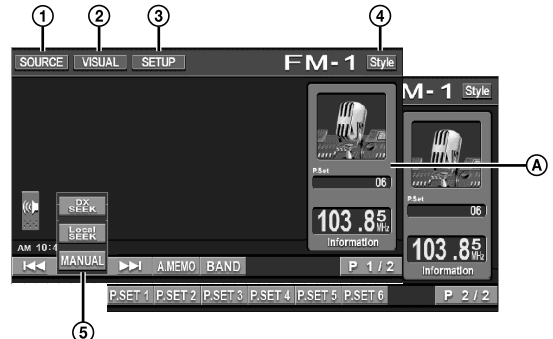

- ① [SOURCE] button: Refer to page 11
 - ② [VISUAL] button: Displays the VISUAL selection screen
 - ③ [SETUP] button: Displays the SETUP selection screen
 - ④ [Style] button: Refer to page 13
 - ⑤ [DX SEEK]* button: Displays the tuning mode selection list.
- Ⓐ Displays the preset number/frequency

Listening to the Radio

- 1 Touch [SOURCE] on the main source screen.
The SOURCE selection screen is displayed.
- 2 Touch [RADIO].
The radio mode is activated and the display changes to the Radio Mode screen.
- 3 Touch [BAND] to select the desired radio band.
Each press changes the bands as follows:
FM-1 → FM-2 → AM → FM-1
- 4 Touch [DX SEEK]* to choose the tuning mode.
DX SEEK Local SEEK MANUAL

- There are two modes you can select for auto tuning, DX and Local:
 - DX (Distance) mode;
Both strong and weak stations will be tuned in.
 - Local mode;
Only strong stations will be tuned in.
The initial setting is DX.

* The button displays the current tuning mode.

- 5 Touch [◀◀], [▶▶] or [◀], [▶] to change the radio frequency up or down respectively.
In manual mode, touch and hold to change the frequency continuously.

Presetting Stations Manually

- 1 Tune in a desired radio station you wish to store in the preset memory by manual or automatic seek tuning.
- 2 Touch **[P1/2]** to change the function guide.
- 3 Touch and hold any one of the preset buttons **[P.SET 1]** through **[P.SET 6]** for at least 2 seconds. The selected station is stored.
- 4 Repeat the procedure to store up to 5 other stations onto the same band.
To use this procedure for other bands, simply select the desired band and repeat the procedure.

A total of 18 stations can be stored in the preset memory (6 stations for each band; FM1, FM2 or AM).

- If a preset memory has already been set in the same preset number; it will be cleared and the new station will be memorized.

Presetting Stations Automatically

The tuner can automatically seek and store 6 strong stations in the selected band in order of signal strength.

After selecting the desired band, touch **[A.MEMO]**.

The tuner automatically seeks and stores 6 strong stations into [P.SET 1] to [P.SET 6] in order of signal strength.

When the automatic storing has been completed, the tuner goes to the station stored in [P.SET 1].

- If no stations are stored, the tuner will return to the original station you were listening to before the automatic storing procedure began.

Tuning to Preset Stations

You can tune in the preset stations in memory on each band using the preset number.

- 1 After selecting the desired band, touch **[P1/2]** to change the function guide.
- 2 Touch any one of the preset buttons **[P.SET 1]** through **[P.SET 6]** that has a station stored to it. The preset station is received.

CD/MP3/WMA/AAC

Display example for MP3/WMA/AAC main screen

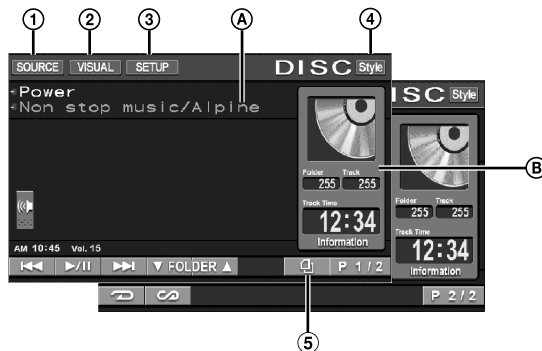

- ① **[SOURCE]** button: Refer to page 11
- ② **[VISUAL]** button: Displays the VISUAL selection screen
- ③ **[SETUP]** button: Displays the SETUP selection screen
- ④ **[Style]** button: Refer to page 13
- ⑤ **[CD]** button: Refer to page 25
- Ⓐ **CD**: Displays the Track text*¹/Disc text*¹

- If there is neither Track nor Disc name information, "NO TEXT" will be displayed.

MP3/WMA/AAC:

After displaying the file name in the upper line, the track name is displayed if there is ID3 tag information.

After displaying the folder name in the lower line, the album name/artist name are displayed if there is ID3 tag information.

- Ⓑ **CD**: Displays the disc number*²/track number/elapsed time.

MP3/WMA/AAC:

Displays the disc number*³/folder number/track number/ elapsed playback time.

*¹ Displayed when a CD text disc is inserted.

*² Displayed when a CD changer is connected.

*³ Displayed when an MP3 compatible CD changer is connected.

Playback

1 Touch [SOURCE] on the main source screen.

The SOURCE selection screen is displayed.

2 Touch [DISC].

The display shows the DISC mode screen.

When a CD/MP3/WMA/AAC is inserted into the DISC SLOT of the IVA-W502E, with the label side facing up, the unit starts to play the CD/MP3/WMA/AAC.

3 Touch [◀◀] or [▶▶] to select the desired track (file).

Returning to the beginning of the current track (file):

Touch [◀◀].

Fast reverse :

Touch and hold [◀◀].

Advancing to the beginning of the next track (file) :

Touch [▶▶].

Fast forward :

Touch and hold [▶▶].

To pause playback

Touch [▶/||].

Touching [▶/||] again will resume playback.

Inserting/Ejecting a Disc

Refer to "Inserting/Ejecting a Disc" (page 11).

- The IVA-W502E model includes a built-in MP3/WMA/AAC unit. You can play CD-ROMs, CD-Rs, and CD-RWs containing MP3/WMA/AAC files on this unit. Use the format compliant with this unit. For further information about playing or storing MP3/WMA/AAC files, refer to pages 16 and 17 before using the unit.
- WMA format files that are protected by DRM (Digital Rights Management), AAC format files that have been purchased from iTunes Music Store and files that are copy-protected (copyright protection) cannot be played back on this unit.
- The unit can play discs containing both audio data and MP3/WMA/AAC data.
- The track display for CD audio data playback is the track numbers recorded on the disc.
- Three-inch (8 cm) CDs can be used.
- "Playing MP3/WMA/AAC Data (FILE PLAY MODE)" is mentioned on page 31.
- If an MP3/WMA/AAC disc with many files and folders is played, it takes a little longer than normal to start playback.
- Touch [🔍] to activate the search mode. For operations, refer to "Search Function" on page 25. However, the search mode function does not work in the CD changer mode.
- The playback time may not be correctly displayed when a VBR (Variable Bit Rate) recorded file is played back.

Repeat Play

Touch [↺] to play back repeatedly the track currently being played.

The track (file) will be played repeatedly.

Touch [↺] again and select OFF to deactivate Repeat play.

CD: RPT → RPT DISC*¹ → (off) → RPT

MP3/WMA/AAC:

- 1 Touch [P1/2]*³ to change the function guide.
- 2 Touch [↺] and select the desired Repeat play.

RPT → RPT FLDR*² → RPT DISC*¹ → (off) → RPT

*¹ If a CD Changer or an MP3 compatible CD changer is connected and the RPT DISC mode is selected, the unit repeatedly plays back all tracks (files) on the disc selected.

*² Only files in a folder are repeatedly played back.

*³ Display may vary depending on the connected devices.

M.I.X. (Random Play)

Touch [🎲] during playback.

The tracks (files) on the disc will be played back in a random sequence.

To cancel M.I.X. play, touch [🎲].

CD: M.I.X. → M.I.X. ALL*¹ → (off) → M.I.X.

MP3/WMA/AAC:

- 1 Touch [P1/2]*⁴ to change the function guide.
- 2 Touch [🎲] and select the desired M.I.X. play.

M.I.X. FLDR*³ → M.I.X.*² → (off) → M.I.X. FLDR*³

*¹ If a CD Changer equipped with the M.I.X. ALL function is connected, M.I.X. ALL will also be selectable.

In this mode, the tracks on all the CDs in the current magazine will be included in the random playback sequence.

*² If an MP3 compatible CD changer is connected, all files in a disc are played back in random sequence, and playback shifts to the next disc.

*³ Only files in a folder are played back in random sequence in the M.I.X. FLDR mode.

*⁴ Display may vary depending on the connected devices.

• If the search mode (page 25) is activated, the M.I.X. play mode will be cancelled.

Selecting Folders (concerning MP3/WMA/AAC)

Touch FOLDER [▼] or [▲] to select the folder.

About MP3/WMA/AAC

CAUTION

Except for private use, duplicating audio data (including MP3/WMA/AAC data) or distributing, transferring, or copying it, whether for free or for a fee, without permission of the copyright holder is strictly prohibited by the Copyright Act and by international treaty.

What is MP3?

MP3, whose official name is "MPEG-1, 2, 2.5 Audio Layer 3", is a compression standard prescribed by the ISO, the International Standardization Organization and MPEG which is a joint activity institution of the IEC.

MP3 files contain compressed audio data. MP3 encoding is capable of compressing audio data at extremely high ratios, reducing the size of music files to as much as one-tenth their original size. This is achieved while still maintaining near CD quality. The MP3 format realizes such high compression ratios by eliminating the sounds that are either inaudible to the human ear or masked by other sounds.

What is AAC?

AAC is the abbreviation for "Advanced Audio Coding", and is a basic format of audio compression used by MPEG2 or MPEG4.

What is WMA?

WMA, or "Windows Media™ Audio," is compressed audio data. WMA is similar to MP3 audio data and can achieve CD quality sound with small file sizes.

Method for creating MP3/WMA/AAC files

Audio data is compressed using software with MP3/WMA/AAC codecs. For details on creating MP3/WMA/AAC files, refer to the user's manual for that software.

MP3/WMA/AAC files that are playable on this device have the file extensions.

MP3: "mp3"

WMA: "wma" (ver. 7.1, 8, 9, 9.1 and 9.2 are supported)

AAC: "m4a"

WMA is not supported for the following files, Windows Media Audio Professional, Windows Media Audio 9 Voice or Windows Media Audio 9 Pro Lossless.

There are many different versions of the AAC format. Confirm that the software being used conforms to the acceptable formats listed above. It's possible that the format may be unplayable even though the extension is valid.

Playback of AAC files encoded by iTunes is supported.

Supported playback sampling rates and bit rates

MP3

Sampling rates: 48 kHz, 44.1 kHz, 32 kHz, 24 kHz, 22.05 kHz, 16 kHz, 12 kHz, 11.025 kHz, 8 kHz

Bit rates: 32 - 320 kbps

WMA

Sampling rates: 48 kHz, 44.1 kHz, 32 kHz

Bit rates: 48 - 192 kbps

AAC

Sampling rates: 48 kHz, 44.1 kHz, 32 kHz, 24 kHz, 22.05 kHz, 16 kHz, 12 kHz, 11.025 kHz, 8 kHz

Bit rates: 16 - 320 kbps

This device may not play back correctly depending on sampling rates.

ID3 tags/WMA tags

If tag data is in an MP3/WMA/AAC file, this device can display the title (track title), artist name, and album name ID3 tag/WMA tag data (maximum 128 characters).

This device can only display single-byte alphanumeric characters and the underscore. For non-supported characters, "NO SUPPORT" is displayed.

The number of characters may be limited, or not correctly displayed, depending on the tag information.

Playing back MP3/WMA/AAC

MP3/WMA/AAC files are prepared, then written to a CD-R, CD-RW (DVD-R/DVD-RW) using CD-R writing software. A disc can hold up to 1024 files/256 folders (including Root Folders), and the maximum number of folders is 255. Playback may not be performed if a disc exceeds the limitations described above.

Media supported

The media that this device can play back are CD-ROMs, CD-Rs, and CD-RWs, DVD-Rs and DVD-RWs.

Corresponding File Systems

This device supports discs formatted with ISO9660 Level 1 or Level 2.

Under the ISO9660 standard, there are some restrictions to remember.

The maximum nested folder depth is 8 (including the root directory). The number of characters for a folder/file name is limited.

Valid characters for folder/file names are letters A-Z (all caps), numbers 0-9, and '_' (underscore).

This device can play back discs in Joliet, Romeo, etc., and other standards that conform to ISO9660. However, sometimes the file names, folder names, etc., are not displayed correctly.

Formats supported

This device supports CD-ROM XA, Mixed Mode CD, Enhanced CD (CD-Extra) and Multi-Session.

This device cannot correctly play back discs recorded with Track At Once or packet writing.

Order of files

Files are played back in the order that the writing software writes them to the disc. Therefore, the playback order may not be what's expected. Verify the writing order in the software's documentation. The playback order of the folders and files is as follows. (The following numbers may differ from actually displayed numbers.)

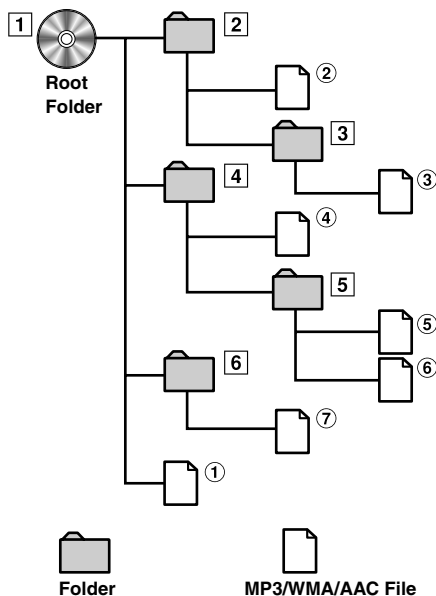

Terminology

Bit rate

This is the “sound” compression rate specified for encoding. The higher the bit rate, the higher the sound quality, but also the larger the files.

Sampling rate

This value shows how many times per second the data is sampled (recorded). For example, music CDs use a sampling rate of 44.1 kHz, so the sound is sampled (recorded) 44,100 times per second. The higher the sampling rate, the higher the sound quality, but also the larger the volume of data.

Encoding

Converting music CDs, WAVE (AIFF) files, and other sound files into the specified audio compression format.

Tag

Song information such as track titles, artist names, album names, etc., written into MP3/WMA/AAC files.

Root folder

The root folder (or root directory) is found at the top of the file system. The root folder contains all folders and files. It is created automatically for all burned discs.

DVD/Video CD

Display example for DVD Video main screen



- ① [SOURCE] button: Refer to page 11
 - ② [VISUAL] button: Displays the VISUAL selection screen
 - ③ [SETUP] button: Displays the SETUP selection screen
 - ④ [Style] button: Refer to page 13
 - Ⓐ Displays the disc (DVD VIDEO, DVD AUDIO, PROGRAM/PLAYLIST (DVD-VR), VIDEO CD) being played back.
Displays tag information for DivX®.
 - Ⓑ Displays the title number/chapter number/elapsed playback time for a DVD Video.
Displays the group number/track number/elapsed playback time for a DVD Audio.
Displays the programme or playlist number/chapter number/elapsed playback time for a DVD-VR.
Displays the track number/elapsed playback time for a Video CD (When PBC is turned off).
Displays the folder number/file number/elapsed playback time for a DivX®.
- If [] on the DivX® mode screen is touched, the search list screen is displayed. Refer to “Search Function” (page 25).
 - Some operations cannot be carried out depending on the disc or playback screen.
 - Displays of the function guide [P1/2], etc., may vary depending on the connected device(s).

Disc types that can be used for each heading are represented by the following marks.

- (DVD-V)** DVD Commercial Video discs (used for the distribution of movies, etc.) or a DVD-R/DVD-RW, DVD+R/DVD+RW recorded in a video mode can be used.
(Including a disc recorded with both DVD video and DVD audio data, played back when “VIDEO” is set in “Setting of the DVD-Audio Playback Mode” (page 31).
- (DVD-A)** DVD Commercial Audio discs can be used.
- (DVD-VR)** DVD-R/DVD-RW discs recorded in DVD-VR mode can be used.
- (VCD)** Video CD discs can be used.
- (DivX)** CD-R/CD-RW/DVD-R/DVD-RW/DVD+R/DVD+RW discs that are recorded in the DivX® mode can be used.

Playing a Disc



IVA-W502E has a built-in DVD player. When an optional Alpine DVD/Video CD/CD player (or DVD changer) is connected to the IVA-W502E, you can control it from the IVA-W502E (except some operations).

WARNING

It is dangerous (and illegal in many states) for the driver to watch the DVD/TV/Video while driving the vehicle. The driver may be distracted from looking ahead and an accident could occur.

Install the IVA-W502E correctly so that the driver cannot watch DVD/TV/Video unless the vehicle is stopped and the emergency brake is applied.

If the IVA-W502E is not installed correctly, the driver will be able to watch the DVD/TV/Video while driving the vehicle and may be distracted from looking ahead causing an accident. The driver or other people could be severely injured.

To display the DVD mode screen



- If you try to activate the auxiliary device while driving, the display will show the warning-**PICTURE OFF FOR YOUR SAFETY**.

Caution

- **Not all functions will operate for every DVD. See the individual DVD's instructions for details on the features supported.**
- **Fingerprints on a disc may adversely affect playback. If a problem occurs, remove the disc and check for fingerprints on the playback side. Clean the disc if necessary.**
- **If you switch the power or Ignition key OFF or change sources during playback, playback will continue where you left off when you resume playback.**
- **If you try to perform an invalid operation (based on the type of disc being played), the following mark is displayed on the monitor screen:**

- **Play Position Memory Function**
Even if you turn power off or switch the Ignition key to OFF during playback or change the source, playback will continue from the point where playback stopped when the power is turned ON again.

1 Touch [SOURCE] on the main source screen.

The SOURCE selection screen is displayed.

2 Touch [DISC].

The display shows the DISC mode screen.

Insert a disc with the label side facing up. The unit starts to play the disc.

When an optional Alpine DVD player is connected:

Insert a disc into the DVD/Video CD/CD player, the player starts playing.

- *The operation screen changes to the visual screen in the DVD or Video CD mode for 5 seconds after an operation has been performed. Touch the display panel to display the operation screen again.*
- *The display mode can be changed by touching [WIDE]. For operation, see "Switching Display Modes" on page 26.*

To eject the disc

Press **OPEN**.

- *The reverse side of a double-sided DVD will not be played automatically. Remove the disc, turn it over, and reinsert it.*
- *Do not insert discs containing maps for the navigation system. Doing so could result in damage.*
- *Refer also to "DVD Setup" (pages 27 to 32).*
- *Be sure the remote input lead is connected to the remote output lead of this unit when a DVD changer or DVD player is connected. If not correctly connected, touch operation cannot be performed.*
- *To return to the previous screen during Video CD playback (when PBC is set to ON), touch [] after touching [P1/2] of the function guide. However, the function may vary depending on the disc.*
- *"CAN'T DOWNMIX" is displayed when a Downmix (multi-channel signals are mixed into 2ch) prohibited section of a DVD-Audio disc is played. In this case, only the Lch/Rch recorded on the disc is output as sound. (The sound of Centre speaker, L-surround speaker, R-surround speaker, and Subwoofer is not output.)*
- *While "INDEX READING" is displayed by DivX[®], the fast-forwarding/fast-reversing and repeat functions, etc. cannot be used.*

If a menu screen appears

On DVDs and Video CDs with playback control (PBC), menu screens may appear automatically. If this happens, perform the operation described below to start playback.

- *To play back a DVD-Audio disc, set "VCAP" in "Setting of the DVD-Audio Playback Mode" (page 31).*

Direct Menu Operations

- 1 Touch the DVD menu directly.
 - *Some operations cannot be performed depending on the disc.*

Menu Operations DVD-V DVD-A



- 1 Touch [KEY].
The menu operation mode will be displayed.

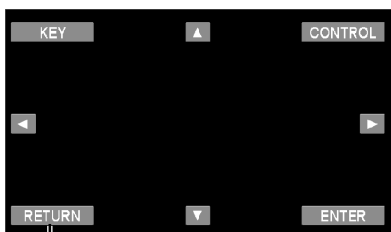

Touch [RETURN] to return to the previous display.

- 2 Select a desired menu item by touching [▲], [▼], [◀] or [▶].
- 3 Touch [ENTER] to confirm the selected item.

Numeric Keypad Input Operations DVD-V DVD-A



- 1 Touch [KEY].
The menu operation mode appears.
- 2 Touch [KEY] again.
The numeric keypad input mode screen appears.

The numeric keypad input screen closes when the area is touched while displayed.



Touch [↵] to close the numeric keypad input screen.

- 3 Touch a desired number.
- 4 Touch [ENT] on the numeric keypad mode screen to confirm your selection.

Numeric Keypad Input Operations VCD

When PBC is turned OFF, the menu screen is not displayed. Turn it ON to display the screen. (See “Setting the Video CD Play Mode” on page 32.)

- 1 Touch [P1/2] in the Video CD mode to change the function guide.
- 2 Touch [10KEY].
The numeric keypad is displayed.
- 3 Touch and input a desired number.
- 4 Touch [ENT] to confirm.

Displaying the Top Menu Screen

DVD-V DVD-A

When a DVD contains two or more titles, the top menu screen appears.

Touch [TOP MENU] on the DVD mode main screen.

The top menu screen appears.

- To perform necessary operations, see “If a menu screen appears” on page 18.
- To play back a DVD-Audio disc, set “VCAP” in “Setting of the DVD-Audio Playback Mode” (page 31).

Displaying the Menu Screen DVD-V

With a DVD having two or more menus, a menu screen will appear for the programmes available, in addition to the main programmes.

Touch [MENU] on the DVD mode main screen.

The menu screen appears.

- To perform necessary operations, see “If a menu screen appears” on page 18.

Displaying the Menu Operation Mode Screen DVD-V DVD-A

1 Touch [P1/2]* on the DVD mode main screen.

The function guide changes.

* Touch [P1/3] to play back the DVD-Audio disc.

2 Touch [MENU CONT].

The menu operation mode screen appears.

- For further operation, see “If a menu screen appears” on pages 18.
- To play back a DVD-Audio disc, set “VCAP” in “Setting of the DVD-Audio Playback Mode” (page 31).

Searching by Programme (DVD-VR)

- 1 Touch **[TOP MENU]** on the DVD mode main screen while playing a DVD-VR disc.
The programme search list screen is displayed.
- 2 Touch **[▶]** of the programme you want to play.
The selected programme is played back, and then returns to the DVD mode main screen.

Searching by Playlist (DVD-VR)

- 1 Touch **[MENU]** on the DVD mode main screen while playing DVD-VR disc.
The playlist search list screen is displayed.
 - 2 Touch **[▶]** of the playlist you want to play.
The selected playlist is played back, and then returns to the DVD mode main screen.
- Only discs containing a Playlist can be operated.

Stopping Playback (PRE STOP)

(DVD-V) (DVD-A) (DVD-VR) (VCD) (DivX)

Press the stop button during playback to stop playback. That position is stored in the memory.

- 1 Touch **[■]** once during playback.
"PRE STOP" is displayed.
 - 2 Touch **[▶/||]** in the PRE STOP mode.
Playback starts from the position at which it was stopped.
- For some discs, the position at which playback was stopped may not be accurate.
 - To play back a DVD-Audio disc, set "VCAP" in "Setting of the DVD-Audio Playback Mode" (page 31).

Stopping Playback

(DVD-V) (DVD-A) (DVD-VR) (VCD) (DivX)

Touch **[■]** twice or touch and hold **[■]** for at least 2 seconds during playback.

"STOP" is displayed, and playback stops.

- Playback starts from the beginning when **[▶/||]** is touched while playback is stopped.

Fast-forwarding/Fast-reversing

(DVD-V) (DVD-A) (DVD-VR) (VCD) (DivX)

DVD-Video, DVD-VR, Video-CD, DVD-Audio (VCAP mode)*, DivX®:

- 1 During playback, touch and hold **[◀◀◀]** (Fast-reverse) or **[▶▶▶]** (Fast-forward).

When touched and held for more than 1 second, the disc is forwarded/reversed at double speed. When held for 5 more seconds or longer, the disc is forwarded/reversed at 8 times the normal speed. When held for 10 seconds or longer, the disc is forwarded/reversed at 21 times the normal speed.

DVD-Audio (VOFF mode)*:

- 1 During playback, touch and hold **[◀◀◀]** (Fast-reverse) or **[▶▶▶]** (Fast-forward).

- 2 Stop touching **[◀◀◀]** or **[▶▶▶]** to return to normal playback.

* When "VCAP" or "VOFF" is set in "Setting of the DVD-Audio Playback Mode" (page 31).

- No sound is played back during fast-forwarding/fast-reversing.
- For DVDs and Video CDs with playback control (PBC), the menu screen may reappear during fast-forwarding/fast-reversing.
- This operation may not be possible on certain discs.

Finding the Beginnings of Chapters/Tracks/Files

(DVD-V) (DVD-A) (DVD-VR) (VCD) (DivX)

During playback, touch **[◀◀◀]** or **[▶▶▶]**.

The chapter/track/file switches each time the button is touched, and playback of the selected chapter/track/file starts.

[▶▶▶]: Touch this to start playback from the beginning of the following chapter, track or file.

[◀◀◀]: Touch this to start playback from the beginning of the current chapter, track or file.

- Some DVDs do not have chapters.
- Be sure to turn PBC off before starting the search. (See "Setting the Video CD Play Mode" on page 32.)

Supplementary explanations

"Chapters" are divisions of movies or musical selections on DVDs.

"Tracks" are divisions of movies or musical selections on Video CD, DVD Audio and music CDs.

"Group" associates a track (one song) with other tracks stored on a DVD-Audio.

Group playback differs, depending on the disc.

"Playlist" specifies a range of images and their playback order.

Only discs containing a Playlist can be used.

Playing Still Frames (Pausing)

DVD-V DVD-A DVD-VR VCD DivX

1 During playback, touch [▶/II].

2 Touch [▶/II] to resume playback.

- No sound is played during the still frame mode.
- The image or sound may stop temporarily when playback starts from the pause mode. This is not a malfunction.

Forward/reverse frame-by-frame Playback

DVD-V DVD-VR VCD

1 In the pause mode, touch [◀◀] or [▶▶].

The picture advances or reverses by one frame each time the button is touched.

2 Touch [▶/II] to return to normal mode.

- No sound is output during forward/reverse frame-by-frame playback.
- Reverse frame-by-frame cannot be carried out on the DVD-VR and Video CD.

Slow Motion Playback

DVD-V DVD-VR VCD

1 When [◀◀] or [▶▶] is touched and held while in the pause mode, the 1/8th speed slow motion playback mode is set.

When held in for 5 more seconds, the slow motion speed switches to 1/2 the normal speed.

2 Stop touching [◀◀] or [▶▶] to pause, and touch [▶/II] to play back.

- No sound is played during slow motion playback.
- Reverse slow motion playback is not available on the DVD-VR and Video CD.
- 1/2, 1/8 are approximate speeds. The actual speed differs from disc to disc.

Selecting Programme (SKIP)

DVD-VR

1 Touch [P1/3] twice while playing a DVD-VR disc. The PROGRAM function guide is displayed.

2 Touch PROGRAM* [▼] or [▲] to select a programme.

- * To switch the function guide display PLAYLIST [▼] or [▲] to PROGRAM [▼] or [▲], play back the programme. For details, refer to "Searching by Programme" (page 20).

Selecting Playlist (SKIP)

DVD-VR

1 Touch [P1/3] twice while playing a DVD-VR disc. The PLAYLIST function guide is displayed.

2 Touch PLAYLIST* [▼] or [▲] to select a playlist.

- * To switch the function guide display PROGRAM [▼] or [▲] to PLAYLIST [▼] or [▲], play back the playlist. For details, refer to "Searching by Playlist" (page 20).

Selecting Folders

DivX

Touch FOLDER [▼] or [▲] to select the folder.

Repeat Playback

DVD-V DVD-A DVD-VR VCD DivX

Use this function to play the disc's titles, chapters or tracks, etc., repeatedly.

DVD Video

Touch [↺].

The repeat mode switches every time the button is touched.

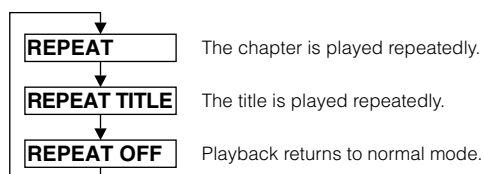

- Display may vary depending on the connected devices.
- The REPEAT mode is always turned off when [↺] is touched and held for at least 2 seconds.

Video CD

During playback, touch [↺].

The repeat mode switches every time the button is touched.

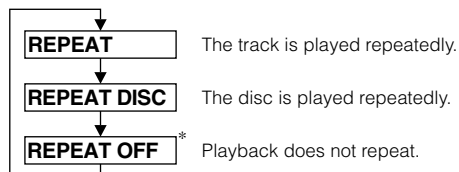

- * Displayed only in the changer mode.
- Display may vary depending on the connected devices.
 - The track/disc repeat modes cannot be used on Video CDs with playback control (PBC). These modes can be carried out after turning PBC off. See "Setting the Video CD Play Mode" on page 32.
 - For some discs it is not possible to switch the repeat mode.

DVD Audio

Touch [].

The repeat mode switches every time the button is touched.

VCAP mode*¹:

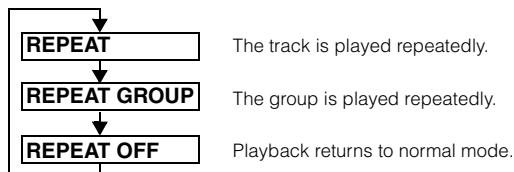

VOFF mode*¹:

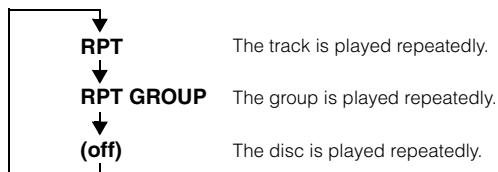

*¹ When "VCAP" or "VOFF" is set in "Setting of the DVD-Audio Playback Mode" (page 31).

DVD-VR

Touch [].

The repeat mode switches every time the button is touched.

The Programme mode*²:

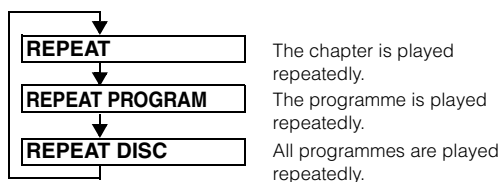

The Playlist mode*²:

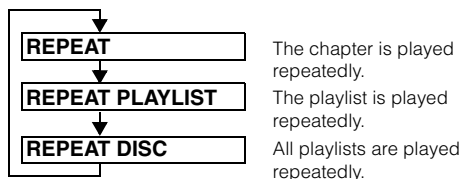

*² To switch the Programme mode display to the Playlist mode display on the DVD mode main screen, play back via programme or playlist search. Refer to "Searching by Programme" or "Searching by Playlist" (page 20).

- Only discs containing a Playlist can be displayed.

DivX®

1 During playback, touch [P1/2].

The function guide changes.

2 Touch [].

The repeat mode switches every time the button is touched.

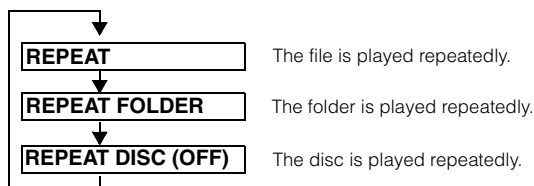

- The REPEAT mode is always turned off when [] is touched and held for at least 2 seconds.

Searching by Title/Group/Programme/Playlist/Folder Number



Use this function to easily find positions on the DVD using the DVD's titles, groups, programmes or playlists.

1 Touch [P1/2]* while playback is stopped.

The function guide appears.

- * Touch [P1/3] while playing a DVD-Audio or DVD-VR disc.

2 Touch [10KEY].

The numeric keypad input mode screen appears.

3 Enter a desired title, group, programme or playlist by touching its title, group, programme or playlist number.

See page 19 for operation of the numeric keypad.

4 Confirm your selection by touching [ENT].

Playback will start from the title number selected.

- To switch the Programme mode display to the Playlist mode display on the DVD mode main screen, play back via programme or playlist search. Refer to "Searching by Programme" or "Searching by Playlist" (page 20).
- This function cannot be used on discs on which no title numbers are recorded.
- Playback starts from the beginning of the chapter/track number in the state of PRE STOP.
- Some disc may not accept any operation.

Searching Directly by Chapter, Track or File Number



Use this function to easily move to the beginnings of the chapters, tracks or files on the disc.

1 Touch [P1/2]* in any mode other than stop mode.

The function guide will appear.

- * Touch [P1/3] while playing a DVD-VR disc or DVD-Audio disc.

2 Touch [10KEY].

The numeric keypad input mode screen will appear.

3 Touch and enter the chapter or track number you want to play.

See page 19 for operation of the numeric keypad.

4 Touch [ENT] to confirm your selection.

Playback will start from the selected chapter or track.

- This function is not available for a disc on which chapters or tracks are not stored.
- Be sure to turn PBC off before starting the search. (See "Setting the Video CD Play Mode" on page 32.)
- For a Video CD disc, a track number can be selected even in the stop mode.

Switching the Angle (DVD-V) (DVD-A)

On DVDs in which scenes have been filmed from multiple angles, the angle can be switched during playback.

1 During playback, touch [P1/2]*.

The function guide changes.

* Touch [P1/3] while playing a DVD-Audio.

2 Touch [ANGLE].

The angle switches between the angles recorded on the disc every time the button is touched.

- Some time may be required for the angle to change.
- Depending on the disc, the angle may switch in one of two ways.
 - Seamless: The angle switches smoothly.
 - Non-seamless: When the angle is switched, a still picture is displayed first, after which the angle switches.
- To play back a DVD-Audio disc, set "VCAP" in "Setting of the DVD-Audio Playback Mode" (page 31).

Scroll to Move the Page Forward or Back

(DVD-A)

"Page" is a still image stored on a DVD-Audio disc.

1 Touch [P1/3] twice while playing a DVD-Audio disc in VCAP mode*.

* To play back a DVD-Audio disc when "VCAP" is set in "Setting of the DVD-Audio Playback Mode" (page 31).

2 Touch PAGE [▼] or [▲].

The display switches.

Touch and hold to display the home page.

- For DVD-Audio discs without Pages, depending on the DVD-Audio disc, the "Page" function may not be operable if images are in slide show form.

Switching the Audio Tracks

(DVD-V) (DVD-A) (DVD-VR) (VCD) (DivX)

DVDs with multiplex audio or audio languages allow switching the sound during playback.

1 During playback, touch [P1/2]*¹.

*¹ The display differs according to the disc (mode).

2 Touch [AUDIO].

The sound switches between the alternate audio tracks recorded on the disc every time the button is touched.

- The alternate track selected becomes the default setting every time the power is turned on or the disc is replaced. If the disc does not include that track, the disc's default language is selected instead.
- Not all discs will allow changing the alternate audio tracks during playback. In these cases, select audio tracks from the DVDs menu.
- There may be a delay before the selected alternate track begins to play.

Video CDs or DVD-VR disc with multiplex audio

1 During playback, touch [P1/2]*².

The function guide changes.

*² Touch [P1/3] while playing a DVD-VR disc.

2 Touch [AUDIO]*³.

The left and right channels will be output as shown below, each time the button is touched.

*³ Touch [AUDIO] for at least 2 seconds to switch while playing a DVD-VR disc.

AUDIO LL → AUDIO RR → AUDIO LR → AUDIO LL

Switching the Subtitles (Subtitle Language) (DVD-V) (DVD-A) (DVD-VR) (DivX)

With DVDs on which multiple subtitle languages are recorded, the subtitle language can be switched during playback; moreover, subtitles can be hidden.

1 During playback, touch [P1/2]*.

The function guide changes.

* Touch [P1/3] while playing a DVD-Audio or DVD-VR disc.

2 Touch [SUBT.].

Touching this button repeatedly selects sequentially the subtitle languages recorded on the disc, and then turns the subtitles OFF.

- To play back a DVD-Audio disc, set "VCAP" in "Setting of the DVD-Audio Playback Mode" (page 31).
- There may be a delay before the selected subtitle appears.
- Not all discs will allow changing the subtitles during playback. In these cases, select subtitles from the DVDs menu.
- The subtitle language selected becomes the default setting every time the power is turned on or the disc is replaced. If the disc does not include that language, the disc's default language is selected instead. However, the subtitle language may differ depending on the disc.
- For some discs, the subtitles will be displayed even when this is set to OFF. However, the subtitle language may differ depending on the disc.
- Switches the subtitles ON/OFF while playing a DVD-VR disc.

Switching from the disc menu

DVD-V DVD-A

For some discs, the audio language, angle and subtitles can be switched from the disc menu.

- 1 Touch **[MENU]** or **[TOP MENU]** to display the menu.
 - 2 Select an item to confirm it.
See "If a menu screen appears" on page 18.
- To play back a DVD-Audio disc, set "VCAP" in "Setting of the DVD-Audio Playback Mode" (page 31).

Displaying the Disc Status for DVD/Video CD

DVD-V DVD-A DVD-VR VCD DivX

Use the procedure described below to display the status (title number, chapter number, group number, etc.) of the currently playing DVD or of the currently playing Video CD (track number, etc.) on the monitor.

- 1 During playback, touch the display panel.
The operation menu screen is displayed.
 - 2 Touch **[ESC]** within 5 seconds.
The display status is displayed for 5 seconds.
- To play back a DVD-Audio disc, set "VCAP" in "Setting of the DVD-Audio Playback Mode" (page 31).

About DivX®

DivX® is a codec (software) programme to compress moving images while maintaining image quality using a highly advanced compression ratio and operating speed.

- Official DivX® Certified product
- Plays all versions of DivX® video (including DivX® 5) with standard playback of DivX® media files
- DivX, DivX Certified, and associated logos are trademarks of DivX, Inc. and are used under license

The unit can play back CD-R/CD-RW/DVD-R/DVD-RW/DVD+R/DVD+RW discs that are recorded in the DivX® mode with extension "avi" or "divx".

The optimum size for DivX® disc playback is as follows:

Screen Size: 32 to 720 pixel (horizontal) × 32 to 576 pixel (vertical)

With an aspect ratio other than 16:9, black bars may be displayed on the left and right sides, or at the top and bottom of the screen.

Image bit rate: "average 4 Mbps, Peak 8 Mbps"
Home Theater Profile supported

The following audio recording systems are supported.

MPEG1 Layer II	64 to 384 kbps
MPEG1 Layer III	32 to 320 kbps
MPEG2 Layer III	8 to 160 kbps
MPEG2.5 Layer III	8 to 160 kbps
Dolby Digital	64 to 448 kbps (Max. 5.1ch)

Other Useful Features

Adjusting the Audio

- 1 Touch **[SETUP]** on the main source screen.
The SETUP selection screen is displayed.
- 2 Touch **[AUDIO SETUP]**.
The AUDIO SETUP screen appears.

Display Example for Audio Adjustment Screen

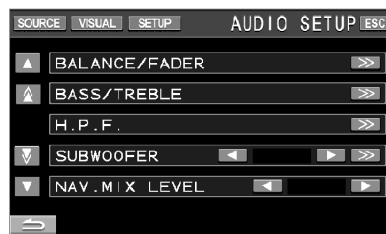

- Touching [**▲**] or [**▼**] will scroll the list one line at a time.
- Touching [**▲**] or [**▼**] will scroll the list one page at a time.
- Touching **[ESC]** will change to the main source screen.
- The A.PROCESSOR menu items will differ depending on which optional audio processor is connected. The IMPRINT audio processor (PXA-H100) or External Audio processors may be used. For details, refer to "IMPRINT Operation (Optional)" (page 46) or "External Audio Processor (Optional)" (page 40).

Adjusting Balance/Fader

Touch **[>>]** of **BALANCE/FADER**, the adjusting screen of **BALANCE/FADER** will be displayed.

Display Example for BALANCE/FADER Screen

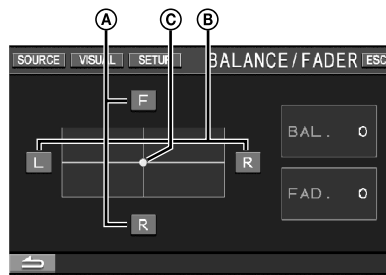

Ⓐ Adjusting the Fader

Touch **[F]** or **[R]** to adjust the volume of the front and rear speakers.

Setting range: F15 to R15

- If an IMPRINT audio processor (PXA-H100) is connected to this unit and you have set the 2.2ch (3WAY)/4.2ch (FRONT/REAR/SUBW.) switch of the IMPRINT audio processor (PXA-H100) to 2.2ch (3WAY), you cannot adjust the FADER. For details, refer to the Owner's Manual of PXA-H100.

Ⓑ Adjusting the Balance

Touch **[L]** or **[R]** to adjust the sound volume of the left and right speakers.

Setting range: L15 to R15

© Adjusting the Balance/Fader Directly

Touch and move [○] to a desired setting.

Or touch a desired setting range, and [○] will move to that location.

Touch [L] or [R] of Balance and [F] or [R] of Fader for fine-tuning.

Turning Defeat ON or OFF

Touch [▼] to display the DEFEAT adjusting screen.

Touch [◀] or [▶] of DEFEAT to set to ON or OFF.

If you set the defeat to ON, MX of an external audio processor is turned OFF and EQ is returned to the initial setting.

Adjusting NAV. MIX Level

Touch [◀] or [▶] of NAV. MIX LEVEL to adjust the volume of navigation interruption.

Setting range: 0 to 15

- This adjustment becomes available when NAV. MIX is turned on in “Setting the Navigation Interruption” (page 36).
- The setting navigation interruption is not displayed if an external audio processor not compatible with NAV. MIX is connected.

Adjusting the Subwoofer Level

Touch [◀] or [▶] of SUBWOOFER to set the subwoofer ON/OFF.

Touch [➤] to display the SUBWOOFER output adjusting screen after setting the SUBWOOFER to ON.

Touch [◀] or [▶] to adjust the SUBWOOFER output.

Setting range: 0 to 15

- When an external processor is connected, the display changes from “SUBWOOFER” to the “SUBW.LV” item. You can change the subwoofer output level between 0 and 15 by touching [◀] or [▶].
- The SUBWOOFER SYSTEM, SUBWOOFER PHASE and SUBWOOFER CHANNEL may be set when an optional IMPRINT audio processor (PXA-H100) is connected, SUBWOOFER is set to ON, and MultEQ OFF mode is selected. For details, refer to “Setting the Subwoofer” on page 50.

Adjusting H.P.F. (Highpass Filter)

Touch [➤] to display the H.P.F. adjusting screen.

Touch [◀] or [▶] of the desired speaker.

Setting range: OFF, 80 Hz, 120 Hz, 160 Hz

- Select OFF when no adjustment is required.
- When an external processor or IMPRINT audio processor (PXA-H100) is connected, the display changes from “H.P.F.” to the “A.PROCESSOR” item. For “A.PROCESSOR” operation, refer to “External Audio Processor (Optional)” on page 40 or “IMPRINT Operation (Optional) on page 46.

Adjusting Bass/Treble

You can change the bass/treble frequency emphasis to create your own tonal preference.

Touch [➤] to display the Bass/Treble adjusting screen.

Touch [▲] or [▼] on the scroll bar to scroll the setup items line by line.

- Adjustment cannot be performed when an external audio processor is connected and DEFEAT is set to ON.

Setting the Bass level

You can emphasize or weaken the bass frequency.

Touch [◀] or [▶] of BASS LEVEL to select the desired bass level.

Setting range: -7 to +7

Setting the Bass Centre Frequency

The displayed bass frequency is emphasized.

Touch [◀] or [▶] of BASS FREQ to select the desired bass centre frequency.

Setting range: 60 Hz, 80 Hz, 100 Hz, 200 Hz

Setting the Bass Bandwidth

Changes the boosted bass bandwidth to wide or narrow.

A wider setting will boost a wide range of frequencies above and below the centre frequency. A narrower setting will boost only frequencies near the centre frequency.

Touch [◀] or [▶] of BASS BANDWIDTH to select the desired bass band width.

Setting range: WIDE1 to WIDE4

- The bass level settings will be individually memorized for each source (FM, AM, CD, etc.) until the setting is changed. The bass frequency and bass bandwidth settings adjusted for one source are effective for all other sources (FM, AM, CD etc.).

Setting the treble level

You can emphasize the treble frequency.

Touch [◀] or [▶] of TREBLE LEVEL to select the desired treble level.

Setting range: -7 to +7

Setting the Treble Centre Frequency

The displayed treble frequency is emphasized.

Touch [◀] or [▶] of TREBLE FREQ to select the desired treble centre frequency.

Setting range: 10 kHz, 12.5 kHz, 15 kHz, 17.5 kHz

- The treble level settings will be individually memorized for each source (FM, AM, CD, etc.) until the setting is changed. The Treble frequency settings adjusted for one source are effective for all other sources (FM, AM, CD, etc.).

Setting the Loudness

Loudness introduces a special low- and high-frequency emphasis at low listening levels. This compensates for the ear's decreased sensitivity to bass and treble sound.

Touch [◀] or [▶] of LOUDNESS to set to ON or OFF.

Search Function

- 1 Touch [□] on the function guide while in the CD, MP3/WMA/AAC or DivX® mode.

Search list screen is displayed.

Select a desired track or folder

Touch [▶] for direct playback.

When a hierarchical list is prepared, [➤] will be displayed. Touch [➤] to display the respective hierarchy list screens.

Display Example for Search Screen

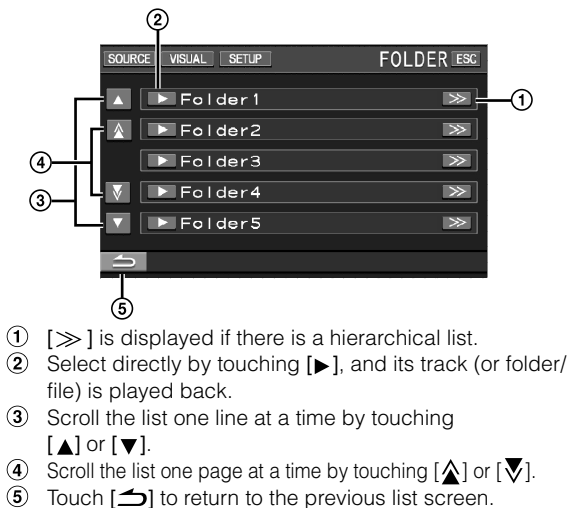

- ① [>>] is displayed if there is a hierarchical list.
 - ② Select directly by touching [▶], and its track (or folder/file) is played back.
 - ③ Scroll the list one line at a time by touching [▲] or [▼].
 - ④ Scroll the list one page at a time by touching [▲] or [▼].
 - ⑤ Touch [↶] to return to the previous list screen.
- The search function does not work on the DVD, Video CD or CD changer. If [TOP MENU] or [MENU] is touched in the DVD-VR mode, the unit changes to the search function. Refer to “Searching by Programme” and “Searching by Playlist” (page 20).
 - A folder list is displayed only during MP3/WMA/AAC playback when the DVD player (DVA-5210) or changer compatible with MP3 is connected.

Internal CD player mode

- 1 The track list* screen appears.
- 2 Touch [▶] of a desired track text*.

* If the CD is text compatible only.

- “TRACK” is displayed in the track text list if there is no text on the disc.

Internal MP3/WMA/AAC/DivX® Player/external MP3-compatible DVD Player/Changer Mode

- 1 The folder list screen appears. Select a desired folder and then touch [>>]. ([>>] appears only when a file is present in the selected folder.) The file list screen is displayed.

- Touch [▶] to play back the folder directly.

- 2 Touch [▶] of a desired file name. The selected file will be played back.

Rear Entertainment Function

The rear entertainment function independently routes different sources to the front and the rear inside a car. For example, while listening to the radio or other audio source in the front, DVD can be enjoyed in the rear with the optional rear monitor and headphones.

1 Touch [SOURCE] on the main source screen.

The SOURCE selection screen is displayed.

2 Touch [RSE].

Rear Select display appears.

- Touching [MAIN] on the REAR selection screen will change to the main source screen.

3 Touch the desired source such as visual (auxiliary input, built-in DVD) to select.

- Touch [OFF] to cancel the rear entertainment function.
- When the “Setting the AUX Mode” (page 36) is set to OFF, the auxiliary source is not displayed.

Switching Display Modes

While your vehicle is parked, touch [WIDE] on the visual source screen.

Each touch changes the display modes as follows:

MODE 1 → MODE 2 → MODE 3 → MODE 1
 (WIDE) (CINEMA) (NORMAL) (WIDE)

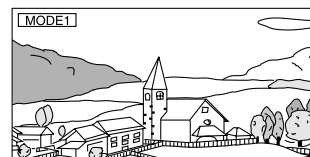

In Mode 1 (Wide), the monitor displays a normal picture wider to fit in a wide-screen monitor by evenly stretching out the picture horizontally.

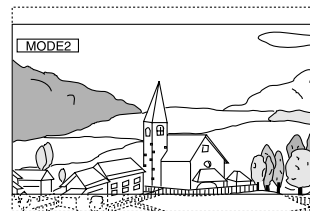

In Mode 2 (Cinema), the monitor displays a normal picture by stretching out the picture horizontally and vertically. This mode is good for displaying a cinema type picture at the 16:9 ratio.

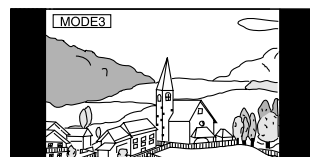

In Mode 3 (Normal), the monitor displays a normal picture at the centre of the screen with a vertical black band at each side.

Switching the Visual Source Only (Simultaneous Function)

You can watch the video portion of another source while listening to the current source.

1 Touch [VISUAL] on the audio source screen.

The VISUAL selection screen appears.

2 Touch a desired visual source.

The visual source is switched to the selected one.

Canceling the Simultaneous Function

- 1 Touch the visual screen to display the main control.
- 2 Touch **[ESC]**.
- 3 Touch **[VISUAL]** within 5 seconds.
The VISUAL selection screen appears.
- 4 Touch **[NORMAL]**.
The simultaneous function is cancelled.

• To make the setting, set to "Setting the VISUAL Soft Button" (page 37).

• If a DVD player is connected, you can receive the DVD picture/sound.

DVD changer (DHA-S680E) is connected:

Press and hold **V.OUT** on the remote control supplied with the DVD player or DVD changer for more than 2 seconds. The picture and sound of the DVD will be output.

The DVA-5210 or DVD changer (DHA-S690) is connected:

Press **V.OUT** on the remote control (included with the DVA-5210 or DHA-S690) to output DVD picture/sound.

• The simultaneous function cannot be used when the Audio source is in the navigation mode.

When NAV. is set in "Setting the VISUAL Soft Button" (page 37), only the navigation screen can be recalled.

Blackout Mode On and Off

When Blackout mode is turned on, the monitor display will turn off to reduce power consumption.

This additional power enhances the sound quality.

- 1 Touch **[VISUAL]** on the main source screen.
The VISUAL selection screen is displayed.
- 2 Touch **[OFF]**.
The backlit-display portion goes out.
- 3 Touch **[OFF]** again to cancel the display backlight.

• To make the setting, set to VISUAL in "Setting the VISUAL Soft Button" (page 37).

• If any button on the unit is pressed during Blackout mode, the function will be displayed for 5 seconds to show the operation before returning to Blackout mode.

Setup

DVD Setup

DVD Setup Operation

The Parking Brake must be engaged to access the DVD mode screen. Attempting to access this screen while driving will display the warning-CAN'T OPERATE WHILE DRIVING.

The DVD Setup operation can be carried out after removing the disc from the unit.

The following steps 1 to 5 are common operations to each "Setting item" of DVD Setup. Refer to each section for details.

- 1 Touch **[SETUP]** on the main source screen.
The SETUP selection screen is displayed.
- 2 Touch **[SOURCE SETUP]**.
The SOURCE SETUP screen appears.
- 3 Touch **[>>]** of DVD SETUP.
The DVD setup screen appears.
- 4 Touch **[<<], [▶] or [>>], etc., of the desired item to change its setting.**

Setting items:

MENU LANGUAGE / AUDIO LANGUAGE / SUBT. LANGUAGE / COUNTRY CODE / PARENTAL / DIGITAL OUT MODE / DOWNMIX MODE / TV SCREEN / BONUS CODE / DVD-A SETUP / FILE PLAY MODE / DVD PLAY MODE / DivX INFO. / PBC

Display example for DVD setup screen

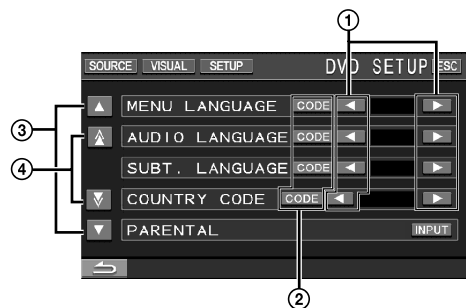

- ① Touch **[<<]** or **[▶]** to set a desired language.
- ② Touch **[CODE]** to display the numeric keypad input screen.
- ③ Touch **[▲]** or **[▼]** to scroll a setting item list by one Line.
- ④ Touch **[▶]** or **[<<]** to scroll a setting item list by one page.

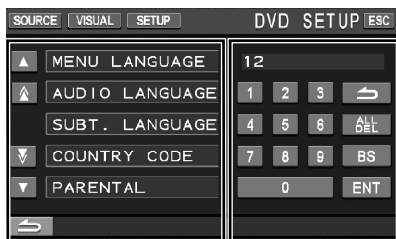

- ① The numeric keypad input screen closes when the area is touched while displayed.
- ② Numeric keypad input screen
The numeric keypad is used if you want to play back in a language other than that displayed, or to input your parental lock password, etc.

5 Touch [↶] to return to the previous screen.

Touch and hold [↶] for at least 2 seconds to return to the main source screen that was displayed before the setup operation was started.

- Immediately after changing the settings of DVD mode (while the system is writing data automatically) do not turn the ignition key (engine key) to OFF. Otherwise, the settings may not be changed.

Changing the language setting

The audio language, subtitle language and menu language can be set according to your preferences.

Once set, this becomes the default language. This function is convenient when you always want to listen in English. (The language setting is not effective on some discs. If not, the default language is set from the factory.)

- When the settings are changed, the old settings are overwritten. Make a note of the current settings before making changes. The memory is cleared when the vehicle's battery is disconnected.
- To temporarily change the language of the current disc, either do so from the DVD menu or by using the operation described in the section "Switching the Audio Tracks" (page 23).
- If the disc does not include the selected language, the disc's default language is set.

Setting of the Menu Language

Set the language used for the menus (title menu, etc.).

Setting item: MENU LANGUAGE

Setting contents: AUTO / EN / JP / DE / ES / FR / IT / SE / RU / CN

- When "AUTO" is selected, the primary menu language among the recorded ones is played.

Setting of the Audio Language

Set the audio language produced from the speakers.

Setting item: AUDIO LANGUAGE

Setting contents: AUTO / EN / JP / DE / ES / FR / IT / SE / RU / CN

- When "AUTO" is selected, the primary audio language among the recorded ones is played.

Setting of the Subtitle Language

Set the language of the subtitles displayed on the screen.

Setting item: SUBT. LANGUAGE

Setting contents: AUTO / EN / JP / DE / ES / FR / IT / SE / RU / CN

- When "AUTO" is selected, the primary subtitle language among the recorded ones is played.

To play in a language other than those displayed

- 1 Touch [CODE].
The numeric keypad screen is displayed.
- 2 Touch the 4-digit numeral of the language number.
As for the language number, refer to "List of Language Codes" (page 63).
- 3 Touch [ENT] to memorize the number.

Changing the Country Code Setting

Set the country number of which you want to set the rating level (Parental lock).

Setting item: COUNTRY CODE

Setting contents: AUTO / OTHER

- AUTO: The primary country code among those recorded is played.
- OTHER: The setting content changes to "OTHER" if the desired country code is input.

- When the settings are changed, the old settings are overwritten. Make a note of the current settings before making changes. The settings are cleared when the vehicle's battery is disconnected.

- 1 Touch [CODE].
- 2 Touch [ALL DEL] or [BS].
Delete the displayed country number.
- 3 Touch the 4-digit country code.
As for the country number, refer to "List of Country Codes" (pages 64 and 65).
- 4 Touch [ENT] to memorize the code.

Setting the Rating Level (Parental Lock)

This function can help restrict the viewing of movies to children of appropriate age levels only.

Setting item: PARENTAL

Setting content: INPUT

- When the settings are changed, the old settings are overwritten. Make a note of the current settings before making changes. The memory is cleared when the vehicle's battery is disconnected.
- On unrated DVDs, playback will not be restricted even if the rating level is set.
- If you want to play back DVD software with the parental lock feature and its use is currently restricted, change the rating level and the country number in order to play back the DVD.
- Once set, this rating level remains in memory until changed. To enable playback of discs of higher rating levels or to cancel the parental lock, the setting must be changed.
- Not all DVDs provide a Parental Lock feature. If you are unsure about a DVD, play it first to confirm. Do not leave DVDs accessible to young children for whom you deem them inappropriate.

- 1 Touch [INPUT].
The numeric keypad screen is displayed.
- 2 Touch the numeric keypad to input a 4-digit password.
The initial number is 1111. Input number are displayed as "*".
- 3 Touch [ENT] to memorize the number.
The PARENTAL screen appears.

Set the rating level of PARENTAL

- 4 Touch [▶] of PARENTAL to turn on.
- 5 Touch [◀] or [▶] of PARENTAL LEVEL to select the rating level (1 to 8).
Select "OFF" to cancel the parental lock or if you do not want to set a rating level. The smaller the number, the higher the rating level.
- 6 Touch [↶] to return to the previous screen.

Changing the password

- 4 Touch [INPUT] of PASSWORD CHANGE.
The numeric keypad screen is displayed.
- 5 Touch the input screen to enter a new 4-digit password.
 - Keep a note of the number somewhere safe in case you should forget it.
- 6 Touch [ENT] to memorize the number.
- 7 Touch [↶] to return to the previous screen.

Changing the rating level temporarily

Some discs may request that you change the rating level set in the default settings during playback. In this case, the message appears on the monitor screen "PARENTAL LEVEL CHANGE OK? [YES] [NO]."

If this screen appears, change the level as follows:

- **To change parental level and play, touch [YES].**
When [YES] is touched, the numeric keypad input screen is displayed. Input the 4-digit password in "Setting the Rating Level (Parental Lock)" you set, then touch [ENT].
- **To play without changing the parental level, touch [NO].**
(When [NO] is touched, playback will be at the parental level set in "Setting the Rating Level (Parental Lock).")

Changing the Digital Output Setting

Use the following procedure to set the digital audio signal output from the IVA-W502E.

Setting item: DIGITAL OUT MODE

Setting contents: AUTO / LPCM

- AUTO:** The digital output is switched automatically according to the type of audio signals being played.
Be sure to select "AUTO" when you want to connect a digital audio processor and play Dolby Digital audio.
"AUTO" is the factory setting.
- LPCM:** The audio signals recorded on the disc are converted to 48 kHz/16 bit (for DVDs) or 44.1 kHz (for Video CDs and CDs) linear PCM audio signals for output.

Audio output/Optical digital audio output

Disc Format	Audio recording format		Digital output setting (DVD SETUP)	Optical digital audio output	Analog audio output (Ai-NET, RCA output)
	Fs	Q			
LPCM (CD-DA, DVD-V, DVD-A, DVD-VR)	44.1/176.4kHz	16/20/24bit	AUTO or LPCM	44.1kHz, 16bit, LPCM 2ch (2ch Downmix)*	OK
	48/96/192kHz	16/20/24bit	AUTO or LPCM	48kHz, 16bit, LPCM 2ch (2ch Downmix)*	OK
PPCM (DVD-A)	44.1/88.2/ 176.4kHz	16/20/24bit	AUTO or LPCM	Not output	OK
	48/96/192kHz	16/20/24bit			
Dolby Digital (-EX) (DVD-V, DVD-A, DVD-VR)	48kHz	16/18/20bit	LPCM	48kHz, 16bit, Decoded 2ch (2chDownmix)*	OK
			AUTO	Auto (Max 7.1ch)*	OK
DTS (-ES) (CD-DA, DVD-V, DVD-A)	44.1kHz	16/20/24bit	LPCM	44.1kHz, 16bit Decoded 2ch (2chDownmix)*	OK
			AUTO	Auto (Max 6.1ch)*	OK
	48/96kHz	16/20/24bit	LPCM	48kHz, 16bit, Decoded 2ch (2chDownmix)*	OK
			AUTO	Auto (Max 6.1ch)*	OK
MPEG1Layer II (VCD, DVD-V, DVD-A, DVD-VR)	44.1kHz	16bit	LPCM	44.1kHz, 16bit, Decoded 2ch*	OK
			AUTO	Auto*	OK
	48kHz	16bit	LPCM	48kHz, 16bit, Decoded 2ch (2chDownmix)*	OK
			AUTO	Auto (Max 5.1ch)*	OK
MPEG2Layer II (DVD-V, DVD-A, DVD-VR)	44.1kHz	16bit	LPCM	44.1kHz, 16bit, Decoded 2ch*	OK
			AUTO	Auto*	OK
	48kHz	16bit	LPCM	48kHz, 16bit, Decoded 2ch (2chDownmix)*	OK
			AUTO	Auto (Max 5.1ch)*	OK
MPEG1/2/ 2.5Layer III (MP3, WMA)	32kHz	16bit	AUTO or LPCM	32kHz, 16bit, Decoded 2ch	OK
	44.1kHz	16bit	AUTO or LPCM	44.1kHz, 16bit, Decoded 2ch	OK
	48kHz	16bit	AUTO or LPCM	48kHz, 16bit, Decoded 2ch	OK

* Not output when playing back a DVD-Audio.

Setting the Downmix Mode

This function applies to Dolby Digital, DTS stream sound.

Setting item: DOWNMIX MODE

Setting contents: SURROUND / STEREO

SURROUND: Surround compatible Downmix

STEREO: Stereo Downmix

Setting the TV Screen Mode

Use the procedure described below to modify the output screen according to the type of TV monitor (rear monitor) being used. This setting can also be applied for the IVA-W502E.

If the rear monitor is not connected, the screen setting is 16:9.

Setting item: TV SCREEN

Setting contents: 4:3 LB / 4:3 PS / 16:9

- For some discs, the picture may not be set to the selected screen size. (For details, refer to the explanation on the disc's jacket.)

4:3 LETTER BOX:

Select this when connected to a conventional 4:3 size (normal TV aspect ratio) monitor. There may be black stripes visible at the top and bottom of the screen (when playing a 16:9 size movie). The width of these stripes will depend upon the original aspect ratio of the theatrical release of the movie.



4:3 PAN-SCAN:

Select this when connected to a conventional 4:3 size monitor. The picture will fill the entire TV screen. However, due to the mismatch in aspect ratio, parts of the movie at the extreme left and right sides will not be visible (when playing a 16:9 size movie).



16:9 WIDE:

Select this when connected to a wide screen TV. This is the factory setting.



Setting of the Bonus Code (DVD-A)

Some DVD-Audio discs include bonus group.

The 4 digit code for the bonus group can be memorized.

Refer to the information on the jacket, etc., of the disc, for the code number.

Setting item: BONUS CODE

Setting content: CODE

- 1 Touch [CODE].**
The 10 key input screen is displayed.
 - 2 Input the 4 digit code number given on the jacket of the disc, etc.**
 - 3 Touch [ENT] to memorize the number.**
- If the code number of the bonus group differs from the code number you set in this section, the 10 key input screen automatically appears in the display. If a new code number is input, this code number will be replaced.

Setting of the DVD-Audio Playback Mode

(DVD-A)

To playback the DVD Audio Disc, you have a choice of 3 different settings. If the disc containing DVD Video and Audio, set VCAP (Video Capable Audio Player) or VOFF (Video OFF) to playback the DVD Audio.

Setting item: DVD-A SETUP

Setting contents: VIDEO / VCAP / VOFF

- VIDEO: Only DVD Video is played back if the disc contains DVD Video and Audio.
- VCAP: DVD Audio is played back with Video.
- VOFF: DVD Audio is played back without Video.

Playing MP3/WMA/AAC Data (FILE PLAY MODE)

When using discs containing both audio data and MP3/WMA/AAC data.

Setting item: FILE PLAY MODE

Setting contents: CD / CMPM

- CD: Plays only the audio data on discs containing both audio data and MP3/WMA/AAC data.
- CMPM: Plays only the MP3/WMA/AAC files on discs containing both audio data and MP3/WMA/AAC data.
- Insert the disc when playback is stopped and remove the disc from the unit before setting.
 - When an MP3-compatible CD changer is used, this setting cannot be applied.

Setting the compressed File Playback Data

If a disc containing both a compressed video file and a compressed audio file is used, you have a choose to play back only a video or only audio.

Setting item: DVD PLAY MODE

Setting contents: AUDIO / VIDEO

- AUDIO: Only AUDIO data is played back.
- VIDEO: Only VIDEO data is played back.

Displaying DivX® Disc Information

Setting item: *DivX INFO.*

If [>>>] of DivX INFO. is touched, a DivX® file registered code is displayed.

Setting the Video CD Play Mode

When playing a Playback Control (PBC) enabled Video CD, you can choose to set PBC ON or OFF.

Setting item: *PBC*

Setting contents: *OFF / ON*

- OFF: The PBC menu is not displayed.
ON: The PBC menu is displayed.

DISPLAY Setup

Display Setup Operation

The Parking Brake must be engaged to access the DISPLAY mode screen. Attempting to access this screen while driving will display the warning-CAN'T OPERATE WHILE DRIVING.

The following steps 1 to 4 are common operations to each "Setting item" of DISPLAY Setup. Refer to each section for details.

- 1 Touch [SETUP] on the main source screen.**
The SETUP selection screen is displayed.
- 2 Touch [DISPLAY SETUP].**
The DISPLAY SETUP screen appears.
- 3 Touch [◀], [▶] or [>>>] etc., of the desired item to change its setting.**

Setting items:

TILT*¹ / DIMMER / DIMMER LOW LEVEL / BACKGROUND /
AUTO BACKGROUND / DATA DOWNLOAD*² /
BASE COLOR / SCREEN ALIGNMENT

*¹ For operation, refer to "Adjusting the Monitor Viewing Angle" on page 11.

*² Refer to "Downloading the BACKGROUND data" on page 39.

- 4 Touch [↶] to return to the previous screen.**
Touch and hold [↶] for at least 2 seconds to return to the main source screen that was displayed before the setup operation was started.

- Immediately after changing the settings of Display Mode (While the system is writing data automatically) do not turn the ignition key (engine key) to OFF. Otherwise, the settings may not be changed.

Setting the Brightness of the Backlighting

Backlighting is provided by a fluorescent light built into the liquid crystal panel. The illumination control adjusts the brightness of the backlighting based on the car ambient lighting for easier viewing.

Setting item: DIMMER

Setting contents: OFF / ON / AUTO

- OFF: Deactivate Auto Dimmer mode to keep the background illumination of the monitor bright.
- ON: Keep the background illumination of the monitor dark.
- AUTO: Adjust the brightness of the background illumination of the monitor automatically to the brightness of the car interior.

- When ON or AUTO is set, the setting is also applied for the button lighting in "Adjusting the Dimmer of Button Lighting at Night" (page 34).

Adjusting the Minimum Level of Backlight

You can adjust the brightness of the backlight (LOW). This function could be used, for instance, to change the screen brightness while travelling at night.

Setting item: DIMMER LOW LEVEL

Setting content: -15 to +15

You can adjust the level between MIN (-15) and MAX (+15). When it reaches the minimum or maximum point, the display shows "MIN" or "MAX" respectively.

Switching Background Textures

You have a choice of background textures you can set.

Setting item: BACKGROUND

Setting contents: MODE1 / MODE2 / MODE3*

* MODE3 is the black screen background supplied on this unit and can't be replaced by "Downloading the BACKGROUND data"

- This operation can be carried out after removing the disc from the unit or when playback of the disc has stopped.
- Wallpapers downloaded from "Downloading the BACKGROUND data" (page 39) are recalled.
- When you select a source other than the built-in disc on this unit, and the built-in disc is selected on the rear monitor connected to the unit, background textures cannot be displayed on the unit.
- When an error message is displayed (ERROR, etc.), background textures selected by this setting cannot be displayed on the unit.

Setting Automatic Background Textures

The background texture will automatically change each time the ignition key is turned off and turned back on again.

Setting item: AUTO BACKGROUND

Setting contents: OFF / ON

- OFF: Turn off the Auto Background Texture Scroll mode.
- ON: Turn on the Auto Background Texture Scroll mode. The background textures will scroll when the ignition key is turned off once and turned back on again as follows:
MODE1 → MODE2 → MODE3 → MODE1

- Wallpapers downloaded from "Downloading the BACKGROUND data" (page 39) are recalled.

Switching the Font Back Display Colour

You can choose from 4 different display colours for the font back (source title, shortcut display, etc.).

Setting item: BASE COLOR



Setting contents: BLUE / RED / GREEN / AMBER



Adjusting the Touch Panel

Adjustment becomes necessary when the display position on the LCD and the touch position on the touch panel do not match.

Setting item: SCREEN ALIGNMENT

Setting contents:  / RESET

- 1 Touch [] of SCREEN ALIGNMENT.
The adjustment screen appears.
- 2 Accurately touch the  mark provided in the lower left corner of the screen.
The screen changes to the adjustment screen.
- 3 Accurately touch the  mark provided in the upper right corner of the screen.
This completes adjustment, and returns to the DISPLAY setup mode screen.

- If you have touched a location other than the  mark, touch [RESET] to restore the adjustment screen to the initial setting.
- If you touch [] on the adjustment screen, no adjustment is done and the DISPLAY setup screen is restored.

GENERAL Setup

General Setup Operation

The Parking Brake must be engaged to access the GENERAL mode screen. Attempting to access this screen while driving will display the warning-CAN'T OPERATE WHILE DRIVING.

The following steps 1 to 4 are common operations to each "Setting item" of GENERAL Setup. Refer to each section for details.

- 1 Touch [SETUP] on the main source screen.**
The SETUP selection screen is displayed.
 - 2 Touch [GENERAL SETUP].**
The GENERAL SETUP screen appears.
 - 3 Touch [◀], [▶] or [≫], etc., of the desired item to change its setting.**
- Setting items:**
CLOCK / CLOCK ADJUST / DEMONSTRATION / BEEP / AUTO SCROLL / LED DIMMER LEVEL
- 4 Touch [↶] to return to the previous screen.**
Touch and hold [↶] for at least 2 seconds to return to the main source screen that was displayed before the setup operation was started.
- Immediately after changing the settings of General Mode (While the system is writing data automatically) do not turn the ignition key (engine key) to OFF. Otherwise, the settings may not be changed.

Displaying the Time

The clock indication on the monitor display is turned on or off respectively.

Setting item: CLOCK
Setting contents: OFF / ON

Setting the Time

Setting item: CLOCK ADJUST
Further setting items : HOUR / MINUTE / TIME ADJUST
Setting contents: 1-12 / 0-59 / RESET

- HOUR:** Adjust the hour.
MINUTE: Adjust the minute.
RESET: If the clock shows less than 30 minutes past, the minute will be "0"; more than 30, the hour advances.

- The clock-adjusting mode is cancelled when the power is turned off, when [↶] or [ESC] is touched.

Demonstration Function

This unit is equipped with a demonstration function capable of showing basic operations of respective sources on the monitor display.

Setting item: DEMONSTRATION
Setting contents: OFF / ON

- OFF:** Turns off the demonstration mode.
ON: Turns on the demonstration mode to show the basic operations.

- The demonstration operation is automatically repeated until the function is turned off.

Sound (Beep) Guide Function

Setting item: BEEP
Setting contents: OFF / ON

- OFF:** Deactivate the Sound Guide mode. The sound guide beep will not be produced when a button on the unit is pressed.
ON: Activate the Sound Guide mode.

Setting the Scroll

Scroll display is available if CD text, folder name, file name or tag information is entered.

Setting item: AUTO SCROLL
Setting contents: OFF / ON

- OFF:** Turns off the AUTO scroll mode. Scroll display is done once as a track is changed.
ON: Turns on the AUTO scroll mode. Scroll display is repeated as long as the mode is turned on.

- The display scrolls on the unit when the screen is filled up.
- Song, artist and album name, etc. scrolls when an iPod is connected.

Adjusting the Dimmer of Button Lighting at Night

You can adjust the brightness of the button lighting at night with the dimmer.

Setting item: LED DIMMER LEVEL
Setting level: -2 to +2

SYSTEM Setup

System Setup Operation

The Parking Brake must be engaged to access the SYSTEM mode screen. Attempting to access this screen while driving will display the warning-CAN'T OPERATE WHILE DRIVING.

The following steps 1 to 4 are common operations to each "Setting item" of SYSTEM Setup. Refer to each section for details.

- 1 Touch [SETUP] on the main source screen.**
The SETUP selection screen is displayed.
- 2 Touch [SYSTEM SETUP].**
The SYSTEM SETUP screen appears.
- 3 Touch [◀] or [▶] etc., of the desired item to change its setting.**

Setting items:

IN INT. MUTE*¹ / IN INT. ICON / REMOTE SENSOR*² / CAMERA IN / NAV. IN / NAV. MIX*³ / AUX IN / AUX IN LEVEL*⁴ / AUX IN SIGNAL*⁴ / AUX OUT / BLUETOOTH IN / USB ADAPTER / VISUAL KEY*⁵ / OPTION KEY / OPTICAL OUT / AUX+ IN / AUX+ LEVEL*⁶

*¹ Displayed only when BLUETOOTH IN is OFF.

*² When ON is set in "Setting the Picture Output" (page 36), the item is displayed.

*³ When ON is set in "Setting the Navigation Mode" (page 36), the item is displayed.

*⁴ Not displayed when OFF is set in "Setting the AUX Mode" (page 36).

*⁵ Not displayed when OFF is set in "Setting the Navigation Mode" (page 36).

*⁶ Not displayed when OFF is set in "Setting the AUX+ Mode" (page 37).

- 4 Touch [↶] to return to the previous screen.**
Touch and hold [↶] for at least 2 seconds to return to the main source screen that was displayed before the setup operation was started.
- Immediately after changing the settings of System Mode (while the system is writing data automatically) do not turn the ignition key (engine key) to OFF. Otherwise, the settings may not be changed.

Setting the External Device Interrupt Mode

If an Alpine Ai-NET Interrupt Box (NVE-K200) is connected to the IVA-W502E, an Auxiliary Source will be allowed to interrupt the current audio source. For example, use this function to have the sound of your TV interrupt CD or DVD play when it occurs. The CD/DVD player will be automatically muted during the voice guidance. For further details, please refer to the manual for NVE-K200.

Setting item: IN INT. MUTE

Setting contents: OFF / ON

OFF: The volume level can be adjusted in Interrupt mode.

ON: Sound will not be output. The icon that is set in "Setting the Interrupt Icon Display" is displayed.

- The auxiliary device being connected must have an Interrupt wire with a negative trigger for this function to operate automatically. Otherwise, a separate switch needs to be added to switch it manually.

Setting the Interrupt Icon Display

The unit can display the icon of an external device, such as a telephone, whenever a phone call comes in to tell you there is a phone call.

Setting item: IN INT. ICON

Setting contents: INT / TEL

INT: The INT icon appears on the display.

TEL: When the external device (telephone) sends the interrupt signal, the telephone icon appears on the display.

Switching the function of the remote sensor

For optional remote control operation, the remote sensor of the external device (monitor, etc.) can be switched, as you prefer.

Setting item: REMOTE SENSOR

Setting contents: FRONT / REAR

FRONT: The remote sensor of this unit is effective.

REAR: The remote sensor of the external monitor connected to AUX OUT of this unit becomes effective. The remote control operates the source connected to the AUX OUT terminals.

- The touch panel rear monitor sensor has priority over the remote control sensor. If the rear monitor (connected to the Alpine rear monitor output via the Monitor control lead) is touched, the command is executed regardless of the remote control sensor switch setting. Note, however, that the remote control sensor that has been set takes priority if it has been 5 seconds since last touching the panel.
- When an optional DVD changer or DVD player is connected, and the remote control sensor is set to REAR, some soft button operations ([■] STOP, etc.) cannot be performed. In this case, set the remote control sensor to FRONT.

Setting the Rear Camera Input

With a rear camera connected, rear view video is output to the monitor.

Setting item: CAMERA IN

Setting contents: OFF / NTSC / PAL

OFF: The CAMERA source is not displayed on the VISUAL selection screen.

NTSC/PAL: Even if the shift lever is not set to reverse (R), the rear pictures are output by selecting the CAMERA source.

- *By shifting to reverse (R), the rear pictures are output. This function is effective when the reverse wire is properly connected.*
- *To apply the setting, set to VISUAL in "Setting the VISUAL Soft Button" (page 37).*

Setting the Navigation Mode

When you connect an optional navigation equipment, set it to ON.

Setting item: NAV. IN

Setting contents: OFF / ON

OFF: Navigation source is not displayed. The settings related to the navigation can not be changed from this unit.

ON: Navigation source is displayed.

Setting the Navigation Interruption

With an Alpine navigation system connected to the IVA-W502E, the voice guidance of the navigation system will be mixed with the radio or CD play.

Setting item: NAV. MIX

Setting contents: OFF / ON

OFF: The navigation interruption mode is turned off.

ON: The navigation interruption mode is on.

See "Adjusting NAV. MIX Level" under "Adjusting the Audio" on page 25 to set the navigation interruption volume level.

- *The volume level for voice prompts during navigation guidance is set by adjusting the volume while the prompts are announced. When the announcement finishes, the normal audio volume and the previous audio screen are restored. The voice prompt volume is always at or below the current listening volume. If a navigation announcement cuts in while adjusting the audio level, it always resets to the current level regardless of the audio level setting.*
- *This setting is effective when NAV. IN of SYSTEM list screen is ON.*

Setting the AUX Mode

Setting item: AUX IN

Setting contents: OFF / ON / DVD / GAME / TV / DVB-T / EXT. DVD / NAV.

OFF: AUX source is not displayed.

ON: AUX source is displayed.

- *OFF is not displayed when the optional DVD player or DVD changer is connected. During SYSTEM setup, although the AUX name can be changed, it is not displayed on the source selection screen.*
- *When OFF is selected, the settings related to AUX cannot be changed from this unit.*
- *The selected source name is displayed instead of AUX source name. Select SOURCE to switch to the guide function of each mode.*
- *Only when an Alpine TV tuner is connected, you can operate the displayed function guide from this unit.*

Adjusting the External Input Audio Level

After setting to ON in "Setting the AUX Mode", this setting can be carried out.

Setting item: AUX IN LEVEL

Setting contents: LOW / HIGH

LOW: Decreases the external input audio level.

HIGH: Increases the external input audio level.

Switching the Visual Input Signal System

After setting to ON in "Setting the AUX mode", this setting can be carried out.

Setting item: AUX IN SIGNAL

Setting contents: NTSC / PAL

- *The video input type can be changed.*

Setting the Picture Output

Outputs the picture of the source selected on the IVA-W502E connected to the rear monitor.

Setting item: AUX OUT

Setting contents: OFF / ON

OFF: The "RSE" item is not displayed on the SOURCE selection screen.

ON: The "RSE" item is displayed on the SOURCE selection screen. Touch [RSE] to change to the REAR selection screen, and then touch the desired source. The selected source picture is output on the rear monitor.

Setting the Bluetooth Connection (BLUETOOTH IN)

Setting item: BLUETOOTH IN

Setting contents: ADAPTER / OFF

- ADAPTER:** Select when the optional Bluetooth box is connected. The TEL screen of the Bluetooth is displayed. When an external interruption occurs, the display changes to the TEL screen.
- OFF:** Select to ignore any external interrupts.

- *The setting cannot be made when “Setting the External Device Interrupt Mode” (page 35) is set to ON.*
- *For details on Bluetooth operation, refer to the Owner’s Manual of the Bluetooth Box.*
- *If the Bluetooth Box compatible with the Voice Dial function is connected, the Voice Dial function can be used.*

Setting the USB Adapter to ON/OFF

If a USB Adapter is to be used, set to ON.

Setting item: USB ADAPTER

Setting contents: OFF / ON

- OFF:** Does not display the USB source name on the SOURCE selection screen.
- ON:** Displays the USB source name on the SOURCE selection screen.
- *If ON is set even when a CD changer is connected, the source name on the SOURCE selection screen will change from CD CHG to USB.*

Setting the VISUAL Soft Button

Setting item: VISUAL KEY

Setting contents: VISUAL / NAV.

- VISUAL:** Recalls the VISUAL selection screen by touching [VISUAL].
- NAV.:** Switches directly to the navigation screen by touching [VISUAL].

Setting the OPTION Button on the Unit

The unit’s ✱ (OPTION) button function can be changed.

Setting item: OPTION KEY

Setting contents: V. SEL / TEL

- V. SEL:** Press ✱ (OPTION) to recall the V. SEL screen.
- TEL:** If you press ✱ (OPTION) when the Bluetooth Box is connected, the Bluetooth TEL screen will be recalled.

Setting the Digital Output

To connect an audio processor using the optical digital output, set to “ON” by the following procedure.

Setting item: OPTICAL OUT

Setting contents: OFF / ON

- *Afterwards, set ACC to OFF once, then turn it ON again. The setting of Digital Output is decided.*

Setting the AUX+ Mode

An external device (such as a portable music player) can be connected to the iPod Direct connector of this unit. An iPod Direct/RCA Interface cable (optional) is required.

A portable music device and an iPod cannot be connected to the iPod Direct connector at the same time.

Setting item: AUX+ IN

Setting contents: OFF / ON

- OFF:** AUX+ source is not displayed
- ON:** AUX+ source is displayed
- *When OFF is selected, the settings related to AUX+ cannot be changed from this unit.*
 - *Only when an Alpine TV tuner is connected, you can operate the displayed function guide from this unit.*

Adjusting the AUX+ Audio Level

After setting to ON in “Setting the AUX+ Mode”, this setting can be carried out.

Setting item: AUX+ LEVEL

Setting contents: LOW / HIGH

- LOW:** Decreases the external input audio level.
- HIGH:** Increases the external input audio level.

L.L.C. (Linear Luminance Control) SETUP

L.L.C. Setting Operation

The Parking Brake must be engaged to access the L.L.C. mode screen. Attempting to access this screen while driving will display the warning-CAN'T OPERATE WHILE DRIVING.

The following steps 1 to 4 are common operations to each "Setting item" of L.L.C. Setup. Refer to each section for details.

- 1 Touch [SETUP] on the main source screen.**
The SETUP selection screen is displayed.
- 2 Touch [L.L.C. SETUP].**
The L.L.C. SETUP screen appears.
- 3 Touch [◀] or [▶] etc., of the desired item to change its setting.**

Setting items:

L.L.C.* ↔ VISUAL EQ* ↔ BRIGHT ↔ COLOR* ↔ TINT*
↔ CONTRAST ↔ SHARP* ↔ USER MEMORY*

* The setting is available in the visual source mode (except navigation screen).

- 4 Touch [↶] to return to the previous screen.**
Touch and hold [↶] for at least 2 seconds to return to the main source screen that was displayed before the setup operation was started.
- Only one setting item can be displayed on each page, you can select the desired brightness, picture tint, etc through the screen displayed.

Picture Quality Darkness Adjustment Function (L.L.C.)

This function allows picture darkness (brighter black/deeper black) of a dark scene to be adjusted.

Setting item: L.L.C.

Setting contents: OFF / 1 / 2 / 3 / 4 / 5

You can adjust the level of picture adjustment effectiveness between 1 and 5.

1 2 3 4 5
⋮ ⋮ ⋮ ⋮ ⋮
Darker Brightness ← Darkness Balance → Brighter

Selecting the VISUAL EQ Mode (Maker's setting)

You can select a mode suitable for the subject image.

Setting item: VISUAL EQ

Setting contents: OFF (FLAT) / NIGHT M. / SOFT / SHARP / CONTRAST / P-1 / P-2

OFF (FLAT): Initial Setting
NIGHT M.: Suitable for movies in which dark scenes frequently appear.
SOFT: Suitable for CGs and animated films.
SHARP: Suitable for old movies where images are not clearly shown.
CONTRAST: Suitable for recent movies.
P-1: Recalls the VISUAL EQ mode being stored on preset No.P-1 from "Storing VISUAL EQ" (page 39).
P-2: Recalls the VISUAL EQ mode being saved on preset No.P-2 from "Storing VISUAL EQ" (page 39).

- To return to the initial setting after selecting any one of the setting contents (NIGHT M. to CONTRAST) and adjusting a desired brightness, picture tint, etc., set this function to OFF.
- If your desired brightness, picture tint, etc., are adjusted after selecting any one of the setting contents (NIGHT M. to CONTRAST), "CUSTOM" is displayed.

Adjusting Brightness

Setting item: BRIGHT

Setting content: -15 ~ +15

You can adjust the brightness between MIN (-15) and MAX (+15). When it reaches the minimum or maximum point, the display shows "MIN" or "MAX" respectively.

- When any Visual EQ Preset is selected, the brightness is automatically adjusted according to the car's interior lighting as long as AUTO is set in "Setting the Brightness of the Backlighting" (page 33).

Adjusting Colour of Picture

Setting item: COLOR

Setting content: -15 ~ +15

You can adjust the colour between MIN (-15) and MAX (+15). When it reaches the minimum or maximum point, the display shows "MIN" or "MAX" respectively.

- Colour adjustment can be made only in the navigation, DVD, Video CD, AUX modes.
- Colour adjustment cannot be made if a Navigation system with the RGB feature is connected.

Adjusting Tint of Picture

Setting item: TINT

Setting content: G15 ~ R15

Adjust the colour from G15 to R15. "G MAX" or "R MAX" is displayed at the maximum of each colour.

- Tint adjustment can be made only in the navigation, DVD, Video CD, AUX modes.
- Tint adjustment cannot be made if a Navigation system with the RGB feature is connected.
- When setting PAL, you cannot adjust the TINT.

Adjusting Image Contrast

Setting item: CONTRAST

Setting content: -15 to +15

Contrast adjustment range is -15 to +15. "LOW" and "HIGH" appear as the minimum and maximum values specified.

Adjusting Picture Quality

Setting item: SHARP

Setting content: -15 to +15

Picture quality adjustment range is -15 to +15. "SOFT" and "HARD" appear as the minimum and maximum values specified.

- *Picture quality adjustment can be made only in the navigation, DVD, Video CD, AUX modes.*
- *Picture quality adjustment cannot be made if a Navigation system with the RGB feature is connected.*

Storing VISUAL EQ

You can store the settings made for "Adjusting Image Brightness, Tint, Depth, Picture Quality and Contrast."

Setting item: USER MEMORY

Setting contents: P-1 / P-2

- 1 After completing "Adjusting Brightness, Tint, Depth, Picture Quality, and Contrast" (pages 38, 39), touch [◀] or [▶] of USER MEMORY and then select preset No. "P-1" or "P-2" to which the settings are to be stored.
 - 2 After selecting a preset No., touch [MEMORY].
The adjusted VISUAL EQ mode is stored by the above operations.
- *You can recall the VISUAL EQ mode stored here from P-1 or P-2 of "Selecting the VISUAL EQ Mode (Maker's setting)" (page 38).*

Data Download

Downloading the BACKGROUND data

You can download data (from Alpine's website) to a CD-R/CD-RW (data is written in the root folder), and store the data to the IVA-W502E. To start BACKGROUND download, access the URL below and follow the on-screen instructions.

<http://www.alpine.com> or <http://www.alpine-europe.com> or <http://www.alpine.com.au>

- 1 **Insert the CD-R/CD-RW disc containing the data you need.**
- 2 **Touch [◀] or [▶] of DATA DOWNLOAD, then select USER1 or USER2.**
The selected wallpaper can be changed.
- 3 **Touch [≫] of DATA DOWNLOAD.**
Data search of the disc starts. After completing the data search, the file selection screen of Data Download is displayed.
- 4 **Touch [▲] or [▼] to select the desired file name.**
- 5 **Touch [MEMORY].**
Data download starts.
When data downloading has completed correctly, the screen returns to the DATA DOWNLOAD screen.
- 6 **Touching [↶] returns to the previous screen.**
Touch and hold [↶] for at least 2 seconds returns to the earlier main source screen.

- *For details about procedures of download, see ALPINE's Web site.*
- *If data is newly downloaded, the data overwrites the previous data.*
- *The downloaded data will not be deleted even when the battery power cord is removed.*
- *You can recall a wallpaper in "Switching Background Textures" (page 33), or "Setting Automatic Background Textures" (page 33).*
- *When download has completed, remove the disc.*

External Audio Processor (Optional)

A compatible, external audio processor is operable from this unit when connected. Some audio processors may require a wired controller. The explanations below use the PXA-H700/PXA-H701 as an example. Refer to the operating instructions of the audio processor for more details.

- The adjustments or settings performed on the connected audio processor cannot be operated properly from this unit.
- The setting "Setting the Speakers", "Setting Bass Sound Control", and "Graphic Equalizer Adjustments" are not available if the MRA-D550 is connected. Additionally, if the MRA-F350 is connected, the following setting "Setting the MX mode of the External Audio processor" is not available. Also, the setting content differs between the PXA-H700 and PXA-H701.
- This unit cannot be connected to the PXA-H510 and PXA-H900.

The Parking Brake must be engaged to access the Audio Processor mode screen. Attempting to access this screen while driving will display the warning-CAN'T OPERATE WHILE DRIVING.

Adjustment Procedure for Dolby Surround

Make the adjustments described below in order to reproduce Dolby Digital and DTS sound with greater accuracy.

Adjustment procedure

- 1 Speaker Setup (page 45)**
(Turning the speakers to be used on and off and setting their response)

↓

- 2 Adjusting the speaker levels (page 45)**
(Adjusting the signal output level to the various speakers)

↓

- 3 Mixing bass sound to the rear channel (page 44)**
(Achieving smooth sound in the rear seat by mixing the front audio signals with the rear speaker signals)

↓

- 4 Adjusting the acoustic image (page 44)**
(Adjusting the acoustic image to achieve a sound as if the centre speaker were directly in front of the listener)

↓

- 5 Achieving powerful high volume sound (page 45)**
(Achieving energetic sound with even greater power, like the sound in a movie theater)

↓

- 6 Adjusting the DVD Level (page 45)**
(Adjust the volume (signal level) in the Dolby Digital, Pro Logic II, DTS and PCM modes)

↓

- 7 Storing Settings in the Memory (page 46)**
(Storing all the settings and adjustments made on the IVA-W502E (not only the above settings/adjusts) in the memory)

In case of combining the Automatic adjustments etc.

We recommend to make the Automatic adjustments before the Dolby Surround adjustments.

Setting the A.PROCESSOR

- 1 Check that Defeat mode is off (page 25).
- 2 Touch **[SETUP]** on the main source screen.
The SETUP selection screen is displayed.
- 3 Touch **[AUDIO SETUP]**.
The AUDIO SETUP screen appears.
- 4 Touch **[>>]** of **A.PROCESSOR**.
The A.PROCESSOR list screen appears.
- 5 Touch **[◀], [▶]** or **[>>]** etc., of the desired item to change its setting.

Setting items:

MEDIA XPANDER / BASS SOUND CONT. / DOLBY PLII/REAR FILL / X-OVER / T.CORR / PHASE / G-EQ / P-EQ / SPEAKER SELECT / MULTI CH SETUP / SPEAKER SETUP / DVD LEVEL / PCM MODE

- Touching **[ESC]** will change to the main source screen.
- Touching **[↶]** to return to the previous screen.

Setting the MX Mode of the External Audio Processor

Before performing the operations below, set MX (Media Xpander) mode of the PXA-H700 to "AUTO" when the PXA-H700 is connected.

Setting item: MEDIA XPANDER

- 1 Select **ON** or **OFF** of MX by touching **[◀]** or **[▶]** of **MEDIA XPANDER**.

OFF: Turns off the MX effect of every music source.
ON: Turns on the specified MX mode.

- 2 Touch **[>>]** after setting to **ON**.
The MEDIA XPANDER setup screen appears.

- 3 Touch **[◀]** or **[▶]** of the desired MX mode.

- Music source (such as radio broadcasts and CDs, excluding AM radio) level can be set.

MX CD (OFF, CD MX 1 to 3)

CD mode processes a large quantity of data. This data is used to reproduce the sound cleanly by making use of the data quantity.

MX CMPM (OFF, CMPM MX 1 to 3)

This corrects information that was omitted at the time of compression. This reproduces a well-balanced sound close to the original.

MX FM (OFF, FM MX 1 to 3)

The medium to high frequencies become more clear, and produces well balanced sound in all the bands.

MX DVD (OFF, MOVIE MX 1 to 2)

The dialog portion of the video is reproduced more clearly.

(DVD MUSIC)

This disc contains a large quantity of data such as music clip. MX uses this data to reproduce the sound accurately.

MX AUX (OFF, CMPM MX, MOVIE MX, MUSIC MX)

Choose the MX mode (CMPM, MUSIC, or MOVIE) that corresponds to the media connected.

- The contents of MX set here is reflected to PXA-H700 or PXA-H701.
- When OFF is selected, MX effect of each MX mode will be OFF.
- Each music source, such as radio, CD and MP3 can have its own MX setting.
- MX mode does not function when MX is ON for AM radio.
- MX CMPM is applied for MP3/WMA/AAC and iPod.
- The MX setting can be performed only when a source is currently selected.

Setting Bass Sound Control

Setting item: BASS SOUND CONT.

Setting Bass Compressor

You can adjust the sound of low frequencies as desired.

- Touch **[◀]** or **[▶]** of **BASS COMP.** to select the desired mode.

Bass sound is emphasized more as the mode is sequentially switched as MODE 1 → 2 → 3, offering you vivid low frequencies.

Select OFF when the setting is not necessary.

Setting Bass Focus

Using the previously specified delay number (time difference) allows you to set a time difference between the front-rear/left-right speakers. Namely, it enables a time correction based on your preference. With an initial delay of 0.05 ms for each of the 0 to 400 steps, audible time correction can be achieved.

- Set the delay number in the front and rear, and on the right and left of the desired speaker by touching the respective **[◀]** or **[▶]** button.

- Any setting in Bass Focus is applied in time correction, too (page 43).

Using the Pro Logic II Mode

Pro Logic processing can be conducted on the music signals recorded on two channels to achieve Dolby Pro Logic II surround sound. For two-channel Dolby Digital and DTS signals, there is also a "REAR FILL" function for outputting the signals of the front channel to the rear channel.

Setting item: DOLBY PLII/REAR FILL

Touch [◀] or [▶] of DOLBY PLII/REAR to select the desired mode.

- PL II MOVIE:** Suits the stereo TV shows and all programmes encoded in Dolby Surround. It improves the sound field directivity to near that of discrete 5.1-channel sound.
- PL II MUSIC:** Can be used for all stereo music recordings, and provides a wide, deep sound field.
- OFF:** Turns DOLBY PL II function to OFF.

If PL II MUSIC is selected, the centre width can be adjusted with following operations.

This function offers the optimum vocal position by adjusting the centre channel position between the centre speaker and the L/R speaker. (The adjustments established in "Adjusting the acoustic image (BI-PHANTOM)" (page 44) are ineffective while this function is activated.)

Touch [◀] or [▶] of CENTER WIDTH CONT. to adjust the level.

The level can be adjusted between 0 to +7. When the level increases, the centre channel position moves from the centre speaker position to both sides.

Touch [OFF] of CENTER WIDTH CONT. to turn off the centre width control.

- This adjustment is effective when the setting of the centre speaker is **SMALL** or **LARGE** in the speaker setup settings (page 45).
- "REAR FILL" function:
Depending on the input signals, the sound may only be output from the front speakers. In this case, the "REAR FILL" function can be used to output signals from the rear speakers as well.
- Avoid stopping, pausing, switching the disc, cueing, fast-forwarding or switching the audio channel of this unit while making this adjustment. The setting is cancelled if the Decode mode is switched.
- This adjustment is ineffective when the speaker is set **CENTER** to **OFF** in "Setting the Speakers" (page 44).
- This function only works with two-channel signals. This operation is ineffective when 5.1-channel DTS or Dolby Digital signals are input.
- If the setting of **REAR FILL** is made when **REAR MIX** is **ON**, sound is unchanged in the rear fill setting because **REAR MIX** is given priority during 2 channel decoder other than linear PCM.
- For linear PCM signals, the voice is output from the rear speaker regardless of the **REAR FILL** and **REAR MIX** setting.

X-OVER Adjustment

Setting item: X-OVER

1 Touch [◀] or [▶] of X-OVER to select L+R or L/R.

L+R: Sets the same adjustment values for the left and right channels.

L/R: Different adjustment values can be set for the left and right channels.

2 Touch [≫] of X-OVER.

A speaker list on the X-OVER screen is displayed.

3 Touch [≫] of the speaker to be adjusted.

The screen changes to the X-OVER screen to be adjusted.

4 Adjust the crossover to your preference.

Selecting the Cut-Off Frequency

Touch [◀] or [▶] of **FREQ.**, then select the cut-off frequency (crossover point).

The adjustable bandwidth differs depending on the speaker (channel).

Adjusting the Level

Touch [◀] or [▶] of **LEVEL**, then adjust the HPF or LPF level.

Adjusting the Slope

Touch [◀] or [▶] of **SLOPE**, then adjust the HPF or LPF slope.

- When the speaker is set to the "OFF" mode, the X-OVER for that speaker cannot be set. Refer to "Setting the Speakers" (page 44).
- Check the playback frequencies of the connected speakers before adjusting.
- In order to protect the speakers, there is no OFF setting for the subwoofer low pass filter (the slope remains the same).
- The HPF cannot be set **SLOPE** to **OFF** if **Tweeter (TW)** is selected for **FRONT1**. Or, only the subwoofer is adjustable if **STEREO** is selected for the subwoofer.

Performing Time Correction Manually (T.CORR)

Because of the particular conditions inside the vehicle, there can be major differences in the distances between the various speakers and the listening position. It is possible to calculate the optimum correction values and eliminate the time error at the listening position yourself using this function.

Setting item: T.CORR

1 Sit in the listening position (the driver's seat, for example) and measure the distance (in meters) between your head and the various speakers.

2 Calculate the difference in distance between the farthest speaker and the other speakers.

$$L = \begin{aligned} & \text{(distance of farthest speaker)} \\ & - \text{(distance of other speakers)} \end{aligned}$$

3 Divide the distances calculated for the different speakers by the speed of sound (343 m/s temperature 20°C).

This value is the time correction value for the various speakers.

Concrete examples

Calculating the time correction value for the front left speaker on the diagram below.

Conditions:

Distance between farthest speaker and listening position:
2.25 m (88-3/4")

Distance between front left speaker and listening position:
0.5 m (20")

Calculation:

$$L = 2.25 \text{ m (88-3/4")} - 0.5 \text{ m (20")} = 1.75 \text{ m (68-3/4")}$$

Compensation time = $1.75 \div 343 \times 1000 = 5.1 \text{ (ms)}$

In other words, setting the time correction value for the front left speaker to 5.1 (ms) sets a virtual distance matching the distance to the farthest speaker.

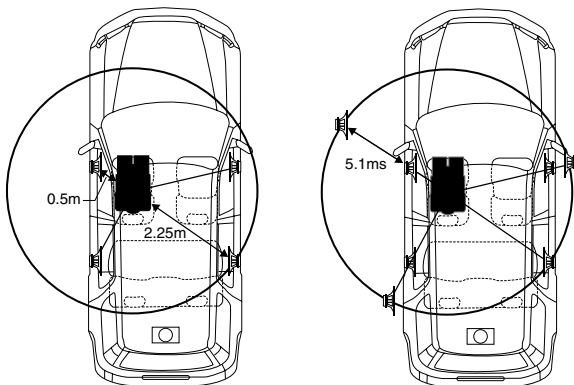

The sound is uneven because the distance between the listening position and the different speakers is different. The difference in the distance between the front left and rear right speakers is 1.75 meters (68-3/4").

Time correction eliminates the difference between the time required for the sound from the different speakers to reach the listening position. Setting the time correction of the front left speaker to 5.1 ms makes it possible to coordinate the distance from the listening position to the speaker.

4 Touch [◀] or [▶] of T.CORR.

Select L+R or L/R.

L+R: Sets the same adjustment values for the left and right channels.

L/R: Different adjustment values can be set for the left and right channels.

5 Touch [≫] of T.CORR.

The T.CORR adjustment screen appears.

6 Adjust the time correction value (0.00 ~ 20.00ms) of a desired speaker by touching the respective [◀] or [▶] button (1 step = 0.05ms).

- When the speaker is set to the "OFF" mode, the TCR for that speaker cannot be set. Refer to "Setting the Speakers" (page 44).
- The adjustment value for FRONT2 (Speakers) which is adjusted in time correction, is also applied to the front speakers in "Setting Bass Focus" (page 41).
- The adjustment (AUTO TCR) cannot be automatically set on this unit.

Phase Switching

Setting item: PHASE

Switch the phase (0° or 180°) by touching [◀] or [▶] of the desired speaker.

Graphic Equalizer Adjustments

The graphic equalizer allows you to modify the sound using 31 bands each for the front (left and right), rear (left and right) and centre speakers. An additional 10 bands are available for the subwoofer. This allows you to customize the sound to suit your taste.

Setting item: G-EQ

1 Select L+R or L/R by touching [◀] or [▶] of G-EQ.

L+R: Sets the same adjustment values for the left and right channels.

L/R: Different adjustment values can be set for the left and right channels.

When parametric EQ is adjusted, this setting will be turned off.

2 Touch [≫] of G-EQ.

The G-EQ list screen appears.

3 Touch [≫] of the desired speaker (channel).

The G-EQ adjustment screen appears.

4 Adjust the G-EQ to your preference.

Adjusting the Level

Touch [◀] or [▶] of the desired frequency to adjust the level.

- When the speaker is set to the "OFF" mode, the graphic equalizer for that speaker cannot be set. Refer to "Setting the Speakers" (page 44).
- Check the playable frequency ranges of the connected speakers before making the equalizer adjustments. If the speaker's playable frequency range is 55 Hz to 30 kHz, for example, adjusting the 40 Hz or 20 Hz band has no effect. Additionally, you may overload and damage the speakers.
- When graphic EQ is adjusted, the adjustment for parametric EQ becomes ineffective.

Parametric Equalizer Adjustments

The frequency bands of the graphic equalizer are fixed. This makes it very difficult to correct for undesired peaks and dips at specific frequencies. The parametric equalizer's centre frequency can be tuned to these specific frequencies. Then, the bandwidth (Q) and level are fine-tuned, independently, to make the necessary corrections. The parametric equalizer function is an advanced tool for serious audiophiles.

Setting item: P-EQ

1 Select L+R or L/R by touching [◀] or [▶] of P-EQ.

L+R: Sets the same adjustment values for the left and right channels.

L/R: Different adjustment values can be set for the left and right channels.

When graphic EQ is adjusted, this setting will be turned off.

2 Touch [≫] of P-EQ.

The P-EQ list screen appears.

3 Touch [≫] of the desired speaker (channel).

The P-EQ adjustment screen appears.

4 Adjust the P-EQ to your preference.

Selecting the Band

Touch [◀] or [▶] of BAND to select the desired band.

Adjusting the Frequency

Touch [◀] or [▶] of FREQ. to adjust the frequency of the selected band.

Adjusting the Level

Touch [◀] or [▶] of LEVEL to adjust the level of the selected band.

Setting the Bandwidth

Touch [◀] or [▶] of Q to select the bandwidth.

- When the speaker is set to the "OFF" mode, the parametric equalizer for that speaker cannot be set. Refer to "Setting the Speakers" (page 44).
- It is not possible to adjust the frequencies of adjacent bands within 7 steps.
- Check the playable frequency ranges of the connected speakers before making the equalizer adjustments. If the speaker's playable frequency range is 55 Hz to 30 kHz, for example, adjusting the 40 Hz or 20 Hz band has no effect. Additionally, you may overload and damage the speakers.
- When the parametric EQ is adjusted, the adjustment for graphic EQ becomes ineffective.

Setting the Speakers

Setting item: SPEAKER SELECT

Set the connected speaker by touching the respective [◀] or [▶] button.

FRONT1:	OFF/FULL (Full Range)/TW (Tweeter)
FRONT2:	OFF/ON
REAR:	OFF/ON
CENTER:	OFF/ON
SUBW.:	OFF/MONO/STEREO

- Set the speaker which is not connected to OFF.
- Settings above can be carried out even when the speaker is set to OFF in "Speaker Setup" (page 45).
- To use the subwoofer in MONO with PXA-H700 or PXA-H701 connected, connect the subwoofer to the subwoofer output terminal of PXA-H700 or PXA-H701.

Setting of Dolby Digital

Setting item: MULTI CH SETUP

Adjusting the acoustic image (BI-PHANTOM)

In most installations, the centre speaker must be placed directly between the front passenger and driver. Using this function, the centre channel information is distributed to the left and right speakers. This creates an acoustic image simulating a centre speaker directly in front of each listener. Adjusting the centre width in PL II MUSIC (see "Using the Pro Logic II Mode" on page 42), makes this function ineffective.

- Avoid stopping, pausing, switching the disc, cueing, fast-forwarding or switching the audio channel of this unit while making this adjustment. The setting is cancelled if the Decode mode is switched.

Touch [◀] or [▶] of BI-PHANTOM to adjust the level.

The level can be adjusted within the range of -5 to +5. The higher the level, the more the position of the centre speaker is shifted to the sides.

The BI-PHANTOM function is turned off by touching [OFF].

- This adjustment is effective when the setting of the centre speaker to SMALL or LARGE in the speaker setup settings.
- This adjustment is ineffective when the speaker is set CENTER to OFF in "Setting the Speakers" (page 44).

Mixing bass sound to the rear channel (REAR MIX)

This function mixes the front channel audio signals to the audio signals output from the rear speakers, improving the sound in the vehicle's rear seat.

- Avoid stopping, pausing, switching the disc, cueing, fast-forwarding or switching the audio channel of this unit while making this adjustment. The setting is cancelled if the Decode mode is switched.

Touch [◀] or [▶] of REAR MIX to adjust the level.

The level can be adjusted in five steps: -6, -3, 0, +3 and +6. The higher the level, the more bass is output from the rear speakers. (The effect differs according to the software (DVD, etc.).)

The REAR MIX function is turned off by touching [OFF].

- This adjustment is ineffective when the rear speaker setup setting is set to "OFF".
- For linear PCM signals, the voice is output from the rear speaker regardless of the REAR FILL and REAR MIX setting.

Achieving powerful high volume sound (LISTENING MODE)

With Dolby Digital, the dynamic range is compressed so that powerful sound can be achieved at regular volume levels. This compression can be cancelled to achieve an energetic sound with even greater power, like the sound in a movie theater. This function works only in the Dolby Digital mode.

Touch [◀] or [▶] of LISTENING MODE to select STD or MAX.

STD: For powerful sound at regular volume levels

MAX.: For powerful sound at high volumes

- *Keep the volume to a level at which sounds outside the vehicle can still be heard.*

Adjusting the speaker levels (OUTPUT LEVEL)

The test tones help to make the volume adjustments of the different speakers. When levels are equal, a strong sense of presence can be heard from the different speakers at the listening position.

- *Avoid stopping, pausing, switching the disc, cueing, fast-forwarding or switching the audio channel of this unit while making this adjustment. The setting is cancelled if the decode mode is switched.*

1 Touch [ON] of OUTPUT LEVEL.

Test tone output is repeated for each of the different speaker channels. They will be repeated in the order shown below.

If no operation is performed for 2 seconds, the channel switches to the next channel.

Left → Centre → Right → Right Surround →
Left Surround → Left

2 While the test tone is being produced from the speakers, touch [◀] or [▶] of OUTPUT LEVEL balance the output from all the speakers.

- The adjustment range for the different speakers is -10 dB - +10 dB.
- Adjust based on the front speakers.

3 Touch [ON] again to turn off.

- *If a speaker is set to off mode, that speaker's level adjustment cannot be made. Refer to "Speaker Setup" (page 45).*

Speaker Setup

The PXA-H700 or PXA-H701 can be set according to the playable frequency range of your speakers.

Check the playable frequency range of the speakers (not including the subwoofer) before performing this operation to verify whether the speakers can play low frequencies (of about 80 Hz or less).

- *Avoid stopping, pausing, switching the disc, cueing, fast-forwarding or switching the audio channel of this unit while making this adjustment. The setting is cancelled if Decode mode is switched.*

Setting item: SPEAKER SETUP

Select the speaker characteristic by touching [◀], [▶] of the desired speaker setting.

OFF*¹: When no speaker is connected.

SMALL: When a speaker that cannot play low frequencies (80 Hz or less) is connected.

LARGE*²: When a speaker that can play low frequencies (80 Hz or less) is connected.

*¹ It is not possible to set the front speakers to "OFF".

*² If the front speakers are set to "SMALL", the rear and centre speakers cannot be set to "LARGE".

- *The subwoofer can be set only to ON/OFF.*
- *If the centre speaker is turned "OFF", the centre channel's audio signals are added to the audio signals output from the front speakers.*
- *If you set the speaker response to "OFF", also set the speaker setting to "OFF" (page 44).*
- *Perform the setup for all the speakers ("Front", "Centre", "Rear" and "Subwoofer"). If not, the sound may not be balanced.*
- *When centre is set to "OFF", the setting is ineffective even if centre is set with this function.*
- *Through changing the settings on each speaker, a change in the output of the other speakers may occur due to the setting requirements.*
- *When using the PRO LOGIC II, if the rear speaker is set to "LARGE", then there will be no output from the subwoofer.*

Adjusting the DVD Level

The volume (signal level) for Dolby Digital, Dolby PL II, DTS and PCM modes can be set.

- *Avoid stopping, pausing, switching the disc, cueing, fast-forwarding or switching the audio channel of this unit while making this adjustment. The setting is cancelled if the Decode mode is switched.*

Setting item: DVD LEVEL

Adjust the level by touching [◀] or [▶] of the desired adjusting mode.

The level can be adjusted in the range of -5 dB to +5 dB.

Linear PCM Setting

The output when playing discs recorded in linear PCM can be set to 2 or 3 channels.

Setting item: PCM MODE

Touch [◀] or [▶] of PCM MODE to select 2CH or 3CH.

2CH: 2ch output (L/R)

3CH: 3ch output (L/R/CENTER)

- *This adjustment is ineffective when the speaker is set CENTER to OFF in "Setting the Speakers" (page 44).*

Storing Settings in the Memory

Adjustment or setting contents can be stored.

Contents that can be stored vary depends on the audio processor used.

1 Touch [MEMORY] on the A.PROCESSOR list display.

2 Within 5 seconds, touch any one of the preset buttons [P.SET 1] through [P.SET 6] on the A.PROCESSOR list screen.

The setting contents are stored.

- *The stored contents will not be deleted even when the battery power cord is detached.*

Calling up the Preset Memory

Touch any one of the preset buttons [P.SET 1] through [P.SET 6] on the A.PROCESSOR list display to select the preset memory.

- *It takes a few moments to call up the preset memory.*

IMPRINT Operation (Optional)

Alpine introduces IMPRINT - the world's first technology that thoroughly eliminates in-car acoustic problems that normally degrade sound quality, which enables us to experience music the way the artist intended, refer to "About IMPRINT" (page 52).

When the IMPRINT audio processor (PXA-H100) (sold separately) is connected to this unit, MultEQ and the following sound adjustment can be performed.

The Parking Brake must be engaged to access the IMPRINT mode screen. Attempting to access this screen while driving will display the warning-CAN'T OPERATE WHILE DRIVING.

Changing MultEQ mode

MultEQ, developed by Audyssey Labs, automatically corrects the audio for the listening environment. The system is optimized for selected positions in the vehicle. To accomplish this, MultEQ must take measurements of the vehicles response characteristics. For details on the set up procedure, consult your authorized Alpine dealer.

1 Press IMPRINT of the unit, the MultEQ mode selection screen will be displayed.

2 Touch [◀] or [▶] to change the setting.

Setting contents: OFF / CURVE 1 / CURVE 2

OFF: Adjusting the audio settings manually to create your own preference.

CURVE1/

CURVE2: Correcting the audio for the listening environment automatically.

- *The Curve mode can be selected only when curve 1 and curve 2 are stored.*
- *When MultEQ is set to CURVE 1 or CURVE 2, MEDIA XPANDER, X-OVER, T.CORR, SUBWOOFER PHASE, SUBWOOFER SYSTEM, SUBWOOFER CHANNEL, TW SETUP, P-EQ, G-EQ and F-EQ can not be adjusted.*

Adjusting Sound Setting in Manual Mode

You can change these sound settings to create your own preference when the MultEQ mode is set to OFF (Manual Mode).

Use steps 1 to 5 to select one of the Sound menu modes to modify. See the applicable section below for details about the selected item.

- 1 Check whether the Defeat mode is off.**
- 2 Touch [SETUP] on the main source screen.**
The SETUP selection screen is displayed.
- 3 Touch [AUDIO SETUP]**
The AUDIO SETUP screen appears.
- 4 Touch [A.PROCESSOR]**
The A.PROCESSOR SETUP screen appears.
- 5 Touch [◀], [▶] or [≫], etc., of the desired item to change its setting.**

Setting items: MEDIA XPANDER / X-OVER / T.CORR / T.CORR PARAMETER / G-EQ / P-EQ / F-EQ / TW SETUP*

* This function can be operable only when PXA-H100 (sold separately) is connected and 2.2ch (3WAY) mode is set. For details, refer to the Owner's Manual of PXA-H100.

- Touching [ESC] will change to the main source screen.
- Touching [↩] to return to the previous screen.
- Media Xpander, F-EQ, P-EQ and G-EQ Adjustment are inoperable when Defeat is set to ON.

Equalizer Presets (F-EQ)

10 typical equalizer settings and 6 user's preset settings are preset at the factory for a variety of musical source material.

Setting item: F-EQ

- 1 Touch [≫] of F-EQ.**
The F-EQ setup screen appears.
 - 2 Touch [◀] or [▶] of the desired type to set to ON.**
Flat / Pops / Rock / News / Jazz&Blues / Electrical Dance / Hip Hop&Rap / Easy Listening / Country / Classical / User1 / User2 / User3 / User4 / User5 / User6
- Only one type can be set to ON.
 - By selecting User's 1 to 6, you can recall the stored preset number in "Adjusting the Graphic Equalizer Curve" (page 48) or "Adjusting the Parametric Equalizer Curve" (page 48).

Setting the Response Slope for the High Range Speaker (TW SETUP)

Depending on the response characteristics of the speaker, care should be taken when setting the response slope of the high range speaker to FLAT in 2.2ch (3WAY) mode (see "Adjusting the Crossover Settings" on page 49), as speaker damage may result.

Setting item: TW SETUP

Touch [◀] or [▶] of TW SETUP to select Maker's or User's.

- Maker's: As protection from possible speaker damage, FLAT cannot be set for the response slope of the high range speaker in 2.2ch (3WAY) mode.
- User's: The FLAT setting is possible in 2.2ch (3WAY) mode.

- The TW Setup mode can only be selected if the FRONT/REAR/SUBW. (4.2CH)/3WAY (2.2CH) switch on the IMPRINT audio processor (PXA-H100) is set to 3WAY (2.2CH).

Setting the MX Level (MEDIA XPANDER)

MX (Media Xpander) makes vocals or instruments sound distinct regardless of the music source. The FM radio, CD, USB memory and iPod, will be able to reproduce the music clearly even in cars with a lot of road noise.

Setting item: MEDIA XPANDER

- 1 Touch [◀] or [▶] of MEDIA XPANDER to select ON or OFF.**
OFF: Turns off the MX effect of every music source.
ON: Turns on the specified MX mode.
- 2 Touch [≫] after setting to ON.**
The MEDIA XPANDER setup screen appears.
- 3 Touch [◀] or [▶] of the desired MX mode.**

- Music source (such as radio broadcasts and CDs, excluding AM radio) level can be set.

MX CD (OFF, CD MX 1 to 3)

CD mode processes a large quantity of data. This data is used to reproduce the sound cleanly by making use of the data quantity.

MX CMPM (OFF, CMPM MX 1 to 3)

This corrects information that was omitted at the time of compression. This reproduces a well-balanced sound close to the original.

MX FM (OFF, FM MX 1 to 3)

The medium to high frequencies become more clear, and produces well balanced sound in all the bands.

MX DVD (OFF, MOVIE MX 1 to 2)

The dialog portion of the video is reproduced more clearly.

(DVD MUSIC)

This disc contains a large quantity of data such as music clip. MX uses this data to reproduce the sound accurately.

MX AUX (OFF, CMPM MX, MOVIE MX, MUSIC MX)

Choose the MX mode (CMPM, MUSIC, or MOVIE) that corresponds to the media connected.

- When OFF is selected, MX effect of each MX mode will be OFF.
- Each music source, such as radio, CD and MP3 can have its own MX setting.
- MX mode does not function when MX is ON for AM radio.
- MX CPM is applied for MP3/WMA/AAC and iPod.
- The MX setting can be performed only when a source is currently selected.

Adjusting the Parametric Equalizer Curve (P-EQ)

You can modify the Equalizer settings to create a response curve more appealing to your personal taste.

Setting item: P-EQ

- 1 Select L+R by touching [▶] of P-EQ.**
When graphic EQ is set to L+R, this setting will be turned off.
- 2 Touch [≫] of P-EQ after selecting L+R.**
The P-EQ list screen appears.
- 3 Adjust the P-EQ to your preference.**

Adjusting the Band

Touch [◀] or [▶] of BAND to select the band to be adjusted.

BAND1 / BAND2 / BAND3 / BAND4 / BAND5

Adjusting the Frequency

Touch [◀] or [▶] of FREQ. to adjust the frequency of the selected band.

Adjustable frequency bands:
20 Hz to 20 kHz (in 1/3 octave steps)

Band-1: 20 Hz~80 Hz (63 Hz)
Band-2: 50 Hz~200 Hz (150 Hz)
Band-3: 125 Hz~3.2 kHz (400 Hz)
Band-4: 315 Hz~8 kHz (1 kHz)
Band-5: 800 Hz~20 kHz (2.5 kHz)

Adjusting the Level

Touch [◀] or [▶] of LEVEL to adjust the level of selected band.

Adjustable level: -6 to +6 dB

Setting the Bandwidth

Touch [◀] or [▶] of Q to select the bandwidth.

Adjustable bandwidth: 1, 1.5, 3

- 4 To adjust another band, repeat step 3 and adjust all bands.**

- The frequencies of adjacent bands cannot be adjusted within 4 steps.
- While adjusting the Parametric EQ, you should consider the frequency response of the connected speakers.
- When the parametric EQ is adjusted, the adjustment for graphic EQ becomes ineffective.

Adjusting the Graphic Equalizer Curve (G-EQ)

You can modify the equalizer settings to create a response curve more appealing to your personal taste.

Setting item: G-EQ

- 1 Select L+R by touching [▶] of G-EQ.**
When parametric EQ is set to L+R, this setting will be turned off.
- 2 Touch [≫] of G-EQ after selecting L+R.**
The G-EQ list screen appears.
- 3 Adjust the G-EQ to your preference.**

Adjusting the Band

Touch [◀] or [▶] of BAND to select the band to be adjusted.

BAND-1 (63 Hz) / BAND-2 (150 Hz) / BAND-3 (400 Hz) /
BAND-4 (1 kHz) / BAND-5 (2.5 kHz) / BAND-6 (6.3 kHz) /
BAND-7 (17.5 kHz)

Adjusting the Level

Touch [◀] or [▶] of LEVEL to adjust the level of selected band.

Adjustable output level: -6 to +6 dB

- 4 To adjust another band, repeat step 3, and then adjust all bands.**

- When graphic EQ is adjusted, the adjustment for parametric EQ becomes ineffective.

Setting the Time Correction Unit (T.CORR PARAMETER)

You can change the unit, (cm or inch) of time correction.

Touch [◀] or [▶] of T.CORR PARAMETER to select cm or Inch.

Setting item: T.CORR PARAMETER

cm ↔ Inch

cm: The unit of time correction is cm.

Inch: The unit of time correction is inch.

Adjusting the Time Correction (T. CORR)

Before performing the following procedures, refer to "About Time Correction" (page 50).

Setting item: T.CORR

- 1 Touch [≫] of T.CORR.**
The T.CORR adjustment screen appears.
- 2 Adjust the distance (0.0 to 336.6 cm) of a desired speaker by touching the respective [◀] or [▶] button.**

$L = (\text{distance to farthest speaker}) - (\text{distance to other speakers})$

Refer to "Time Correction Value List" on page 51.

- 3 Repeat step 2 to set another speaker.**
By setting these values to make its sound reach the listening position at the same time as the sound of other speakers.

Adjusting the Crossover Settings (X-OVER)

Before performing the following procedures, refer to "About the Crossover" (page 51).

Setting item: X-OVER

1 Touch [◀] or [▶] of X-OVER to select L+R or L/R.

L+R: Sets the same adjustment values for the left and right channels.

L/R: Different adjustment values can be set for the left and right channels.

2 Touch [≫] of X-OVER.

A speaker list on the X-OVER screen is displayed.

3 Touch [≫] of the band to be adjusted.

The screen changes to the X-OVER screen to be adjusted.

4.2ch (FRONT/REAR/SUBW.) System

4.2ch (FRONT/REAR/SUBW.) System / (L+R)

setting contents:

LOW (SUB-W) / MID (REAR) / HIGH (FRONT)

4.2ch (FRONT/REAR/SUBW.) System / (L/R)

setting contents:

LOW (SUB-W)-L / LOW (SUB-W)-R / MID (REAR)-L / MID (REAR)-R / HIGH (FRONT)-L / HIGH (FRONT)-R

4 Adjust the crossover to your preference.

Selecting the Cut-Off Frequency

Touch [◀] or [▶] of FREQ., then select the cut-off frequency (crossover point).

The adjustable bandwidth differs depending on the speaker (channel).

4.2ch (FRONT/REAR/SUBW.) System

Setting contents:

LOW (SUB-W) 20 Hz~200Hz

MID (REAR) 20 Hz~200Hz

HIGH (FRONT) 20 Hz~200Hz

Adjusting the Slope

Touch [◀] or [▶] of SLOPE, then adjust the HPF or LPF slope.

Adjustable slope: FLAT, -6 dB/oct., -12 dB/oct., -18 dB/oct., -24 dB/oct.

Adjusting the Level

Touch [◀] or [▶] of LEVEL, then adjust the HPF or LPF level.

Adjustable output level: -12 to 0 dB.

5 Repeat steps 3 to 4 to make adjustment to the other bands.

2.2ch (3WAY) System

2.2ch (3WAY) System / (L+R)

Setting contents:

LOW / MID-L / MID-H / HIGH

2.2ch (3WAY) System / (L/R)

Setting contents:

LOW-L / LOW-R / MID-L-L / MID-L-R / MID-H-L /

MID-H-R / HIGH-L / HIGH-R

4 Adjust the crossover to your preference.

Selecting the Cut-Off Frequency

Touch [◀] or [▶] of FREQ., then select the cut-off frequency (crossover point).

The adjustable bandwidth differs depending on the speaker (channel).

2.2ch (3WAY) System

Setting contents:

LOW / MID-L 20 Hz~200 Hz

MID-H 20 Hz~20 kHz

HIGH (1 kHz~20 kHz)^{*1} / (20 Hz~20 kHz)^{*2}

^{*1} When Maker's is selected, refer to "Setting the Response Slope for the High Range Speaker (TW SETUP)" (page 47).

^{*2} When User's is selected, refer to "Setting the Response Slope for the High Range Speaker (TW SETUP)" (page 47).

Adjusting the Level

Touch [◀] or [▶] of LEVEL, then adjust the HPF or LPF level.

Adjustable output level: -12 to 0 dB.

Adjusting the Slope

Touch [◀] or [▶] of SLOPE, then adjust the HPF or LPF slope.

Adjustable slope: FLAT*, -6 dB/oct., -12 dB/oct., -18 dB/oct., -24 dB/oct.

* FLAT can be set for the HIGH slope only when User's is selected in "Setting the Response Slope for the High Range Speaker (TW SETUP)" (page 47). Depending on the response characteristics of the speaker, care should be taken when setting the response slope to FLAT, as speaker damage may result. With this unit, a message is displayed when the response slope for the high range speaker is set to FLAT.

5 Repeat steps 3 to 4 to make adjustment to the other bands.

- While adjusting the X-OVER, you should consider the frequency response of the connected speakers.
- About the 2.2ch (3WAY)/4.2ch (FRONT/REAR/SUBW.) system You can switch the system mode with the 2.2ch (3WAY)/4.2ch (FRONT/REAR/SUBW.) switch on the PXA-H100. For details, refer to the Owner's Manual of PXA-H100.

Storing Settings in the Memory

Adjustment or setting contents of X-OVER, T.CORR and P/G-EQ can be stored.

Contents that can be stored vary depends on the audio processor used.

1 Check whether the Defeat mode is off.

2 Touch [MEMORY] on the A.PROCESSOR list display.

3 Within 5 seconds, touch any one of the preset buttons [P.SET 1] through [P.SET 6] on the A.PROCESSOR list screen.

The setting contents are stored.

- The stored contents will not be deleted even when the battery power cord is detached.
- This operation cannot be performed when a typical equalizer setting (e.g. Pops) is selected in "Equalizer Presets (F-EQ)" (page 47).

Calling up the Preset Memory

- 1 Check whether the Defeat mode is off.
- 2 Touch any one of the preset buttons [P.SET 1] through [P.SET 6] on the A.PROCESSOR list display to select the preset memory.

• It takes a few moments to call up the preset memory.

Setting the Subwoofer

- 1 Touch [SETUP] on the main source screen.
The SETUP selection screen is displayed.
- 2 Touch [AUDIO SETUP].
The AUDIO SETUP screen appears.
- 3 Touch [◀] or [▶] of SUBWOOFER to set the subwoofer ON/OFF.
- 4 Touch [>>] of SUBWOOFER after setting the SUBWOOFER to ON.
The SUBWOOFER SETUP screen appears.

Setting items:

LEVEL / PHASE / SYSTEM / CHANNEL

Adjusting the Subwoofer Level

Touch [◀] or [▶] of LEVEL to adjust the SUBWOOFER output.

Setting range: 0 to 15

Setting the Subwoofer System

When the subwoofer is on, you can select either System1 or System2 for the desired subwoofer effect.

Touch [◀] or [▶] of SYSTEM to select SYSTEM 1 or SYSTEM 2

SYSTEM 1 :Subwoofer level changes according to the main volume setting.

SYSTEM 2 :Subwoofer level change is different from the main volume setting. For example, even at low volume settings, the subwoofer is still audible.

Setting the Subwoofer Phase

Touch [◀] or [▶] of PHASE to select 0° or 180°

The subwoofer output phase is toggled SUBWOOFER NORMAL (0°) or SUBWOOFER REVERSE (180°).

Setting the Subwoofer Channel

You can set the subwoofer output to stereo or monaural. Make sure to set the correct output for your subwoofer type.

Touch [◀] or [▶] of CHANNEL to select STEREO or MONO.

STEREO: Subwoofer stereo (L/R) output

MONO: Subwoofer monaural output

About Time Correction

The distance between the listener and the speakers in a car vary widely due to the complex speaker placement. This difference in the distances from the speakers to the listener creates a shift in the sounds image and frequency characteristics. This is caused by the time delay between the sound reaching the listener's right versus the left ear.

To correct this, this unit is able to delay the audio signal to the speakers closest to the listener. This effectively creates a perception of increased distance for those speakers. The listener can be placed at an equal distance between the left and right speakers for optimum staging. The adjustment will be made for each speaker in 3.4cm steps.

Example 1. Listening Position: Front Left Seat

Adjust the time correction level of the front left speaker to a high value and the rear right to zero or a low value.

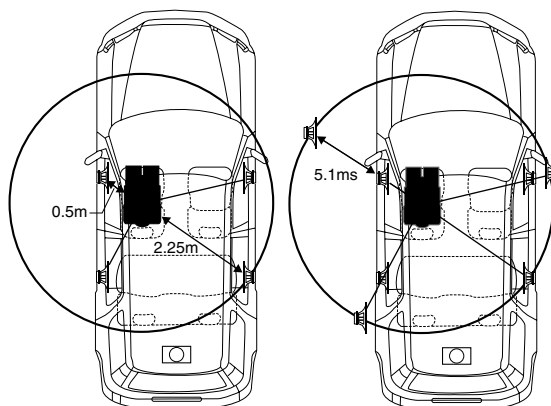

The sound is not balanced because the distance between the listening position and the various speakers is different. The difference in distance between the front left speaker and the rear right speaker is 1.75 m (68-7/8"). Here we calculate the time correction value for the front left speaker in the diagram on the above.

Conditions:

Farthest Speaker – listening position : 2.25 m (88-9/16")

Front left speaker – listening position : 0.5 m (19-11/16")

Calculation: $L = 2.25 \text{ m} - 0.5 \text{ m} = 1.75 \text{ m (68-7/8")}$

Time correction = $1.75 \div 343^{*1} \times 1000 = 5.1 \text{ (ms)}$

^{*1} Speed of sound: 343 m/s (765 mph) at 20°C

In other words, giving the front left speaker a time correction value of 5.1 ms makes it seem as if its distance from the listener is the same as the distance to the farthest speaker.

Time correction eliminates the differences in the time required for the sound to reach the listening position.

The time of the front left speaker is corrected by 5.1 ms so that its sound reaches the listening position at the same time as the sound of other speakers.

Example 2. Listening Position: All Seats

Adjust the time correction level of each speaker to almost the same level.

- 1 Sit in the listening position (driver's seat, etc.) and measure the distance (in meters) between your head and the various speakers.
- 2 Calculate the difference between the distance correction value to the farthest speaker and the other speakers.

$L = (\text{distance to farthest speaker}) - (\text{distance to other speakers})$

These values are the time correction values for the different speakers. Setting these values to make each sound reach the listening position at the same time as the sound of other speakers.

Time Correction Value List

Delay Number	Time Difference (ms)	Distance (cm)	Distance (inch)	Delay Number	Time Difference (ms)	Distance (cm)	Distance (inch)
0	0.0	0.0	0.0	51	5.1	173.4	68.3
1	0.1	3.4	1.3	52	5.2	176.8	69.7
2	0.2	6.8	2.7	53	5.3	180.2	71.0
3	0.3	10.2	4.0	54	5.4	183.6	72.4
4	0.4	13.6	5.4	55	5.5	187.0	73.7
5	0.5	17.0	6.7	56	5.6	190.4	75.0
6	0.6	20.4	8.0	57	5.7	193.8	76.4
7	0.7	23.8	9.4	58	5.8	197.2	77.7
8	0.8	27.2	10.7	59	5.9	200.6	79.1
9	0.9	30.6	12.1	60	6.0	204.0	80.4
10	1.0	34.0	13.4	61	6.1	207.4	81.7
11	1.1	37.4	14.7	62	6.2	210.8	83.1
12	1.2	40.8	16.1	63	6.3	214.2	84.4
13	1.3	44.2	17.4	64	6.4	217.6	85.8
14	1.4	47.6	18.8	65	6.5	221.0	87.1
15	1.5	51.0	20.1	66	6.6	224.4	88.4
16	1.6	54.4	21.4	67	6.7	227.8	89.8
17	1.7	57.8	22.8	68	6.8	231.2	91.1
18	1.8	61.2	24.1	69	6.9	234.6	92.5
19	1.9	64.6	25.5	70	7.0	238.0	93.8
20	2.0	68.0	26.8	71	7.1	241.4	95.1
21	2.1	71.4	28.1	72	7.2	244.8	96.5
22	2.2	74.8	29.5	73	7.3	248.2	97.8
23	2.3	78.2	30.8	74	7.4	251.6	99.2
24	2.4	81.6	32.2	75	7.5	255.0	100.5
25	2.5	85.0	33.5	76	7.6	258.4	101.8
26	2.6	88.4	34.8	77	7.7	261.8	103.2
27	2.7	91.8	36.2	78	7.8	265.2	104.5
28	2.8	95.2	37.5	79	7.9	268.6	105.9
29	2.9	98.6	38.9	80	8.0	272.0	107.2
30	3.0	102.0	40.2	81	8.1	275.4	108.5
31	3.1	105.4	41.5	82	8.2	278.8	109.9
32	3.2	108.8	42.9	83	8.3	282.2	111.2
33	3.3	112.2	44.2	84	8.4	285.6	112.6
34	3.4	115.6	45.6	85	8.5	289.0	113.9
35	3.5	119.0	46.9	86	8.6	292.4	115.2
36	3.6	122.4	48.2	87	8.7	295.8	116.6
37	3.7	125.8	49.6	88	8.8	299.2	117.9
38	3.8	129.2	50.9	89	8.9	302.6	119.3
39	3.9	132.6	52.3	90	9.0	306.0	120.6
40	4.0	136.0	53.6	91	9.1	309.4	121.9
41	4.1	139.4	54.9	92	9.2	312.8	123.3
42	4.2	142.8	56.3	93	9.3	316.2	124.6
43	4.3	146.2	57.6	94	9.4	319.6	126.0
44	4.4	149.6	59.0	95	9.5	323.0	127.3
45	4.5	153.0	60.3	96	9.6	326.4	128.6
46	4.6	156.4	61.6	97	9.7	329.8	130.0
47	4.7	159.8	63.0	98	9.8	333.2	131.3
48	4.8	163.2	64.3	99	9.9	336.6	132.7
49	4.9	166.6	65.7				
50	5.0	170.0	67.0				

About the Crossover

Crossover (X-OVER):

This unit is equipped with an active crossover. The crossover limits the frequencies delivered to the outputs. Each channel is controlled independently. Thus, each speaker pair can be driven by the frequencies for which they have been optimally designed.

The crossover adjusts the HPF (high pass filter) or LPF (low pass filter) of each band, and also the slope (how fast the filter rolls off the highs or lows).

Adjustments should be made according to the reproduction characteristics of the speakers. Depending on the speakers, a passive network may not be necessary. If you are unsure about this point, please consult your authorized Alpine dealer.

4.2ch (FRONT/REAR/SUBW.) mode

	Cut-off frequency (1/3 octave steps)		Slope		Level
	HPF	LPF	HPF	LPF	
Low range speaker	----	20 Hz - 200 Hz	----	FLAT, 6, 12, 18, 24 dB/oct.	0 to -12 dB
Rear high range speaker	20 Hz - 200 Hz	----	FLAT, 6, 12, 18, 24 dB/oct.	----	0 to -12 dB
Front high range speaker	20 Hz - 200 Hz	----	FLAT, 6, 12, 18, 24 dB/oct.	----	0 to -12 dB

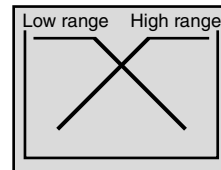

(Different from actual display)

2.2ch (3WAY) mode

	Cut-off frequency (1/3 octave steps)		Slope		Level
	HPF	LPF	HPF	LPF	
Low range speaker	----	20 Hz - 200 Hz	----	FLAT, 6, 12, 18, 24 dB/oct.	0 to -12 dB
Mid range speaker	20 Hz - 200 Hz	20 Hz - 20 kHz	FLAT, 6, 12, 18, 24 dB/oct.	FLAT, 6, 12, 18, 24 dB/oct.	0 to -12 dB
High range speaker	1 kHz - 20 kHz, (20 Hz ~ 20 kHz)*	----	FLAT* 6, 12, 18, 24 dB/oct.	----	0 to -12 dB

* Only when selecting User's in "Setting the Response Slope for the High Range Speaker (TW SETUP)" (page 47).

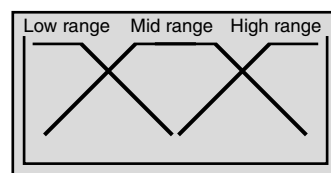

(Different from actual display)

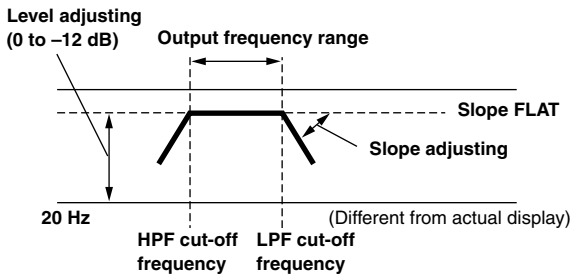

- **HPF (high pass filter):** Cuts the lower frequencies and allows the higher frequencies to pass.
- **LPF (low pass filter):** Cuts the higher frequencies and allows the lower frequencies to pass.
- **Slope:** The level change (in dB) for a frequency change of one octave.
- The higher the slope value, the steeper the slope becomes.
- Adjust the slope to **FLAT** to bypass the HP or LP filters.
- Do not use a tweeter without the HPF on or set to a low frequency, as it may cause damage to the speaker due to the low frequency content.
- You cannot adjust the crossover frequency higher than the HPF or lower than the LPF.
- Adjustment should be made according to the recommended crossover frequency of the connected speakers. Determine the recommended crossover frequency of the speakers. Adjusting to a frequency range outside that recommended may cause damage to the speakers. For the recommended crossover frequencies of Alpine speakers, refer to the respective Owner's Manual.
We are not responsible for damage or malfunction of speakers caused by using the crossover outside the recommended value.

About IMPRINT



VISION VS. REALITY

All good music starts as an artist's vision. After countless hours of rehearsing, recording and mixing, that vision is ready for us to hear on discs, radio and other media. But do we hear it as the artist created it? Unfortunately, the reality is that we are almost never able to listen to it in the exact way the artist intended. Especially when we are listening in a car.

CARS ARE TERRIBLE LISTENING SPACES

Car interiors are full of materials that obstruct and degrade sound quality. For example, windows amplify and reflect high frequencies. Seat and dashboard coverings change certain frequencies. Carpets absorb and suppress mid frequencies. Graphic and parametric EQs are only partial remedies for these problems. In addition, the speakers are not located at equal distances from listeners, creating an unbalanced, uncentred sound stage. Time correction can help fix this, but only for one listening position.

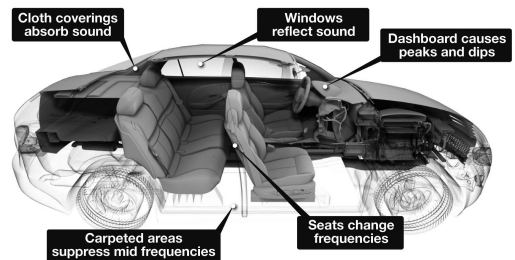

INTRODUCING IMPRINT

These acoustical problems are so severe that no correction system has been able to overcome them. Until now, with the introduction of IMPRINT, Alpine provides a hardware/software combination that not only solves these problems, it actually improves the sound stage, tonal balance and definition - and does it automatically, in a matter of minutes!

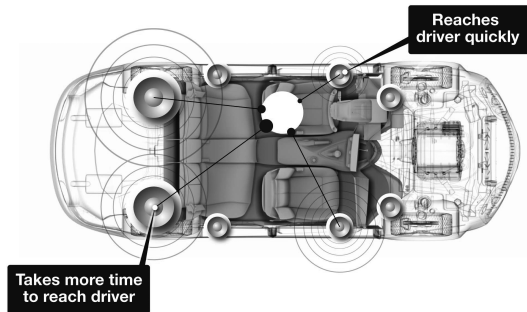

HOW IMPRINT IS DIFFERENT

IMPRINT using MultEQ is superior to other equalisation systems in five ways.

- It is the only system that measures the entire listening area, capturing time domain information from each listening location and applying a proprietary method for processing it to represent all seat locations. This gives the people in each seat the optimal listening experience.
- It corrects both time and frequency problems, for an improved soundstage and smoother, more natural sound.
- It uses dynamic frequency allocation to apply hundreds of points of correction to those areas where the sound problems are greatest.
- It determines optimized blending points for low frequency crossovers.
- It provides, in minutes, vehicle sound tuning that generally takes skilled professionals days to accomplish.

Navigation System (Optional)

Switching the Navigation Screen (Optional)

If an optional Alpine Navigation System is connected to the IVA-W502E, the Navigation screen can be displayed on this unit.

- 1 Touch [SOURCE] on the main source screen.**
The source screen appears on the display.
 - 2 Touch [NAV].**
The Navigation Screen is displayed.
The operation is possible with the supplied navigation remote control.
For navigation operation, refer to the Owner's Manual of the navigator.
- *The Navigation mode is selected in "Setting the VISUAL Soft Button" (page 37). The navigation mode is activated through the VISUAL Button without interrupting normal audio.*
 - *If the Navigation mode menu is not displayed on the main menu screen, select ON in "Setting the Navigation Mode" (page 36).*
 - *When the Navigation System is on and in guidance mode, the voice prompts and navigation map interrupts the current audio source.*

Auxiliary Device (Optional)

Operating Auxiliary Devices (Optional)

To operate your devices connected to the AUX terminals on the rear panel of IVA-W502E (AUX mode) or to the iPod Direct connector by using iPod Direct/RCA Interface cable (sold separately) (AUX+ mode), follow the procedure described below.

WARNING

It is dangerous (and illegal in many states) for the driver to watch the TV/Video while driving the vehicle. The driver may be distracted from looking ahead and an accident could occur.

Install the IVA-W502E correctly so that the driver cannot watch TV/Video unless the vehicle is stopped and the emergency brake is applied.

If the IVA-W502E is not installed correctly, the driver will be able to watch the TV/Video while driving the vehicle and may be distracted from looking ahead and cause an accident. The driver or other people could be severely injured.

- If you try to activate the auxiliary device while driving, the display will show the warning-PICTURE OFF FOR YOUR SAFETY.

- 1 Touch **[SOURCE]** on the main source screen.
The source screen appears on the display.
- 2 Touch **[AUX]*¹** or **[AUX+]*²**.
The external input screen is displayed.
- 3 Touch **[NTSC/PAL]** to change the video input.
- 4 Touch **[COMP./S-VIDEO]*³** to switch the video signal input mode.
The mode switches with each touch.

*¹ The name which is given as the source name in "Setting the AUX Mode" on page 36 is displayed.

*² The mode which is given as the source name in "Setting the AUX+ Mode" (page 37).

*³ The video signal can be input in two ways, selecting the right mode depending on the connection method. Switching to the COMP. mode when using the Video Input Connector. Switching to the S-VIDEO mode when using the S Video Input Connector.

- If the AUX mode is not displayed on the main menu, set AUX IN to ON by following "Setting the AUX Mode" (page 36).
- The setting of switching NTSC/PAL, which you have set in this section can be used in same way in "Switching the Visual Input Signal System" on page 36.
- The display mode changes by touching **[WIDE]**.
For operation, refer to "Switching Display Modes" on page 26.
- After connecting the KCA-410C, its AUX input can be used only in INTERRUPT MODE. For details, refer to the KCA-410C Owner's Manual.

TUE-T200DVB Operation (Optional)

Operating the TUE-T200DVB (Optional)

Operable when optional TUE-T200DVB is connected.
When DVB-T is selected in "Setting the AUX Mode" (page 36), the source is displayed in SOURCE selection screen.

- 1 While your vehicle is parked, touch **[SOURCE]** on the main source screen.
The source screen appears on the display.
- 2 Touch **[DVB-T]**.
The DVB-T screen is displayed.
- 3 Perform the desired operation.

Channel Number Up/Down or favourite Channel Number Up/Down

Touch **[CH.]*** to select changing the Channel or the favourite Channel.

Touch CH. [**◀**] or [**▶**] to move the Channel number Up/Down.

Touch FAV [**◀**] or [**▶**] to move the favourite Channel number Up/Down.

* The button displays the current changing mode ([CH.] or [FAV]).

Calling up Main Menu Screen

Touch **[MENU]** to call up the main menu screen.

Calling up Menu Operation Mode

- 1 Touch **[P1/2]**.
The function guide appears.
- 2 Touch **[MENU CONT]** to call up the menu operation mode.

Switching the Source

Touch **[BAND]**.

The source switches with each touch.

Calling up Electronic Programme Guide (EPG)

Touch **[EPG]** to call up the Electronic Programme Guide.

Scanning Mode

- 1 Touch **[P1/2]**.
The function guide appears.
- 2 Touch **[A.MEMO]** to start the auto scan procedure.

- For detail, refer to the Owner's Manual of the TUE-T200DVB sold separately.

Switching the Video Input Mode

Touch **[COMP./S-VIDEO]**.

The video signal input mode switches with each touch.

- Switching to the COMP. mode when using the Video Input Connector. Switching to the S-VIDEO mode when using the S Video Input Connector.

Changer (Optional)

Controlling CD Changer (Optional)

An optional 6-disc or 12-disc CD Changer may be connected to the IVA-W502E if it is Ai-NET compatible. With a CD Changer connected to the Ai-NET input of the IVA-W502E, the CD Changer will be controllable from the IVA-W502E.

If you connect a changer compatible with MP3, you can play CD-ROMs, CD-Rs, and CD-RWs containing MP3 files on the IVA-W502E.

Using the KCA-410C (Versatile Link Terminal) multiple changers can be controlled by the IVA-W502E.

See the Multi-Changer Selection section for selecting the CD Changers (explained on page 55).

1 Touch [SOURCE] on the main source screen.

2 Touch [CD CHG.].

The display changes to the CD changer mode screen.

When a 6 Disc CD Changer is connected;

1 Touch [P1/2]*.

The Function Guide display appears.

* *When an MP3 compatible CD changer or DVD changer is connected, touch repeatedly until the disc number is displayed.*

2 Touch any one of the select buttons [DISC 1] through [DISC 6].

DISC 1 through DISC 6 select the discs from the first disc to 6th disc.

When an MP3 compatible CD changer is connected;

1 Touch [P1/3] twice to change the Function Guide display.

2 Touch any one of the select buttons [DISC 1] through [DISC 6].

DISC 1 through DISC 6 select the discs from the first disc to 6th disc.

When a 12-Disc CD Changer is connected;

You can select the disc numbers 1 to 6 in the same manner as for 6-disc Changer.

Touch [P1/3] twice to select disc numbers 7 to 12.

The function guide display changes so that DISC 7 through DISC 12 represent disc numbers 7 to 12.

- *After selecting the desired disc, you can operate in the same way as for the CD player. For details, see the CD/MP3/WMA/AAC section.*
- *When an MP3 compatible CD changer is connected, the unit can play discs containing both audio data and MP3 data.*
- *The DVD changer (optional) is controllable from the IVA-W502E as well as the CD changer.*
- *For operation of the connected DVD changer (DHA-S690), refer to the section "CD/MP3/WMA/AAC" or "DVD/Video CD" described in this manual, or the Owner's Manual of the DHA-S690.*
- *When the optional DVD changer (DHA-S690) is connected to this unit, touching [NTSC/PAL] after touching [P1/4] three times will change the video input; touching [COMP/S-VIDEO] after touching [P1/4] once will change the video signal input mode. For details, refer to the same key of "Auxiliary Device (Optional)" page 54.*

Multi-Changer Selection (Optional)

When using KCA-410C (Versatile Link Terminal), you can connect two changers.

1 In changer mode, touch [CHG SEL] to select the next changer (connected CD changers or KCA-420i).

2 To operate the selected changer, see "CD/MP3/WMA/AAC" section.

- *To operate the selected changer, see "CD/MP3/WMA/AAC" (pages 14-17).*

USB Adapter Operation (Optional)

Controlling USB (Optional)

If the optional USB Adapter for the MP3 (KCA-620M) is connected, it is controllable from the unit.

1 Touch [SOURCE] on the main screen.

2 Touch [USB].

The display changes to the USB mode screen.

- After selecting the USB mode, you can operate in the same way as for the changer. For details, see the “Changer” and “CD/MP3/WMA/AAC” section.

USB Memory (Optional)

A USB memory or Portable audio player can be connected to the IVA-W502E through the USB Connector of this unit.

If a USB memory device or Portable audio player is connected to the unit, MP3/WMA/AAC files of USB memory and MP3/WMA files of Portable audio player can be played back.

BANK Function (USB memory only)

What is a Bank?

A bank is a unit of up to 1,000 songs, which is stored in memory.

“Banking” refers to the action of building up a bank (of songs) from the songs available in USB memory.

About Banking

While a bank is being built up, “BANKING” is displayed.

If another bank is selected when unit power is turned on, the ACC position is set, or USB connection is made, banking will start.

It can take anywhere from a few seconds to up to 10 minutes for banking to complete. This depends on the number of files and folders in USB memory.

Available operations while Banking

- Search functions, such as album search or tag information (artist display, etc.) are available during the banking process. However, during such time, tag information display changes.
- Regular fast-forwarding and next song selection is available.
- During Banking, the played back song order may differ from the song order in USB memory.

This unit has a BANK function that automatically divides every 1,000 songs stored in USB memory into individual banks to make searching and playing back a song easier. A maximum of 1,000 songs for one bank can be stored according to the order stored in USB memory. A maximum of 10 banks (10,000 songs) can be recognised. BANK1 (songs 1 to 1,000) is set as the default. If you want to search beyond 1,000 songs, perform the following operation to select a different bank.

BANK No.	Song number
BANK1	1~1,000
BANK2	1,001~2,000
⋮	⋮
BANK10	9,001~10,000

1 Touch [P1/2] to change the function guide.

2 Touch BANK [▼] or [▲] to select the desired BANK.

Each operation can be performed in the selected bank.

- Even if the files are contained in the same folder, they may be saved as different BANK.

Playback

- 1 Touch **[SOURCE]** on the main source screen.
The SOURCE selection screen is displayed.
- 2 Touch **[USB AUDIO]**, the USB mode is activated and the display changes to the USB screen.
- 3 Touch **[◀◀]** or **[▶▶]** to select the desired track (file).

Returning to the beginning of the current track (file):
Touch **[◀◀]**.

Fast backward (Only for USB Memory):
Touch and hold **[◀◀]**.

Advancing to the beginning of the next track (file):
Touch **[▶▶]**.

Fast forward (Only for USB Memory):
Touch and hold **[▶▶]**.

- 4 To pause playback, touch **[▶/||]**.
Touching **[▶/||]** again will resume playback.

- WMA format files that are protected by DRM (Digital Rights Management), AAC format files that have been purchased from iTunes Music Store and files that are copy-protected (copyright protection) cannot be played back on this unit.
- The playback time may not be correctly displayed when a VBR (Variable Bit Rate) recorded file is played back.
- If there is tag information, artist name/album name/track name is displayed.
- ID3 tag/WMA tag
If an MP3/WMA/AAC file contains ID3 tag/WMA tag information, the ID3 tag/WMA tag information is displayed (e.g., song name, artist name, and album name). All other tag data is ignored.
- "NO SUPPORT" is scroll displayed when text information is not compatible with this unit.
- Before disconnecting USB memory, be sure to change to another source or set to pause.

Repeat Play

Only Repeat One is available for this mode.
Repeat One: A single song is repeatedly played back.

- 1 Touch **[P1/2]**.
The function guide is displayed.
- 2 Touch **[↔]**.
The file will be played repeatedly.
RPT ↔ (off)
(Repeat One) (Repeat the list being played back)
- 3 To cancel repeat play, touch **[↔]**.

Random Play Shuffle (M.I.X.)

The Shuffle function of the USB memory or Portable audio player is displayed as M.I.X. on the IVA-W502E.

Shuffle ALL:
All songs in the USB memory or Portable audio player are played back in random sequence. Any one song does not play back again until all songs have been played back.

Shuffle Songs:
Song shuffle randomly plays back songs within a selected category (playlist, album, etc.). The songs within the category are played just once until all songs have been played.

- 1 Touch **[∞]** after touching **[P1/2]**.
The songs will be played back in random sequence.

→ M.I.X. SONGS → M.I.X. ALL → (off) →
(Shuffle Songs) (Shuffle ALL)

- 2 To cancel M.I.X. play, touch **[∞]**.
- When a song is played back during Random (M.I.X.) play, the song can be played back again randomly even if not all songs on the USB Memory have been played back.

Searching for a desired Song

A USB memory or Portable audio player device can contain hundreds of songs. By using file tag information and keeping these songs organized in playlists, this unit's search functions will ease song searches.

Each music category has its own individual hierarchy. Use the PLAYLISTS/ARTISTS/ALBUMS/SONGS/GENRES/COMPOSERS/FOLDERS/FILES search mode to narrow searches based on the table below.

Hierarchy 1	Hierarchy 2	Hierarchy 3	Hierarchy 4
Playlist	Song	—	—
Artist*	Album*	Song	—
Album*	Song	—	—
Song	—	—	—
Genre*	Artist*	Album*	Song
Composer*	Album*	Song	—
Folder	File	—	—
File	—	—	—

For example: Searching by Artist name

The following example explains how an ARTISTS search is performed. Another search mode can be used for the same operation, although the hierarchy differs.

Searching by artist name

1 Touch [].

The search mode is activated, and the search list screen appears.

- Touching [] for at least 2 seconds will return to last search mode.

2 Touch [] of ARTISTS.



The ARTISTS search screen is displayed.

3 Select the desired artist.







To play back the artist directly

- 1 Touch [] next to the artist's name.
All songs of the selected artist are played back.

To search for the album of an artist

- 1 Touch [] of the selected artist.
The ALBUMS search screen of the selected artist is displayed.
- 2 Touch [] next to the desired album's name.
All songs of the selected album are played back.

To search for a song in the album of an artist

- 1 Touch [] of the desired album in "To search for the album of an artist" in step 2.
The SONGS search screen of the selected album is displayed.
 - 2 Touch [] next to the desired song's name.
The selected song is played back.
- Touching [] of ALL will play back all songs in the list when you are in a hierarchy with an asterisk "*" (see table on the previous page).
 - Touching [] of ALL will display the search list in the next hierarchy.
 - When search is made during M.I.X. play, the M.I.X. play mode will be cancelled.
 - In search mode, you can jump to an assigned position by touching the direct search bar for quick search. For details, refer to "Direct Search Function" (page 60).
 - In the search mode, you can scroll the list one chapter*¹ at a time by touching [] or [].

*¹ Titles are listed alphabetically, and can be skipped every 200 titles with the same beginning alphabetical character. If there are fewer than 200 titles, titles beginning with the next alphabetical character are selected. e.g. press [] switch to the section begin with alphabet B from A.

Selecting Playlist/Artist/Album/Genre/Composer

Playlist/Artist/Album/Genre/Composer can be easily changed.

For example, if you listen to a song from a selected album, the album can be changed.

Touch [] or [] to select the desired Playlist/Artist/Album/Genre/Composer.

- If search selection mode is not activated, a SONGS search is not possible.
- If an album is selected from an artist search, the album can be searched.
- During shuffle (M.I.X.) playback, this operation is not possible.

Select the desired Folder (Folder up/down)

If you listen to a file from a selected folder, the folder can be changed.

Touch FOLDER [] or [] to select the folder.

Creating the playlist from the Artist/Album information of the current song

When a song is played back, a playlist about all the songs with the same Artist or Album stored in the USB memory or portable audio player can be created.

1 Touch [P1/2] when a song is played back.

The function guide changes.

2 Touch [X-RPT ARTIST] or [X-RPT ALBUM] to create the playlist.

- According to the artist/album information of the current song, a playlist about all the songs with the same artist/album of the BANK are made into a playlist, which then starts to play back.

About MP3/WMA/AAC File of USB Memory

Playing back MP3/WMA/AAC

MP3/WMA/AAC files are prepared, then stored to a USB memory. Or, synchronize an MP3/WMA file using Windows Media Player (Ver. 10 or 11), and then forward to the Portable audio player. This unit can recognise at least 256 folders (including root folder) and 10000 files per folder stored in USB memory. Playback may not be performed if a USB memory/Portable audio player exceeds the limitations described above. Do not make a file's playback time more than 1 hour.

Media supported

This device can play back USB memory/Portable audio player media.

Corresponding File Systems

This device supports FAT 12/16/32 for USB memory device/Portable audio player.

iPod® (Optional)

An iPod® can be connected to this unit.

iPod connection can be made in two ways using the USB connection cable, or directly connecting the iPod using the FULL SPEED™ connection cable (KCE-422i).

When the IVA-W502E is connected by using the cable, the controls on the iPod are not functional.

- Only 5th generation iPod, the first generation iPod nano and the second generation iPod nano can be connected via a USB device.
- Set AUX+ to OFF when an iPod is connected via the FULL SPEED™ connection cable (refer to "Setting the AUX+ Mode" on page 37).
- If the Bluetooth Box and an iPod are connected at the same time, be sure to disconnect the iPod from the Bluetooth Box while turning ACC to OFF.
- To watch the video screen of the file in the Video iPod (fifth generation iPod), using the USB connection and the Parking Brake must be engaged.

About iPods usable with this unit

- The unit can be used with the fourth generation and above iPod, iPod photo, iPod mini or the first, second generation iPod nano only. However, future generation iPod compatibility cannot be guaranteed.

<USB connected>

Fifth generation iPod
First generation iPod nano
Second generation iPod nano

<Directly connected>

Fourth generation iPod
Fifth generation iPod
iPod photo
iPod mini
First generation iPod nano
Second generation iPod nano

- If the unit is used with iPod software versions of iTunes earlier than 7.1.0.59, correct function and performance are not guaranteed.

Playback

1 Touch [SOURCE] on the main source screen.

The SOURCE selection screen is displayed.

2 Touch [iPod]*¹ or [iPod-2]*².

The display shows the iPod or iPod-2 mode screen.

*¹ Only when the iPod is connected by using the USB connector.

*² Only when the iPod is connected by using the iPod direct connector.

3 Touch [◀◀] or [▶▶] to select the desired song.

Return to the beginning of the current song:

Touch [◀◀].

Fast backward the current song:

Touch and hold [◀◀].

Advance to the beginning of the next song:

Touch [▶▶].

Fast forward the current song:

Touch and hold [▶▶].

4 To pause playback, touch [▶/||].

Touching [▶/||] again will resume playback.

- If a song is playing on the iPod when it is connected to the IVA-W502E, it will continue playing after the connection.

- If you listen to an episode from a selected podcast or audiobook, the episode can be changed by pressing EPISODE [▼] or [▲].
- An episode may have several chapters. The chapter can be changed by pressing [◀◀] or [▶▶].
- Display mode can be changed by touching [WIDE] when an iPod compatible video is connected by using USB connector. For details, refer to "Switching Display Modes" (page 26).
- If the artist, album or song name, created in iTunes, has too many characters, songs may not be played back when connected to the IVA-W502E. Therefore, a maximum of 250 characters is recommended. The maximum number of characters for the head unit is 128 (128 byte).
- Some characters may not be correctly displayed.
- "NO SUPPORT" is displayed when text information is not compatible with the IVA-W502E.

Searching for a desired Song

An iPod can contain hundreds of songs. By keeping these songs organized in playlists, the IVA-W502E can use these to ease song searches.

Using the search mode's individual hierarchy, you can narrow down your search as shown in the table below.

<MUSIC Search Menu>

Hierarchy 1	Hierarchy 2	Hierarchy 3	Hierarchy 4
Playlist	Song	—	—
Artist*	Album*	Song	—
Album*	Song	—	—
Song	—	—	—
Podcast	Episode	—	—
Genre*	Artist*	Album*	Song
Composer*	Album*	Song	—
Audiobook	—	—	—

- Video search mode depends on the iPod. If the specification of the iPod is changed, the search mode on this unit will also be changed.

For example: Searching by Artist name

The following example explains how an ARTISTS search is performed. Another search mode can be used for the same operation, although the hierarchy differs.

Searching by artist name

1 Touch [🔍].

The search mode is activated, and the search list screen appears.

- When an iPod compatible video is connected by using USB connector. Select the MUSIC or VIDEOS search mode by touching [➤] at first. If VIDEOS mode is selected, the Video playlists/Movies/Music Videos/TV Shows/Video Podcasts search mode may be used depending on the connected iPod. If MUSIC mode is selected the operation is as the same as follow.
- Touching [🔍] for at least 2 seconds will return to last search mode when the iPod is connected through the USB connector.

2 Touch [➤] of ARTISTS.

The ARTISTS search screen is displayed.

3 Select the desired artist.

To play back the artist directly

- 1 Touch [▶] next to the artist's name.
All songs of the selected artist are played back.

To search for the album of an artist

- 1 Touch [➤] of the selected artist.
The ALBUMS search screen of the selected artist is displayed.
- 2 Touch [▶] next to the desired album's name.
All songs of the selected album are played back.

To search for a song in the album of an artist

- 1 Touch [➤] of the desired album in "To search for the album of an artist" in step 2.
The SONGS search screen of the selected album is displayed.
 - 2 Touch [▶] next to the desired song's name.
The selected song is played back.
- Touching [▶] of ALL will play back all songs in the list when you are in a hierarchy with an asterisk "*" (see table on the previous page).
 - Touching [➤] of ALL will display the search list in the next hierarchy.
 - In search mode, you can jump to an assigned position by touching the direct search bar for quick search. For details, refer to "Direct Search Function" (page 60).
 - When search is made during M.I.X. play, the M.I.X. play mode will be cancelled.

Direct Search Function

The unit's direct search function can be used to search for an album, song, etc., more efficiently. In PLAYLISTS/ARTISTS/ALBUMS/SONGS/PODCASTS/GENRES/COMPOSERS/AUDIOBOOKS mode, you can quickly target any song.

Example of ALBUM search screen

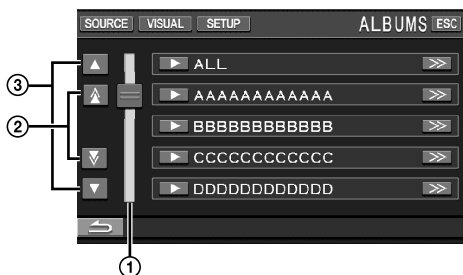

- ① Direct search bar.
- ② Scroll the list one chapter*¹ at a time by touching [▲] or [▼].
- ③ Scroll the list one line at a time by touching [▲] or [▼].

*¹ Titles are listed alphabetically, and can be skipped every 200 titles with the same beginning alphabetical character. If there are fewer than 200 titles, titles beginning with the next alphabetical character are selected for the USB connection mode (iPod mode). e.g. press [▼], switch to the section beginning with alphabet B from A. List is scrolled one page at a time for the iPod directly connection mode (iPod-2 mode).

In search mode, touch anywhere on the direct search bar, or touch and drag [≡] to the desired place.

The active point moves to the specified place, and the search list will be changed according to the selected song position.

<SONG search example>

If there are 100 songs in your iPod, all the songs are allocated in the direct search bar.

Suppose the song you are searching for is located at around the 50th song of your library; touch around the middle (50%) of the direct search bar to jump to the song you desire.

Selecting Playlist/Artist/Album/Genre/Composer/Category

Playlist/Artist/Album/Genre/Composer/Category*² can be easily changed.

For example, if you listen to a song from a selected album, the album can be changed.

Touch [▼] or [▲] to select the desired Playlist/Artist/Album/Genre/Composer/Category*².

*² CATEGORY can be changed only when an iPod compatible video is connected by using USB connector.

- If search selection mode is not activated, a SONG search is not possible.
- If an album is selected from an artist search, the album can be searched.
- During shuffle (M.I.X.) playback, this operation is not possible.

Random Play Shuffle (M.I.X.)

The Shuffle function of the iPod is displayed as M.I.X. on the IVA-W502E.

Shuffle ALL:

All songs in the iPod are played back in random sequence. Any one song does not play back again until all songs have been played back.

Shuffle Albums:

The songs on each album are played back in proper order. Upon completion of all the songs on the album, the next album is selected randomly. This continues until all albums have been played.

Shuffle Songs:

Song shuffle randomly plays back songs within a selected category (playlist, album, etc.). The songs within the category are played just once until all songs have been played.

1 Touch [ALL ∞]*.

The songs will be played back in random sequence.

M.I.X. ALL ↔ (off)
(Shuffle ALL)

Touch [∞] after touching [P1/2].

→ M.I.X. ALBUMS → M.I.X. SONGS → (off) →
(Shuffle Albums) (Shuffle Songs)

2 To cancel M.I.X. play, touch [ALL ∞] or [∞].

- For details of the search mode, refer to "Searching for a desired Song" (page 59).
- If a song is selected in the album search mode before selecting Shuffle (M.I.X.), the songs will not play back randomly even when Shuffle album is selected.

* This operation cannot be performed for the video iPod connected through the USB connector.

Repeat Play

Only Repeat One is available for the iPod.

Repeat One: A single song is repeatedly played back.

1 Touch [P1/2].

The function guide is displayed.

2 Touch [↻].

The file will be played repeatedly.

RPT	↔	(off)
(Repeat One)		(Repeat the list being played back)

3 To cancel repeat play, touch [↻].

- During repeat playback, no other songs are selectable by touching [◀◀] or [▶▶].

Information

About DVDs

Music CDs and DVDs have grooves (tracks) in which the digital data is recorded. The data is represented as microscopic pits recorded into the track – these pits are read by a laser beam to play the disc. On DVDs, the density of the tracks and pits is twice that of CDs, so DVDs can contain more data in less space.

CDs

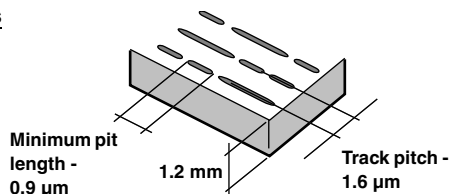

DVDs

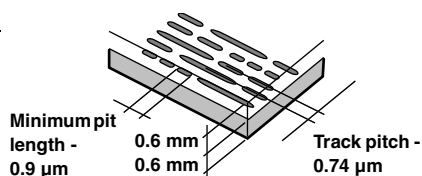

A 12 cm disc can contain one movie or about four hours of music. In addition, DVDs provide sharp picture quality with vivid colours thanks to a horizontal resolution of over 500 lines (compared to less than 300 for VHS tape). With the addition of an optional, digital audio processor (PXA-H701, etc.), you can recreate the power and presence of a movie theater with Dolby Digital 5.1-channel Surround.

In addition, DVDs offer a variety of functions.

Multiple audio* (page 23)

Movies can be recorded in up to eight languages. The desired language can be selected from the unit.

Subtitles function* (page 23)

Movies can include subtitles in up to 32 languages. The desired subtitle language can be selected from the unit.

Multi angle function* (page 23)

When the DVD contains a movie shot from multiple angles, the desired angle can be selected from the unit.

Multi story function*

With this function, a single movie includes various story lines. You can select different story lines to view various versions of the same movie.

Operation differs from disc to disc. Story line selection screens including instructions appear during the movie. Just follow the instructions.

* These functions differ from disc to disc. For details, refer to the disc's instructions.

Terminology

Dolby Digital

Dolby Digital is a digital audio compression technology developed by Dolby Laboratories that allows large quantities of audio data to be efficiently recorded on discs. It is compatible with audio signals from mono (1 channel) all the way up to 5.1-channel surround sound. The signals for the different channels are completely independent, and since the sound is high quality digital there is no loss of sound quality.

* *The separately sold digital audio processor (PXA-H701, etc.) is required to enjoy full 5.1-channel surround sound.*

The IVA-W502E performs Dolby Digital decoding when it outputs analog audio signals, it just happens to be 2-channel audio not 5.1-channel.

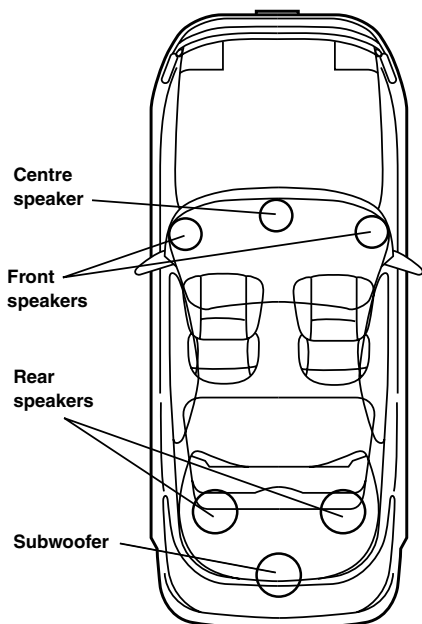

**Speaker layout for enjoying
Dolby Digital sound/DTS sound**

DTS

This is a home-use digital sound format of the DTS Sound System. This is a high quality sound system, developed by DTS, Inc. for use in movie theaters.

DTS has six independent sound tracks. The theater presentation is fully realized in the home and other settings. DTS is the abbreviation for Digital Theater System.

* *To enjoy DTS surround sound you need the separately sold DTS digital audio processor (PXA-H701, etc.). The DVD video software must also have a DTS sound track.*

The IVA-W502E has a built-in DTS 2-channel audio decoder. Analog audio outputs are available.

Dolby Pro Logic II

Dolby Pro Logic II plays 2-channel sources in 5 channels over the entire frequency range.

This is done with an advance, high sound quality matrix surround decoder which draws out the spatial properties of the original recording without adding any sounds to or changing the sound of the source.

* *The separately sold digital audio processor (PXA-H701, etc.) is required to enjoy Dolby Pro Logic II surround sound.*

Linear PCM audio (LPCM)

LPCM is a signal recording format used for music CDs. Whereas music CDs are recorded at 44.1 kHz/16 bits, DVDs are recorded at 48 kHz/16 bits to 96 kHz/24 bits, thereby achieving higher sound quality than music CDs.

Rating levels (parental lock)

This is a function of the DVD for restricting the viewing age as stipulated by laws in different countries. The way in which viewing is restricted differs from DVD to DVD. Sometimes the DVD cannot be played at all, other times certain scenes are skipped, and other times certain scenes are replaced with other scenes.

List of Language Codes

(For details, see page 28.)

Abbreviation	Code	Language	Abbreviation	Code	Language	Abbreviation	Code	Language
AA	6565	Afar	IE	7369	Interlingue	RN	8278	Kirundi
AB	6566	Abkhazian	IK	7375	Inupiak	RO	8279	Romanian
AF	6570	Afrikaans	IN	7378	Indonesian	RU	8285	Russian
AM	6577	Amharic	IS	7383	Icelandic	RW	8287	Kinyarwanda
AR	6582	Arabic	IT	7384	Italian	SA	8365	Sanskrit
AS	6583	Assamese	IW	7387	Hebrew	SD	8368	Sindhi
AY	6589	Aymara	JA	7465	Japanese	SG	8371	Sangho
AZ	6590	Azerbaijani	JL	7473	Yiddish	SH	8372	Serbo-Croatian
BA	6665	Bashkir	JW	7487	Javanese	SI	8373	Singhalese
BE	6669	Byelorussian	KA	7565	Georgian	SK	8375	Slovak
BG	6671	Bulgarian	KK	7575	Kazakh	SL	8376	Slovenian
BH	6672	Bihari	KL	7576	Greenlandic	SM	8377	Samoan
BI	6673	Bislama	KM	7577	Cambodian	SN	8378	Shona
BN	6678	Bengali, Bangla	KN	7578	Kannada	SO	8379	Somali
BO	6679	Tibetan	KO	7579	Korean	SQ	8381	Albanian
BR	6682	Breton	KS	7583	Kashmiri	SR	8382	Serbian
CA	6765	Catalan	KU	7585	Kurdish	SS	8383	Siswati
CO	6779	Corsican	KY	7589	Kirghiz	ST	8384	Sesotho
CS	6783	Czech	LA	7665	Latin	SU	8385	Sundanese
CY	6789	Welsh	LN	7678	Lingala	SV	8386	Swedish
DA	6865	Danish	LO	7679	Laothian	SW	8387	Swahili
DE	6869	German	LT	7684	Lithuanian	TA	8465	Tamil
DZ	6890	Bhutani	LV	7686	Latvian, Lettish	TE	8469	Telugu
EL	6976	Greek	MG	7771	Malagasy	TG	8471	Tajik
EN	6978	English	MI	7773	Maori	TH	8472	Thai
EO	6979	Esperanto	MK	7775	Macedonian	TI	8473	Tigrinya
ES	6983	Spanish	ML	7776	Malayalam	TK	8475	Turkmen
ET	6984	Estonian	MN	7778	Mongolian	TL	8476	Tagalog
EU	6985	Basque	MO	7779	Moldavian	TN	8478	Setswana
FA	7065	Persian	MR	7782	Marathi	TO	8479	Tonga
FI	7073	Finnish	MS	7783	Malay	TR	8482	Turkish
FJ	7074	Fiji	MT	7784	Maltese	TS	8483	Tsonga
FO	7079	Faroese	MY	7789	Burmese	TT	8484	Tatar
FR	7082	French	NA	7865	Nauru	TW	8487	Twi
FY	7089	Frisian	NE	7869	Nepali	UK	8575	Ukrainian
GA	7165	Irish	NL	7876	Dutch	UR	8582	Urdu
GD	7168	Scots Gaelic	NO	7879	Norwegian	UZ	8590	Uzbek
GL	7176	Galician	OC	7967	Occitan	VI	8673	Vietnamese
GN	7178	Guarani	OM	7977	(Afan) Oromo	VO	8679	Volapuk
GU	7185	Gujarati	OR	7982	Oriya	WO	8779	Wolof
HA	7265	Hausa	PA	8065	Punjabi	XH	8872	Xhosa
HI	7273	Hindi	PL	8076	Polish	YO	8979	Yoruba
HR	7282	Croatian	PS	8083	Pashto, Pushto	ZH	9072	Chinese
HU	7285	Hungarian	PT	8084	Portuguese	ZU	9085	Zulu
HY	7289	Armenian	QU	8185	Quechua			
IA	7365	Interlingua	RM	8277	Rhaeto-Romance			

List of Country Codes

(For details, see page 28.)

Abbreviation	Code	Country	Abbreviation	Code	Country	Abbreviation	Code	Country
AD	6568	Andorra	DM	6877	Dominica	KI	7573	Kiribati
AE	6569	United Arab Emirates	DO	6879	Dominican Republic	KM	7577	Comoros
AF	6570	Afghanistan	DZ	6890	Algeria	KN	7578	Saint Kitts and Nevis
AG	6571	Antigua and Barbuda	EC	6967	Ecuador	KP	7580	Korea, Democratic People's Republic of
AI	6573	Anguilla	EE	6969	Estonia			
AL	6576	Albania	EG	6971	Egypt	KR	7582	Korea, Republic of
AM	6577	Armenia	EH	6972	Western Sahara	KW	7587	Kuwait
AN	6578	Netherlands Antilles	ER	6982	Eritrea	KY	7589	Cayman Islands
AO	6579	Angola	ES	6983	Spain	KZ	7590	Kazakhstan
AQ	6581	Antarctica	ET	6984	Ethiopia	LA	7665	Lao People's Democratic Republic
AR	6582	Argentina	FI	7073	Finland			
AS	6583	American Samoa	FJ	7074	Fiji	LB	7666	Lebanon
AT	6584	Austria	FK	7075	Falkland Islands	LC	7667	Saint Lucia
AU	6585	Australia	FM	7077	Micronesia, Federated States of	LI	7673	Liechtenstein
AW	6587	Aruba	FO	7079	Faroe Islands	LK	7675	Sri Lanka
AZ	6590	Azerbaijan	FR	7082	France	LR	7682	Liberia
BA	6665	Bosnia and Herzegovina	GA	7165	Gabon	LS	7683	Lesotho
BB	6666	Barbados	GB	7166	United Kingdom	LT	7684	Lithuania
BD	6668	Bangladesh	GD	7168	Grenada	LU	7685	Luxembourg
BE	6669	Belgium	GE	7169	Georgia	LV	7686	Latvia
BF	6670	Burkina Faso	GF	7170	French Guiana	LY	7689	Libyan Arab Jamahiriya
BG	6671	Bulgaria	GH	7172	Ghana	MA	7765	Morocco
BH	6672	Bahrain	GI	7173	Gibraltar	MC	7767	Monaco
BI	6673	Burundi	GL	7176	Greenland	MD	7768	Moldova, Republic of
BJ	6674	Benin	GM	7177	Gambia	MG	7771	Madagascar
BM	6677	Bermuda	GN	7178	Guinea	MH	7772	Marshall Islands
BN	6678	Brunei Darussalam	GP	7180	Guadeloupe	MK	7775	Macedonia, The former Yugoslav Republic of
BO	6679	Bolivia	GQ	7181	Equatorial Guinea			
BR	6682	Brazil	GR	7182	Greece	ML	7776	Mali
BS	6683	Bahamas	GS	7183	South Georgia and the South Sandwich Islands	MM	7777	Myanmar
BT	6684	Bhutan				MN	7778	Mongolia
BV	6686	Bouvet Island	GT	7184	Guatemala	MO	7779	Macau
BW	6687	Botswana	GU	7185	Guam	MP	7780	Northern Mariana Islands
BY	6689	Belarus	GW	7187	Guinea-Bissau	MQ	7781	Martinique
BZ	6690	Belize	GY	7189	Guyana	MR	7782	Mauritania
CA	6765	Canada	HK	7275	Hong Kong	MS	7783	Montserrat
CC	6767	Cocos (Keeling) Islands	HM	7277	Heard Island and McDonald Islands	MT	7784	Malta
CD	6768	Congo, the Democratic Republic of the				MU	7785	Mauritius
CF	6770	Central African Republic	HN	7278	Honduras	MV	7786	Maldives
CG	6771	Congo	HR	7282	Croatia	MW	7787	Malawi
CH	6772	Switzerland	HT	7284	Haiti	MX	7788	Mexico
CI	6773	Cote d'Ivoire	HU	7285	Hungary	MY	7789	Malaysia
CK	6775	Cook Islands	ID	7368	Indonesia	MZ	7790	Mozambique
CL	6776	Chile	IE	7369	Ireland	NA	7865	Namibia
CM	6777	Cameroon	IL	7376	Israel	NC	7867	New Caledonia
CN	6778	China	IN	7378	India	NE	7869	Niger
CO	6779	Colombia	IO	7379	British Indian Ocean Territory	NF	7870	Norfolk Island
CR	6782	Costa Rica	IQ	7381	Iraq	NG	7871	Nigeria
CU	6785	Cuba	IR	7382	Iran, Islamic Republic of	NI	7873	Nicaragua
CV	6786	Cape Verde	IS	7383	Iceland	NL	7876	Netherlands
CX	6788	Christmas Island	IT	7384	Italy	NO	7879	Norway
CY	6789	Cyprus	JM	7477	Jamaica	NP	7880	Nepal
CZ	6790	Czech Republic	JO	7479	Jordan	NR	7882	Nauru
DE	6869	Germany	JP	7480	Japan	NU	7885	Niue
DJ	6874	Djibouti	KE	7569	Kenya	NZ	7890	New Zealand
DK	6875	Denmark	KG	7571	Kyrgyzstan	OM	7977	Oman
			KH	7572	Cambodia	PA	8065	Panama

Abbreviation	Code	Country	Abbreviation	Code	Country	Abbreviation	Code	Country
PE	8069	Peru	SJ	8374	Svalbard and Jan Mayen	TW	8487	Taiwan, Province of China
PF	8070	French Polynesia	SK	8375	Slovakia	TZ	8490	Tanzania, United Republic of
PG	8071	Papua New Guinea	SL	8376	Sierra Leone	UA	8565	Ukraine
PH	8072	Philippines	SM	8377	San Marino	UG	8571	Uganda
PK	8075	Pakistan	SN	8378	Senegal	UM	8577	United States Minor Outlying Islands
PL	8076	Poland	SO	8379	Somalia	US	8583	United States
PM	8077	Saint Pierre and Miquelon	SR	8382	Suriname	UY	8589	Uruguay
PN	8078	Pitcairn	ST	8384	Sao Tome and Principe	UZ	8590	Uzbekistan
PR	8082	Puerto Rico	SV	8386	El Salvador	VA	8665	Holy See (Vatican City State)
PT	8084	Portugal	SY	8389	Syrian Arab Republic	VC	8667	Saint Vincent and the Grenadines
PW	8087	Palau	SZ	8390	Swaziland	VE	8669	Venezuela
PY	8089	Paraguay	TC	8467	Turks and Caicos Islands	VG	8671	Virgin Island, British
QA	8165	Qatar	TD	8468	Chad	VI	8673	Virgin Islands, U.S
RE	8269	Reunion	TF	8470	French Southern Territories	VN	8678	Viet Nam
RO	8279	Romania	TG	8471	Togo	VU	8685	Vanuatu
RU	8285	Russian Federation	TH	8472	Thailand	WF	8770	Wallis and Futuna
RW	8287	Rwanda	TJ	8474	Tajikistan	WS	8783	Samoa
SA	8365	Saudi Arabia	TK	8475	Tokelau	YE	8969	Yemen
SB	8366	Solomon Islands	TM	8477	Turkmenistan	YT	8984	Mayotte
SC	8367	Seychelles	TN	8478	Tunisia	YU	8985	Yugoslavia
SD	8368	Sudan	TO	8479	Tonga	ZA	9065	South Africa
SE	8369	Sweden	TP	8480	East Timor	ZM	9077	Zambia
SG	8371	Singapore	TR	8482	Turkey	ZW	9087	Zimbabwe
SH	8372	Saint Helena	TT	8484	Trinidad and Tobago			
SI	8373	Slovenia	TV	8486	Tuvalu			

In Case of Difficulty

If you encounter a problem, please turn the power off, then on again. If the unit is still not functioning normally, please review the items in the following checklist. This guide will help you isolate the problem if the unit is at fault. Otherwise, make sure the rest of your system is properly connected, or then consult your authorized Alpine dealer.

Basic

No function or display.

- Vehicle's ignition is off.
 - If connected according to the instructions, the unit will not operate with the vehicle's ignition off.
- Improper power lead connections.
 - Check power lead connections.
- Blown fuse.
 - Check the fuse on the battery lead of the unit; replace with the proper value if necessary.
- Internal micro-computer malfunctioned due to interference noise, etc.
 - Press the RESET switch with a ballpoint pen or other pointed article.
- Blackout mode is activated.
 - Cancel Blackout mode.

No sound or unnatural sound.

- Incorrect setting of volume/balance/fader controls.
 - Readjust the controls.
- Connections are not properly or securely made.
 - Check the connections and firmly connect.

Screen not displayed.

- Brightness control is set at the minimum position.
 - Adjust the Brightness control.
- Temperature in the vehicle is too low.
 - Increase the vehicle's interior temperature to operation temperature range.
- Connections to the DVD, CD player, navigation system are not securely made.
 - Check the connections and firmly connect.

Movement of displayed picture is abnormal.

- Temperature in the vehicle is too high.
 - Allow the vehicle's interior temperature to cool.

Unclear or noisy display.

- Fluorescent plate is worn out.
 - Replace the fluorescent plate.

Navigation system inoperative.

- Connections to the navigation system are incorrect.
 - Check the connections with the navigation system and connect the cables correctly and firmly.

The optional remote control is inoperative.

- The remote control sensor setting of "Rear Entertainment Function" is not set to this unit.
 - Set for this unit.

Unclear picture display.

- Fluorescent tube is exhausted.
 - Replace the fluorescent tube*.

* The fluorescent tube replacement is not free of charge even within the warranty period, for the tube is an article of consumption.

Radio

Unable to receive stations.

- No antenna, or open connection in the antenna cable.
 - Make sure the antenna is properly connected; replace the antenna or cable if necessary.

Unable to tune stations in the seek mode.

- You are in a weak signal area.
 - Make sure the tuner is in DX mode.
- If the area you are in is a primary signal area, the antenna may not be grounded and connected properly.
 - Check your antenna connections; make sure the antenna is properly grounded at its mounting location.
- The antenna may not be the proper length.
 - Make sure the antenna is fully extended; if broken, replace the antenna with a new one.

Broadcast is noisy.

- The antenna is not the proper length.
 - Extend the antenna fully; replace it if it is broken.
- The antenna is poorly grounded.
 - Make sure the antenna is grounded properly at its mounting location.
- The station signal is weak and noisy.
 - If above solution does not work, tune in another station.

CD/MP3/WMA/AAC/DVD/Video CD

Disc playback sound is wavering.

- Moisture condensation in the disc Module.
 - Allow enough time for the condensation to evaporate (about 1 hour).

Disc insertion not possible.

- A disc is already in the DVD player.
 - Eject the disc and remove it.
- The disc is being improperly inserted.
 - Make sure the disc is being inserted following the instructions in the CD/MP3/WMA/AAC, DVD/Video CD Player Operation section.

Unable to fast forward or backward the disc.

- The disc has been damaged.
 - Eject the disc and discard it; using a damaged disc in your unit can cause damage to the mechanism.

Disc playback sound skips due to vibration.

- Improper mounting of the unit.
 - Securely re-mount the unit.
- Disc is very dirty.
 - Clean the disc.
- Disc has scratches.
 - Change the disc.
- The pick-up lens is dirty.
 - Do not use a commercially available lens cleaner disc. Consult your nearest Alpine dealer.

Disc playback sound skips without vibration.

- Dirty or scratched disc.
 - Clean the disc; damaged disc should be replaced.

CD-R/CD-RW playback not possible.

- Close session (finalisation) has not been performed.
 - Perform finalisation and attempt playback again.

Error displays.

- Mechanical error.
 - Press **OPEN**. After the error indication disappears, insert the disc again. If the above-mentioned solution does not solve the problem, consult your nearest Alpine dealer.

MP3/WMA/AAC is not played back.

- Writing error occurred. The CD format is not compatible.
 - Make sure the CD has been written in a supported format. Refer to "About MP3/WMA/AAC" (pages 16 and 17), then rewrite in the format supported by this device.

Unit does not operate.

- Monitor's power is not turned on.
 - Turn on the monitor's power.
- Condensation.
 - Wait a while (about 1 hour) for the condensation to dry.

No picture is produced.

- Monitor's mode is not switched to the mode you want to see.
 - Switch to the mode you want to see.
- Monitor's parking brake lead is not connected.
 - Connect the monitor's parking brake wire and set the parking brake. (For details, refer to the monitor's instructions.)

Playback does not start.

- Disc is loaded upside-down.
 - Check the disc and load it with the labeled side facing upward.
- Disc is dirty.
 - Clean the disc.
- A disc not able to play back with this unit is loaded.
 - Check if the disc is able to be played back.
- Parental lock is set.
 - Cancel the parental lock or change the rating level.

Picture is unclear or noisy.

- Disc is being fast-forwarded or fast-reversed.
 - The picture may be slightly disturbed, but this is normal.
- Vehicle's battery power is weak.
 - Check the battery power and wiring.
(The unit may malfunction if the battery power is under 11 volts with a load applied.)
- Monitor's fluorescent tube is worn.
 - Replace the monitor's fluorescent tube.

Image stops sometimes.

- Disc is scratched.
 - Replaced with a non-scratched disc.

Playing back a DRM protected DivX® File

Some operations cannot be performed while displaying the following message.

"Authorization Error

This player is not authorized to play this video."

- If an unauthorized DRM protected DivX® file is played back, the following message is displayed for 2 seconds: "Authorization Error This player is not authorized to play this video." This means the file's registration code does not match the player's and cannot be played back. After the message has been displayed, the beginning of the next file will automatically begin playing.

"Rental Expired"

- A DivX® rental is set for a fixed number of viewings. If viewing time has counted down to 0, "Rental Expired" is displayed for 2 seconds. This indicates that the file can no longer be played. After the message has been displayed, the beginning of the next file will automatically begin playing.

"Rental countdown OK?"

- While playing back a rental file, if B.SKIP or ENTER is selected in the file selection menu, "Rental countdown OK?" is displayed. The rental file playback is interrupted (viewing time is reduced by 1). To confirm stopping playback, touch [YES] or touch [NO] to continue playing the file.

"View DivX® VOD Rental

This rental has (remaining times) views left.

Do you want to use one of your (remaining times) views now?"

- If audio/visual times still remain, the remaining number of playback times is displayed. To play back, touch [YES]. If the next file is to be played back, touch [NO].

Indication for CD/MP3/WMA/AAC

NO DISC

- No disc is inserted.
 - Insert a disc.
- Although a disc is inserted, "NO DISC" is displayed and the unit does not start to play or eject the disc.
 - Remove the disc by following these steps.
Press **OPEN** for at least 3 seconds.

LOADING ERROR

EJECT ERROR

- Mechanism error.
 - 1) Press **OPEN** and eject the disc.
If not ejecting, consult your Alpine dealer.
 - 2) When the error indication remains after ejecting, press **OPEN** again.
If the error indication still does not turn off after pressing **OPEN** for a few times, consult your Alpine dealer.
- Disc was forcibly pulled out by hand during Auto Loading.
 - When the error indication remains after loading, try to load again. If the error indication still does not turn off after pressing for a few times, consult your Alpine dealer.

DISC ERROR

- Scratched disc, contaminated disc/poor recording/disc incompatible with this unit.
 - Press **OPEN**.
 - Change the disc.

PROTECT

- A copy-protected WMA file was played back.
 - You can only play back non-copy-protected files.

UNSUPPORTED

- A sampling rate/bit rate not supported by the unit is used.
 - Use a sampling rate/bit rate is supported by the unit.

Indication for DVD/Video CD

NO DISC

- No disc is inserted.
 - Insert a disc.
- Although a disc is inserted, "NO DISC" is displayed and the unit does not start to play or eject the disc.
 - Remove the disc by following these steps.
 - Press **OPEN** for at least 3 seconds.



- Button operation on the unit or optional remote control is not possible.
 - For some discs or playing modes, certain operations are not possible. This is not a malfunction.

REGIONAL CODE VIOLATION

- Disc does not match regional code number.
 - Load a disc that matches the regional code number.

LOADING ERROR

EJECT ERROR

- Mechanism error.
 - 1) Press **OPEN** and eject the disc.
 - If not ejecting, consult your Alpine dealer.
 - 2) When the error indication remains after ejecting, press **OPEN** again.
 - If the error indication still does not turn off after pressing **OPEN** for a few times, consult your Alpine dealer.

DISC ERROR

- Scratched disc, contaminated disc/poor recording/disc incompatible with this unit.
 - Press **OPEN**.
 - Change the disc.

EJECT DISC BEFORE USING DVD-SETUP

- The DVD setup operation was attempted when a disc is inserted in the unit.
 - Eject the disc before the DVD setup operation.

UNSUPPORTED

(DivX[®] mode)

- A sampling rate/bit rate not supported by the unit is used.
 - Use a sampling rate/bit rate that is supported by the unit.

Indication for CD changer

HI-TEMP

- Protective circuit is activated due to high temperature.
 - The indicator will disappear when the temperature returns to within operation range.

ERROR01

- Malfunction in the CD Changer.
 - Consult your Alpine dealer. Press the magazine eject button and pull out the magazine.
 - Check the indication. Insert the magazine again.
 - If the magazine cannot be pulled out, consult your Alpine dealer.
- Magazine ejection not possible.
 - Press the magazine eject button. If the magazine does not eject, consult your Alpine dealer.

ERROR02

- A disc is left inside the CD Changer.
 - Press the eject button to activate the eject function. When the CD Changer finishes the eject function, insert an empty CD magazine into the CD Changer to receive the disc left inside the CD Changer.

NO MAGAZINE

- No magazine is loaded into the CD Changer.
 - Insert a magazine.

NO DISC

- No indicated disc.
 - Choose another disc.

Indication for iPod Mode

NO iPod

- The iPod is not connected.
 - Make sure the iPod is correctly connected.
 - Make sure the cable is not bent excessively.

NO SONG

- There are no songs in the iPod.
 - Download songs to the iPod and connect to the IVA-W502E.

ERROR01

- Communication error.
 - Turn the ignition key off, and then set to ON again.
 - Check the display by reconnecting between the iPod and the unit, using the iPod cable.

ERROR02

- Caused by the iPod Software Version not being compatible with this unit.
 - Update the iPod Software Version to be compatible with this unit.
-

ERROR03

- Indication error
 - Turn the ignition key off, and then set to ON again.
 - Check the display by reconnecting between the iPod and the unit, using the iPod cable.

Indication for USB memory

CURRENT ERROR

- Abnormal current is run to the USB connector device. USB memory is a malfunction or it is shorted.
 - Connect another USB memory.
-

USB DEVICE ERROR

- A USB device that is not supported by the unit is connected.
 - Connect a USB device that is supported by the unit.
-

NO USB DEVICE

- A USB memory is not connected.
 - Make sure the USB memory device is correctly connected and the cable is not excessively bent.
-

ERROR01

- A USB memory is not connected.
 - Make sure the USB memory device is correctly connected and the cable is not excessively bent.
-

ERROR02

- Caused by the iPod Software Version not being compatible with this unit.
 - Update the iPod Software Version to be compatible with this unit.
-

ERROR03

- Indication error
 - Turn the ignition key off, and then set to ON again.
 - Check the display by reconnecting between the iPod and the unit, using the iPod cable.
-

Specifications

MONITOR SECTION

Screen Size	7.0"
LCD Type	Transparent type TN LCD
Operation System	TFT active matrix
Number of Picture Elements	1,152,000 pcs. (800 × 3 × 480)
Effective Number of Picture Elements	99% or more
Illumination System	LED

FM TUNER SECTION

Tuning Range	87.5 – 108.0 MHz
Mono Usable Sensitivity	9 dBf (0.8 μ V/75 ohms)
50 dB Quieting Sensitivity	9 dBf (1.3 μ V/75 ohms)
Alternate Channel Selectivity	80 dB
Signal-to-Noise Ratio	60 dB
Stereo Separation	30 dB
Capture Ratio	2.0 dB

AM TUNER SECTION

Tuning Range	531 – 1,602 kHz
Usable Sensitivity	22.5 μ V/27 dBf

USB SECTION

USB requirements	USB 1.1/2.0
Max. Power Consumption	500mA
USB Class	USB (Play From Device)/USB (Mass Storage Class)
File System	FAT12/16/32
MP3 Decoding	MPEG-1/2 AUDIO Layer-3
WMA Decoding	Windows Media™ Audio
AAC Decoding	AAC-LC format “.m4a” file
Number of Channels	2-Channel (Stereo)
Frequency Response*	5-20,000 Hz (\pm 1 dB)
Total Harmonic Distortion	0.008% (at 1 kHz)
Dynamic Range	95 dB (at 1 kHz)
Signal-to-Noise Ratio	105 dB
Channel Separation	85 dB (at 1 kHz)

* Frequency response may differ depending on the encoder software/bit rate.

CD/DVD SECTION

Frequency Response	5 – 20,000 Hz
Wow & Flutter (% WRMS)	Below measurable limits
Total Harmonic Distortion	0.02% (at 1 kHz)
Dynamic Range	95 dB (at 1 kHz)
Channel Separation	65 dB (at 1 kHz)
Signal system	NTSC / PAL
Horizontal resolution	500 lines or greater
Video output level	1Vp-p (75 ohms)
Video S/N ratio	DVD: 60 dB
Audio S/N ratio	More than 95 dB

GENERAL

Power Requirement	14.4 V DC (11–16 V allowable)
Operating temperature	+32°F to +113°F (0°C to +45°C)
Maximum Power Output	50 W × 4
Output Voltage	2,000 mV/10k ohms
Bass	\pm 14 dB at 60 Hz
Treble	\pm 14 dB at 10 kHz
Weight	2.7 kg (5 lbs. 15 oz)
Audio output level	
Preout (Front, Rear):	2V/10k ohms (max.)
Preout (Subwoofer):	2V/10k ohms (max.)
AUX OUT:	1.2V/10k ohms
Ai-NET:	850 mV

CHASSIS SIZE

Width	178 mm (7")
Height	100 mm (3-15/16")
Depth	160.5 mm (6-3/8")

- Due to continuous product improvement, specifications and design are subject to change without notice.
- The LCD panel is manufactured using an extremely high precision manufacturing technology. Its effective pixel ratio is over 99.99%. This means that there is a possibility that 0.01% of the pixels could be either always ON or OFF.

Installation and Connections

Before installing or connecting the unit, please read the following and pages 4 to 6 of this manual thoroughly for proper use.

Warning

MAKE THE CORRECT CONNECTIONS.

Failure to make the proper connections may result in fire or product damage.

USE ONLY IN CARS WITH A 12 VOLT NEGATIVE GROUND.

(Check with your dealer if you are not sure.) Failure to do so may result in fire, etc.

BEFORE WIRING, DISCONNECT THE CABLE FROM THE NEGATIVE BATTERY TERMINAL.

Failure to do so may result in electric shock or injury due to electrical shorts.

DO NOT ALLOW CABLES TO BECOME ENTANGLED IN SURROUNDING OBJECTS.

Arrange wiring and cables in compliance with the manual to prevent obstructions when driving. Cables or wiring that obstruct or hang up on places such as the steering wheel, shift lever, brake pedals, etc. can be extremely hazardous.

DO NOT SPLICE INTO ELECTRICAL CABLES.

Never cut away cable insulation to supply power to other equipment. Doing so will exceed the current carrying capacity of the wire and result in fire or electric shock.

DO NOT DAMAGE PIPE OR WIRING WHEN DRILLING HOLES.

When drilling holes in the chassis for installation, take precautions so as not to contact, damage or obstruct pipes, fuel lines, tanks or electrical wiring. Failure to take such precautions may result in fire.

DO NOT USE BOLTS OR NUTS IN THE BRAKE OR STEERING SYSTEMS TO MAKE GROUND CONNECTIONS.

Bolts or nuts used for the brake or steering systems (or any other safety-related system), or tanks should NEVER be used for installations or ground connections. Using such parts could disable control of the vehicle and cause fire etc.

KEEP SMALL OBJECTS SUCH AS BOLTS OR SCREWS OUT OF THE REACH OF CHILDREN.

Swallowing them may result in serious injury. If swallowed, consult a physician immediately.

DO NOT INSTALL IN LOCATIONS WHICH MIGHT HINDER VEHICLE OPERATION, SUCH AS THE STEERING WHEEL OR SHIFT LEVER.

Doing so may obstruct forward vision or hamper movement etc. and results in serious accident.

Caution

HAVE THE WIRING AND INSTALLATION DONE BY EXPERTS.

The wiring and installation of this unit requires special technical skill and experience. To ensure safety, always contact the dealer where you purchased this product to have the work done.

USE SPECIFIED ACCESSORY PARTS AND INSTALL THEM SECURELY.

Be sure to use only the specified accessory parts. Use of other than designated parts may damage this unit internally or may not securely install the unit in place. This may cause parts to become loose resulting in hazards or product failure.

ARRANGE THE WIRING SO IT IS NOT CRIMPED OR PINCHED BY A SHARP METAL EDGE.

Route the cables and wiring away from moving parts (like the seat rails) or sharp or pointed edges. This will prevent crimping and damage to the wiring. If wiring passes through a hole in metal, use a rubber grommet to prevent the wire's insulation from being cut by the metal edge of the hole.

DO NOT INSTALL IN LOCATIONS WITH HIGH MOISTURE OR DUST.

Avoid installing the unit in locations with high incidence of moisture or dust. Moisture or dust that penetrates into this unit may result in product failure.

Precautions

- Be sure to disconnect the cable from the (-) battery post before installing your IVA-W502E. This will reduce any chance of damage to the unit in case of a short-circuit.
- Be sure to connect the colour coded leads according to the diagram. Incorrect connections may cause the unit to malfunction or damage to the vehicle's electrical system.
- When making connections to the vehicle's electrical system, be aware of the factory installed components (e.g. on-board computer). Do not tap into these leads to provide power for this unit. When connecting the IVA-W502E to the fuse box, make sure the fuse for the intended circuit of the IVA-W502E has the appropriate amperage. Failure to do so may result in damage to the unit and/or the vehicle. When in doubt, consult your Alpine dealer.
- The IVA-W502E uses female RCA-type jacks for connection to other units (e.g. amplifier) having RCA connectors. You may need an adaptor to connect other units. If so, please contact your authorized Alpine dealer for assistance.
- Be sure to connect the speaker (-) leads to the speaker (-) terminal. Never connect left and right channel speaker cables to each other or to the vehicle body.
- The Display must be completely retracted in the casing when installing. If it is not, problems may occur.
- When installing in automobiles, make sure the Display can open/close without coming in contact with the shift lever.

IMPORTANT

Please record the serial number of your unit in the space provided below and keep it as a permanent record. The serial number plate is located on the bottom of the unit.

SERIAL NUMBER: _____
INSTALLATION DATE: _____
INSTALLATION TECHNICIAN: _____
PLACE OF PURCHASE: _____

Installation

Caution

Do not block the unit's fan or heat sink, thus preventing air circulation. If blocked, heat will accumulate inside the unit and may cause a fire.

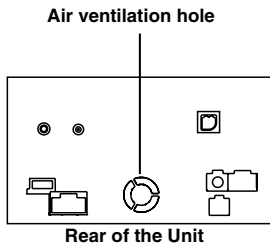

Caution concerning the installation location

- 1 Before installing, make sure that the opening and closing of the display will not interfere with operation of the shift lever.

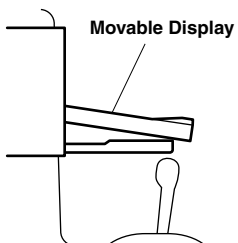

2 Angle of installation

Install at an angle of between horizontal and 30°. Note that installing at an angle outside of this range will result in a loss of performance and possibly damage.

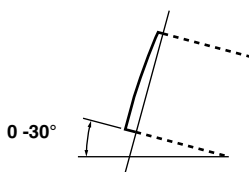

- 3 Remove the mounting sleeve from the main unit (see "Removal" on page 73).

The unit can be installed in the mounting sleeve in three positions by aligning its mounting holes (A to C) on the sides of the unit. Position A will be used in most cases. If B or C are to be used, the hole positions need to be modified.

First, determine the mounting position in the mounting sleeve, then affix the supplied seal (refer to "How to use a Seal").

Slide the unit into the mounting sleeve and secure it.

- If B or C is used, make sure that there is enough space depthwise before installing the unit. If the unit is forcibly pushed into the mounting sleeve, damage may occur.

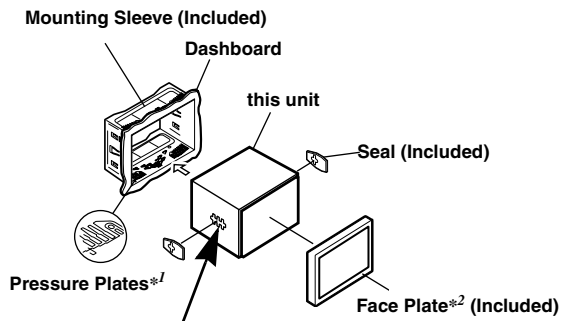

<Mounting Hole Position>

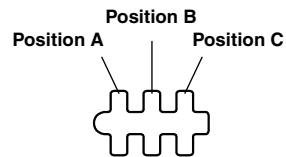

- Depending on the position chosen, the front panel will protrude differently.

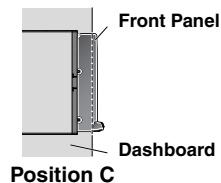
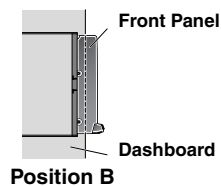
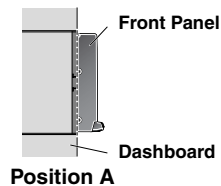

*1 If the installed mounting sleeve is loose in the dashboard, the pressure plates may be bent slightly to remedy the problem.

How to use a Seal

If A is used for installation:

Affix the seal so that mounting holes B and C are covered.

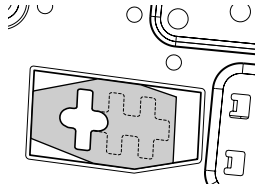

If B is used for installation:

Affix the seal so that mounting holes A and C are covered.

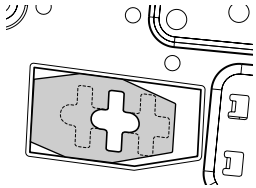

If C is used for installation:

Affix the seal so that the mounting holes A and B are covered.

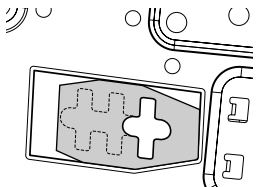

Installing the Face Plate

^{*2} If A is used, the supplied face plate may be mounted.

If B is used, the face plate must be modified before installing it.

To modify the face plate, consult your Alpine dealer.

If C is used, the face plate cannot be mounted. Consult your Alpine dealer.

4

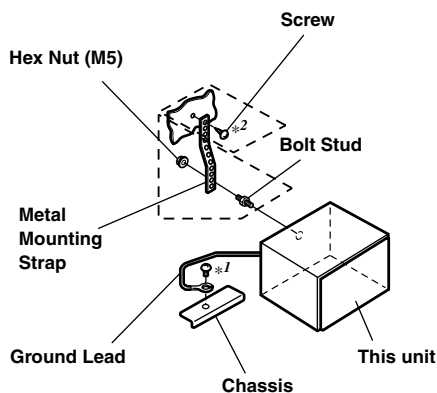

Reinforce the head unit with the metal mounting strap (not supplied). Secure the ground lead of the unit to a clean metal spot using a screw (^{*1}) already attached to the vehicle's chassis.

- For the screw marked "^{*2}", use an appropriate screw for the chosen mounting location.

Connect each input lead coming from an amplifier or equalizer to the corresponding output lead coming from the left rear of the IVA-W502E. Connect all other leads of the IVA-W502E according to details described in the CONNECTIONS section.

- 5 Slide the IVA-W502E into the dashboard until it clicks. This ensures that the unit is properly locked and will not accidentally come out from the dashboard.

Removal

1. Insert the bracket keys into the unit, along the guides on either side. The unit can now be removed from the mounting sleeve.

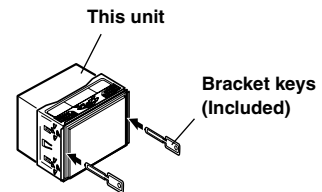

2. Pull the unit out, keeping it unlocked as you do so.

<JAPANESE CAR>

Take the face plate off, and secure the ground lead of the unit to a clean metal spot using a screw (^{*}) already attached to the car's chassis.

Attach the Original Mounting Bracket to each side of the IVA-W502E, using the screws supplied with IVA-W502E.

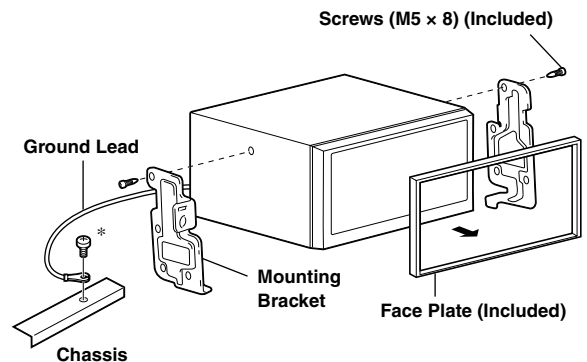

Connection Diagram of SPST Switch (Sold Separately)

(If the ACC power supply is not available)

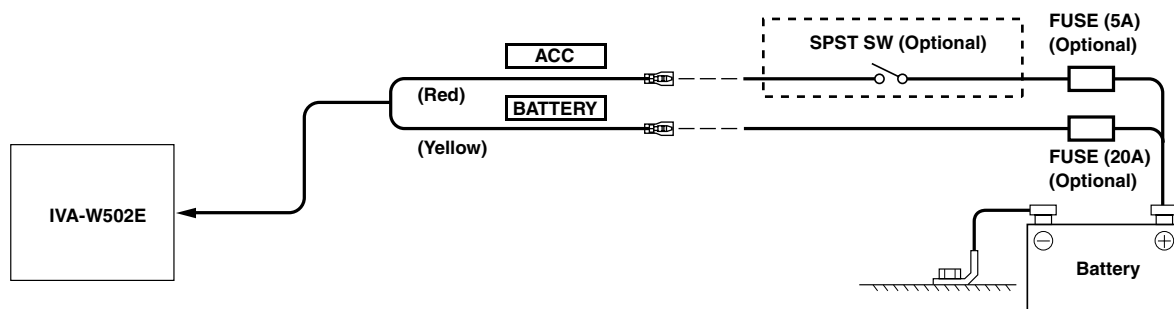

- If your vehicle has no ACC power supply, add an SPST (Single-Pole, Single-Throw) switch (sold separately) and fuse (sold separately).
- The diagram and the fuse amperage shown above are in the case when IVA-W502E is used individually.
- If the switched power (ignition) lead of the IVA-W502E is connected directly to the positive (+) post of the vehicle's battery, the IVA-W502E draws some current (several hundred milliamperes) even when its switch is placed in the OFF position and the battery may be discharged.

To prevent external noise from entering the audio system.

- Locate the unit and route the leads at least 10 cm away from the car harness.
- Keep the battery power leads as far away from other leads as possible.
- Connect the ground lead securely to a bare metal spot (remove any paint, dirt or grease if necessary) of the car chassis.
- If you add an optional noise suppressor, connect it as far away from the unit as possible. Your Alpine dealer carries various noise suppressors, contact them for further information.
- Your Alpine dealer knows best about noise prevention measures so consult your dealer for further information.

Connections

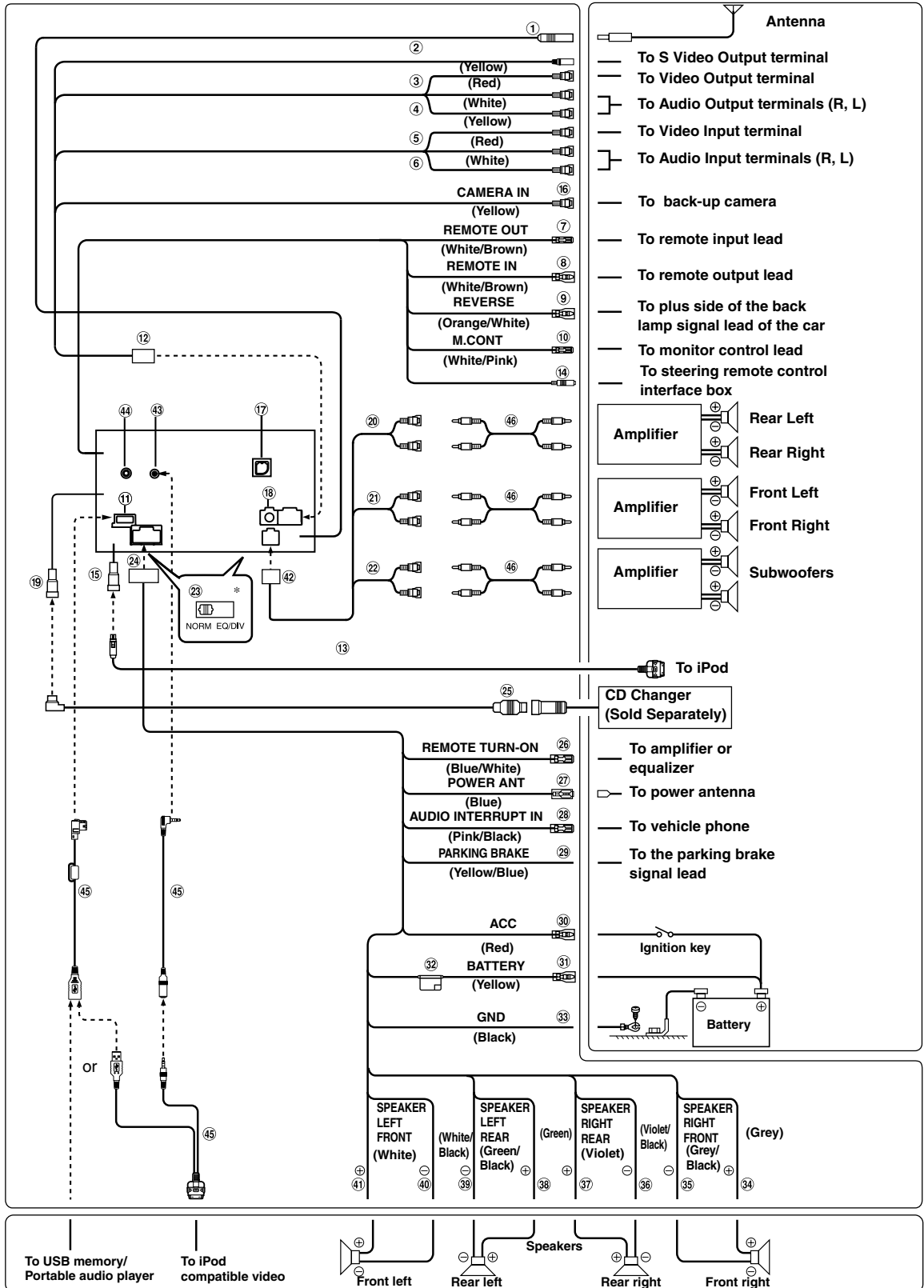

• Set the system switch to "NORM" when only a changer is connected (when the Ai-NET compatible equalizer is not used). When the IMPRINT audio processor is connected, set to EQ/DIV position.
 * The two system switches are located on the bottom of the unit.

- ① **Antenna Receptacle**
- ② **S Video Input Connector**
Input the video signal.
Connect to the output terminal of S video of connected devices.
- ③ **Video Input Connector (AUX INPUT) (Yellow)**
Input the video.
- ④ **Audio Input Connectors (AUX INPUT)**
RED is right and WHITE is left input the audio.
- ⑤ **Video Output Connector (AUX OUTPUT) (Yellow)**
Output the video.
- ⑥ **Audio Output Connectors (AUX OUTPUT)**
RED is right and WHITE is left output the audio.
- ⑦ **Remote Control Output Lead (White/Brown)**
Connect this lead to the remote control input lead. This lead outputs the controlling signals from the remote control.
- ⑧ **Remote Control Input Lead (White/Brown)**
Connect the external Alpine product to the remote control output lead.
- ⑨ **Reverse Lead (Orange/White)**
Use only when a back-up camera is connected. Connect to the plus side of the car's reverse lamp. This lamp illuminates when the transmission is shifted into reverse (R).
With this lead properly wired, the video picture automatically switches to the back-up camera whenever the car is put into reverse (R).
- ⑩ **Monitor Control Lead (White/Pink)**
Connect this to the Monitor Control Lead of the touch panel-compatible rear monitor.
- ⑪ **USB Connector**
- ⑫ **AUX I/O Camera In Connector**
- ⑬ **FULL SPEED™ Connection Cable (KCE-422i) (Sold Separately)**
- ⑭ **Steering Remote Control Interface Connector**
To steering remote control interface box.
For details about connections, consult your nearest Alpine dealer.
- ⑮ **iPod Direct Connector**
iPod control signals.
Connect this to an iPod or an optional Bluetooth Box, using the FULL SPEED™ Connection Cable (KCE-422i) (sold separately).
To use a hands-free mobile phone, an optional Bluetooth Box connection is required. For details on connection, refer to the Owner's Manual of the Bluetooth Box.
- ⑯ **CAMERA Input Connector**
Use when connecting a back-up camera.
- ⑰ **RGB Input Terminal**
Connect this to the RGB output terminal of the Navigation System.
- ⑱ **Digital Output Terminal (Optical)**
Use when combining fiber optic digital input compatible products. Be sure to use the Optical Digital Cable (KWE-610A) (sold separately) only.
- ⑲ **Ai-NET Connector**
Connect this to the output or input connector of another device (CD Changer, Equalizer, etc.) equipped with Ai-NET.
 - *You can input TV/video sound by connecting an optional Ai-NET/RCA Interface cable (KCA-121B) to this component.*
 - *Be sure to set "Setting the Connected Head Unit (MODEL SETUP)" to "DVD CHG", when the DHA-S690 is connected.*
- ⑳ **Rear Output/Input RCA Connectors**
It can be used as Rear Output or Input RCA Connectors.
- ㉑ **Front Output/Input RCA Connectors**
It can be used as Front Output or Input RCA Connectors.
- ㉒ **Subwoofer RCA Connectors**
RED is right and WHITE is left.
- ㉓ **System Switch**
When connecting an equalizer or divider using Ai-NET feature, place the two switches in the EQ/DIV position.
When no device is connected, leave the switches in the NORM position.
 - *Do not make the two switches to different settings.*
 - *Be sure to turn the power off to the unit before changing the switch position.*
- ㉔ **Power Supply Connector**
- ㉕ **Ai-NET Cable (Included with CD Changer)**
- ㉖ **Remote Turn-On Lead (Blue/White)**
Connect this lead to the remote turn-on lead of your amplifier or signal processor.
- ㉗ **Power Antenna Lead (Blue)**
Connect this lead to the +B terminal of your power antenna, if applicable.
 - *This lead should be used only for controlling the vehicle's power antenna. Do not use this lead to turn on an amplifier or a signal processor, etc.*
- ㉘ **Audio Interrupt In Lead (Pink/Black)**
- ㉙ **Parking Brake Lead (Yellow/Blue)**
Connect this lead to the power supply side of the parking brake switch to transmit the parking brake status signals to the IVA-W502E.
- ㉚ **Switched Power Lead (Ignition) (Red)**
Connect this lead to an open terminal on the vehicle's fuse box or another unused power source which provides (+) 12V only when the ignition is turned on or in the accessory position.
- ㉛ **Battery Lead (Yellow)**
Connect this lead to the positive (+) post of the vehicle's battery.
- ㉜ **Fuse Holder (10A)**

- ③③ **Ground Lead (Black)**
Connect this lead to a good chassis ground on the vehicle.
Make sure the connection is made to bare metal and is
securely fastened using the sheet metal screw provided.
- ③④ **Right Front (+) Speaker Output Lead (Grey)**
- ③⑤ **Right Front (-) Speaker Output Lead (Grey/Black)**
- ③⑥ **Right Rear (-) Speaker Output Lead (Violet/Black)**
- ③⑦ **Right Rear (+) Speaker Output Lead (Violet)**
- ③⑧ **Left Rear (+) Speaker Output Lead (Green)**
- ③⑨ **Left Rear (-) Speaker Output Lead (Green/Black)**
- ④① **Left Front (-) Speaker Output Lead (White/Black)**
- ④② **Left Front (+) Speaker Output Lead (White)**
- ④③ **RCA Output/Input Connector**
- ④④ **iPod AUDIO/VIDEO Input Connector**
Connect this to the AV extension cable.
- ④⑤ **MIC Input Connector**
To Microphone (sold separately).
- ④⑥ **Video iPod /USB Connect Cable (KCE-450lvu) (Sold Separately)**
- ④⑦ **RCA Extension Cable (Sold Separately)**

System Example

Connect the Ai-NET compatible audio processor (Fiber optic digital compatible), Navigation system, DVD player and changer.

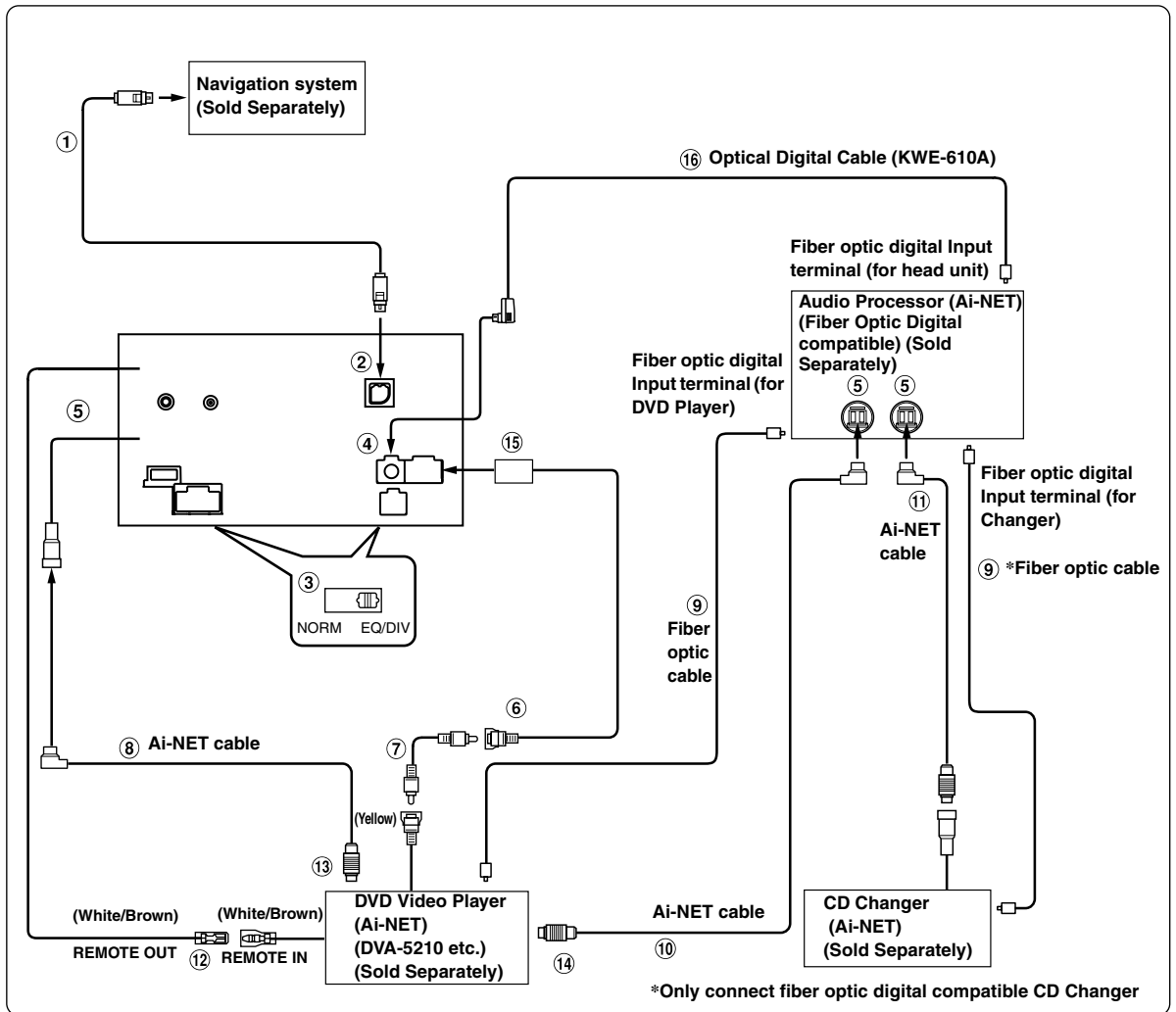

- When the fiber optic compatible product is connected, it is necessary to set the mode of this unit. Refer to "Setting the Digital Output" (page 37) and set to ON.

Please observe the following when using Fiber Optic Cable (Optical Digital Cable).

- Do not coil the Fiber Optic Cable smaller than a 30 mm radius.
- Do not place anything on top of the Fiber Optic Cable.
- Be careful not to bend the Fiber Optic Cable at a sharp angle.

- ① **RGB Cable (Sold Separately)**
- ② **RGB Input Terminal**
Connect this to the RGB output terminal of the Navigation System.
- ③ **System Switch**
When connecting an equalizer or divider using Ai-NET feature, place the two switches in the EQ/DIV position. When no device is connected, leave the switches in the NORM position.
 - *Do not make the two switches to different settings.*
 - *Be sure to turn the power off to the unit before changing the switch position.*
- ④ **Digital Output Terminal**
- ⑤ **Ai-NET Connector**
Connect this to the output or input connector of other product equipped with Ai-NET.
- ⑥ **Video Input Connector (AUX INPUT) (Yellow)**
Connect the video output lead of a DVD video player or DVD changer to this terminal.
- ⑦ **RCA Extension Cable (Included with DVD video player)**
- ⑧ **Ai-NET Cable (Included with DVD video player)**
- ⑨ **Fiber Optic Cable (Sold Separately)**
- ⑩ **Ai-NET Cable (Included with Audio Processor)**
- ⑪ **Ai-NET Cable (Included with CD Changer)**
- ⑫ **Remote Control Output Lead (White/Brown)**
Connect this lead to the remote control input lead. This lead outputs the controlling signals from the remote control.
- ⑬ **To Ai-NET Connector (Grey)**
- ⑭ **To Ai-NET Connector (Black)**
- ⑮ **AUX I/O Camera In Connector**
- ⑯ **Optical Digital Cable (KWE-610A) (Sold Separately)**

When Connecting External Equipment

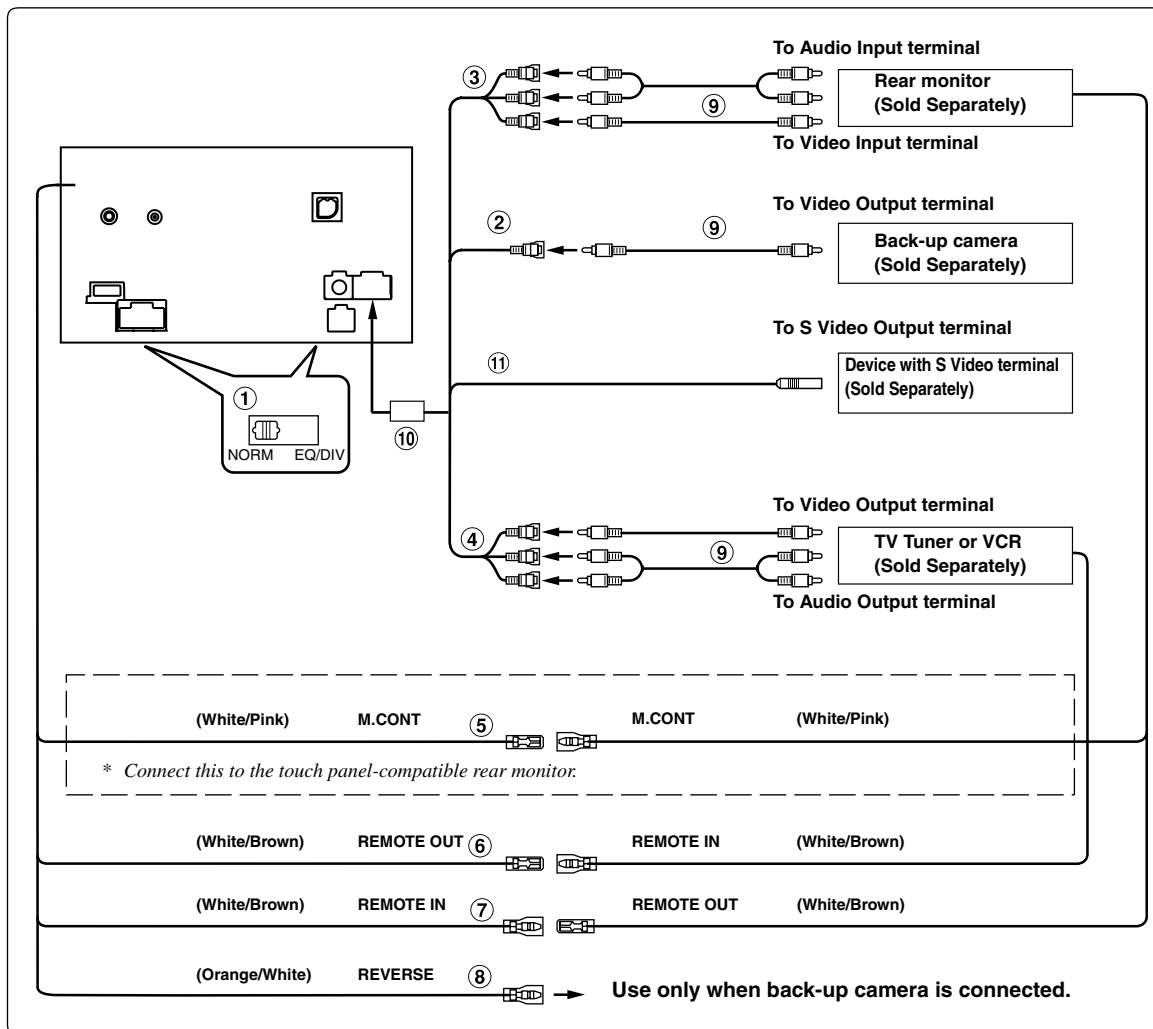

① System Switch

When connecting an equalizer or divider using Ai-NET feature, place the two switches in the EQ/DIV position. When no device is connected, leave the switches in the NORM position.

- Do not make the two switches to different settings.
- Be sure to turn the power off to the unit before changing the switch position.

② CAMERA Input Connector

Use when connecting a back-up camera.

③ Video/Audio Output Connectors (AUX OUTPUT)

Use when connecting an optional monitor etc.

④ Video/Audio Input Connectors (AUX INPUT)

⑤ Monitor Control Lead (White/Pink)

Connect this to the Monitor Control Lead of the touch panel-compatible rear monitor.

⑥ Remote Control Output Lead (White/Brown)

Connect this lead to the remote control input lead. This lead outputs the controlling signals from the remote control.

⑦ Remote Control Input Lead (White/Brown)

⑧ Reverse Lead (Orange/White)

Use only when a back-up camera is connected. Connect to the plus side of the car's reverse lamp. This lamp illuminates when the transmission is shifted into reverse (R). With this lead properly wired, the video picture automatically switches to the back-up camera whenever the car is put into reverse (R).

⑨ RCA Extension Cable (Sold Separately)

⑩ AUX I/O Camera In Connector

⑪ S Video Input Connector

Input the video signal. Connect to the output terminal of S video of connected devices.

Free Manuals Download Website

<http://myh66.com>

<http://usermanuals.us>

<http://www.somanuals.com>

<http://www.4manuals.cc>

<http://www.manual-lib.com>

<http://www.404manual.com>

<http://www.luxmanual.com>

<http://aubethermostatmanual.com>

Golf course search by state

<http://golfingnear.com>

Email search by domain

<http://emailbydomain.com>

Auto manuals search

<http://auto.somanuals.com>

TV manuals search

<http://tv.somanuals.com>