



EN

CT

DVD-Video Tuner

DVA-9965E

MLX MP3



- OWNER'S MANUAL
Please read before using this equipment.
- 用戶說明書
使用前請一定閱讀本說明書。

ALPINE ELECTRONICS MARKETING, INC.
1-1-8 Nishi Gotanda,
Shinagawa-ku,
Tokyo 141-0031, Japan
Phone 03-5496-8231

ALPINE ELECTRONICS OF AMERICA, INC.
19145 Gramercy Place, Torrance,
California 90501, U.S.A.
Phone 1-800-ALPINE-1 (1-800-257-4631)

ALPINE ELECTRONICS OF CANADA, INC.
777 Supertest Road, Toronto,
Ontario M3J 2M9, Canada
Phone 1-800-ALPINE-1 (1-800-257-4631)

**ALPINE ELECTRONICS OF AUSTRALIA PTY.
LTD.**
161-165 Princes Highway, Hallam
Victoria 3803, Australia
Phone 03-8787-1200

ALPINE ELECTRONICS GmbH
Frankfurter Ring 117, 80807 München, Germany
Phone 089-32 42 640

ALPINE ELECTRONICS OF U.K. LTD.
Alpine House
Fletchamstead Highway, Coventry CV4 9TW, U.K.
Phone 0870-33 33 763

ALPINE ELECTRONICS FRANCE S.A.R.L.
(RCS PONTOISE B 338 101 280)
98, Rue de la Belle Etoile, Z.I. Paris Nord II,
B.P. 50016, 95945 Roissy Charles de Gaulle
Cedex, France
Phone 01-48638989

ALPINE ITALIA S.p.A.
Viale C. Colombo 8, 20090 Trezzano
Sul Naviglio (MI), Italy
Phone 02-484781

ALPINE ELECTRONICS DE ESPAÑA, S.A.
Portal de Gamarra 36, Pabellón, 32
01013 Vitoria (Alava)-APDO 133, Spain
Phone 945-283588

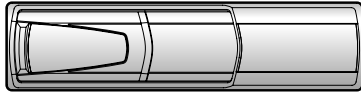

CHA-S634

- CD changer for DVA-9965E.
- 用於 DVA-9965E 的 CD 換碟器。

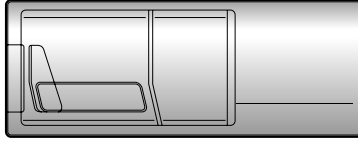

CHA-1214

- CD changer for DVA-9965E.
- 用於 DVA-9965E 的 CD 換碟器。

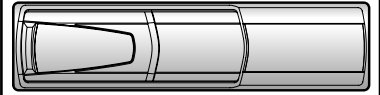

CHM-S630

Alpine CD Changers Give You More!

More musical selections, more versatility, more convenience.

The CHA-S634 is a high-performance 6-disc changer with a new M DAC, CD-R/RW PLAY BACK, MP3 PLAY BACK and CD TEXT. The CHA-1214 Ai-NET model holds 12 discs, and the CHM-S630 M-Bus model is a super-compact 6-disc changer with a CD-R/RW PLAY BACK.

Alpine CD 換片機將提供更多！

更多音色選擇、更多功能性、更多便利性。

CHA-S634 是一款帶有新 M DAC、CD-R/RW 播放、MP3 播放及 CD 文字顯示的高性能 6 碟片換片機。CHA-1214 Ai-NET 型可裝 12 碟片。CHM-S630M-Bus 型 是一款帶 CD-R/RW 播放的高壓縮 6 碟片換片機。

Contents

Operating Instructions

WARNING

WARNING	3
CAUTION	3
PRECAUTIONS	3
Discs playable on this unit	5

About the GlideTouch™ Bar Operation ...7

Getting Started

Turning Power On and Off	8
Initial System Start-Up	8
Setting the Time and Calendar	8
Opening and Closing the Movable Display	9
Display Tilt Adjustment	9
Adjusting Volume	9
Lowering Volume Quickly	9
Detaching and Attaching the Front Panel	9

Radio

Listening to Radio	10
Manual Storing of Station Presets	10
Automatic Memory of Station Presets	10
Tuning to Preset Stations	10
Frequency Search Function	11

CD/MP3/WMA

Playback	11
Repeat Play	12
M.I.X. (Random Play)	13
Scanning Programmes	13
Searching from CD Text	13
File/Folder Name Search (concerning MP3/WMA)	13
About MP3/WMA	14

DVD/Video CD

Playing DVD/Video CD	16
Stopping Playback (PRE-STOP)	17
Stopping Playback	17
Fast-forwarding/Fast-reversing	17
Finding the Beginning of Chapters or Tracks	17
Playing Still Frames (pausing)	17
Forward/reverse frame-by-frame Playback	17
Slow Motion Playback	17
Searching by Title Number (DVD only)	17
Searching Directly by Chapter or Track Number ...	18
Chapter/Track/Title Repeat Playback	18
Switching the Audio Tracks	18
Switching the Angle (DVD only)	18

Switching the Subtitles (subtitle language) (DVD only)	19
Displaying the Disc Status (DVD only)	19
Displaying the Disc Status (Video CD only)	19
GlideTouch bar Operation	20

Sound Setting

Adjusting Balance (Between Left and Right)/Fader (Between Front and Rear)/Defeat	20
Selecting the EQ mode (Factory settings)	21
Setting User's EQ mode	21
Adjusting and Storing the Parametric Equalizer Curve	21
Adjusting and Storing the Graphic Equalizer Curve ...	22
Recalling the Stored Equalizer Curve	22
About the Crossover	23
Adjusting and Storing the Crossover Settings	24
Recalling the Stored Crossover Settings	25
About Time Correction	25
Setting the Time Correction Unit	26
Adjusting and Storing the Time Correction	26
Recalling the Stored Time Correction Settings	27
Setting the MX Mode	27

Other Functions

Displaying the Text	28
Displaying Time	29
Blackout Mode On and Off	29
Setting Amplifier Link	29
Displaying the External Amplifier Information	30
Setting the Multicolour Illumination	30
Rear DVD Function	31

i-Personalize™ Data Download Operation

About i-Personalize™ Data Download	31
Data Downloading	32
Downloading the Wallpaper	32

DVD Setup

DVD Setup Operation	33
Setting the language	33
Setting the TV Screen	34
Setting the Country Code	34
Setting the Rating Level (Parental Lock)	34
Setting the Digital Output	35

Custom Setup

Custom Setup Operation	36
Setting the CD Play Mode	36
Setting the Video CD Play Mode	36
Setting the Pause Mode	36
Setting the Downmix Mode	36

SETUP

Setup Operation	37	Parametric Equalizer Adjustments	47
General Setting		Setting Bass Compressor	47
Setting the Clock display	37	Speaker Setup	47
Playing MP3/WMA Data	37	Setting of Dolby Digital	48
Sound (Beep) Guide Function	37	Adjusting the speaker levels	
Changing the Sound (Beep) Guide Pattern	37	(OUTPUT LEVEL)	48
Turning Mute Mode On/Off	38	Mixing bass sound to the rear channel	
Setting Tone Defeat for External Devices	38	(REAR MIX)	48
Setting the AUX Mode (V-Link)	38	Adjusting the acoustic image	
Setting the Digital Output	38	(BI-PHANTOM)	49
Setting the Digital Audio Processor	38	Achieving powerful high volume sound	
Audio Setting		(LISTENING)	49
Subwoofer On and Off	38	Adjusting the DVD Level	49
Setting the Response Slope for the High Range		Using the Pro Logic II Mode	50
Speaker	38	Linear PCM Setting	50
Display Setting		Storing Settings in the Memory	51
Dimmer Control	39	Getting out the Preset Memory	51
Setting the Display Dimmer	39	Remote Control	
Changing the Display Colour	39	Controls on Remote Control	51
Scroll Setting	39	When Using the Remote Control	52
Scroll Type Setting	39	Battery Replacement	52
Switching the Character Font	39	Information	
Setting the Temperature Display for the External		About DVDs	53
Amplifier	39	Terminology	54
Switching the Animation Display Type	39	List of Language Codes	55
Opening Message ON/OFF Setting	39	List of Country Codes	56
Setting of Calendar Display Pattern Switching	39	In Case of Difficulty	58
Demo Setting		Specifications	61
Demonstration	39	<hr/>	
iPod™ Operation (Optional)		Installation and Connections	
Playback	40	Warning	62
Searching for a desired Song	40	Caution	62
Quick Search	41	Precautions	62
Random Play Shuffle (M.I.X.)	41	Installation	63
Repeat Play	42	Connections	65
Displaying the Text	42	System Example	67
Changer (Optional)			
Controlling CD Changer (Optional)	42		
Playing MP3 Files with the CD Changer (Optional) ...	43		
Multi-Changer Selection (Optional)	43		
External Audio Processor (Optional)			
Adjustment Procedure for Dolby Surround	44		
Setting the Speakers	44		
Set MX Mode of the External Audio Processor	44		
X-OVER Adjustment	45		
Performing Time Correction Manually (TCR)/			
Phase Switching	45		
Calculating the Time Correction	45		
Inputting the Time Correction	46		
Switching the Phase	46		
Graphic Equalizer Adjustments	46		

Operating Instructions

WARNING

WARNING

This symbol means important instructions. Failure to heed them can result in serious injury or death.

DO NOT OPERATE ANY FUNCTION THAT TAKES YOUR ATTENTION AWAY FROM SAFELY DRIVING YOUR VEHICLE.

Any function that requires your prolonged attention should only be performed after coming to a complete stop. Always stop the vehicle in a safe location before performing these functions. Failure to do so may result in an accident.

KEEP THE VOLUME AT A LEVEL WHERE YOU CAN STILL HEAR OUTSIDE NOISE WHILE DRIVING.

Failure to do so may result in an accident.

MINIMIZE DISPLAY VIEWING WHILE DRIVING.

Viewing the display may distract the driver from looking ahead of the vehicle and cause an accident.

DO NOT DISASSEMBLE OR ALTER.

Doing so may result in an accident, fire or electric shock.

USE ONLY IN CARS WITH A 12 VOLT NEGATIVE GROUND.

(Check with your dealer if you are not sure.) Failure to do so may result in fire, etc.

KEEP SMALL OBJECTS SUCH AS BATTERIES OUT OF THE REACH OF CHILDREN.

Swallowing them may result in serious injury. If swallowed, consult a physician immediately.

USE THE CORRECT AMPERE RATING WHEN REPLACING FUSES.

Failure to do so may result in fire or electric shock.

DO NOT BLOCK VENTS OR RADIATOR PANELS.

Doing so may cause heat to build up inside and may result in fire.

USE THIS PRODUCT FOR MOBILE 12V APPLICATIONS.

Use for other than its designed application may result in fire, electric shock or other injury.

DO NOT PLACE HANDS, FINGERS OR FOREIGN OBJECTS IN INSERTION SLOTS OR GAPS.

Doing so may result in personal injury or damage to the product.



CAUTION

This symbol means important instructions. Failure to heed them can result in injury or material property damage.

HALT USE IMMEDIATELY IF A PROBLEM APPEARS.

Failure to do so may cause personal injury or damage to the product. Return it to your authorized Alpine dealer or the nearest Alpine Service Centre for repairing.

DO NOT MIX NEW BATTERIES WITH OLD BATTERIES. INSERT WITH THE CORRECT BATTERY POLARITY.

When inserting the batteries, be sure to observe proper polarity (+ and -) as instructed. Rupture or chemical leakage from the battery may cause fire or personal injury.

KEEP FINGERS AWAY WHILE THE MOTORIZED FRONT PANEL OR MOVING MONITOR IS IN MOTION.

Failure to do so may result in personal injury or damage to the product.



PRECAUTIONS

Product Cleaning

Use a soft dry cloth for periodic cleaning of the product. For more severe stains, please dampen the cloth with water only. Anything else has the chance of dissolving the paint or damaging the plastic.

Temperature

Be sure the temperature inside the vehicle is between +60°C (+140°F) and -10°C (+14°F) before turning your unit on.

Moisture Condensation

You may notice the CD playback sound wavering due to condensation. If this happens, remove the disc from the player and wait about an hour for the moisture to evaporate.

Damaged Disc

Do not attempt to play cracked, warped, or damaged discs. Playing a bad disc could severely damage the playback mechanism.

Maintenance

If you have problems, do not attempt to repair the unit yourself. Return it to your Alpine dealer or the nearest Alpine Service Station for servicing.

Never Attempt the Following

Do not grip or pull out the disc while it is being pulled back into the player by the automatic reloading mechanism.

Do not attempt to insert a disc into the unit when the unit power is off.

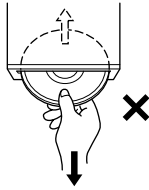

Inserting Discs

Your player accepts only one disc at a time for playback. Do not attempt to load more than one disc.

Make sure the label side is facing up when you insert the disc. "Error" will be displayed on your player if you insert a disc incorrectly. If "Error" continues to be displayed even though the disc has been inserted correctly, push the RESET switch with a pointed object such as a ballpoint pen.

Playing a disc while driving on a very bumpy road may result in skips, but this will not scratch the disc or damage the player.

New Discs

As a protective measure to prevent the CD from jamming, "Error" will be displayed if discs with irregular surface are inserted or inserted incorrectly. When a new disc is inserted into the player and ejected after initial loading, using your finger, feel around the inside of the center hole and outside edge of the disc. If you feel any small bumps or irregularities, this could inhibit proper loading of the disc. To remove the bumps, rub the inside edge of the hole and outside edge of the disc with a ballpoint pen or other such instrument, then insert the disc again.

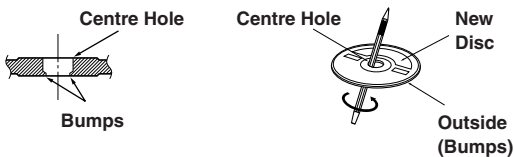

Irregular Shaped Discs

Be sure to use round shape discs only for this unit and never use any special shape discs.

Use of special shape discs may cause damage to the mechanism.



Installation Location

Make sure the DVA-9965E will not be installed in a location subjected to:

- Direct sun and heat
- High humidity and water
- Excessive dust
- Excessive vibrations

Correct Handling

Do not drop the disc while handling. Hold the disc so you will not leave fingerprints on the surface. Do not affix tape, paper, or gummed labels to the disc. Do not write on the disc.

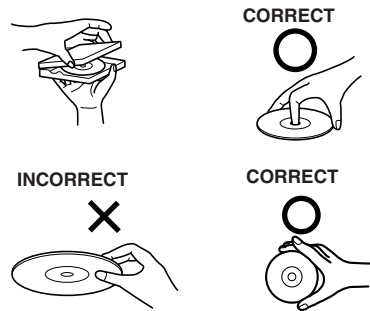

Disc Cleaning

Fingerprints, dust, or soil on the surface of the disc could cause the CD player to skip. For routine cleaning, wipe the playing surface with a clean, soft cloth from the centre of the disc to the outer edge. If the surface is heavily soiled, dampen a clean, soft cloth in a solution of mild neutral detergent before cleaning the disc.



Disc Accessories

There are various accessories available on the market for protecting the disc surface and improving sound quality. However, most of them will influence the thickness and/or diameter of the disc. Using such accessories can cause the disc to be out of standard specifications and may create operational problems. We recommend not using these accessories on discs played in Alpine CD players.

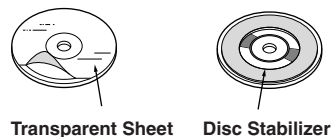

Discs playable on this unit

Playable Discs

The discs listed below can be played on this unit.

	Mark (logo)	Recorded content	Disc size	Max. playing time
DVD Video		Audio + Video (Moving pictures)	12 cm*	One-sided disc Approx. 4 hours
				Two-sided disc Approx. 8 hours
			8 cm	One-sided disc Approx. 80 Minutes
				Two-sided disc Approx. 160 Minutes
Video CD		Audio + Video (Moving pictures)	12 cm	Approx. 74 Minutes
			8 cm	Approx. 20 Minutes
Music CD		Audio	12 cm	Approx. 74 Minutes
			8 cm (CD single)	Approx. 20 Minutes

* Two-layer DVD disc compatible

Discs that cannot be played

DVD-ROMs, DVD-RAMs, DVD + Rs, DVD + RWs, CD-ROMs (excluding MP3/WMA files), photo CDs, etc.

DVD region number (playable region number)

Refer to the attached card, "TO CUSTOMERS," for the playable DVD region number for this DVD player.

Video CDs

This DVD head unit is compatible with playback control (PBC) compatible video CDs (version 2.0).

"PBC" is a function by which you can use menu screens recorded on the disc to find the scene you want to watch and view various types of information in dialogue style.

Using compact discs (CD/CD-R/CD-RW)

If you use unspecified compact discs, correct performance cannot be guaranteed.

You can play CD-Rs (CD-Recordable)/CD-RWs (CD-ReWritable) which have been recorded only on audio devices. You can also play CD-Rs/CD-RWs containing MP3/WMA formatted audio files.

- Some of the following discs may not be played on this unit:
 - Flawed discs, discs with fingerprints, discs exposed to extreme temperatures or sunlight (e.g., left in the car or this unit), discs recorded under unstable conditions, discs on which a recording failed or a re-recording was attempted, copy-protected CDs which do not conform to the audio CD industry standard.
- Use discs with MP3/WMA files written in a format compliant with ISO9660 level 1 or level 2. For details, see pages 14 and 15.

To customers using CD-R/CD-RW

- If a CD-R/CD-RW cannot be played back, make sure the last recording session was closed (finalized).
- Finalize the CD-R/CD-RW if necessary, and attempt playback again.

Tips for making your own CDs

The DVA-9965E plays DVD Video, Video CD, Audio CD and has a built in MP3/WMA decoder.

The following information is designed to help you create your own music CDs (either Audio CD or MP3/WMA encoded CD-R/RW files).

What is the difference between an Audio and MP3/WMA CD?

An Audio CD is the same format as the commercial CDs you buy in the store (also known as CD-DA). MP3 (MPEG-1 Audio Layer 3)/WMA (Windows Media Audio) is a data file that uses a compression scheme to reduce the size of the music file.*

Hybrid Audio CD and Data (MP3/WMA) CD-R/RW discs:

The DVA-9965E can read either sector on the disc. Choose CD-DA to play the CD audio section or MP3/WMA to play the MP3/WMA section.*

Continued

Multisession CD-R/RW:

Once a recording has been stopped, this is considered as one session. If the disc is not closed (finalized), additional data may be added. Once this additional data has been recorded, this becomes a "multisession" CD. The DVA-9965E can only read multisession DATA Formatted discs (MP3/WMA files - Not Audio CD files).

Properly formatted MP3/WMA Discs:

Use ISO9660 formatting to insure proper playback. You may use standard ISO naming Level 1 (8.3 DOS standard), Level 2 (32 characters) or Joliet (Windows or Macintosh long filenames) file naming conventions*.

*Please consult the Owner's manual for additional information.

On handling compact discs (CD/CD-R/CD-RW)

- Do not touch the surface.
- Do not expose the disc to direct sunlight.
- Do not affix stickers or labels.
- Clean the disc when it is dusty.
- Make sure that the disc is smooth and flat.
- Do not use commercially available disc accessories.

Do not leave the disc in the car or the unit for a long time. Never expose the disc to direct sunlight.

Heat and humidity may damage the disc and you may not be able to play it again.

Using DVD-Rs/DVD-RWs

- This unit is compatible only with discs recorded in the DVD-Video mode. Discs recorded in the DVD-VR mode cannot be played back.
- Note that discs not finalized (processed to enable to play on playback-only DVD players) cannot be played on this DVD player.
- Some discs may not play back, depending on the recording device. (This unit has a copy protection function. Discs copied illegally will not be played back. Some files recorded by a software using an improper recording system may be recognized as illegally copied.)
- In the following cases, the disc may not play on this unit: discs recorded by certain DVD recorders, certain irregular discs, flawed discs, dirty discs, when the pickup lens of this DVD player is dirty, or when moisture condensation has occurred inside the unit.
- Be sure to follow all cautions included with your DVD-Rs/ DVD-RWs discs.
- Do not put stickers, seals, or tape on the label side of DVD-Rs/ DVD-RWs.
- Compared to the regular discs, DVD-Rs/DVD-RWs are more affected by heat, moisture, and direct sunlight. If left in a car, etc., damage may occur and it might not play on this unit.

Disc terminology

Title

If titles are programmed for the DVD, these are the largest units of division of the information recorded on the disc.

Chapter

Each Title may also be divided into smaller divisions, called chapters. These can be specific scenes or musical selections.

- *This product incorporates copyright protection technology that is protected by U.S. patents and other intellectual property rights. Use of this copyright protection technology must be authorized by Macrovision, and is intended for home and other limited viewing uses only unless otherwise authorized by Macrovision. Reverse engineering or disassembly is prohibited.*
- *Manufactured under license from Dolby Laboratories. "Dolby," "Pro Logic" and the double-D symbol are trademarks of Dolby Laboratories.*
- *"DTS" and "DTS2.0 + Digital Out" are trademarks of Digital Theater Systems, inc.*
- *Windows Media and the Windows logo are trademarks, or registered trademarks of Microsoft Corporation in the United States and/or other countries.*
- *Apple and the Apple logo are trademarks of Apple Computer, Inc., registered in the U.S. and other countries. iPod and iPod mini are trademarks of Apple Computer, Inc.*
- *"MPEG Layer-3 audio coding technology licensed from Fraunhofer IIS and Thomson"*
- *"Supply of this product only conveys a license for private, non-commercial use and does not convey a license nor imply any right to use this product in any commercial (i.e. revenue-generation) real time broadcasting (terrestrial, satellite, cable and/or any other media), broadcasting/streaming via internet, intranets and/ or other networks or in other electronic content distribution systems, such as pay-audio or audio-on-demand applications. An independent license for such use is required. For details, please visit <http://www.mp3licensing.com>."*

About the GlideTouch™ Bar Operation

1 Touch or press the desired position on the **GlideTouch bar**.

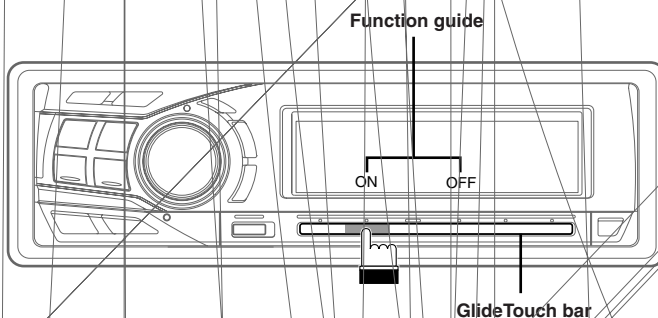

Press any one of the 6 positions on the **GlideTouch bar** to which a function has been assigned in the guide display. For example, to select ON, press the **GlideTouch bar** directly below where ON is indicated in the guide display. The manual expresses this as follows: "Change the setting by pressing the **GlideTouch bar** below either the ON or OFF function indicators."

2 Move your finger on the **GlideTouch bar** to the left or right.

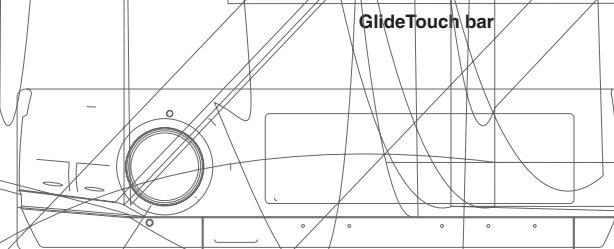

Place your finger on the **GlideTouch bar** and slide it gently to the left or right. Items or lists in the display will change as you move your finger across the **GlideTouch bar**.

To select items on the following page, scroll the page as follows:

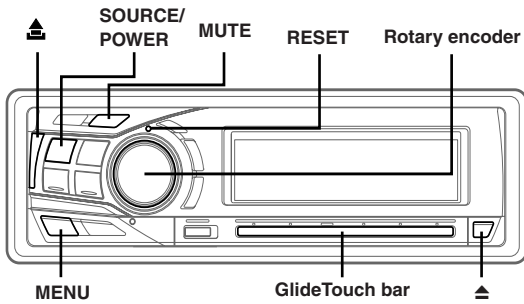

- Place and hold your finger on either side of the **GlideTouch bar** for at least 3 seconds.
When scrolling the page toward the left, place and hold your finger on the left side of the **GlideTouch bar**.
When scrolling the page toward the right, place and hold your finger on the right side of the **GlideTouch bar**.

Getting Started



Turning Power On and Off

Press **SOURCE/POWER** to turn on the unit.

- The unit can be turned on by pressing any other button except eject  and .

Press and hold **SOURCE/POWER** for at least 2 seconds to turn off the unit.

- The first time power is turned on, the volume will start from level 12.

Initial System Start-Up

Be sure to press the **RESET** switch when using the unit for the first time, after installing the CD changer, after changing the car battery, etc.

- 1 Turn off the unit power.
- 2 Press **RESET** with a ball-point pen or similar pointed object.

Setting the Time and Calendar

- 1 Press **MENU**.
The main SETUP menu is displayed.
- 2 Select **Setup** by sliding your finger on the **GlideTouch bar** to the left or right. Press the **GlideTouch bar** under **Setup**.
The main SETUP menu is displayed.
- 3 Select **GENERAL** by sliding your finger on the **GlideTouch bar** to the left or right. Press the **GlideTouch bar** under **GENERAL**.
The GENERAL SETUP menu is displayed.
- 4 Select **CLOCK ADJUST** by sliding your finger on the **GlideTouch bar** to the left or right. Press the **GlideTouch bar** under **CLOCK ADJUST**.
- 5 Select "Year" by sliding your finger on the **GlideTouch bar** to the left or right.
- 6 Adjust "Year" by turning the **Rotary encoder**.
- 7 Adjust "Month", "Day", "Hour" and "Minute" by turning the **Rotary encoder** by repeating steps 5 and 6.
- 8 After setting, press and hold **MENU** for at least 2 seconds to return to normal mode.
 - To synchronize the clock to another clock/watch or radio time announcement, press and hold the **Rotary encoder** for at least 2 seconds after setting the "hour." Minutes will reset to 00. If the display shows over "30" minutes when you do this, the time will advance to the nearest hour.
 - If **MENU** is pressed while adjusting or setting the items in the **MENU** mode, the unit will return to the previous selection screen.
 - By pressing the **GlideTouch bar** under **RETURN** in the **MENU** mode, the unit will return to the normal mode.
 - If no operation is performed for 60 seconds, the unit will return to the normal mode.

Opening and Closing the Movable Display

Press **▲**.

The movable display will open.

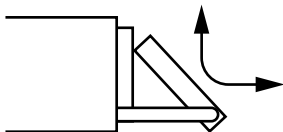

To close the movable display, press **▲** again.

The movable display will close.

- Do not apply shock to the movable display when it is open as it may result in malfunction of the unit.
- The display may be dim during low temperature and immediately after turning on the power. The brightness will return to normal as time elapses.
- The display will stop at the set tilt angle when closing.

Caution

Keep hands (or any other object) away from the display while it is opening or closing to avoid damage or injury. The back of the movable display will get very warm under normal operating conditions. This is not a malfunction. Do not touch.

Display Tilt Adjustment

The movable display may be adjusted to 3 different angles depending upon user preference.

- 1 Press **MENU**.
- 2 Select **TILT Adjust** by sliding your finger on the **GlideTouch bar** to the left or right. Press the **GlideTouch bar** under **TILT Adjust**.
- 3 Touch **↑** (UP) or **↓** (DOWN) on the **GlideTouch bar** to adjust the display angle.

- Selecting **●** RETURN will return to the previous screen.

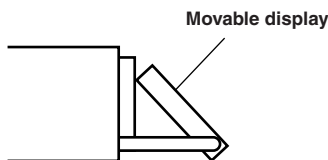

- 4 After setting, press and hold **MENU** for at least 2 seconds to return to normal mode.

- The adjusted tilt angle of the display is stored in memory. There is no need to re-adjust the tilt angle when the power is turned back on.
- If **MENU** is pressed while adjusting or setting the items in the **MENU** mode, the unit will return to the previous selection screen.
- By pressing the **GlideTouch bar** under **RETURN** in the **MENU** mode, the unit will return to the normal mode.

Caution

Keep hands (or any other object) away from the display while it is opening or closing to avoid damage or injury. The back of the movable display will get very warm under normal operating conditions. This is not a malfunction. Do not touch.

Adjusting Volume

Turn the **Rotary encoder** until the desired sound is obtained.

- While in the **MENU** mode, the volume cannot be adjusted.

Lowering Volume Quickly

Activating the Audio Mute function will instantly lower the volume level by 20 dB.

Press **MUTE** to activate the **MUTE** mode.

The audio level will decrease by about 20 dB.

Pressing **MUTE** again will bring the audio back to its previous level.

Detaching and Attaching the Front Panel

Detaching

- 1 Turn off the unit power.
- 2 Press **▲** (Release) at the upper left side until the front panel pops out.
- 3 Grasp the left side of the front panel and pull it out.

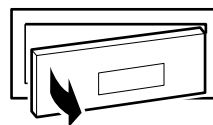

- The front panel may become hot in normal usage (especially the connector terminals on the back of the front panel). This is not a malfunction.
- To protect the front panel, place it in the supplied carrying case.

Attaching

- 1 Insert the right side of the front panel into the main unit. Align the groove on the front panel with the projections on the main unit.
- 2 Push the left side of the front panel until it locks firmly into the main unit.

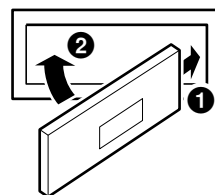

- Before attaching the front panel, make sure that there is no dirt or dust on the connector terminals and no foreign object between the front panel and the main unit.
- Attach the front panel carefully. Hold the panel by its sides to avoid pushing any buttons by mistake.

Radio

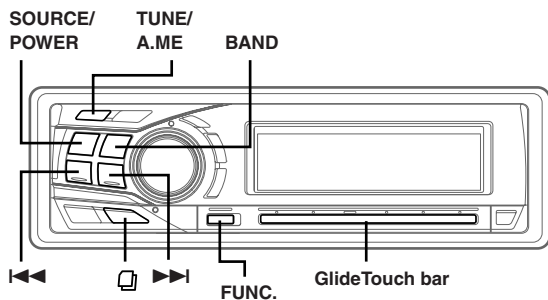

Listening to Radio

1 Press **SOURCE/POWER** until a radio frequency appears in the display.

2 Press **BAND** repeatedly until the desired radio band is displayed.

FM-1 → FM-2 → AM → FM-1

3 Press **TUNE/A.ME** to select the tuning mode.

DX (Distance mode) → LOCAL (Local mode) → MANUAL (Manual mode) → DX

• *The initial mode is Distance mode.*

Distance mode:

Both strong and weak stations will be automatically tuned in (Automatic Seek Tuning).

Local mode:

Only strong stations will be automatically tuned in (Automatic Seek Tuning).

Manual mode:

The frequency is manually tuned in steps (Manual tuning).

4 Press **◀◀** or **▶▶** to tune in the desired station.

Holding down **◀◀** or **▶▶** will change the frequency continuously.

• *The ST indicator appears on the display when a stereo FM station is tuned in.*

• *With the DVA-9965E, you can tune the radio station using the **GlideTouch bar**. Press **FUNC.** to select the source operation mode. Press the **GlideTouch bar** under the desired function shown in the function guide display.*

Manual Storing of Station Presets

1 Select the radio band and tune in a desired radio station you wish to store in the preset memory.

2 Press **FUNC.** to activate the preset mode.

Source select mode → Preset mode →
Source operation mode → Source select mode

3 Select any one of the preset numbers (1 through 6) by sliding your finger on the **GlideTouch bar** to the left or right. Press and hold the **GlideTouch bar** for at least 2 seconds under the selected preset number.

The selected station is stored.

- *A total of 18 stations can be stored in the preset memory (6 stations for each band; FM1, FM2 and AM).*
- *If you store a station in a preset memory which already has a station, the current station will be cleared and replaced with the new station.*

Automatic Memory of Station Presets

1 Press **BAND** repeatedly until the desired radio band is displayed.

2 Press and hold **TUNE/A.ME** for at least 2 seconds.

The frequency on the display continues to change while the automatic memory is in progress. The tuner will automatically seek and store 6 strong stations in the selected band. They will be stored into buttons 1 to 6 in order of signal strength.

When the automatic memory has been completed, the tuner goes to the station stored in preset location No. 1.

- *If no stations are stored, the tuner will return to the original station you were listening to before the auto memory procedure began.*

Tuning to Preset Stations

1 Press **BAND** repeatedly until the desired band is displayed.

2 Press **FUNC.** to activate the preset mode.



Source select mode → Preset mode →
Source operation mode → Source select mode

3 Select any one of the preset numbers (1 through 6) by sliding your finger to the left or right on the **GlideTouch bar**. Press the **GlideTouch bar** under the selected preset number.

The display shows the band, preset number and frequency of the station selected.

Frequency Search Function

You can search for a radio station by its frequency.

- 1 Press and hold  for at least 2 seconds in Radio mode to activate Frequency Search mode.
 - 2 Within 10 seconds, select the desired frequency by sliding your finger to the left or right on the **GlideTouch bar**. Press the **GlideTouch bar** under the desired frequency.
The radio station on the frequency selected is received.
- Frequency Search mode is cancelled by pressing and holding  for at least 2 seconds.
 - If either side of the **GlideTouch bar** is touched and held, the frequencies are scrolled continuously.

CD/MP3/WMA

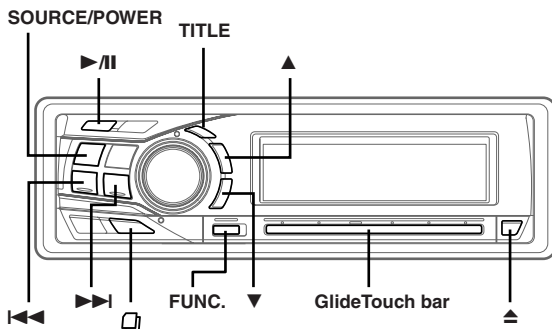

Playback

- 1 Press .
The movable display will open.
- 2 Insert a disc with the label side facing up.
The disc will be pulled into the unit automatically.

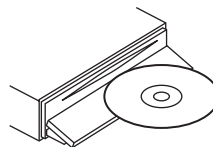















The movable display will close and playback will begin. When a disc is already inserted, press **SOURCE/POWER** to switch to the DISC mode.

The mode will change every time the button is pressed.

DISC → TUNER → CD CHANGER* → DISC

* Only when the CD changer is connected

- 3 While playing back MP3/WMA, press  or  to select the desired folder.
Pressing and holding  or  will change folders continuously.
- 4 Press  or  to select the desired track (file).
Returning to the beginning of the current track (file):
Press .
Fast backward:
Press and hold .
Advancing to the beginning of the next track (file):
Press .
Fast forward:
Press and hold .
- 5 To pause playback, press .
Pressing  again will resume playback.
- 6 To eject the disc, press .

- Do not remove a CD during its eject cycle. Do not load more than one disc at a time. A malfunction may result from doing either.
- If the CD does not eject, press and hold  for at least 2 seconds with the movable display open.

continued

11-EN

- The CD-player can play discs containing audio data, MP3 data and WMA data.
- A WMA format file that is protected by DRM (Digital Rights Management) cannot be played back on this unit.
- The track display for MP3/WMA data playback is the file numbers recorded on the disc.
- If the HDA-5460 model is connected to the unit, some operations (for example changing the source, selecting the file by holding buttons up or down, etc.), can be carried out on this unit.
- The playback time may not be correctly displayed when a VBR (Variable Bit Rate) recorded file is played back.
- With the DVA-9965E, you can return to the beginning of the current track, fast forward/fast reverse and playback/pause using the GlideTouch bar. Press **FUNC.** to select the source operation mode. Press the **GlideTouch bar** under the desired function shown in the function guide display.

MP3/WMA Play Display

The folder number, file number, sampling rate, and bit rate will be displayed as described below.

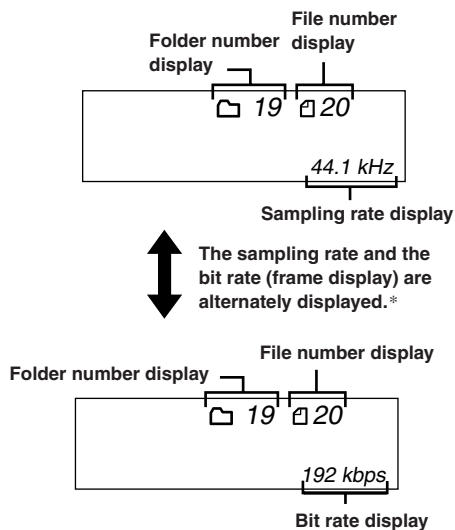

- Press **TITLE** to switch the display. Please see “Displaying the Text” (page 28) for information about display switching.

* The recording sampling rate and bit rate of the MP3/WMA file are displayed. A WMA file of variable bit rate displays the average bit rate.

Repeat Play

1 Press **FUNC.** to activate the audio function mode.

Source select mode → Audio function mode →
Source operation mode → Source select mode

2 Press the **GlideTouch bar** under **RPT** to select the **RPT mode**.

The track (file) will be played back repeatedly.

CD mode:

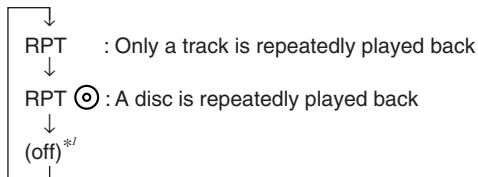

*1 When a CD changer is connected.

- If REPEAT is set to ON during M.I.X. play in CD changer mode, M.I.X. will apply to the current disc only.

MP3/WMA mode:

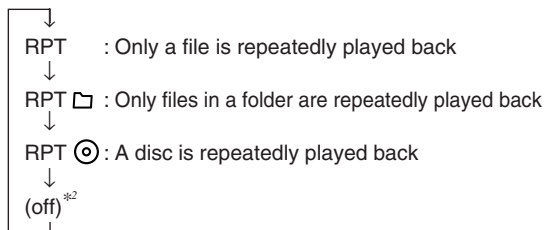

*2 When an MP3 compatible CD changer is connected.

- The function mode you previously recalled can be recalled again if the **GlideTouch bar** is touched.
- If no operation is performed for 10 seconds, the audio function mode turns off.
- When a file is moved up or down in the RPT □ mode, audio files in other folders are played back repeatedly.

M.I.X. (Random Play)

1 Press **FUNC.** to activate the audio function mode.

Source select mode → Audio function mode →
Source operation mode → Source select mode

2 Press the **GlideTouch bar** under **M.I.X.** to select the **Random Play mode.**

The tracks (files) will be played back in random sequence.

CD mode:

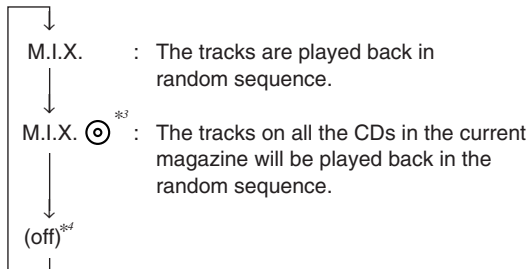



*3 When a CD changer equipped with the All M.I.X. function is connected.

*4 When selecting the internal disc mode, RPT  is illuminated.

- If M.I.X. is set to ON during RPT  (REPEAT ALL) play in CD changer mode, M.I.X. will apply to the current disc only.

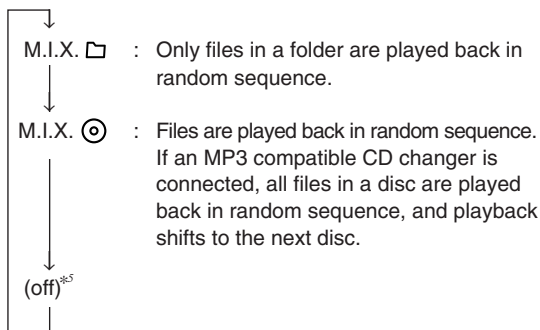
MP3/WMA mode:



*5 When selecting the internal disc mode, RPT  is illuminated.

- The function mode you previously recalled can be recalled again if the **GlideTouch bar** is touched.
- If no operation is performed for 10 seconds, the audio function mode turns off.

Scanning Programmes

1 Press **FUNC.** to activate the audio function mode.

Source select mode → Audio function mode →
Source operation mode → Source select mode

2 Press the **GlideTouch bar** under **SCAN** to select the **Scan mode.**

The first 10 seconds of each track (file) will be played back in succession.

3 If the desired song is found, perform steps 1 and 2 to stop scanning.

- The function mode you previously recalled can be recalled again if the **GlideTouch bar** is touched.
- If no operation is performed for 10 seconds, the audio function mode turns off.

Searching from CD Text

Tracks can be searched and played by using the CD text on the disc. In the case of discs and changers that do not support text, searches can be made by using the track numbers.

1 Press during play.

This will set the search mode.

2 Select the desired track by sliding your finger on the **GlideTouch bar** to the left or right. Press the **GlideTouch bar** under the **Text of the desired Track.**

This will play the selected track.

- Press and hold  for at least 2 seconds in the search mode to cancel. Or the search mode will be cancelled when an operation has not been performed in 10 seconds.
- CD text search cannot be made during M.I.X. play.
- Tracks are skipped continuously by touching and holding either side of the **GlideTouch bar**.

File/Folder Name Search (concerning MP3/WMA)

You can display and search the folder and file name while listening to the file currently being played back.

1 Press in MP3/WMA mode.

2 Within 10 seconds, select the **Folder search mode** or **File search mode** by sliding your finger on the **GlideTouch bar** to the left or right. Press the **GlideTouch bar** under the desired **search mode.**

Folder Name Search mode ↔ File Name Search mode

Folder Name Search mode

The desired folder is searched from all folders in a disc.

File Name Search mode

File is searched from all files in a disc or folder that is selected by folder search.



Folder Name Search mode

3 Within 10 seconds, select the folder to play back by sliding your finger on the **GlideTouch bar** to the left or right. Press **▶/||** to play the selected folder.

The first file in the selected folder is played back.

To search a file in the selected folder, press the **GlideTouch bar** or **FUNC.** to change to the file search mode.



Refer to "File Name Search mode" for operation.

- *Folder Name Search mode is cancelled by pressing and holding  for at least 2 seconds.*
- *While in Folder Name Search mode, press  to return to the selecting search mode.*
- *"NO FILE" is displayed for 2 seconds if the folder that is selected by the Folder Name Search mode contains no files.*
- *"ROOT" is displayed for the root folder that does not have folder name.*
- *Folder Name search cannot be made during M.I.X. play.*
- *Folders are skipped continuously by touching and holding either side of the **GlideTouch bar**.*

File Name Search mode

3 Within 10 seconds, select the file to play back by sliding your finger on the **GlideTouch bar** to the left or right. Press the **GlideTouch bar** or **FUNC.** to play the selected file.

The selected file is played back.

- *File Name Search mode is cancelled by pressing and holding  for at least 2 seconds.*
- *While in the File Name Search mode, press  to switch to the previous mode (Folder Search mode or the selecting search mode).*
- *File Name search cannot be made during M.I.X. play.*
- *Files are skipped continuously by touching and holding either side of the **GlideTouch bar**.*

About MP3/WMA

CAUTION

Except for private use, duplicating audio data (including MP3/WMA data) or distributing, transferring, or copying it, whether for free or for a fee, without permission of the copyright holder is strictly prohibited by the Copyright Act and by international treaty.

What is MP3?

MP3, whose official name is "MPEG-1 Audio Layer 3," is a compression standard prescribed by the ISO, the International Standardization Organization and MPEG which is a joint activity institution of the IEC.

MP3 files contain compressed audio data. MP3 encoding is capable of compressing audio data at extremely high ratios, reducing the size of music files to as much as one-tenth their original size. This is achieved while still maintaining near CD quality. The MP3 format realizes such high compression ratios by eliminating the sounds that are either inaudible to the human ear or masked by other sounds.

What is WMA?

WMA, or "Windows Media™ Audio," is compressed audio data.

WMA is similar to MP3 audio data and can achieve CD quality sound with small file sizes.

Method for creating MP3/WMA files

Audio data is compressed by using MP3/WMA specified software. For details on creating MP3/WMA files, refer to the user's manual for that software.

MP3/WMA files that can be played back by this device have the file extension "mp3" / "wma". Files with no extension cannot be played back. (WMA ver. 7.1, 8 are supported)

Supported playback sampling rates and bit rates

MP3

Sampling rates : 32 kHz - 48 kHz

Bit rates: 32 - 320 kbps

WMA

Sampling rates : 32 kHz - 48 kHz

Bit rates: 32 - 320 kbps

This device may not play back correctly depending on sampling rates or bit rates.

ID3 tags/WMA tags

If tag data is in an MP3/WMA file, this device can display the title (track title), artist name, and album name ID3 tag/WMA tag data.

This device can only display single-byte alphanumeric characters and the underscore. For non-supported characters, "NO SUPPORT" is displayed. The number of characters may be limited, or not correctly displayed, depending on the tag information.

Producing MP3/WMA discs

MP3/WMA files are prepared, then written to a CD-R or CD-RW (DVD-R) using CD-R writing software. A disc can hold up to 1024 files/256 folders (Including Root Folders).

Depending on the structure of the folders or files, it may take time to read a disc. In this case, it is recommended to decrease the number of folders or files.

Media supported

The media that this device can play back are CD-ROMs, CD-Rs, and CD-RWs.

Corresponding File Systems

This device supports discs formatted with ISO9660 Level 1 or Level 2.

Under the ISO9660 standard, there are some restrictions to remember.

The maximum nested folder depth is 8 (including the root directory). The number of characters for a folder/file name is limited.

Valid characters for folder/file names are letters A-Z (all caps), numbers 0-9, and '_' (underscore).

This device also can play back discs in Joliet, Romeo, etc., and other standards that conform to ISO9660. However, sometimes the file names, folder names, etc., are not displayed correctly.

Formats supported

This device supports CD-ROM, CD-ROM XA, Mixed Mode CD, Enhanced CD (CD-Extra) and Multi-Session.

This device cannot correctly play back discs recorded with Track At Once or packet writing.

Order of files

The unit plays the files in the order that the writing software writes them. Therefore, the playing order may not be the same as the order you input. The playback order of the folders and files is as follows. However, the folder and file playback order differs from the folder and file number indicated on the display.

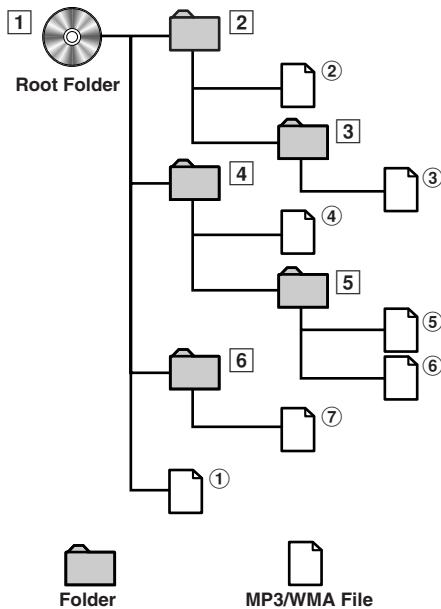

Terminology

Bit rate

This is the "sound" compression rate specified for encoding. The higher the bit rate, the higher the sound quality, but also the larger the files.

Sampling rate

This value shows how many times per second the data is sampled (recorded). For example, music CDs use a sampling rate of 44.1 kHz, so the sound is sampled (recorded) 44,100 times per second. The higher the sampling rate, the higher the sound quality, but also the larger the volume of data.

Encoding

Converting music CDs, WAVE (AIFF) files, and other sound files into the specified audio compression format.

Tag

Song information such as track titles, artist names, album names, etc., written into MP3/WMA files.

MP3: ID3 tag

WMA: WMA tag

Root folder

The root folder is found at the top of the file system. The root folder contains all folders and files.

DVD/Video CD

Playing DVD/Video CD

⚠ Caution

- Not all functions will be operated for every DVD. See the individual DVD's instructions for details on the features supported.
- Fingerprints on a disc may adversely affect playback. If a problem occurs, remove the disc and check for fingerprints on the playback side. Clean the disc if necessary.
- When using the remote control, be careful to press only one button at a time. Pressing multiple buttons at the same time may cause erroneous operation.
- If you try to perform an invalid operation (based on the type of disc being played), the following mark is displayed on the monitor screen: ⓪

Play Position Memory Function

Even if you turn power off or switch the Ignition Key to OFF during playback or change the source, playback will continue from the point where playback stopped when the power is turned ON again.

1 Insert a disc with the label side facing up.

The disc will be pulled into the unit automatically.

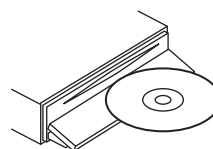

When a disc is already inserted, press SOURCE/POWER on the main unit to switch to the DISC mode.

The mode will change every time the button is pressed.

DISC → TUNER → CD CHANGER* → DISC

* Only when the CD changer is connected

2 To eject the disc, press ▲ on the main unit.

- Do not remove a disc during its eject cycle. Do not load more than one disc at a time. A malfunction may result from doing either.
- If the disc does not eject, press and hold ▲ for at least 2 seconds.
- The reverse side of a double-sided DVD will not be played automatically. Remove the disc, turn it over, and reinsert it.
- Never insert map discs for navigation purposes as they could damage the equipment.
- Refer also to "DVD Setup" (pages 33 to 35).

If a menu screen appears

On DVDs and video CDs with playback control (PBC), menu screens may appear automatically. If this happens, perform the operation described below to start playback.

- This operation is performed by the remote control unit.
- For many discs, the menu screen can also be displayed by pressing MENU.

DVD menu

Press ▲, ▼, ◀ or ▶ to select the desired item, then press ENT.

- For some discs it is possible to select items directly from the menu screen using the number keys ("0" to "9").

Video CD menu

Use the number keys ("0" to "9") to select the desired number, then press ENT.

- The menu screen does not appear when the PBC function is turned off. In this case, set VCD PLAY MODE to turn on the PBC function. For details, refer to "Setting the Video CD Play Mode" (page 36).

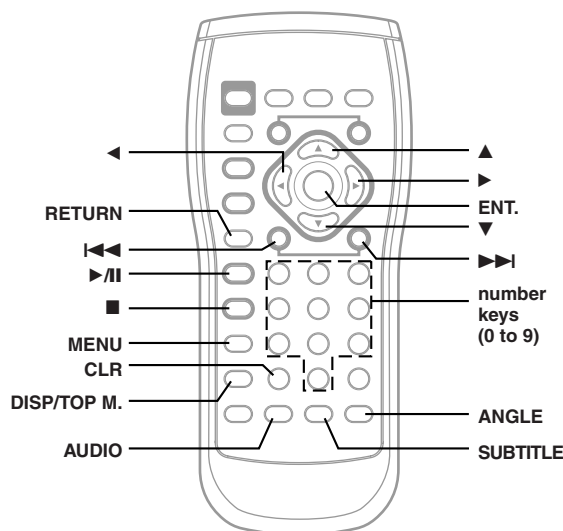
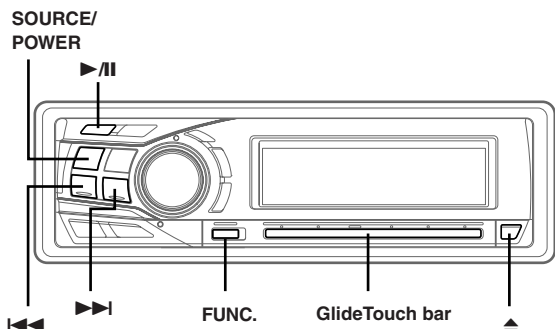

- DVD and Video CD operation can be controlled from both the remote control and the main unit. In this section, both remote control and main unit operation are described. For GlideTouch bar details, refer to page 20.
- To view DVD and Video CD, the optional TV monitor is required.
- DVA-9965E automatically changes the video output signal (NTSC or PAL), according to the disc. To set NTSC or PAL on the connected monitor, refer to the Owner's Manual of the monitor.

Stopping Playback (PRE-STOP)

Press ■ during playback to stop playback. That position is stored in memory.

- 1 During playback, press ■ on the remote control unit.**
"PRE-STOP" is displayed.
- 2 Press ►/II in the PRE-STOP mode.**
Playback starts from the position at which it was stopped.
 - For some discs, the position at which playback was stopped may not be accurate.

Stopping Playback

During playback, press and hold ■ for at least 2 seconds.

"STOP" is displayed, and playback stops.

- Pressing ■ twice also stops playback.
- Playback starts from the beginning when ►/II is pressed while playback is stopped.

Fast-forwarding/Fast-reversing

- 1 During playback, press and hold I◀◀ (fast-reverse) or ▶▶I (fast-forward) .**
When pressed for more than 1 second, the disc is forwarded/reversed at double speed.
When held in 5 more seconds, the disc is forwarded/reversed at 8 times the normal speed.
- 2 Release I◀◀ or ▶▶I to return to normal playback.**
 - No sound is played during fast-forwarding/fast-reversing.
 - Fast-forwarding/fast-reversing of only a track being played back can be made on the Video CD equipped with PBC (play back control).
 - For DVDs and video CDs with playback control (PBC), the menu screen may reappear during fast-forwarding/fast-reversing.

Finding the Beginning of Chapters or Tracks

During playback, press I◀◀ or ▶▶I.

The chapter/track switches each time the button is pressed, and playback of the selected chapter/track starts.

▶▶I: Press this to start playback from the beginning of the following chapter or track.

I◀◀: Press this to start playback from the beginning of the current chapter or track.

- Some DVDs do not have chapters.
- The beginning of a track may not be found on the Video CD equipped with PBC (playback control). Set VCD PLAY MODE to turn the PBC function off. Refer to "Setting the Video CD Play Mode" (page 36).

Supplementary explanation

"Chapters" are divisions of movies or musical selections on DVDs.
"Tracks" are divisions of movies or musical selections on video and music CDs.

Playing Still Frames (pausing)

- 1 During playback, press ►/II.**
- 2 Press ►/II to resume playback.**
 - No sound is played during the still mode.
 - The image or sound may stop temporarily when playback starts from the pause mode. This is not a malfunction.

Forward/reverse frame-by-frame Playback

- 1 In the pause mode, press I◀◀ or ▶▶I.**
The picture advances or reverses by one frame each time the button is pressed.
- 2 Press ►/II to resume normal playback.**
 - No sound is output during forward/reverse frame-by-frame playback.
 - For video CD, reverse frame-by-frame playback is not available.

Slow Motion Playback

- 1 When I◀◀ or ▶▶I is pressed and held while in the pause mode, the 1/8th speed slow motion playback mode is set.**
When held in for 5 more seconds, the slow motion speed switches to 1/2 the normal speed.
- 2 Release I◀◀ or ▶▶I to pause, and press ►/II to playback.**
 - No sound is played during slow motion playback.
 - Slow playback is not available when playing back a slide show.
 - 1/2 and 1/8 are approximate speeds. The actual speed differs from disc to disc.
 - For video CD, reverse slow motion playback is not available.

Searching by Title Number (DVD only)

Use this function to easily find positions on the DVD using the DVD's title.

- This operation is performed by the remote control unit.

- 1 When playback stops, input the number of the title you want to play by using the number keys ("0" to "9").**
- 2 Press ENT.**
Playback starts from the selected title number.
 - This function cannot be used on discs on which no title numbers are recorded.
 - Press CLR to delete the last digit in the title number. Press and hold CLR for at least 2 seconds to clear all title numbers.
 - Press RETURN to cancel the title search mode and resume normal playback.
 - The playback starts automatically for two digit title numbers even if ENT. in procedure 2 is not pressed.

Searching Directly by Chapter or Track Number

Use this function to easily move to the beginning of the chapters or tracks on the disc.

- This operation is performed by the remote control unit.

1 During playback or pre-stop, input the chapter or track number you desire using the number keys ("0" to "9").

2 Press **ENT**.

Playback starts from the selected chapter or track.

- This function cannot be used on discs on which no chapter numbers are recorded.
- The beginning of a track number cannot be directly found on the Video CD equipped with PBC (playback control). Set VCD PLAY MODE to turn the PBC function off. Refer to "Setting the Video CD Play Mode" (page 36).
- Depending on the number of digits input, playback may start automatically even if **ENT** is not pressed in step 2.
- Press **CLR** to delete the last digit in the chapter/track number. Press and hold **CLR** for at least 2 seconds to clear "Chapter" and "Track" numbers.
- Press **RETURN** to cancel the chapter/track search mode and resume normal playback.

Chapter/Track/Title Repeat Playback

Use this function to play the disc's titles, chapters or tracks repeatedly.

1 Press **FUNC.** to activate the audio function mode.

Source select mode → Audio function mode 1* →
Audio function mode 2 → Source operation mode →
Source select mode

- * DVD mode only.

2 Press the **GlideTouch bar** under **RPT** to select the **RPT mode**.

The repeat mode switches each time the button is pressed.

DVD

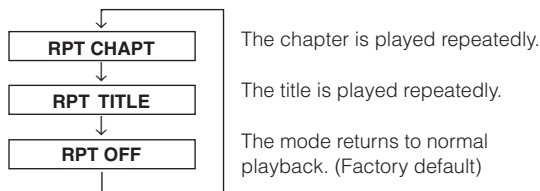

- By pressing **GlideTouch bar** under **RPT** for more than 2 seconds, the unit will switch to **REPEAT OFF**.

VIDEO CD

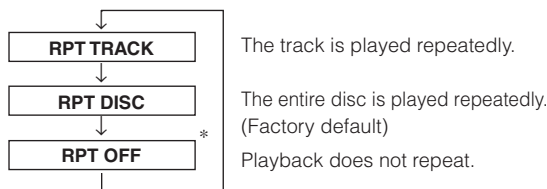

- * Displayed only in the changer mode.

- The track/disc repeat modes cannot be used on video CDs with playback control (PBC). Set VCD PLAY MODE to turn the PBC function off. Refer to "Setting the Video CD Play Mode" (page 36).
- For some discs it is not possible to switch the repeat mode.

Switching the Audio Tracks

DVDs can have up to 8 different audio tracks. These alternate tracks can be switched during playback.

- This operation is performed by the remote control unit.

During playback, press **AUDIO**.

The sound switches between the alternate audio tracks recorded on the disc each time the button is pressed.

- The selected audio track becomes the default setting every time the power is turned on or the disc is replaced. If a disc does not include the language you selected for the default audio track, the disc's default language is selected instead. Refer to "Setting the language" (page 33).
- Not all discs will allow changing the alternate audio tracks during playback. In these cases, select audio tracks from the DVDs menu.
- There may be a delay before the selected alternate track begins to play.

Video CDs with multiplex audio

During playback, press **AUDIO**.

The left and right channels will be output as shown in the figure below, each time the button is pressed.

LR → LL → RR → LR

Switching the Angle (DVD only)

On DVDs in which scenes have been filmed from multiple angles, the angle can be switched during playback.

- This operation is performed by the remote control unit.

During playback, press **ANGLE**.

The angle switches between the angles recorded on the disc each time the button is pressed.

- Some time may be required for the angle to change.
- Depending on the disc, the angle may switch in one of two ways.
 - Seamless: The angle switches smoothly.
 - Non-seamless: When the angle is switched, a still picture is displayed first, after which the angle switches.

Switching the Subtitles (subtitle language) (DVD only)

With multiple subtitle language DVDs, the subtitle language can be switched during playback, or subtitles can be hidden.

- This operation is performed by the remote control unit.

During playback, press **SUBTITLE**.

The subtitle switches between the languages recorded on the disc and OFF each time the button is pressed.

- There may be a delay before the selected subtitle appears.
- Not all discs will allow changing the subtitles during playback. In these cases, select subtitles from the DVD's menu.
- The selected subtitle language becomes the default setting every time the power is turned on or the disc is replaced. If a disc does not include that language, the disc's default language is selected instead. Refer to "Setting the language" (page 33).
- For some discs, the subtitles will be displayed even when this is set to off.

Tips

Switching from the disc menu.

For some discs, the audio language, angle and subtitles can be switched from the disc menu.

- This operation is performed by the remote control unit.
 - 1 Press **MENU**, select the item, then press **ENT**.
 - 2 Press **▲**, **▼**, **◀** or **▶** to select the language or angle, then press **ENT**.
(For some discs, they can be selected using the number keys "0" to "9" while the language or the angle menu is displayed.)

Displaying the Disc Status (DVD only)

Use the procedure described below to display the status (title number, chapter number, etc.) of the currently playing DVD on the monitor screen.

- This operation is performed by the remote control unit.

During playback, press **DISP/TOP M**.

The playback status is displayed.

The playback status display closes when **DISP/TOP M** is pressed again.

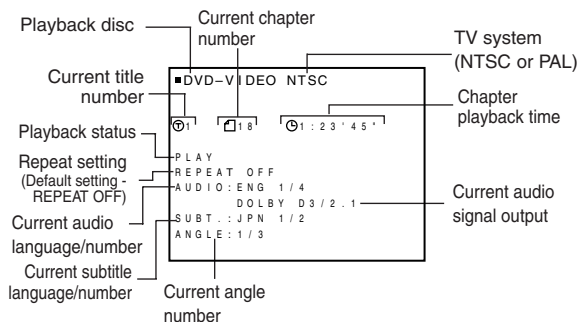

Displaying the Disc Status (Video CD only)

Use the procedure described below to obtain an on-screen display of the status (track number, etc.) of the currently playing video CD on the monitor screen.

- This operation is performed by the remote control unit.

During playback, press **DISP/TOP M**.

The playback status is displayed.

The playback status display closes when **DISP/TOP M** is pressed again.

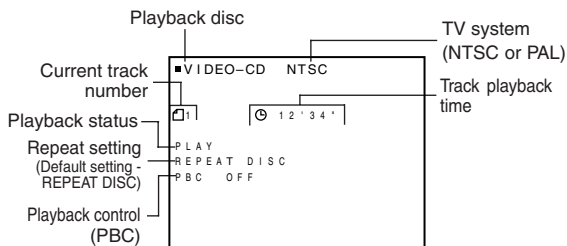

- When **PBC** is set to **ON**, the current track number and track playback time is not displayed.

GlideTouch bar Operation

The **GlideTouch bar** controls the same functions as the unit buttons and remote control.

1 Press **FUNC.** then select the desired mode.

Source select mode →
 Audio function mode 1* (◀, ▶, ENT., etc.) →
 Audio function mode 2 (AUDIO, RPT, etc.) →
 Source operation mode (◀◀, ▶▶, etc.) →
 Source select mode

* DVD mode only.

2 The function guide of the selected mode is displayed.

3 Press the position on the **GlideTouch bar** which corresponds to the function guide in the display.

Source Operation Mode

<DVD/Video CD mode>

■	Stopping Playback (PRE-STOP)	pgae17
■	Stopping Playback	pgae17
◀◀▶▶	Fast-forward/Fast-reverse	pgae17
◀◀▶▶▶▶	Find the Beginning of Chapters or Tracks	pgae17
▶	Playback	pgae17
	Still (pause)	pgae17
◀◀▶▶▶▶	Forward/Reverse frame-by-frame playback	pgae17
◀◀▶▶▶▶	Slow Motion Playback	pgae17

Audio Function Mode

<DVD mode>

◀▶/▲/▼/ENT.	Selection button when the menu display is indicated.	page16
RTN	Return to the previous display (Depending on the disc, it may not be possible to return to the previous display.)	



FUNC.

Press **FUNC.** to change.



TOP.M	Recall the top menu display	page16
MENU	Recall the menu display	page16
AUDIO	Switching the Audio Tracks	page18
SUBT.	Switching the Subtitles	page19
ANGLE	Change the angle	page18
RPT	Chapter/Title repeat playback	page18

<Video CD mode>

AUDIO	Change audio output	page18
RPT	Chapter/Track repeat playback	page18
PBC	Set Video CD playback mode	page36
RTN	Return to the previous display (Depending on the disc, it may not be possible to return to the previous display.)	

Sound Setting

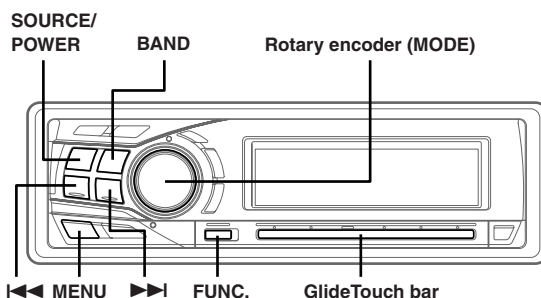

Adjusting Balance (Between Left and Right)/Fader (Between Front and Rear)/Defeat

1 Press the **Rotary encoder (MODE)** repeatedly to choose the desired mode.

Each press changes the mode as follows:

SUBWOOFER*¹ → BALANCE → FADER → DEFEAT →
 VOLUME → SUBWOOFER*¹

Subwoofer : 0 ~ +15
 Balance : L15 ~ R15
 Fader : R15 ~ F15
 Defeat : ON/OFF
 Volume : 0 ~ 35

Press ◀◀ or ▶▶ after selecting the Subwoofer mode, and the subwoofer output phase is switched NORMAL (PHASE 0°) or REVERS (PHASE 180°).

- If the **Rotary encoder (MODE)** is not pressed within 5 seconds after selecting the **BALANCE**, **FADER**, **DEFEAT** or **SUBWOOFER** mode, the unit automatically returns to normal mode.
- If you set the 2WAY/3WAY switch (page 65, 66 and 68) to 3WAY, you cannot adjust the **FADER** mode.

*¹ When the subwoofer mode is set to OFF, its level and phase cannot be adjusted.

2 Turn the **Rotary encoder (MODE)** until the desired sound is obtained in each mode.

By setting Defeat ON, previously adjusted settings of EQ will return to the factory defaults and MX is turned off.

- If an external audio processor is connected, refer to "External Audio Processor (Optional)" (pages 43 to 51).

Selecting the EQ mode (Factory settings)

- 1 Press **MENU**.
- 2 Select the Factory's EQ mode by sliding your finger on the **GlideTouch bar** to the left or right. Press the **GlideTouch bar** under the Factory's EQ mode.
- 3 Select the desired equalizer characteristic by sliding your finger on the **GlideTouch bar** to the left or right.
 - By selecting USER'S 1 to 6, you can recall the stored preset number in "Adjusting and Storing the Graphic Equalizer Curve." (page 22) or "Adjusting and Storing the Parametric Equalizer Curve" (this page).
- 4 Press and hold **MENU** for at least 2 seconds to return to normal mode.
 - This function is inoperable when DEFEAT is set to ON (page 20).
 - If **MENU** is pressed while adjusting or setting the items in the **MENU** mode, the unit returns to the previous selection screen.
 - By pressing the **GlideTouch bar** under RETURN in the **MENU** mode, the unit will return to the normal mode.
 - If no operation is performed for 60 seconds, the unit will return to the normal mode.

Setting User's EQ mode

This setting gives you a choice of 9-band parametric, or 9-band graphic equalizer.

- 1 Press **MENU**.
- 2 Select Setup by sliding your finger on the **GlideTouch bar** to the left or right. Press the **GlideTouch bar** under Setup. The main SETUP menu is displayed.
- 3 Select AUDIO by sliding your finger on the **GlideTouch bar** to the left or right. Press the **GlideTouch bar** under AUDIO. The AUDIO SETUP menu is displayed.
- 4 Select EQ MODE by sliding your finger on the **GlideTouch bar** to the left or right. Press the **GlideTouch bar** under EQ MODE.
- 5 Select EQ Type by sliding your finger on the **GlideTouch bar** to the left or right. Press the **GlideTouch bar** under P.EQ or G.EQ.

P.EQ: 9-band parametric EQ (initial setting)
G.EQ: 9-band graphic EQ
- 6 Press and hold **MENU** for at least 2 seconds to return to normal mode.
 - If **MENU** is pressed while adjusting or setting the items in the **MENU** mode, the unit returns to the previous selection screen.
 - By pressing the **GlideTouch bar** under RETURN in the **MENU** mode, the unit will return to the normal mode.
 - If no operation is performed for 60 seconds, the unit will return to the normal mode.

Adjusting and Storing the Parametric Equalizer Curve

You can modify the Equalizer settings to create a response curve more appealing to your personal taste.

To adjust the parametric equalizer curve, set the EQ mode to P.EQ. For details, refer to "Setting User's EQ mode" (this page).

- 1 Press and hold **MENU** for at least 2 seconds.
- 2 Select the Parametric EQ mode by sliding your finger on the **GlideTouch bar** to the left or right. Press the **GlideTouch bar** under the Parametric EQ mode.
- 3 Press **BAND** to select the band to be adjusted.

BAND1 → BAND2 → ... BAND9 → BAND1
- 4 Select the frequency by sliding your finger on the **GlideTouch bar** to the left or right.
- 5 Adjust the level by turning the **Rotary encoder**.

Adjustable level: ±7step (1step: 1.3dB)
- 6 Press **SOURCE/POWER** to set the band width (Q).
- 7 To adjust another band, repeat steps 3 to 6 and adjust all bands.
- 8 When the setting has been completed, press **FUNC.** or the **GlideTouch bar** to activate the preset mode.
- 9 Select any one of the preset numbers (1 through 6) by sliding your finger on the **GlideTouch bar** to the left or right. Press and hold the **GlideTouch bar** under the desired preset for at least 2 seconds. The adjustments are saved in the selected preset.
- 10 After setting, press and hold **MENU** for at least 2 seconds to return to normal mode.
 - This function is inoperable when DEFEAT is set to ON (page 20).
 - If **MENU** is pressed while adjusting or setting the items in the **MENU** mode, the unit returns to the previous selection screen.
 - By pressing the **GlideTouch bar** under RETURN in the **MENU** mode, the unit will return to the normal mode.
 - If no operation is performed for 60 seconds, the unit will return to the normal mode.

Adjusting and Storing the Graphic Equalizer Curve

You can modify the equalizer settings to create a response curve more appealing to your personal taste. To adjust the graphic equalizer curve, set the EQ mode to G.EQ. For details, refer to “Setting User’s EQ mode” (page 21).

- 1 Press and hold **MENU** for at least 2 seconds.
- 2 Select the Graphic EQ mode by sliding your finger on the **GlideTouch bar** to the left or right. Press the **GlideTouch bar** under the Graphic EQ mode.
- 3 Press **BAND** to select the band to be adjusted.
BAND1 → BAND2 → ... BAND9 → BAND1
- 4 Adjust the level by turning the **Rotary encoder**.
Adjustable output level: ± 7 step (1step:1.3dB)
- 5 To adjust another band, repeat steps 3 and 4, then adjust all bands.
- 6 When the setting has been completed, press **FUNC.** or the **GlideTouch bar** to activate the preset mode.
- 7 Select any one of the preset numbers (1 through 6) by sliding your finger on the **GlideTouch bar** to the left or right. Press and hold the **GlideTouch bar** under the desired preset for at least 2 seconds. The adjustments are saved in the selected preset.
- 8 After setting, press and hold **MENU** for at least 2 seconds to return to normal mode.

- This function is inoperable when **DEFEAT** is set to **ON** (page 20).
- If **MENU** is pressed while adjusting or setting the items in the **MENU** mode, the unit returns to the previous selection screen.
- By pressing the **GlideTouch bar** under **RETURN** in the **MENU** mode, the unit will return to the normal mode.
- If no operation is performed for 60 seconds, the unit will return to the normal mode.

Recalling the Stored Equalizer Curve

- 1 Press and hold **MENU** for at least 2 seconds.
- 2 Select the Parametric EQ or Graphic EQ mode by sliding your finger on the **GlideTouch bar** to the left or right. Press the **GlideTouch bar** under the Parametric EQ or Graphic EQ mode.
- 3 Press **FUNC.** or the **GlideTouch bar** to activate the preset mode.
- 4 Select any one of the preset numbers (1 through 6) by sliding your finger on the **GlideTouch bar** to the left or right. Press the **GlideTouch bar** under the desired preset. The previously stored adjustments are recalled.
- 5 Press and hold **MENU** for at least 2 seconds to return to normal mode.

- This function is inoperable when **DEFEAT** is set to **ON** (page 20).
- You can recall the adjusted equalizer curve from “Selecting the EQ mode (Factory settings)” (page 21).
- If **MENU** is pressed while adjusting or setting the items in the **MENU** mode, the unit returns to the previous selection screen.
- By pressing the **GlideTouch bar** under **RETURN** in the **MENU** mode, the unit will return to the normal mode.
- If no operation is performed for 60 seconds, the unit will return to the normal mode.

About the Crossover

Crossover:

This unit is equipped with an active crossover. The crossover limits the frequencies delivered to the outputs. Each channel is controlled independently. Thus, each speaker pair can be driven by the frequencies for which they have been optimally designed.

The crossover adjusts the HPF (high pass filter) or LPF (low pass filter) of each band, and also the slope (how fast the filter rolls off the highs or lows). Adjustments should be made according to the reproduction characteristics of the speakers. Depending on the speakers, a passive network may not be necessary. If you are unsure about this point, please consult your authorized Alpine dealer.

2 way mode

	Cut-off frequency (1/3 octave steps)		Slope		Level
	HPF	LPF	HPF	LPF	
Low range speaker	----	20 Hz - 200 Hz	----	FLAT, 6, 12, 18, 24 dB/oct	0 to -12 dB
Rear high range speaker	20 Hz - 200 Hz	----	FLAT, 6, 12, 18, 24 dB/oct	----	0 to -12 dB
Front high range speaker	20 Hz - 200 Hz	----	FLAT, 6, 12, 18, 24 dB/oct	----	0 to -12 dB

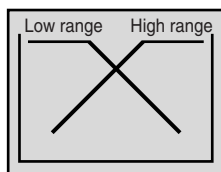

(Different from actual display)

3 way mode

	Cut-off frequency (1/3 octave steps)		Slope		Level
	HPF	LPF	HPF	LPF	
Low range speaker	----	20 Hz - 200 Hz	----	FLAT, 6, 12, 18, 24 dB/oct	0 to -12 dB
Mid range speaker	20 Hz - 200 Hz	1 kHz - 20 kHz	FLAT, 6, 12, 18, 24 dB/oct	FLAT, 6, 12, 18, 24 dB/oct	0 to -12 dB
High range speaker	1 kHz - 20 kHz	----	FLAT*1 6, 12, 18, 24 dB/oct	----	0 to -12 dB

*1 Only when selecting USER'S in "Setting the Response Slope for the High Range Speaker (page 38).

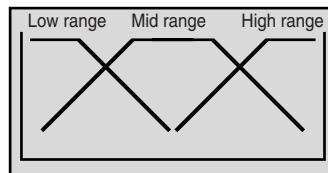

(Different from actual display)

Level adjusting

(0 to -12 dB)

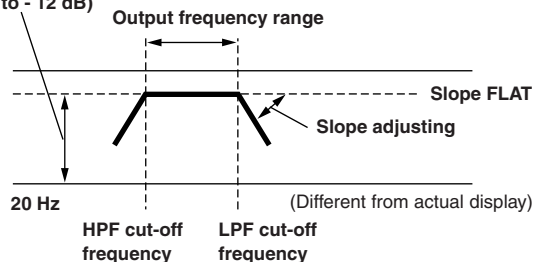

- **HPF (high pass filter):** Cuts the lower frequencies and allows the higher frequencies to pass.
 - **LPF (low pass filter):** Cuts the higher frequencies and allows the lower frequencies to pass.
 - **Slope:** The level change (in dB) for a frequency change of one octave.
 - The higher the slope value, the steeper the slope becomes.
 - Adjust the slope to FLAT to bypass the HP or LP filters.
 - Do not use a tweeter without the HPF on or set to a low frequency, as it may cause damage to the speaker due to the low frequency content.
 - You cannot adjust the crossover frequency higher than the HPF or lower than the LPF.
 - Use the recommended crossover frequencies of the speakers being used for setting the crossover. Adjusting to a frequency outside that recommended range might cause damage to the speakers. For the recommended crossover frequencies of Alpine speakers, refer to the respective Owner's Manual.
- Alpine is not responsible for damage of malfunction of speaker caused by improper crossover settings.

Adjusting and Storing the Crossover Settings

Before performing the following procedures, refer to "About the Crossover" (Page 23).

- 1 Press and hold **MENU** for at least 2 seconds.
- 2 Select the Crossover mode by sliding your finger on the **GlideTouch bar** to the left or right. Press the **GlideTouch bar** under the Crossover mode.

2 WAY System

- 3 Press **BAND** to select the band to be adjusted.
SUBW → REAR → FRONT → SUBW
- 4 Select the desired cut-off frequency (Crossover Point) by sliding your finger on the **GlideTouch bar** to the left or right.
Adjustable frequency bands: 20Hz to 200Hz
(in 1/3 octave steps)
- 5 Press **SOURCE/POWER** to adjust the slope.
Adjustable slope: FLAT, 6dB/oct., 12dB/oct.,
18dB/oct., 24dB/oct.
- 6 Adjust the output level by turning the **Rotary encoder**.
Adjustable output level: -12 to 0 dB.
- 7 To adjust another band, repeat steps 3 to 6, then adjust all bands.
- 8 When the setting has been completed, press **FUNC.** or the **GlideTouch bar** to activate the preset mode.
- 9 Select any one of the preset numbers (1 through 6) by sliding your finger on the **GlideTouch bar** to the left or right. Press and hold the **GlideTouch bar** under the desired preset for at least 2 seconds. The adjustments are saved in the selected preset.
- 10 After setting, press and hold **MENU** for at least 2 seconds to return to normal mode.

- If **MENU** is pressed while adjusting or setting the items in the **MENU** mode, the unit returns to the previous selection screen.
- By pressing the **GlideTouch bar** under **RETURN** in the **MENU** mode, the unit will return to the normal mode.
- If no operation is performed for 60 seconds, the unit will return to the normal mode.

3 WAY System

- 3 Press **BAND** to select the band to be adjusted.
LOW → MID-L → MID-H → HIGH → LOW
- 4 Select the desired cut-off frequency (Crossover Point) by sliding your finger on the **GlideTouch bar** to the left or right.
Adjustable frequency bands:
LOW: 20Hz to 200Hz (in 1/3 octave steps)
MID-L: 20Hz to 200Hz (in 1/3 octave steps)
MID-H: 1kHz to 20kHz (in 1/3 octave steps)
HIGH: 1kHz to 20kHz (in 1/3 octave steps)
- 5 Press **SOURCE/POWER** to adjust the slope.
Adjustable slope: FLAT*, 6dB/oct., 12dB/oct.,
18dB/oct., 24dB/oct.

* FLAT can be set for the HIGH slope only when **USER'S** is selected in "Setting the Response Slope for the High Range Speaker" (page 38). Depending on the response characteristics of the speaker, care should be taken when setting the response slope to FLAT, as speaker damage may result. With the DVA-9965E, a message is displayed when the response slope for the high range speaker is set to FLAT. After the message is displayed, press the **Rotary encoder** to set to FLAT.
- 6 Adjust the output level by turning the **Rotary encoder**.
Adjustable output level: -12 to 0 dB.
- 7 To adjust another band, repeat steps 3 to 6, then adjust all bands.
- 8 When the setting has been completed, press **FUNC.** or the **GlideTouch bar** to activate the preset mode.
- 9 Select any one of the preset numbers (1 through 6) by sliding your finger on the **GlideTouch bar** to the left or right. Press and hold the **GlideTouch bar** under the desired preset for at least 2 seconds. The adjustments are saved in the selected preset.
- 10 After setting, press and hold **MENU** for at least 2 seconds to return to normal mode.

- If **MENU** is pressed while adjusting or setting the items in the **MENU** mode, the unit returns to the previous selection screen.
- By pressing the **GlideTouch bar** under **RETURN** in the **MENU** mode, the unit will return to the normal mode.
- If no operation is performed for 60 seconds, the unit will return to the normal mode.
- About the 2way/3way system
You can switch to 2way/3way system mode with the 2way/3way switch on the bottom side of the unit (page 65, 66 and 68).



When setting to "3 WAY":

The unit can be operated in a 3 way system.

When setting to "F/R/Sub-W":

The unit can be operated in a 2 way system.

Recalling the Stored Crossover Settings

- 1 Press and hold **MENU** for at least 2 seconds.
- 2 Select the Crossover mode by sliding your finger on the **GlideTouch** bar to the left or right. Press the **GlideTouch** bar under the Crossover mode.
- 3 Press **FUNC.** or the **GlideTouch** bar to activate the preset mode.
- 4 Select any one of the preset numbers (1 through 6) by sliding your finger on the **GlideTouch** bar to the left or right. Press the **GlideTouch** bar under the desired preset to recall the stored contents.
- 5 Press and hold **MENU** for at least 2 seconds to return to normal mode.

- If **MENU** is pressed while adjusting or setting the items in the **MENU** mode, the unit returns to the previous selection screen.
- By pressing the **GlideTouch** bar under **RETURN** in the **MENU** mode, the unit will return to the normal mode.

About Time Correction

The distance between the listener and the speakers in a car vary widely due to the complex speaker placement. This difference in the distances from the speakers to the listener creates a shift in the sounds image and frequency characteristics. This is caused by the time delay between the sound reaching the listener's right versus the left ear.

To correct this, the DVA-9965E is able to delay the audio signal to the speakers closest to the listener. This effectively creates a perception of increased distance for those speakers. The listener can be placed at an equal distance between the left and right speakers for optimum staging.

The adjustment will be made for each speaker in 0.1 ms steps.

Example 1. Listening Position: Front Left Seat

Adjust the time correction level of the front left speaker to a high value and the rear right to zero or a low value.

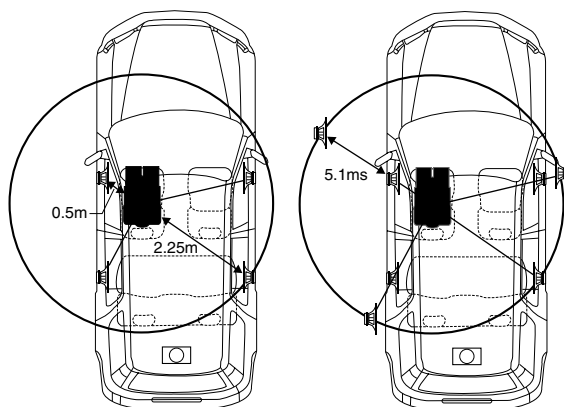

The sound is not balanced because the distance between the listening position and the various speakers is different. The difference in distance between the front left speaker and the rear right speaker is 1.75 m (68-7/8").

Here we calculate the time correction value for the front left speaker in the diagram on the above.

Conditions:

Farthest Speaker – listening position : 2.25 m (88-9/16")

Front left speaker – listening position : 0.5 m (19-11/16")

Calculation: $L = 2.25 \text{ m} - 0.5 \text{ m} = 1.75 \text{ m} (68-7/8")$

Time correction = $1.75 \div 343^{*1} \times 1000 = 5.1 \text{ (ms)}$

**1 Speed of sound: 343 m/s (765 mph) at 20°C*

In other words, giving the front left speaker a time correction value of 5.1 ms makes it seem as if its distance from the listener is the same as the distance to the farthest speaker.

Time correction eliminates the differences in the time required for the sound to reach the listening position.

The time of the front left speaker is corrected by 5.1 ms so that its sound reaches the listening position at the same time as the sound of other speakers.

Example 2. Listening Position: All Seats

Adjust the time correction level of each speaker to almost the same level.

- 1 Sit in the listening position (driver's seat, etc.) and measure the distance (in meters) between your head and the various speakers.
- 2 Calculate the difference between the distance to the farthest speaker and the other speakers.
 $L = (\text{distance to farthest speaker}) - (\text{distance to other speakers})$
- 3 Divide the distances calculated for the speakers by the speed of sound (343 m/s (765 mph) at 20°C).
These values are the time correction values for the different speakers.

Continued

Time Difference Table

Delay Number	Time Difference (ms)	Distance (cm)	Distance (inch)	Delay Number	Time Difference (ms)	Distance (cm)	Distance (inch)
0	0.0	0.0	0.0	51	5.1	173.4	68.3
1	0.1	3.4	1.3	52	5.2	176.8	69.7
2	0.2	6.8	2.7	53	5.3	180.2	71.0
3	0.3	10.2	4.0	54	5.4	183.6	72.4
4	0.4	13.6	5.4	55	5.5	187.0	73.7
5	0.5	17.0	6.7	56	5.6	190.4	75.0
6	0.6	20.4	8.0	57	5.7	193.8	76.4
7	0.7	23.8	9.4	58	5.8	197.2	77.7
8	0.8	27.2	10.7	59	5.9	200.6	79.1
9	0.9	30.6	12.1	60	6.0	204.0	80.4
10	1.0	34.0	13.4	61	6.1	207.4	81.7
11	1.1	37.4	14.7	62	6.2	210.8	83.1
12	1.2	40.8	16.1	63	6.3	214.2	84.4
13	1.3	44.2	17.4	64	6.4	217.6	85.8
14	1.4	47.6	18.8	65	6.5	221.0	87.1
15	1.5	51.0	20.1	66	6.6	224.4	88.4
16	1.6	54.4	21.4	67	6.7	227.8	89.8
17	1.7	57.8	22.8	68	6.8	231.2	91.1
18	1.8	61.2	24.1	69	6.9	234.6	92.5
19	1.9	64.6	25.5	70	7.0	238.0	93.8
20	2.0	68.0	26.8	71	7.1	241.4	95.1
21	2.1	71.4	28.1	72	7.2	244.8	96.5
22	2.2	74.8	29.5	73	7.3	248.2	97.8
23	2.3	78.2	30.8	74	7.4	251.6	99.2
24	2.4	81.6	32.2	75	7.5	255.0	100.5
25	2.5	85.0	33.5	76	7.6	258.4	101.8
26	2.6	88.4	34.8	77	7.7	261.8	103.2
27	2.7	91.8	36.2	78	7.8	265.2	104.5
28	2.8	95.2	37.5	79	7.9	268.6	105.9
29	2.9	98.6	38.9	80	8.0	272.0	107.2
30	3.0	102.0	40.2	81	8.1	275.4	108.5
31	3.1	105.4	41.5	82	8.2	278.8	109.9
32	3.2	108.8	42.9	83	8.3	282.2	111.2
33	3.3	112.2	44.2	84	8.4	285.6	112.6
34	3.4	115.6	45.6	85	8.5	289.0	113.9
35	3.5	119.0	46.9	86	8.6	292.4	115.2
36	3.6	122.4	48.2	87	8.7	295.8	116.6
37	3.7	125.8	49.6	88	8.8	299.2	117.9
38	3.8	129.2	50.9	89	8.9	302.6	119.3
39	3.9	132.6	52.3	90	9.0	306.0	120.6
40	4.0	136.0	53.6	91	9.1	309.4	121.9
41	4.1	139.4	54.9	92	9.2	312.8	123.3
42	4.2	142.8	56.3	93	9.3	316.2	124.6
43	4.3	146.2	57.6	94	9.4	319.6	126.0
44	4.4	149.6	59.0	95	9.5	323.0	127.3
45	4.5	153.0	60.3	96	9.6	326.4	128.6
46	4.6	156.4	61.6	97	9.7	329.8	130.0
47	4.7	159.8	63.0	98	9.8	333.2	131.3
48	4.8	163.2	64.3	99	9.9	336.6	132.7
49	4.9	166.6	65.7				
50	5.0	170.0	67.0				

Setting the Time Correction Unit

You can change the unit (ms, cm or inch) of time correction.

- 1 Press **MENU**.
- 2 Select Setup by sliding your finger on the **GlideTouch bar** to the left or right. Press the **GlideTouch bar** under Setup.
The main SETUP menu is displayed.
- 3 Select DISP by sliding your finger on the **GlideTouch bar** to the left or right. Press the **GlideTouch bar** under DISP.
The DISPLAY SETUP menu is displayed.
- 4 Select T.CORR by sliding your finger on the **GlideTouch bar** to the left or right. Press the **GlideTouch bar** under T.CORR.
- 5 Select (ms), (cm) or (inch) by sliding your finger on the **GlideTouch bar** to the left or right. Press under (ms), (cm) or (inch) on the **GlideTouch bar**.
- 6 After setting, press and hold **MENU** for at least 2 seconds to return to normal mode.
 - If **MENU** is pressed while adjusting or setting the items in the **MENU** mode, the unit returns to the previous selection screen.
 - By pressing the **GlideTouch bar** under **RETURN** in the **MENU** mode, the unit will return to the normal mode.
 - If no operation is performed for 60 seconds, the unit will return to the normal mode.

Adjusting and Storing the Time Correction

Before performing the following procedures, refer to "About Time Correction" (page 25).

- 1 Press and hold **MENU** for at least 2 seconds.
- 2 Select Time Correction mode by sliding your finger on the **GlideTouch bar** to the left or right. Press the **GlideTouch bar** under Time Correction.
- 3 Press **BAND** to select a speaker to be adjusted.
F-L → F-R → R-L → R-R → SW-L → SW-R → F-L
- 4 Adjust the time difference (0.0 to 9.9 ms) or distance by sliding your finger on the **GlideTouch bar** to the left or right. Or turn the **Rotary encoder** to adjust the time difference.
- 5 Repeat steps 3 and 4 to set another speaker.
- 6 When the setting has been completed, press **FUNC.** or the **GlideTouch bar** to activate the preset mode.

7 Select any one of the preset numbers (1 through 6) by sliding your finger on the **GlideTouch bar** to the left or right. Press and hold the **GlideTouch bar** under the desired preset for at least 2 seconds. The adjustments are saved in the selected preset.

8 After setting, press and hold **MENU** for at least 2 seconds to return to normal mode.

- If **MENU** is pressed while adjusting or setting the items in the **MENU** mode, the unit returns to the previous selection screen.
- By pressing the **GlideTouch bar** under **RETURN** in the **MENU** mode, the unit will return to the normal mode.
- If no operation is performed for 60 seconds, the unit will return to the normal mode.

Recalling the Stored Time Correction Settings

1 Press and hold **MENU** for at least 2 seconds.

2 Select the Time Correction mode by sliding your finger on the **GlideTouch bar** to the left or right. Press the **GlideTouch bar** under the Time Correction mode.

3 Press **FUNC.** or the **GlideTouch bar** to activate the preset mode.

4 Select any one of the preset numbers (1 through 6) by sliding your finger on the **GlideTouch bar** to the left or right. Press the **GlideTouch bar** under the desired preset to recall the stored contents.

5 Press and hold **MENU** for at least 2 seconds to return to normal mode.

- If **MENU** is pressed while adjusting or setting the items in the **MENU** mode, the unit returns to the previous selection screen.
- By pressing the **GlideTouch bar** under **RETURN** in the **MENU** mode, the unit will return to the normal mode.

Setting the MX Mode

MX (Media Xpander) makes vocals or instruments sound distinct regardless of the music source. The FM radio, CD, and MP3, will be able to reproduce the music clearly even in cars with a lot of road noise.

1 Press **MENU**.

2 Select the Media Xpander mode by sliding your finger on the **GlideTouch bar** to the left or right. Press the **GlideTouch bar** under the Media Xpander mode.

3 Press the **GlideTouch bar** under **ON** to activate **MX**.

4 After setting, press and hold **MENU** for at least 2 seconds to return to normal mode.

5 Press **SOURCE/POWER** to select the source to which you want to apply MX (Media Xpander).

6 Press and hold **MENU** for at least 2 seconds.

7 Select the Media Xpander mode by sliding your finger on the **GlideTouch bar** to the left or right. Press the **GlideTouch bar** under the Media Xpander mode.

8 Select the MX Level by sliding your finger on the **GlideTouch bar** to the left or right. Press the **GlideTouch bar** under the desired level or **OFF** (Non Effect).

FM (MX level 1 to 3):

The medium to high frequencies become clearer, and produces well balanced sound at all frequencies.

CD (MX level 1 to 3):

CD mode processes a large amount of data during playback. MX takes advantage of this large data quantity to reproduce a more clear, clean output.

CMPM (MX level 1 to 3):

This corrects information that was lost at the time of compression. This reproduces a well-balanced sound close to the original.

DVD (Video CD)

(MOVIE MX level 1 to 2):

The dialogue portion of a video is reproduced more clearly.

(DVD MUSIC):

A DVD or Video CD contains a large quantity of data such as music clip. MX uses this data to reproduce the sound accurately.

AUX (MX level 1):

Choose the MX mode (CMPM, MOVIE, or MUSIC) that corresponds to the media connected.

If two external devices are connected, a different MX mode for each media can be selected.

9 After setting, press and hold **MENU** for at least 2 seconds to return to normal mode.

- To cancel MX mode for all music sources, set MX to OFF in step 3.
- Each music source, such as FM radio, CD, and MP3/WMA can have its own MX setting.
- On discs with both MP3/WMA and CD-DA, when the source changes from "MP3/WMA to CD-DA" or "CD-DA to MP3/WMA", MX-mode switching may delay playback slightly.
- Setting to MX OFF sets MX mode of each music source to OFF.
- This function is inoperable when DEFEAT is set to ON.
- There is no MX mode for AM radio.
- If an audio processor with the MX function (PXA-H701, etc.) is connected, its own MX processing is applied to the music source. Since the processor MX settings may not match the head unit, the audio processor needs to be adjusted. For details, refer to the Owner's Manual of the audio processor.
- "CMPM" is applied for MP3/WMA, WAV and iPod.
- If **MENU** is pressed while adjusting or setting the items in the **MENU** mode, the unit returns to the previous selection screen.
- By pressing the **GlideTouch bar** under **RETURN** in the **MENU** mode, the unit will return to the normal mode.
- If no operation is performed for 60 seconds, the unit will return to the normal mode.

Other Functions

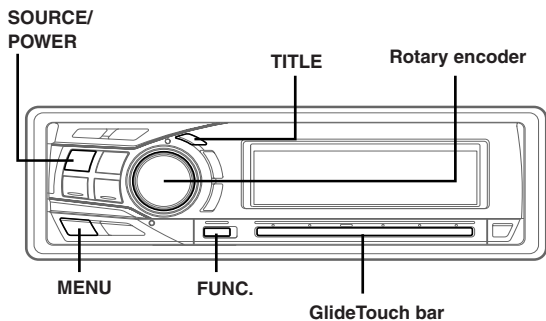

Displaying the Text

Text information, such as the disc name and the track name, will be displayed if playing a CD text compatible disc. It is also possible to display the folder name, the file name, and the tag, etc., while playing MP3/WMA files.

Press **TITLE**.

The display will change every time the button is pressed.

The display in Radio mode:

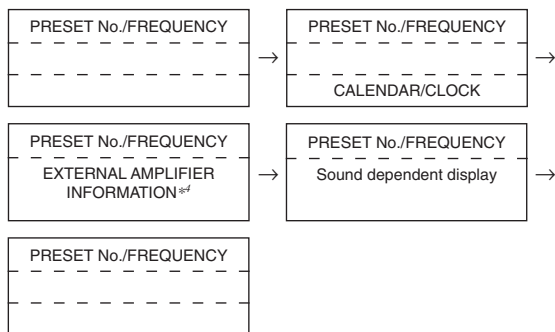

The display in CD mode:

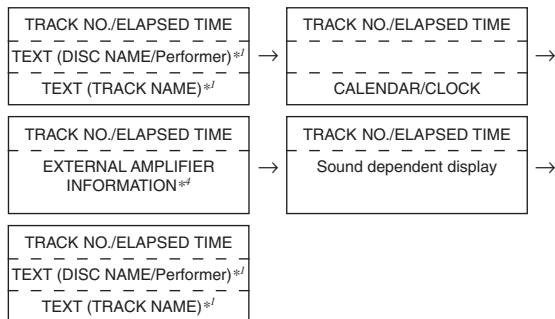

The display in MP3/WMA mode:

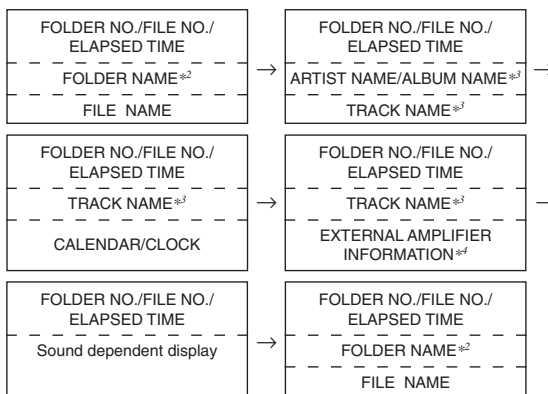

The display in DVD mode:

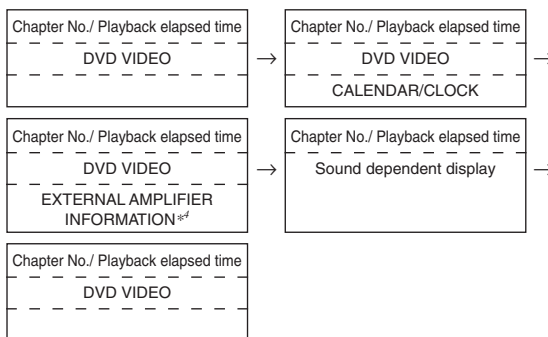

The display in Video CD mode:

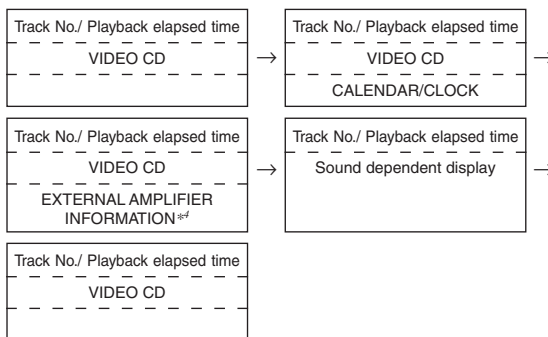

^{*1} Displayed during playback of a disc with CD Text.

"NO TEXT" will be displayed when the CD contains no Text data.

^{*2} "ROOT" is displayed for a root folder that does not have a folder name.

^{*3} ID3 tag/WMA tag

If an MP3/WMA file contains ID3 tag/WMA tag information, the ID3 tag/WMA tag information is displayed (e.g., track name, artist name, and album name). All other tag data is ignored.

"NO DATA" will be displayed when an MP3/WMA file contains no ID3 tag/WMA tag information.

^{*4} Only when an external Amplifier Link compatible amplifier is connected. For details, refer to "Displaying the External Amplifier Information" (page 30).

About "Text"

Text:

Text compatible CDs contain text information such as the disc name and track name. Such text information is referred to as "text."

- Some characters may not be displayed correctly with this device, depending on the character type.
- The CD changer must also be CD Text compatible for the Text information to be displayed.
- When the Scroll Setting (page 39) is set to "MANUAL," press and hold **TITLE** for at least 2 seconds to scroll the Text information only once (TEXT DISPLAY, FOLDER NAME DISPLAY, FILE NAME DISPLAY or TAG DISPLAY mode).
- "NO SUPPORT" is displayed when the desired text information cannot be displayed on this unit.
- The text or tag information may not be correctly displayed, depending on the contents.
- When external audio is interrupted (INTERRUPT is displayed), the time can be displayed by pressing **TITLE**.

Displaying Time

Press **TITLE** repeatedly until the time is displayed.

Each press changes the display.

For details, see "Displaying the Text" (page 28).

Blackout Mode On and Off

When Blackout mode is turned on, the display will turn off to reduce power consumption. This additional power enhances the sound quality.

Press and hold **FUNC.** for at least 2 seconds to activate the blackout mode.

The display will turn off.

- If any button on the unit is pressed during the blackout mode, the function will be displayed for 5 seconds to show the operation before returning to Blackout mode.

To cancel Blackout mode, press and hold **FUNC.** for at least 2 seconds.

Setting Amplifier Link

When an Amplifier Link compatible amplifier (MRD-M1005 or MRD-M605, etc.) is connected, the amplifier settings are adjustable from the head unit. A maximum of 8 external amplifiers can be adjusted.

- 1 Press and hold **MENU** for at least 2 seconds.
- 2 Select the Amplifier Link mode by sliding your finger on the **GlideTouch bar** to the left or right. Press the **GlideTouch bar** under the Amplifier Link mode.
- 3 Select the AMP-1 to AMP-8 to be adjusted by sliding your finger on the **GlideTouch bar** to the left or right. Press the **GlideTouch bar** under the desired AMP 1 to 8.

The input level mode to be adjusted is activated.

If a Mono Amplifier is connected

- 4 Adjust the input level by sliding your finger on the **GlideTouch bar** to the left or right. Press the **GlideTouch bar** under the desired level.

If a 4ch Amplifier is connected

- 4 Adjust the input level of CH 1/2 by sliding your finger on the **GlideTouch bar** to the left or right. Press the **GlideTouch bar** under the desired level.
- 5 Adjust the input level of CH 3/4 by sliding your finger on the **GlideTouch bar** to the left or right. Press the **GlideTouch bar** under the desired level.
- 6 When adjustment has been completed, press and hold **MENU** for at least 2 seconds to return to normal mode.

- For details of each of the settings, refer to the Owner's Manual of the external amplifier.
- If amplifier settings are made on the unit, do not then change the setting with the amplifier buttons as the amplifier display may not match the operations of the unit.
- "No Link" is displayed if the amplifier is removed or its power cannot be turned on, etc.
- If multiple amplifiers are connected to this unit, set a different ID on each amplifier. Otherwise the display may flicker.
- External amplifier information display can be changed by pressing **TITLE** while adjusting the input level.
- If the **GlideTouch bar** is pressed and held while adjusting the input level, the amplifier link mode can be switched between lock and unlock.
- If **MENU** is pressed while adjusting or setting the items in the MENU mode, the unit will return to the previous selection screen.
- By pressing the **GlideTouch bar** under RETURN in the MENU mode, the unit will return to the normal mode.
- If no operation is performed for 60 seconds, the unit will return to the normal mode.

Displaying the External Amplifier Information

When an Amplifier Link compatible amplifier is connected, the amplifier's status (voltage, temperature and fan status) can be shown in the head unit's display.

1 Press **TITLE** in the Radio or CD mode to switch the display of the external amplifier information.

- For switching the display, refer to the section "Displaying the Text" (page 28).
- For changing the iPod display, refer to the section "Displaying the Text" (page 42).

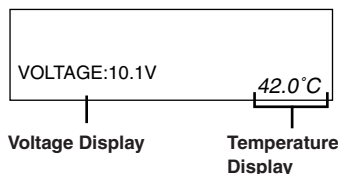

↑↓ The temperature display and the fan status display are alternately displayed.

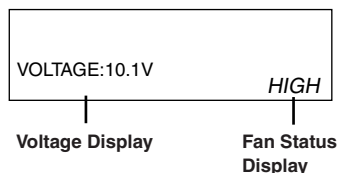

- To switch the display between Celsius and Fahrenheit, refer to page 39.

Setting the Multicolour Illumination

You can change the lighting colour of the following four buttons : SOURCE/POWER, BAND, ◀◀ and ▶▶.

- 1 Press **MENU**.
- 2 Select the Multicolour Illumi. mode by sliding your finger on the **GlideTouch** bar to the left or right. Press the **GlideTouch** bar under the Multicolour Illumi. mode.
- 3 Change the colour by sliding your finger on the **GlideTouch** bar to the left or right. Press the **GlideTouch** bar under the desired colour.

BLUE ↔ GREEN ↔ AMBER ↔ RED ↔ (USER1-6*)

- 4 Press **SOURCE/POWER** to change to the 2 lit Illumination mode.
- 5 Touch the **GlideTouch** bar, and select the lighting colour for the whole unit by sliding it to the left or right.

AMBER ↔ GREEN ↔ AUTO

- *AUTO*: As you change the colour of the illuminated buttons, their colour switches between AMBER and GREEN.

- 6 Press **FUNC.** or the **GlideTouch** bar to execute.
- 7 After setting, press and hold **MENU** for at least 2 seconds to return to normal mode.

* You can also use other colours if they have already been stored in the USER'S presets described below.

If you want to use colours other than the above

- 1 Press **MENU**.
- 2 Select the Multicolour Illumi. mode by sliding your finger on the **GlideTouch** bar to the left or right. Press the **GlideTouch** bar under the Multicolour Illumi. mode.
- 3 Turn the **Rotary encoder** to select colours (1 through 512).
Each press of BAND advances the colour number by 30.
1.....19.....184.....363.....512
(Red) (Amber) (Green) (Blue)
- 4 Select any one of the preset numbers (1 through 6) by sliding your finger on the **GlideTouch** bar to the left or right. Press the **GlideTouch** bar under the desired preset to store the adjustment.

To recall the stored colour setting

Select USER'S 1 through 6 in "Setting the Multicolour Illumination" step 3.

The stored setting contents are recalled.

- 5 After setting, press and hold **MENU** for at least 2 seconds to return to normal mode.

- If **MENU** is pressed while adjusting or setting the items in the **MENU** mode, the unit returns to the previous selection screen.
- By pressing the **GlideTouch** bar under **RETURN** in the **MENU** mode, the unit will return to the normal mode.
- If no operation is performed for 60 seconds, the unit will return to the normal mode.

Rear DVD Function

- 1 Select the desired audio source.
- 2 Press **MENU**.
- 3 Select Rear DVD by sliding your finger on the **GlideTouch bar** to the left or right. Press the **GlideTouch bar** under Rear DVD.
- 4 Select ON or OFF by sliding your finger on the **GlideTouch bar** to the left or right. Press the **GlideTouch bar** under ON or OFF.

If ON is set:

You can enjoy the picture and background of an inserted disc on the front or rear monitor while listening to an alternate audio source, such as the radio, on this unit.

The Rear DVD function setting determines which remote control sensor is recognized. When remote control operation is disabled, operation from the head unit controls is still possible.

Confirm this in the following table.

SOURCE	REAR DVD ON/OFF setting	Remote Input is connected*1 or remote control with optional remote control eye (KRE-500E).	Remote control with the unit's built-in sensor	Operation by the unit buttons
Built-in DISC	ON	Remote control of built-in disc mode	Inoperable	Unit buttons control of built-in disc mode
	OFF	Inoperable*2	Remote control of built-in disc mode	Unit buttons control of built-in disc mode
Built-in TUNER	ON	Remote control of built-in disc mode	Inoperable	Unit buttons control Tuner mode
	OFF	Inoperable*2	Remote control of Tuner mode	Unit buttons control Tuner mode
Ai-NET Changer etc.	ON	Remote control of built-in disc mode	Inoperable	Remote control of Changer etc.
	OFF	Inoperable*2	Remote control of Changer etc.	Remote control of Changer etc.

*1 Use the remote control sensor of the connected monitor.

*2 If an Alpine touch panel compatible monitor (monitor control lead connected) is connected and touch operation can be performed.

5 Press and hold **MENU** for at least 2 seconds to return to normal mode.

- The volume of any add-on displays (rear monitor, etc.) cannot be adjusted from the DVA-9965E. Adjust the volume on the display itself. In addition, its sound cannot be muted.
- The function for external interruption of the sound of the rear monitor (from the navigation system, for example) cannot be used when the rear DVD function setting is turned on.
- If you are listening to the AM radio while the rear DVD function is set to ON, noises may be heard from the radio, but this is not a malfunction.

i-Personalize™ Data Download Operation

SOURCE/POWER

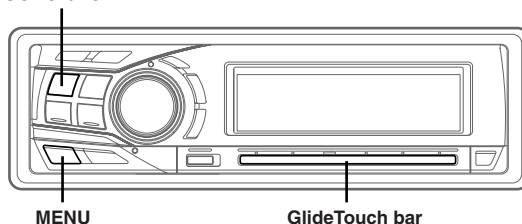

About i-Personalize™ Data Download

You can download data (from Alpine's website) to a CD-R, and download and store the data to the DVA-9965E.

To start i-Personalize, access the URL below and follow the on-screen instructions.

<http://www.alpine.com> or <http://www.alpine-europe.com> or <http://www.alpine.com.au>

Downloadable data

Parametric equalizer or Graphic equalizer	Data is memorized in Preset 6 of the Parametric EQ mode or Graphic EQ mode.
Time correction	Data is memorized in Preset 6 of the Time Correction mode.
Crossover	Data is memorized in Preset 6 of the crossover mode.
Profile	Data is set to the opening display.
Calendar message	Data is set to the calendar message.

The file name of download data shall be "A_U*****.MP3."

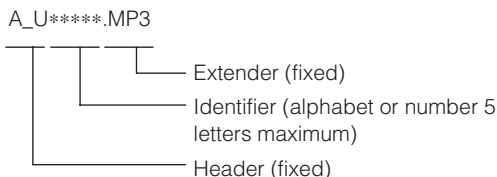

You can create a file name via the website. Do not change a file name once it has been created. Malfunction may result.

- For downloading procedure details, see Alpine's website.
- If the HDA-5460 model is connected to this unit, the HDA-5460 hard disc can be used. Data that has been stored in the hard disc is downloaded by the "Data Downloading" operation to DVA-9965E. For details on how to download data to the hard disc, refer to the Owner's Manual of the HDA-5460 model.
- If an external audio processor is connected, data that is downloaded cannot be used.

Data Downloading

- 1 Insert the CD-R disc containing the data. If the source is not the DISC mode, press SOURCE/POWER to change to DISC mode.**
- 2 Press MENU.**
- 3 Select the Data Download mode by sliding your finger on the GlideTouch bar to the left or right. Press the GlideTouch bar under the Data Download mode.**
- 4 Select Download by pressing the GlideTouch bar under Download.**

Data search of the disc starts and the first file name is displayed.

 - If you want to cancel the data search, press the GlideTouch bar under CANCEL.*
 - If a file is not found by a data search, "NO FILE" is indicated.*
 - The "NO FILE" display will automatically disappear if no operation is performed for 5 seconds.*
- 5 Select the file to download by sliding your finger on the GlideTouch bar to the left or right. Press the GlideTouch bar under the desired file.**

Data downloading starts.

- 6 When data download is finished successfully, the confirmation screen is displayed, and download finishes.**

Successfully downloaded items are indicated as checked boxes on the confirmation screen.

PARAMETRIC EQ or GRAPHIC EQ data

The data is memorized in Preset 6 of Parametric EQ mode or Graphic EQ mode. The memorized data settings in Preset 6 (Parametric EQ mode or Graphic EQ mode) are automatically applied.

X-OVER (Crossover) data

The data is memorized in Preset 6 of X-OVER mode. The memorized data settings in Preset 6 (X-OVER mode) are automatically applied.

You cannot download the data if the setting of the 2WAY/3WAY switch is not suitable for the data.

TIME CORRECTION data

The data is memorized in Preset 6 of the Time correction mode. The memorized data settings in Preset 6 (Time Correction mode) are automatically applied.

- * If the downloaded parametric EQ or graphic EQ differs from the current EQ mode, Preset 6 setting will not change automatically. Change the EQ mode and recall Preset 6.
- * If data is downloaded while setting DEFEAT to ON, Preset 6 setting will not change automatically. Recall Preset 6 in the EQ mode.

- 7 Press and hold MENU for at least 2 seconds to return to normal mode.**

- When you download the data again, the data is overwritten in Preset 6.*
- If MENU is pressed while adjusting or setting the items in the MENU mode, the unit returns to the previous selection screen.*
- By pressing the GlideTouch bar under RETURN in the MENU mode, the unit will return to the normal mode.*

Downloading the Wallpaper

A data file downloaded from the Alpine Owner's website is written to a CD-R/CD-RW disc, and automatically uploaded when the disc is inserted into the DVA-9965E.

The wallpaper file can be saved and displayed as long as a disc is not inserted, or while playing a CD/MP3/WMA audio, or if a DVD disc is stopped.

- If several files are stored in a disc, only the first file will be stored on the unit.*

Insert a CD-R/CD-RW disc containing data.

After sensing the disc, the data file is updated.

- Up to 2 files can be stored on this unit. If a third file is downloaded, the first file is overwritten and new one memorized.*
- To change the wallpaper, press and hold ENT, on the remote control unit for at least 2 seconds while disc is not inserted, or while PRE-STOP or STOP is set in disc mode.*
- Even if the battery power cable is removed, the downloaded data is not cleared.*

DVD Setup

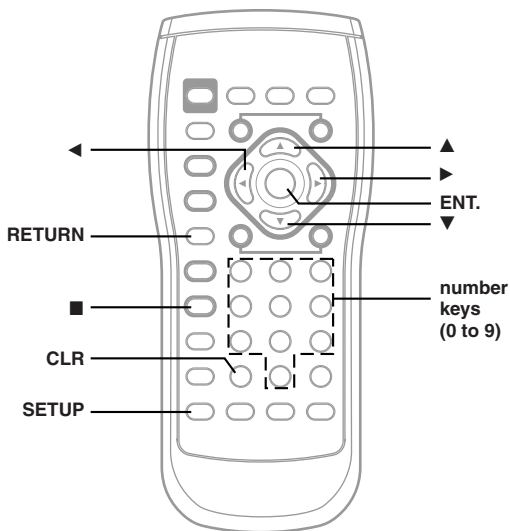

Setting the language

The audio language, subtitle language and menu language can be set according to your preferences. Once set, this becomes the default language. This function is convenient when you always want to listen in English. (Not all discs allow changing the default language. If not, the factory default language applies.)

Setting item: LANGUAGES

Further setting items: AUDIO / SUBTITLE / MENU

AUDIO:

Set the audio track language.

SUBTITLE:

Set the language of the subtitles displayed on the screen.

MENU:

Set the language used for the menus (title menu, etc.).

■ SETUP	
LANGUAGES	
AUDIO	AUTO
SUBTITLE	AUTO
MENU	AUTO

Setting contents:

AUTO*1 / **ENGLISH** / **JAPANESE** / **GERMAN** / **SPANISH** / **FRENCH** / **ITALIAN** / **PORTUGUESE** / **RUSSIAN** / **CHINESE** / **OTHER***2

Press ▲, ▼, ◀ or ▶ to select your desired language, then press ENT.

*1 AUTO:

The disc is played with the audio language or subtitle language set as the priority language for the disc.

*2 OTHER:

Set this to play the disc with a language other than one of the languages displayed. Press ENT. then use the number keys "0" to "9" to input the 4-digit language code. Then press ENT. again. For the language codes, refer to "List of Language Codes" (page 55).

DVD Setup Operation

- DVD Setup Operation is performed by the remote control unit.

The following 4 steps are common to each of the DVD settings. Refer to the specific section for details.

1 Press **SETUP** before inserting a disc, or when in stop mode.

The setup menu appears on the monitor.

■ SETUP	
LANGUAGES	
TV SCREEN	16:9 (WIDE)
COUNTRY CODE	AU-6585
PARENTAL	OFF
DIGITAL OUT	
CUSTOM SETUP	

2 Press ▲ or ▼ to select your desired setting item, then press **ENT.**

Further items will be displayed.

Setting items:

LANGUAGES / TV SCREEN / COUNTRY CODE / PARENTAL / DIGITAL OUT / CUSTOM SETUP*1

*1 Refer to "Custom Setup" on page 36.

3 Press ▲, ▼, ◀ or ▶ to change the setting, then press **ENT.**

4 Press **RETURN** repeatedly until the **SETUP** mode is deactivated.

- When settings are changed, old settings are overwritten. Make a note of the current settings before making changes. If the vehicle's battery is disconnected, the settings will be cleared and will return to the factory settings.

- If you change the language setting when the disc is inside, the setting is decided with one of the following operations.
 - Turn OFF the main unit.
 - Switch the source on the head unit.
- To temporarily change the language of the current disc, either do so from the DVD menu or using the operation described in the section "Switching the Audio Tracks" (page 18).
- If the disc does not include the selected language, the disc's default language is set.
- Languages set upon shipment from the factory:
 - Audio language : AUTO
 - Subtitle language : AUTO
 - Menu language : AUTO
- Press **RETURN** to return to the previous display.

Continued

Setting the TV Screen

Use the procedure described below to set the output screen according to the type of TV monitor being used.

Setting item: TV SCREEN

Setting contents: 16:9 (WIDE) / 4:3 (LB) / 4:3 (PS)

- For some discs, the picture may not be set to the selected screen size. (For details, refer to the explanation on the disc's jacket.)
- Press **RETURN** to return to the previous screen.

16:9 (WIDE)

Select this when connected to a wide screen TV. This is selected upon shipment from the factory.



4:3 LB (LETTER BOX)

Select this when connected to a conventional 4:3 size (normal TV aspect ratio) monitor. There may be black bands visible at the top and bottom of the screen (when playing a 16:9 size movie). The width of these stripes will depend upon the original aspect ratio of the theatre release of the movie.



4:3 PS (PAN-SCAN)

Select this when connected to a conventional 4:3 size monitor. The picture will fill the entire TV screen. However, due to the mismatch in aspect ratio, parts of the movie at the extreme left and right sides will not be visible (when playing a 16:9 size movie).



Setting the Country Code

Set the country code of which you want to set the parental level (Parental lock).

Setting item: COUNTRY CODE

Setting contents: CODE

- Press **▲** or **▼** to select "COUNTRY CODE," then press **ENT**.
"COUNTRY CODE" will be reset.

COUNTRY CODE - - - -

- Use the number keys "0" to "9" to input the 4-digit country code, then press **ENT**.
Example: AU "6585" is input

COUNTRY CODE 6 5 8 5

- For the country codes, refer to "List of Country Codes" (page 56 to 57).
- Each time you press **CLR** one digit is erased. Press **CLR** for at least 2 seconds to delete all digits.
- Press **RETURN** to return to the previous screen.

Setting the Rating Level (Parental Lock)

Use this function to restrict the viewing of movies to children of appropriate age levels only.

Setting item: PARENTAL

Setting contents: PASSWORD

- Press **▲** or **▼** to select "PARENTAL," then press **ENT**.
The password input mode is activated.
- Use the number keys "0" to "9" to input the 4-digit password, then press **ENT**.

PASSWORD * * * *

Input numbers are displayed as "*".

The default password is 1111 upon shipment from the factory.

The restriction level (PARENTAL LEVEL) input display appears.

- Each time you press **CLR** one digit is erased. Press **CLR** for at least 2 seconds to delete all digits.
 - Press **RETURN** to return to the previous screen.
- Press **▲**, **▼**, **◀** or **▶** to select the restriction level (1 to 8), then press **ENT**.

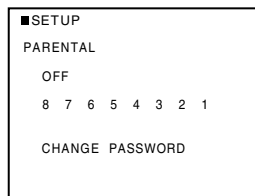

Select "OFF" to cancel the parental lock or if you do not want to set a rating level.

The lower the number, the higher the rating level.

- Press **RETURN** to return to the previous display.
- Press **RETURN** repeatedly until the SETUP mode is deactivated.
- If you want to change the password, select "CHANGE PASSWORD," then input the new password (4 digits).
 - Write down the password on a piece of paper and store the paper somewhere in case you forget it.
 - On unrated DVDs, playback will not be restricted even if the rating level is set.
 - Once set, this rating level remains in memory until changed. To enable the play of discs of higher rating levels or to cancel the parental lock, the setting must be changed.
 - Not all DVDs provide a Parental Lock feature. If you are unsure about a DVD, play it first to confirm. Do not leave DVDs accessible to young children for whom you deem them inappropriate.

Tips

- Changing the rating level temporarily**
Some discs may request that you change the rating level set in the default settings during playback. In this case, the message appears on the monitor screen "PARENTAL LEVEL CHANGE OK?"
- To change parental level and play, press ENT.**
The password input mode is displayed. Input the 4-digit password you set in "Setting the Rating Level (Parental Lock)", then press **ENT**.
- To play without changing the parental level, press ■.**
(When **■** is pressed, playback will be at the parental level set with "Setting the Rating Level (Parental Lock).")

Setting the Digital Output

Use the following procedure to set the digital audio signal output from the DVA-9965E.

Setting item: DIGITAL OUT

Further setting items: DOLBY D / DTS / MPEG

Press ▲ or ▼ to select your desired setting item, then press ENT.

DOLBY D: Sets Dolby Digital output.
The initial setting is LPCM.

DTS: Sets DTS output.
The initial setting is LPCM.

MPEG: Sets MPEG audio output by converting 48 kHz/16 bit linear PCM (DVD) or 44.1 kHz (Video CD, CD).
The initial setting is LPCM.

Setting contents: BITSTREAM / LPCM

Press ▲ or ▼ to select BITSTREAM or LPCM, then press ENT.

BITSTREAM: The digital output is switched automatically according to the type of audio signal being played.
Be sure to select "BITSTREAM" when you want to connect a digital audio processor and play Dolby Digital audio. "BITSTREAM" is selected upon shipment from the factory.

LPCM: The audio signal recorded on the disc is converted to 48 kHz/16 bit (for DVDs) or 44.1 kHz (for video CDs and CDs) linear PCM audio signals for output.

- If "BITSTREAM" is set when an external audio processor is not connected, no sound is output. Set "LPCM".
- Press **RETURN** to return to the previous screen.

Audio output/Optical digital audio output

Disc	Audio recording format		Digital output setting	Optical digital audio output (when a digital audio processor is connected)	Analog audio output (RCA output)
DVD	DTS		BITSTREAM	DTS Elementary Stream	OK
			LPCM	LPCM Encode 2ch Down mix (44.1kHz or 48kHz/16bit)	OK
	Dolby Digital		BITSTREAM	Dolby Digital	OK
			LPCM	LPCM (48kHz/16bit)	OK
	Linear PCM	48kHz/16bit	BITSTREAM or LPCM	LPCM (48kHz/16bit)	OK
		48kHz/20bit	BITSTREAM or LPCM	LPCM (48kHz/16bit)	OK
		48kHz/24bit	BITSTREAM or LPCM	LPCM (48kHz/16bit)	OK
		96kHz/16bit	BITSTREAM or LPCM	LPCM (48kHz/16bit)	OK
		96kHz/20bit	BITSTREAM or LPCM	LPCM (48kHz/16bit)	OK
		96kHz/24bit	BITSTREAM or LPCM	LPCM (48kHz/16bit)	OK
MPEG2		BITSTREAM or LPCM	LPCM (44.1kHz or 48kHz/16bit)	OK	
Video CD	MPEG1		BITSTREAM or LPCM	LPCM (44.1kHz)	OK
CD	Linear PCM		BITSTREAM or LPCM	LPCM (44.1kHz)	OK
	DTS		BITSTREAM	DTS Elementary Stream	OK
LPCM			LPCM Encode 2ch Down mix (44.1kHz/16bit)	OK	
MP3	MPEG-1 Audio Layer3 Bit Rate: 32kbps-320kbps	32kHz/16bit	BITSTREAM or LPCM	LPCM Encode 2ch (32kHz/16bit)	OK
		44.1kHz/16bit	BITSTREAM or LPCM	LPCM Encode 2ch (44.1kHz/16bit)	OK
		48kHz/16bit	BITSTREAM or LPCM	LPCM Encode 2ch (48kHz/16bit)	OK
WMA	Windows Media™ Audio Bit Rate: 32kbps-320kbps	32kHz/16bit	BITSTREAM or LPCM	LPCM Encode 2ch (32kHz/16bit)	OK
		44.1kHz/16bit	BITSTREAM or LPCM	LPCM Encode 2ch (44.1kHz/16bit)	OK
		48kHz/16bit	BITSTREAM or LPCM	LPCM Encode 2ch (48kHz/16bit)	OK

Custom Setup

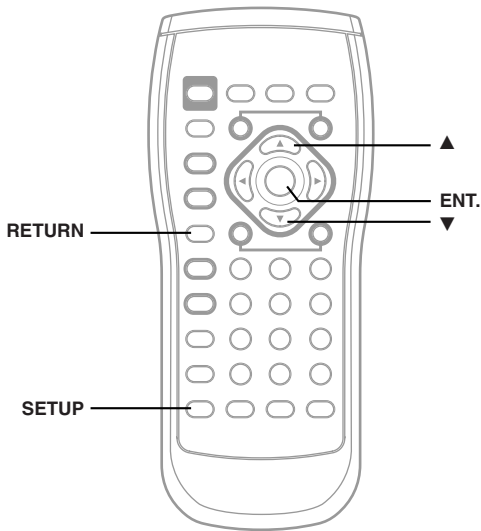

Custom Setup Operation

- Custom Setup Operation is performed by the remote control unit.

The following 5 steps are common to each of the Custom Setup settings. Refer to the specific section for details.

1 Press **SETUP** before inserting a disc, or when in stop mode.

The setup menu appears on the monitor.

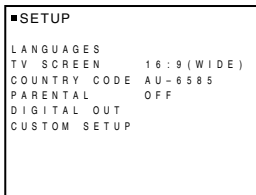

2 Press **▲** or **▼** to select "CUSTOM SETUP", then press **ENT.**

3 Press **▲** or **▼** to select your desired setting item, then press **ENT.**

CUSTOM SETUP items:

CD PLAY MODE / VCD PLAY MODE / PAUSE MODE /
DOWNMIX MODE

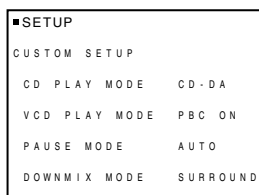

4 Press **▲** or **▼** to change the setting, then press **ENT.**

5 Press **RETURN** repeatedly until the **SETUP** mode is deactivated.

- When settings are changed, old settings are overwritten. Make a note of the current settings before making changes. If the vehicle's battery is disconnected, the settings will be cleared and will return to the factory settings.

Setting the CD Play Mode

The unit can be set to play only the audio data or only the MP3/WMA files on discs containing both audio data and MP3/WMA data.

Setting item: CD PLAY MODE

Setting contents: CD-DA / COMPRESSED AUDIO

CD-DA: Only CD data can be played back.

COMPRESSED AUDIO: Only MP3/WMA data can be played back.

The initial setting at the factory is CD-DA.

- If a disc has already been inserted, perform the setting after you remove the disc.
- The setting cannot be carried out if an MP3 compatible changer is used.

Setting the Video CD Play Mode

When playing a Playback Control (PBC) enabled video CD, you can choose to set PBC ON or OFF.

Setting item: VCD PLAY MODE

Setting contents: PBC ON / PBC OFF

PBC ON: The PBC menu is displayed.

PBC OFF: The PBC menu is not displayed.

The initial setting at the factory is PBC ON.

Setting the Pause Mode

In pause mode, screen blurring may occur. To overcome this, set AUTO/FIELD/FRAME accordingly.

Setting item: PAUSE MODE

Setting contents: AUTO / FIELD / FRAME

If you experience blurring during pause mode, set to FIELD or FRAME.

The initial setting at the factory is AUTO.

Setting the Downmix Mode

This function applies to Dolby Digital, DTS stream sound.

Setting item: DOWNMIX MODE

Setting contents: STEREO / SURROUND ENCODED

STEREO: Stereo Downmix

SURROUND ENCODED: Dolby surround compatible Downmix

The initial setting at the factory is SURROUND ENCODED.

SETUP

You can flexibly customize the unit to suit your own preferences and usage. Choose the SETUP menu from General Setting, Tuner Setting, etc., to select your desired setting.

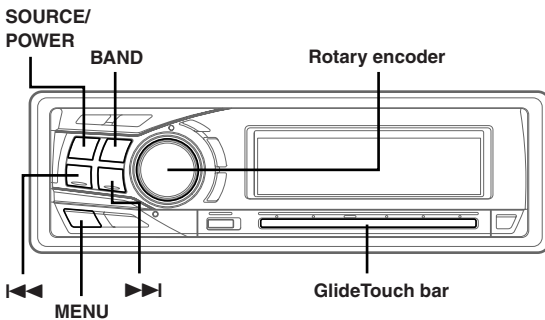

Setup Operation

The following 4 steps are common to each of the Setup functions. Refer to the specific section for details.

- 1 Press MENU.**
- 2 Select Setup by sliding your finger on the GlideTouch bar to the left or right. Press the GlideTouch bar under Setup.**
The main SETUP menu is displayed.
- 3 Select the desired item by sliding your finger on the GlideTouch bar to the left or right. Press the GlideTouch bar under your selection.**
GENERAL ↔ TUNER ↔ AUDIO ↔ DISP (DISPLAY) ↔ DEMO
The SETUP menu of the selected item is displayed.
- 4 Select the desired item by sliding your finger on the GlideTouch bar to the left or right. Press the GlideTouch bar under your selection.**

Setting items:

GENERAL

CLOCK MODE ↔ CLOCK ADJUST*¹ ↔ PLAY MODE*² ↔ BEEP ↔ SOUND GUIDE ↔ INT MUTE ↔ INT AUDIO ↔ AUX IN ↔ (AUX NAME)*² ↔ OPTICAL OUT*³ ↔ AP SELECT*⁴ ↔ CLOCK MODE

AUDIO

SUBWOOFER ↔ EQ MODE*⁵ ↔ TW SETUP*⁶ ↔ SUBWOOFER

DISPLAY

DIMMER ↔ DIMMER LEVEL ↔ DISPLAY COLOR ↔ TEXT SCROLL ↔ SCROLL TYPE ↔ FONT SELECT ↔ A-LINK TEMP*⁷ ↔ BGV SELECT ↔ OPENING MSG ↔ CALENDAR ↔ T.CORR*⁸ ↔ DIMMER

DEMO

DEMO

- Although the TUNER Setup icon appears on the display, it is not available on this unit.

- *¹ Refer to "Setting the Time and Calendar" (page 8).
- *² Displayed only when AUX is ON.
- *³ Refer to "Setting User's EQ mode" (page 21).
- *⁴ Displayed only when the 2WAY/3WAY switch (pages 65, 66 and 68) is set to 3WAY.
This function cannot be selected when an external audio processor is connected.
- *⁵ "A-LINK TEMP" is displayed when an Amplifier Link compatible external amplifier is connected.
- *⁶ Refer to "Setting the Time Correction Unit" (page 26).
- *⁷ Displayed when an Alpine external audio processor is not connected.
- *⁸ Displayed when an Alpine external audio processor is connected.
- *⁹ Displayed when STOP is set with a disc inserted in the unit, or when a disc is not inserted.

5 Change the parameter by pressing the GlideTouch bar under the desired setting.

6 After setting, press and hold MENU for at least 2 seconds to return to normal mode.

- If MENU is pressed while adjusting or setting the items in the MENU mode, the unit returns to the previous selection screen.
- By pressing the GlideTouch bar under RETURN in the MENU mode, the unit will return to the normal mode.
- If no operation is performed for 60 seconds, the unit will return to the normal mode.

General Setting

General is selected on the setup main menu in step 3.

Setting the Clock display

Setting item: **CLOCK MODE**

Setting contents: **AM12:00 (12-hour (Initial setting) / 00:00 (24-hour))**

You can select the clock display type, 12-hour or 24-hour, depending on your preference.

Playing MP3/WMA Data

Setting item: **PLAY MODE**

Setting contents: **CD-DA (Initial setting) / MP3/WMA**

This product can playback CDs containing both CD and MP3/WMA data. However, in some situations (some enhanced CDs), playback may be difficult. For these special cases, you can select playback of CD data only. You can set for MP3/WMA playback only.

CD-DA :	Only CD data can be played back.
MP3/WMA :	Only MP3/WMA file tracks can be played back.

- Perform this setting before inserting a disc. If a disc has already been inserted, perform the setting after you remove the disc.
- The setting cannot be carried out if an MP3 compatible changer is used.

Sound (Beep) Guide Function

Setting item: **BEEP**

Setting contents: **ON (Initial setting) / OFF**

This function will give audible feedback with varying tones depending upon the button pressed.

Changing the Sound (Beep) Guide Pattern

Setting item: **SOUND GUIDE**

Setting contents: **TYPE1 (Initial setting) / TYPE2 / TYPE3**

Press this button to choose between 3 types of operation sounds.

- If you do not want the operational beep sounds, set "Sound (Beep) Guide Function" (this page) to OFF.

Turning Mute Mode On/Off

Setting item:INT MUTE

Setting contents:ON (Initial setting) / OFF

If a device having the interrupt feature is connected, audio will be automatically muted whenever the interrupt signal is received from the device.

Setting Tone Defeat for External Devices

Setting item:INT AUDIO

Setting contents:ON / OFF (Initial setting)

When inputting external devices to this unit, turning tone defeat on will bypass EQ and MX, i.e., sound for external devices is output at the default setting.

Setting the AUX Mode (V-Link)

Setting item:AUX IN

Setting contents:ON / OFF (Initial setting)

You can input TV/video sound by connecting an optional Ai-NET/ RCA Interface cable (KCA-121B) or Versatile Link Terminal (KCA-410C) to this component.

You can change the AUX name display when AUX ON is set. Select the AUX name by sliding your finger on the **GlideTouch bar** to the left or right. Then press the **GlideTouch bar**.

If the KCA-410C is connected, it is possible to select two AUX names.

- Via KCA-410C, up to 2 external devices with RCA output can be connected. In this case, press **SOURCE/POWER** to select AUX mode and then press **BAND** to select your desired device.

Setting the Digital Output

Setting item:OPTICAL OUT

Setting contents:ON / OFF (Initial setting)

To connect an optical digital compatible audio processor other than Alpine, the optical digital output must be set to ON.

- After input selection is completed, turn the ignition off and back on again. The digital output is set.

Setting the Digital Audio Processor

Setting item:AP SELECT

Setting contents:H510 / OTHERS (Initial setting)

According to the type of Ai-NET compatible digital audio processor you are connecting, connect and change the setting as follows:

H510 : When connecting the PXA-H510, select the H510, using the optical digital input connection to the DVD.

OTHERS : When connecting other than the PXA-H510, select OTHERS, and connect the optical digital input terminal to the head unit.

- After input selection is completed, turn the ignition off and back on again. Setting of the optical digital input switch is completed.

Audio Setting

Audio is selected on the setup main menu in step 3.

Subwoofer On and Off

Setting item: SUBWOOFER

Setting contents:ON (Initial setting) / OFF

When the subwoofer is on, perform the steps below to adjust the subwoofer output phase and level.

- 1 Press the **Rotary encoder** repeatedly to select the SUBWOOFER mode.
SUBWOOFER → BALANCE → FADER → DEFEAT → VOLUME → SUBWOOFER
- If you set the 2WAY/3WAY switch (pages 65, 66 and 68) to 3WAY, you cannot adjust the FADER mode.
- 2 Press **◀◀** or **▶▶**.
The subwoofer output phase is toggled SUBWOOFER NORMAL (0°) or SUBWOOFER REVERS (180°).
To adjust the level, turn the **Rotary encoder**.

Setting the Response Slope for the High Range Speaker

Setting item: TW SETUP

Setting contents:MAKER'S (Initial setting) / USER'S

Depending on the response characteristics of the speaker, care should be taken when setting the response slope of the high range speaker to FLAT in 3-way mode (see "Adjusting and Storing the Crossover Settings" on page 24), as speaker damage may result.

MAKER'S : As protection from possible speaker damage, FLAT cannot be set for the response slope of the high range speaker in 3-way mode.

USER'S : The FLAT setting is possible in 3-way mode.

- A message is displayed when the response slope for the high range speaker is set to FLAT in 3-way mode.

Display Setting

The display is selected on the setup main menu in step 3.

Dimmer Control

Setting item:DIMMER

Setting contents:AUTO (Initial setting) / MANUAL

- AUTO:** When the headlights are turned on, the display decreases the illumination, and the brightness level which is set in "Setting the Display Dimmer" (this page) is set.
- MANUAL:** Regardless of the headlights being on or off, the display decreases the illumination, and the brightness level which is set in "Setting the Display Dimmer" (this page) is set.

Setting the Display Dimmer

Setting item:DIMMER LEVEL

Setting contents:Level1 / Level2 (Initial setting) / Level3

In the display Dimmer AUTO setting, three levels are available, the lowest level (LEVEL 1) being the brightest when the car headlights are on.

Changing the Display Colour

Setting item:DISPLAY COLOR

Setting contents:OFF (Initial setting) / AUTO

You can change the display colour of the unit.

- OFF :** Displayed in full colour.
- AUTO :** The character colour, etc., is changed according to the setting in "Setting the Multicolour Illumination" (page 30).

Scroll Setting

Setting item:TEXT SCROLL

Setting contents:AUTO / MANUAL (Initial setting)

This CD player can scroll the disc and track names recorded on CD-TEXT discs, as well as the text information of MP3/WMA files, folder names, and tags.

- AUTO :** The CD text information, the text information of folder and file names, and the tags are scrolled automatically.
- MANUAL :** The display is scrolled when a disc is loaded or when a track is changed, etc.
- *The unit scrolls CD text names, folder names, file names or tag display.*
 - *Even when the scroll setting is set to MANUAL with the DVA-9965E while displaying ARTIST NAME/ALBUM NAME, the text information scrolls continuously.*

Scroll Type Setting

Setting item:SCROLL TYPE

Setting contents:TYPE1 (Initial setting) / TYPE2

Two types of scroll can be selected.
You can select the scroll type you like.

Switching the Character Font

Setting item:FONT SELECT

Setting contents:TYPE1 (Initial setting) / TYPE2

Two types of font can be selected.
You can select the font type you like.

Setting the Temperature Display for the External Amplifier

Setting item:A-LINK TEMP

Setting contents:A-LINK TEMP °F / A-LINK TEMP °C (Initial setting)

When a separately sold Amplifier Link compatible amplifier is connected, you can set how to display its temperature. You can switch the setting between Fahrenheit and Celsius.

- °F : The temperature is displayed in Fahrenheit.
°C : The temperature is displayed in Celsius.

Switching the Animation Display Type

Setting item:BGV SELECT

Setting contents:OFF / TYPE1 (initial setting) / TYPE2 / TYPE3 / TYPE4

You have a choice of 4 different background animation displays.

Opening Message ON/OFF Setting

Setting item:OPENING MSG

Setting contents:ON / OFF (Initial setting)

You can select whether the opening display is shown or not when power is turned ON. Choose between the standard display pattern and the downloaded Profile data display pattern.
This function is only available if you have already downloaded the profile data.

- OFF mode :** This shows the standard display pattern.
ON mode : This shows the downloaded Profile data and the calendar message after data downloading.

Setting of Calendar Display Pattern Switching

Setting item:CALENDAR

Setting contents:dd/mm/yyyy / yyyy/mm/dd (Initial setting)

You can switch the calendar display pattern to be shown when the time is displayed.

- yyyy : shows the year
mm : shows the month
dd : shows the day
ex. dd/mm/yyyy → 25/12/2005

Demo Setting

Demo is selected on the setup main menu in step 3.

Demonstration

Setting item:DEMO

Setting contents:ON / OFF (Initial setting)

This unit has a Demonstration feature for the display and sound.

- *To quit Demo mode, set to DEMO OFF.*

iPod™ Operation (Optional)

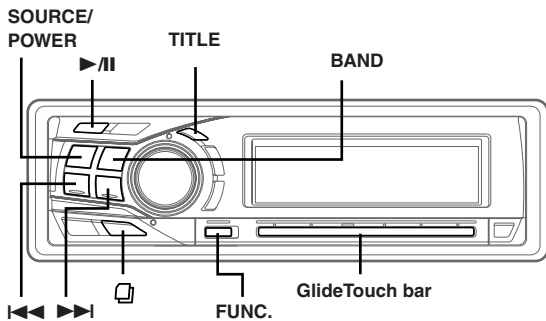

When an iPod™ or iPod™ mini is connected to the optional Alpine Interface adapter for iPod™ (KCA-420i), it can be controlled from the DVA-9965E. However, operation from the iPod is disabled.

- For details, refer to the Owner's Manual of the iPod™ Interface adapter (KCA-420i).
- Refer to the iPod's documentation for a description of its functions.

Playback

1 Press SOURCE/POWER to switch to the iPod mode.

2 Press I◀◀ or ▶▶I to select the desired song.

Return to the beginning of the current song:

Press I◀◀.

Fast backward:

Press and hold I◀◀.

Advance to the beginning of the next song:

Press ▶▶I.

Fast forward:

Press and hold ▶▶I.

3 To pause playback, press ▶/II.
Pressing ▶/II again will resume playback.

- If a song is playing on the iPod when it is connected to the DVA-9965E, it will continue playing after the connection.
- If using the iPod with a changer, the Versatile Link Terminal (KCA-410C) must be used. In this case, press **BAND** to select the changer mode applicable to the iPod.
- With the DVA-9965E, you can return to the beginning of the current track, fast forward/fast reverse and playback/pause. The source operation mode is selected by touching the **GlideTouch bar** under **FUNC.** in the function guide display.

Searching for a desired Song

An iPod can contain hundreds of songs. By keeping these songs organized in playlists, the DVA-9965E can use these to ease song searches.

- When *Shuffle (M.I.X.)* is on, the search function cannot be used.

Searching by Playlist

- 1 Press**
- 2 Select Playlist Search** by sliding your finger on the **GlideTouch bar** to the left or right. Press the **GlideTouch bar** under **Playlist Search**.
- ^{*1} **3 Within 10 seconds, select the playlist** by sliding your finger on the **GlideTouch bar** to the left or right.
- 4 Within 10 seconds, press ▶/II to play back a selected playlist.**

To search for a song in the selected playlist

- 1 After selecting the playlist in step 3^{*1}, press the **GlideTouch bar** or **FUNC.** to change to the song search mode of the selected playlist.
 - 2 Within 10 seconds, select a song by sliding your finger on the **GlideTouch bar** to the left or right, then pressing ▶/II or the **GlideTouch bar**.
The selected song is played back.
- If you choose "iPod name" of iPod in step 3^{*1} and you press ▶/II, all songs in iPod are played back.
 - The search mode is cancelled by pressing and holding for at least 2 seconds in the search mode.
 - The playlist can be scrolled continuously by touching and holding either side of the **GlideTouch bar**.

Searching by artist name

- 1 Press** .
- 2 Select Artist Search** by sliding your finger on the **GlideTouch bar** to the left or right. Press the **GlideTouch bar** under **Artist Search**.
- ^{*2} **3 Within 10 seconds, select the artist to be played back** by sliding your finger on the **GlideTouch bar** to the left or right.
- 4 Within 10 seconds, press ▶/II to play back all songs of the selected artist.**

To search for an album of the selected artist

- 1 After selecting the artist in step 3^{*2}, press the **GlideTouch bar** or **FUNC.** to change to the album search mode of the selected artist.
- 2^{*3} Within 10 seconds, select the album to be played back by sliding your finger on the **GlideTouch bar** to the left or right.
- 3 Press ▶/II to play back all songs of the selected album.

To search for a song of the selected album

- 1 After selecting the album in step 2^{*3}, press the **GlideTouch bar** or **FUNC.** to change to the song search mode of the selected album.
 - 2 Within 10 seconds, select a song by sliding your finger on the **GlideTouch bar** to the left or right, then pressing **▶/||** or the **GlideTouch bar**.
The selected song is played back.
- If you choose **ALL** in step 3^{*2}, and you press **▶/||**, all songs in iPod are played back. If you choose **ALL**, and you press the **GlideTouch bar** or **FUNC.**, the **ALBUM** search mode for all artists is activated.
 - If you choose **ALL** in step 2^{*3}, and you press **▶/||**, all songs of the selected artist are played back. If you choose **ALL**, and you press the **GlideTouch bar** or **FUNC.**, the **SONG** search mode for the selected artist is activated.
 - The search mode is cancelled by pressing and holding **□** for at least 2 seconds in the search mode.
 - The artist, album or song can be scrolled continuously by touching and holding either side of the **GlideTouch bar**.

Searching by album name

- 1 Press **□**.
- 2 Select **Album Search** by sliding your finger on the **GlideTouch bar** to the left or right. Press the **GlideTouch bar** under **Album Search**.
- 3^{*4} Within 10 seconds, select the album to be played back by sliding your finger on the **GlideTouch bar** to the left or right.
- 4 Within 10 seconds, press **▶/||** to play back all songs of the selected album.

To search for a song of the selected album

- 1 After selecting the album in step 3^{*4}, press the **GlideTouch bar** or **FUNC.** to change to the song search mode of the selected album.
 - 2 Within 10 seconds, select a song by sliding your finger on the **GlideTouch bar** to the left or right, then pressing **▶/||** or the **GlideTouch bar**.
The selected song is played back.
- If you choose **ALL** in step 3^{*4}, and you press **▶/||**, the search mode is cancelled. If you choose **ALL**, and you press the **GlideTouch bar** or **FUNC.**, the **SONG** search mode for all albums is activated.
 - The search mode is cancelled by pressing and holding **□** for at least 2 seconds in the search mode.
 - The album or song can be scrolled continuously by touching and holding either side of the **GlideTouch bar**.

Quick Search

You can search for songs.

- 1 Press and hold **□** for at least 2 seconds to activate the quick search mode.
 - 2 Select the desired song by sliding your finger on the **GlideTouch bar** to the left or right.
The selected song is played back immediately.
- The search mode is cancelled by pressing and holding **□** for at least 2 seconds in the search mode.
 - The songs can be scrolled continuously by touching and holding either side of the **GlideTouch bar**.
 - "Quick Search" is displayed during Quick search.

Random Play Shuffle (M.I.X.)

The Shuffle function of the iPod is displayed as M.I.X. on the DVA-9965E.

Shuffle Albums (M.I.X. ALBUM):

Select an album randomly in the iPod, and plays back the songs of the album in sequential order. If a song has been selected in the playlist/artist search mode before selecting Shuffle Album, only the albums within the playlist/artist are selected randomly. The songs of the album are played back sequentially.

Shuffle Songs (M.I.X. ALL ON):

All songs in the iPod are played back in random sequence. If a song has been selected in the playlist/artist search mode before selecting Shuffle song, only the songs of the playlist/artist/album are played back randomly.

- 1 Press **FUNC.** to activate the audio function mode.

Source select mode → Audio function mode →
Source operation mode → Source select mode

- 2 Press the **GlideTouch bar** under the **M.I.X.** function in the function guide display.

The songs will be played back in random sequence.

→ M.I.X. **□** → M.I.X. **⊙** → (off)
(Shuffle Albums) (Shuffle Songs)

The Random Play mode is cancelled by selecting off.

- The function mode you previously recalled can be recalled again if the **GlideTouch bar** is touched.
- If no operation is performed for 10 seconds, the audio function mode turns off.
- For details of the search mode, refer to "Searching for a desired Song" (page 40).
- If a song is selected in the album search mode before selecting Shuffle (M.I.X.), the songs will not play back randomly even when Shuffle album is selected.
- If there is no album in the playlist, Shuffle (M.I.X.) will not function even when Shuffle album is selected.

Repeat Play

Only Repeat One is available for the iPod.

Repeat One: A single song is repeatedly played back.

1 Press **FUNC.** to activate the audio function mode.

Source select mode → Audio function mode →
Source operation mode → Source select mode

2 Press the **GlideTouch** bar under the RPT function in the function guide display.

The song will be played back repeatedly.

RPT ↔ (off)
(Repeat One)

The RPT mode is cancelled by selecting off.

- The function mode you previously recalled can be recalled again if the **GlideTouch bar** is touched.
- If no operation is performed for 10 seconds, the audio function mode turns off.
- During repeat playback, no other songs are selectable by pressing **◀◀** or **▶▶**.

Displaying the Text

You can display the tag information of a song in the iPod.

Press **TITLE.**

Each press changes the display.

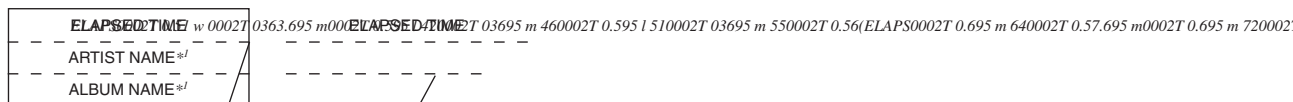

*1 "NO DATA" is displayed if there is no information.

*2 Only when an external Amplifier Link compatible amplifier is connected. For details, refer to "Displaying the External Amplifier Information" (page 30).

- When the Scroll Setting (page 39) is set to "MANUAL," press and hold **TITLE** for at least 2 seconds to scroll the tag information only once.
- Only alphanumeric characters can be displayed.
- When the artist name, album name or song name is set on iTunes, and the amount of characters is increased, songs may not be played back when connected to the adapter. Therefore, a maximum of 250 characters is recommended. The maximum number of characters for the head unit is 64.
- Some characters may not be correctly displayed.
- "NO SUPPORT" is displayed when text information is not compatible with the DVA-9965E.
- Playlist name cannot be displayed.

Playing MP3 Files with the CD Changer (Optional)

If you connect a changer compatible with MP3, you can play CD-ROMs, CD-Rs, and CD-RWs containing MP3 files on this unit.

- 1 Press **SOURCE/POWER** to switch to the MP3 Changer mode.
- 2 Press **FUNC.** to activate the direct disc recall mode.
Source selection mode ↔ Audio function mode ↔
Direct disc recall mode ↔ Source operation mode ↔
Source selection mode
- 3 After activating the direct disc recall mode in step 2, select a disc (1 to 6) by touching the **GlideTouch bar** and sliding your finger to the left or right.
Press the **GlideTouch bar** under the desired disc.

- 4 To pause playback, press **▶/II**.

Pressing **▶/II** again will resume playback.

- The unit can play discs containing both audio data and MP3 data.
- For operating MP3 with an MP3 compatible CD Changer, refer to "CD/MP3/WMA" pages 11 to 15.

Multi-Changer Selection (Optional)

Alpine's Ai-NET system will support up to 6 CD Changers. When operating two or more changers, the KCA-400C (Multi-Changer Switching device) must be used. If you use 1 Switching device, you can connect up to 4 CD Changers. If you use 2 Switching devices, you can connect up to 6 CD Changers. When using KCA-410C (Versatile Link Terminal), you can connect two changers and two external outputs (AUX).

- 1 Press **SOURCE/POWER** on this unit to activate the CD Changer mode.
- 2 Press **BAND** to activate the CD Changer Selection mode.
The CD Changer Selection mode remains active for a few seconds.
- 3 Press **BAND** until the desired CD Changer indicator appears on the display.

- If the selected CD Changer is not connected, the display will show "NO CHANGER."
- To operate the selected changer, see "CD/MP3/WMA" (page 11).
- For further details about the external input (AUX) when using KCA-410C, see "Setting the AUX Mode (V-Link)" on page 38.

External Audio Processor (Optional)

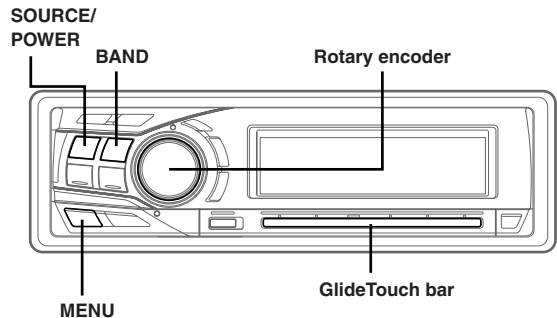

When an external audio processor is connected to this unit, you can operate it from this unit. Some audio processors may not be operated. When PXA-H510 or PXA-H900 is connected, some of the operations may not be performed from this unit. In this case, operate them in the connected product. Explanations below is the case when PXA-H700 or PXA-H701 is connected for example. Refer also to the operating instructions of the connected audio processor.

- The adjustments or settings performed on the connected audio processor cannot be operated properly from this unit.
- The setting "Setting the Speakers", "Setting Bass Sound Control", and "Graphic Equalizer Adjustments" are not available if the MRA-D550 is connected. Additionally, if the MRA-F350 is connected, the following setting "Setting the MX mode" is not available. Also, the setting content differs between the PXA-H700 and PXA-H701.
- The unit has no Bass Focus function.
- If no operation is performed for approximately 15 seconds when setting the external audio processor, the A.PROC mode is cancelled, and the normal mode returns.

Adjustment Procedure for Dolby Surround

Make the adjustments described below in order to reproduce Dolby Digital and DTS sound with greater accuracy.

Adjustment procedure

- 1 **Speaker Setup (page 47)**
(Turning the speakers to be used on and off and setting their response)
- 2 **Adjusting the speaker levels (page 48)**
(Adjusting the signal output level to the various speakers)
- 3 **Mixing bass sound to the rear channel (page 48)**
(Achieving smooth sound in the rear seat by mixing the front audio signals with the rear speaker signals)
- 4 **Adjusting the acoustic image (page 49)**
(Adjusting the acoustic image to achieve a sound as if the centre speaker were directly in front of the listener)
- 5 **Achieving powerful high volume sound (page 49)**
(Achieving energetic sound with even greater power, like the sound in a movie theatre)
- 6 **Adjusting the DVD Level (page 49)**
(Adjust the volume (signal level) in the Dolby Digital, Pro Logic II, DTS and PCM modes.)
- 7 **Storing settings in the Memory (page 51)**
(Storing all the settings and adjustments made on the DVA-9965E (not only the above settings/adjusts) in the memory)

In case of combining the Automatic adjustments etc.

We recommend to make the Automatic adjustments before the Dolby Surround adjustments.

Setting the Speakers

- 1 Check that Defeat mode is off (page 20).
- 2 Press and hold **MENU** for at least 2 seconds.
- 3 Select the Speaker Select mode by sliding your finger on the **GlideTouch bar** to the left or right. Press the **GlideTouch bar** under the Speaker Select mode.
- 4 Touch the **GlideTouch bar** and select the speaker by sliding it to the left or right, then press the **GlideTouch bar**.
- 5 Touch the **GlideTouch bar**, and select any speaker (ON/OFF) by sliding it to the left or right, then press the **GlideTouch bar**.

FRONT1: OFF/TW (Tweeter)/FULL (Full Range)*
FRONT2: OFF/ON
REAR: OFF/ON
CENTER: OFF/ON
SUBWOOFER: OFF/MONO/STEREO

* Displayed when "USER'S" is set in "Setting the Reponse Slope for the High Range Speaker" (page 38).

- 6 To adjust another speaker, return to the previous display by pressing **MENU** and repeat step 5.
- 7 When the setting is complete, press and hold **MENU** for at least 2 seconds.

- Set the speaker which is not connected to OFF.
- Settings above can be carried out even when the speaker is set to OFF in "Speaker Setup" (page 47).
- To use the subwoofer in MONO with PXA-H700 or PXA-H701 connected, connect the subwoofer to the subwoofer output terminal of PXA-H700 or PXA-H701.

Set MX Mode of the External Audio Processor

Before performing the operations below, set MX (Media Xpander) mode of the PXA-H700 to "AUTO" when the PXA-H700 is connected.

- 1 Check that Defeat mode is off (page 20).
- 2 Press **MENU**.
- 3 Select the Media Xpander mode by sliding your finger on the **GlideTouch bar** to the left or right. Press the **GlideTouch bar** under the Media Xpander mode.
- 4 Press the **GlideTouch bar** under ON to activate MX.
- 5 After setting, press and hold **MENU** for at least 2 seconds to return to normal mode.
- 6 Press **SOURCE/POWER** to select the source to which you want to apply MX (Media Xpander).
- 7 Press and hold **MENU** for at least 2 seconds.

8 Select the Media Xpander mode by sliding your finger on the **GlideTouch bar** to the left or right. Press the **GlideTouch bar** under the Media Xpander mode.

9 Select the MX Level by sliding your finger on the **GlideTouch bar** to the left or right. Press the **GlideTouch bar** under the desired level or OFF (Non Effect).

FM (MX level 1 to 3):

The medium to high frequencies become clearer, and produces well balanced sound at all frequencies.

CD (MX level 1 to 3):

CD mode processes a large amount of data during playback. MX takes advantage of this large data quantity to reproduce a more clear, clean output.

CMPM (MX level 1 to 3):

This corrects information that was lost at the time of compression. This reproduces a well-balanced sound close to the original.

DVD (Video CD)

(MOVIE MX level 1 to 2):

The dialogue portion of a video is reproduced more clearly.

(DVD MUSIC):

A DVD or Video CD contains a large quantity of data such as music clip. MX uses this data to reproduce the sound accurately.

AUX (MX level 1):

Choose the MX mode (CMPM, MOVIE, or MUSIC) that corresponds to the media connected. If two external devices are connected, a different MX mode for each media can be selected.

10 After setting, press and hold **MENU** for at least 2 seconds to return to normal mode.

- The contents of MX set here is reflected to PXA-H700 or PXA-H701.
- When OFF is selected, MX effect of each MX mode will be OFF.
- Each music source, such as radio, CD, and MP3 can have its own MX setting.
- MX mode does not function when MX is ON for AM radio.
- MX COMPRESS MEDIA is applied for MP3/WMA, MMD and iPod.
- If no operation is performed for 15 seconds, the unit will return to the normal mode.

X-OVER Adjustment

1 Check that Defeat mode is off (page 20).

2 Press and hold **MENU** for at least 2 seconds.

3 Select the Crossover (X-OVER) mode by sliding your finger on the **GlideTouch bar** to the left or right. Press the **GlideTouch bar** under the Crossover (X-OVER) mode.

4 Select L+R or L/R by pressing and holding **BAND** for at least 2 seconds.

L+R: Sets the same adjustment values for the left and right channels.

L/R: Different adjustment values can be set for the left and right channels.

5 Select the desired channel by pressing **BAND**.

6 Touch the **GlideTouch bar**, and select the desired cut-off frequency (Crossover Point) by sliding it to the left or right, then press the **GlideTouch bar**.

7 Press **SOURCE/POWER** to adjust the slope.

8 Turn the **Rotary encoder** to adjust the output level.

9 To adjust other channels, repeat steps 5 to 8.

10 When the setting is complete, press and hold **MENU** for at least 2 seconds.

- When the speaker is set to the "OFF" mode, the X-OVER for that speaker cannot be set. Refer to "Setting the Speakers" (page 44).
- Check the playback frequencies of the connected speakers before adjusting.
- In order to protect the speakers, there is no OFF setting for the subwoofer low pass filter (the slope remains the same).
- The H.P.F. filter cannot be set to OFF (slope OFF) if Tweeter is selected for FRONT1. Or, only the subwoofer is adjustable if STEREO is selected for the subwoofer.
- When the setting is complete, it is recommended to store the setting contents. For storing, refer to page 51.

Performing Time Correction Manually (TCR)/Phase Switching

Because of the particular conditions inside the vehicle, there can be major differences in the distances between the various speakers and the listening position. It is possible to calculate the optimum correction values and eliminate the time error at the listening position yourself using this function.

Calculating the Time Correction

1 Sit in the listening position (the driver's seat, for example) and measure the distance (in meters) between your head and the various speakers.

2 Calculate the difference in distance between the farthest speaker and the other speakers.

$$L = (\text{distance of farthest speaker}) - (\text{distance of other speakers})$$

3 Divide the distances calculated for the different speakers by the speed of sound (343 m/s temperature 20°C).

This value is the time correction value for the various speakers.

Concrete examples

Calculating the time correction value for the front left speaker on the diagram below.

Conditions:

Distance between farthest speaker and listening position:
2.25 m (88-3/4")

Distance between front left speaker and listening position:
0.5 m (20")

Calculation:

$$L = 2.25 \text{ m (88-3/4")} - 0.5 \text{ m (20")} = 1.75 \text{ m (68-3/4")}$$
$$\text{Compensation time} = 1.75 \div 343 \times 1000 = 5.1 \text{ (ms)}$$

In other words, setting the time correction value for the front left speaker to 5.1 (ms) sets a virtual distance matching the distance to the farthest speaker.

Continued

45-EN

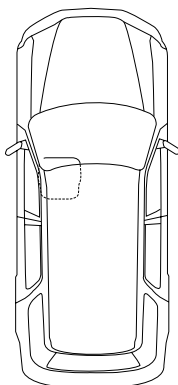

Graphic Equalizer Adjustments

The graphic equalizer allows you to modify the sound using 31 bands each for the front (left and right), rear (left and right) and centre speakers. An additional 10 bands are available for the subwoofer. This allows you to customize the sound to suit your taste.

- 1** Check that **Defeat mode is off** (page 20) and **G.EQ is selected in “Setting User’s EQ mode”** (page 21).
- 2** Press and hold **MENU** for at least 2 seconds.
- 3** Select the **Graphic EQ mode** by sliding your finger on the **GlideTouch bar** to the left or right. Press the **GlideTouch bar** under the **Graphic EQ mode**.
- 4** Select **L+R** or **L/R** by pressing and holding **BAND** for at least 2 seconds.
 - L+R: Sets the same adjustment values for the left and right channels.
 - L/R: Different adjustment values can be set for the left and right channels.

When parametric EQ is adjusted, this setting will be turned off.
- 5** Select the **channel** by sliding your finger on the **GlideTouch bar** to the left or right. Press the **GlideTouch bar** under the **channel**.
- 6** Select the **desired band** by pressing **BAND**.
- 7** Adjust the level by turning the **Rotary encoder**.
- 8** To adjust other bands, repeat steps 6 to 7.
- 9** When the setting is complete, press and hold **MENU** for at least 2 seconds.

- When the speaker is set to the “OFF” mode, the graphic equalizer for that speaker cannot be set. Refer to “Setting the Speakers” (page 44).
- Check the playable frequency ranges of the connected speakers before making the equalizer adjustments. If the speaker’s playable frequency range is 55 Hz to 30 kHz, for example, adjusting the 40 Hz or 20 Hz band has no effect. Additionally, you may overload and damage the speakers.
- When graphic EQ is adjusted, the adjustment for parametric EQ becomes ineffective.
- When the setting is complete, it is recommended to store the setting contents. For storing, refer to page 51.

Parametric Equalizer Adjustments

The frequency bands of the graphic equalizer are fixed. This makes it very difficult to correct for undesired peaks and dips at specific frequencies. The parametric equalizer's centre frequency can be tuned to these specific frequencies. Then, the bandwidth (Q) and level are fine-tuned, independently, to make the necessary corrections. The parametric equalizer function is an advanced tool for serious audiophiles.

- 1 Check that **Defeat mode** is off (page 20) and **P.EQ** is selected in "Setting User's EQ mode" (page 21).
- 2 Press and hold **MENU** for at least 2 seconds.
- 3 Select the **Parametric EQ** mode by sliding your finger on the **GlideTouch bar** to the left or right. Press the **GlideTouch bar** under the **Parametric EQ** mode.
- 4 Select **L+R** or **L/R** by pressing and holding **BAND** for at least 2 seconds.

L+R: Sets the same adjustment values for the left and right channels.
L/R: Different adjustment values can be set for the left and right channels.

When graphic EQ is adjusted, this setting will be turned off.
- 5 Select the desired channel by sliding your finger on the **GlideTouch bar** to the left or right. The channel changes by pressing the **GlideTouch bar**.
- 6 Press **BAND** to select the band.
- 7 Select the frequency by sliding your finger on the **GlideTouch bar** to the left or right. Press the **GlideTouch bar** under the frequency.
- 8 Press **SOURCE/POWER** to set the band width (Q).
- 9 Adjust the level by turning the **Rotary encoder**.
- 10 To adjust other bands, repeat steps 6 to 9.
- 11 When the setting is complete, press and hold **MENU** for at least 2 seconds.

- When the speaker is set to the "OFF" mode, the parametric equalizer for that speaker cannot be set. Refer to "Setting the Speakers" (page 44).
- It is not possible to adjust the frequencies of adjacent bands within 7 steps.
- Check the playable frequency ranges of the connected speakers before making the equalizer adjustments. If the speaker's playable frequency range is 55 Hz to 30 kHz, for example, adjusting the 40 Hz or 20 Hz band has no effect. Additionally, you may overload and damage the speakers.
- When the parametric EQ is adjusted, the adjustment for graphic EQ becomes ineffective.
- When the setting is complete, it is recommended to store the setting contents. For storing, refer to page 51.

Setting Bass Compressor

You can adjust the sound of low frequencies as desired.

- 1 Check that **Defeat mode** is off (page 20).
- 2 Press and hold **MENU** for at least 2 seconds.
- 3 Select the **BASS COMP.** mode by sliding your finger on the **GlideTouch bar** to the left or right. Press the **GlideTouch bar** under the **BASS COMP.** mode.
- 4 Touch the **GlideTouch bar**, and select the desired mode by sliding your finger to the left or right, then press the **GlideTouch bar**.
Bass sound is emphasized more as the mode is sequentially switched as **MODE1** → 2 → 3, offering you vivid low frequencies.
Select **OFF** when the setting is not necessary.
- 5 When the setting is complete, press and hold **MENU** for at least 2 seconds.

Speaker Setup

The PXA-H700 or PXA-H701 can be set according to the playable frequency range of your speakers.

Check the playable frequency range of the speakers (not including the subwoofer) before performing this operation to verify whether the speakers can play low frequencies (of about 80 Hz or less).

- Avoid stopping, pausing, switching the disc, cueing, fast-forwarding or switching the audio channel of this unit while making this adjustment. The setting is cancelled if **Decode mode** is switched.

- 1 Check that **Defeat mode** is off (page 20).
- 2 Press and hold **MENU** for at least 2 seconds.
- 3 Select the **Speaker Setup** mode by sliding your finger on the **GlideTouch bar** to the left or right. Press the **GlideTouch bar** under the **Speaker Setup** mode.
- 4 Touch the **GlideTouch bar**, and select the speaker by sliding your finger to the left or right, then press the **GlideTouch bar**.
- 5 Select the speaker characteristic by sliding your finger on the **GlideTouch bar** to the left or right. Press the **GlideTouch bar** under the speaker characteristic.

OFF*1: When no speaker is connected.

SMALL: When a speaker that cannot play low frequencies (80 Hz or less) is connected.

LARGE*2: When a speaker that can play low frequencies (80 Hz or less) is connected.

*1 It is not possible to set the front speakers to "OFF".

*2 If the front speakers are set to "SMALL", the rear and centre speakers cannot be set to "LARGE".

Continued

47-EN

6 When the setting is complete, press and hold **MENU** for at least 2 seconds.

- The subwoofer can be set only to ON/OFF.
- If the centre speaker is turned "OFF", the centre channel's audio signals are added to the audio signals output from the front speakers.
- If you set the speaker response to "OFF", also set the speaker setting to "OFF" (page 44)
- Perform the setup for all the speakers ("Front," "Center," "Rear" and "Subwoofer"). If not, the sound may not be balanced.
- When centre is set to "OFF", the setting is ineffective even if centre is set with this function.
- Through changing the settings on each speaker, a change in the output of the other speakers may occur due to the setting requirements.
- When using the PRO LOGIC II, if the rear speaker is set to "LARGE", then there will be no output from the subwoofer.
- When the setting is complete, it is recommended to store the setting contents. For storing, refer to page 51.

Setting of Dolby Digital

Adjusting the speaker levels (OUTPUT LEVEL)

The test tones help to make the volume adjustments of the different speakers. When levels are equal, a strong sense of presence can be heard from the different speakers at the listening position.

- Avoid stopping, pausing, switching the disc, cueing, fast-forwarding or switching the audio channel of this unit while making this adjustment. The setting is cancelled if the decode mode is switched.

1 Check that Defeat mode is off (page 20).

2 Press and hold **MENU** for at least 2 seconds.

3 Select the Multi CH Setup mode by sliding your finger on the **GlideTouch** bar to the left or right. Press the **GlideTouch** bar under the Multi CH Setup mode.

4 Select OUTPUT LEVEL by sliding your finger on the **GlideTouch** bar to the left or right. Press the **GlideTouch** bar under the OUTPUT LEVEL mode. The test tone is reproduced by each speaker automatically.

5 Adjust the output level by turning the **Rotary encoder** to balance the volume of each speaker.

- The adjustment range for the different speakers is -10 dB - +10 dB.
- Adjust based on the front speakers.

6 When the setting is complete, press and hold **MENU** for at least 2 seconds.

- If a speaker is set to off mode, that speaker's level adjustment cannot be made. Refer to "Speaker Setup" (page 47).
- When the setting is complete, it is recommended to store the setting contents. For storing, refer to page 51.
- While adjusting the speaker, it cannot be switched.

Mixing bass sound to the rear channel (REAR MIX)

This function mixes the front channel audio signals to the audio signals output from the rear speakers, improving the sound in the vehicle's rear seat.

- Avoid stopping, pausing, switching the disc, cueing, fast-forwarding or switching the audio channel of this unit while making this adjustment. The setting is cancelled if the Decode mode is switched.

1 Check that Defeat mode is off (page 20).

2 Press and hold **MENU** for at least 2 seconds.

3 Select the Multi CH Setup mode by sliding your finger on the **GlideTouch** bar to the left or right. Press the **GlideTouch** bar under the Multi CH Setup mode.

4 Select the REAR MIX mode by sliding your finger on the **GlideTouch** bar to the left or right. Press the **GlideTouch** bar under the REAR MIX mode.

5 Select the REAR MIX ON/OFF by sliding your finger on the **GlideTouch** bar to the left or right. Press the **GlideTouch** bar under the REAR MIX ON/OFF. If ON is set, the audio signal which is output from the rear speaker is mixed to the front audio signal.

6 Adjust the level by turning and then pressing the **Rotary encoder**.

The level can adjusted in five steps: -6, -3, 0, +3 and +6. The higher the level, the more bass is output from the rear speakers. (The effect differs according to the software (DVD, etc..))

7 When the setting is complete, press and hold **MENU** for at least 2 seconds.

- This adjustment is ineffective when the rear speaker setup setting is set to "OFF"
- For linear PCM signals, the voice is output from the rear speaker regardless of the REAR FILL and REAR MIX setting.
- When the setting is complete, it is recommended to store the setting contents. For storing, refer to page 51.

Adjusting the acoustic image (BI-PHANTOM)

In most installations, the centre speaker must be placed directly between the front passenger and driver. Using this function, the centre channel information is distributed to the left and right speakers. This creates an acoustic image simulating a centre speaker directly in front of each listener. Adjusting the centre width in PL II MUSIC (see "Using the Pro Logic II Mode," page 50), makes this function ineffective.

- Avoid stopping, pausing, switching the disc, cueing, fast-forwarding or switching the audio channel of this unit while making this adjustment. The setting is cancelled if the Decode mode is switched.

- 1 Check that Defeat mode is off (page 20).
 - 2 Press and hold **MENU** for at least 2 seconds.
 - 3 Select the Multi CH Setup mode by sliding your finger on the **GlideTouch bar** to the left or right. Press the **GlideTouch bar** under the Multi CH Setup mode.
 - 4 Select the BI-PHANTOM mode by sliding your finger on the **GlideTouch bar** to the left or right. Press the **GlideTouch bar** under the BI-PHANTOM mode.
 - 5 Select the BI-PHANTOM ON/OFF by sliding your finger on the **GlideTouch bar** to the left or right. Press the **GlideTouch bar** under the BI-PHANTOM ON/OFF.
- If ON is set, the soundstage created is as if you are positioned directly in front of the centre speaker by distributing the centre speaker sound left and right.
- 6 Adjust the level by turning and then pressing the **Rotary encoder**.
The level can be adjusted within the range of -5 to +5. The higher the level, the more the position of the centre speaker is shifted to the sides.
 - 7 When the setting is complete, press and hold **MENU** for at least 2 seconds.

- This adjustment is effective when the setting of the centre speaker to **SMALL** or **LARGE** in the speaker setup settings.
- This adjustment is ineffective when the speaker is set to **CENTER OFF** in "Setting the Speakers" (page 44).
- When the setting is complete, it is recommended to store the setting contents. For storing, refer to page 51.

Achieving powerful high volume sound (LISTENING)

With Dolby Digital, the dynamic range is compressed so that powerful sound can be achieved at regular volume levels. This compression can be cancelled to achieve an energetic sound with even greater power, like the sound in a movie theatre. This function works only in the Dolby Digital mode.

- 1 Check that Defeat mode is off (page 20).
 - 2 Press and hold **MENU** for at least 2 seconds.
 - 3 Select the Multi CH Setup mode by sliding your finger on the **GlideTouch bar** to the left or right. Press the **GlideTouch bar** under the Multi CH Setup mode.
 - 4 Select the LISTEN MODE by sliding your finger on the **GlideTouch bar** to the left or right. Press the **GlideTouch bar** under the LISTEN MODE.
 - 5 Select the STD (Standard) or MAX (Maximum) by sliding your finger on the **GlideTouch bar** to the left or right. Press the **GlideTouch bar** under the STD or MAX.
- STD: For powerful sound at regular volume levels
MAX: For powerful sound at high volumes
- 6 When the setting is complete, press and hold **MENU** for at least 2 seconds.

- Keep the volume to a level at which sounds outside the vehicle can still be heard.
- When the setting is complete, it is recommended to store the setting contents. For storing, refer to page 51.

Adjusting the DVD Level

The volume (signal level) for Dolby Digital, Dolby PL II, DTS and PCM modes can be set.

- Avoid stopping, pausing, switching the disc, cueing, fast-forwarding or switching the audio channel of this unit while making this adjustment. The setting is cancelled if the Decode mode is switched.

- 1 Check that Defeat mode is off (page 20).
- 2 Press and hold **MENU** for at least 2 seconds.
- 3 Select the DVD Level mode by sliding your finger on the **GlideTouch bar** to the left or right. Press the **GlideTouch bar** under the DVD Level mode.
- 4 Press the **GlideTouch bar** to the left or right to select the mode (DOLBY DIGITAL, DOLBY PLII, DTS, PCM) to be adjusted.
- 5 Adjust the level by turning the **Rotary encoder**.
The level can be adjusted in the range of -5 to +5.
- 6 When the other mode level is adjusted, press **MENU** to return to the previous display, then repeat steps 4 and 5.
- 7 When the setting is complete, press and hold **MENU** for at least 2 seconds.

- When the setting is complete, it is recommended to store the setting contents. For storing, refer to page 51.

Using the Pro Logic II Mode

Pro Logic processing can be conducted on the music signals recorded on two channels to achieve Dolby Pro Logic II surround sound. For two-channel Dolby Digital and DTS signals, there is also a "REAR FILL" function for outputting the signals of the front channel to the rear channel.

- 1 Check that Defeat mode is off (page 20).
- 2 Press and hold **MENU** for at least 2 seconds.
- 3 Select the Dolby PL II mode by sliding your finger on the **GlideTouch** bar to the left or right. Press the **GlideTouch** bar under the Dolby PL II mode. The DOLBY PL II setup mode is activated.
- 4 Select the **DOLBY PL II** by sliding your finger on the **GlideTouch** bar to the left or right, then press the **GlideTouch** bar.
- 5 Select the desired mode by sliding your finger on the **GlideTouch** bar to the left or right. Press the **GlideTouch** bar under the desired mode.

PL II MOVIE:

Suits the stereo TV shows and all programs encoded in Dolby Surround. It improves the sound field directivity to near that of discrete 5.1-channel sound.

PL II MUSIC:

Can be used for all stereo music recordings, and provides a wide, deep sound field.

PL II FILL:

Depending on the input signals, the sound may only be output from the front speakers. In this case, the "REAR FILL" function can be used to output signals from the rear speakers as well.

OFF: Turns DOLBY PL II function to OFF.

If PL II MUSIC is selected, the centre width can be adjusted with the following operations.

This function offers the optimum vocal position by adjusting the centre channel position between the centre speaker and the L/R speaker. (The adjustments established in "Adjusting the acoustic image" (page 49) are ineffective while this function is activated.)

Selecting the CENTER WIDTH CONT.

- 1) Select CENTER WIDTH by activating the DOLBY PL II setup mode in step 4 of "Using the Prologic II Mode."
- 2) Select ON or OFF by sliding your finger on the **GlideTouch** bar to the left or right. Press the **GlideTouch** bar under the ON or OFF.
If ON is set, you can enjoy the optimum vocal position by distributing the centre channel sound between the centre speaker and L/R speaker.
- 3) Adjust the level by turning the **Rotary** encoder.

The level can be adjusted between 0 to 7. When the level increases, the centre channel position moves from the centre speaker position to both sides.

- 6 When the setting is complete, press and hold **MENU** for at least 2 seconds.

- This adjustment is effective when the setting of the centre speaker is **SMALL** or **LARGE** in the speaker setup settings.
- Avoid stopping, pausing, switching the disc, cueing, fast-forwarding or switching the audio channel of this unit while making this adjustment. The setting is cancelled if the Decode mode is switched.
- This adjustment is ineffective when the speaker is set to **CENTER OFF** in "Setting the Speakers" (page 44).
- This function only works with two-channel signals. This operation is ineffective when 5.1-channel DTS or Dolby Digital signals are input.
- If the **REAR FILL** setting is made while **REAR MIX** is ON, the sound for rear fill is unchanged. **REAR MIX** is given priority during all 2 channel decoding other than linear PCM.
- For linear PCM signals, the voice is output from the rear speaker regardless of the **REAR FILL** and **REAR MIX** setting.
- When the setting is complete, it is recommended to store the setting contents. For storing, refer to page 51.

Linear PCM Setting

The output when playing discs recorded in linear PCM can be set to 2 or 3 channels.

- 1 Check that Defeat mode is off (page 20).
- 2 Press and hold **MENU** for at least 2 seconds.
- 3 Select the DVD Level mode by sliding your finger on the **GlideTouch** bar to the left or right. Press the **GlideTouch** bar under the DVD Level mode.
- 4 Select the **PCM MODE** by sliding your finger on the **GlideTouch** bar to the left or right. Press the **GlideTouch** bar under the **PCM MODE**.
- 5 Select the desired mode by sliding your finger on the **GlideTouch** bar to the left or right. Press the **GlideTouch** bar under the desired mode.

2CH OUTPUT : 2ch output (L/R)

3CH OUTPUT : 3ch output (L/R/CENTER)

- 6 When the setting is complete, press and hold **MENU** for at least 2 seconds.

- This adjustment is ineffective when the speaker is set to **CENTER OFF** in "Setting the Speakers" (page 44).

Storing Settings in the Memory

Up to 6 settings can be stored on the unit.

All settings and adjustments described below are stored in one memory preset.

Setting/adjusting items	Refer to page
Setting the Speakers	44
Setting Time Correction/Switching Phase	45, 46
Adjusting EQ	46, 47
Adjusting X-OVER	45
Setting MX	44, 45
Setting BASS COMP.	47
Setting PRO LOGIC II/Adjusting the Centre Width*	50
Adjusting Dolby Surround*	48, 49
Linear PCM Setting*	50

* Depending on the input signal, sound effect may not be obtained.

- 1 Press **MENU**.
- 2 Touch the **GlideTouch bar**, select AP Preset Mode by sliding it to the left or right, then press **GlideTouch bar**.
- 3 Touch the **GlideTouch bar**, select the preset number (1 through 6) by sliding it to the left or right, then press and hold the **GlideTouch bar** for at least 2 seconds to store the adjusted contents.

- This function is operable only when Defeat is set to OFF.
- The stored contents will not be deleted even when battery power cord is detached.

Getting out the Preset Memory

- 1 Check that Defeat mode is off (page 20).
- 2 Press **MENU**.
- 3 Touch the **GlideTouch bar**, select AP Preset mode by sliding it to the left or right, then press the **GlideTouch bar**.
- 4 Touch the **GlideTouch bar**, and select a preset number (1 through 6) you wish to recall by sliding it to the left or right, then press the **GlideTouch bar**.

- It takes a few moment to get out the preset memory.

Remote Control

Controls on Remote Control

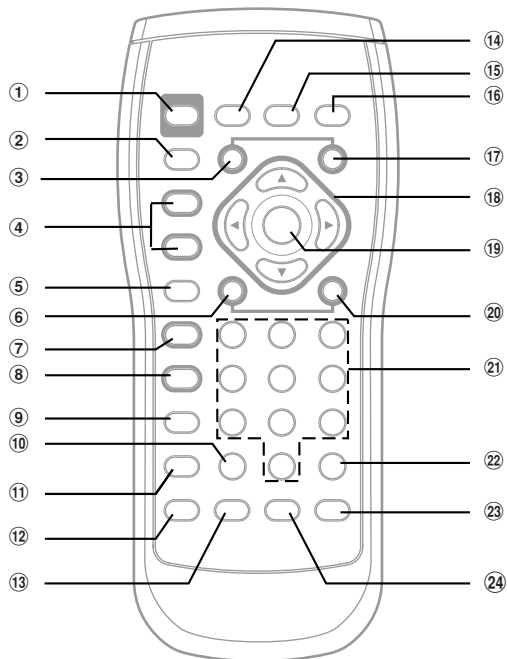

- ① **PWR Button**
Turns the power ON and OFF.
- ② **SRC Button**
Selects the audio source.
- ③ **DN Button**
Radio mode: Selects, in descending order, stations programmed into the radio's presets.
MP3/WMA mode: Folder Select (DN) Button selects the folder.
Changer mode: DISC Select (DN) Button selects a disc in descending order.
- ④ **VOLUME ▲ / ▼ Button**
Increase or decreases the volume level.
- ⑤ **RETURN Button**
DVD/Video CD (PBC ON) mode: Returns to the previous display. (Does not return in some discs.)
- ⑥ **◀◀ Button**
Radio mode: SEEK (DN) button
CD/Changer mode:
Press the button to go back to the beginning of the current track. Press and hold to fast reverse.
MP3/WMA mode:
Press the button to go back to the beginning of the current file. Press and hold to fast reverse.
DVD/Video CD:
 - Move to the desired position on the disc.
 - During playback, press and hold for more than 1 second to reverse the disc at double speed. Hold for more than 5 seconds to reverse the disc at 8 times the normal speed.

Continued
51-EN

DVD/Video CD:

- Move to the desired position on the disc.
- During playback, press and hold for more than 1 second to forward the disc at double speed. Hold for more than 5 seconds to forward the disc at 8 times the normal speed.
- When pressed and held in while in the pause mode, the disc is played in slow motion at 1/8th the normal speed. When held in for 5 more seconds, the slow motion speed switches to 1/2 the normal speed.
- The picture is forwarded by one frame each time the button is pressed in the pause mode.

⑳ **Numeric Keypad**

Inputs numbers.

㉑ **MONITOR Button**

Switches the input mode of the connected monitor (sold separately)

㉒ **ANGLE Button**

DVD mode: Switches the angle of the picture.

㉓ **SUBTITLE button**

DVD mode: Switches the subtitle.

- *If you use a Remote Control other than the supplied one, some operations may not be performed.*

When Using the Remote Control

- **Point the remote control at the remote sensor within about 2 meters.**
- **It may not be possible to operate the remote control if the remote control sensor is exposed to direct sunlight.**
- **The remote control is a small, lightweight precision device. To avoid damage, short battery life, operational errors and poor response, observe the following.**
 - **Do not subject the remote control to excessive shock.**
 - **Do not put in a trouser pocket.**
 - **Keep away from food, moisture and dirt.**
 - **Do not place in direct sunshine.**

Battery Replacement

Battery type: CR2025 battery or equivalent.

1 Opening the battery case

Slide out the battery cover while firmly pressing in the direction of the arrow.

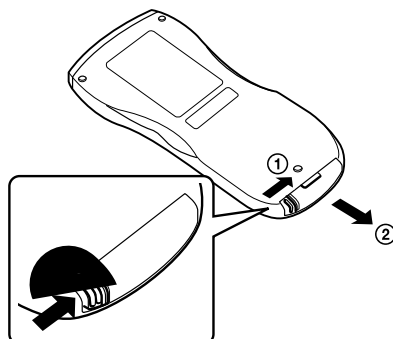

2 Replacing the battery

Put the battery in the case with the (+) indication upward as shown in the illustration.

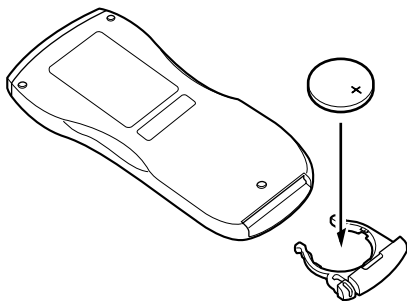

- *Placing a battery in backwards way may cause a malfunction.*

3 Closing the cover

Slide the cover as illustrated until a click is heard.

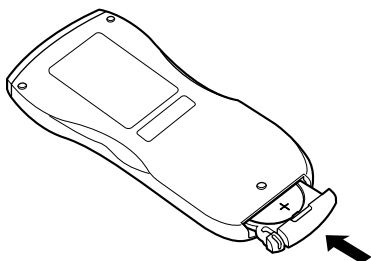

Warning

DO NOT OPERATE ANY FUNCTION THAT TAKES YOUR ATTENTION AWAY FROM SAFELY DRIVING YOUR VEHICLE.

Any function that requires your prolonged attention should only be performed after coming to a complete stop. Always stop the vehicle in a safe location before performing these functions. Failure to do so may result in an accident.

Controllable With Remote Control

Point the optional remote control transmitter at the remote control sensor.

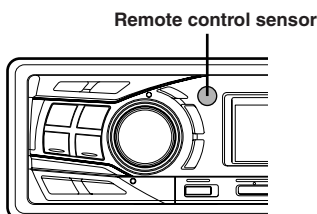

Connectable to Remote Control Interface Box

You can operate this unit from the vehicle's control unit when an Alpine Remote Control Interface Box (optional) is connected. For details, contact your Alpine dealer.

Information

About DVDs

Music CDs and DVDs have grooves (tracks) in which the digital data is recorded. The data is represented as microscopic pits recorded into the track – these pits are read by a laser beam to play the disc. On DVDs, the density of the tracks and pits is twice that of CDs, so DVDs can contain more data in less space.

CDs

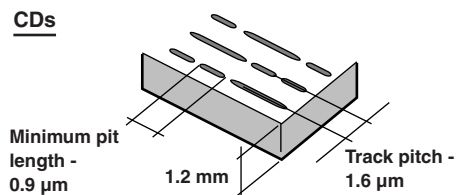

DVDs

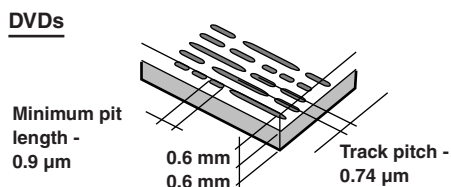

A 12 cm disc can contain one movie or about four hours of music. In addition, DVDs provide sharp picture quality with vivid colours thanks to a horizontal resolution of over 500 lines (compared to less than 300 for VHS tape). With the addition of an optional, digital audio processor (PXA-H510, PXA-H900, PXA-H701 etc.), you can recreate the power and presence of a movie theatre with Dolby Digital 5.1-channel Surround.

In addition, DVDs offer a variety of functions.

- **Multiple audio*** (page 18)
Movies can be recorded in up to eight languages. The desired language can be selected from the remote control.
- **Subtitles function*** (page 19)
Movies can include subtitles in up to 32 languages. The desired subtitle language can be selected from the remote control.
- **Multi angle function*** (page 18)
When the DVD contains a movie shot from multiple angles, the desired angle can be selected from the remote control.
- **Multi story function***
With this function, a single movie includes various story lines. You can select different story lines to view various versions of the same movie. Operation differs from disc to disc. Story line selection screens including instructions appear during the movie. Just follow the instructions.

* *The functions, audio languages, subtitle languages, angles, etc., differ from disc to disc. For details, refer to the disc's instructions.*

Terminology

Dolby Digital

Dolby Digital is a digital audio compression technology developed by Dolby Laboratories that allows large quantities of audio data to be efficiently recorded on discs. It is compatible with audio signals from mono (1 channel) all the way up to 5.1-channel surround sound. The signals for the different channels are completely independent, and since the sound is high quality digital there is no loss of sound quality.

* *The separately sold digital audio processor (PXA-H510, PXA-H900, PXA-H701 etc.) is required to enjoy full 5.1-channel surround sound.*

The DVA-9965E performs Dolby Digital decoding when it outputs analog audio signals; 2-channel audio, not 5.1-channel.

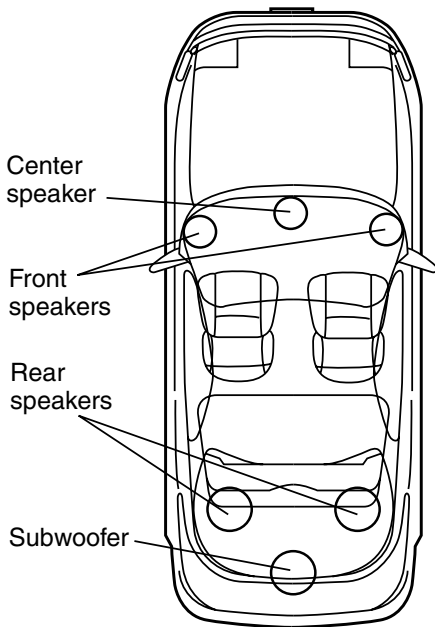

Speaker layout for enjoying Dolby Digital sound/dts sound

DTS

This is a home-use digital sound format of the DTS Sound System. This is a high quality sound system, developed by Digital Theater Systems, Inc. for use in movie theatres. DTS has six independent sound tracks. The theatre presentation is fully realized in the home, etc. DTS is the abbreviation for Digital Theater System.

* *To enjoy DTS surround sound you need the separately sold DTS digital audio processor (PXA-H900, PXA-H701 etc.). The DVD video software must also have a DTS sound track.*

The DVA-9965E has a built-in DTS 2-channel audio decoder. Analog audio outputs are available.

Dolby Pro Logic

Dolby Pro Logic is the technology used to decode programs encoded in Dolby Surround. Pro logic decoding will provide you with four channels of sound (front left/right, centre and monaural rear surround) from a 2-channel (stereo) source.

* *The separately sold digital audio processor (PXA-H510, PXA-H900) is required to enjoy Dolby Pro Logic surround sound.*

Dolby Pro Logic II

Dolby Pro Logic II plays 2-channel sources in 5 channels over the entire frequency range.

This is done with an advanced, high sound quality matrix surround decoder which draws out the spatial properties of the original recording without adding any sounds to or changing the sound of the source.

* *The separately sold digital audio processor (PXA-H701 etc.) is required to enjoy Dolby Pro Logic II surround sound.*

Linear PCM audio (LPCM)

LPCM is a signal recording format used for music CDs. Whereas music CDs are recorded at 44.1 kHz/16 bits, DVDs are recorded at 48 kHz/16 bits to 96 kHz/24 bits, thereby achieving higher sound quality than music CDs.

Rating levels (parental lock)

This is a DVD function for restricting the viewing age as stipulated by censorship laws in different countries. The way in which viewing is restricted differs from DVD to DVD. Sometimes the DVD cannot be played at all, other times certain scenes are skipped, and other times certain scenes are replaced with other scenes.

List of Language Codes

(For details, see page 33.)

Abbreviation	Code	Language	Abbreviation	Code	Language	Abbreviation	Code	Language
AA	6565	Afar	IE	7369	Interlingue	RN	8278	Kirundi
AB	6566	Abkhazian	IK	7375	Inupiak	RO	8279	Romanian
AF	6570	Afrikaans	IN	7378	Indonesian	RU	8285	Russian
AM	6577	Amharic	IS	7383	Icelandic	RW	8287	Kinyarwanda
AR	6582	Arabic	IT	7384	Italian	SA	8365	Sanskrit
AS	6583	Assamese	IW	7387	Hebrew	SD	8368	Sindhi
AY	6589	Aymara	JA	7465	Japanese	SG	8371	Sangho
AZ	6590	Azerbaijani	JL	7473	Yiddish	SH	8372	Serbo-Croatian
BA	6665	Bashkir	JW	7487	Javanese	SI	8373	Singhalese
BE	6669	Byelorussian	KA	7565	Georgian	SK	8375	Slovak
BG	6671	Bulgarian	KK	7575	Kazakh	SL	8376	Slovenian
BH	6672	Bihari	KL	7576	Greenlandic	SM	8377	Samoan
BI	6673	Bislama	KM	7577	Cambodian	SN	8378	Shona
BN	6678	Bengali, Bangla	KN	7578	Kannada	SO	8379	Somali
BO	6679	Tibetan	KO	7579	Korean	SQ	8381	Albanian
BR	6682	Breton	KS	7583	Kashmiri	SR	8382	Serbian
CA	6765	Catalan	KU	7585	Kurdish	SS	8383	Siswati
CO	6779	Corsican	KY	7589	Kirghiz	ST	8384	Sesotho
CS	6783	Czech	LA	7665	Latin	SU	8385	Sundanese
CY	6789	Welsh	LN	7678	Lingala	SV	8386	Swedish
DA	6865	Danish	LO	7679	Laothian	SW	8387	Swahili
DE	6869	German	LT	7684	Lithuanian	TA	8465	Tamil
DZ	6890	Bhutani	LV	7686	Latvian, Lettish	TE	8469	Telugu
EL	6976	Greek	MG	7771	Malagasy	TG	8471	Tajik
EN	6978	English	MI	7773	Maori	TH	8472	Thai
EO	6979	Esperanto	MK	7775	Macedonian	TI	8473	Tigrinya
ES	6983	Spanish	ML	7776	Malayalam	TK	8475	Turkmen
ET	6984	Estonian	MN	7778	Mongolian	TL	8476	Tagalog
EU	6985	Basque	MO	7779	Moldavian	TN	8478	Setswana
FA	7065	Persian	MR	7782	Marathi	TO	8479	Tonga
FI	7073	Finnish	MS	7783	Malay	TR	8482	Turkish
FJ	7074	Fiji	MT	7784	Maltese	TS	8483	Tsonga
FO	7079	Faroese	MY	7789	Burmese	TT	8484	Tatar
FR	7082	French	NA	7865	Nauru	TW	8487	Twi
FY	7089	Frisian	NE	7869	Nepali	UK	8575	Ukrainian
GA	7165	Irish	NL	7876	Dutch	UR	8582	Urdu
GD	7168	Scots Gaelic	NO	7879	Norwegian	UZ	8590	Uzbek
GL	7176	Galician	OC	7967	Occitan	VI	8673	Vietnamese
GN	7178	Guarani	OM	7977	(Afan) Oromo	VO	8679	Volapuk
GU	7185	Gujarati	OR	7982	Oriya	WO	8779	Wolof
HA	7265	Hausa	PA	8065	Punjabi	XH	8872	Xhosa
HI	7273	Hindi	PL	8076	Polish	YO	8979	Yoruba
HR	7282	Croatian	PS	8083	Pashto, Pushto	ZH	9072	Chinese
HU	7285	Hungarian	PT	8084	Portuguese	ZU	9085	Zulu
HY	7289	Armenian	QU	8185	Quechua			
IA	7365	Interlingua	RM	8277	Rhaeto-Romance			

List of Country Codes

(For details, see page 34.)

Abbreviation	Code	Country	Abbreviation	Code	Country	Abbreviation	Code	Country
AD	6568	Andorra	DM	6877	Dominica	KI	7573	Kiribati
AE	6569	United Arab Emirates	DO	6879	Dominican Republic	KM	7577	Comoros
AF	6570	Afghanistan	DZ	6890	Algeria	KN	7578	Saint Kitts and Nevis
AG	6571	Antigua and Barbuda	EC	6967	Ecuador	KP	7580	Korea, Democratic People's Republic of
AI	6573	Anguilla	EE	6969	Estonia			
AL	6576	Albania	EG	6971	Egypt	KR	7582	Korea, Republic of
AM	6577	Armenia	EH	6972	Western Sahara	KW	7587	Kuwait
AN	6578	Netherlands Antilles	ER	6982	Eritrea	KY	7589	Cayman Islands
AO	6579	Angola	ES	6983	Spain	KZ	7590	Kazakstan
AQ	6581	Antarctica	ET	6984	Ethiopia	LA	7665	Lao People's Democratic Republic
AR	6582	Argentina	FI	7073	Finland			
AS	6583	American Samoa	FJ	7074	Fiji	LB	7666	Lebanon
AT	6584	Austria	FK	7075	Falkland Islands	LC	7667	Saint Lucia
AU	6585	Australia	FM	7077	Micronesia, Federated States of	LI	7673	Liechtenstein
AW	6587	Aruba	FO	7079	Faroe Islands	LK	7675	Sri Lanka
AZ	6590	Azerbaijan	FR	7082	France	LR	7682	Liberia
BA	6665	Bosnia and Herzegovina	GA	7165	Gabon	LS	7683	Lesotho
BB	6666	Barbados	GB	7166	United Kingdom	LT	7684	Lithuania
BD	6668	Bangladesh	GD	7168	Grenada	LU	7685	Luxembourg
BE	6669	Belgium	GE	7169	Georgia	LV	7686	Latvia
BF	6670	Burkina Faso	GF	7170	French Guiana	LY	7689	Libyan Arab Jamahiriya
BG	6671	Bulgaria	GH	7172	Ghana	MA	7765	Morocco
BH	6672	Bahrain	GI	7173	Gibraltar	MC	7767	Monaco
BI	6673	Burundi	GL	7176	Greenland	MD	7768	Moldova, Republic of
BJ	6674	Benin	GM	7177	Gambia	MG	7771	Madagascar
BM	6677	Bermuda	GN	7178	Guinea	MH	7772	Marshall Islands
BN	6678	Brunei Darussalam	GP	7180	Guadeloupe	MK	7775	Macedonia, The former Yugoslav Republic of
BO	6679	Bolivia	GQ	7181	Equatorial Guinea			
BR	6682	Brazil	GR	7182	Greece	ML	7776	Mali
BS	6683	Bahamas	GS	7183	South Georgia and the South Sandwich Islands	MM	7777	Myanmar
BT	6684	Bhutan				MN	7778	Mongolia
BV	6686	Bouvet Island	GT	7184	Guatemala	MO	7779	Macau
BW	6687	Botswana	GU	7185	Guam	MP	7780	Northern Mariana Islands
BY	6689	Belarus	GW	7187	Guinea-Bissau	MQ	7781	Martinique
BZ	6690	Belize	GY	7189	Guyana	MR	7782	Mauritania
CA	6765	Canada	HK	7275	Hong Kong	MS	7783	Montserrat
CC	6767	Cocos (Keeling) Islands	HM	7277	Heard Island and McDonald Islands	MT	7784	Malta
CD	6768	Congo, the Democratic Republic of the	HN	7278	Honduras	MU	7785	Mauritius
CF	6770	Central African Republic	HR	7282	Croatia	MV	7786	Maldives
CG	6771	Congo	HT	7284	Haiti	MW	7787	Malawi
CH	6772	Switzerland	HU	7285	Hungary	MX	7788	Mexico
CI	6773	Cote d'Ivoire	ID	7368	Indonesia	MY	7789	Malaysia
CK	6775	Cook Islands	IE	7369	Ireland	MZ	7790	Mozambique
CL	6776	Chile	IL	7376	Israel	NA	7865	Namibia
CM	6777	Cameroon	IN	7378	India	NC	7867	New Caledonia
CN	6778	China	IO	7379	British Indian Ocean Territory	NE	7869	Niger
CO	6779	Colombia	IQ	7381	Iraq	NF	7870	Norfolk Island
CR	6782	Costa Rica	IR	7382	Iran, Islamic Republic of	NG	7871	Nigeria
CU	6785	Cuba	IS	7383	Iceland	NI	7873	Nicaragua
CV	6786	Cape Verde	IT	7384	Italy	NL	7876	Netherlands
CX	6788	Christmas Island	JM	7477	Jamaica	NO	7879	Norway
CY	6789	Cyprus	JO	7479	Jordan	NP	7880	Nepal
CZ	6790	Czech Republic	JP	7480	Japan	NR	7882	Nauru
DE	6869	Germany	KE	7569	Kenya	NU	7885	Niue
DJ	6874	Djibouti	KG	7571	Kyrgyzstan	NZ	7890	New Zealand
DK	6875	Denmark	KH	7572	Cambodia	OM	7977	Oman
						PA	8065	Panama

Abbreviation	Code	Country	Abbreviation	Code	Country	Abbreviation	Code	Country
PE	8069	Peru	SJ	8374	Svalbard and Jan Mayen	TW	8487	Taiwan, Province of China
PF	8070	French Polynesia	SK	8375	Slovakia	TZ	8490	Tanzania, United Republic of
PG	8071	Papua New Guinea	SL	8376	Sierra Leone	UA	8565	Ukraine
PH	8072	Philippines	SM	8377	San Marino	UG	8571	Uganda
PK	8075	Pakistan	SN	8378	Senegal	UM	8577	United States Minor Outlying Islands
PL	8076	Poland	SO	8379	Somalia	US	8583	United States
PM	8077	Saint Pierre and Miquelon	SR	8382	Suriname	UY	8589	Uruguay
PN	8078	Pitcairn	ST	8384	Sao Tome and Principe	UZ	8590	Uzbekistan
PR	8082	Puerto Rico	SV	8386	El Salvador	VA	8665	Holy See (Vatican City State)
PT	8084	Portugal	SY	8389	Syrian Arab Republic	VC	8667	Saint Vincent and the Grenadines
PW	8087	Palau	SZ	8390	Swaziland	VE	8669	Venezuela
PY	8089	Paraguay	TC	8467	Turks and Caicos Islands	VG	8671	Virgin Island, British
QA	8165	Qatar	TD	8468	Chad	VI	8673	Virgin Islands, U.S
RE	8269	Reunion	TF	8470	French Southern Territories	VN	8678	Viet Nam
RO	8279	Romania	TG	8471	Togo	VU	8685	Vanuatu
RU	8285	Russian Federation	TH	8472	Thailand	WF	8770	Wallis and Futuna
RW	8287	Rwanda	TJ	8474	Tajikistan	WS	8783	Samoa
SA	8365	Saudi Arabia	TK	8475	Tokelau	YE	8969	Yemen
SB	8366	Solomon Islands	TM	8477	Turkmenistan	YT	8984	Mayotte
SC	8367	Seychelles	TN	8478	Tunisia	YU	8985	Yugoslavia
SD	8368	Sudan	TO	8479	Tonga	ZA	9065	South Africa
SE	8369	Sweden	TP	8480	East Timor	ZM	9077	Zambia
SG	8371	Singapore	TR	8482	Turkey	ZW	9087	Zimbabwe
SH	8372	Saint Helena	TT	8484	Trinidad and Tobago			
SI	8373	Slovenia	TV	8486	Tuvalu			

In Case of Difficulty

If you encounter a problem, please turn the power off, then on again. If the unit is still not functioning normally, please review the items in the following checklist. This guide will help you isolate the problem if the unit is at fault. Otherwise, make sure the rest of your system is properly connected or consult your authorized Alpine dealer.

Basic

No function or display.

- Vehicle's ignition is off.
 - If connected following instructions, the unit will not operate with the vehicle's ignition off.
- Improper power lead (Red) and battery lead (Yellow) connections.
 - Check power lead and battery lead connections.
- Blown fuse.
 - Check the fuse of the unit; replace with the proper value if necessary.
- Internal micro-computer malfunctioned due to interference noise etc.
 - Press the RESET switch with a ballpoint pen or other pointed article.
- Blackout mode is activated.
 - Cancel Blackout mode.

Radio

Unable to receive stations.

- No antenna or open connection in cable.
 - Make sure the antenna is properly connected; replace the antenna or cable if necessary.

Unable to tune stations in the seek mode.

- You are in a weak signal area.
 - Make sure the tuner is in the DX mode.
- If the area you are in is a primary signal area, the antenna may not be grounded and connected properly.
 - Check your antenna connections; make sure the antenna is properly grounded at its mounting location.
- The antenna may not be the proper length.
 - Make sure the antenna is fully extended; if broken, replace the antenna with a new one.

Broadcast is noisy.

- The antenna is not the proper length.
 - Extend the antenna fully; replace it if it is broken.
- The antenna is poorly grounded.
 - Make sure the antenna is grounded properly at its mounting location.

CD/MP3/WMA/DVD/Video CD

Disc Player not functioning.

- Out of operating temperature range +50°C (+120°F) for CD.
 - Allow the vehicle's interior (or trunk) temperature to cool.

Disc playback sound is wavering.

- Moisture condensation in the disc unit.
 - Allow enough time for the condensation to evaporate (about 1 hour).

Disc insertion not possible.

- A disc is already in the DVD player.
 - Eject the disc and remove it.
- The disc is being improperly inserted.
 - Re-insert the disc following the instructions in the "loading and unloading discs" section.

Unable to fast forward or reverse the disc.

- The disc has been damaged.
 - Eject the disc and discard it; using a damaged disc in your unit can cause damage to the mechanism.

Disc playback sound skips due to vibration.

- Improper mounting of the unit.
 - Securely re-mount the unit.
- The disc is very dirty.
 - Clean the disc.
- The disc has scratches.
 - Change the disc.
- The pick-up lens is dirty.
 - Do not use a commercial available lens cleaner disc. Consult your nearest Alpine dealer.

Disc playback sound skips without vibration.

- The disc is dirty or scratched.
 - Clean the disc; damaged disc should be replaced.

CD-R/CD-RW playback not possible.

- Close session (finalization) has not been performed.
 - Perform finalization and attempt playback again.

Error displays

- Mechanical error
 - Press . After the error indication disappears, insert the disc again. If the above-mentioned solution does not solve the problem, consult your nearest Alpine dealer.

MP3 or WMA is not played back.

- Writing error occurred. The CD format is not compatible.
 - Make sure the CD has been written in a supported format. Refer to "About MP3/WMA" on pages 14-15, then rewrite in the format supported by this device.

Unit does not operate.

- Monitor's power is not turned on.
 - Turn on the monitor's power.
- Condensation.
 - Wait a while (about 1 hour) for the condensation to dry.

No picture is produced.

- Monitor's mode is not switched to the mode you want to see.
 - Switch to the mode you want to see.
- Monitor's parking brake cord is not connected.
 - Connect the monitor's parking brake cord and set the parking brake. (For details, refer to the monitor's instructions.)
- Monitor's parking brake is not set.
 - Connect the monitor's parking brake cord and set the parking brake. (For details, refer to the monitor's instructions.)

Playback does not start.

- Disc is loaded upside-down.
 - Check the disc and load it with the labeled side facing upward.
- Disc is dirty.
 - Clean the disc.
- A disc not able to playback with this unit is loaded.
 - Check if the disc is able to be played back.
- Parental lock is set.
 - Cancel the parental lock or change the rating level.

Picture is unclear or noisy.

- Disc is being fast-forwarded or fast-reversed.
 - The picture may be unclear, but this is normal.
- Vehicle's battery power is weak.
 - Check the battery power and wiring.
(The unit may malfunction if the battery power is under 11 volts with a load applied.)
- Monitor's fluorescent tube is worn out.
 - Replace the monitor's fluorescent tube.

Image stops sometimes.

- Disc is scratched.
 - Replace with a non-scratched disc.

Indication for CD Player

HITEMP

- Protective circuit is activated due to high temperature.
 - The indication will disappear when the temperature returns to normal operating range.

NO DISC

- No CD is inserted.
 - Insert a CD.
- Although a disc is inserted, "NO DISC" is displayed and the unit does not start to play or eject the disc.
 - Remove the disc by following these steps:
Press the **▲** button again for at least 2 seconds.
If the disc still does not eject, consult your Alpine dealer.

ERROR

- Mechanism error.
 - 1) Press the **▲** button and eject the CD.
If not ejecting, consult your Alpine dealer.
 - 2) When the error indication remains after ejecting, press the **▲** button again.
If the error indication still does not turn off after pressing the **▲** button for a few times, consult your Alpine dealer.
- When "ERROR" is displayed:
*If that the disc cannot be ejected by pressing **▲**, press the RESET switch (refer to page 8) and press **▲** again.
If the disc still cannot be ejected, consult your Alpine dealer.*

PROTECT

- A copy-protected WMA file was played back.
 - You can only play back non-copy-protected files.

UNSUPPORT

- The disc is not written in a MP3/WMA supported format.
 - Use a disc written at the MP3/WMA supported format.

Indication for DVD/Video CD Player

DISC ERROR

(Monitor display)

ERROR

(Audio display)

- Mechanism error.
 - 1) Press **▲** and eject the disc.
If the disc does not eject, press **▲** again for at least 2 seconds and eject the disc.
If the disc still does not eject, consult your Alpine dealer.
 - 2) When the error indication remains after ejecting, press **▲** again.
If the error indication still does not turn off after pressing **▲** a few times, consult your Alpine dealer.

NO DISC

(Monitor display)

NO DISC

(Audio display)

- No disc is inserted.
 - Insert a disc.
- Although a disc is inserted, "NO DISC" is displayed and the unit does not start to play or eject the disc.
 - Remove the disc by following step:
Press **▲** again for at least 2 seconds.



(Monitor display)

- Remote control operation is not possible.
 - For some discs or playing modes, certain operations are not possible. This is not a malfunction.

REGIONAL CODE VIOLATION

(Monitor display)

ERROR

(Audio display)

- Disc does not match regional code number.
 - Load a disc that matches the regional code number.

HI-TEMP

(Monitor display)

HITEMP

(Audio display)





- Protective circuit is activated at high temperature.
 - The indication will disappear when the temperature returns to normal operating range.
 - Leave the power OFF until the temperature decreases and then turn the power ON again.

LOADING ERROR**ERROR**

(Audio display)

EJECT ERROR

(Monitor display)

- Mechanism error.
 - 1) Press  and eject the disc.
If the disc does not eject, press  again for at least 2 seconds and eject the disc.
If the disc still does not eject, consult your Alpine dealer.
 - 2) When the error indication remains after ejecting, press  again.
If the error indication still does not turn off after pressing  a few times, consult your Alpine dealer.
-

Indication for CD Changer**HI TEMP**

- Protective circuit is activated due to high temperature.
 - The indication will disappear when the temperature returns to normal operating range.
-

ERROR - 01

- Malfunction in the CD Changer.
 - Consult your Alpine dealer. Press the magazine eject button and pull out the magazine.
Check the indication. Insert the magazine again.
If the magazine cannot be pulled out, consult your Alpine dealer.
 - Magazine ejection not possible.
 - Press the magazine eject button. If the magazine does not eject, consult your Alpine dealer.
-

ERROR - 02

- A disc is left inside the CD Changer.
 - Press the eject button to activate the eject function. When the CD Changer finishes the eject function, insert an empty CD magazine into the CD Changer to receive the disc left inside the CD Changer.
-

NO MAGZN

- No magazine is loaded into the CD Changer.
 - Insert a magazine.
-

NO DISC

- No indicated disc.
 - Choose another disc.
-

Indication for iPod Mode**NO IPOD**

- The iPod is not connected.
 - Make sure the iPod is correctly connected (refer to "Connections").
Make sure the cable is not bent excessively.
 - The iPod's battery remains low.
 - Refer to the iPod's documentation and charge the battery.
-

NO FILE

- There are no songs in the iPod.
 - Download songs to the iPod and connect to the adapter.
-

ERROR-01

- Communication error
 - Turn the ignition key off, and then set to ACC or ON again.
 - Check the display by reconnecting between the iPod and the adapter, using the iPod cable.
-

ERROR-02

- Caused by the iPod Software Version not being compatible with the optional adapter KCA-420i.
 - Refer to the Owner's Manual of the optional adapter KCA-420i, and update the iPod Software Version to be compatible with the optional adapter KCA-420i.
-

Specifications

FM TUNER SECTION

Tuning Range	87.5 – 108.0 MHz
Mono Usable Sensitivity	9.3 dBf (0.8 μ V/75 ohms)
50 dB Quieting Sensitivity	13.5 dBf (1.3 μ V/75 ohms)
Alternate Channel Selectivity	80 dB
Signal-to-Noise Ratio	80 dB
Stereo Separation	45 dB
Capture Ratio	2.0 dB

AM TUNER SECTION

Tuning Range	531 – 1,602 kHz
Sensitivity (IEC Standard)	22.5 μ V/27 dB

CD/DVD SECTION

Frequency Response	5 – 20,000 Hz (\pm 1 dB)
Wow & Flutter (% WRMS)	Below measurable limits
Total Harmonic Distortion	0.008% (at 1 kHz)
Dynamic Range	95 dB (at 1 kHz)
Channel Separation	90 dB (at 1 kHz)
Signal system	NTSC/PAL
Horizontal resolution	500 lines or greater
Video output level	1 Vp-p (75 ohms)
Video S/N ratio	DVD: 70 dB
Audio S/N ratio	115 dB

REMOTE CONTROL

Battery Type	CR2025 battery
Width	51 mm (2")
Height	119 mm (4-11/16")
Depth	13 mm (1/2")
Weight	40 g (1.4 oz) (battery excluded)

GENERAL

Power Requirement	14.4 V DC (11–16 V allowable)
Maximum Pre-Output Voltage	4 V/10 k ohms
Weight	1.6 kg (3 lbs. 8 oz)

CHASSIS SIZE

Width	178 mm (7")
Height	50 mm (2")
Depth	160 mm (6-1/4")

NOSEPIECE SIZE

Width	170 mm (6-3/4")
Height	46 mm (1-13/16")
Depth	19 mm (3/4")

- *Due to continuous product improvement, specifications and design are subject to change without notice.*

Installation and Connections

Before installing or connecting the unit, please read the following and pages 3 to 4 of this manual thoroughly for proper use.

Warning

MAKE THE CORRECT CONNECTIONS.

Failure to make the proper connections may result in fire or product damage.

USE ONLY IN CARS WITH A 12 VOLT NEGATIVE GROUND.

(Check with your dealer if you are not sure.) Failure to do so may result in fire, etc.

BEFORE WIRING, DISCONNECT THE CABLE FROM THE NEGATIVE BATTERY TERMINAL.

Failure to do so may result in electric shock or injury due to electrical shorts.

DO NOT ALLOW CABLES TO BECOME ENTANGLED IN SURROUNDING OBJECTS.

Arrange wiring and cables in compliance with the manual to prevent obstructions when driving. Cables or wiring that obstruct or hang up on places such as the steering wheel, shift lever, brake pedals, etc. can be extremely hazardous.

DO NOT SPLICE INTO ELECTRICAL CABLES.

Never cut away cable insulation to supply power to other equipment. Doing so will exceed the current carrying capacity of the wire and result in fire or electric shock.

DO NOT DAMAGE PIPE OR WIRING WHEN DRILLING HOLES.

When drilling holes in the chassis for installation, take precautions so as not to contact, damage or obstruct pipes, fuel lines, tanks or electrical wiring. Failure to take such precautions may result in fire.

DO NOT USE BOLTS OR NUTS IN THE BRAKE OR STEERING SYSTEMS TO MAKE GROUND CONNECTIONS.

Bolts or nuts used for the brake or steering systems (or any other safety-related system), or tanks should NEVER be used for installations or ground connections. Using such parts could disable control of the vehicle and cause fire etc.

KEEP SMALL OBJECTS SUCH AS BATTERIES OUT OF THE REACH OF CHILDREN.

Swallowing them may result in serious injury. If swallowed, consult a physician immediately.

DO NOT INSTALL IN LOCATIONS WHICH MIGHT HINDER VEHICLE OPERATION, SUCH AS THE STEERING WHEEL OR SHIFT LEVER.

Doing so may obstruct forward vision or hamper movement etc. and results in serious accident.

Caution

HAVE THE WIRING AND INSTALLATION DONE BY EXPERTS.

The wiring and installation of this unit requires special technical skill and experience. To ensure safety, always contact the dealer where you purchased this product to have the work done.

USE SPECIFIED ACCESSORY PARTS AND INSTALL THEM SECURELY.

Be sure to use only the specified accessory parts. Use of other than designated parts may damage this unit internally or may not securely install the unit in place. This may cause parts to become loose resulting in hazards or product failure.

ARRANGE THE WIRING SO IT IS NOT CRIMPED OR PINCHED BY A SHARP METAL EDGE.

Route the cables and wiring away from moving parts (like the seat rails) or sharp or pointed edges. This will prevent crimping and damage to the wiring. If wiring passes through a hole in metal, use a rubber grommet to prevent the wire's insulation from being cut by the metal edge of the hole.

DO NOT INSTALL IN LOCATIONS WITH HIGH MOISTURE OR DUST.

Avoid installing the unit in locations with high incidence of moisture or dust. Moisture or dust that penetrates into this unit may result in product failure.

Precautions

- Be sure to disconnect the cable from the (-) battery post before installing your DVA-9965E. This will reduce any chance of damage to the unit in case of a short-circuit.
- Be sure to connect the color coded leads according to the diagram. Incorrect connections may cause the unit to malfunction or damage to the vehicle's electrical system.
- When making connections to the vehicle's electrical system, be aware of the factory installed components (e.g. on-board computer). Do not tap into these leads to provide power for this unit. When connecting the DVA-9965E to the fuse box, make sure the fuse for the intended circuit of the DVA-9965E has the appropriate amperage. Failure to do so may result in damage to the unit and/or the vehicle. When in doubt, consult your Alpine dealer.
- The DVA-9965E uses female RCA-type jacks for connection to other units (e.g. amplifier) having RCA connectors. You may need an adaptor to connect other units. If so, please contact your authorized Alpine dealer for assistance.

IMPORTANT

Please record the serial number of your unit in the space provided below and keep it as a permanent record. The serial number plate is located on the bottom of the unit.

SERIAL NUMBER: _____
INSTALLATION DATE: _____
INSTALLATION TECHNICIAN: _____
PLACE OF PURCHASE: _____

Installation

Accessory List

- Head unit 1
- Power Supply box 1
- Power cable 1
- S video cable 1
- RCA extension cable (for video signal) 1
- Mounting sleeve 1
- Screw (M5 × 8) 4
- Flange-head tapping screw (M4 × 14) 4
- Velcro Fasteners 2
- Front frame 1
- Remote Control 1
- Battery (CR2025) 1
- Carrying case 1
- Owner's Manual 1 set

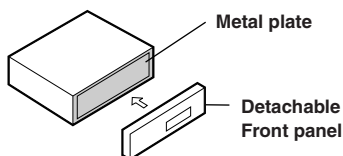

Caution

When you install this unit in your car, do not remove the detachable front panel.
If the detachable front panel is removed during installation, you might press too hard and warp the metal plate that holds it in place.

1

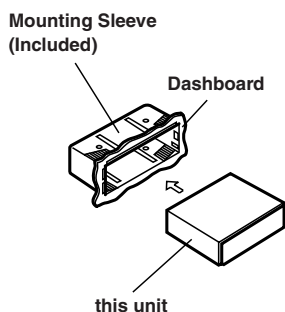

Slide the mounting sleeve into the dashboard.

2

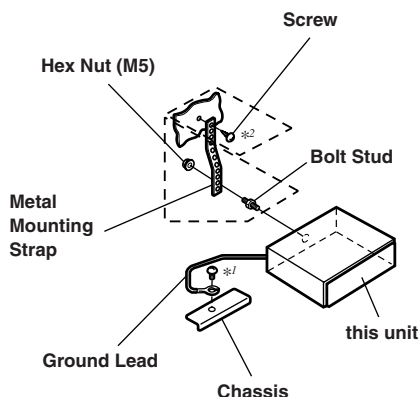

Reinforce the head unit with the metal mounting strap (not supplied). Secure the ground lead of the unit to a clean metal spot using a screw (*1) already attached to the vehicle's chassis.

- For the screw marked "*2", use an appropriate screw for the chosen mounting location.

Connect each input lead coming from an amplifier or equalizer to the corresponding output lead coming from the left rear of the DVA-9965E. Connect all other leads of the DVA-9965E according to details described in the CONNECTIONS section.

3

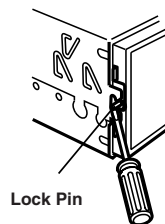

Slide the DVA-9965E into the dashboard. When the unit is in place, make sure the locking pins are fully seated in the down position. This can be done by pressing firmly in on the unit while pushing the locking pin down with a small screwdriver. This ensures that the unit is properly locked and will not accidentally come out from the dashboard. Install the detachable front panel.

Removal

- 1 Remove the detachable front panel.
- 2 Use a small screwdriver (or similar tool) to push the locking pins to the "up" position (see above drawing). As each pin is unlocked, gently pull out on the unit to make sure it does not re-lock before unlocking the second pin.
- 3 Pull the unit out, keeping it unlocked as you do so.

<JAPANESE CAR>

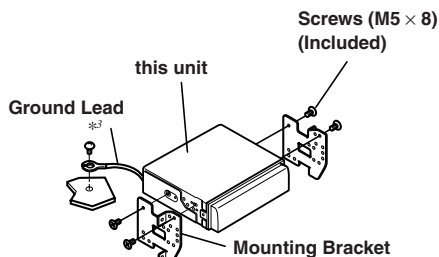
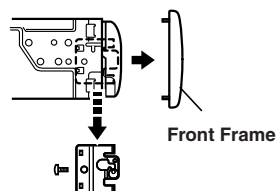

- Secure the ground lead of the unit to a clean metal spot using a screw (*1) already attached to the vehicle's chassis.

Continued

Installing the Power Supply Unit

Caution

Do not block the unit's fan or heat sink, thus preventing air circulation. If blocked, heat will accumulate inside the unit and may cause a fire.

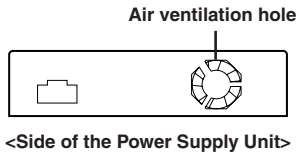

When mounting with Velcro fasteners

When mounting the Power Supply Unit with the Velcro fasteners, be sure to choose a flat location. Do not hang the unit from the bottom of the dashboard or rear deck with the Velcro fasteners.

- 1 Remove the Protective paper and attach two pieces of Velcro fastener to the bottom of the Power Supply Unit.

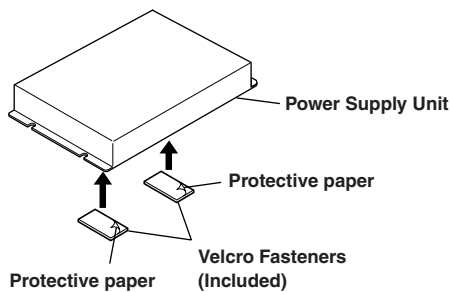

- 2 Check the position, and then fix the Power Supply Unit to the floor carpet.

When mounting with Screws

When mounting the Power Supply Unit with the screws, be sure to choose a flat location.

When making holes, be careful not to scratch any pipes or wires.

Install the Power Supply Unit on the floor with the supplied flange-head tapping screws (M4 × 14).

Flange-head tapping screws
(M4 × 14) (Included)

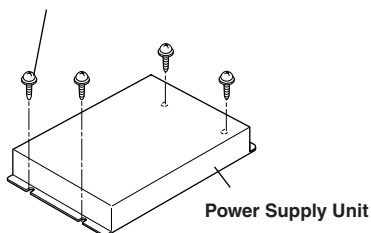

Connections

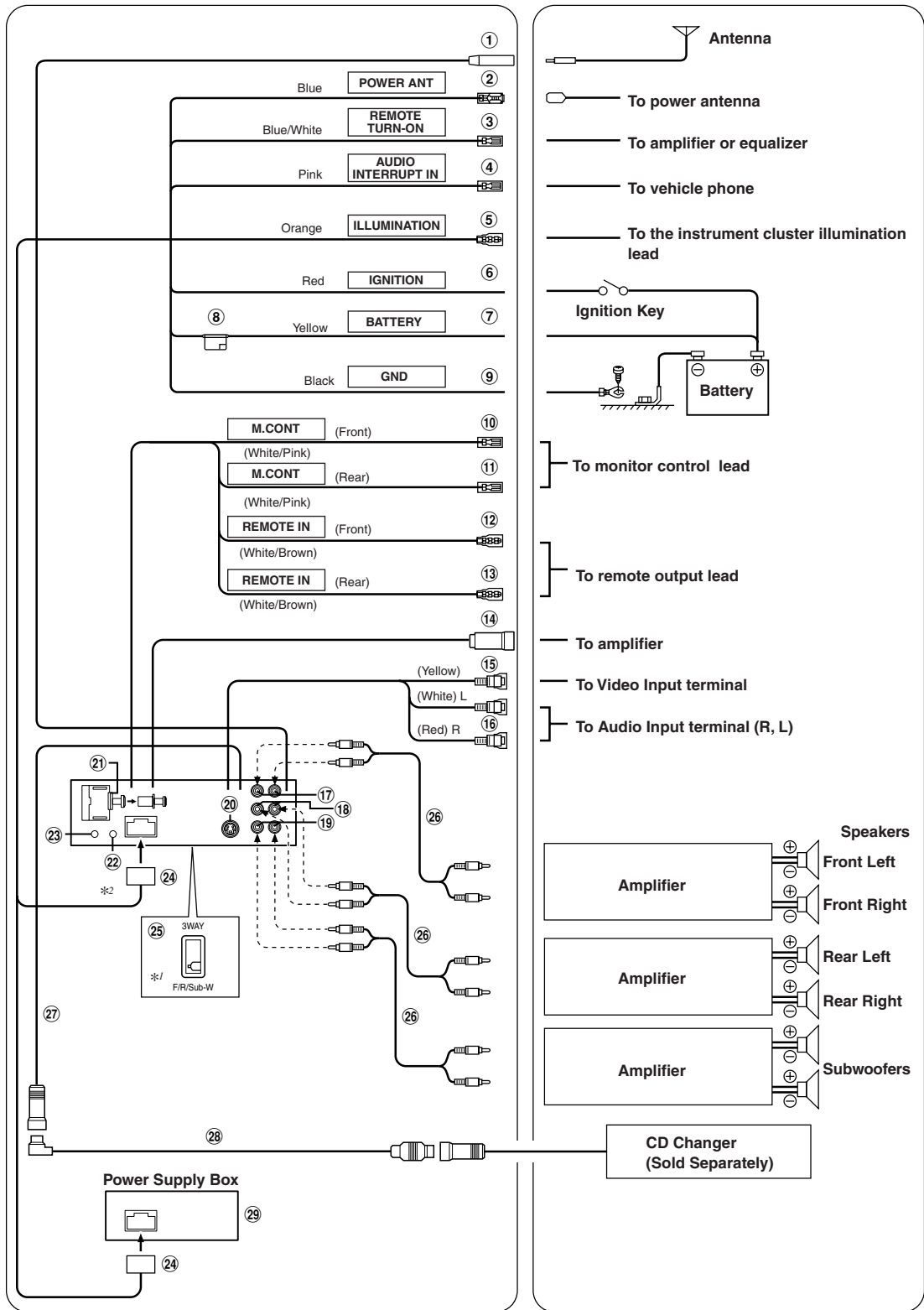

*1 The label is attached on the bottom of the unit.

***2 Caution about Power cable**

Use the power cable supplied with the unit.
Do not use a power cable that is not supplied with the unit.

- ① **Antenna Receptacle**
- ② **Power Antenna Lead (Blue)**
Connect this lead to the +B terminal of your power antenna, if applicable.
 - *This lead should be used only for controlling the vehicle's power antenna. Do not use this lead to turn on an amplifier, or a signal processor, etc.*
- ③ **Remote Turn-On Lead (Blue/White)**
Connect this lead to the remote turn-on lead of your amplifier or signal processor.
- ④ **Audio Interrupt In Lead (Pink)**
- ⑤ **Illumination Lead (Orange)**
This lead may be connected to the vehicle's instrument cluster illumination lead. This will allow the backlighting of the unit to dim whenever the vehicle's lights are turned on.
- ⑥ **Switched Power Lead (Ignition) (Red)**
Connect this lead to an open terminal on the vehicle's fuse box or another unused power source which provides (+)12V only when the ignition is turned on or in the accessory position.
- ⑦ **Battery Lead (Yellow)**
Connect this lead to the positive (+) post of the vehicle's battery.
- ⑧ **Fuse Holder (7.5A)**
- ⑨ **Ground Lead (Black)**
Connect this lead to a good chassis ground on the vehicle. Make sure the connection is made to bare metal and is securely fastened using the sheet metal screw provided.
- ⑩ **Monitor Control Lead (Front) (White/Pink)**
Connect this to the Monitor Control Lead of the touch panel compatible front monitor.
- ⑪ **Monitor Control Lead (Rear) (White/Pink)**
Connect this to the Monitor Control Lead of the touch panel compatible rear monitor.
- ⑫ **Remote Control Input Lead (Touch panel compatible front monitor) (White/Brown)**
Connect this to the remote control output lead for the touch panel compatible front monitor.
- ⑬ **Remote Control Input Lead (Rear) (White/Brown)**
Connect this to the remote control output lead for the rear monitor.
 - *If the optional remote control eye (KRE-500E) is connected, the remote control signal cannot be received.*
- ⑭ **Amplifier Link Connector**
Outputs Amplifier Link control signals.
Connect this to an external Amplifier Link compatible amplifier, using the (also separately sold) Amplifier Link box KCE-511M.
- ⑮ **Video Output Connector (Yellow)**
Output the video
- ⑯ **Audio Output Connectors**
RED is right and WHITE is left output the audio.
- ⑰ **Front Output RCA Connectors**
RED is right and WHITE is left.
- ⑱ **Rear Output RCA Connectors**
RED is right and WHITE is left.
- ⑲ **Subwoofer RCA Connectors**
RED is right and WHITE is left.
- ⑳ **S Video output terminal**
Outputs the video signal.
Connect a monitor that has a S video input terminal.
- ㉑ **Digital Output Terminal (Optical)**
Use when combining fiber digital input compatible products.
- ㉒ **Remote Control Eye Jack**
If a monitor other than Alpine is installed, it can still be controlled by the supplied remote control by installing the optional remote control eye (KRE-500E).
- ㉓ **Steering Remote Control Interface Connector**
To steering remote control interface box.
- ㉔ **Power Supply Connector**
- ㉕ **Setting the 3WAY/2WAY switch**
Set the 3way/2way switch according to your audio system.
- ㉖ **RCA Extension Cable (sold separately)**
- ㉗ **Ai-NET Connector**
Connect this to the output or input connector of another device (CD Changer, Equalizer, INTERFACE ADAPTER FOR iPod™* etc.) equipped with Ai-NET.
 - * *When connecting iPod, INTERFACE ADAPTER FOR iPod™ (KCA-420i) is required. For details on how to connect, refer to the Owner's Manual of KCA-420i.*
 - *You can input TV/video sound by connecting an optional Ai-NET/RCA Interface cable (KCA-121B) to this component.*
- ㉘ **Ai-NET Cable (Included with CD Changer)**
- ㉙ **Power Supply Box**
 - *Do not install the Power Supply Box at a location subjected to water such as under the floor mat or air conditioner. This may cause a malfunction.*
 - *Do not bundle the Power Supply Box cable with other audio cables. Doing so may induce noise into your system.*
 - *Keep the Power Supply Box converter away from the Antenna cables and the rear side of the unit, otherwise noise may be generated when receiving radio broadcast.*

Exam



The X-Over Switch position for a two-way system (frequency range is divided between highs for front/rear and lows for the Subwoofer).

The position of the X-Over switch: F/R/Sub-W

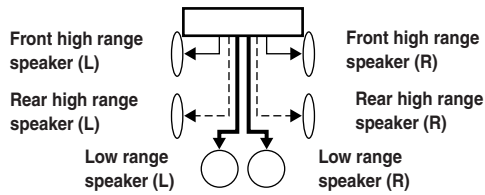

The X-Over Switch position for a three-way system whose frequency range is divided among the highs (Front), mids (Rear), and lows (Subwoofer).

The position of the X-Over switch: 3WAY

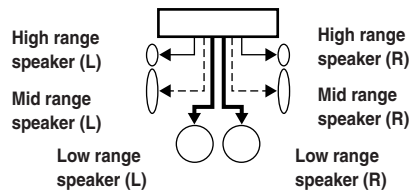

Output of this unit :

————— Front output - - - - - Rear output ——— Subwoofer output

- Use RCA-Type cables to connect the Subwoofer output to an amplifier driving the low range speakers.
- You cannot adjust the fader when set to 3WAY.

To prevent noise/interference in the audio system.

- Locate the unit and route the leads at least 10 cm away from the car harness.
- Keep the battery power leads as far away from other leads as possible.
- Connect the ground lead securely to a bare metal spot (remove any paint, dirt or grease if necessary) of the car chassis.
- If you add an optional noise suppressor, connect it as far away from the unit as possible. Your Alpine dealer carries various noise suppressors, contact them for further information.
- Your Alpine dealer knows best about noise prevention measures so consult your dealer for further information.

Free Manuals Download Website

<http://myh66.com>

<http://usermanuals.us>

<http://www.somanuals.com>

<http://www.4manuals.cc>

<http://www.manual-lib.com>

<http://www.404manual.com>

<http://www.luxmanual.com>

<http://aubethermostatmanual.com>

Golf course search by state

<http://golfingnear.com>

Email search by domain

<http://emailbydomain.com>

Auto manuals search

<http://auto.somanuals.com>

TV manuals search

<http://tv.somanuals.com>