

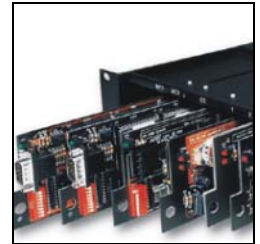

AXB-IRS4

IR/Serial Interface (4 Ports)



AXlink Bus Controllers

AMX Limited Warranty and Disclaimer

AMX Corporation warrants its products to be free of defects in material and workmanship under normal use for three (3) years from the date of purchase from AMX Corporation, with the following exceptions:

- Electroluminescent and LCD Control Panels are warranted for three (3) years, except for the display and touch overlay components that are warranted for a period of one (1) year.
- Disk drive mechanisms, pan/tilt heads, power supplies, MX Series products, and KC Series products are warranted for a period of one (1) year.
- Unless otherwise specified, OEM and custom products are warranted for a period of one (1) year.
- Software is warranted for a period of ninety (90) days.
- Batteries and incandescent lamps are not covered under the warranty.

This warranty extends only to products purchased directly from AMX Corporation or an Authorized AMX Dealer.

AMX Corporation is not liable for any damages caused by its products or for the failure of its products to perform. This includes any lost profits, lost savings, incidental damages, or consequential damages. AMX Corporation is not liable for any claim made by a third party or by an AMX Dealer for a third party.

This limitation of liability applies whether damages are sought, or a claim is made, under this warranty or as a tort claim (including negligence and strict product liability), a contract claim, or any other claim. This limitation of liability cannot be waived or amended by any person. This limitation of liability will be effective even if AMX Corporation or an authorized representative of AMX Corporation has been advised of the possibility of any such damages. This limitation of liability, however, will not apply to claims for personal injury.

Some states do not allow a limitation of how long an implied warranty last. Some states do not allow the limitation or exclusion of incidental or consequential damages for consumer products. In such states, the limitation or exclusion of the Limited Warranty may not apply. This Limited Warranty gives the owner specific legal rights. The owner may also have other rights that vary from state to state. The owner is advised to consult applicable state laws for full determination of rights.

EXCEPT AS EXPRESSLY SET FORTH IN THIS WARRANTY, AMX CORPORATION MAKES NO OTHER WARRANTIES, EXPRESSED OR IMPLIED, INCLUDING ANY IMPLIED WARRANTIES OF MERCHANTABILITY OR FITNESS FOR A PARTICULAR PURPOSE. AMX CORPORATION EXPRESSLY DISCLAIMS ALL WARRANTIES NOT STATED IN THIS LIMITED WARRANTY. ANY IMPLIED WARRANTIES THAT MAY BE IMPOSED BY LAW ARE LIMITED TO THE TERMS OF THIS LIMITED WARRANTY.

Table of Contents

Product Information	1
Specifications	1
Configuration and Installation	3
Setting the Device DIP Switch.....	3
Setting the Carrier/BAUD DIP switch	3
Positions 1-4: Carrier signal enable/disable	4
Position 5: RS-232/PCTouch mode	4
Positions 6-8: Baud rate setting	4
Setting the Internal Jumpers (E1 and E2) for AXlink or RS-232 Communication	5
Removing the circuit card.....	5
AXlink communication.....	5
RS232 communication.....	5
Wiring the AXB-IRS4.....	6
Wiring Guidelines	6
Preparing/connecting captive wires	6
Using AXlink for data and power.....	7
Using AXlink for data and a 12 VDC power supply.....	7
Using the AXlink-to-DB-9 connector cable for a PC system	7
Using the AXlink-to-DB-25 connector cable for a PC system	8
Connecting an IR device	9
Connecting a serial device	9
Replacing the Lithium Battery	9
Programming	11
Channel Setting Commands	11
Send Commands.....	11
RS-232 Protocol Commands.....	14
RS-232 Protocol Commands (IR Output).....	14
RS-232 Protocol Commands (Channel Pulse Time).....	15
RS-232 Protocol Commands (Carrier)	15
RS-232 Protocol Commands (Miscellaneous)	16

Product Information

The AXB-IRS4 (FIG. 1) is an AXCESS bus device you can program to control up to four infrared (IR) or serial-controlled audiovisual devices such as televisions and video cassette recorders. The AXB-IRS4 can be controlled by an AMX AXCESS or AXCENT2 system, or independently with a personal computer (PC).

The AXB-IRS4 can be programmed to control a wide variety of AV equipment. If you change the IR or serial equipment in your system, you can easily reprogram the AXB-IRS4 with new control commands. This flexibility allows you to upgrade your system as advances are made in AV equipment.

Specifications

AXB-IRS4 Specifications	
Control	Controls up to four IR or serial devices
Memory	28K bytes (total); stores up to 200 control commands in each port.
Power requirement	12 VDC
Power consumption	125 mA
Supported baud rates	300, 600, 1,200, 2,400, 4,800, 9,600, 19,200
Front panel components	
AXlink LED	The AXlink LED blinks when there is AXlink or RS-232 communication activity or a memory error. If an AMX system controls the AXB-IRS4, the green AXlink LED indicates the following power and data activity, or memory errors: <ul style="list-style-type: none"> • One blink per second: Power is active and the AXlink is functional. • Full on: Power is active and AXlink communication is not functional. • Fast blink: There is a memory error. A memory error can be caused by a power-deficient battery. Follow the instructions in the <i>Replacing the Lithium Battery</i> section on page 9. If the error continues, contact AMX technical support for assistance. • If a PC system controls the AXB-IRS4, the green AXlink LED blinks when RS-232 data is received or transmitted.
DEVICE DIP switch	8-position DIP switch that sets the AXB-IRS4's device number so that the Central Controller sends the proper control commands to the correct device. See the <i>Setting the Device DIP Switch</i> section on page 3 for details.
CARRIER/BAUD DIP switch	8-position DIP switch that sets the carrier/No Carrier (NC) option on the AXB-IRS4 ports, and the data transmission speed. See the <i>Setting the Carrier/BAUD DIP switch</i> section on page 3 for details.
IR/Serial LEDs (1-4)	The red IR/SERIAL LEDs blink when the AXB-IRS4 transmits IR or serial data on ports 1 through 4.
Rear panel components	
4 IR/Serial connectors	2-pin captive wire connector for each IR/serial port.
AXlink/RS232 connector	4-pin captive wire connector that supports AXlink or RS-232 data communications. <ul style="list-style-type: none"> • If you have an AMX system, use an AXlink cable to connect to the control system. • If you have a PC, use a DB-9 or DB-25 RS-232 cable to connect to the PC. See the <i>Wiring the AXB-IRS4</i> section on page 6 for details.

AXB-IRS4 Specifications (Cont.)	
PWR connector	2-pin captive wire connector connects an external 12 VDC power supply to the AXB-IRS4. An external power supply should be used when the distance between the AXB-IRS4 and control system exceeds the wiring guidelines described in the <i>Wiring Guidelines</i> section on page 6.
Battery	Lithium battery backup for stored control commands
Enclosure type	Metal with black textured finish
Weight	1.12 lbs (508 grams)
Dimensions	1.51" x 5.55" x 5.45" (38.4mm x 141.0mm x 138.4mm)
Mounting options	<ul style="list-style-type: none"> • Flat surface • Rack mount, with optional AC-RK Rack Kit

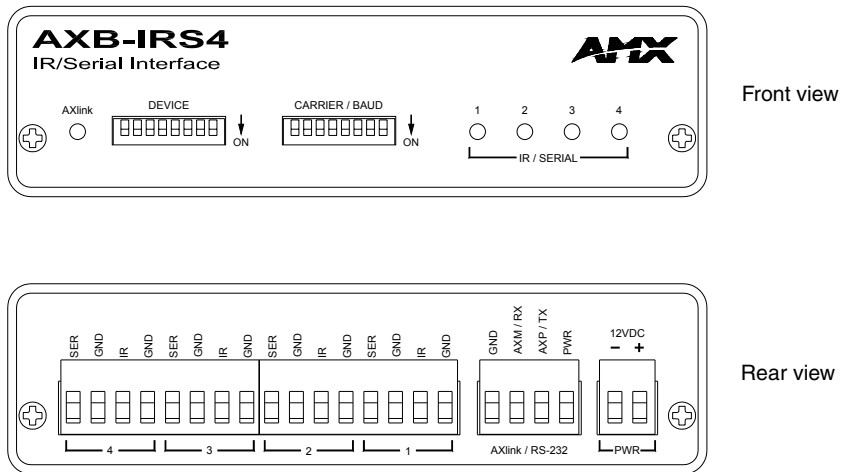

FIG. 1 Front and rear views of the AXB-IRS4

Configuration and Installation

Setting the Device DIP Switch

The 8-position DEVICE DIP switch sets the AXlink identification number for the AXB-CAM. Make sure the device number matches the number assigned in the AXCESS software program.

When you set the first device number on the DEVICE DIP switch, the AXB-IRS4 automatically assigns the next three device numbers. For example, if you set the DEVICE DIP switch to 97 (1+32+64=97) as shown below, the AXB-IRS4 sets ports 1 through 4 as device numbers 97, 98, 99, and 100.

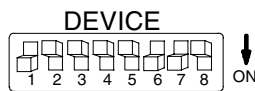

FIG. 1 DEVICE DIP switch, set to 97

The following table describes the values on the DEVICE DIP switch.

Device DIP Switch Settings								
Position	1	2	3	4	5	6	7	8
Value	1	2	4	8	16	32	64	128

To reset the AXB-IRS4 with a new DIP switch device number, disconnect and connect the AXlink or 12 VDC power connector on the AXB-IRS4.



If the AXB-IRS4 is wired for RS-232 communication, set all eight DIP switch positions to the off (up) position.

Setting the Carrier/BAUD DIP switch

The CARRIER/BAUD DIP switch sets the carrier signals and baud rates for the AXB-IRS4.

- DIP switch positions 1 through 4 set the carrier/NC signal option for ports 1 through 4.
- DIP switch position 5 is used for RS-232 or PCTouch mode.
- DIP switch positions 6 through 8 set the baud rate for RS-232 data communication.

FIG. 2 shows the DIP switch positions.

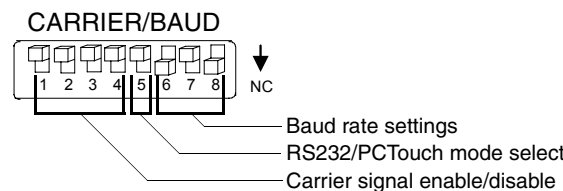

FIG. 2 CARRIER/BAUD DIP switch

Positions 1-4: Carrier signal enable/disable

DIP Switch positions 1-4 on the CARRIER/BAUD DIP switch determine whether the AXB-IRS4 transmits carrier signals along with the IR equipment codes.

- If DIP switch positions 1 through 4 are set to the **up** position, the carrier signal is enabled and the AXB-IRS4 transmits IR equipment codes at device-specific signal frequencies.
- If DIP switch positions 1 through 4 are set to **NC** (down), the carrier signal is disabled and the IR equipment codes transmit without the carrier signal.

Set the DIP switch positions 1 through 4 when you determine the port assignments and signal requirements for the IR and serial devices in your system.

Position 5: RS-232/PCTouch mode

DIP switch position 5 on the CARRIER/BAUD DIP switch sets either RS-232 or PCTouch mode. If you enable PCTouch mode, the AXB-IRS4 will only respond to PCTouch (PCCOM) command protocol. If you enable RS-232 mode, the AXB-IRS4 will respond to the standard AXB-IRS4 control protocol, PCCOM control protocol, and SX-DCU+ control protocol. You can also use RS-232 mode to download codes to the AXB-IRS4 with the IRLIB software program.

- Position 5 (up): RS-232 mode enabled.
- Position 5 (down): PCTouch mode enabled.



Refer to the PCTouch/ PCDesign Instruction Manual for detailed PCTouch program information.

Positions 6-8: Baud rate setting

DIP switch positions 6-8 on the CARRIER/BAUD DIP switch sets the baud rate for RS232 communications. Communication settings are 1 stop bit, 8 data bits, and no parity. The following table shows the baud rate settings on the CARRIER/BAUD DIP switch.

RS-232 Baud Rate Settings			
Baud Rates	DIP Switches		
	6	7	8
300	Off	Off	Off
600	On	Off	Off
1,200	Off	On	Off
2,400	On	On	Off
4,800	Off	Off	On
9,600	On	Off	On
19,200	Off	On	On

Setting the Internal Jumpers (E1 and E2) for AXlink or RS-232 Communication

Internal jumpers are located on the circuit card inside the AXB-IRS4 enclosure. You will need a Phillips-head screwdriver to open the enclosure.



Static electricity can damage electronic circuitry. Before removing the AXB-IRS4 circuit card from the enclosure, discharge any accumulated static electricity from your body and the screwdriver by touching a properly grounded metal object.

Removing the circuit card

1. Discharge the static electricity from your body and the screwdriver.
2. Unplug all connectors from the rear panel of the AXB-IRS4.
3. Remove the two Phillips-head screws on the front or rear panel.
4. Remove the front or rear panel, and slide the circuit card out of the enclosure.

AXlink communication

To set internal jumpers E1 and E2 for AXlink communication (FIG. 3):

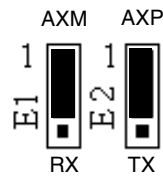

FIG. 3 Internal jumpers E1 and E2: AXlink communication setting

1. Place the 2-pin jumper on the AXM/RX (E1) connector pins 1 and 2.
2. Place the 2-pin jumper on the AXP/TX (E2) connector pins 1 and 2.

RS232 communication

To set internal jumpers E1 and E2 for RS-232 communication (FIG. 4):

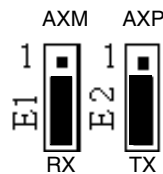

FIG. 4 Internal jumpers E1 and E2: RS232 communication setting

1. Place the 2-pin jumper on the AXM/RX (E1) connector pins 2 and 3.
2. Place the 2-pin jumper on the AXP/TX (E2) connector pins 2 and 3.
3. **Set all the DEVICE DIP switch positions to OFF (up).**

Once the jumpers are set, replace the card in the enclosure. Replace the front or rear panel, refasten the two Phillips-head screws, and plug in all connectors.

Wiring the AXB-IRS4

The serial, IR, AXlink, and power supply connectors are located on the rear panel of the AXB-IRS4 as shown in FIG. 5. The AXlink connector can also be used for RS-232 communications.

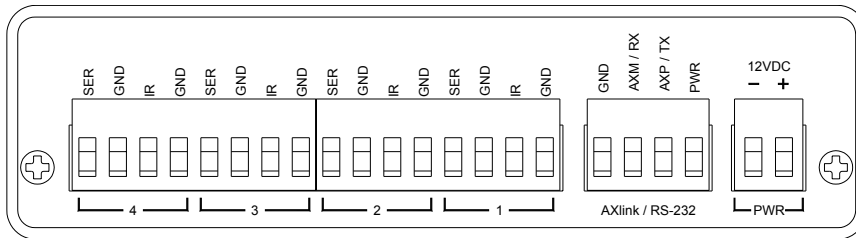

FIG. 5 AXB-IRS4 rear panel connectors



Do not connect power to the AXB-IRS4 until the wiring is complete. If you are using power from AXlink, disconnect the wiring from the Card-Frame before wiring the AXB-IRS4. If you are using an optional 12 VDC power supply, apply power to the AXB-IRS4 only when the installation is complete.

Wiring Guidelines

The AXB-IRS4 requires 12 VDC power to operate properly. The power can be supplied by the AMX system's AXlink cable or with an optional 12 VDC power supply. The maximum wiring distance between the control system and AXB-IRS4 is determined by power consumption, supplied voltage, and the wire gauge used for the cable. The following table lists wire sizes and the maximum lengths allowable between the AXB-IRS4 and control system. The maximum wiring lengths for using AXlink power are based on a minimum of 13.5 volts available at the control system's power supply.

Wiring Guidelines at 125 mA	
Wire Size	Maximum Wiring Length
18 AWG	938.97 feet (286.19 m)
20 AWG	594.06 feet (181.07 m)
22 AWG	370.37 feet (112.89 m)
24 AWG	233.46 feet (71.16 m)

If the AXB-IRS4 is installed farther away from the control system than recommended in the Wiring Guidelines table, connect a 12 VDC power supply to the 2-pin 12 VDC PWR connector on the rear panel.

Preparing/connecting captive wires

1. Strip 0.25 inch of wire insulation off all wires.
2. Insert each wire into the appropriate opening on the connector according to the wiring diagrams and connector types described in this section. Do not tighten the screws excessively; doing so may strip the threads and damage the connector.

Using AXlink for data and power

Connect the Central Controller's AXlink connector to the AXlink/RS-232 connector, on the rear panel of the AXB-IRS4, for data and 12 VDC power, as shown in FIG. 6.

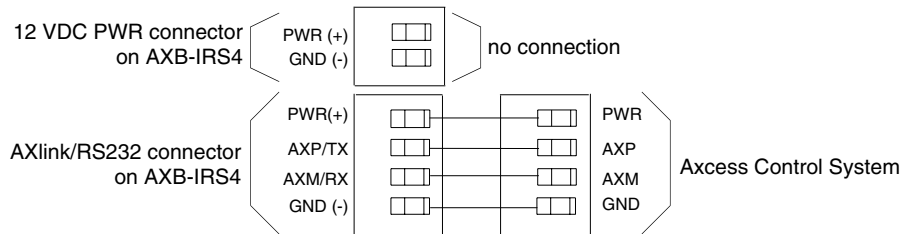

FIG. 6 AXlink data and power wiring diagram

Using AXlink for data and a 12 VDC power supply

Connect the Central Controller's AXlink connector to the AXlink/RS-232 connector, on the rear panel of the AXB-IRS4, and the optional 12 VDC power supply, as shown in FIG. 7.

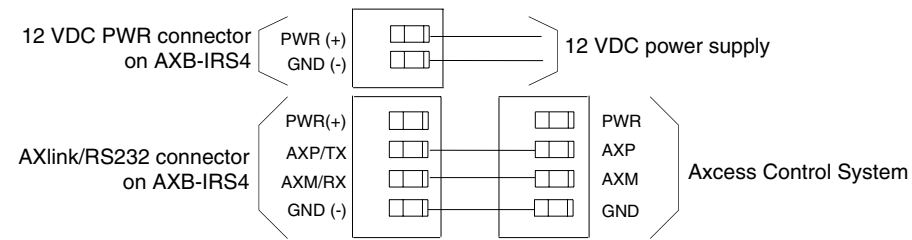

FIG. 7 AXlink and optional 12 VDC power supply wiring diagram

Use the 12 VDC power supply when the distance between the AMX system and AXB-IRS4 exceeds the limits described in the Wiring Guidelines at 125 mA table on page 6. Make sure to connect only the GND wire on the AXlink/RS-232 connector when using a 12 VDC power supply. Do not connect the PWR wire to the AXlink connector's PWR opening.

Using the AXlink-to-DB-9 connector cable for a PC system



To use a PC, set the internal jumpers for RS-232 communication mode and the DEVICE DIP switch positions 1 - 8 off (down).

The AXlink/RS-232 connector, on the back of the AXB-IRS4, can be connected to a PC system using a DB-9 connector cable. Connector pins 2, 3, and 5 are used for data and ground. The following table lists the DB-9 wiring pinouts.

DB-9 Wiring Pinouts					
Pin	Signal	Function	Pin	Signal	Function
1	N/A	Not used	6	N/A	Not used
2	RXD	Receive data	7	RTS	Request to send (not used)
3	TXD	Transmit data	8	CTS	Clear to send (not used)
4	DTR	Data terminal ready (not used)	9	N/A	Not used
5	GND	Signal ground			

FIG. 8 shows the AXlink/RS-232, DB-9, and power supply wiring diagram. For some applications, you may need to strap pins 7 (request to send) and 8 (clear to send) together depending on the PC (as shown in the illustration).

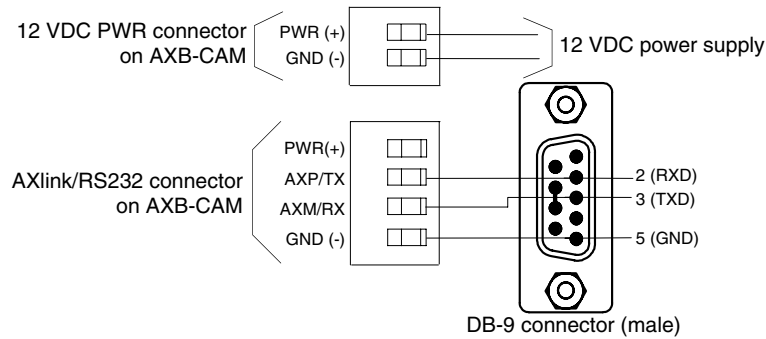

FIG. 8 AXlink/RS-232, DB-9, and power supply wiring diagram

Using the AXlink-to-DB-25 connector cable for a PC system

The AXlink/RS-232 connector on the back of the AXB-IRS4 can be connected to a PC-based system with a DB-25 connector cable. Connector pins 2, 3, and 7 are used for data and ground. Refer to the following table for the DB-25 wiring pinouts.

DB-25 Wiring Pinouts					
Pin	Signal	Function	Pin	Signal	Function
1	N/A	Not used	6	DSR	Data set ready
2	TXD	Transmit data	7	GND	Signal ground
3	RXD	Receive data	8-19	N/A	Not used
4	RTS	Ready to send	20	DTR	Data terminal ready
5	CTS	Clear to send	21-25	N/A	Not used

FIG. 9 shows the AXlink/RS-232, DB-25, and power supply wiring diagram. For some applications, you may need to strap pin 4 (ready to send) to 5 (clear to send) and/or pin 6 (data set ready) to 20 (data terminal ready) depending on the PC.

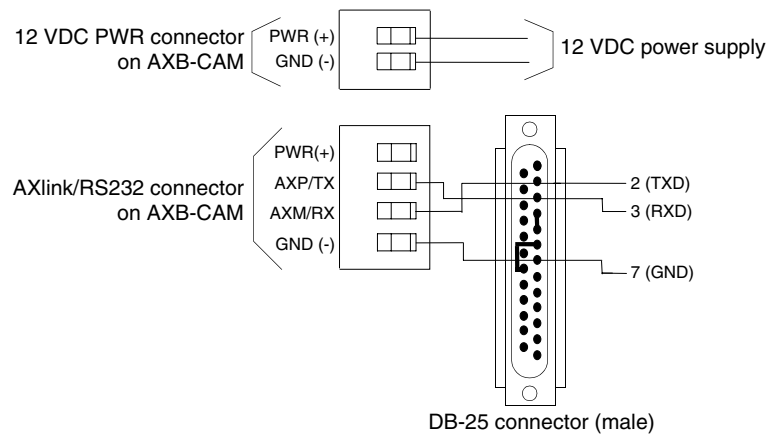

FIG. 9 AXlink/RS-232, DB-25, and power supply wiring diagram

Connecting an IR device

IR devices connect to the AXB-IRS4 with an IR device cable. The cables supplied with the AXB-IRS4 are designed to accommodate the IR devices in your system. IR cables have a two-pin connector on one end that plugs into the AXB-IRS4, and the other end has a device-specific interface adapter such as an IR emitter.

Connect IR devices to the AXB-IRS4 as shown in FIG. 10.

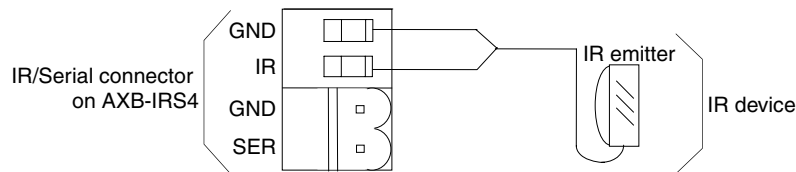

FIG. 10 IR device wiring diagram

Connecting a serial device

Serial devices connect to the AXB-IRS4 with a serial device cable. The cables supplied with the AXB-IRS4 are designed to accommodate the serial devices in your system. Serial cables have a two-pin connector on one end that plugs into the AXB-IRS4, and the other end has a device-specific interface adapter such as a control plug.

Connect serial devices to the AXB-IRS4 as shown in FIG. 11. Each serial device requires a model-specific cable. Make sure to match each serial device with the appropriate cable.

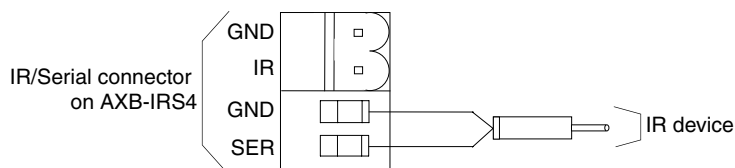

FIG. 11 Serial device wiring diagram

Replacing the Lithium Battery

A lithium battery (FIG. 12) with a life of approximately 5 years, protects stored presets if a power loss occurs. The battery is not used when DC power is supplied to the AXB-IRS4. Write down the replacement date on a sticker or label by adding 5 years to the date of installation, and then attach it to the bottom of the AXB-CAM.

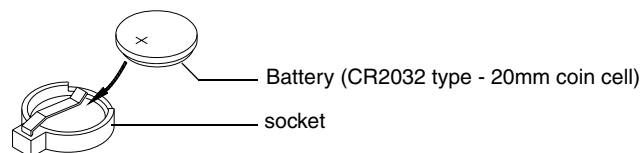

FIG. 12 Lithium battery and socket



All control commands in AXB-CAM memory are lost when the lithium battery is replaced

Contact your AMX dealer before you replace the lithium battery and verify that they have a current copy of the AXCESS program for your AXB-IRS4. This will avoid any inadvertent loss of data or a service outage.

You will need a flat-blade tool (non-conducting) that can be slipped under the lithium battery to pry it up and out of the socket.



Static electricity can damage electronic circuitry. Before removing the lithium battery from the enclosure, discharge any accumulated static electricity from your body by touching a grounded metal object.

1. Discharge the static electricity from your body.
2. Unplug all cables from the AXB-IRS4.
3. Remove the AC-RK2 and AXB-IRS4 from the mounting rack. Otherwise, go to step 4.
4. Remove the five pan-head screws on the top of the AXB-IRS4 enclosure.
5. Pull the two enclosure halves apart and set the bottom portion of the enclosure on a flat surface.
6. Locate the battery on the circuit card.
7. Carefully pry the battery out of its socket and insert the new battery. Write down the next replacement date on a sticker or label by adding 5 years to the replacement date, and then attach it to the bottom of the AXB-IRS4.
8. Plug all cables back into the AXB-IRS4.
9. Place the top portion of the enclosure back onto the bottom portion. Then, refasten the five pan-head screws.
10. Reconnect the cables removed for battery replacement.



There is a danger of explosion if you replace the battery incorrectly. Replace the battery with the same or equivalent type recommended by the manufacturer. Dispose of used battery according to the manufacturer's instructions. Never recharge, disassemble, or heat the battery above 212 °F (100 °C). Never solder directly to the battery or expose the contents of the battery to water.

Programming

Channel Setting Commands

The AXB-IRS4 channel settings listed in the following table set IR output channels. The AXB-IRS4 can process up to two IR or serial device channel setting commands simultaneously. If more than two device commands are sent simultaneously, only the first two devices receive the commands. The AXB-IRS4 can also be controlled with older SX-DCU+ RS-232 protocols.

Channel Setting Commands	
Channel	Description
1-252	Channel assignment for IR output.
253	Non-volatile data error. If IR memory is cleared, the lithium battery may need to be replaced.
255	Non-volatile data not present. Control commands are not loaded into the AXB-IRS4.

Send Commands

The send commands listed in the following table send software strings to the AMX system, and they are interpreted into a command and performed. The AXB-IRS4 can store up to 24 simultaneous CH, CP, SP, CTON, and CTOF send commands. Each command is stored and transmitted to the appropriate channel when it becomes available.

Send Commands	
Command	Description
CARON	Enable carrier to respond according to DIP switch settings on the front panel. Example: <code>SEND_COMMAND 1 , 'CARON'</code> Device 1 sends the carrier signal according to the DIP switch settings.
CAROFF	Disable carrier from responding until a CARON command is received. This command overrides the DIP switch settings on the front panel. Example: <code>SEND_COMMAND 1 , 'CAROFF'</code> Device 1 will not send a carrier signal.

Send Commands (Cont.)	
Command	Description
'CH',channel number	<p>Transmit the IR pulses that select the proper channel. Enter all channel numbers below 100 as two digits. For example, enter channel 1 as 01. If the IR code for ENTER (#21) is loaded, an ENTER follows the number. If the channel is greater or equal to 100, the IR Function Number (FN) 127 is generated for the one-hundredth digit.</p> <p>Variable: channel number = 1-199</p> <p>Example: <code>SEND_COMMAND 2, "'CH',18"</code></p> <p>The AXB-IRS4 performs the following:</p> <ul style="list-style-type: none"> • Transmits the IR code pulses for 1 (IR code 11) for the time set by CTON. • Waits for the time set by CTOF. • Transmits the IR code pulses for 8 (IR code 18) for the time set by CTON. • Waits for the time set by CTOF. If the IR code for ENTER (IR code 21) is programmed, steps 5 and 6 are performed. • Transmits the IR code pulses for ENTER (IR code 21) for the time set by CTON. • Waits for the time set by CTOF.
'CP',code	<p>Transmit IR code pulses and clear all commands in the buffer. Pulse time is set by the CTON and CTOF commands.</p> <p>Variable: code = 1-252</p> <p>Example: <code>SEND_COMMAND 2, "'CP',2"</code></p> <p>Clears all pending commands in device 2, and pulses command number 2.</p>
'CTOF',time	<p>Set the off time in tenths of a second. Default time is 5 (0.5 second). The time is stored in non-volatile RAM.</p> <p>Variable: time = 1-255</p> <p>Example: <code>SEND_COMMAND 2, "'CTOF',15"</code></p> <p>Sets channel pulse's off time for device 2 to 1.5 seconds.</p>
'CTON',time	<p>Set the on time in tenths of a second. Default time is 5 (0.5 second). Time is stored in non-volatile RAM.</p> <p>Variable: time = 1-255</p> <p>Example: <code>SEND_COMMAND 2, "'CTON',10"</code></p> <p>Sets the channel pulse's on time for device 2 to 1 second.</p>
IROFF	<p>Stop all IR code or pulses from being generated.</p> <p>Example: <code>SEND_COMMAND 3, 'IROFF'</code></p> <p>Stops the current IR output on device 3.</p>

Send Commands (Cont.)	
Command	Description
"SP',code"	<p>Transmit IR code pulses. Pulse time is set by the CTON and CTOF commands.</p> <p>Variable: code = 1-252</p> <p>Example: SEND_COMMAND 1, "'SP',2"</p> <p>Transmits a pulse out for command number 2 to device 1.</p>
<p>XCHM</p> <p>Changes the IR output pattern for the XCH command.</p>	<p>Syntax: SEND_COMMAND <DEV>, 'XCH-<Mode>'</p> <p>Variable: Mode = 0-4</p> <p>Example: SEND_COMMAND IR_1, 'XCH 3'</p> <p>Sets the IR_1 device's extended channel command to mode 3.</p> <p>Mode 0 Example (default): [x] [x] <x> <enter></p> <p>SEND_COMMAND IR_1, 'XCH 3'</p> <p>Transmits the IR code as 3-enter.</p> <p>SEND_COMMAND IR_1, 'XCH 34'</p> <p>Transmits the IR code as 3-4-enter.</p> <p>SEND_COMMAND IR_1, 'XCH 343'</p> <p>Transmits the IR code as 3-4-3-enter.</p> <p>Mode 1 Example: <x> <x> <x> <enter></p> <p>SEND_COMMAND IR_1, 'XCH 3'</p> <p>Transmits the IR code as 0-0-3-enter.</p> <p>SEND_COMMAND IR_1, 'XCH 34'</p> <p>Transmits the IR code as 0-3-4-enter.</p> <p>SEND_COMMAND IR_1, 'XCH 343'</p> <p>Transmits the IR code as 3-4-3-enter.</p> <p>Mode 2 Example: <x> <x> <x></p> <p>SEND_COMMAND IR_1, 'XCH 3'</p> <p>Transmits the IR code as 0-0-3.</p> <p>SEND_COMMAND IR_1, 'XCH 34'</p> <p>Transmits the IR code as 0-3-4.</p> <p>SEND_COMMAND IR_1, 'XCH 343'</p> <p>Transmits the IR code as 3-4-3.</p> <p>Mode 3 Example: [[100][100]...] <x> <x></p> <p>SEND_COMMAND IR_1, 'XCH 3'</p> <p>Transmits the IR code as 0-3.</p> <p>SEND_COMMAND IR_1, 'XCH 34'</p> <p>Transmits the IR code as 3-4.</p> <p>SEND_COMMAND IR_1, 'XCH 343'</p> <p>Transmits the IR code as 100-100-100-4-3.</p>

Send Commands (Cont.)	
Command	Description
XCH <Channel>	<p>Transmit the IR code in the format set with the XCHM mode command.</p> <p>Syntax:</p> <pre>SEND_COMMAND <DEV>, 'XCH <Channel>'</pre> <p>Variable:</p> <p><Channel> = 0 through 999</p>

RS-232 Protocol Commands

The RS-232 protocol commands listed in the following tables send control signals from an RS-232 device to the AXB-IRS4. The following RS-232 figures are grouped together by IR output, channel pulse time, and carrier commands.

RS-232 Protocol Commands (IR Output)

RS-232 Protocol Commands (IR Output)	
Command	Description
CH[Dev,Chan]	<p>Transmit IR pulses to the designated device that selects the proper channel. Enter all channel numbers below 100 as two digits. For example, enter channel 1 as 01. If the IR code for ENTER (#21) is loaded, an ENTER follows the number. If the channel is greater or equal to 100, IR FN 127 is generated for the one-hundredth digit.</p> <p>Variable:</p> <p>Dev = 1-4, Chan = 1-199</p> <p>Example:</p> <pre>CH[1,18]</pre> <p>The AXB-IRS4 performs the following:</p> <ul style="list-style-type: none"> • Transmits IR pulses for 1 (IR code 11) for the time set by CTON. • Waits for the time set by CTOF. • Transmits IR pulses for the IR code for 8 (IR code 18) for the time set by CTON. • Waits for the time set by CTOF. If the IR code for ENTER (IR code 21) is programmed, steps 5 and 6 are performed. • Transmits IR pulses for ENTER (IR code 21) for the time set by CTON. • Waits for the time set by CTOF.
CP(Dev,Chan)	<p>Transmit IR code pulses and clear all commands in the buffer. This command pulses the actual IR code. Pulse time is set by the CTON and CTOF commands.</p> <p>Variable:</p> <p>Dev = 1-4, Chan = 1-252</p> <p>Example:</p> <pre>CP[1,2]</pre> <p>Clears pending commands and pulses command number 2.</p>
OFF[Dev,Chan]	<p>Stop IR output on the designated device and channel.</p> <p>Variable:</p> <p>Dev = 1-4, Chan = 1-252</p> <p>Example:</p> <pre>OFF[1,11]</pre> <p>Stops device 1 from transmitting command number 11.</p>

RS-232 Protocol Commands (IR Output - Cont.)	
Command	Description
ON[Dev,Chan]	Start IR output on the designated device and channel. Variable: Dev = 1-4, Chan = 1-252 Example: ON[1, 11] Starts device 1 and transmits command number 11.
SP[Dev,Chan]	Transmit single IR code pulse. This command will pulse the actual IR code. Pulse time is set by the CTON and CTOF commands. Variable: Dev = 1-4, Chan = 1-252 Example: SP[1, 2] Transmits command number 2 pulses to device 1.

RS-232 Protocol Commands (Channel Pulse Time)

RS-232 Protocol Commands (Channel Pulse Time)	
Command	Description
CTOF(Dev,Time)	Set the channel's off-time pulse in tenths of a second. Default time is 5 (0.5 second). Time is stored in non-volatile RAM. Variable: Dev = 1-4, Time = 1-255 Example: CTOF(1, 10) Sets channel off-time pulse to one second on device 1.
CTON(Dev,Time)	Set the channel's on-time pulse in tenths of a second. Default time is 5 (0.5 second). Time is stored in non-volatile RAM. Variable: Dev = 1-4, Time = 1-255 Example: CTON(1, 10) Sets on-time pulse to 1 second on device 1.

RS-232 Protocol Commands (Carrier)

RS-232 Protocol Commands (Carrier)	
Command	Description
CAROFF(Dev)	Disable carrier from responding until a CARON command is received. This command overrides the DIP switch setting on the front panel. Variable: Dev = 1-4
CARON(Dev)	Enable the carrier to respond according to DIP switch settings on the front panel. Variable: Dev = 1-4

RS-232 Protocol Commands (Miscellaneous)

RS-232 Protocol Commands (Miscellaneous)	
Command	Description
ECHO OFF	Disable the terminal character's echo function.
ECHO ON	Enable the terminal character's echo function.
HELP	Display the on-line help menu.
MEM	Display the current amount of available memory.
VER	Display the current software version of the AXB-IRS4.
ZAP!(Dev)	Clear the specified device's IR data, and re-initialize CTON CTOF to their default values. Example: ZAP!(1) Clears IR load on device 1, and sets CTON and CTOF to 5.
ZAPALL!	Clear all device's IR data, and re-initialize CTON and CTOF to their default values. Example: ZAPALL! Clears all four devices' IR load, and sets CTON and CTOF to 5.



AMX reserves the right to alter specifications without notice at any time.

brussels • dallas • los angeles • mexico city • philadelphia • shanghai • singapore • tampa • toronto* • york
3000 research drive, richardson, TX 75082 USA • 469.624.8000 • 800.222.0193 • fax 469.624.7153 • technical support 800.932.6993

032-004-1018 5/02 ©2002 AMX Corporation. All rights reserved. AMX, the AMX logo, the building icon, the home icon, and the light bulb icon are all trademarks of AMX Corporation. AMX reserves the right to alter specifications without notice at any time. *In Canada doing business as Panja Inc.

Free Manuals Download Website

<http://myh66.com>

<http://usermanuals.us>

<http://www.somanuals.com>

<http://www.4manuals.cc>

<http://www.manual-lib.com>

<http://www.404manual.com>

<http://www.luxmanual.com>

<http://aubethermostatmanual.com>

Golf course search by state

<http://golfingnear.com>

Email search by domain

<http://emailbydomain.com>

Auto manuals search

<http://auto.somanuals.com>

TV manuals search

<http://tv.somanuals.com>