



Please take the time to complete the registration card and return promptly. If registration card is missing, call Amana Consumer Affairs Department. When contacting Amana, provide product information from serial plate found on upper left hand corner of storage door opening:

Model Number _____
Manufacturing (P) Number _____
Serial Number (S/N) _____
Purchase Date _____
Dealer Name _____
Dealer Address _____
Dealer Phone _____

Keep this manual and your sales receipt together in a safe place for future reference or if warranty service is required.

For answers to questions or to locate an authorized servicer, call **1-800-843-0304 inside USA or 319-622-5511 outside USA.**

Warranty service must be performed by an authorized servicer.

Amana Appliances also recommends contacting an authorized servicer if

Warning and Important Safety Instructions appearing in this manual are not meant to cover all possible conditions and situations that may occur. Common sense, caution, and care must be exercised when installing, maintaining, or operating range.

Always contact your dealer, distributor, service agent, or manufacturer about problems or conditions you do not understand.

Recognize Safety Symbols, Words, Labels



DANGER

DANGER—Immediate hazards which **WILL** result in severe personal injury or death.



WARNING

WARNING—Hazards or unsafe practices which **COULD** result in severe personal injury or death.



CAUTION

CAUTION—Hazards or unsafe practices which **COULD** result in minor personal injury or product or property damage.

IMPORTANT SAFETY INFORMATION

WARNING

To reduce risk of the appliance tipping, it must be secured by a properly installed anti-tip bracket. To verify bracket has been installed properly, remove the storage drawer or panel and look under the range with a flashlight. Bracket must be engaged in the rear corner of the range.

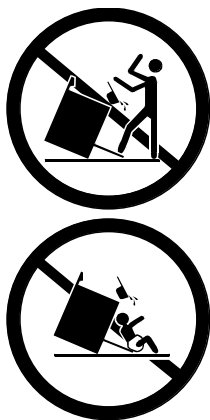

- ALL RANGES CAN TIP
- INJURY TO PERSONS COULD RESULT
- INSTALL ANTI-TIP BRACKET PACKED WITH RANGE
- REFER TO INSTALLATION INSTRUCTIONS

WARNING

To avoid personal injury, do not sit, stand or lean on oven door or oven drawer.

WARNING

To avoid risk of electrical shock, personal injury, or death, verify your range has been properly grounded and always disconnect it from main power supply before servicing.

WARNING

If the information in this manual is not followed exactly, a fire or explosion may result causing property damage, personal injury or death.

— Do not store or use gasoline or other flammable vapors and liquids in the vicinity of this or any other appliance.

— **What To Do If You Smell Gas**

- Do not try to light any appliance.
- Do not touch any electrical switch.
- Do not use any phone in your building.
- Immediately call your gas supplier from a neighbor's phone. Follow the gas supplier's instructions.
- If you cannot reach your gas supplier, call the fire department.

— Installation and service must be performed by a qualified installer, service agency or the gas supplier.

CAUTION

DO NOT TOUCH SURFACE BURNERS OR AREAS NEAR BURNERS—Areas near surface burners may become hot enough to cause burns. During and after use do not touch, let clothing or other flammable materials touch or contact surface burners or areas near surface burners until they have had enough time to cool. These areas include the rangetop and backguard.

CAUTION

DO NOT TOUCH GAS BURNERS OR INTERIOR SURFACES OF OVEN—Interior surfaces of an oven become hot enough to cause burns. During and after use do not touch, let clothing or other flammable materials touch, or contact heated interior surfaces of the oven until they have had enough time to cool. Other range surfaces that may become hot enough to cause burns are the oven door and oven vent at the backguard.

CAUTION

To avoid fire or smoke damage,

- remove any flammable materials from storage drawer. Items like plastic containers and paper manuals can melt or burn.
- clean excess spills before starting a self-clean cycle.

SAVE THESE INSTRUCTIONS

IMPORTANT SAFETY INFORMATION

ALL APPLIANCES

1. Proper Installation—Be sure your appliance is properly installed and grounded by a qualified technician.
2. Never Use Your Appliance for Warming or Heating the Room.
3. Do Not Leave Children Alone—Children should not be alone or unattended in the area where the appliance is in use. They should never be allowed to sit or stand on any part of the appliance.
4. Wear Proper Apparel—Loose fitting or hanging garments should never be worn while using appliance.
5. User Servicing—Do not repair or replace any part of the appliance unless specifically recommended in the manual. All other servicing should be referred to a qualified technician.
6. Storage in or on Appliance—Flammable materials should not be stored in an oven, in storage drawer or near surface units.
7. Do Not Use Water On Grease Fires—Smother fire or flame, or use dry chemical or foam-type extinguisher.
8. Use Only Dry Potholders—Moist or damp potholders on hot surfaces may result in burns from steam. Do not let potholder touch elements. Do not use a towel or other bulky cloth.



SURFACE BURNERS

1. Use Proper Pan Size—This appliance is equipped with one or more surface burners of different sizes. Select utensils having flat bottoms large enough to cover the surface burner. The use of undersized utensils will expose a portion of the burner to direct contact and may result in ignition of clothing. Use of oversized utensils concentrates heat on cooking surface and can cause damage to range. Proper relationship of utensil to burner improves efficiency.
2. Never Leave Surface Burners Unattended—Boilover causes smoking and greasy spillovers that may ignite.
3. Make Sure Reflector Pans or Drip Bowls Are in Place—Absence of these pans or bowls during cooking may subject wiring or components underneath to damage.
4. Protective Liners—Do not use aluminum foil to line surface burner drip bowls or oven bottom, except as suggested in the manual. Improper installation of these liners may result in a risk of electric shock, or fire.
5. Glazed Cooking Utensils—Only certain types of glass, ceramic, earthenware, or other glazed utensils are suitable for rangetop service without breaking due to sudden change in temperature.
6. Utensil Handles Should Be Turned Inward and Not Extended Over Adjacent Surface Burners—To reduce the risk of burns, ignition of flammable materials, and spillage due to unintentional contact with the utensil, the handle of a utensil should be positioned so that it is turned inward, and does not extend over adjacent surface burners.



California Safe Drinking Water and Toxic Enforcement Act (Proposition 65)

The Governor of California is required to publish a list of substances known to the state of California to cause cancer or reproductive harm and requires businesses to warn customers of potential exposures to such substances.

This appliance may contain or produce a chemical or chemicals which can cause death or serious illness and which are known to the State of California to cause cancer, birth defects, or other reproductive harm. To reduce the risk from substances in the fuel or from fuel combustion, make sure this appliance is installed, operated and maintained according to the instructions provided.



CAUTION

To avoid delayed or improper ignition, do not obstruct the flow of combustion or ventilation air.



CAUTION

Do not store items of interest to children in cabinets above a range or on the backguard of a range—children climbing on the range to reach items could be seriously injured.

SAVE THESE INSTRUCTIONS

IMPORTANT SAFETY INFORMATION

OVENS

1. Use Care When Opening Door—Let hot air or steam escape before removing or replacing food.
2. Do Not Heat Unopened Food Containers—Build-up of pressure may cause container to burst and result in injury.
3. Keep Oven Vent Ducts Unobstructed.
4. Placement of Oven Racks—Always place oven racks in desired location while oven is cool.
5. Protective Liners—Do not use aluminum foil to line drip bowls, oven racks or oven bottoms. Improper installation of these liners may result in a risk of electrical shock, or fire.

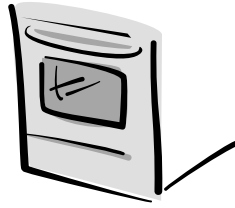

Fires can occur as a result of over cooking or excessive grease. Though a fire is unlikely, if one occurs, proceed as follows:



Surface Burner Fire

1. Smother the fire with a nonflammable lid or baking soda, or use a Class ABC or BC extinguisher. Not water. Not salt. Not flour.
2. As soon as it is safe to do so, turn the surface controls to . Turn off power at main circuit breaker or fuse box. Turn off gas supply.

Oven Fires

1. If you see smoke from your oven, do not open oven door.
2. Turn off oven.
3. As an added precaution, turn off power at main circuit breaker or fuse box. Turn off gas supply.
4. Turn on vent to remove smoke.
5. Allow food or grease to burn itself out in oven.
6. If smoke and fire persist, call fire department.
7. If there is any damage to components, call an authorized servicer before using range.

SELF-CLEANING OVENS

1. Do Not Clean Door Gasket—The door gasket is essential for a good seal. Care should be taken not to rub, damage, or move the gasket.
2. Do Not Use Oven Cleaners—No commercial oven cleaner or oven liner protective coating of any kind should be used in or around any part of the liner.
3. Clean Only Parts Listed in Manual.
4. Before Self-Cleaning the Oven—Remove broiler pan, oven racks, and other utensils.
5. Remove All Items From Rangetop and Backguard.

VENTILATION HOODS

1. Clean Ventilating Hoods Frequently—Grease should not be allowed to accumulate on hood or filter.
2. When flaming foods under the hood, turn the fan on.

In Case of Fire

SAVE THESE INSTRUCTIONS

Adjusting Surface Burner Flame

Adjustments must conform to all local, municipal and state building codes, and local utility regulations.

Placing burner caps

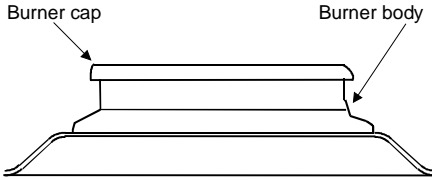

Burner cap must be correctly seated on the burner base for proper operation of the burner. Verify cap is properly aligned and leveled by moving the burner cap around on burner base while rangetop is cool.

- The cap should not be loose.
- The pegs in the burner base should fit into the recess on the underside of burner cap.
- Cap should be the correct size for each burner base.
- Cap must be clean and dry for proper ignition.
- Place grate over cap and burner base once cap is properly placed.

Testing and adjusting surface burner flame

A properly adjusted surface burner on a high setting has flames that are clean and blue with a distinct inner cone approximately $\frac{1}{4}$ to $\frac{1}{2}$ " long. Some yellow flame is normal when burning LP/Propane.

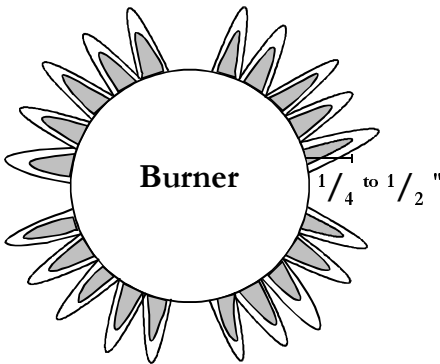

- See section in Important Safety Information for safety warnings and procedures.
- **Flames will not be a uniform size around the cap. This distribution around the cap and grate allows for optimal heating.**
- If burner flame is blowing or noisy, airflow should be reduced to the burner (close air shutter).
- If burner flame is weak and does not hold its shape, airflow should be increased to the burner (open air shutter).

Adjusting the surface burner's air shutter

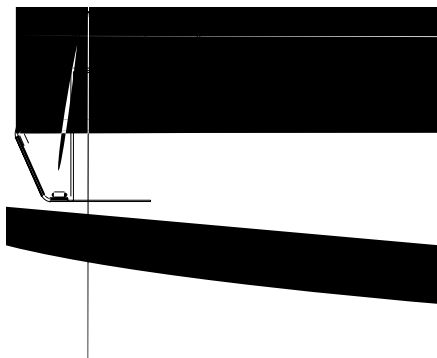

1. Ignite burner and evaluate flame. See , above.
2. Turn off all surface burners and disconnect electrical supply.
2. Remove access covers located under burner control panel.
 - Each cover is attached with a screw.
3. Using a small screwdriver, adjust air shutter depending upon appearance of the burner flame.
 - Slide air shutters using the screwdriver.
 - Air shutter should be moved by $\frac{1}{16}$ to $\frac{1}{8}$ " at a time.
4. Connect electrical supply.
5. Check flame adjustment.
6. Disconnect electrical supply if further adjustments are needed.
7. When adjustments are completed, replace access covers.

Adjusting Oven Burner Flame

Adjustments must conform to all local, municipal and state building codes, and local utility regulations.

Testing and adjusting the bake and broil burner flames

Properly adjusted oven burner flames are blue with a distinct blue inner cone approximately $\frac{1}{2}$ " long. When using natural gas, flame should not have any yellow flame when burning. Some yellow flame when burning LP/Propane gas is normal.

Flame should not be visible in oven cavity when burning and should not extend into the oven cavity beyond the removable oven bottom.

See _____ section in Important Safety Information for safety warnings and procedures.

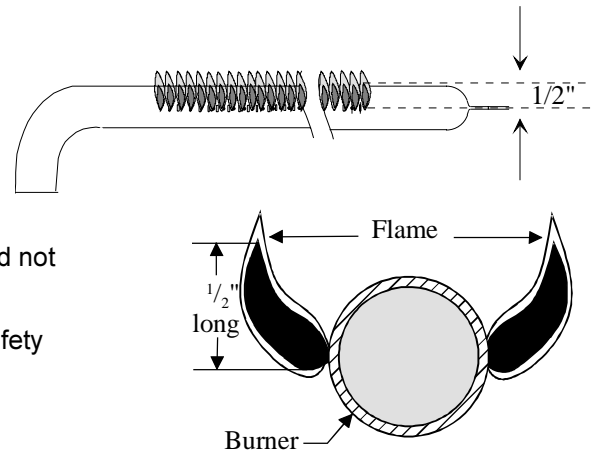

Adjusting bake burner's air shutter

1. Disconnect electrical supply.
2. Remove oven bottom when oven is cool.
3. Remove storage drawer.
4. Locate and remove 2 screws attaching Z-shaped cover plate.
 - Cover plate located in center, rear of storage drawer cavity.
 - Removing cover plate exposes oven burner orifice and air shutter
5. From front of range, locate bake burner air shutter.
6. Loosen air shutter lock screw and open or close air shutter.
 - Air shutter should be moved by $\frac{1}{16}$ " to $\frac{1}{8}$ " at a time.
 - If burner flame is blowing or noisy, reduce airflow to the burner (close air shutter)
 - If burner flame is yellow and does not hold its shape, increase airflow to the burner (open air shutter).
7. Tighten air shutter screw.
8. Connect electrical supply.
9. Test oven bake burner flame for proper adjustment. If not adjusted properly, disconnect electrical supply and repeat steps 5, 6 and 7.
10. Replace cover plate and storage drawer.
11. When oven is again cool, replace oven bottom.

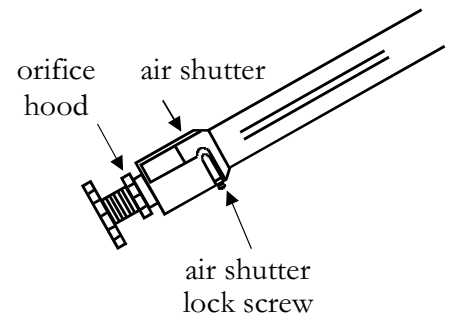

Adjusting broil burner's air shutter

Broiler flame should appear hazy or fuzzy. Haze should be approximately $\frac{3}{8}$ inch thick. Because broiler has a fixed orifice it can not be adjusted. Broiler does not have an air shutter.

Cookware Recommendations

What Should You Consider in Cookware?

For best cooking results, use a pan with a flat bottom. To determine if pan has a flat bottom:

1. Rotate a ruler along bottom of pan. If pan is not flat, gaps between bottom of pan and edge of ruler can be seen.
2. A small groove or mark on a pan does not affect cooking times. However, if a pan has a gap, formed rings, or an uneven bottom, it does not cook efficiently and in some cases may not boil liquids.

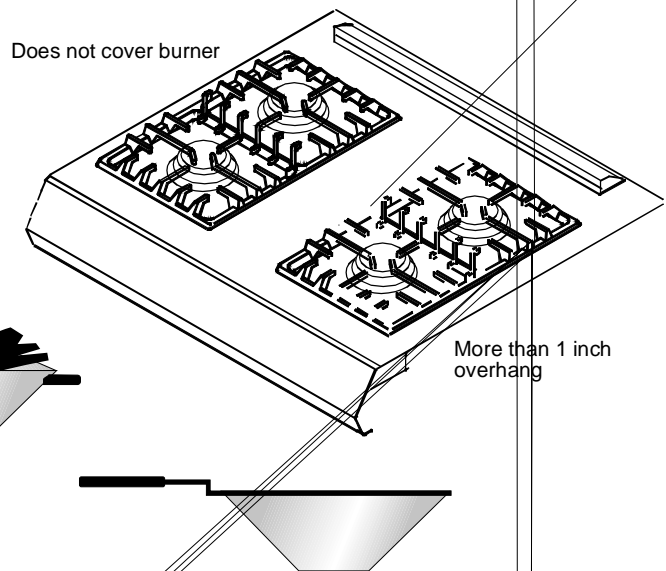
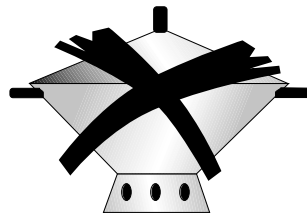
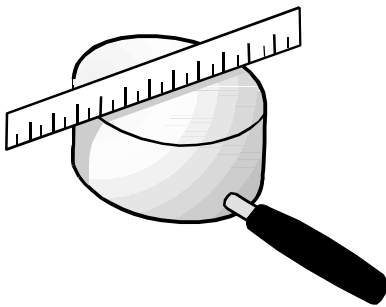

SELECT	AVOID
Flat bottomed cookware.	Cookware with rounded or warped bottoms.
Heavy gauge metal cookware.	Light gauge metal cookware.
Handles that are secure, that are not heavy enough to tilt pan.	Cookware with loose or broken handles or heavy handles that tip pan when empty.
Proper pan size.	Cookware that is smaller than or greater than burner grate by 1 inch.
Flat bottomed wok	Wok with a ringstand on bottom.

Canning is not recommended with any of the Amana gas ranges or cooktops due to the intense heat and large cookware required to can.

The high, sustained heat generated by the canning cookware overheats both the burners and the surface of the range or cooktop. This may cause damage to burners, knobs, or finish, and may even cause overheating of surrounding walls.

Damage incurred by canning, or attempting to can, is not covered under warranty.

COOKWARE MATERIAL	USES
Aluminum	Heats and cools quickly. Use for frying, braising, and roasting.
Stainless Steel	Heats and cools at moderate rate. Use for soups, sauces, vegetables, general cooking.
Copper Clad / Tin Lined	Heats and cools quickly. Use for gourmet cooking, wine sauces, egg dishes.
Cast Iron	Heats and cools slowly. Use for low heat cooking, frying.
Enamelware	Heating speed depends on base metal in the cookware. Use for low heat cooking.
Ceramic (Glass)	Heats and cools slowly. Use for low heat cooking.

Using the Range

Setting Surface Burner Controls

Burner should ignite within 4 seconds. If burner does not ignite within 4 seconds, turn control knob to OFF position and follow directions in _____ section.

See _____ section in Important Safety Information for safety warnings and procedures.

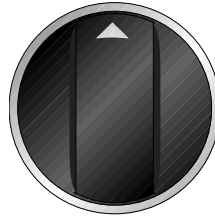

WARNING

To avoid risk of serious personal injury, property damage, or fire, do not leave surface burners unattended while in operation. Grease and spillovers may ignite causing a fire.

1. Push in and turn knob to LITE.
 - Burner should ignite within 4 seconds.
2. After gas ignites, turn control to desired setting.
 - Knobs do not have distinct 'clicks'.
 - Use HI to bring food to boiling temperatures. When food is boiling temperature setting should be reduced.
 - After lighting burner do not operate for long periods of time without cookware on grate. The finish on the grate can chip without cookware to absorb the heat.
 - Flame size should match the size of the pan. Do not allow flame to extend up the sides of the pan. This can cause clothing to ignite, make the handle hot, or cause burns.
3. When finished cooking, turn control to OFF position.



The control descriptions are intended to show the variety of features that are available in the product line. If your range does not have all the features that are shown, it is not a mistake. The information provided applies to several of the available models.

SURFACE BURNER CONTROL SETTINGS	WHEN TO USE SETTING
LO	Use to prepare food at less than boiling temperatures or to simmer.
MED	Use to maintain boiling of larger amounts of food, low temperature frying and to maintain correct pressure in a pressure cooker.
HI	Use to bring food to boiling temperatures. When food is boiling temperature setting should be reduced to LO through MED.

Although the system that lights the burners is electric, surface burners can be ignited during a power outage. **Never attempt to light bake or broil burners (oven burners) during a power failure.**

1. Hold match at base of desired surface burner.
2. Push in burner control knob and turn to LITE position.
3. After gas ignites, remove match from burner and turn burner control knob to desired setting.

Adjusting Burner Flame Size

- While turning the burner control knob, watch the burner flame.
- Flame size should match the size of the pan.
- Flames that extend up the sides of the pan can ignite clothing, make the handle hot, or cause burns.

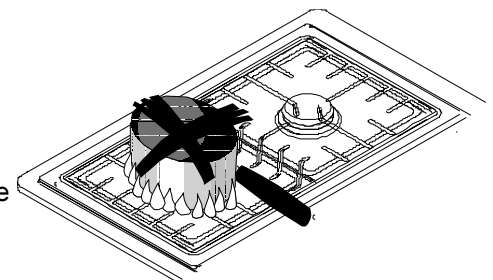

Display and Signals

Displays time-of-day, timer and timed or delayed settings.

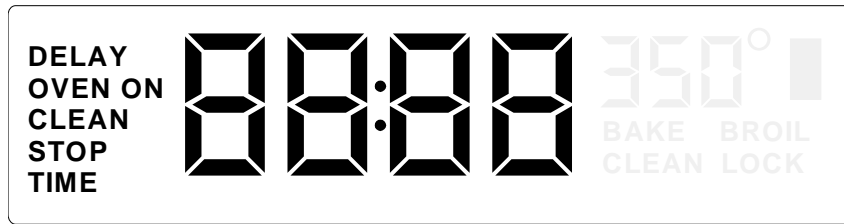

Displays temperature and cooking method or function of oven.

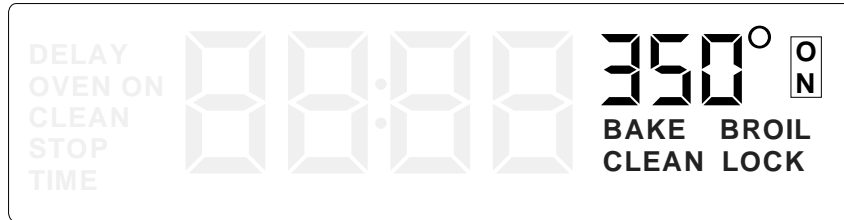

The display is used for many different models of ranges. Depending on the model, certain words or symbols may never be highlighted or become visible.

When time elapses, timer beeps three, one second tones and then one beep approximately every six to eight seconds.

After setting oven to bake and selecting a temperature, oven preheats. When oven reaches set temperature, oven signals a single audible beep.

When a timed cooking cycle is complete, the oven will beep three tones approximately one second apart, followed by one second beeps every six to eight seconds for five minutes.

DISPLAY	DESCRIPTION
TIME	Displays when time-of-day, timed or delayed baking, or delayed self-cleaning is set.
BAKE	Displays while bake is set and used.
ON	Displays when oven is heating
DELAY	Displays when delayed bake or self-clean cycle is set. Oven is not heating.
STOP	Displays when setting the stop time for a delayed baking or self-clean cycle.
BROIL	Displays when a broil is set and used.
CLEAN	Displays when self-clean cycle is set and used.
LOCK	LOCK flashes while oven door is locking and remains in display while door is locked. After cycle is complete and oven has cooled to a safer temperature, LOCK no longer displays and door can be opened.

Child lockout

This safety feature is used to prevent children from accidentally programming oven by disabling electronic oven control. Child lockout is also useful to prevent accidental programming while cleaning the range control. Press and hold the BAKE and CLOCK pads for 5 seconds. OFF displays where the temperature normally appears. To reactivate control, press and hold the BAKE and CLOCK pads for 5 seconds on the oven control. Child lockout must be reset after a power failure.

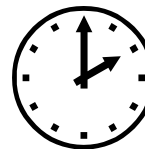

12-hour automatic cancel

This safety feature prevents oven from continuing to operate if it has been left on for over 12 hours. If a cooking function continues longer than 12 hours without any options on oven control being touched, this feature turns oven off. Any time an option is touched, 12-hour automatic cancel is reset.

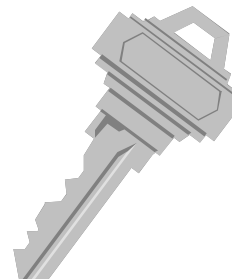

Oven temperature control adjustment

Your range is calibrated at the factory for proper temperature. Due to individual variances and preferences, it may be necessary to adjust ovens once they have been installed.

When first using the oven, follow recipe times and temperatures. Before adjusting oven baking temperature, test a recipe by setting oven temperature higher or lower than the suggested temperature. The baking results should help you to decide how much of a temperature adjustment is required.

An accurate digital thermometer is necessary to calibrate the oven. Store purchased oven thermometers may not accurately measure oven temperature. Oven temperature can be increased or decreased by 35°F. To avoid over adjusting the oven, only adjust the temperature by 5°F each time.

NOTE: DO NOT place aluminum foil on racks and oven bottom as this will alter oven performance. Check for blocked heat vents. If it still appears the oven is not performing as expected, a calibration may be done.

1. Press BAKE pad.
2. Using the UP arrow pad until an oven temperature greater than 500°F displays.
3. Immediately press and hold BAKE pad for approximately 5 seconds.
4. A double digit offset temperature will display. Factory default is normally 00 degrees.
 - Use arrow pads to key to adjust the temperature change in 5° increments.
 - When temperature is adjusted to a cooler setting, a minus sign (-) will display with the offset temperature.
5. To set the temperature change, press OVEN CANCEL pad.
 - Offset temperature change will be retained through a power failure.

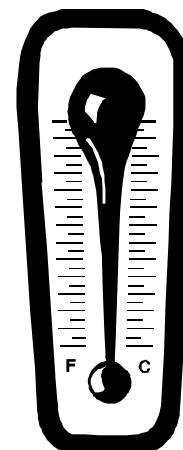

Service codes and tones

Electronic oven control is equipped with a self-diagnostic system. The self-diagnostic system alerts you if there is an error or problem with the unit. If electronic range control sounds a series of short, rapid beeps for over 16 seconds and display shows an F-code, **record** the F-code shown. Some F-codes can be cleared by pressing cancel or disconnecting power to the range for at least 3 minutes. If the code continues to reoccur disconnect electrical supply to range and contact an authorized servicer.

F-code	Possible Meaning
F1	Shorted pad button
F2	Oven over temperature
F3	Open circuit in oven
F4	Shorted circuit in oven
F5	Failed circuit in control
F7	Lock failure
F9	Lock failure

Using the Oven Control

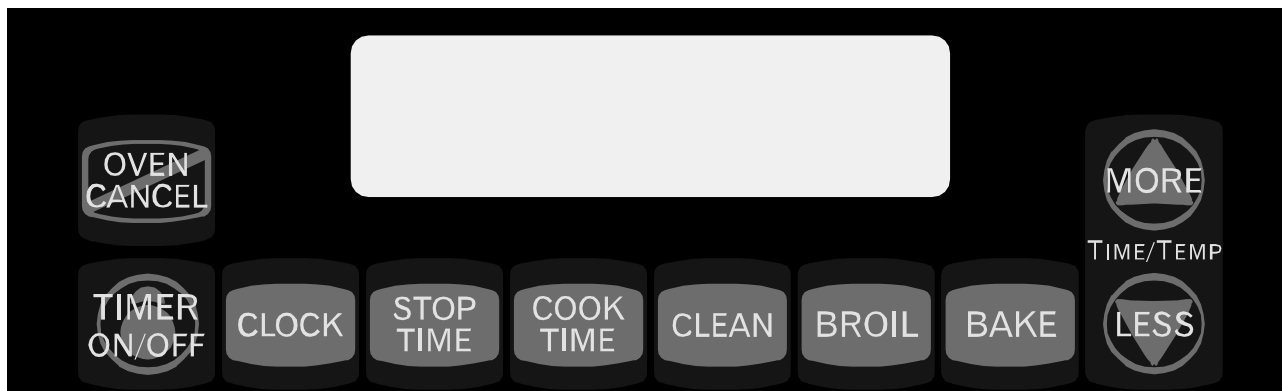

When power is connected or interrupted, oven display flashes. Press CLOCK to reset display. Clock may need to be reset.

Setting Electronic Clock

12 hour clock does not display AM, PM or military time. When power is connected or restored, display flashes until CLOCK or CANCEL pad is pressed.

1. Press CLOCK pad.
 - TIME displays.
2. Press MORE or LESS pads until correct time of day displays.
3. Press OVEN CANCEL pad to set time, or time is set after 30 seconds of no adjustment.

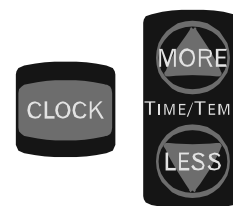

When time elapses, timer will sound three one-second beeps and then once every 30 seconds. END also displays. Press TIMER ON/OFF pad to stop timer and return to clock display.

Setting Minute Timer

Timer is a timer only. Electronic timer does not control bake, broil or self-clean function. Timer can be set from 5 seconds up to 9 hours and 50 minutes.

1. Press TIMER ON/OFF pad.
 - TIMER displays.
2. Press MORE or LESS pads until desired time displays.
 - Timer begins counting down automatically after time is entered.
3. Press and hold TIMER ON/OFF pad for 3 seconds to cancel timer signal.
 - After time elapses, timer beeps three tones, and then once approximately every 6 - 8 seconds until CANCEL is pressed.

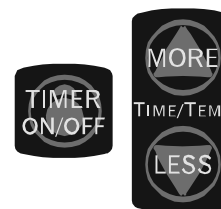

Resetting and Canceling Timer

To cancel timer when remaining time is displayed or when signal is beeping, press and hold TIMER ON/OFF pad for approximately 3 seconds DO NOT press OVEN CANCEL pad. CANCEL will stop all cooking functions if the oven is in use.

Using the Oven Control

Baking

While oven is still cool, remove any stored items from the oven cavity.

1. Press BAKE pad.
 - **BAKE** and ---° display.
2. Press arrow pads until desired temperature is displayed.
 - Time of day, oven temperature, **BAKE**, and  display.
3. Press OVEN CANCEL pad when finished.
 - Remove food from oven when cooking time has elapsed. Food left in oven can overcook.

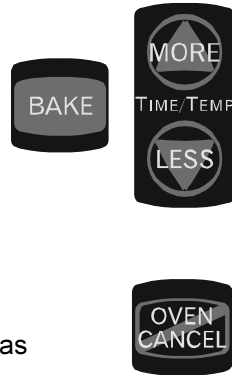

WARNING

To avoid risk of personal injury, property damage or fire, do not line oven bottom, racks, or broiler pan and grid with aluminum foil.

WARNING

To avoid risk of personal injury, property damage or fire, never leave oven unattended while broiling.

Broiling

Broiling sears in natural juices and provides charbroiled flavor.

To broil, center food on broiling grid and pan and place on proper rack in oven. Do not place aluminum foil over broiling pan, oven rack or oven bottom. **Oven door must be fully closed.** Broiling does not require preheating so you can place food in oven while it is still cool.

1. Adjust oven racks to desired position.
2. Place food on desired rack.
3. Close oven door.
4. Press BROIL pad.
 - **BROIL** and --- displays.
5. Press MORE or LESS pads.
 - Oven begins to broil automatically. **BROIL**, , and **Hi** display.
6. Press OVEN CANCEL pad when finished.

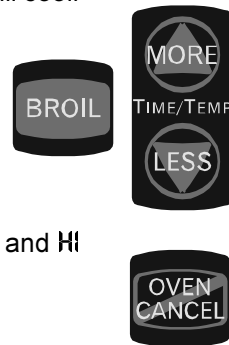

After setting oven to bake and selecting a temperature, oven preheats. When oven reaches set temperature, the preheat signal sounds.

While the oven is baking, simply press BAKE, enter the desired temperature, and then press START. Use these steps to change the oven temperature during Timed and Delayed Baking, also. To change cook time during Timed or Delayed Baking, press COOK TIME, enter the desired cooking time, and press START.

Oven temperature can be set from 170°F to 550°F in 5° increments. Oven cavity temperature displays at 100°F and increases in 5° increments until the reaching the set cooking temperature.

With new ovens, some minor smoking is normal when using the oven for first few times. Performing a self-clean cycle should stop further smoking.

Using the Oven Control

When using **TIMED** cooking, the oven begins to heat immediately after the oven control is set. Then, the oven cooks for the specified length of time. When using **DELAYED** cooking, the oven begins to cook later in the day. Set the time that you want to begin cooking and the how long you want to cook. The oven begins to heat when at the selected time and cooks for the specified length of time.

Cook time and stop time can be set up to 11 hours and 59 minutes ahead. To view cook time, press and hold **COOK TIME** pad. When cooking time has elapsed, an end of cycle signal sounds, oven automatically turns off and display returns to time of day. Oven signal sounds 4 times, then once every 10 seconds until knob is turned to **OFF**. Broil can not be set to Timed or Delayed.





CAUTION

To reduce risk of food poisoning due to bacterial growth and production of toxins, never hold meat, milk, fish, or eggs for more than 2 hours before cooking.

For a delayed bake cycle, the cook time can be viewed by pressing the **COOK** pad. For a timed bake cycle, the stop time can be viewed by pressing the **STOP** pad.



Timed Baking

1. Place food in oven.
2. Press **COOK TIME** pad.
 - **OVEN, TIME, HR**, and  display.
3. Press **MORE** or **LESS** pads until cooking time is displayed.
 - 10 minutes minimum cooking time.
 - If **BAKE** pad is not pressed, oven signals and **BAKE** display.
4. Press **BAKE** pad.
 - **BAKE** and $---$ ° display.
5. Press **MORE** or **LESS** pads until desired temperature is displayed.
 - **OVEN, TIME, BAKE**, , and **HR** display.
 - Cooking time begins to count down.
 - When cooking time has elapsed, an end-of-cycle signal sounds, oven automatically turns off and display returns to time of day. Oven no longer maintains cooking temperature after timed bake is complete.
6. Press **OVEN CANCEL** pad when finished.
 - Remove food from oven when cooking time has elapsed. Food left in oven can overcook.
 - Pressing **OVEN CANCEL** stops end of cycle signal.



Delayed Baking

Set oven to begin baking at a later time.

1. Place food in oven.
2. Press **BAKE** pad.
 - **BAKE** and $---$ display.
3. Press **MORE** or **LESS** pads until desired temperature is displayed.
 - Time of day, oven temperature, **BAKE**, and  display.
4. Press **STOP TIME** pad.
 - Current time of day, **STOP, TIME, BAKE**, and  display.
5. Press **MORE** or **LESS** pads until desired stop time displays.
6. Press **COOK TIME** pad.
 - **OVEN, TIME**, and **BAKE** display.
 - To view cook time later, press **COOK TIME** pad.
7. Press **MORE** or **LESS** pads until desired cooking time is displayed.
 - Maximum cooking time, **DELAY, OVEN, TIME, HR**, and **BAKE** display.
 - 10 minutes minimum cooking time.
 - Electronic range control calculates start time.
 - When start time is reached **DELAY** no longer displays and  displays.
 - When cooking time has elapsed, end-of-cycle signal sounds, oven automatically turns off and display returns to time-of-day.
 - Press **OVEN CANCEL** to stop end of cycle signal.

Using the Oven Control

WARNING

To avoid risk of personal injury, property damage, or fire, clean excess grease and soil from oven and oven bottom before beginning a self-clean cycle.

1. Wearing gloves, pull oven bottom forward and lift out of range.
2. Wipe out burner area with a cloth and warm soapy water.
3. Dry area thoroughly and carefully replace oven bottom.

CAUTION

To avoid fire or smoke damage,

- **clean excess spills before starting a self-clean cycle.**
- remove any flammable materials from storage drawer. Items like plastic containers and paper manuals can melt or burn.

Self-cleaning

Self-clean feature uses high oven temperature to clean oven interior. For the oven to operate through a complete self-clean cycle, the self-clean must be set when the oven is cool.

1. Prepare oven for self-cleaning (see below right).

2. Close door.

3. Press CLEAN pad.

- The default self-clean cycle length of 3 hours will display.

4. Set cycle length for self-clean.

- Press MORE or LESS pads to adjust time as necessary before oven indicator light turns on.
- Clean cycle can be set from two to four hours in five minute increments.
- Default setting for the cycle is three hours.

5. Self-clean begins.

- OVEN ON indicator light will be on and will remain on until the end of the cycle.
- At the end of the self-clean cycle, the OVEN ON indicator light will shut off.
- At the end of the self-clean cycle, the oven will stop heating, however, oven will remain hot.
- The LOCKED indicator light will remain on until oven reaches a cooler temperature. LOCKED light will flash while door is unlocking, and then shut off when door has unlocked. Oven cavity will be hot to the touch. **DO NOT** attempt to open door prior to LOCKED indicator light shutting off. When oven is cool, turn oven knob to OFF.

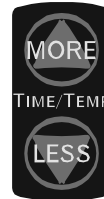

Interrupting the self-clean cycle

To stop a self-clean cycle that has already started follow these steps. If the interruption occurs mid cycle, the oven will remain locked, even though the cycle has stopped, until the oven cavity has cooled to a lower temperature.

1. Press OVEN CANCEL pad.
2. When oven has cooled to a lower temperature, LOCKED light turns off. **DO NOT** force door. This can cause damage to the latch.

WARNING

To avoid risk of personal injury, do not touch oven vents, or area around vents, during self-cleaning. These areas can become hot enough to cause burns.

To get the best results from the self-clean cycle, follow these steps:

- **Remove birds or animals susceptible to smoke or other fumes from the room or adjoining room.**
- Clean excess spills from oven interior and bottom thoroughly.
- Open window if possible.
- Make sure oven light cover is properly in place. Do not use cleaning cycle if it is not.
- Remove oven racks and all cooking utensils from oven.
- Remove items from range top, backguard and storage drawer. These areas can become hot during self-cleaning cycle.
- The range vents from the center bottom of the backguard. Make sure this area is unobstructed by removing all items from backguard and range top.

Using the Oven Control

CAUTION

To avoid fire or smoke damage,

- **clean excess spills before starting a self-clean cycle.**
- remove any flammable materials from storage drawer. Items like plastic containers and paper manuals can melt or burn.

WARNING

To avoid risk of personal injury, do not touch oven vents, or area around vents, during self-cleaning. These areas can become hot enough to cause burns.

WARNING

To avoid risk of personal injury, property damage, or fire, clean excess grease and soil from oven and oven bottom before beginning a self-clean cycle.

1. Pull oven bottom forward and lift out of range.
2. Wipe out burner area with a cloth and warm soapy water.
3. Dry area thoroughly and replace oven bottom.

To get the best results from the self-clean cycle, follow these steps:

- **Remove birds or animals susceptible to smoke or other fumes from the room or adjoining room.**
- Clean excess spills from oven interior and bottom thoroughly.
- Open window if possible.
- Make sure oven light cover is properly in place. Do not use cleaning cycle if it is not.
- Remove oven racks and all cooking utensils from oven.
- Remove items from range top, backguard and storage drawer. These areas can become hot during self-cleaning cycle.
- The range vents from the center bottom of the backguard. Make sure this area is unobstructed by removing all items from backguard and range top.

WARNING

To avoid risk of personal injury, property damage, or fire, clean excess grease and soil from oven and oven bottom before beginning a self-clean cycle.

1. Wearing gloves, pull oven bottom forward and lift out of range.
2. Wipe out burner area with a cloth and warm soapy water.
3. Dry area thoroughly and carefully replace oven bottom.

Delayed Self-cleaning

Self-clean feature uses high oven temperature to clean oven interior. For the oven to operate through a complete self-clean cycle, the self-clean must be set when the oven is cool.

1. Prepare oven for self-cleaning (see below left).

2. Close door.

3. Press CLEAN pad.

- The default self-clean cycle length of 3 hours will display.

4. Set cycle length for self-clean.

- Press MORE or LESS pads to adjust time as necessary before oven indicator light turns on.

- Clean cycle can be set from two to four hours in five minute increments.

- Default setting for the cycle is three hours.

5. Press STOP TIME pad.

- Press MORE or LESS pads until desired stopping time displays.

6. Oven calculates starting time based on cleaning time and stop time.

- To view remaining cleaning time, press and hold CLEAN pad.

- To view calculated stop time, press STOP TIME pad.

- DELAY displays until oven starts self-clean cycle. OVEN ON indicator light will be on during cleaning and will remain on until the end of the cycle.

- At the end of the self-clean cycle, the OVEN ON indicator light will shut off. There is no end-of-cycle beep.

- At the end of the self-clean cycle, the oven will stop heating, however, oven will remain hot.

- The LOCK indicator light will remain on until oven reaches a cooler temperature. LOCK light will flash while door is unlocking, and then shut off when door has unlocked. Oven cavity will be hot to the touch. **DO NOT** attempt to open door prior to LOCK indicator light shutting off. When oven is cool, turn oven knob to OFF.

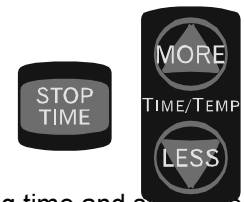
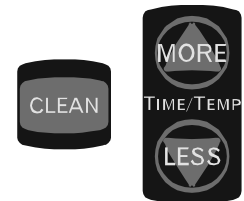

Interrupting the self-clean cycle

To stop a self-clean cycle that has already started follow these steps. If the interruption occurs mid cycle, the oven will remain locked, even though the cycle has stopped, until the oven cavity has cooled to a lower temperature.

1. Press OVEN CANCEL pad.
2. When oven has cooled to a lower temperature, LOCKED light turns off. **DO NOT** force door. This can cause damage to the latch.

Baking Guidelines

When baking with a new oven, keep in mind temperatures vary from oven to oven. Store-bought thermometers are generally not accurate and should not be used to calibrate oven temperatures.

BAKING TIME GUIDELINES

Cake Pan Type	Pan size	Cups of batter	Oven Temp.	Minutes
Oval	7 3/4" x 5 3/4"	2 1/2	350°F	25 to 30
	13" x 9 3/4"	8	350°F	25 to 30
Round, 2" layer	6"	2	350°F	25 to 30
	8"	3	350°F	30 to 35
	14"	10	350°F	50 to 55
Round, 3" layer	8"	5	325°F	60 to 65
	12"	11	325°F	75 to 80
Half Round, 2" layer	18"	9	325°F	60 to 65
Half Round, 3" layer	18"	12	325°F	60 to 65
Square	6"	2	350°F	25 to 30
	10"	6	350°F	35 to 40
	16"	15 1/2	350°F	45 to 50

- Shiny, flat cookie sheets should be used. Avoid cookie pans with high sides—this will cause uneven browning on the top.
- Cookie sheet should not touch the sides of the oven or door.
- For best results, use only one cookie sheet at a time.
- Follow recipe's directions for pan size. Shiny pans work best for cakes.
- Cake baked in too large a pan will be thin and dry. Too small a pan will be undercooked or unevenly cooked and may spill.
- Pies should be baked in dark or dull pans to increase browning.
- Frozen pies should be heated on an aluminum cookie sheet.

Bake Pan Placement

- Keep pans and baking sheets 2 inches from oven walls.
- Stagger pans placed on different racks so one is not directly over the other.

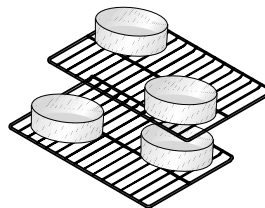

In most cases, you should preheat the oven before baking. After the range control is set, the oven temperature will begin to rise until the desired cooking temperature is reached (approximately 8 to 10 minutes). When cooking temperature is reached oven signal beeps. **For delicate baking (such as puff pastries or souffles), preheat approximately 15–20 minutes before placing food inside oven or wait 10 minutes after oven signal beeps before placing food in oven.** The extra time creates a more stable oven temperature.

BAKEWARE GUIDELINES

Dark or dull pans	Absorb more heat and result in darker browning. Recommended for pies and breads.
Shiny pans (no sides)	Recommended for cookies.
Shiny pans (sides)	Recommended for cakes
Glass pans	Lower recommended oven temperature by 25°F.

Cooking

Common Baking Problems

If you begin to notice consistent problems refer to the chart below for possible solutions. If results are still poor, contact **Amana Consumer Affairs at (800) 843-0304**.

Test your cakes for doneness.

While they are still in the oven. Because of variances across individual ovens, it is best to test for the proper consistency rather than solely relying on time and visual appearance as an indicator.

It may not be the oven.

Cake problems may be in the mixing of the batter. Overbeating can cause cake structure to break down and excessive shrinkage of the cake. Underbeating can result in lumpy cakes that may not be cooked thoroughly. All ingredients should be at room temperature—not out of the refrigerator. Make sure to follow the recipes directions for how long the batter should be mixed.

Cake stuck?

Allow cake to cool in cake pan on a rack for 10 minutes before removing. Larger cakes (over 14 inches in diameter) may take 15 minutes. If the cake has cooled too long, reheat in the oven at 250°F for a few minutes.

Make sure to follow recipe directions and use butter or margarine when it is listed. Using a low fat substitute will cause a recipe to fail.

Problem	Cause
Lopsided cakes (bake unevenly)	Pans touching each other or oven walls. Batter spread unevenly in pan. Uneven heat distribution in oven. Oven is not level.
Cakes, cookies, biscuits too brown on bottom or top	Oven not preheated. Pans touching each other or oven walls. Using glass, darkened, warped or dull finish metal pans. Rack position too high or low. Incorrect use of aluminum foil. Oven temperature too high.
Pies don't brown	Incorrect rack position. Using shiny metal pans. Temperature set too low.
Cakes not done in center	Temperature too high. Pan too small. Baking time too short. Pan not centered in oven.
Cakes fall	Too much shortening or sugar. Too much or too little liquid. Temperature too low. Old or too little baking powder. Pan too small. Oven door opened frequently (peeking). Insufficient baking.
Excessive shrinkage	Too little leavening. Mixing batter too long. Pan too large. Oven temperature too high. Baking time too long.
Cakes high in middle or cracked	Temperature set too high. Overmixing. Too much flour. Pans touching each other or oven walls.

Cooking

Meat Basics

While cooking has always been a talent, it is now becoming a science, also. Amana provides this information as a guide to aid in preparation. For specific questions regarding meat preparation, handling, or storage contact **USDA (United States Department of Agriculture) Meat & Poultry Hotline at (800) 535-4555.**

Handling Hints

- When shopping, put meat in its own separate plastic sack to keep drips off other foods.
- Defrost frozen meats in refrigerator, not at room temperature.
- Keep meat cool and covered until it is time to cook.
- Wash hands with warm soapy water before and after handling meat or raw egg.
- Thoroughly wash any surface or utensil raw meat or egg touched.
- Do not put cooked meat on the same plate that held raw meat.

Cooking Tips

- Marinate meat in the refrigerator. Throw out excess marinade that came into contact with meat.
- Use an oven-proof meat thermometer.
- Cook meat to internal temperature recommended by USDA.
- When reheating foods, heat to an internal temperature of at least 165 °F.
- While cooking meats, turn over at least once.

Storage Safety

- Once carved, refrigerate unused portion immediately.
- Keep hot foods hot and cold foods cold when serving meals.
- Separate cooked foods into small portions for fast cooling.
- Do not store cooked ground meats or meals containing ground meats for longer than 3 to 4 days in the refrigerator.
- Do not allow cooked or uncooked meat juices to come into contact with ready-to-eat foods such as fruits or vegetables.

Using a Meat Thermometer

When using a meat thermometer, remember to insert it at a slight angle, in the thickest part of the meat, away from fat and bone. The meat should be removed when 5°F below the desired final temperature. While the meat sits before carving, it will continue to cook internally, raising the last 5°F by itself.

- Take the guesswork out of cooking to a desired 'doneness'.
- Help reduce the risk of foodborne illness.

Oven-safe Thermometer

- Inserted before the meat is placed in the oven, this thermometer stays with the meat while it cooks.
- The internal temperature will rise slowly as the meat cooks.

Instant-read Thermometer

- Not oven safe, these thermometers are placed in the meat when it is removed from the oven.
- While times may vary, an accurate temperature is normally displayed within one to two minutes.
- When using an instant-read, remember to clean the thermometer stem with warm, soapy water between readings.

Tenderizing

Braising is only one way to tenderize less tender cuts. Before cooking, you may pound, cube, marinate, or use commercially prepared meat tenderizers. You may then use a dry method to cook the meat.

- **Marinades** are acidic liquids such as wine, citrus, or vinegar. Marinades soften meat fibers but only penetrate about one-fourth of an inch into the interior of the meat. Do not marinate meat for longer than 24 hours.
- **Pounding** with a heavy meat mallet breaks down the connective tissue to tenderize meat.
- **Cubing** breaks down the structure more than pounding. Cubing is done at the meat counter.
- **Commercial tenderizers** are primarily enzymes that work on the outer fourth inch on a meat cut. Make sure to follow the manufacturer's directions.

Broiling

Broiling Guidelines

Broiling is a dry heat cooking method that allows a restaurant quality finish and flavor. Meat is exposed directly to the heating element at high temperatures.

Place meat on rack in broiler pan, with the surface of cuts the specified distance from the heating element (specified below).
Broil for half the recommended time, or until the surface is browned. Turn meat and continue broiling to desired internal temperature.
Broil to desired doneness.

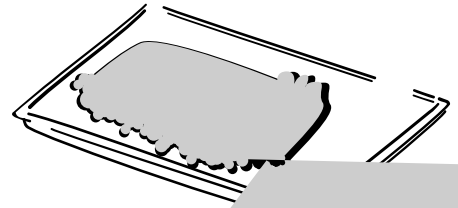

Cooking

Roasting Guidelines

Tender cuts such as rib and loin cuts are best cooked by dry heat methods, such as roasting. To roast:

1. Heat oven to desired temperature.
2. Place roast directly from refrigerator fat side up in a shallow roasting pan.
3. Insert ovenproof meat thermometer so tip is centered in thickest part of roast. Make sure thermometer does not rest in fat or on bone.
4. Remove roast 5°F below desired degree of finished internal temperature.
5. Transfer roast to carving board and tent loosely with aluminum foil for approximately 15 minutes.

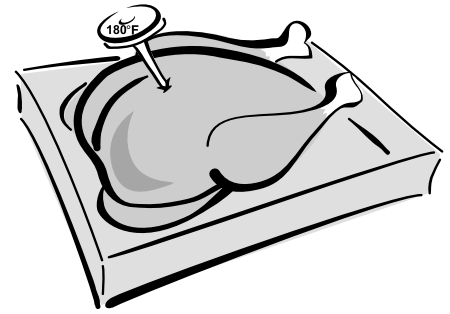

Meat Cut	Recommended Internal Temperature	Oven Temperature	Weight (pounds)	Approximate Cooking Time (minutes)
----------	----------------------------------	------------------	-----------------	------------------------------------

BEEF

Meat Cut	Recommended Internal Temperature	Oven Temperature	Weight (pounds)	Approximate Cooking Time (minutes)
Boneless Rump Roast		325°F	4 to 6	25 to 30
Tip Roast	Very Rare 130°F	325°F	3 ½ to 4	30 to 40
Eye Round Roast	Rare 140°F	325°F	4 to 6	20 to 30
Tenderloin Roast	Medium Rare 145°F	425°F	2 to 3	35 to 45
	Medium 160°F		4 to 6	45 to 60
Rib Roast	Well Done 170°F	325°F	4 to 6	26 to 42
	Very Well Done 180°F		6 to 8	23 to 35
Rib Eye Roast		350°F	4 to 6	18 to 24

PORK

Meat Cut	Recommended Internal Temperature	Oven Temperature	Weight (pounds)	Approximate Cooking Time (minutes)
Loin Roast, bone-in	All pork must be cooked to an internal temperature of at least 160°F to reduce the likelihood of Trichinosis and other food-borne illnesses.	350°F	3 to 5	20 minutes per pound
Rib Roast, boneless		350°F	2 to 4	
Tenderloin		450°F	½ to 1	
Ham bone-in, cook-before-eating		325°F	7 to 8	

LAMB

Meat Cut	Recommended Internal Temperature	Oven Temperature	Weight (pounds)	Approximate Cooking Time (minutes)
Shoulder		325°F	3 ½ to 6	35 to 40
Rib Roast	Medium-Rare 150°F Medium 160°F Well Done 170°F	375°F	1 ½ – 2 ½	30 to 35
Rib Crown Roast, not stuffed		375°F	2 to 3	25 to 30
Loin Roast		325°F	1 ¼ to 1 ¾	45 to 55
Leg, Frenched Style or Half Shank		325°F	5 to 7 7 to 9	15 to 20 20 to 25

POULTRY (unstuffed)

Meat Cut	Recommended Internal Temperature	Oven Temperature	Weight (pounds)	Approximate Cooking Time (minutes)
Capon	To reduce the risk of food-borne illnesses, poultry must be cooked to an internal temperature of 180°F.	325 to 350°F	4 to 8	20 to 30 min/lb.
Cornish Hens, whole		325 to 350°F	1 ¼ to 1 ½	50 to 60 total
Duck, whole		325 to 350°F	—	18-20 min/lb.
Goose, whole		325 to 350°F	—	20 to 25 min/lb.
Pheasant, whole		325 to 350°F	2	30 min/lb.
Quail, whole		325 to 350°F	—	20 minutes total
Turkey		325°F	8 to 16	3 ½ to 5 ½ hours

All times and recommended temperatures are provided by the USDA, the Beef Industry Council, the National Pork Producer's Council, and the American Sheep Industry Council.

Cooking

Braising Guidelines

Less tender cuts such as those from the round, chuck, brisket and shank require moist cooking. A longer cooking time at lower temperatures with moisture helps soften the meat.

1. Brown meat with a small amount of oil in heavy pan.
2. Pour off excessive drippings, season, if desired.
3. Add small amount of liquid (1/2 to 2 cups) and cover tightly.
 - Simmer gently over low heat on top of the range or in a 325°F oven, until meat is fork tender.

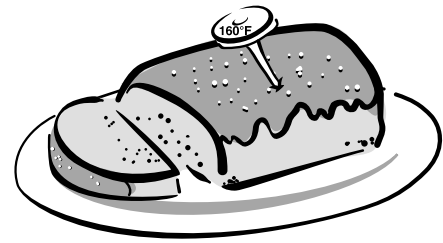

Meat Cut	Recommended Internal Temperature	Oven Temperature	Weight (pounds) OR Thickness	Approximate Cooking Time (hours)
BEEF				
Blade Pot Roast	Meat should be cooked to a temperature of at least 160°F to reduce the likelihood of food-borne illnesses.	325°F	3 to 5	1 ½ to 2
Arm Pot Roast		325°F	3 to 5	2 to 3
Chuck Roast (boneless)		325°F	3 to 5	2 to 3
Short Ribs		325°F	2 inches x 2 inches x 4 inches thick	1 ½ to 2 ½
Round Steak		325°F	¾ to 1 inch thick	1 to 1 ½
Flank Steak		325°F	1 ½ to 2 inches thick	1 ½ to 2 ½
LAMB				
Shoulder Chops, Round Bone or Blade	Meat should be cooked to a temperature of at least 160°F to reduce the likelihood of food-borne illnesses.	325°F	1 inch thick	1 to 1 ¼
Riblets		325°F	3 pounds	1 ½ to 2
Shanks		325°F	3 pounds	1 to 1 ½
Stew Cubes		325°F	1 inch pieces 1 ¼ lbs.	1 ¼ to 1 ½

All times and recommended temperatures are provided by the USDA, the Beef Industry Council, the National Pork Producer's Council, and the American Sheep Industry Council.

Care and Cleaning



CAUTION

To avoid personal injury or property damage, handle oven door with care.

- Do not lift door by handle.
- Remove storage drawer.
- Door is heavy and can be damaged if dropped.
- Screwdriver can scrape or chip range or oven finish.
- Do not scratch or chip glass or twist door. Glass may break suddenly.

Removing Oven Door

1. Open door fully.
2. Remove screws on side of oven door (one on each side).
 - Oven doors are attached with a screw on each side of lower oven door.
3. Close door to the first stop.
4. Grasp door firmly on each side and lift upward until door is off hinges.
 - Do not lift door by handle. Glass can break.
 - Only push hinges closed once oven door is removed if necessary. Use both hands when closing hinge. Hinge snaps closed.

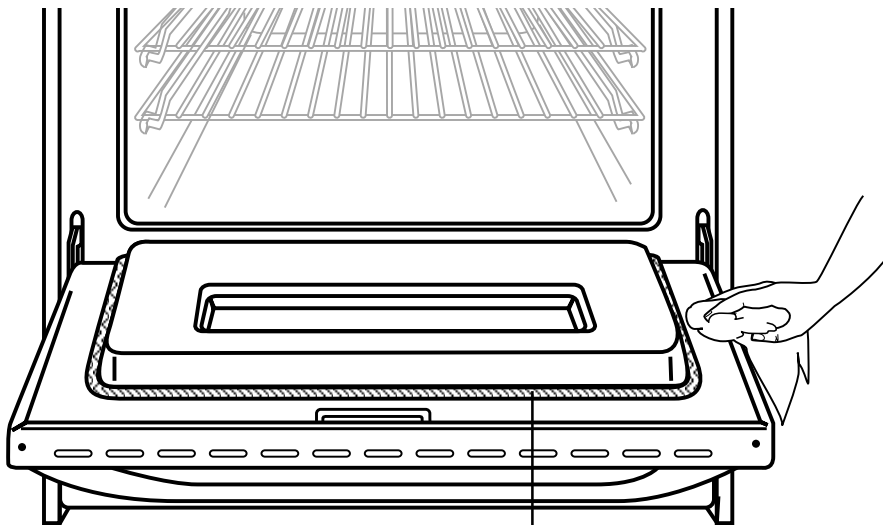
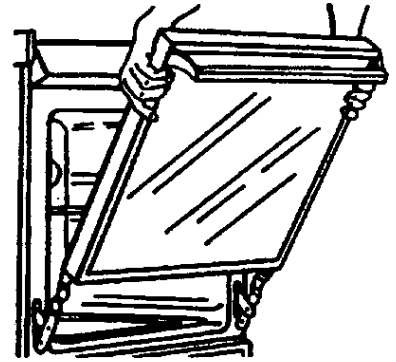

door gasket

Cleaning Oven Door

Not all areas of the oven are cleaned by the self-clean cycle. The oven door, the gasket and area surrounding the gasket will not be cleaned effectively by the self-clean cycle. **DO NOT** use spray cleaners to clean the outside or inside of the oven door. Cleaner will streak the inner window area.

DO NOT clean the gasket. Do not wet, rub, soak or use any type of cleaning material to clean the oven gasket. Any damage or defects occurring from attempting to clean or remove the gasket are not covered by warranty.

To clean the area around the gasket make sure oven is cool to the touch. Using a cloth with a mild soap wipe area needing to be cleaned. Avoid gasket. Gasket should not be removed while cleaning. Do not allow water or cleaning solution to spill or drip onto gasket.

Removing Storage Drawer

1. Slide drawer out until it stops.
2. Remove stored items.
3. Grasp drawer sides near back of drawer.
4. Lift up and out. Reverse to reinstall.

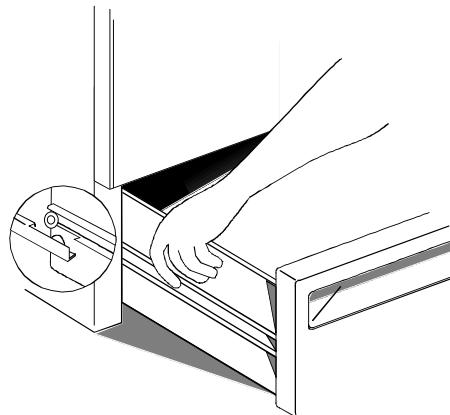

Care and Cleaning

CAUTION

Avoid risk of personal injury, wear gloves to protect hands from accidental bulb breakage.





WARNING

Avoid risk of burns or electrical shock:
Disconnect electrical supply to oven before changing light bulb.
Before replacing light bulb make sure oven and bulb are cool.
Do not operate oven without bulb and cover in place.

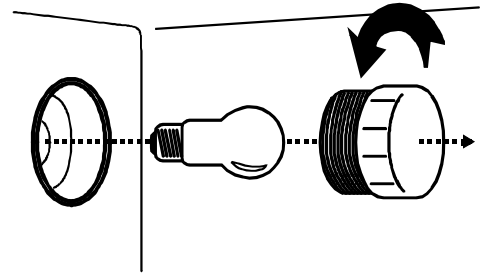
Replacing Oven Light

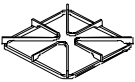
1. Disconnect electrical supply.
2. Remove oven door if desired.
3. While wearing protective gloves, unscrew counter clockwise the light bulb cover located in rear of oven cavity. Then turn light bulb counterclockwise to remove.
4. Replace light bulb with 120-volt, 40-watt appliance bulb. **Do not over tighten bulb or cover or they may be difficult to remove later.**
5. Replace light bulb cover and oven door before use.
6. Reconnect power supply.



PART	GENERAL DIRECTIONS
Burner caps and grates 	<p>Cool before cleaning. Frequent cleaning with soap and water and a non abrasive pad prolongs time between deep cleanings. Be sure to dry thoroughly.</p> <p>For deep cleaning, place burner caps and grates in plastic bag with ½ cup ammonia. DO NOT pour ammonia into bag or allow ammonia to touch grates or caps. Close bag tightly and allow to sit overnight. Open bag pointed away from face to avoid fumes. Remove grates and caps and wash normally.</p>
Burner base	<p>Allow to cool. Clean with warm soapy water and a clean cloth. If ports are clogged, clean with a toothbrush or a straight pin. Do not use a toothpick. Replace burner caps and turn on burners to check for proper operation.</p>
Electrode	<p>Cool and remove burner grates and caps. Clean area around ceramic electrode with non-metallic utensil such as plastic pick, plastic straw or old toothbrush. Be sure there is no debris, burned fragments, or grease that may divert the spark or cause poor ignition. Do not pry on ceramic electrode</p>
Boiler pan and grid 	<p>Drain fat, cool pan and grid slightly. (Do not stand soiled pan and grid in oven to cool.) Sprinkle with soap. Fill the pan with warm water. Let pan and grid stand for a few minutes</p>
Control knobs 	<p>Pull off knobs. Wash gently with mild soap and water but do not soak. Dry and return knobs to oven, making sure to match flat area on the knob to the flat area on the shaft.</p>
Stove finish 	<p>Wash all glass with cloth dampened in soapy water. Rinse and polish with a dry cloth. If knobs are removed, do not allow water to run down inside surface while cleaning.</p>
Oven racks	<p>For heavy soil, place oven racks in large plastic bag with ammonia and water in cup. Seal tightly and allow to stand overnight. Wash and rinse, dry thoroughly.</p>
Oven door	<p>For heavy soil, clean by hand and rinse thoroughly. Remove drawer for ease in cleaning. Be sure drawer is dry before replacing.</p>

Care and Cleaning

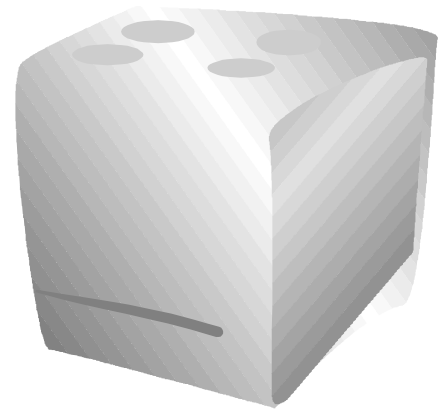

For best cleaning results

1. Wash surfaces with warm soapy water and a soft, clean cloth or sponge.
2. Rinse surfaces with warm water. Dry surfaces with a soft, clean cloth.
DO NOT use the following harsh cleaners:
 - abrasive or acidic cleaners (ammonia, chlorine bleach, vinegar-based product, etc.)
 - citrus-based cleaners
 - scouring pads (metal, textured plastic, etc.)

These items can scratch, discolor, or permanently tarnish surfaces.

3. Follow up rinsing by immediately drying with a soft, clean cloth. This will avoid water spotting on stainless steel finish.



Can I use liquid cleaners on my stainless steel?

Just because a cleaner is a liquid does not mean it is non-abrasive. Many liquid cleansers designed to be gentle on tile and smooth surfaces still damage stainless steel. Cosmetic damage from using non-recommended products is not covered under warranty.



Citric Acid

Citric acid permanently discolors stainless steel. To prevent damage to the finish of your stainless steel appliance, do not allow these substances to remain on the steel finish:

- mustard
- tomato juice
- marinara sauce
- citrus based sauces
- citrus based products



Questions? Comments?
Concerns? Contact us!

www.amana.com

or call Consumer Affairs at
1-800-843-0304

Troubleshooting

You may save time and money by checking items below before calling for service. List includes common concerns that are not the result of defective workmanship or materials. If your question is not explained below, contact Amana Consumer Affairs Department at **800-843-0304**.

Topic	Possible Cause	Solution
-------	----------------	----------

OPERATION

Appliance not working	Power outage	Make sure appliance is plugged in. Verify that circuit breaker is not tripped. Replace household fuse but do not change fuse capacity.
	Oven door locked	Allow oven to cool for automatic lock to disengage. Once oven has unlocked, set oven to desired temperature.
Self clean shuts off during cycle	Using surface burners during self clean cycle	Surface burners should not be used during a self clean cycle. Set self clean cycle to delay when range does not need to be used.
Surface burner does not ignite	Poor cap placement	Turn control to OFF and follow directions in Placing Burner Cap section.
	Dirt or debris on electrode	Turn control to OFF and follow directions in Care and Cleaning section.
Broil cycle stops	Oven door open	Oven door must be closed during a broil cycle. Close oven door and broil cycle should resume normally.
Clock and timer not working	Power outage	Make sure appliance is plugged in. Verify that circuit breaker is not tripped. Replace fuse but do not change fuse capacity.
Oven light not working	Loose bulb	Check for loose bulb. Tighten.
	Burnt out bulb	Check for burnt out bulb. Replace if necessary with an appliance bulb.
Oven door will not unlock	Oven is self-cleaning	Allow cycle to complete or cancel function.
	Oven still hot	Will not unlatch until a certain cooler temperature has been reached. Do not force door open—will void warranty. May blow cooler air on latch with hair dryer at cool setting to quicken process.
Oven not clean after a self clean cycle	Too much soil, grime left in oven	Wipe out and remove excess soil prior to running self-clean cycle.
	Soot remains in oven after cycle	Normal. Wipe out with damp cloth.
Pans rock on surface burner grates	Warped pans	See Utensil section to check pan for flat bottom.
Locked light displayed	Door locked	If oven is hot, allow to cool rather than trying to force door open.
Display flashing	Power failure reset clock	Press CLOCK.
F-(numeric) display	Service code	Shut off power to oven for three minutes by switching off circuit breaker. Reset breaker. If continues, contact service department.
Oven smokes the first few times used	Normal	Minor smoking is normal the first few times the oven is used.

Troubleshooting

COOKING

Food not baking properly	Various causes	See <i>Cooking, Common Baking Problems</i>
Food not roasting properly	Various causes	See <i>Cooking, Roasting</i>
Food not broiling properly	Various causes	See <i>Cooking, Broiling</i>
Oven temperature too hot or cold	Calibrate oven temperature	See <i>Using the Oven Control, Oven Temperature Control Adjustment</i>
Oven has strong odor	Normal	Ovens will have a 'new' odor. Run a self-clean cycle to remove the odor.
Not boiling or cooking fast enough	Improperly sized cooking utensils	Make sure pans fit heating elements. See <i>Cookware Requirements</i> .

NOISE

Frequent cycling off and on of oven.	Normal	To maintain a temperature for baking, the oven cycles on and off.
Surface burners all click at once.	Normal	Ignitor sparks all burners when lighting a surface burner.
Cracking or popping sound	Normal	Wet cooking utensils or possible spillage. Expansion or contraction of oven during heating cycle. May be louder when using LP/Propane.

Amana Warranty

Full ONE Year Warranty

Amana Appliances will repair or replace, including related labor and travel, any part (f.o.b. Amana Iowa) which proves defective as to workmanship or materials.

Limited Warranty

After one year from the date of original retail purchase, Amana will provide a free part, as listed below, to replace any part that fails due to a defect in materials or workmanship. The owner will be responsible for paying all other costs including labor, mileage, and transportation.

Second through Fifth Year

Amana will provide replacement gas surface burners, part only (f.o.b. Amana Iowa) which prove defective as to workmanship or materials.

What is not covered by these warranties

- Replacement of household fuses, resetting of circuit breakers, or correction to household wiring or plumbing.
- Normal product maintenance and cleaning, including light bulbs.
- Products with original serial numbers removed, altered, or not readily determined.
- Products purchased for commercial, industrial, rental, or leased use.
- Products located outside of the United States or Canada.
- Premium service charges, if the servicer is requested to perform service in addition to normal service or outside normal service hours or area.
- Adjustments after the first year.
- Repairs resulting from the following:
 - Improper installation, exhaust system, or maintenance.
 - Any modification, alteration, or adjustment not authorized by Amana.
 - Accident, misuse, abuse, fire, flood, or acts of nature.
 - Connections to improper electrical current, voltage supply, or gas supply.
 - Use of improper pans, containers, or accessories that cause damage to the product.

To Receive Warranty Service

Service must be performed by an authorized Amana service representative. To schedule service, contact the Amana dealer where you purchased your appliance or contact Amana Appliances Factory Service.

Amana Appliances Factory Service

1-800-628-5782 inside USA

For more information, Amana Appliances Consumer Services

Amana Appliances

2800 220th Trail

Amana, Iowa 52204

1-800-843-0304 inside USA

(319) 622-5511 worldwide

When contacting Amana Appliances please include the following information:

- Your name, address, and telephone number.
- Model number and serial number of your appliance (found on upper left hand corner of storage drawer opening).
- The name and address of your dealer and the date of purchase.
- A clear description of the problem.
- Proof of purchase (sales receipt).

IN NO EVENT SHALL AMANA BE LIABLE FOR INCIDENTAL OR CONSEQUENTIAL DAMAGES.

This warranty gives you specific legal rights, and you may have others which vary from state to state. For example, some states do not allow the exclusion or limitation of incidental or consequential damages, so this exclusion may not apply to you.

Amana Appliances Online • <http://www.amana.com>

Free Manuals Download Website

<http://myh66.com>

<http://usermanuals.us>

<http://www.somanuals.com>

<http://www.4manuals.cc>

<http://www.manual-lib.com>

<http://www.404manual.com>

<http://www.luxmanual.com>

<http://aubethermostatmanual.com>

Golf course search by state

<http://golfingnear.com>

Email search by domain

<http://emailbydomain.com>

Auto manuals search

<http://auto.somanuals.com>

TV manuals search

<http://tv.somanuals.com>