

PT A1069211

Welcome to
the Amana family

J

36071
36078
36551
36558

SX22J
SX25J
SKI20J
SBI20J
SL22J
SC25J

Amana

Side-By-Side Refrigerator

Use & Care Manual

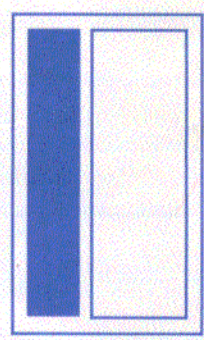

Amana 19
Amana 20
Amana 22
Amana 25

Welcome to the Amana Family

Your purchase of an Amana refrigerator/freezer — a household appliance known for its quality and reliability — is sincerely appreciated by Amana Refrigeration, Inc. Your total satisfaction with this new product is extremely important to us, and this Use and Care Manual will aid you in understanding the operation of your new appliance.

Each product is thoroughly tested and checked at the factory. Once in your home, you may want to make a few simple adjustments of control settings, etc., to tailor your new unit to your own individual requirements. These adjustments are easily made following the instruction in this manual.

Should your new unit ever require service, certain product information will aid in obtaining service faster! For your convenience and protection, please record this information in the box at right and retain this booklet for future reference.

The Registration Card in the packet with the manual should be filled out and returned to Amana Refrigeration, Inc.

Record in the space below the information found on the nameplate of your refrigerator. The nameplate is located in the upper left hand corner of the refrigerator section. Also, please retain a copy of your sales receipt for future reference should warranty service be needed.

Serial No. _____

Model No. _____

Manufacturing No. _____

Date of Purchase _____

Selling Dealer _____

WARNING

Electrical Grounding Instructions—This appliance is equipped with a three-prong (grounding) plug for your protection against possible shock hazards. Where a two-prong wall receptacle is encountered, it is the personal responsibility and obligation of the customer to contact a qualified electrician and have it replaced with a properly grounded three-prong wall receptacle in accordance with the National Electrical Code (see figure.)

Unit is designed to operate on a separate 103 to 126 V.A.C., 15 amp., 60 cycle line.

DO NOT UNDER ANY CIRCUMSTANCES CUT OR REMOVE THE ROUND GROUNDING PRONG FROM THE PLUG. THE UNIT MUST BE GROUNDED AT ALL TIMES. DO NOT REMOVE WARNING TAG FROM THE SERVICE CORD.

WARNING

**DO NOT USE A TWO-PRONG ADAPTER.
DO NOT USE AN EXTENSION CORD.**

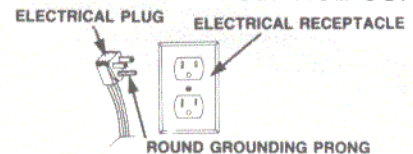

Contents	Page	Contents	Page
Electrical Warning	2	Freezer Features	11
Unpacking and Dimensions	3	Other Features	12
Door Handle and Assembly		Sounds	13
Removal	3	Care and Cleaning	14
Placement, Leveling and		Save Energy	17
Door Alignment	4	Non-Use Period	16
General Features	6	Before Calling For Service	18
Setting the Controls	7	Amana Assure	19
Refrigerator Features	8	Amana Toll-Free	19

Unpacking and Dimensions

CAUTION:

To Avoid The Risk Of Personal Injury use caution in unpacking, handling, removing, installing and cleaning all parts of product which may have sharp edges.

CAUTION:

To Avoid The Risk Of Personal Injury wear protective hand covering.

Remove all tape and packing material. To remove tape residue, touch a portion of the tape to the residue and lift it off. If adhesive residue still remains, try cleaning the sticky area with a clean cloth soaked in mild dish washing soap. Wipe area clean. If the wood base is still attached, have someone help you tilt the unit onto its back, placing a sturdy support underneath. Remove the mounting bolts from the base and discard bolts and wood base.

IMPORTANT! Do not leave the cabinet on its back longer than it takes to remove the wooden base and do not connect the power cord until after all the inside packing has

been removed and the cabinet has been leveled for proper operation.

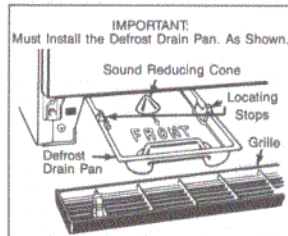

Model	Location of the Defrost Drain Pan
19	Leftside (As Shown)
20	
22	Rightside (Opposite)
25	

With the unit upright, pull the grille from the bottom front and make sure the defrost drain pan is located underneath the defrost water drain tube. Two drain pan side supports (attached to the cabinet bottom) keep the pan in the proper location, to make the automatic defrost drain water drop on the sound reducing cone. The drain pan locating stops - prevent the pan from being installed backwards.

Remove all tape and packing material from inside the unit.

SPECIAL NOTE: If cabinet is unable to fit through doorway safely, you may have to remove the door handles, or door assemblies. Refer to the following chart and diagrams.

Dimensions

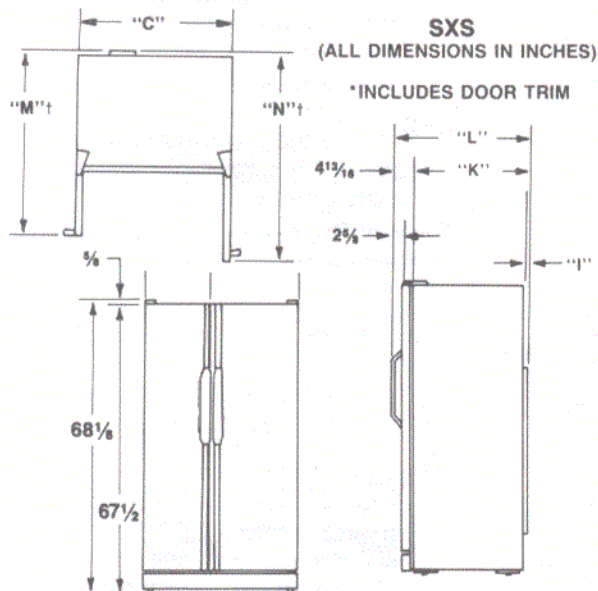

MODEL	"C" CABINET WIDTH	"I" OC BACK	"K" OC BACK TO CAB FRONT	"L" OC BACK TO HANDLE	"M" FRZ DOOR OPEN 90°	"N" REF. DOOR OPEN 90°
19	32	1	27	31 $\frac{1}{8}$	43	44 $\frac{1}{8}$
20	35 $\frac{1}{4}$	—	23 $\frac{1}{2}$	28 $\frac{3}{8}$	39 $\frac{3}{8}$	45 $\frac{1}{4}$
22	35 $\frac{1}{4}$	—	26	30 $\frac{3}{8}$	42 $\frac{3}{8}$	47 $\frac{3}{8}$
25	35 $\frac{1}{4}$	—	28 $\frac{3}{8}$	33 $\frac{3}{8}$	44 $\frac{3}{8}$	50 $\frac{1}{2}$

†Must be installed from side walls for 90° door opening.

*Outer Case

Door Handle and Door Assembly Removal

To Remove The Door Handles (WITHOUT FACTORY INSTALLED DECORATOR PANELS.)

Tools Required: Tightly fitted gloves, putty knife, and $\frac{5}{16}$ " hex nut driver.

1. First remove the upper and lower door handle trim from both doors. See Figure 1.

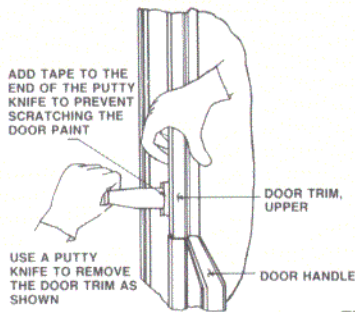

FIGURE 1

2. Remove the upper and lower door handle screws. See Figure 2.

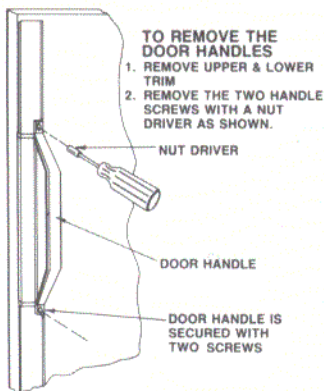

FIGURE 2

To Remove Door Handles With Factory Installed Decorator Panels

1. Loosen the upper and lower door handle trim and rotate 90°. See Figure 3.

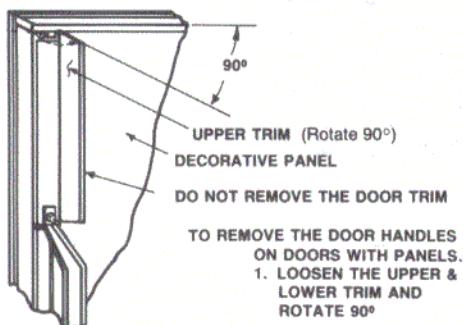

FIGURE 3

2. Remove the upper and lower door handle screws. See Figure 4.

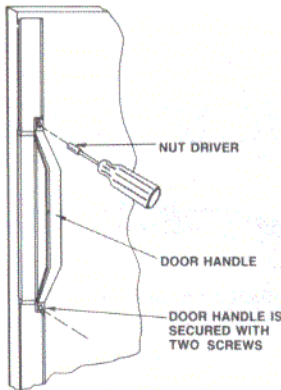

FIGURE 4

3. Rotate the trim back in place to move the cabinet through the doorway.

To Remove The Door Assemblies (Do not remove the door handles)

Tools Needed: Tape, tightly fitted gloves, $\frac{5}{16}$ " hex nut driver, pencil, $\frac{3}{8}$ " drive ratch, $\frac{3}{8}$ " hex socket.

- 1.

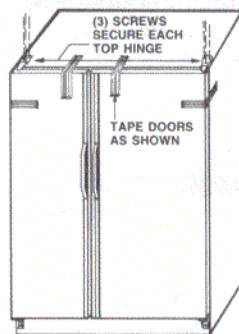
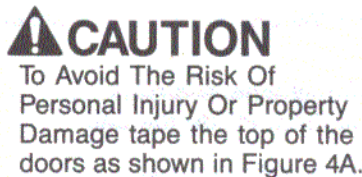

FIGURE 4A

2. To remove top hinge covers follow the instructions below:
 - a. Lift the back of the hinge cover about $\frac{1}{4}$ ", then
 - b. Slide the hinge cover toward the front and off hinge. See Figure 5.

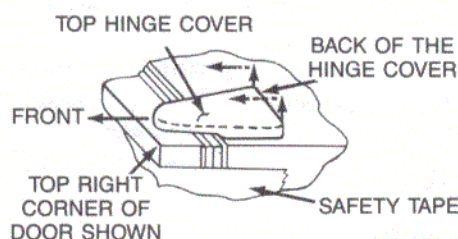

FIGURE 5

CAUTION

To Avoid The Risk Of Personal Injury Or Property Damage have two (2) people remove the door. One to hold the door and one to remove the safety tape and help with tools.

3. To assure proper door realignment, draw a pencilled outline of both top hinges on cabinet. See Figure 5A.

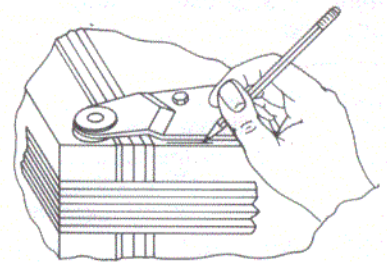

FIGURE 5A

4. Remove the upper door hinges, (3) screws per upper hinge.

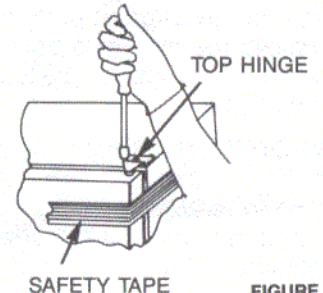
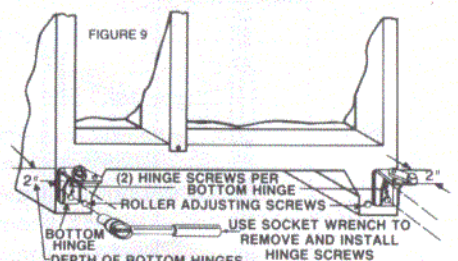

FIGURE 6

5. Remove the door assemblies by lifting off the bottom hinge pins. Note: At this point the refrigerator may go through the doorway. If not proceed to steps 6 and 7.
6. To assure proper door realignment, draw a pencilled outline around the lower hinge brackets.
7. Remove the lower hinge bracket screws. (2) screws per lower hinge. See Figure 7.
8. Reverse order to install the door assemblies.



TO REMOVE THE BOTTOM HINGE BRACKETS, REMOVE (2) SCREWS PER HINGE BRACKET AS SHOWN

FIGURE 7

Placement, Door Alignment and Leveling

Placement of 20 Cu. Ft. Models

On most counter tops there is a 1" overhang. If this is the case, the front corners of the counter top must be trimmed off at a 45° angle for the refrigerator and freezer door clearance. See Figure 8.

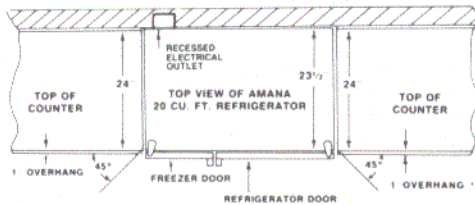

FIGURE 8

CAUTION

To Avoid Property Damage to soft vinyl flooring follow floor products manufacturer's recommendations when installing or moving the refrigerators.

A recessed electrical outlet installed on the back wall allows for built-in installation of your refrigerator. The suggested height requirement for the recessed electrical outlet is 3 to 4 feet from floor.

Leveling

Install the unit on a solid floor that is strong enough to support the combined weight of the unit, approximately 320 lbs.; and the food, maximum of 625 lbs. with an approximate combined weight of 945 lbs.

The unit must be level to insure complete door closings and proper ice making. Improper leveling will cause water spills and uneven ice cube size.

The unit must be level from side to side with a slight downward tilt from front to back. This allows doors to close firmly. If the floor is uneven

from side to side, place thin metal plates under one of the rear wheels. Adjust the front wheels or leveling feet to obtain the front-to-back tilt. To raise, turn screw or leveling feet clockwise. To lower, turn counterclockwise.

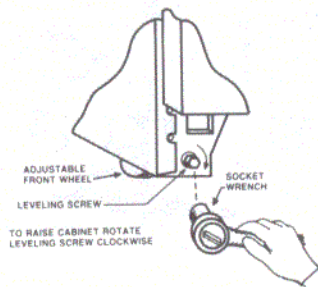

Door Alignment

The doors on this refrigerator were aligned at the factory. Once the refrigerator is properly leveled, the doors will be aligned. If further adjustment is required, please follow the steps below.

1. Before checking alignment, open and close both doors to insure they are resting on the bottom bearings.
2. Check alignment of doors at TOP CENTER. See Figure 9A. If doors are aligned, go to step 4.

3. If doors are not aligned:
 - A. Lower the front roller (turn the screw clockwise one turn at a time) on the side of the refrigerator which has the lower door. See Figure 9.
 - B. Open and close both doors.
 - C. Recheck alignment.
 - D. If doors are not aligned repeat steps A through C.
4. If one of the front rollers is not touching the floor (refrigerator will rock), lower that roller only enough to contact the floor.

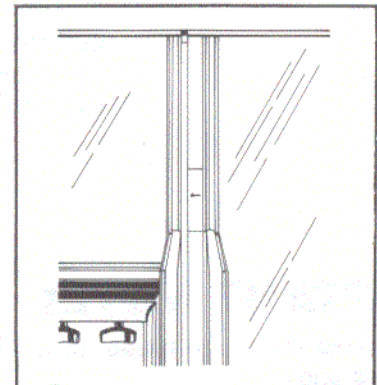
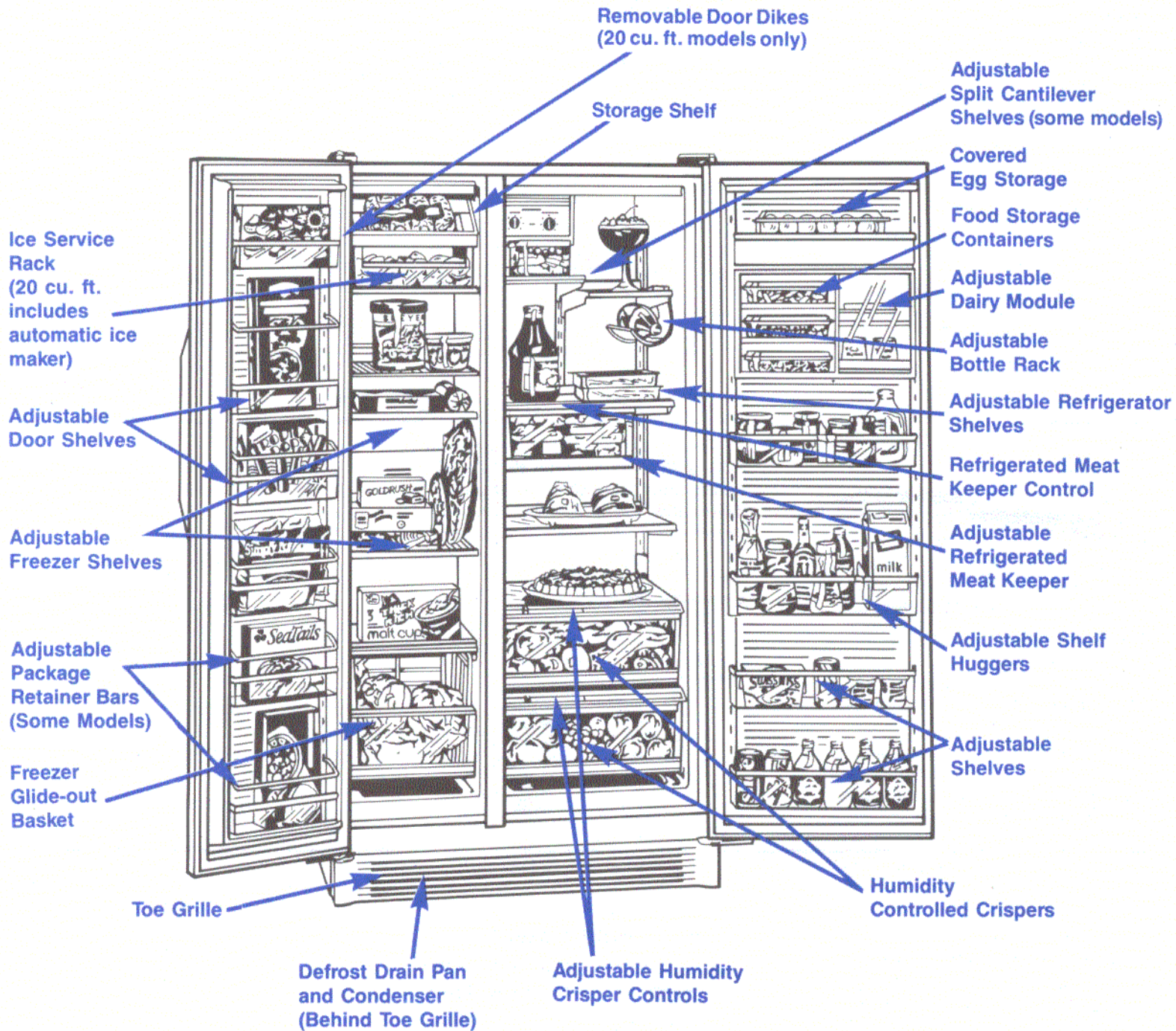

FIGURE 9A

General Features



IMPORTANT NOTE:

* Features may vary from model to model. Your refrigerator may not have all of the features shown.

Setting the Controls

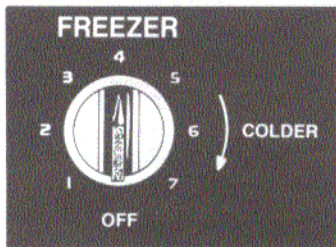

FIGURE 10

Freezer Control

This is the main control located on the upper back wall of the fresh food section. See Figure 10. If it is turned OFF, neither the Freezer nor

the Refrigerator will cool. All of the electrical circuits remain energized except for the compressor and fan motors. The control has seven settings, from "1" (the warmest) to "7" (the coldest). Start by setting the dial on "4". Load food in freezer. Allow 24 hours for freezer to cool after unit is installed, before checking food temperatures.

Check **FOOD** temperature as instructed on page 7. **Adjust the control as needed one number at a time.** The best temperature for frozen food storage is in the 0° to +2°F range.

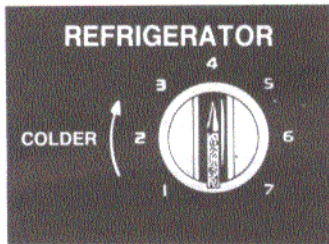

FIGURE 11

Temp-Assure™ Thermostatic Refrigerator Control

This control located on the upper back wall of the fresh food section, operates independently of the freezer control only if the freezer control is turned on. See Figure 11. A hidden thermostatic sensor

measures refrigerator air temperature constantly, and automatically lets in more cold air if temperature rises as little as 1½°F from your setting.

The control has seven settings, from "1" (the warmest) to "7" (the coldest). The best food storage temperature is in the 38° to 40°F range. Start by setting the dial on 4. Load food in the refrigerator. Place a glass of water in the middle of the refrigerator section, making sure air can flow around it. (This will be used later to check food temperature.) Allow 24 hours for the refrigerator to cool after unit is installed. Check food temperature as instructed on the next page.

Checking Food Temperature

Twenty-four hours after the unit is installed, check the food temperature in the refrigerator and freezer sections. Use a quality thermometer that can register below-zero temperatures.

FREEZER: Place the thermometer in the center of the freezer, surrounded by frozen packages. See Figure 12. Wait 5 to 8 hours, then check the reading. If temperature is not within 0° to +2°F, adjust control as needed, one number at a time and check the temperature again after 4 to 6 hours.

REFRIGERATOR: Place the thermometer in a glass of water and place the glass in the middle of the refrigerator section. See Figure 13.

Be sure air can flow around it. Wait 3 to 4 hours, check the temperature and adjust the control one number at a time as needed to within the 38° to 40°F range. Wait 3 to 4 hours and check the temperature again.

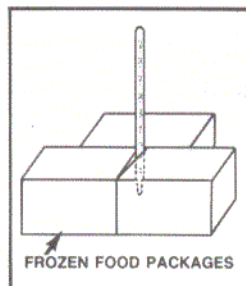

FIGURE 12

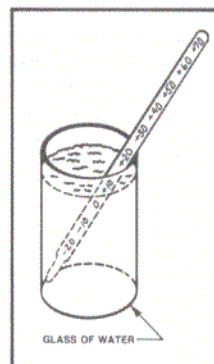

FIGURE 13

Refrigerator Features

Energy Saver Control

The 2-Position Energy Saver Control lets you save energy by adjusting refrigerator operation to the levels of humidity in your house. See Figure 14. During hot, humid weather, any refrigerator/freezer will form moisture around the doors, similar to the way condensate forms on a glass of ice water. The cabinet has special heaters to minimize this condensation. The Energy Saver Control lets you turn these heaters on or off.

The upper position is for periods of high humidity.

The lower position turns the heaters off for maximum energy savings. Use for periods of low humidity.

A minimum amount of condensation is normal. During extreme high humidity, condensate may also form on the cabinet sides and doors.

This is normal and will disappear when climatic conditions return to normal.

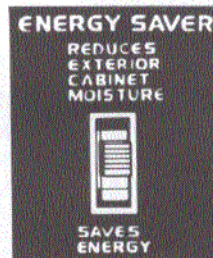

FIGURE 14

Refrigerated Meat Keeper Control (Some Models)

The Refrigerated Meat Keeper features a drawer inside a wrapper or sleeve. A control, located in the front trim, allows you to adjust the amount of freezer air that circulates between the drawer and sleeve to keep meat extra fresh without drying it out. See Figure 15. Slide the control to the left for the coldest temperatures and to the right for warmer temperatures. The additional cold air can affect the refrigerator compartment temperature, so the Temp-Assure™ thermostatic control

may require adjustment after the Meat Keeper temperature has been set.

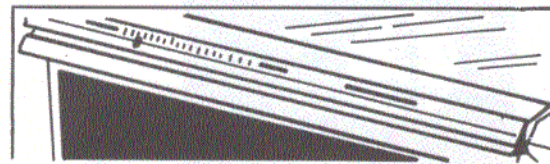

FIGURE 15

Adjustable Cantilever Glass Shelves

These shelves attach to metal tracks at the back of the interior. See Figure 16. To remove, tap upwards at rear of shelf near the tracks to loosen shelf hooks. Lift shelf and pull out. To install, tilt shelf and engage upper hooks in desired track slots. Lower shelf front and tap downwards near the tracks until shelf hooks are securely seated and shelf is level.

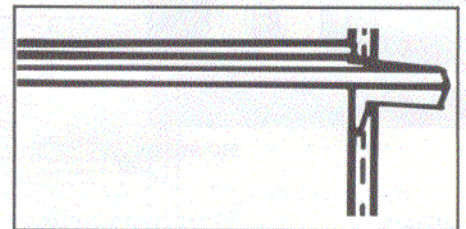

FIGURE 16

CAUTION

To Avoid Personal Injury Or Property Damage test for proper installation by exerting some pressure downward on the front edge — shelf should not move.

Refrigerator Features (cont.)

To Adjust The Refrigerated Meat Storage Drawer

The Refrigerated Meat Keeper must be installed with its cold air supply tube covering the air inlet port completely. To ensure proper alignment, only insert the upper hooks of the shelf into the 9th, 10th, 11th or 12th track slots from the top. See Figure 17. Otherwise food will freeze below the uncovered air supply hole, located in the back left side wall.

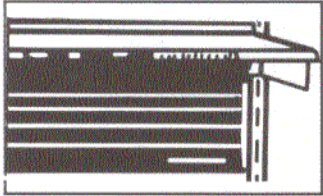

FIGURE 17

Humidity Controlled Crisper Drawers

These drawers are for storage of fresh fruits and vegetables. It is normal for moisture to accumulate inside. See Figure 17A.

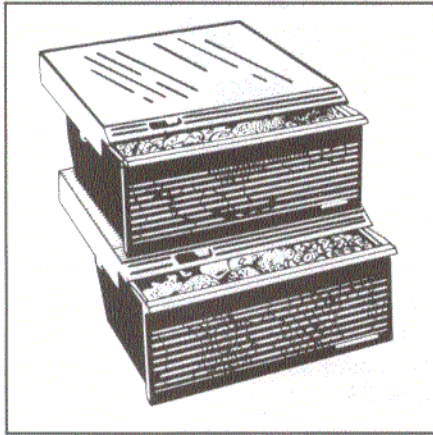

FIGURE 17A

Crisper Drawers can be pulled out fully, even when door is opened at a 90° angle. See Figure 18.

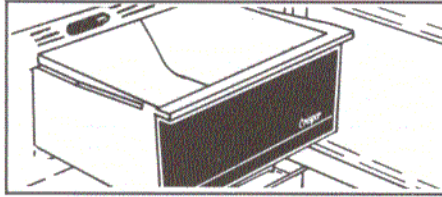

FIGURE 18

Hi-Humidity Drawers have a control to regulate humidity inside. Set high humidity for leafy vegetables such as cabbage and lettuce, and set low humidity for produce with skins such as apples and tomatoes. On models with humidity control, slide control to the left for high humidity and to the right for low humidity. See Figure 19.

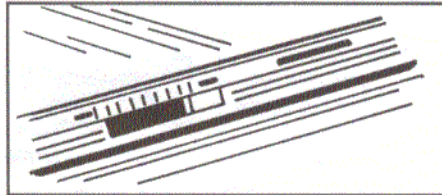

FIGURE 19

Refrigerator Features (cont.)

Stor-Mor® Door

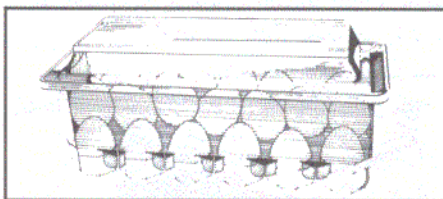

FIGURE 20

Egg Storage. A removable take-to-counter egg bucket stores eggs in a see-thru covered container. See Figure 20. To clean, hand wash in warm, soapy water.

Dairy Storage. On 20, 22 and 25 cubic foot models, store butter and cheese in an adjustable dairy module complete with full length top door shelf, two dairy compartments with sliding door and three food storage containers. The 19 cubic foot model features one large dairy compartment with two condiment trays and three food storage containers. See Figure 21.

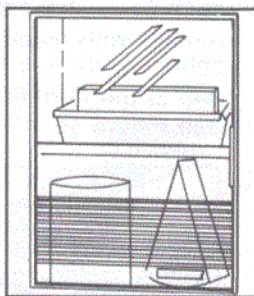

FIGURE 21

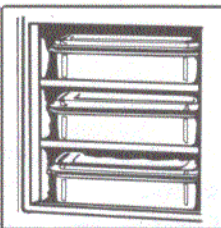

FIGURE 22

store conveniently in this compartment and slide out for easy access. Containers are microwave* and dishwasher safe. (Place in top rack of dishwasher only.) **Note:** If containers should stain, follow manufacturer's instructions for cleaning.

Food Storage Containers.

Some models feature three durable left-over containers. See Figure 22. They

Door Shelves.

Some models feature door shelves that can be moved up or down to fit storage needs. See Figure 23. To remove, loosen shelf by tapping upwards gently underneath both ends. Lift shelf slightly, then rotate bottom out and up to release mounting hooks from door slots. To

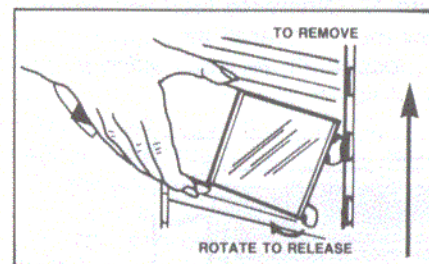

FIGURE 23

install, tilt shelf and insert upper hooks into any two door slots as shown. Rotate shelf bottom towards door and insert bottom hooks into door slots. Hold shelf against door and tap down gently on both ends until shelf is seated securely.

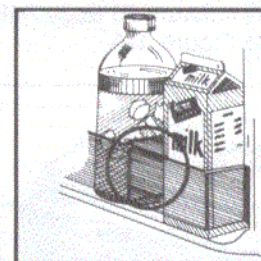

FIGURE 24

Huggers. Some models feature two handy shelf huggers that slide back and forth along door shelves to accommodate storage needs. See Figure 24.

*Note: Be sure to follow manufacturer's instructions located in the containers when using containers to reheat foods in a microwave oven.

Freezer Features

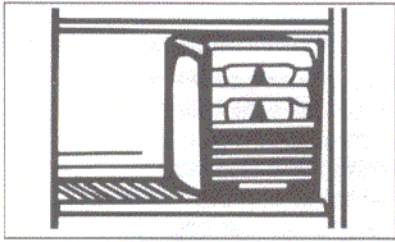

FIGURE 25

Freezer Ice Service

Some units feature an Ice Service Rack with two ice cube trays and a pull-out ice cube drawer. See Figure 25. To release ice cubes, grasp both ends of the tray and twist in opposite directions until the ice pops out.

Factory installed automatic ice maker on 20 cu. ft. model.

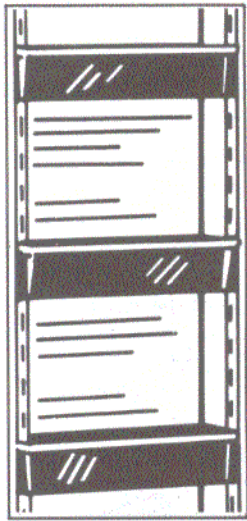

FIGURE 26

Freezer Door

The freezer door has six adjustable shelves. To remove gently tap both ends up, then pull out. See Figure 26.

Large Glide-out Freezer Basket

Basket

Stores odd-shaped, bulky food items. See Figure 27.

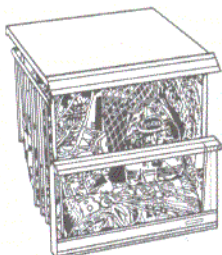

FIGURE 27

Adjustable Freezer Shelves

The removable shelves are installed on supports in the freezer side walls. See Figure 28.

1. To remove, tap shelf gently from the right side and slide out.
2. Reverse procedure to install.

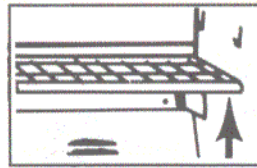

FIGURE 28

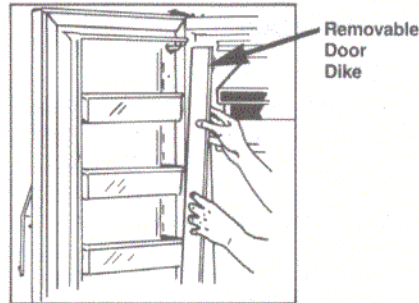

FIGURE 29

Removable Door Dike (20 cu. ft. Only)

Designed for kitchens when space limitations restrict opening of door to 90°. The removable door dike (closest to hinges) will snap out to allow removal of freezer basket and ice bucket. To insert door dike align the four push clips to the holes on the freezer door. Snap in until the door dike is locked into place. See Figure 29.

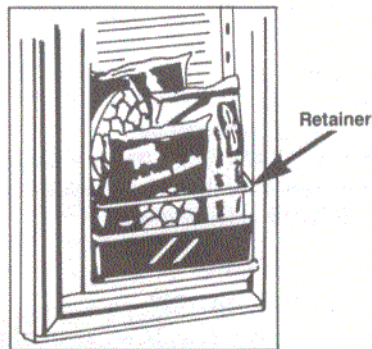

FIGURE 30

Tall Package Retainers

Allows placement of tall packages in door shelves. Retainer will keep packages securely in place. See Figure 30.

Other Features

Automatic Free-O'-Frost™ Operation

The freezer and refrigerator sections are completely frost-free. The Amana Frost-Magnet® evaporator coil in the back wall stops frost before it starts. Under normal operating conditions, you'll never have to defrost the unit, because it's automatic.



FIGURE 31

Bottle Rack (Some Models)

This rack hangs from any glass shelf and holds a large bottle within easy reach. See Figure 31. It is shipped inside a crisper drawer. To install, hook tabs on flat portion of rack over the side metal frame of any shelf. The shelf may have to be tilted up or removed temporarily. **Be sure bottle cap is on tightly before placing a bottle in the rack.**

Decorator Doors

The door fronts of most units can be decorated with panels to accent your kitchen decor. Some models are equipped with factory installed trim kits required to do this. For other models, trim kits may be purchased separately from your Amana dealer.

The basic 1/16" trim kit attaches to the door edges and can hold 1/16"-thick panels. For panels that are 1/4" thick, an additional trim kit is required. The 1/4" kit attaches to the panels and slides in a tongue-in-groove fashion into the 1/16" trim, which must be installed on the doors first. Ask your Amana dealer about panel availability, or you may supply your own panels.

How to install decorator panels

Dimensions for 1/16" panels:

•19 cu. ft. models —

Freezer door-14 1/4" x 61 7/8"

Refrigerator door-14 23/32" x 61 7/8"

•20, 22 and 25 cu. ft. models —

Freezer door-14 1/4" x 61 7/8"

Refrigerator door-18 15/32" x 61 7/8"

Tools Needed: Standard screwdriver, phillips screwdriver and masking tape.

1. **Remove trim cover from hinge side of door.** Tape tip and shaft of standard screwdriver to avoid marring the unit. Place screwdriver tip at top of trim cover next to hinge pin and push rear edge of trim out to the sides. Working down the door, lift the rear edge of the trim cover to the side until it snaps off the trim retainer.
2. **Unscrew and remove the trim retainer.**
3. **Guide panel into channels in the top and bottom trim** and slide panel across the door and underneath the door handle. Press panel or squeeze door handle as needed.
4. **Replace the trim retainer.** Hook trim cover onto the front edge of the trim retainer, then gently tap back of cover with base of hand until cover is firmly seated along its entire length.
5. **NOTE:** On models having black handles and trim it will be necessary to modify a small black plastic shim located behind the top end of the upper trim piece on the handle side of the door. Remove shim by sliding part to the right. See Fig. 32 and 32A. Modify per Fig. 33, then reinstall shim by sliding it back into place.

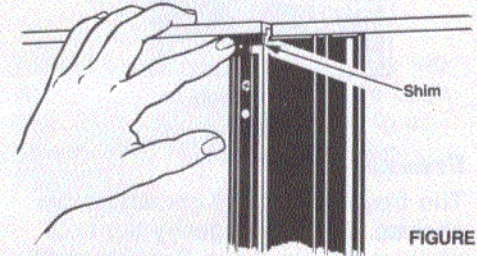

FIGURE 32A

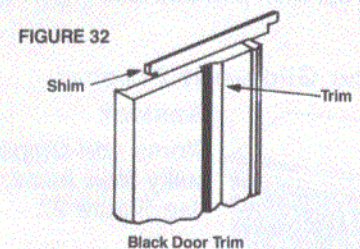

FIGURE 32

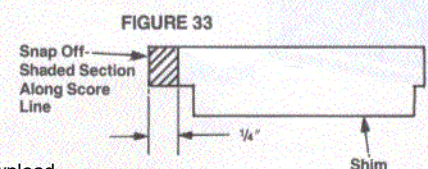

FIGURE 33

Other Features (cont.)

Can Be Built In

Condenser air circulation, required for proper operation, occurs at the bottom front of the unit. Therefore, the unit can safely be enclosed completely at the top, back and sides for a built-in look. Do not block airflow through the toe grille at bottom front of unit. See Figure 8 on page 5.

Automatic Ice Maker

Some models have an automatic ice maker already installed. See Figure 34. Other models have a connection in the freezer back wall for installation of an optional ice maker, available at extra cost from your Amana dealer.

Allow 4 to 12 hours after installation for the first ice harvest to occur. The time required will depend on the freezer temperature setting and on the amount of food in the unit. The ice maker automatically fills itself with water and empties ice into the bin. A wire arm senses the amount of ice and turns the icemaker off when the bin is full.

To start ice production: Install the ice bin and lower the wire arm. The ice bin should be placed in the

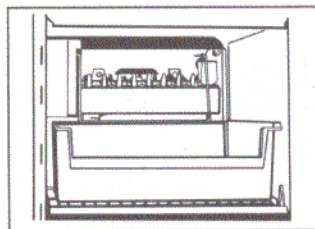

FIGURE 34

furthermost position, or it will not operate correctly. (The freezer compartment may become filled with ice cubes.)

To stop ice production: Raise the wire arm until it locks. (**NOTE:** As long as the arm is raised, the ice maker will not operate.)

Discard the first several ice harvests so any impurities flushed through the water line or ice maker will not be consumed.

Ice cubes are porous and will absorb food odors, so be sure to keep foods covered in the freezer and refrigerator sections. (See "Before Calling For Service" on page 19.)

Cold, dry air circulates through the entire refrigerator/freezer to maintain safe storage temperatures. After several weeks, this air movement can cause cubes stored open in the ice bin to evaporate and stick together.

CAUTION:

To guard against possible water damage. If the refrigerator will be unattended, raise the ice maker wire shut off arm and turn the water shut off valve for the refrigerator to OFF.

* If you should choose to install the optional ice maker, please follow the provided instructions and use only Amana parts.

Sounds

Your new unit may be replacing a smaller refrigerator of different design and/or a product which operated less efficiently. We have taken steps in product design and operation which will continue to provide our customers the highest quality product, one which is energy efficient and operates as economically as possible. With this new design, you may hear sounds which are unfamiliar to you, yet quite normal.

Polyurethane foam insulation, while a much better insulator, does not have the sound-absorbing characteristic of fiberglass insulation. Sounds may be amplified further by the wall and/or floor acting as a sounding board.

Because your product is designed to provide greater efficiency, the compressor operates at a much higher speed than previously. This results in a high speed hum which

will be more noticeable than the sound produced by a slower speed compressor. In addition, the compressor's increased torque may cause some vibration during start up or shut down of the unit.

The refrigerant flowing through the refrigeration tubing may create "water running" or "gurgling" sounds during operation and shortly after shut down. You may also hear the ice falling out of the automatic Ice Maker or the activation of the water solenoid valve during an ice making cycle.

Periodically, your refrigerator will automatically defrost. When this happens, you may hear "dripping water" and "sizzling" sounds.

None of these sounds are unusual, and will soon become familiar. They indicate the unit is operating and performing as designed.

Care & Cleaning

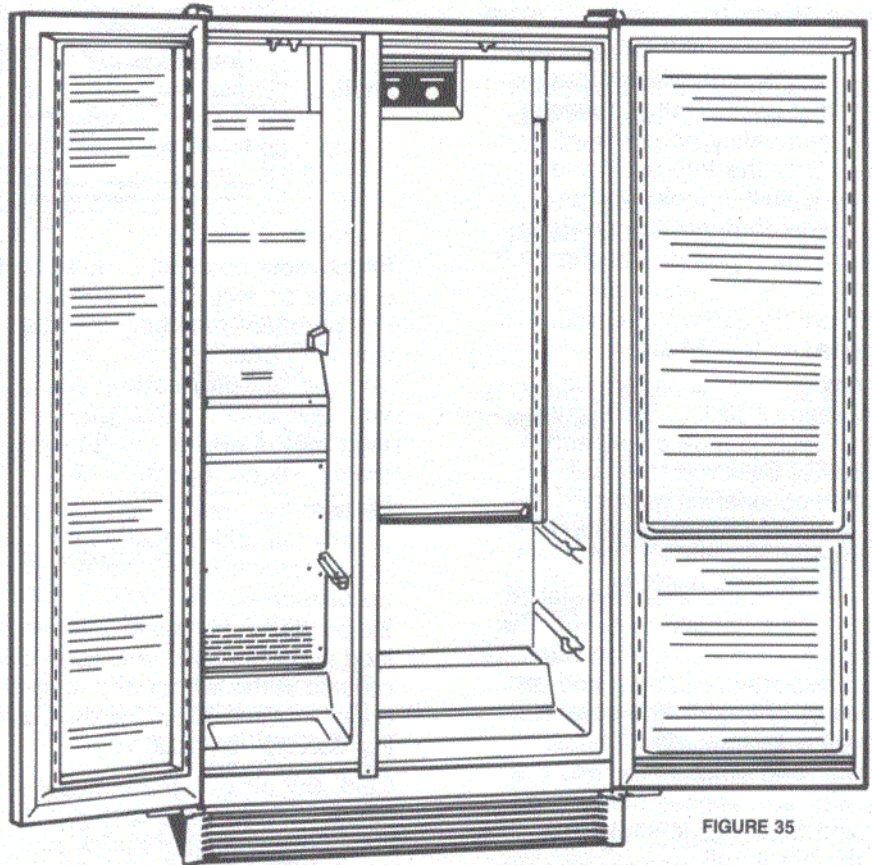

FIGURE 35

CAUTION:

To Avoid The Risk Of Personal Injury use caution in unpacking, handling, removing, installing and cleaning all parts of product which may have sharp edges.

CAUTION:

To Avoid The Risk Of Personal Injury wear protective hand covering.

WARNING

To Avoid The Risk Of Electrical Shock Or Death unplug the power cord before replacing a burned out light bulb or cleaning.

Remove all food and special compartments from the freezer and refrigerator sections. See Figure 35.

Exterior. Wash with warm, soapy water, rinse and dry. Use appliance polish or wax periodically to keep the exterior looking like new. Note: If your unit has factory installed black front panels do not use ammonia containing cleaners.

Door Gaskets. Clean at least twice a year with mild soap and water. Rinse and dry. Apply a light film of petroleum jelly to the gaskets on the hinge side to keep them soft and pliable.

Interior. Wash the liner with warm, soapy water. Rinse and dry. Interior components such as shelves and drawers may be washed with 4

tablespoons baking soda dissolved in 1 quart warm water to "sweeten" these parts. Rinse and dry thoroughly.

Interior and Exterior. DO NOT USE abrasive, heavy-duty powders such as AJAX cleanser, COMET cleanser, etc., when cleaning the interior or exterior of the refrigerator. These can scratch and dull the surface, depending on their abrasiveness and the cleaning pressure applied. Avoid metal pads and abrasive impregnated plastic, nylon and cloth pads such as CHORE-BOY® and KURLY KATE® pot cleansers, BRILLO® metal cleaning pads, SCOTCH-BRITE® scouring pads, S.O.S.® and PADDY® soap pads, etc. These can scratch the baked enamel exterior and interior surfaces.

Care & Cleaning (cont.)

Do not use concentrated liquid dishwashing detergent (dissolve in warm water before using), abrasive cleansers, solvents or polishing agents on plastic parts. These cleansers may cause cracking or discoloring.

Do not wash plastic parts in an automatic dishwasher. They may warp. (The butter dish and food storage containers can be washed in a dishwasher. See page 10 for details.)

Ice Maker. If your water has a high mineral content, the ice maker may require periodic cleaning. Cleaning with vinegar should remove most of the build-up. Contact your dealer for assistance with ice maker removal, cleaning and reinstallation. An in-line water filter may also be necessary.

Clean Defrost Drain Pan. The pan is located underneath the unit behind the toe grille. Every three months, remove the drain pan, wash it with warm soapy water, rinse and dry. When replacing the pan, make sure it is directly underneath the defrost water tube that extends from the back of the unit. Pull the toe grille forward to remove.

Clean Condenser Coil. The condenser coil is located behind the toe grille. Use a long-handled bottle brush and a vacuum cleaner to remove dust and lint from the coil. A suitable brush can be purchased from your Amana dealer. Dust and lint act as an insulator and prevent the coil from expelling heat taken from inside the unit. Failure to keep the coil clean will reduce cooling performance and efficiency.

Reconnect Power Cord. After cleaning, reconnect the power cord.

Odors

If an offensive odor appears to be lingering in the refrigerator or freezer, the following procedures may eliminate the problem. Always begin with Method I. Use Method II and III only if the odor persists.

Method I

1. Unplug the unit.
2. Remove all food.
3. Thoroughly wash the inside of the unit including all shelves, drawers, accessories and gaskets

with a mixture of 4 tablespoons of baking soda dissolved in 1 quart of warm water. Pay special attention to any corners, crevices or grooves into which odor-causing liquid may have seeped. Dry thoroughly.

4. Return food to unit washing off all bottles, jars and containers before placing them into the refrigerator and freezer.
5. Plug in the unit. Wait 24 hours before checking to see if the odor has been eliminated. If the odor is still present, proceed with Method II.

Method II

1. Unplug the unit.
2. Remove all food, making arrangements for other food storage. (The inside of the unit should already have been washed as instructed in Method I.)
3. Place crisper drawers on the top shelf of the refrigerator section.
4. Lightly crumple single sheets of newspaper. Loosely pack and fill the entire refrigerator and freezer interior with newspapers including door shelves, drawers and compartments.
5. Randomly place charcoal briquettes throughout the crumpled newspaper in both compartments.
6. Close the doors and let stand for 24 to 48 hours.
7. Remove the charcoal briquettes and newspapers. Wash and dry the inside of the unit as described in Method I.
8. Plug in the unit. Wait for 24 hours before checking to see if the odor has been eliminated. If the odor has been eliminated then replace the food. If the odor persists, proceed with Method III.

Method III

Order Delta Foremost's Original Country Club Cherry (a commercial neutralizing aerosol) from your nearest Amana authorized service center (Part number R1831-6). Use according to the instructions packaged with the aerosol. Remember to unplug the unit before beginning.

Non-Use Periods

Vacation Time. If you will be away for vacation, remove perishable foods from the unit. Shut off the ice maker by turning off the water supply to the refrigerator and moving the icemaker wire arm to its uppermost position.

Extended Periods of Non-Use. If you are going to be away for longer periods, empty and unplug the unit. This will reduce needless operation and assure that food will not be spoiled if electrical service is interrupted. Just clean the unit as instructed in this manual and prop open the doors so air can circulate inside. Leave the unit unplugged. If the refrigerator has an automatic icemaker, turn off the water supply to the refrigerator.

CAUTION

To Avoid Property Damage do NOT use tape that has a "permanent" type adhesive.

When You Move. Unplug the unit and clean it. Use strapping tape or masking tape to secure all trays, shelves and other parts to prevent damage during shipment. Do not leave the unit closed for an extended period of time.

If The Refrigerator Will Be Stored.

If the refrigerator will be stored or remain unused in a sub-freezing environment, remove the water and protect the water valve from damage as follows:

1. Disconnect the refrigerator from the electrical power source.
2. Shut off the refrigerator water supply. This can be done at the saddle valve where the $\frac{1}{4}$ " copper supply tubing joins the household water line. (Refer to illustration on back of cabinet.)
3. Remove the compressor compartment cover from the bottom rear of the refrigerator to reveal the water valve coupling. Place a small container under the valve to catch water spills. Remove the brass hose fitting from the valve. Unscrew the compression nuts from the tube and bottom of valve. Push end of the tubes away from the valve fitting. See Figure 36.

TYPICAL WATER VALVE COUPLING

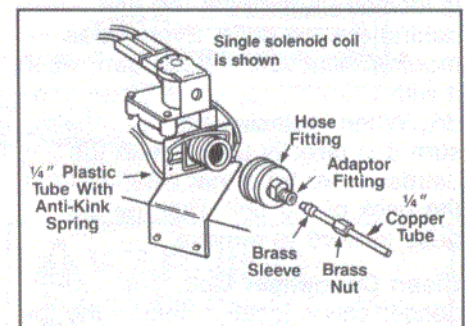

FIGURE 36

You Can Help Save Energy!

Your New Amana Stor-Mor® Refrigerator/Freezer is designed to operate efficiently. You can help reduce energy consumption by following these suggestions:

Energy Saver Control. This control regulates special heaters that help reduce condensation during periods of high humidity. Reduce energy consumption by setting the control according to current climatic conditions.

Refrigerated Meat Keeper. Adjust the control to obtain the best storage conditions for highly perishable food items.

Keep Freezer Section Full. The unit operates more economically when the freezer is filled to capaci-

ty, but not overfilled. A full freezer helps maintain frozen temperatures when the door is opened.

Controls. See the freezer and refrigerator controls so that compartments are not colder than recommended. See page 7 for details.

Doors. Make sure the door gaskets do not become blocked, dirty or worn. Air leaks will cause the unit to operate more often.

Location. Install the unit away from heating equipment or direct sunlight.

Keep the Condenser Coil Clean. A dirty condenser coil will cause the unit to operate more than necessary. See above for details.

Before Calling For Service

Unnecessary service calls may be avoided by checking for the following common sources of difficulty. You will be charged for a serviceman's travel expenses and labor, even though the product may be in warranty, if the difficulty is not caused by *workmanship* or *material*, or if the component is *customer replaceable*. The following items are considered customer replaceable: defrost drain pan, door and cabinet shelves and drawers, butter dish, ice trays, light bulbs, egg bucket, huggers and accessories.

Your refrigerator/freezer is designed for operation in a conditioned environment. For best performance your refrigerator should not be installed where surrounding temperature will be lower than 55 degrees F. The compressor will not run frequently enough to maintain proper temperature. Operation in surrounding temperatures below 32 degrees F. will result in defrosting problems and is not recommended for self defrosting products.

If product does not appear to be operating:

- Does the light work? A dim light indicates low voltage or a weak bulb.
- Is cord plugged in?
- Is a fuse or circuit breaker open? Check by plugging in another appliance or lamp at the same wall outlet.
- Has either of the doors been left open? Make certain food items stored within the refrigerator are not obstructing proper door closure. Check leveling of unit. (See page 5.)
- If the lights work and the freezer control is on, but the fan and compressor are not operating, the unit is likely in the defrost cycle. Wait 30 minutes to see if the unit will restart. If it does not, remove the toe grille. The defrost timer is located behind the grille. Turn the timer knob clockwise until you hear a click. The refrigerator should begin running.

Before Calling For Service

If the unit still won't operate:

- Be sure you have completed the steps listed above.
- Unplug the unit and take the steps necessary to preserve the food stored in the unit. Dry ice may be placed in the freezer section of the unit to preserve food until the unit can be serviced. Doors should be left closed until the unit has been repaired. Your product warranty does not cover food loss.
- Call your nearest Amana dealer or authorized service center listed in the Yellow Pages.

If food temperature appears to be warm:

- See prior sections.
- Allow adequate time for the food to reach freezing temperature.
- Are any shelves covered with foil or plastic, preventing proper air flow?
- Is the condenser area clean? See pages 15 & 17.)
- Adjust freezer control. (See page 7.)

If refrigerator section is too warm:

- See prior sections.
- Adjust Temp-Assure refrigerator control. (See page 7.)

If Refrigerated Meat Keeper is too warm:

- Is Meat Keeper inlet tube in place with the control outlet tube on side wall?
- Slide Meat Keeper control to colder setting.
- Adjust freezer control to colder setting.

If refrigerator food temperature is too cold:

- Check Refrigerated Meat Keeper drawer assembly to see that inlet tube is in proper place over the outlet hole on side wall. If it is not properly connected, freezer air will spill into the refrigerator section.
- If Refrigerated Meat Keeper has been moved, check to see that inlet connector is in proper place over the air inlet side hole. (See page 9.)
- Is condenser area clean? (See pages 15 & 17.)

- Are any shelves covered with foil or plastic, preventing proper air flow?
- Adjust Temp-Assure refrigerator control. (See page 7.)
- Adjust freezer control to warmer setting. Allow several hours for temperature to change.

If the unit runs too much or too frequently:

- It may be normal to maintain an even temperature.
- Is condenser area clean? (See pages 15 & 17.)
- Have doors been opened frequently or for an extended period of time?
- Is freezer running too cold? Adjust freezer control. (See page 7.)
- Check door alignment and gasket seal for proper closure.

If the unit makes unfamiliar sounds such as popping or cracking; tapping, gurgling, boiling or bubbling; rumbling or rattling on shutdown:

- These may be normal operating sounds. Refer to page 13 for information on sounds the unit may make.

If you hear running water in the unit:

- This is normal when the icemaker fills.
- This is normal when the unit defrosts and water enters the condensate pan.

If you hear periodic buzzing:

- This is normal in cabinets with an automatic icemaker. The water valve will buzz when energized to refill the icemaker.

If condensate forms on the inside of the unit:

- This is normal during periods of high humidity.

If condensate forms on the outside of the unit:

- Is Energy Saver Control on highest setting? This will help reduce condensate.
- Check door alignment and gasket seal for proper closure.

Before Calling For Service

If Crisper or Meat Keeper drawers do not close freely:

- Check for package obstructing proper closure.
- Check to confirm drawer is in proper position in assembly.
- Apply thin layer of petroleum jelly to slide channels.
- Make sure refrigerator is level.

If there is an odor in the unit or ice cubes:

- Clean product. (See pages 14 & 15.)
- Cover all foods tightly.
- Use freezer containers or freezer wrap.

If ice forms in the inlet tube to the ice maker: (If equipped with an optional ice maker.)

- Indicates sediment in solenoid valve which has not allowed the valve to close. An in-line water filter should be added. If problem persists the solenoid valve will need to be cleaned or changed.

If the Automatic Ice Maker does not produce ice:

- Check for ice cubes obstructing the shut-off arm.
- Check to make sure shut-off arm is in the 'down' position.

If light bulb needs replacing:

- Unplug unit from wall outlet to avoid electrical shock. A pair of gloves should be worn as a precaution against broken glass.

Refrigerator Compartment

1. Unscrew the light bulb located on the front upper wall of the refrigerator compartment by turning counterclockwise.
2. Replace with a G.E. or Westinghouse #40A15/1, Sylvania #40A15 or order from your Amana Service Dept., part number A0282803.

Freezer Compartment

1. Remove the light bulb located on the front upper wall of the freezer compartment by turning counterclockwise.
2. Replace with a G.E. or Westinghouse #40A15/1, Sylvania #40A15 or order from your Amana Service Dept., part number A0282803.



Rest assured against unexpected repair bills!

Amana is pleased to offer an important opportunity for long-term service protection on your new Amana appliance. The Amana Asure Extended Service Plan is specially designed to supplement the strong warranty that already accompanies your appliance, and it combines with this standard warranty to provide budget-protecting coverage on your appliance for up to five full

years, covering parts, labor and travel charges.

Your participating Amana dealer has details. Or contact us:

Amana Refrigeration, Inc.
Customer Service Department
Amana, IA 52204
(319) 622-5511
Monday through Friday
(8 a.m.-4:30 p.m., C.S.T.)

1-800-843-0304

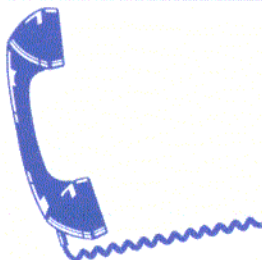

TOLL-FREE
Amana®

Information on product usage, installation, warranty and dealer/service can be obtained through the toll-free number.

Part No. A1069211 Rev. 1
Printed in U.S.A.

Amana
A Raytheon Company

©1990 Amana Refrigeration, Inc.
Amana, Iowa 52204

Free Manuals Download Website

<http://myh66.com>

<http://usermanuals.us>

<http://www.somanuals.com>

<http://www.4manuals.cc>

<http://www.manual-lib.com>

<http://www.404manual.com>

<http://www.luxmanual.com>

<http://aubethermostatmanual.com>

Golf course search by state

<http://golfingnear.com>

Email search by domain

<http://emailbydomain.com>

Auto manuals search

<http://auto.somanuals.com>

TV manuals search

<http://tv.somanuals.com>