

amazonkindle



user's guide

4th edition

Table of Contents

WELCOME	8
CHAPTER 1:	
Getting Started with Your Kindle	18
1.1 Views of Kindle	18
Front View	18
Top View	22
Bottom View	23
1.2 Getting Around	24
Using the Buttons	24
Using the Menus	24
The Application Menu	26
1.3 Entering Text	27
Lowercase and Uppercase Letters	27
Numbers, Punctuation, and Symbols	27
1.4 Screen Rotation	29
1.5 Status Indicators	30
Whispernet Status Indicators	30
Battery Status Indicators	31
Activity Indicator	31
CHAPTER 2:	
Getting to Know Kindle Content	32
2.1 The Home Screen	32
Home Screen Features	34
Show Options	36
Sort Options	38
The Home Screen Menu	40
2.2 Managing Your Content	41
Removing Kindle Content	41
More about Managing Items	42
International Wireless Delivery	42

CHAPTER 3: Reading on Kindle

43

3.1 Types of Content	43
Books	43
Newspapers	43
Magazines	43
Blogs	44
Personal Documents	44
Audiobooks	45
Background Music	45
3.2 Content Formatting on Kindle	46
Progress Indicator	47
Changing the Text Size	47
Adjusting the Number of Words per Line	49
Increasing the Size of a Picture	49
3.3 Moving from Place to Place	50
Using the Menu to Get Around	50
Navigating within a Periodical	54
Selecting Internal Links	56
Viewing a Table	57
Reading Across Multiple Kindles	57
3.4 Looking Up Definitions	58
The Lookup Feature	58
3.5 Annotations and Clippings	58
Using Bookmarks	59
Using Highlights	61
Using Notes	62
Using Clippings	64
3.6 Reading PDF Files	66
3.7 Listening to Audio Materials	69
Audiobooks	69
Background Audio	71
Text-to-Speech	72

CHAPTER 4:
Searching on Kindle **74**

4.1 Introduction to Search.74
 Types of Searches74
 Performing a Search75

4.2 Search Results Page76
 Search Results for a Specific Item77
 Search Results for a Definition.79

4.3 Performing Remote Searches.80
 Searching Wikipedia80
 Searching the Web80
 Searching the Kindle Store.80

CHAPTER 5:
The Kindle Store **82**

5.1 Getting Started at the Store82
 Connecting to the Kindle Store82

5.2 Kindle Store Pages82
 The Kindle Storefront83
 The Store Menu84
 Browsing the Store85
 Getting the Details.87
 Saving Items for Later.89

5.3 Recommendations, Reviews, and Ratings89
 Recommended for You89
 Looking Up Reviews89
 Writing Your Own Ratings and Reviews90
 Entering a Rating and Review91

5.4 Making Purchases92
 Trying a Sample Book92
 Buying Your Selections.92
 Returning an Item92

CHAPTER 6:
Accessing the Web **93**

6.1 Using Basic Web 93
 Entering a URL 94
 Using Bookmarks and Adding Your Own 94
 Using Next Page and Previous Page 95
 Selecting Links, Buttons, and Boxes 95
 Using History 97
 The Basic Web Menu 97

6.2 Other Features 98
 Text Size 98
 Downloading Files 98
 Basic Web Settings 99

CHAPTER 7:
Settings and Experimental **101**

7.1 Adjusting Your Kindle Settings 101
 Registering or Deregistering Kindle 103
 Personalizing Your Kindle 104
 Choosing Your Primary Dictionary 105
 Changing Automatic Backup 105
 The Settings Menu 105

7.2 Experimental 107

CHAPTER 8:
Kindle and Your Computer **108**

8.1 Getting Started. 108
 System Requirements. 108
 Making the Connection. 108

8.2 Transferring Files When Whispernet is Unavailable. 110
 Managing Your Documents 110
 Transferring Your Clippings 110

8.3 Converting and Transferring Your Documents 111
 Supported Formats for Conversion 111
 Sending Your Documents for Conversion. 112

8.4 Audiobooks and MP3s 113
 Audiobooks from Audible.com 113
 Audiobook Formats for Kindle 113
 Transferring MP3s 114

CHAPTER 9:
Your Kindle and Amazon.com **115**

9.1 Shopping for Kindle Content on Amazon.com 115
 Browsing the Kindle Store 115
 Searching the Kindle Store. 115
 Getting the Details. 116
 Ordering Content. 116

9.2 Managing Your Kindle on Amazon.com 117
 Managing Your Device 117
 Managing Your Orders 118
 Downloading Content from Your Computer 119

9.3 Contacting Kindle Support 119

CHAPTER 10:	
Migrating Content to Your New Kindle	120
10.1 Transferring Books	120
10.2 Transferring Periodical Subscriptions	121
10.3 Transferring Personal Documents	122
10.4 Transferring Audiobooks	123
10.5 Transferring MP3s	124
CHAPTER 11:	
Troubleshooting	125
APPENDIX	130
Safety and compliance Information	130
Servicing Your Device	130
Headphone Safety	131
Compliance Information for Kindle Users Outside the US	134
UL Certification Number	134
Product Specifications	135
KINDLE LICENSE AGREEMENT AND TERMS OF USE	136
Wireless Connectivity	136
Digital Content	137
Software	138
General	139
Patent Notices	145
Copyright and Trademark Notices	145
Other Language Versions	145



Welcome to amazonkindle

Thank you for purchasing Amazon Kindle. You are reading the Welcome section of the *Kindle User's Guide*. This section provides an overview of Kindle and highlights a few basic features so you can start reading as quickly as possible.

You can leave this guide at any time by pressing the Home button on your Kindle. To turn to the next page, press one of the Next Page buttons.

If your Kindle was a gift, you will need to register your device. Please look at the *Getting Started* instructions that came with your Kindle for information on registering your device.

Congratulations!

You are reading on your new Kindle.

If you haven't done so already, please follow the Getting Started instructions that came with your Kindle and plug in your Kindle to charge the battery. The charge indicator light on the bottom edge of your Kindle turns yellow and a lightning bolt appears on the battery icon at the top of the display. Charging the battery fully should take less than three hours and you can continue reading while it charges.

 **Tip:** The charge indicator light will turn green when the battery is fully charged.

If you prefer to read the *Kindle User's Guide* side-by-side with the device, you can download and print a PDF copy of the *Kindle User's Guide* at:

<http://www.amazon.com/kindledocuments>

Getting Around

You navigate Kindle using the 5-way controller; the Home, Menu, Back, and Next/Previous Page buttons; and the keyboard:

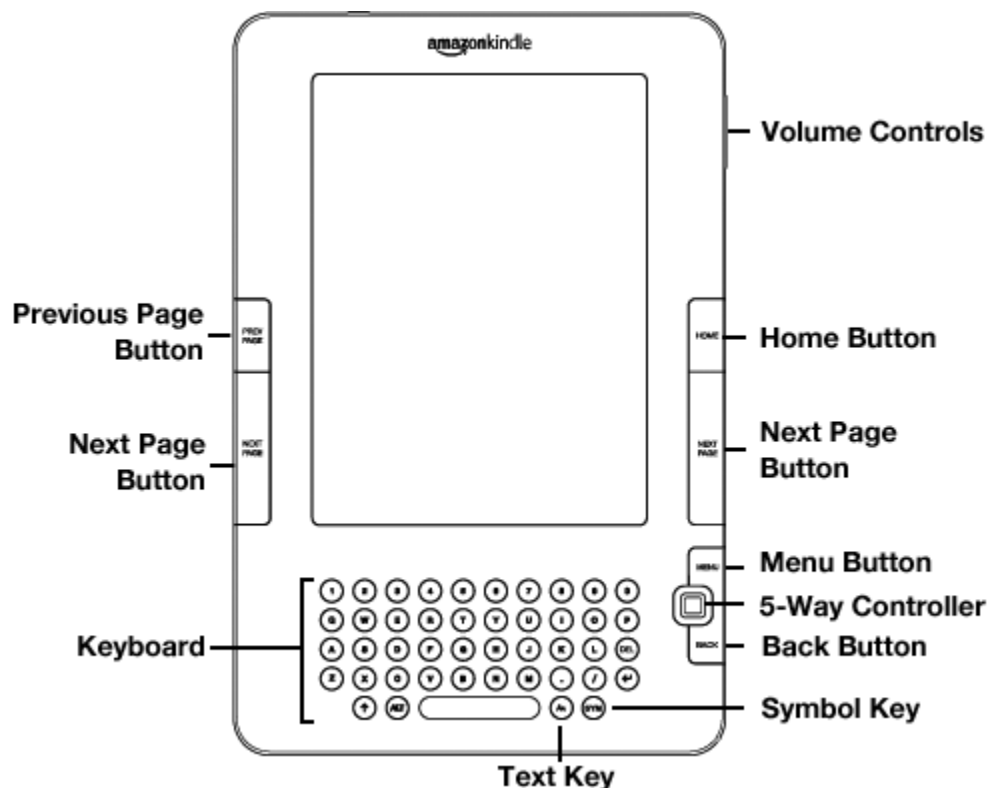

To select a particular item such as a menu option or a specific word in your reading material, move the 5-way controller up, down, left, or right to highlight your choice and then press to select.

You can press the Next or Previous Page buttons to move forward or backward in your reading material and press the Back button to retrace your steps on your Kindle. Use the keyboard to type words or phrases when searching your reading material or items in the Kindle Store. You can also use the keyboard to create notes while reading. All of these are covered in more detail later in this guide.

Easy-to-Read Display

Kindle uses a high-resolution display technology called electronic paper. It works using ink just like books and newspapers, but it displays the ink particles electronically. The page flash you see when you turn the page is part of the ink placement process.

The electronic paper display is reflective, which means unlike most displays, you can read it clearly even in bright sunlight. Also, electronic paper does not need power to hold the ink in place, which extends your Kindle's battery life.

Wireless Access with Whispernet

Using the wireless Amazon Whispernet service, Amazon delivers content to your Kindle whenever and wherever you want it, within the wireless coverage area, using the same technology as a cell phone. By default, your Kindle ships with Whispernet already turned on. To turn Whispernet on or off, press the Menu button, move the 5-way controller up to underline "Turn Wireless On/Off," and then press the 5-way.

Your Choice of Text Size

To optimize your reading experience, Kindle provides a quick way to adjust the size of the reading text among six sizes.

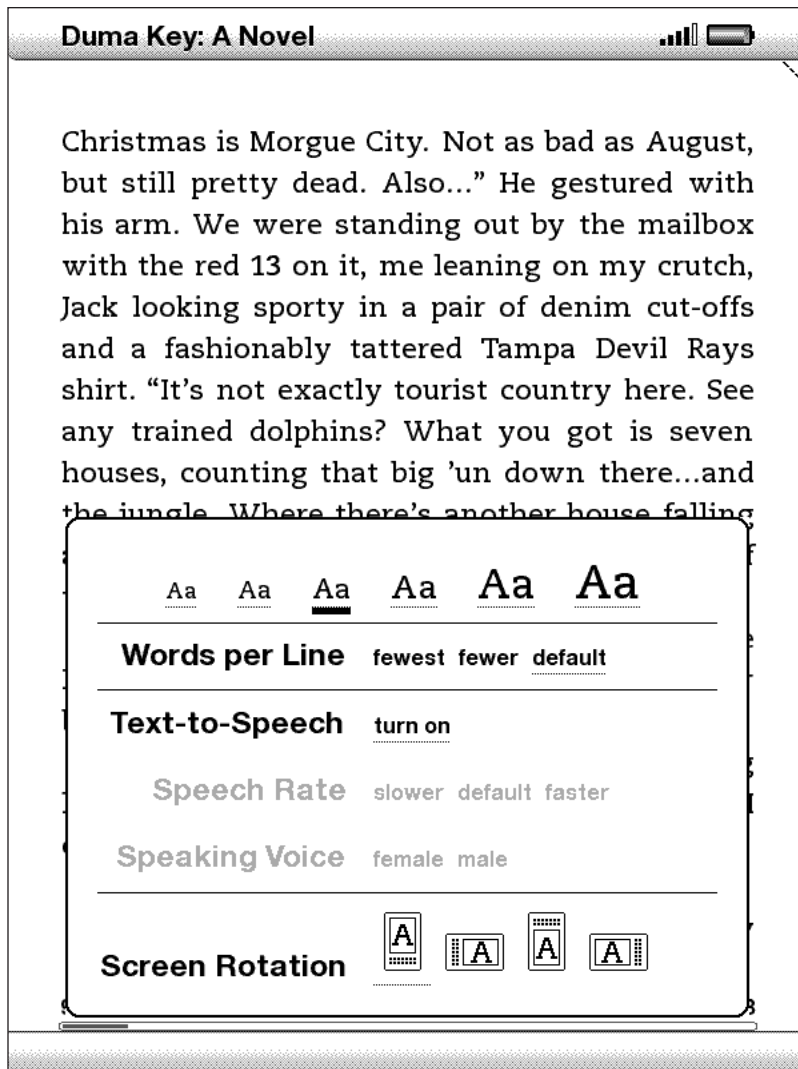

To try it now, press the Text key  move the 5-way controller to choose the size you prefer and press the 5-way to select. The text changes to the new size. Repeat the same steps to change the text size back or to change it to a size comfortable for you to read.

Your Choice of Number of Words per Line

You can also change the number of words per line in the book or periodical you are currently reading. Press the Text key , move the 5-way controller to choose the number of words per line you prefer and press the 5-way to select. This changes the width of the margins. You may find you read faster with fewer words per line. Experiment to see what works best for you.

Adjust Screen Rotation

The Kindle screen image can be rotated so you can see the entire width of a web page or magnify the page of a PDF file. You can lock your Kindle screen to a portrait or landscape orientation to fit your reading position. Press the Text key , then move the 5-way controller to select the screen rotation you want. Press the 5-way to select.

Read PDF Files

Kindle can display a PDF document without losing the formatting of the original file. Just drag PDF files over USB or e-mail them to your dedicated Kindle e-mail address (found on the Settings page on Kindle or the Manage Your Kindle page on Amazon.com). We will wirelessly deliver the original file directly to your Kindle via Whispersnet for a fee. For details, click on the "Learn more" link on the "Your orders and individual charges" section of your Manage Your Kindle page for your Kindle on Amazon.com.

Let Kindle Read to You

You can also choose to turn on the experimental application, Text-to-Speech, which will read aloud your books (where allowed by the rights holder), newspapers, blogs, and personal documents. You can either listen through your Kindle's external speakers or plug in earphones into the headphone jack. While Text-to-Speech is playing, the screen will turn the pages automatically so you can follow along while the audio is playing. You have the choice of hearing your content spoken with a male or female voice and can also further optimize the listening experience by slowing down or increasing the rate of speech.

Look It Up

Your Kindle includes *The New Oxford American Dictionary*. You can easily look up a particular word without leaving the content. Simply use the 5-way controller to navigate the cursor in front of the word you want defined. A definition of the word appears at the bottom of the screen. To view the full definition, press the Return key  on the keyboard. To return to the text you were reading, press the Back button.

Take It All with You

Although Kindle is about the size of a paperback book, it can store over a thousand digital books, newspapers, blogs, and magazines, which are referred to collectively as “content” throughout this guide. A copy of all your books and recent issues of newspapers and magazines purchased from the Kindle Store are kept on Amazon.com.

To open content on your Kindle, press the Home button. This displays a list of the content on your Kindle. Move the 5-way controller up or down to underline the item you want to open and then press the 5-way to open the item. To delete content on your Kindle, move the 5-way controller up or down to underline the item you want to delete. Move the 5-way to the left and then press the 5-way to complete the removal of the item.

To move previously deleted content from Amazon.com back to your Kindle, Whispernet must be on. From Home, select “Archived Items.” This shows all of the content stored at Amazon.com. Underline the item you want to move back to your Kindle and move the 5-way to the right and then press the 5-way to start the transfer. In under a minute, the item re-downloads into your Kindle and appears in the list of content in Home.

Shop Anytime, Anywhere

If you have Whispernet on and you select “Shop in Kindle Store” from any menu, Kindle connects you to a broad offering of reading material including books, newspapers, blogs, and magazines. You can browse by category or check out the latest bestsellers, new and noteworthy items, or your personalized recommendations. You can see details about an item, read customer reviews, and even download free samples of books you are interested in. If you want to buy an item, Kindle uses secure Amazon 1-Click and then Whispernet delivers the item to your Kindle generally in under a minute.

Automatic Delivery

Since Kindle connects to the Whispernet network, we deliver your favorite periodicals over the air to your device as soon as they are published, often before they are even available in print. For example, if you subscribe to the Kindle edition of *The New York Times*, the latest edition is wirelessly delivered overnight so you can read it each morning. Your favorite periodicals follow you wherever you go in Whispernet's broad coverage area, whether you are at home or on the road.

Peruse Your Periodicals

Just as you would thumb through a physical newspaper or magazine to locate an article of interest, your Kindle supplies you with navigation shortcuts so that you can quickly zero in on an article of interest. By moving the 5-way controller right or left you can advance to the next or previous article and pushing the 5-way brings up the periodical's section list.

Search Your World

While you are in Home, the Kindle Store, or reading content, you can use your Kindle's search feature. From the keyboard, begin typing what you'd like to search for and then using the 5-way controller, select the range of your search. If you begin your search while in Home or with open content, you have the option to search for that item in all of your books, newspapers, blogs, personal documents, and annotations. You also have the option to focus your search to the built-in dictionary, the Kindle Store, Wikipedia, and the Web.

Clip Your Favorite Passages

Have you ever been reading a book or a newspaper and wanted to clip and save a few words to refer to later? With Kindle, simply select "Add a Note or Highlight" from the menu and use the 5-way to highlight the content you want to clip and then press the 5-way to save your selection. The clipping is added to a file in Home called "My Clippings." You can review your clippings later, search for words or terms you clipped, and transfer the "My Clippings" file to your computer. This is a great way to capture your favorite quotations to share with others.

Bookmark Your Reading

Kindle automatically saves your place in whatever book you are reading, but you can also add a bookmark to any page by pressing the Menu button and selecting “Add a Bookmark.” You can see that the upper right corner of the page is dog-eared. Kindle stores all your bookmarks for the current content in your annotations. You can view them at any time by pressing the Menu button and selecting “My Notes & Marks.”

Add Your Own Notes

Do you like to take notes and make comments while reading? You can add notes to any of the content on Kindle. Amazon automatically stores all of your book annotations in the “My Clippings” file and backs them up on Amazon servers so they will not be lost.

As an example, this sentence is highlighted and has a note attached as indicated by the superscripted number one to the right of this text.¹ Using the 5-way controller, move the cursor over the notation number to see the note. To add your own note, move the cursor to the word where you want to add your thoughts, and begin typing your note. Then use the 5-way again to highlight the “save note” button onscreen and press the 5-way to select. You can later view, edit, or remove a note, or see all of your annotations by pressing the Menu button and selecting “My Notes & Marks.”

Stay in Sync

Whispersync technology saves and synchronizes your reading location across your Kindle(s) and your iPhone. Now you can read a few pages on your iPhone and pick up right where you left off when you return to your Kindle.

Convert Your Own Documents

In addition to all of the great reading material you can get from the Kindle Store, Amazon can also convert your own documents so you can read them on Kindle. You can e-mail Microsoft Word, TXT, HTML, RTF, or image files like JPEGs and GIFs to your dedicated Kindle e-mail address (found on the Settings page on Kindle or the Manage Your Kindle page on Amazon.com). We will convert the document into Kindle format and wirelessly provide it directly to your Kindle via Whispernet for a fee or back to your computer for free. If you e-mail a PDF to your Kindle, it will be sent to your device with no conversion.

Learning More

This ends your brief introduction to just some of the capabilities on Kindle. The chapters that follow give a more complete overview of these and other features. Remember, you can always search on a particular feature or learn more about how to do a particular task by opening this guide and typing on the keyboard to activate Search.

The Table of Contents for the *Kindle User's Guide* shows you all of the topics covered in this guide. You can get to the table of contents by pressing the Menu button from any page. Move the 5-way down until you underline "Table of Contents" and press the 5-way to go to it.

You can also navigate by clicking an underlined word or words like the "Table of Contents" above. Underlined words indicate a link to somewhere else in the material you are reading, like a footnote, a chapter, or a web site. In the example above, when you navigate the 5-way controller over one of the underlined words, a hand icon  will appear. Pressing the 5-way will take you to the beginning of the table of contents. Press the Back button to go back to where you were reading.

If you bought your Kindle with your Amazon account, it is already registered with your account information and you are ready to go. When you go to the Home screen, check the top left corner of the screen to see if your Amazon name (the same one you see when you are shopping on Amazon.com) is shown. If it says "My Kindle" instead of your Amazon account name, you need to register your Kindle. To register, first press Home to display the Home screen and then press the Menu button. Select "Settings" and then select "register" on the page that appears to enter your Amazon user name and password. If your Amazon user name or password contains characters not present on the Kindle keyboard, press the Symbol key  on the bottom of the keyboard to see a menu of the extended characters and use the 5-way to select the character you require. Alternatively, you can register your Kindle by visiting the Manage Your Kindle page on Amazon.com at: <http://www.amazon.com/manageyourkindle>

You can leave the *Kindle User's Guide*, or any item you are reading, at any time by pressing the Home button. If you are done reading, you can put your Kindle to sleep by sliding and releasing the power button located at the top of your Kindle (you wake up Kindle the same way). Sleeping your Kindle will extend battery life and also lock all of the keys and buttons so you don't inadvertently press one while not using your Kindle. When your Kindle is asleep, you will see an image on the screen. To turn off your Kindle completely, slide and hold the power switch for four seconds, then release. The Kindle screen will blank and the device will turn off. If you ever need assistance, you can use the Web or your telephone to contact us. See Chapter 9 for all of the Kindle Support contact options. 

CHAPTER 1: Getting Started with Your Kindle

In the Welcome chapter of the *Kindle User's Guide*, you read about many of the things you can do with your Kindle. This chapter reviews all of the physical features of Kindle and covers the basics of using the Kindle buttons, menus, and keyboard.

1.1 Views of Kindle

FRONT VIEW

The front of your Kindle contains the screen the keyboard, and the navigation controls. These features are illustrated below and explained in the list that follows.

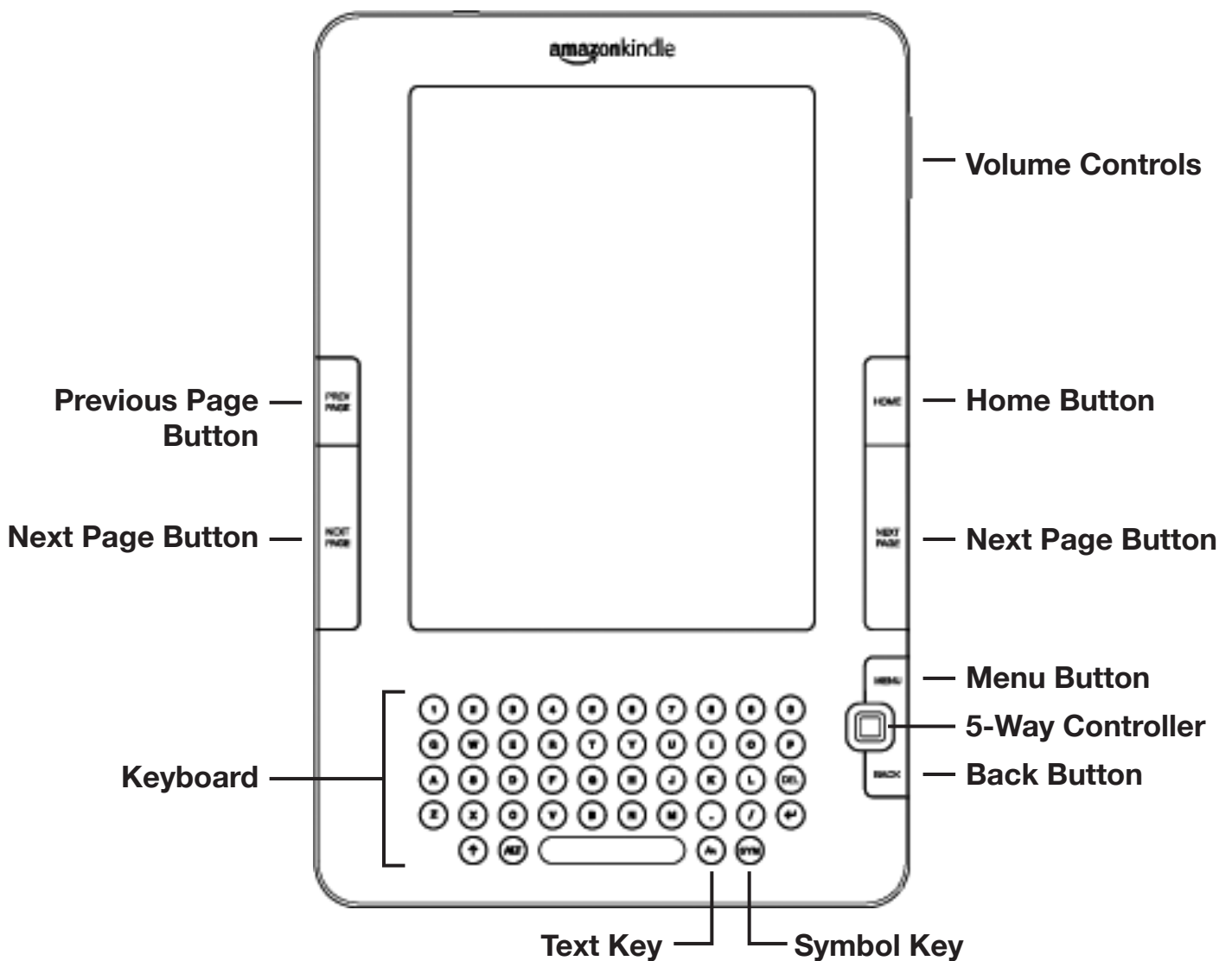

Volume controls — controls the headphone or speaker volume for audiobooks, background music, and text-to-speech.

Previous Page button — takes you to the previous page in your reading material.

Home button — shows content stored on your Kindle as well as content archived at Amazon.

Next Page button — takes you to the next page in your reading material.

To accommodate different ways of holding the Kindle, there is a Next Page button on both sides.

Menu button — displays application and navigation choices that are related to the screen you are viewing.

5-way controller — selects an item or action when pressed down. Moves the on-screen highlight or cursor up and down when moved up and down. Moves the on-screen highlight or cursor side-to-side when moved left or right. Holding the 5-way controller up or down without releasing it accelerates the cursor movement, making it faster to navigate through lists or text.

Keyboard — use to enter search terms, notes in your content, URLs for Web sites, etc.

Back button — retraces your steps on Kindle just like the back button on a web browser. For example, you can follow a link in a book and then press the Back button to return to your place.

Symbol key  — presents a menu of punctuation marks and symbols. Move the 5-way controller to select the desired symbol and press the 5-way to select.

Text key  — adjusts font size and number of words per line to suit your reading preference. Also allows you to turn on/off Text-to-Speech and to change the screen rotation settings.

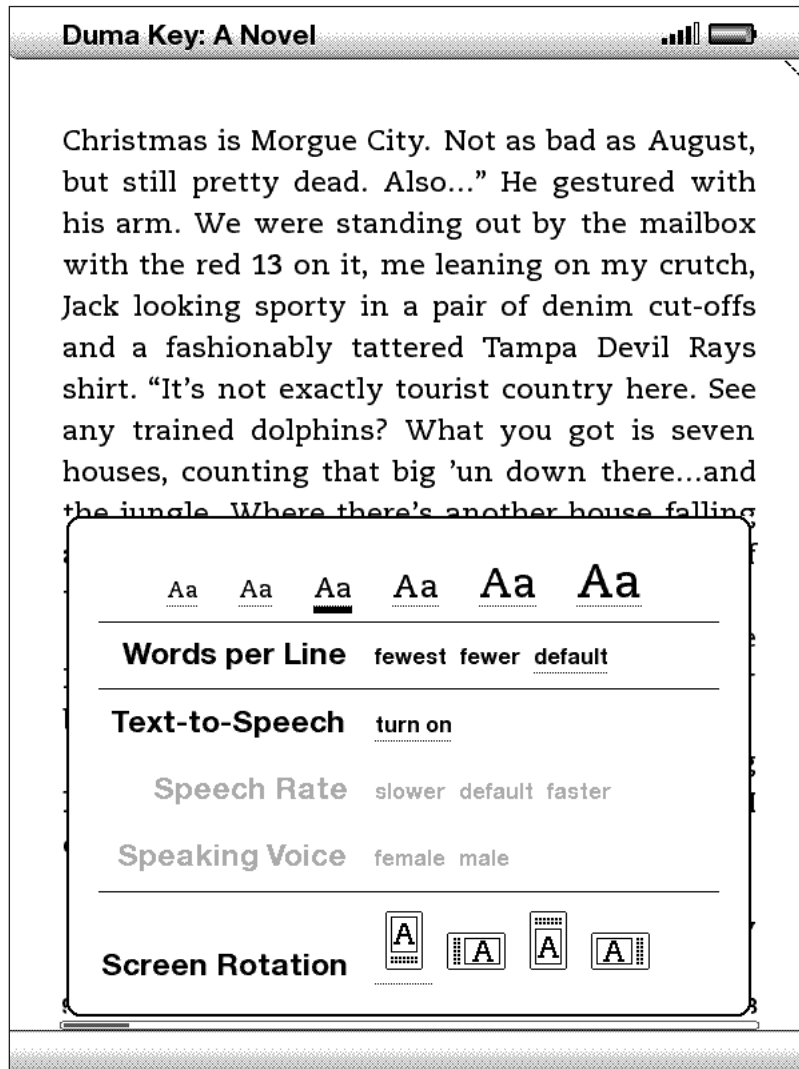

BACK VIEW

The back of your Kindle contains stereo speakers for audio content.

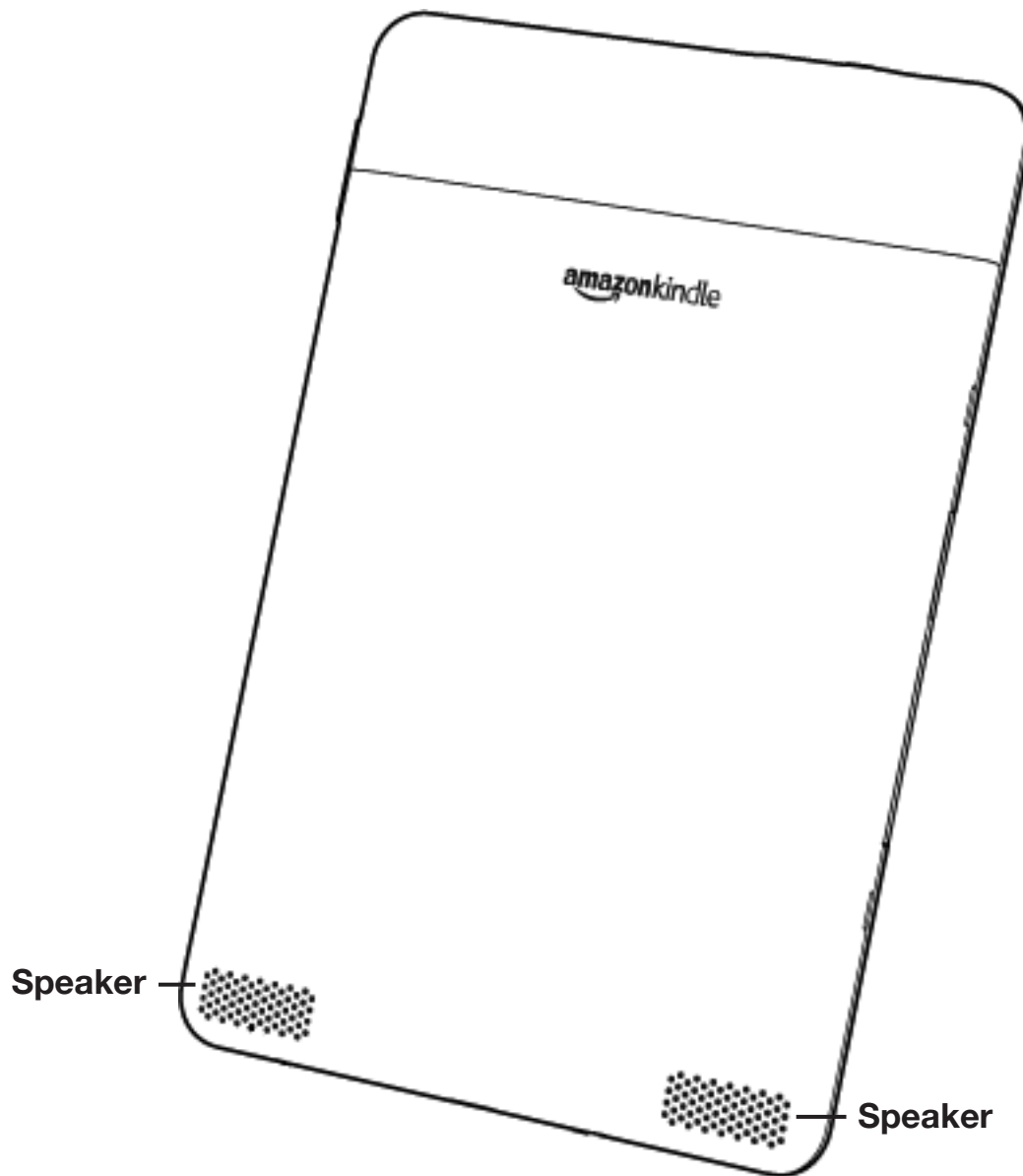

TOP VIEW

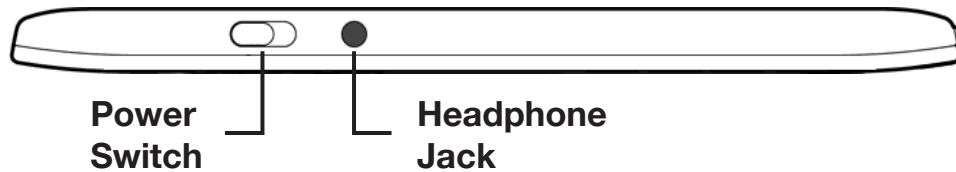

Power switch — puts your Kindle to sleep, wakes it up, and turns your Kindle on or off. To put your Kindle to sleep, slide and release the power switch; a full screen image appears on the display. While your Kindle is asleep, other keys and buttons are locked so that you don't accidentally change the place in your reading. To turn your Kindle off, slide and hold the power switch for four seconds until the screen goes blank and then release. To wake up or turn on your Kindle, slide and release the power switch again.

If your Kindle does not power on or is unresponsive during use, try resetting the device by disconnecting your Kindle from any power source, and then sliding and holding the power switch for 15 seconds before releasing.

 **Tip:** Your Kindle will also go to sleep by itself after ten minutes if you are not using it. If your Kindle had wireless on prior to going to sleep, it will continue to receive your regularly scheduled subscriptions while in sleep.

Headphone jack — plug in headphones to listen to an audiobook, background music, or content read aloud through text-to-speech. Attaching headphones turns off the built-in speakers.

BOTTOM VIEW

The bottom of your Kindle contains the charge indicator light and a micro-USB port.

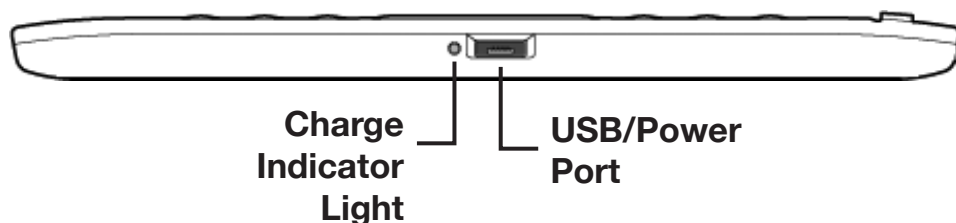

Micro-USB/power port — attach the USB cord that came with your Kindle into the micro-USB/power port and into the Kindle power adapter*. Plug the adapter into a U.S.-compatible electrical outlet to charge the Kindle battery. You can also charge your Kindle by detaching the USB cord from the power adapter and connecting it to a computer's USB port or powered USB hub. The charging status light will turn yellow, indicating that the battery is charging; you can continue to use your Kindle while it charges. A green light indicates that the battery is fully charged.

Check to make sure the power adapter is not covered by anything that could cause it to overheat. If the charge indicator light does not light up, make sure that the USB cable is fully inserted into your Kindle and the power adapter or USB port. If Kindle still is not charging, try another electrical outlet or USB port.

To transfer content between your computer and your Kindle, connect the provided USB cable to the Kindle and to the computer's USB port.

** Not all configurations ship with a power adapter.*

1.2 Getting Around

To get around on your Kindle, you use the buttons, menus, and the keyboard—all of which are explained here.

USING THE BUTTONS

In the Welcome section you learned about the navigation buttons (Previous Page, Next Page, and Back). For an explanation of what each button does, see Front View of Kindle.

USING THE MENUS

In addition to the physical buttons, you also navigate Kindle using the menus. Kindle's menus are context sensitive, but they all work the same way.

You use the 5-way controller to navigate within the menu and press the 5-way to select an item.

The illustration below shows the Home menu; the bold line under “Shop in Kindle Store” indicates that it is ready to be selected.



THE APPLICATION MENU

You can display a menu from any screen on your Kindle. When you press the Menu button, it displays choices related to the screen you are viewing. The sample screen below shows you the screen you would typically see when you press the Menu button from within a book.



1.3 Entering Text

To use the Kindle keyboard, most people find it easiest to hold the device in both hands, and use the tips of their thumbs to press the keys.

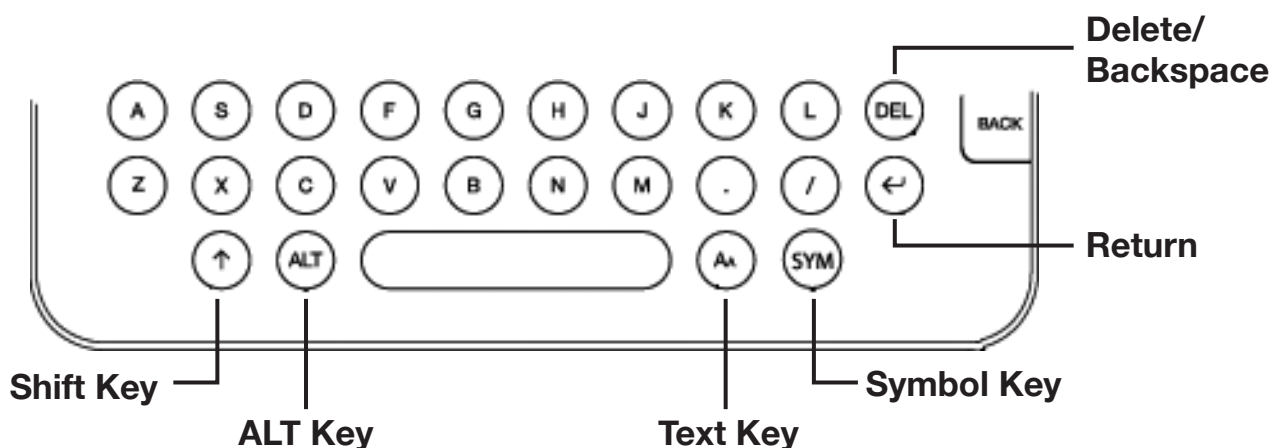

LOWERCASE AND UPPERCASE LETTERS

To enter lowercase letters, press the appropriate letter key. To enter uppercase letters, hold down the Shift key (↑), and then press the desired letter key like you do on your computer keyboard. Alternatively, you can press and release the Shift key (↑) and then press the desired letter. Only the next letter will be capitalized.

NUMBERS, PUNCTUATION, AND SYMBOLS

The number keys are located at the top of the keyboard. If you need a punctuation mark or a symbol that is not shown, press the Symbol key (SYM) on the bottom row of the keyboard. You will see a menu of punctuation marks and symbols.

Use the 5-way controller to choose the character you want and it will appear in your text entry box.

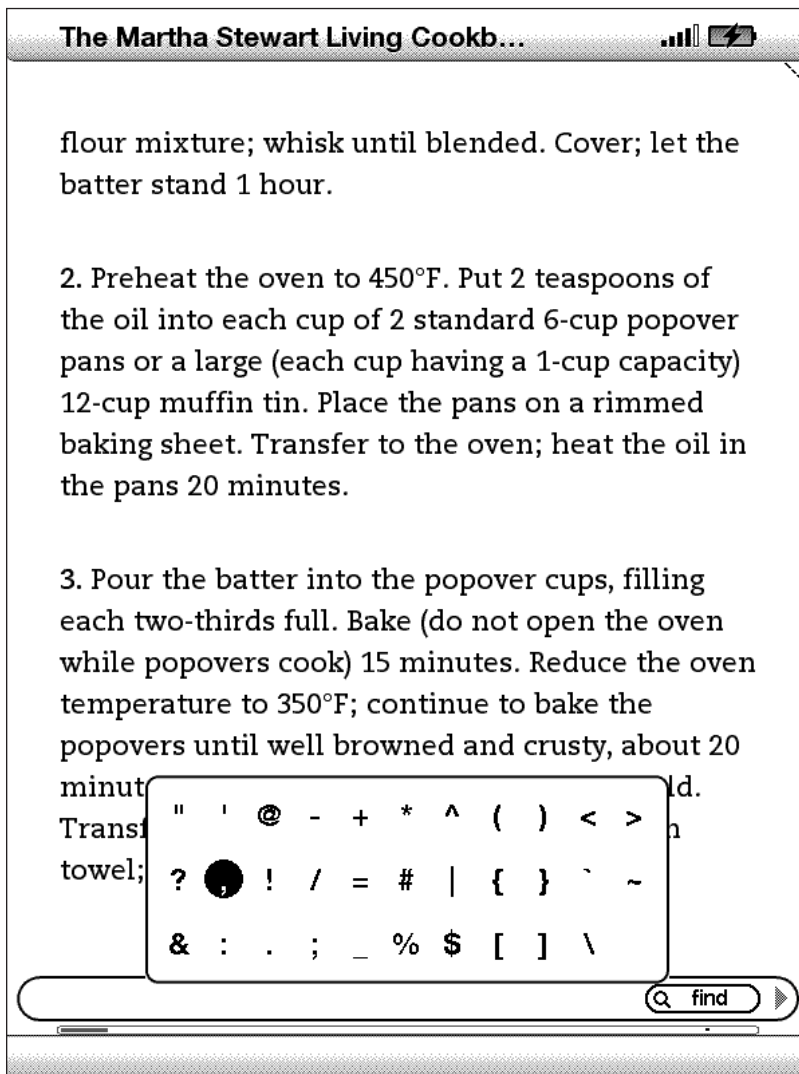

1.4 Screen Rotation

The Kindle screen image can be rotated so you can see the entire width of a web page or magnify the page of a PDF file. The buttons work the same in either rotation, but the 5-way controller movements are switched to match the rotation.

To lock your screen into portrait or landscape mode, follow these steps:

1. Press the Text key  located on the bottom row of the keyboard. Screen Rotation is displayed at the bottom of the menu.
2. Move the 5-way to select one of the four options to lock the display in a set orientation: portrait , landscape with the keyboard on the left, portrait with the keyboard at the top, and landscape with the keyboard on the right.
3. Press the 5-way to confirm your choice.

Note — You can view Kindle Store pages only in portrait mode.

1.5 Status Indicators

At the top of every screen, you also see Whispernet and battery life status indicators to keep you in the know.

WHISPERNET STATUS INDICATORS

The Whispernet status indicator shows you whether the wireless radio is turned on or off, the signal strength of your Whispernet service, and the connection speed. Here are the possible indicators and their meanings.

 The Whispernet service is active and your Kindle has a strong signal. The more bars that are filled in with black, the stronger the wireless signal. Note that a weak signal can increase power consumption.

 None of the bars are filled in. This means the wireless signal strength is too low to connect. You will not be able to connect to the Kindle Store, Basic Web, register your device, retrieve content from Archived Items, receive your subscriptions, or sync to furthest page read.

 The bars are filled in grey. This means Whispernet is checking for signal strength. This usually lasts less than 30 seconds.

 The Whispernet service is turned off. You can turn on the wireless by pressing the Menu button, and using the 5-way controller to navigate to “Turn Wireless On.”

When you activate a menu, icons indicating the speed of your Whispernet service appear to the left side of the signal bars.

 **Kindle with international wireless**

EDGE and GPRS wireless networks are slower than the 3G Whispernet service. Your Kindle World Edition will automatically switch to the faster 3G network when available.

 **Kindle**

The 1X icon indicates that your Kindle is connected to the 1XRTT wireless network. Your Kindle will automatically switch to the faster 3G network when available.

BATTERY STATUS INDICATORS



You have your Kindle plugged into power and the battery is charging. The charge indicator light on the bottom of your Kindle also lights up. Note that if your Kindle is plugged into a low powered USB port such as those found on some keyboards or older computers, you will only derive enough charge to avoid depleting the battery but not enough to recharge it.



The images above show the various states of the battery as it discharges. As you deplete the battery, less of the battery indicator will be filled in.



The battery is too low to power the Whispernet service. You must charge your Kindle battery to restore wireless service.

Keep in mind that subscribing to multiple blogs that update frequently may increase power consumption and decrease the battery life. Weak signal coverage can also increase power consumption

⦿ ACTIVITY INDICATOR

Appears in the top left corner of your Kindle screen when the device is busy downloading new content, checking for new items, searching for an item, opening a large PDF file, or loading a web page. 

CHAPTER 2: Getting to Know Kindle Content

The Kindle Home screen gives you an overall picture of what you currently have on your Kindle. It shows you what has arrived recently, what you are reading, and where you are in your reading. It also allows you to remove content from your Kindle and to move content from Amazon.com to your Kindle. Read below for more details.

2.1 The Home Screen

Your Home screen displays a list of all of your Kindle reading materials — books, newspapers, magazines, blogs, PDF files, personal documents, as well as audiobooks. It serves as a personal bookshelf for all of your reading material, as well as a starting point to access other Kindle features.

To display the Home screen, press the Home button on the right edge of your Kindle. By default, the Home screen lists all of the items that you have on your Kindle beginning with the most recently viewed (or acquired) items. Each type of content has a slightly different description and label. You can read more about the types of content available in Chapter 3.

KINDLE BOOKS

Books are shown by title and author. Below the book title are a series of dots which give you an approximation of how long the book is. Bold dots within the series indicate how far along you are in the book based on the last page you viewed.

PERIODICALS

Periodicals include newspapers and magazines that can be purchased as a single issue or as a subscription delivered on a regular basis. Your Home screen lists the most recent issue of each periodical you have on your Kindle. Older issues appear inside a grouping called Periodicals: Back Issues. Selecting the grouping takes you to a screen that displays the back issues of all the periodicals you have on your Kindle. Note that Kindle automatically deletes issues that are more than seven issues old to free up space for new content. An exclamation point  next to an issue indicates that it will be deleted within 24 hours.

BLOGS

Blogs are subscription-based and appear on the Home screen as a single entry like books. As additional blog content arrives, it is added to the item and older entries are rolled off, much like a blog works on a computer.

AUDIOBOOKS

Audiobooks look similar to books, but they will be labeled in the Home screen as audio content. Like regular books, they have a progress indicator that shows where you are in the audiobook.

PDF FILES

PDF files also look similar to books, but they will be labeled in the Home screen as “pdf.” Like regular books, they have a progress indicator that shows where you are in the file.

HOME SCREEN FEATURES

What you see on your Home screen varies depending on what reading materials you have purchased, and how you choose to show and sort this list. The screen sample and list below explain the features that you may find on your Home screen.

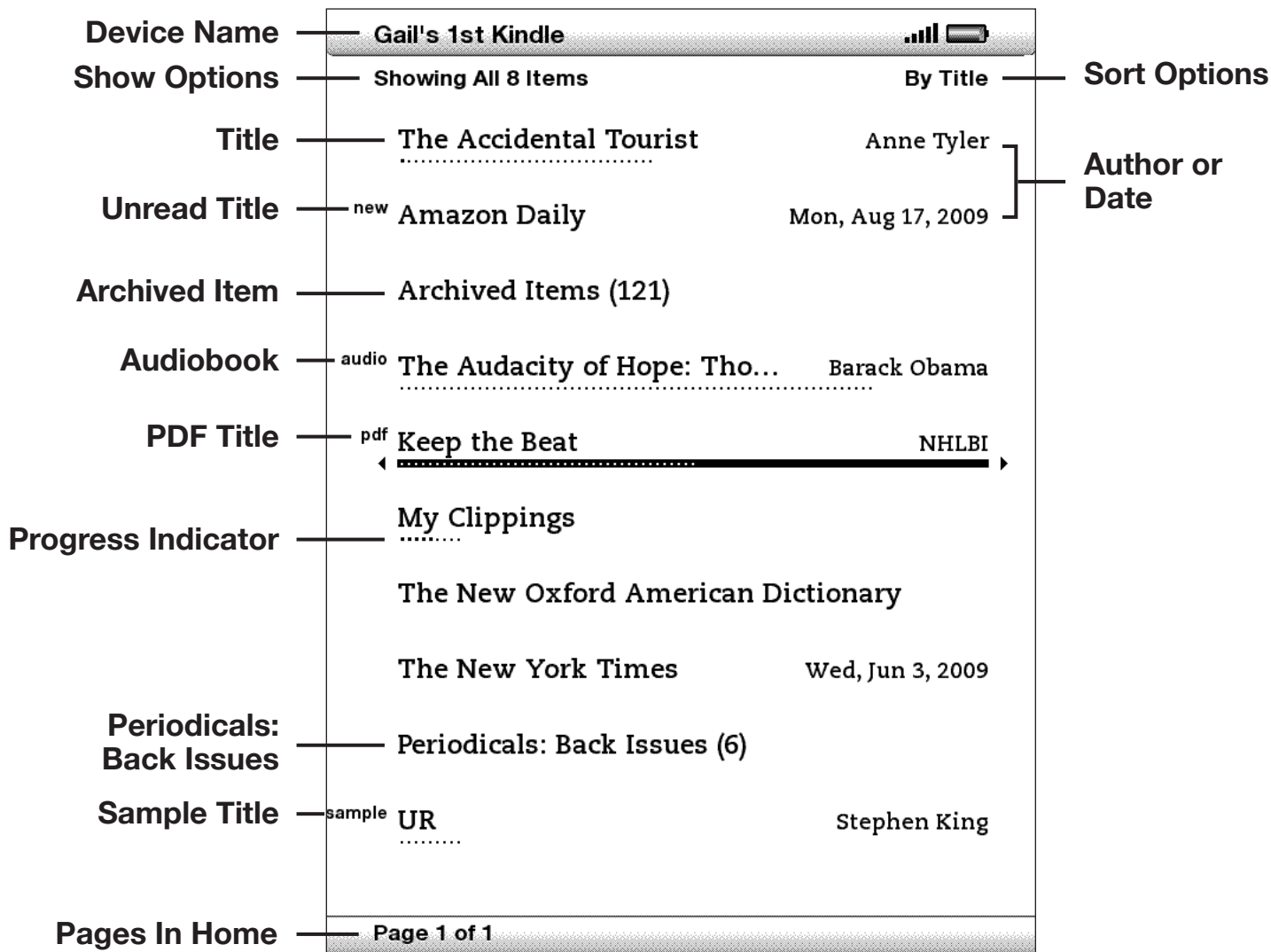

Device name —the name of your Kindle. You can edit this name on the Settings screen.

Show options — choose which types of content you want displayed in Home.

Sort options — choose the order you want content displayed in Home.

Title — the title of the item.

Author or Date — for books, the author of the item is listed. For periodicals and blogs, the date is listed.

Progress indicator — the series of dots below the item shows how long the book is and bold dots show how far you have read in a particular item.

Unread title — the “new” label indicates the item has never been opened and is less than 24 hours old. Once you open a new document or more than 24 hours has passed since the item arrived on your Kindle, the “new” label is removed.

Archived Items — items stored at Amazon.com that you can re-download to your device.

Audiobook title — the “audio” label indicates the book is an audiobook.

PDF title — the “pdf” label indicates the file is a PDF.

Periodicals: Back Issues — stores older issues of newspapers and magazines.

Sample title — the “sample” label indicates the book is a sample. If you like it, you can purchase the full book from within the sample.

Pages — indicates the total number of pages in Home. Use the Next Page or Previous Page button to navigate the pages.

SHOW OPTIONS

The following screen sample shows the location of the Show options and the list below explains each of the options. Moving the 5-way controller to the left lets you select what items to show in Home.

Show Options —

Gail's Kindle [Signal] [Battery]

Personal Docs Subscriptions Books **All My Items**

new **The New York Times - La...** Thu, Sep 10, 2009
.....

new **Amazon Daily** Thu, Sep 10, 2009
.....

new **The New York Times** Thu, Sep 10, 2009

The Accidental Tourist Anne Tyler
.....

My Clippings
.....

Frankfurter Allgemeine Tue, Sep 8, 2009

The Help KATHRYN STOCKETT
.....

The Cook's Illustrated H... The Editors of Co...
.....

The Martha Stewart Livi... Martha Stewart ...
.....

So Brave, Young, and Handsome Enger,Leif
.....

Page 1 of 2

Personal Docs — shows only the Personal Documents you have stored on your Kindle, including PDF files.

Subscriptions — shows only the periodicals and blogs you have stored on your Kindle.

Books — shows only the books and audiobooks you have stored on your Kindle.

All My Items — shows all of the content you have stored on your Kindle.

CHANGING WHAT YOUR HOME SCREEN SHOWS

By default, the Home screen shows all of your content. To change the type of content displayed, follow these steps:

1. If you are not already on the Home screen, press the Home button.
2. Move the 5-way up until the Show and Sort options are underlined.
3. Move the 5-way to the left to see the Show options.
4. Move the 5-way to underline the type of content you want to display.
5. Press the 5-way to select it. The new display option changes immediately.

SORT OPTIONS

The following screen shows the location of the Sort options and the list below explains each of the options. Moving the 5-way to the right lets you change how to sort these items.

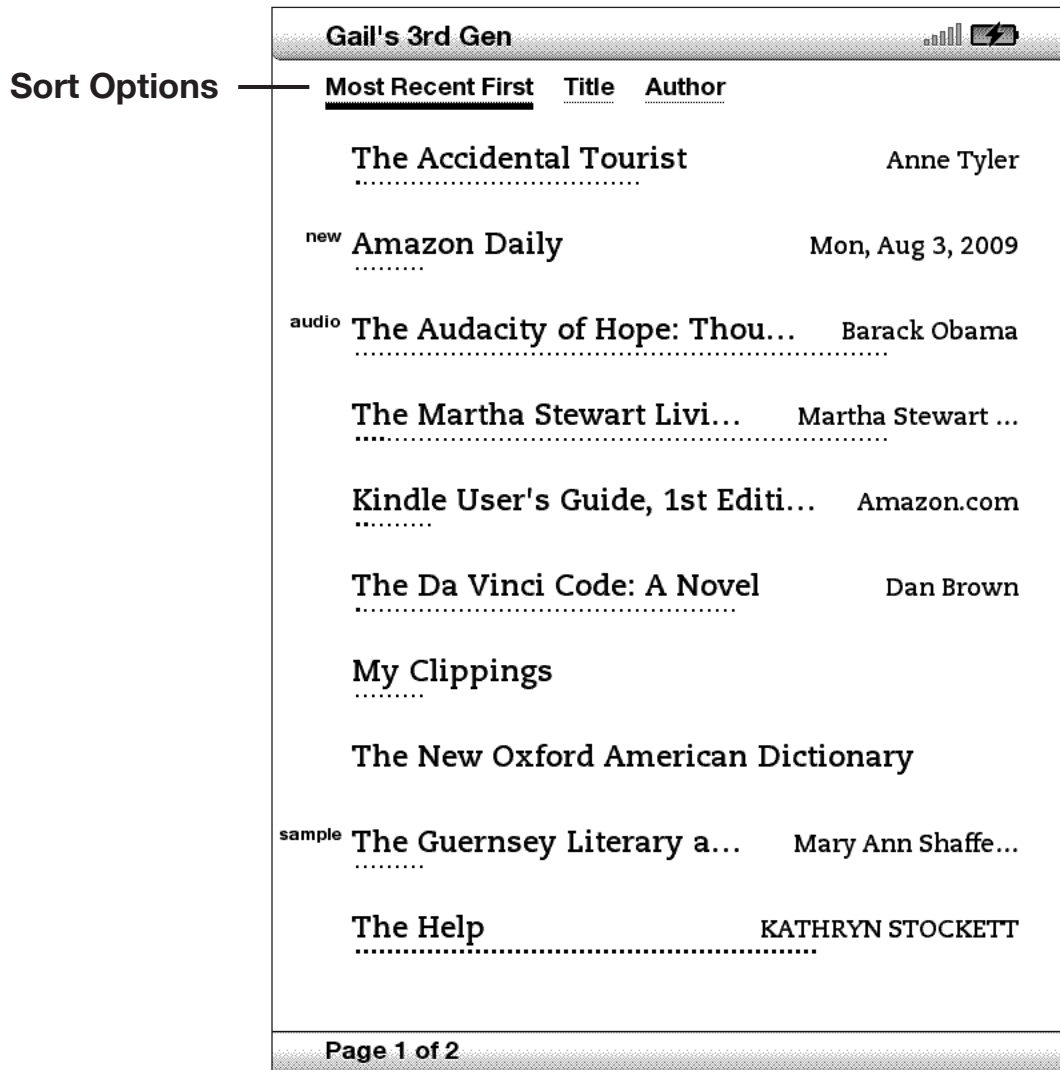

Most Recent First — sorts your content by the most recently added or recently opened items first.

Title — sorts your content alphabetically by title of the item.

Author — sorts your content alphabetically by the author's last name or publisher's name. If you choose this option, periodicals will be sorted by their dates.

CHANGING HOW THE HOME SCREEN IS SORTED

By default, your content is sorted by most recent first, meaning all of the new items and the content you are currently reading are at the top. To change this option, follow these steps:

1. If you are not already on the Home screen, press the Home button.
2. Move the 5-way up until the Show and Sort Options are underlined.
3. Move the 5-way to the right to see the Sort options.
4. Move the 5-way to underline how you want the items sorted.
5. Press the 5-way to select it. The sort order on the Home screen changes immediately.

THE HOME SCREEN MENU

The Home screen menu allows you to navigate to other places in Kindle or to perform specialized tasks. To display the Home screen menu, press the Menu button when your Home screen is displayed. The list below explains the menu.

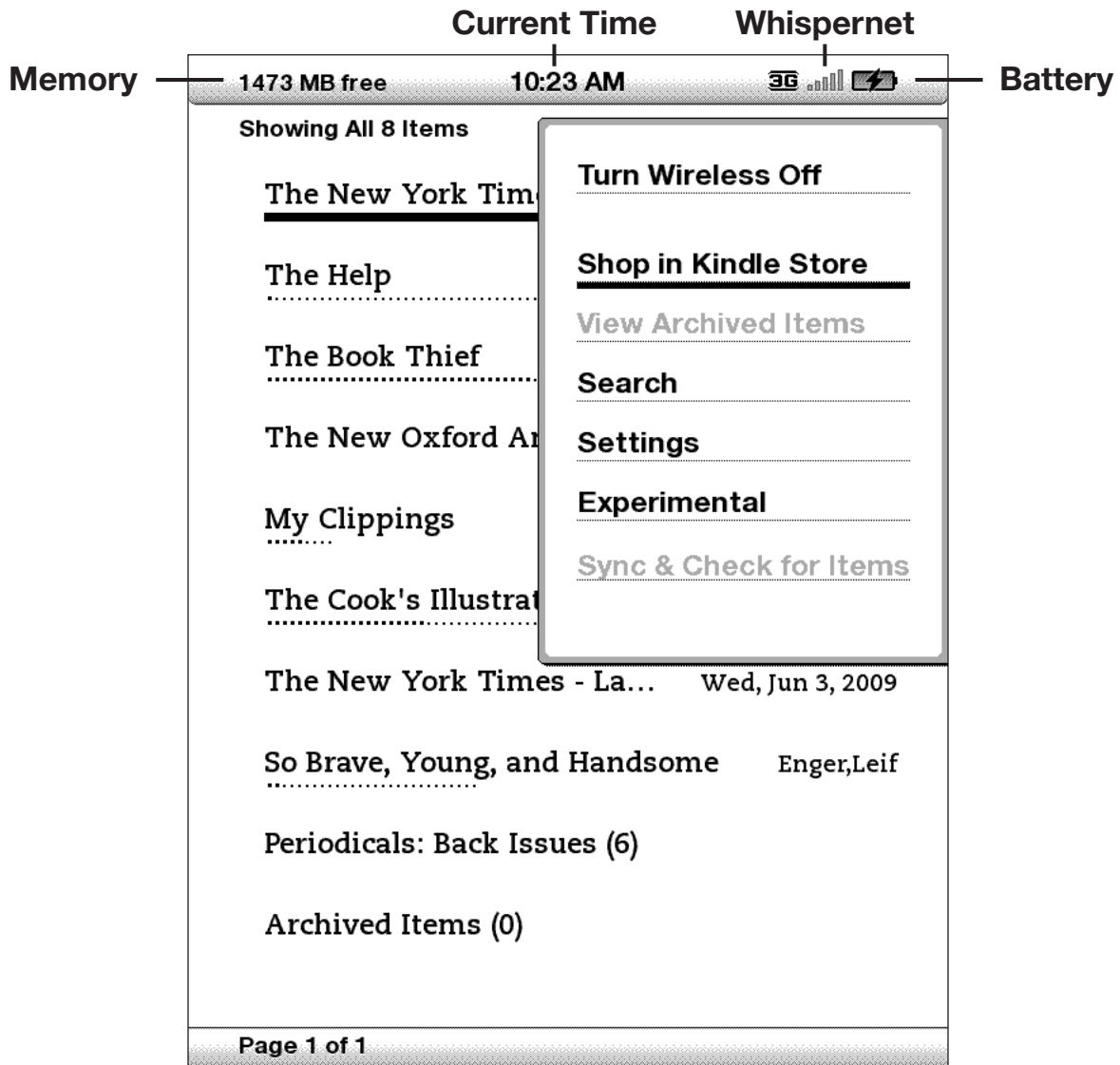

Turn Wireless Off/On — turns the Whispernet service off or on.

Shop in Kindle Store — takes you to the Kindle Storefront.

View Archived Items — takes you to Archived Items where you can view and wirelessly re-download content you are storing at Amazon.com.

Search — brings up the Search text entry page for submitting a word or phrase to search for.

Settings — takes you to the Settings screen.

Experimental — takes you to the Experimental page where you can see and use some of the experimental prototypes we are working on.

Sync & Check for Items — connects to Amazon.com to download any newly available items and sync the furthest page read and bookmarks for all the books on your device.

2.2 Managing Your Content

All books you purchase are automatically backed up on Amazon.com. When you remove a book that you have purchased, it appears in your Archived Items. You access your Archived Items from your Home screen. To move content between Archived Items and Home, Whispernet needs to be on.

REMOVING KINDLE CONTENT

To remove content, follow these steps:

1. If you are not already on the Home screen, press the Home button.
2. In the list of the content already on your device, move the 5-way to underline the item you want to remove.
3. Move the 5-way to the left to remove the item.
4. For books purchased from the Kindle Store you will see “remove from device” and for all other content you will see “delete.” Press the 5-way to remove the content. To change your mind, move the 5-way up or down to cancel. Note that Kindle books are backed up for you at Amazon.com even if removed from the device.
5. For content other than books purchased from the Kindle Store, you will need to confirm the deletion of the content by selecting “ok.”

MORE ABOUT MANAGING ITEMS

Amazon also stores the seven most recent issues of your newspapers and magazines. If you'd like to keep a copy of an issue indefinitely, open the issue, press the Menu button, and select "Keep this Issue"; you will then see the word "keep" to the left of the issue title in Home.

You can download items stored at Amazon.com any time you are within Whispernet coverage. If you are not within coverage, Kindle will automatically download the item when you re-enter Whispernet wireless service.

Personal documents (including PDF files) sent to your Kindle are not backed up at Amazon.com.

When you remove a Kindle book you bought from Amazon, we automatically save all of your annotations for the book in case you ever want to download it again. However, if you remove a subscription issue that is older than seven days, a blog of any age, or an item you did not get from Amazon, any annotations you created on Kindle for those items do not get saved. Your "My Clippings" file will still remain as a separate file containing all the clippings you added regardless of whether the content is a book, subscription, or blog or was purchased from Amazon or not. See Chapter 3 for more information.

INTERNATIONAL WIRELESS DELIVERY

(Kindle with international wireless only) If you wirelessly receive or download content to your Kindle via Whispernet while outside the U.S., additional fees may apply. For further information go to: <http://www.amazon.com/kindlewhispernetroaming>



CHAPTER 3:

Reading on Kindle

Kindle retains the best qualities of printed books, but adds many features that are available only through digital technologies such as word look up, changeable text size, and clippings. This chapter explains more about Kindle's reading features.

3.1 Types of Content

There are many types of reading material available for your Kindle such as books, newspapers, magazines, and blogs. If you want to begin purchasing and downloading reading material, you can learn more in Chapter 5. You can also purchase audiobooks from Audible.com and even have Amazon convert and deliver personal documents to your Kindle. The different types of supported content are described below.

BOOKS

Thousands of books — both popular and hard-to-find — are available in the Kindle Store. Once you buy a book, it usually arrives wirelessly in under a minute. Because you can't always judge a book by its cover, you can download and read a sample of most Kindle books for free. If you like it, simply buy it from within the sample and continue reading. You can learn more about this feature in Chapter 5.

NEWSPAPERS

The Kindle Store offers a selection of U.S. and international newspapers. Subscriptions are delivered wirelessly to your Kindle overnight so that the latest edition can arrive on your device every morning, and every newspaper subscription starts with a free trial.

MAGAZINES

The Kindle Store offers an expanding selection of magazines to meet every interest. As with newspapers, all periodical subscriptions are delivered wirelessly and start with a free trial.

BLOGS

The Kindle Store offers thousands of Kindle blogs, including up-to-the-minute news feeds and topical blogs. Blog categories include business, technology, sports, politics, culture, entertainment, humor, and science. Kindle blogs are sent to you wirelessly throughout the day, allowing you to keep current. Unlike traditional feeds, which often only provide headlines, Kindle downloads the complete feed onto the device so you can read them even when you are not wirelessly connected. All blog subscriptions are delivered wirelessly and start with a free trial.

PERSONAL DOCUMENTS

In addition to purchased content, you can read your personal documents on Kindle.

Kindle can display a PDF document without losing the formatting of the original file. You can either drag PDF files over USB to your device or e-mail them to your dedicated Kindle e-mail address (found on the Settings page on Kindle or the Manage Your Kindle page on Amazon.com). When you choose to e-mail a PDF, we will wirelessly provide it directly to your Kindle via Whispernet for a fee. You can also press the Text key  to change the orientation of your display to widescreen viewing. For more information on the unique aspects of reading PDF files on Kindle, see Section 3.6.

Additionally, if you have files formatted as text, Microsoft Word, HTML, PDF, or image files like GIF or JPEG, you can e-mail the files as attachments to your Kindle e-mail address. Amazon will convert the files if necessary and send them back to your computer for free or via Whispernet to your Kindle for a fee, whichever you prefer. For more information on transferring, converting, and e-mailing your personal documents, see Chapter 8.

For details on fees, see the “Your individual charges” section of your Manage Your Kindle page on Amazon.com.

AUDIOBOOKS

You can download and enjoy thousands of audiobooks from Audible.com. Due to their large file size, audiobooks must be downloaded to your PC or Mac over your existing Internet connection and then transferred to Kindle over USB. Listen to audiobooks through Kindle's speakers or plug in your headphones for private listening. For more information on transferring and listening to audiobooks, see Chapter 8.

BACKGROUND MUSIC

If you like to listen to music while you use your Kindle, use your computer to transfer MP3 files to the "music" folder on your Kindle. When you select "Play MP3" from the Experimental page, each of the songs will play in the order they were added to your Kindle.

3.2 Content Formatting on Kindle

When you read a book on Kindle, you will find that the formatting generally follows the printed version of the book. If the book has a table of contents, it will appear in Kindle. If the book has chapters, a preface, an illustrated cover, and so forth, these will be displayed.

While you are reading, each page displays a header showing the content title and/or issue date. The top of the page shows the battery and Whispernet status indicators.

The screenshot shows a Kindle page with a header bar at the top. The header bar contains the title "The Da Vinci Code: A Novel" on the left and signal strength and battery icons on the right. The main text area contains several paragraphs of text, including a paragraph about Hebrew spelling, a dialogue line from Sophie, and a section titled "B a P V o M e Th". Below the text is a progress indicator bar. The progress indicator shows a progress bar at 70%, with "Locations 5000-5007" and "7087" marked. The labels "Progress Indicator" and "Locations" are positioned to the left and right of the bar respectively.

The Da Vinci Code: A Novel [Signal Strength] [Battery]

spelling, the vowel sounds are not written. Therefore, when we write the word *Baphomet* using the Hebrew alphabet, it will lose its three vowels in translation, leaving us—

“Five letters,” Sophie blurted.

Teabing nodded and began writing again. “Okay, here is the proper spelling of Baphomet in Hebrew letters. I’ll sketch in the missing vowels for clarity’s sake.

B a P V o M e Th

“Remember, of course,” he added, “that Hebrew is normally written in the opposite direction, but we can just as easily use Atbash this way. Next, all we have to do is create our substitution scheme by rewriting the entire alphabet in reverse order opposite the original alphabet.”

“There’s an easier way,” Sophie said, taking the pen from Teabing. “It works for all reflectional substitution ciphers, including the Atbash. A little trick I learned at the Royal Holloway.” Sophie

Progress Indicator — 70% — Locations 5000-5007 — 7087 — **Locations**

PROGRESS INDICATOR



At the bottom of every page of your reading material, you can see where you are by glancing at the progress indicator. As you progress further into the content, you will see a solid bar growing longer. The progress indicator also shows structural marks within content such as chapters, articles, bookmarks, notes, or highlights.

In books, the progress indicator also shows you the overall percentage of the book you have read and a numeric location of where you are reading, so you can easily find a particular passage or reference it to your friends. Locations are the digital answer to page numbers. Changing the text size on Kindle also changes the page numbering, but with locations, you return to the same place every time regardless of the text size.

CHANGING THE TEXT SIZE

You can adjust the size of the text to suit your preference. You have a choice of six sizes for reading content on Kindle. (You cannot change the text size on menus, in PDF files, or on Kindle screens, such as the Home screen or the Kindle Store.)

To pick the text size that you want to use while reading, follow these steps:

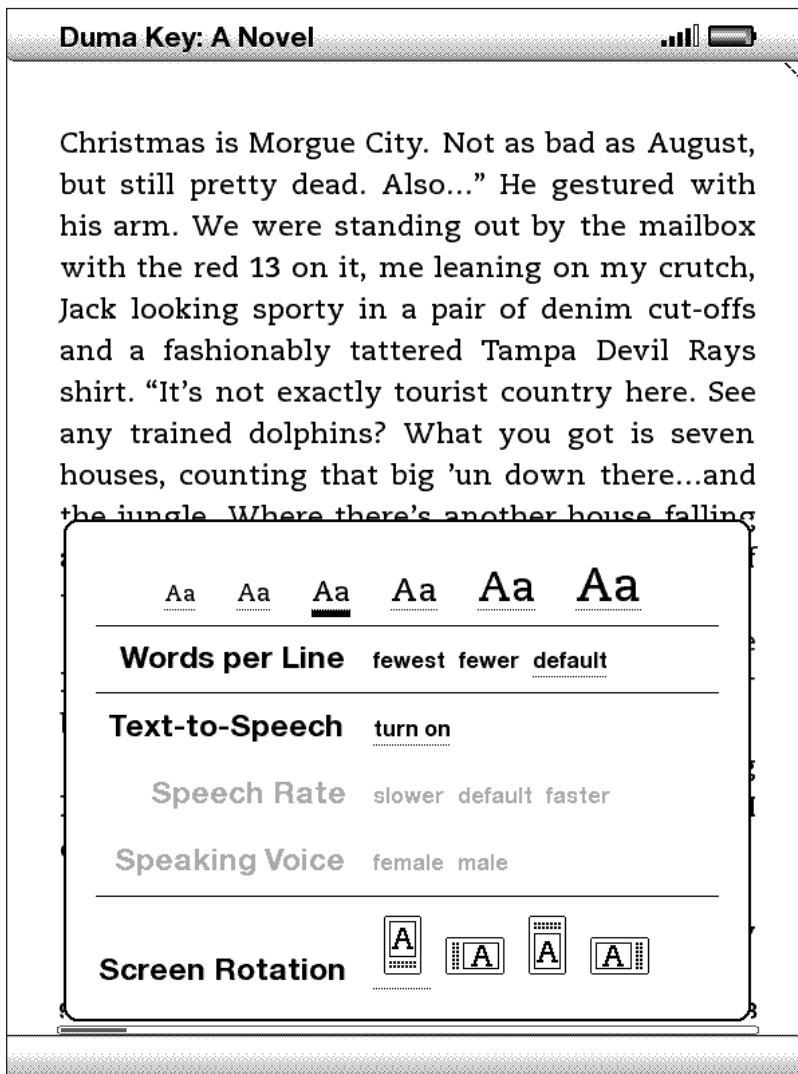

1. Press the Text key  located on the bottom row of the keyboard. The text size choices are displayed as well as controls for Text-to-Speech.
2. Move the 5-way left or right to the new text size that you want to use (you see the new text size immediately).
3. Press the 5-way or the Text key  to confirm your choice.



ADJUSTING THE NUMBER OF WORDS PER LINE

You can change the number of words per line in the book, periodical, or personal document you are currently reading to suit your reading preference. Adjusting the number of words increases or decreases the size of the margins. You may find you read faster with fewer words per line. Experiment to find what works best for you.

To pick the number of words per line you prefer, follow these steps:

1. Press the Text  key located on the bottom row of the keyboard. The Words per Line choices are displayed below the text size choices.
2. Move the 5-way down to underline the Words per Line options.
3. Move the 5-way left or right to choose the option you want to use (you see the change immediately).
4. Press the 5-way or the Text key  to confirm your choice.

Note: You cannot change the number of words per line in PDF files or in Basic Web.

INCREASING THE SIZE OF A PICTURE

If you'd like to see a larger size of a picture or image you encounter in your reading material, simply follow these steps to zoom temporarily on the image.

1. Use the 5-way controller to position the cursor over the picture.
2. An image of a magnifying glass with a plus sign  will appear on top of the picture.
3. Press the 5-way to zoom the image. You will see an expanded view of the picture that rotates if necessary to maximize the use of the display.
4. Press the 5-way (or any key or button, except the Home button) to return to your content.

3.3 Moving from Place to Place

There are several ways for you to get from place to place once you have opened your reading material. Most often you will turn pages using the Next Page and Previous Page buttons (described in Chapter 1). You can also get around inside your book or periodical by selecting locations from the item's Menu, clicking on links in the content, or by moving the 5-way controller left or right to advance to another article or chapter.

USING THE MENU TO GET AROUND

To go to the menu, press the Menu button when reading a book or periodical. You will have slightly different options depending on the content you are reading. Examples of the menu options are described below.



If you are reading a Kindle book, the menu shows the following options:

Turn Wireless Off — turns off Whispernet. When Whispernet is off, this option will change to “Turn Wireless On.”

Shop in Kindle Store — takes you to the Kindle Storefront.

Buy This Book Now — connects to the Kindle Store, purchases, and downloads the full book to your Kindle. Only appears if you are reading a sample from the Kindle Store.

Cover — takes you to the cover page of the item you are reading. This is usually the cover of the book.

Table of Contents — takes you to the Table of Contents for the item you are reading.

Go to Beginning — takes you to the place in the book the publisher considers to be the beginning. This is usually the first chapter, but may be a foreword, the table of contents, or other point the publisher chooses.

Go to Location... — displays at the bottom of the screen, a text entry box that allows you to specify a location to jump to in the content.

Sync to Furthest Page Read — connects to Amazon.com and compares your current reading location with the one saved at Amazon. If you are further along in your book using another device, Kindle gives you the choice to go to the furthest page read.

Book Description — connects to the Kindle Store and displays the book’s detail page.

Search This Book — displays the Search line at the bottom of the screen. Additional details on how to conduct a search are provided in Chapter 4.

Add a Bookmark — bookmarks the page you are currently on. After selecting this option, the upper right corner of the book will be dog-eared and this menu option will change to “Delete Bookmark.”

Add a Note or Highlight — puts you into annotation mode. Additional details on how to create a note or highlight are provided later in this chapter.

My Notes & Marks — displays a page containing all of your current item’s notes, highlights, and bookmarks.

If you are reading a newspaper or magazine, you will see the following different options:



Clip This Article — makes a copy of the entire article and adds it to your “My Clippings” file.

Keep This Issue — designates the newspaper or magazine issue as one to be stored in your Kindle until you remove it.

If you are reading a blog, you will see the following options:



NAVIGATING WITHIN A PERIODICAL

At the bottom of a newspaper or magazine you will see options for quickly navigating within an issue. When viewing a blog, you will see similar options for navigation.

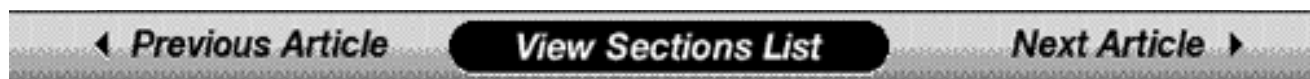

Previous Article — takes you to the previous article when you move the 5-way controller to the left.

View Sections List — takes you to the sections list of a newspaper or magazine when you press the 5-way.

View Articles List —takes you to the articles list of a blog when you press the 5-way.

Next Article — advances you to the next article when you move the 5-way controller to the right.

By default, “View Sections List” for newspapers and magazines is highlighted and when you press the 5-way, a list of the sections will appear. If you are viewing a blog, “View Articles List” is highlighted and pressing the 5-way shows a list of the blog’s articles.



To navigate to a particular section, use the 5-way controller to underline the section title and then press the 5-way to select. To dismiss this view and return to where you were last reading in the magazine or newspaper, select "Close Sections List" located at the bottom of the screen. Selecting the number to the right of the section title will take you to a list of articles found within that section.

The New York Tim... • Jun 3, 2009 .lll ⚡
The Arts • 20 Articles
<u>Music Review: From Public Problems to Personal Pleasures at th...</u> BY JON PARELES The Dave Matthews Band was in song mode at
Mike Doyle of 'Law & Order' Chalks Up His Seventh Death ... BY MICHAEL WILSON Mike Doyle, who was killed off of NBC's "Law &
Is Slam in Danger of Going Soft? BY LARRY ROHTER Marc Kelly Smith has expressed mixed feelings
Dance Review: Love Is in Full Flower in Premiere of Ale... BY ALASTAIR MACAULAY The curious specialty of the choreographer
With Titles Like 'Planet 51,' Computer-Animated... BY BROOKS BARNES Computer animation, once one of the most
Music Review: A Teenager's Keen Emotions, Seen From a... BY BEN RATLIFF Jessica Lea Mayfield sings in a dry voice for a
Page 1 of 4
Close Articles List

To navigate to a particular article within a section or blog, simply move the 5-way controller to underline the article title and press to select. To dismiss this view, select "Close Articles List" located at the bottom of the screen.

SELECTING INTERNAL LINKS

Your reading material may also contain links to other places in the document. For example, in many books, the table of contents is set up to link to the content pages. Links are easy to spot because they are underlined.

To select a link:

1. Move the 5-way over the link.
2. The cursor changes to look like this: 
3. Press the 5-way to select the link.
4. Kindle takes you to the linked location.
5. Press the Back button to go back to where you were.

Your reading material may also contain external links that take you to locations on the Web (if you have Whispersnet turned on and are in range).

VIEWING A TABLE

Your reading material may contain a large table that is not entirely contained within the screen. To see the rest of the table, move the 5-way controller up or down to bring up the cursor and then place the cursor to the left of the table. Move the 5-way to the right to scroll through the rest of the table.

READING ACROSS MULTIPLE KINDLES

If you read the same Kindle Store book across multiple Kindles (including Kindle for iPhone), you'll find Whispersync makes it easy for you to switch back and forth. Whispersync synchronizes the bookmarks, notes, highlights and furthest page read among devices registered to the same account.

Whispersync is on by default to ensure a seamless reading experience for a book read across multiple Kindles. If you would like to turn Whispersync off, follow these steps:

1. Go to <http://www.amazon.com/manageyourkindle>
2. At the bottom of the page, click on the link, "Manage synchronization between devices."
3. Select "Turn Synchronization off."

Once you turn synchronization off, your books will still open to the last page read on that device, but Whispersync will no longer sync bookmarks or the furthest page read with other devices. If you would like to sync the book manually, press the Menu button and select "Sync to Furthest Page Read."

3.4 Looking Up Definitions

While reading a book, periodical, or personal document (except PDF), you can see a brief definition of a word using the Lookup feature. You can choose the dictionary you want to use when you look up words while you are reading. The default is *The New Oxford American Dictionary* included on your Kindle, but you can change your dictionary choice by purchasing a different dictionary from the “Kindle Default Dictionary” category in the Kindle Store. See Chapter 7 for details on how to change your default dictionary.

THE LOOKUP FEATURE

To see the definition of a particular word in your reading content, follow these steps:

1. Move the 5-way controller up or down to display the cursor.
2. Move the 5-way in front of the word you want to look up.
3. If the word is found in the dictionary, a definition extract appears at the bottom of the screen.
4. To see the complete definition, press the Return key . You will now be placed in the dictionary and can use Previous Page and Next Page to view other word definitions.
5. Press the Back button to return to your reading.

 *Tip: If you want to expand your search beyond the dictionary on your device, you can use the Search feature to look for the word on Wikipedia or the Web. See Chapter 4 for more information.*

3.5 Annotations and Clippings

You can add annotations to all of your books, periodicals, and personal documents (except PDF). Annotations can include notes you have written, highlights you’ve marked, and bookmarks you’ve created. Annotations are specific to the content you are reading, so each book or periodical has its own annotations. When you view the annotations, you see only those for the content you are currently reading. Note that when you create an annotation in a newspaper or magazine, you will see the word “keep” to the left of the issue title in Home, indicating that the issue will be stored on your Kindle until you remove it.

Kindle also gathers the annotations you've made across all your various books, magazines, newspapers, and personal documents and places them in the "My Clippings" file in your Home screen. See Using Clippings for more information on My Clippings.

The list below explains the types of annotations:

Bookmarks — mark an entire page for later reference.

Highlights — mark a passage on a page for later reference.

Notes — add your thoughts about a passage.

The sections below explain how to add annotations.



Tip: All of your annotations on a Kindle book are backed up on Amazon servers in case you transfer your Kindle to another person or lose or break the device. When you download a previously annotated book from Amazon.com, your annotations and last location read will come down with it. When you open the book, you will be right where you were the last time you read the book and all of your annotations will be included. Note that your "My Clippings" file is not listed as a separate downloadable item.

USING BOOKMARKS



Although Kindle automatically saves your place whenever you stop reading, you may also want to add additional bookmarks. You can place a bookmark at any location, and you can have multiple bookmarks in whatever book you are reading. When you add a bookmark, it is associated with the first location on the page. If you change text size, the bookmark will still be associated with that location. You can return to a bookmarked location at any time.

Kindle stores all your bookmarks for the current content in your annotations. You can view them at any time by pressing the Menu button and selecting "My Notes & Marks."

PLACING A BOOKMARK

To place a bookmark:

1. Go to the page that you want to bookmark.
2. Press the Menu button.
3. Move the 5-way controller down until “Add a Bookmark” is underlined. Press the 5-way to select.
4. A dog-ear icon in the upper right corner of the page will appear, indicating that the page is bookmarked.

 *Tip: You can quickly create a bookmark by either holding down the Alt key  and pressing the ‘B’ key, or by moving the 5-way up or down to go into cursor mode and then pressing the 5-way controller twice.*

VIEWING YOUR BOOKMARKS

To view your bookmarks, press the Menu button and select “My Notes & Marks.” Bookmarks are listed in the order they occur in the content. Each bookmark entry shows a location number and the first line of the bookmarked location.



To go to a bookmark location, navigate to the bookmark and press the 5-way.

There is no limit to the number of bookmarks that you can set.

REMOVING A BOOKMARK

To remove a bookmark:

1. Go to the bookmarked page.
2. Press the Menu button.
3. Move the 5-way controller down until “Delete Bookmark” is underlined. Press the 5-way to select. The bookmark is removed.

 *Tip: You can also remove a bookmark on the page by holding down the Alt key  and pressing the ‘B’ key.*

To remove several bookmarks at one time:

1. Press the Menu button.
2. Move the 5-way controller down until “My Notes & Marks” is underlined. Press the 5-way to select it.
3. Using the 5-way, navigate to the bookmark you want to remove.
4. Press the Delete key .
5. Repeat steps 3 and 4 until you have removed all unwanted bookmarks.
6. Move the 5-way down until the “Close Notes & Marks” button is highlighted and press the 5-way to exit. You can also exit this view by pressing the Back button.

USING HIGHLIGHTS

You can highlight text in Kindle like you would use a highlighter pen on paper. Kindle stores all your highlights for the current content in your annotations. You can view them at any time by pressing the Menu button and selecting “My Notes & Marks.” See Viewing Your Annotations for more information.

Kindle also stores everything you highlight in your “My Clippings” file.

HIGHLIGHTING A PASSAGE

To highlight one or more lines, follow these steps:

1. Use the 5-way to position the cursor where you want to start highlighting.
2. Press the 5-way.
3. Move the 5-way right (or left) to where you want your highlight to end. You can turn pages if you want to highlight text across multiple pages.
4. Press the 5-way at the place where you want the highlight to end.
5. Notice that the text you highlighted appears with a gray underline.

DELETING A HIGHLIGHT

To remove a highlight, follow these steps:

1. Navigate the cursor over the highlight you want to remove.
2. Press the Delete key 

Or,

1. Press the Menu button.
2. Move the 5-way controller down until “My Notes & Marks” is underlined. Press the 5-way to select it.
3. Using the 5-way, navigate to the highlight you want to remove.
4. Press the Delete key 
5. Move the 5-way down until the “Close Notes & Marks” button is highlighted and press the 5-way to exit. You can also exit this view by pressing the Back button.

USING NOTES

To add a note, follow these steps:

1. Using the 5-way, move the cursor to the left of the word where you want to add your thoughts.
2. Type your note.
3. Using the 5-way navigate the cursor over “save note” and press the 5-way.

Notice the superscripted number where you inserted your note. Notes are numbered in the order they appear in the content, so if you later create another note on an earlier page, the numbering of the previously created notes will change.

To edit a note, follow these steps:

1. Use the 5-way to move the cursor over the note’s number.
2. The note appears at the bottom of the screen.
3. Press the Return key  to edit the note.
4. Use the keyboard to make your changes.
5. Navigate the 5-way over “save note” and press the 5-way.

To delete a note, follow these steps:

1. Use the 5-way to move the cursor over the note's number.
2. The note appears at the bottom of the screen.
3. Press the Delete key  to delete the note.



Tip: You can also view the notes and highlights you've created for each of your Kindle books at <http://kindle.amazon.com>.

VIEWING YOUR ANNOTATIONS

To view your bookmarks, highlights, and notes, press the Menu button and select "My Notes & Marks."

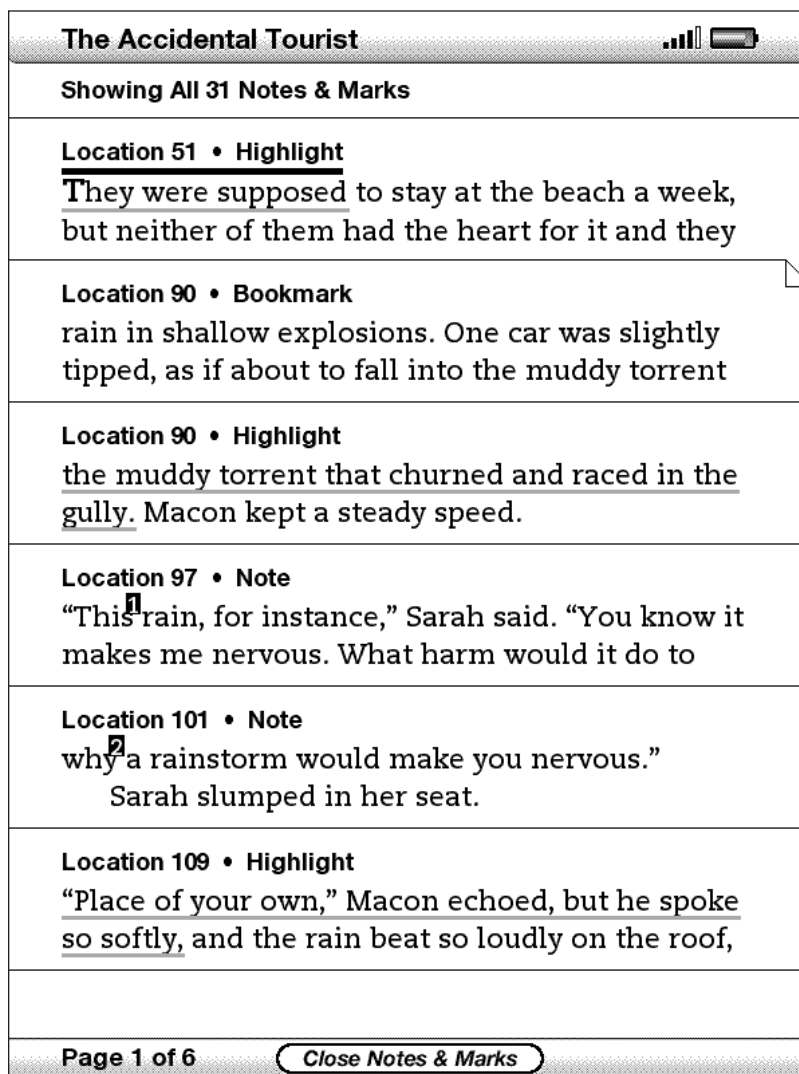

The Accidental Tourist 

Showing All 31 Notes & Marks

Location 51 • Highlight
They were supposed to stay at the beach a week, but neither of them had the heart for it and they

Location 90 • Bookmark
rain in shallow explosions. One car was slightly tipped, as if about to fall into the muddy torrent

Location 90 • Highlight
the muddy torrent that churned and raced in the gully. Macon kept a steady speed.

Location 97 • Note
“This¹ rain, for instance,” Sarah said. “You know it makes me nervous. What harm would it do to

Location 101 • Note
why² a rainstorm would make you nervous.”
Sarah slumped in her seat.

Location 109 • Highlight
“Place of your own,” Macon echoed, but he spoke so softly, and the rain beat so loudly on the roof,

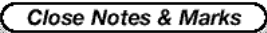
Page 1 of 6 

Each entry has a location number followed by the bookmark, highlighted passage, or note. Your annotations are listed in the order that they occur in the content. There is no limit to the number of annotations you can have. Use the Next Page and Previous Page buttons to turn the pages just as you would in a book.

To go to a location, move the 5-way up or down to select the bookmark, highlighted passage, or note and press the 5-way to go there.

Your annotations are also stored in your “My Clippings” file for later reference. See below for more information.

USING CLIPPINGS

In addition to annotations, you can “clip” an entire periodical article to the “My Clippings” file. The “My Clippings” file contains all of the bookmarks, highlights, notes, and clippings you have made across all your content. Later, you can view the file or copy it to your computer; it will download to your computer as TXT file. Once on your computer, you can edit it or send your clippings to someone else. Clipping and highlighting are a great way to capture your favorite quotes and share with others.

To clip an article:

1. Go to the article you want to clip.
2. Press the Menu button.
3. Move the 5-way controller down until “Clip this Article” is underlined. Press the 5-way to select.

Kindle adds your clipping to the “My Clippings” file. You can review your clippings later, search for words or terms you clipped, and transfer the “My Clippings” file to your computer.

To view your clippings, press the Home button to display the Home screen. Move the 5-way down until “My Clippings” is underlined. Press the 5-way to open it. While viewing the file, you cannot navigate through to the materials referenced in the file.

MORE ABOUT MY CLIPPINGS

You cannot edit the “My Clippings” file from within Kindle, but you can edit the file on your computer.

To edit the “My Clippings” file:

1. Connect your Kindle to your computer using the USB cable.
2. Your Kindle should appear on your computer in the same location you would normally find an external USB drive.
3. Open your Kindle. You should see a folder entitled Documents. Transfer the “My Clippings” file out of this folder.
4. Open the “My Clippings” file on your computer using an application that can read or import a .txt file.
5. Make the changes and save the edited file.
6. Transfer the “My Clippings” file back to the “Documents” folder on your Kindle.
7. Unmount your Kindle from your computer before removing the USB cable.

Changing your “My Clippings” file does not affect any notes, bookmarks, or highlights you’ve made in the actual content. The next time you read the content, you can still use them for navigation and reference.

To remove the “My Clippings” file from your Kindle:

1. Press the Home button and move the 5-way down until “My Clippings” is underlined.
2. Move the 5-way to the left.
3. Press the 5-way to select “delete.”
4. Press the 5-way to select “ok.”

Kindle adds a new “My Clippings” file the next time you add a clipping or annotation to any content.

The amount of text you can add to the “My Clippings” file from each item may be limited. The “My Clippings” file will include a note informing you if a clipping limit has been reached for a given item.

3.6 Reading PDF Files

Your Kindle is able to display most PDF documents. (Note that password-protected PDF files are not supported.)

When your Kindle is set to portrait orientation, PDF documents are displayed in their original layout and fit the entire screen of the device. White margins of PDF documents are automatically cropped to maximize the amount of content shown on the screen.

Let the Nutrition Facts Label Guide You to Healthy Choices

Shopping for the right food item can be dizzying. Shelves are packed with different brands, some with special health claims.

There's a surefire way to pick out the best item: Read its Nutrition Facts Label. This label gives you x-ray eyes. It tells you nutritional value and number of servings in an item.

The label has another asset too—the Percent Daily Value listing. This tells you how much each serving of the item supplies of the day's recommended intake for total fat, saturated fat, cholesterol, sodium, total carbohydrate, dietary fiber, vitamins A and C, calcium, and iron. Not bad.

Use the Nutrition Facts Label to compare foods. As a guide, if you want to consume more of a nutrient (such as fiber), try to choose foods with a higher Percent Daily Value; to consume less of a nutrient (such as saturated fat, cholesterol, or sodium), choose foods with a lower Percent Daily Value. Try the "5–20" guide—an easy way to use the Percent Daily Value to compare the nutrients in similar foods. So, for nutrients

Nutrition Facts	
Serving Size 1/2 cup (67g)	
Servings Per Container 16	
Amount Per Serving	
Calories 100	Calories from Fat 0
% Daily Value	
Total Fat 0g	0%
Saturated Fat 0g	0%
Cholesterol 0g	0%
Sodium 60mg	3%
Total Carbohydrate 22g	7%
Dietary Fiber 0g	0%
Sugars 15g	
Protein 3g	
Vitamin A 2%	Vitamin C* 0%
Calcium 45%	Iron* 0%

*Percent Daily Values are based on a 2,000 calorie diet.

10% Page 9 9
(17 of 156)

In landscape orientation, Kindle automatically magnifies your document to fit the width of the screen to improve readability.

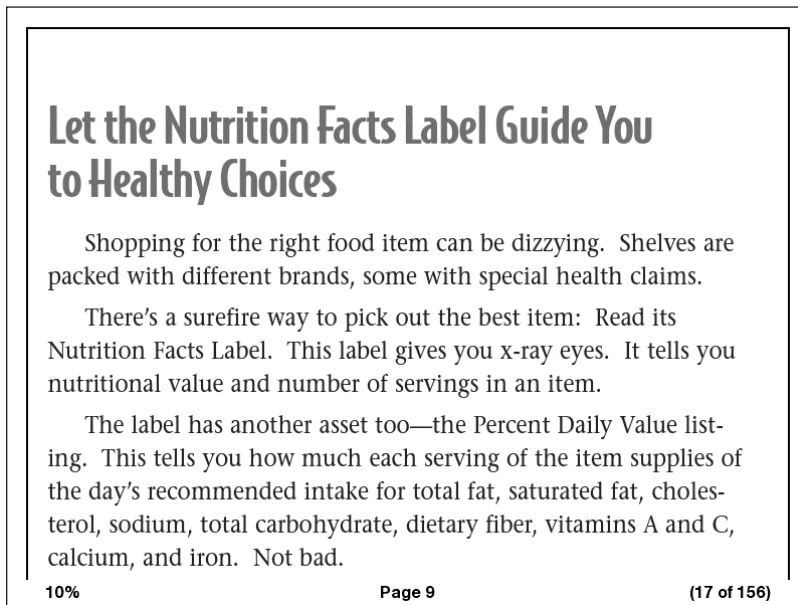

A black outline defines the limit of the page of the PDF document. In both portrait and landscape orientations, the bottom of the screen shows how far you have read in a particular item as a percentage, and displays the current page number, as well as the total number of pages of the current document.

USING THE PDF MENU

The options available while reading a PDF file are slightly different than when reading a book or a periodical on Kindle. Options that are not available in PDF files are grayed out in the menu.

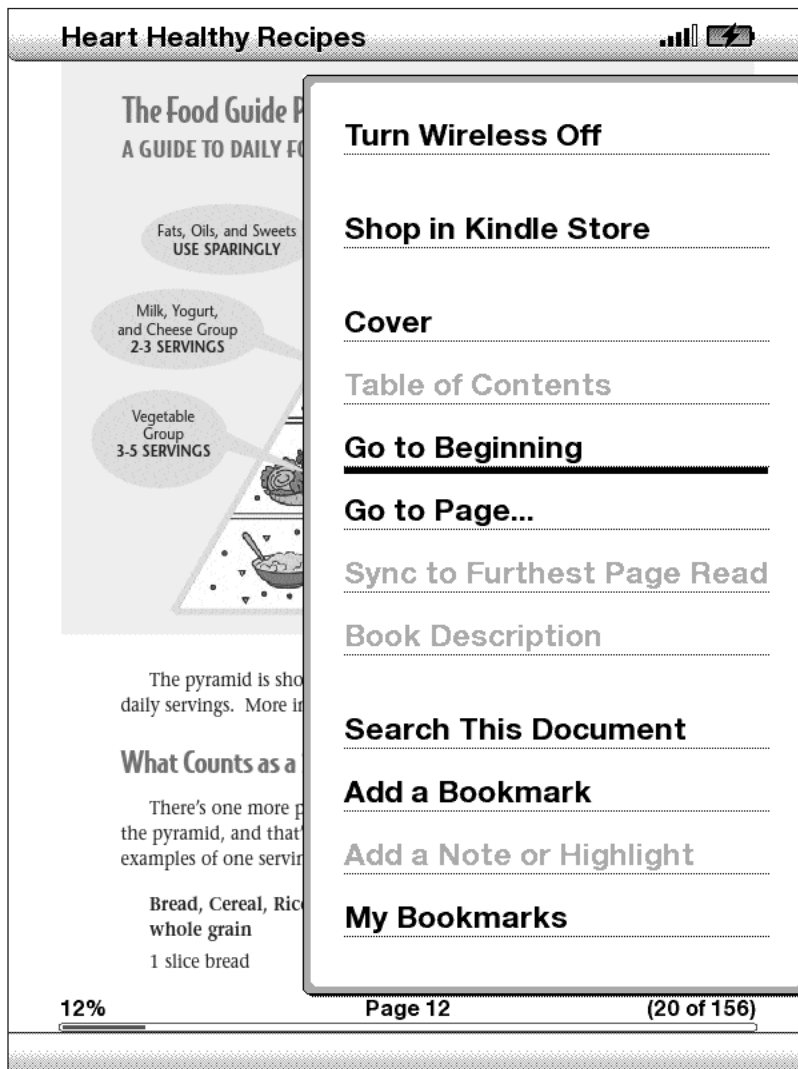

Cover — takes you to the cover page of the item you are reading.

Go to Beginning — takes you to the beginning of the PDF file.

Go to Page... — displays a text entry box at the bottom of the screen, so you can specify a page to jump to in the content.

Search This Document — displays the Search line at the bottom of the screen. This allows you search for a word or a combination of words inside the currently opened PDF document. This feature doesn't work in cases where a PDF document was created using image files.

Add a Bookmark — bookmarks the page you are currently on. After selecting this option, the upper right corner of the PDF will be dog-eared and this menu option will change to "Delete Bookmark."

My Bookmarks — displays a page containing all of your current item's bookmarks.

3.7 Listening to Audio Materials

There are three types of audio materials that you can listen to on your Kindle. You can purchase, transfer, and listen to audiobooks from Audible.com, transfer MP3 files from your computer to play as background music while you read, or turn on Text-to-Speech in any of your reading material (where allowed by the rights holder). (For information about transferring audiobooks or MP3 files to your Kindle, see Chapter 8.)

AUDIOBOOKS

On your Home screen, your audiobooks list the title and author, but they also have the word "audio" next to the title to indicate that they are audiobooks.

To listen to one of your audiobooks, select it from your Home screen. You will see a page similar to the one shown below. Kindle provides a standard set of controls that are explained below.

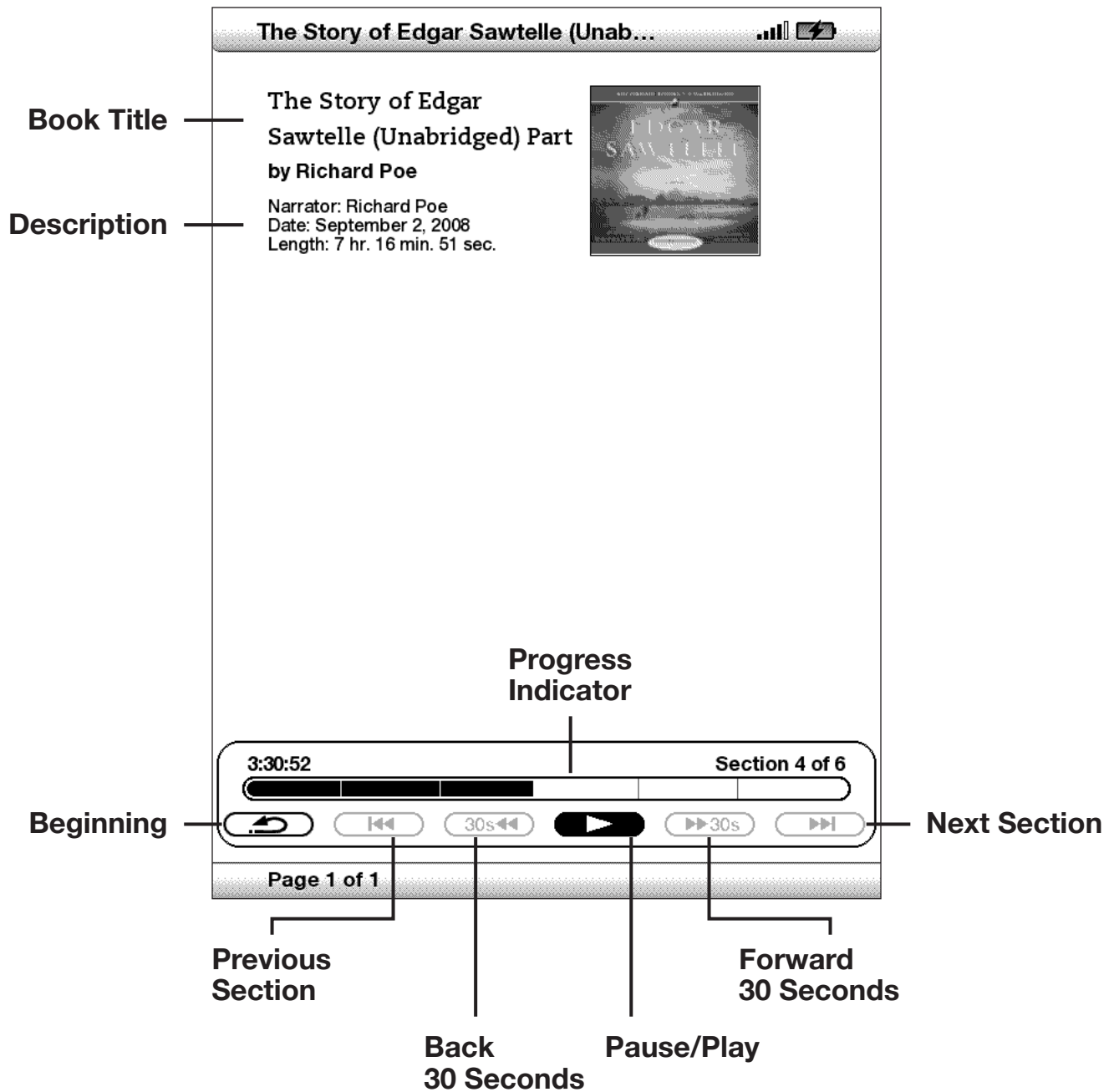

Progress Indicator — indicates how far you have come in the audiobook, the elapsed time, and the section you are in.

Pause/Play — pauses or plays the audiobook (there is no Stop control).

Forward 30 Seconds — moves ahead thirty seconds from the current location.

Beginning — takes you back to the beginning of the audiobook.

Previous Section — moves backwards in the audiobook to the previous section.

Back 30 Seconds — moves backwards thirty seconds from the current location.

Next Section — moves ahead to the next section in the audiobook, which is usually the next chapter.

BACKGROUND AUDIO



To play background audio (MP3 files) that you have transferred to your Kindle, follow the steps below:

1. If you are not already on the Home screen, press the Home button.
2. Press the Menu button.
3. Move the 5-way down until “Experimental” is underlined and press the 5-way to select it.
4. Move the 5-way down until “Play MP3” is underlined and press down to select it.

The songs are played in order, by the date you added them to your Kindle. You can adjust the volume of the music using the volume controls on the right side of your Kindle. You can continue to listen to the audio while reading content; the background audio continues to play unless you open an audio book, turn on text-to-speech, all of the files have been played, or if you stop the playback as indicated below.

To turn off background audio:

1. If you are not already on the Home screen, press the Home button.
2. Press the Menu button.
3. Move the 5-way down until “Experimental” is underlined. Press the 5-way to select.
4. Move the 5-way down until “Play MP3” is underlined. Press the 5-way to select.

 *Tip: You can also play or stop background audio by holding down the ALT key  and pressing the space bar. You can forward to the next track by holding down the ALT key  and pressing the ‘F’ key.*

TEXT-TO-SPEECH

Your Kindle can read aloud your books (where allowed by the rights holder), newspapers, magazines, blogs, and personal documents with the Kindle Experimental application Text-to-Speech.

To turn on Text-to-Speech, follow these steps:



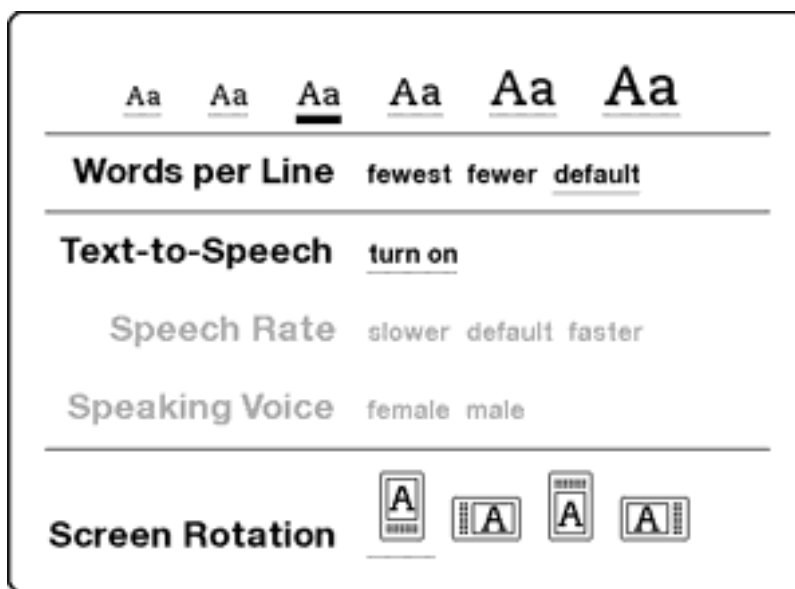

1. Press the Text key 



2. Move the 5-way down so that “turn on” is underlined. Press the 5-way to select. In a few moments, you will hear your content spoken aloud. You can either listen to it through the Kindle’s external speakers or plug in earphones into the headphone jack.
3. By default, content is spoken with a male voice, but using the 5-way, you can select a female speaking voice. You can also slow down or increase the rate of speech as well as pause or turn off Text-to-Speech
4. While Text-to-Speech is playing, the screen will update to the corresponding page of text.

For PDF files and books which the rights holder does not allow Text-to-Speech to read aloud, Text-to-Speech will be grayed out and you will not be able to select it.

By default, Text-to-Speech starts reading at the beginning of the page currently displayed. To start reading at a particular spot, move the cursor where you’d like the reading to begin before starting Text-to-Speech.

 *Tip: You can also play or stop Text-to-Speech by holding down the Shift key  and pressing the Symbol key . You can pause and resume Text-to-Speech by pressing the Spacebar. *

CHAPTER 4:

Searching on Kindle

Kindle allows you to take advantage of powerful search capabilities. You can search locally on Kindle or remotely at the Kindle Store, Wikipedia, or the Web.

4.1 Introduction to Search

This section describes the types of searches that you can perform using Kindle and how to use search.

TYPES OF SEARCHES

Kindle supports several types of search as summarized below.

SEARCHING WHAT YOU ARE CURRENTLY READING

You can limit a search to only what you are currently reading. You enter your search term or phrase and Kindle searches in the body of the text in the current item.

SEARCHING ALL YOUR CONTENT

You can alternatively search all the reading material that you have stored on Kindle, including books, newspapers, magazines, and other items. You enter your search term or phrase and Kindle searches in the body of the text, in the metadata (for example, the title or author), and in your “My Clippings” file. For PDFs, Kindle searches for the term in the metadata only (author’s name and file name). Additionally, Kindle also keeps and searches the metadata for the content you have stored on Amazon.

SEARCHING REMOTELY

Kindle can perform remote searches in several different locations using Whispernet. Each of these remote location searches are described in the final section of this chapter. See [Searching the Kindle Store](#), [Searching the Web](#), or [Searching Wikipedia](#).

SEARCHING FOR DEFINITIONS

You can limit a search to the dictionary. Kindle searches your default dictionary for definitions of the word you have entered.

PERFORMING A SEARCH

To perform a search, follow these steps:

1. Type in your search term; the Search line will automatically appear. You can use whole words, and no distinction is made between lower and upper case.



2. To find the word or phrase in the content you are currently reading, move the 5-way to the right to highlight "find." Or, to choose the type of search, continue moving the 5-way right. You can search all your items, the Kindle Store, Google, Wikipedia, or the dictionary.

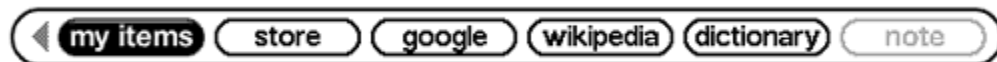

3. Press the 5-way to submit your search.

If you select "Search" from the Home page menu, the screen will display a full Search page.

Search

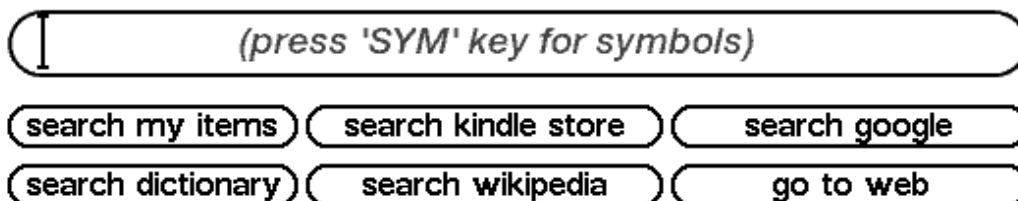

4.2 Search Results Page

When searching all your content, Kindle looks in the reading materials you have on your Kindle and the metadata (like title and author) of the materials you have in Archived Items. This includes purchased items, personal documents, and annotations that you have created.

The example below shows a typical Search Results page.



The screenshot shows a Kindle search results page. At the top, the device name "Gail's Kindle" is displayed next to signal and battery icons. Below this, the search results are shown for the term "politics". The results are sorted by relevance, as indicated by the "By Relevance" label. The top result is "(119) Team of Rivals: The Poli..." by Doris Kearns Go... which is highlighted with a thick black bar. Below it are other results: "(38) Hot, Flat, and Crowded" by Thomas L. Friedman, "(4) The Brief Wondrous Life of Osc..." by Junot Diaz, "(4) The Help" by KATHRYN STOCKETT, "(3) The Book Thief" by Markus Zusak, "(2) The Da Vinci Code: A Novel" by Dan Brown, "(2) Frommer's- London 2009" by Darwin Porter, "(2) So Brave, Young, and Handsome" by Enger, Leif, and "(1) Kindle User's Guide, 1st Editi..." by Amazon.com. At the bottom of the results list, there is a search bar containing the text "politics" and a button labeled "search my items". The page number "Page 1 of 1" is displayed at the very bottom.

Rank	Title	Author
(119)	Team of Rivals: The Poli...	Doris Kearns Go...
(38)	Hot, Flat, and Crowded	Thomas L. Friedman
(4)	The Brief Wondrous Life of Osc...	Junot Diaz
(4)	The Help	KATHRYN STOCKETT
(3)	The Book Thief	Markus Zusak
(2)	The Da Vinci Code: A Novel	Dan Brown
(2)	Frommer's- London 2009	Darwin Porter
(2)	So Brave, Young, and Handsome	Enger, Leif
(1)	Kindle User's Guide, 1st Editi...	Amazon.com

The screen shows the titles of the items that contain your search term and indicates how many times the term occurs. The list is ordered by the number of occurrences of the search term in each item. If the term appears in a title of an archived item, then that item is listed first and does not include the number of occurrences.

Use the Next Page and Previous Page buttons if there are more results than fit on the current page.

SEARCH RESULTS FOR A SPECIFIC ITEM

To see the results for one of the items listed:

1. Use the 5-way to underline the item.
2. Press the 5-way to view the matches.
3. A page appears showing all instances of the search term in that particular title. Each occurrence lists its location number and is shown in context so you can see how the search term is used.

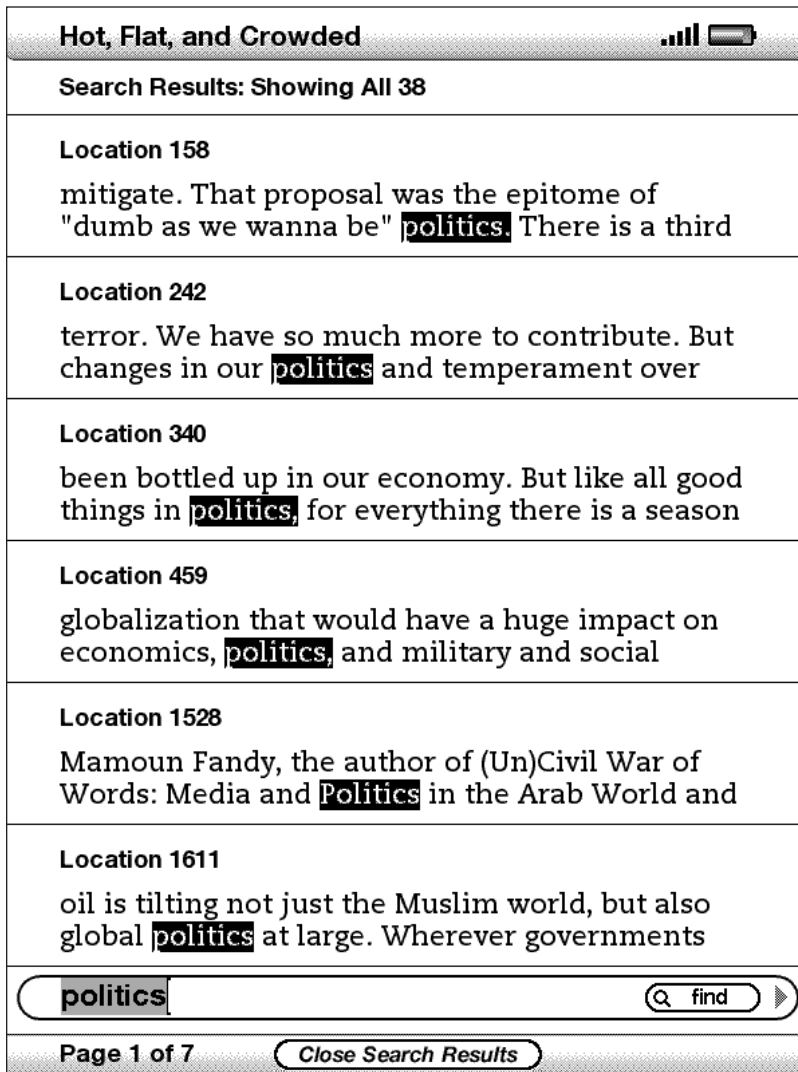

To go to a specific location in the content where the search term occurs, use the 5-way to underline the location and press the 5-way to select. If the search results encompass multiple pages, then use the Next Page and Previous Page buttons to navigate between pages.

To close the Search Results page, move the 5-way to highlight "Close Search Results" and press the 5-way.

SEARCH RESULTS FOR A DEFINITION

When you want to look up the meaning of a word, you can limit a search to the dictionary. Kindle searches your default dictionary for definitions of the word you enter.

To find a definition, follow these steps:

1. Type in the word you want defined.
2. Move the 5-way right to highlight “dictionary.”
3. Press the 5-way to submit your search.

You will see a complete definition of the word.

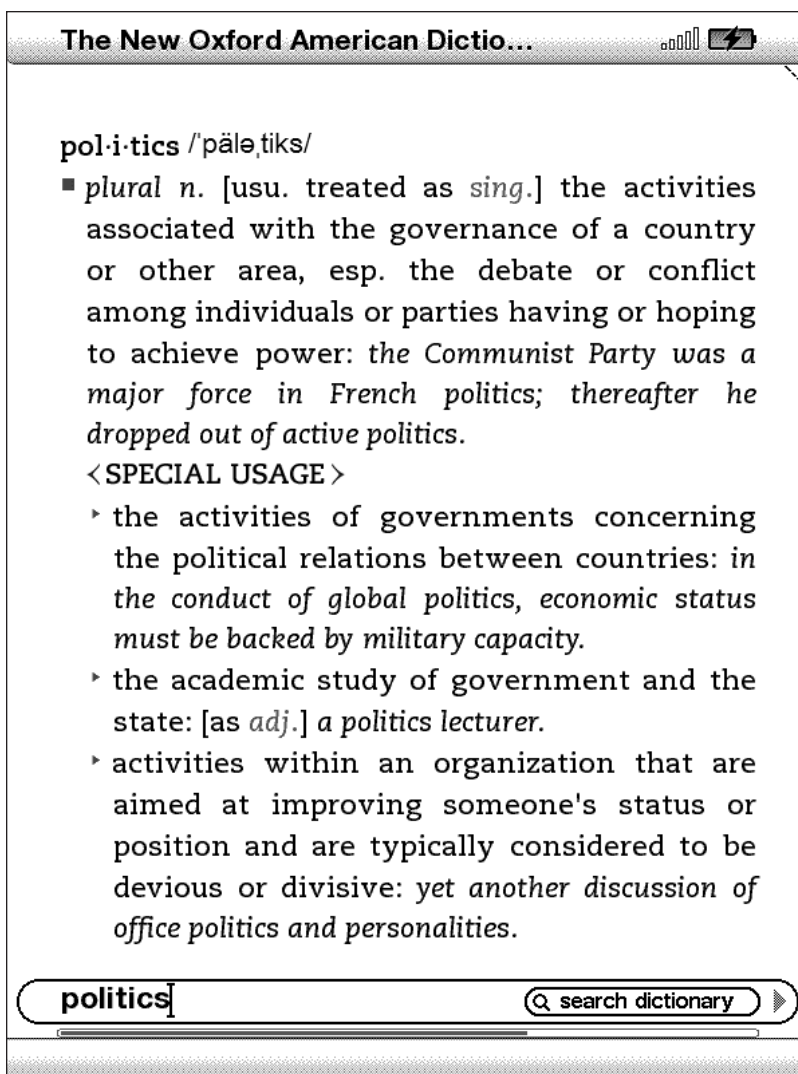

4.3 Performing Remote Searches

To search remotely, you must have Whispernet switched on. You can select any of the remote searches described in this section.

If Whispernet is not already on, press the Menu button. Move the 5-way controller to underline "Turn Wireless On" and press the 5-way controller to select and turn on Whispernet.

SEARCHING WIKIPEDIA

To search Wikipedia, enter your term and move the 5-way to select "wikipedia." This opens Basic Web and displays the Wikipedia page.

SEARCHING THE WEB

To search the Web, enter your term and move the 5-way to select "google." This opens Basic Web and submits your search term to Google.

SEARCHING THE KINDLE STORE

To search the Kindle Store, enter your term and move the 5-way to select "store." Your Kindle connects to the Kindle Store and displays the search results page for the store sorted by relevance, as shown in the example below. You can page through the results just like you would do in the content on your Kindle.

Gail's Kindle .lll 🔋

Kindle Store Narrow Results by Category

Search Results: "politics"
14651 Titles, Sorted by Relevance

1.  **Politics by Aristotle**
by Aristotle
★★★★☆

2.  **Silos, Politics and Turf Wars: A Leadership Fable About Destroying the...**
by Patrick M. Lencioni
★★★★☆

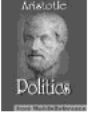
3.  **Politics by Aristotle. Published by MobileReference (mobi).**
by Aristotle
★★★★☆

4.  **Politics by Aristotle**
by Aristotle
★★★★☆

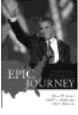

5.  **POLITICS --- WITH LINKED TABLE OF CONTENTS**
by Aristotle
★★★★☆

6.  **Epic Journey: The 2008 Elections and American Politics**
by James W. Ceaser, Andrew E. Busch, John J., Jr...
★★★★☆

Begin typing to search 🔍 search store

Page 1 of 2442

You can narrow results by categories by clicking on the drop-down list located in the upper right corner of the Search Results page.

 **Tip:** You can also narrow a search in the Kindle Store to an author's name by typing "@author" followed by the author's name. For example, to search the Kindle Store for books by Agatha Christie, enter "@author Agatha Christie" in the Search line. This will narrow your Kindle Store search to find only books written by Agatha Christie. 

CHAPTER 5: The Kindle Store

The Kindle Store is the place to purchase your Kindle books, newspapers, magazines, and blogs. Find an item in the store, select “Buy,” and you will typically receive your item wirelessly in under a minute. All of your Kindle purchases use Amazon 1-Click for easy purchasing and Amazon automatically backs up all of your purchases in case you lose your Kindle or want to download a title again. To help other Amazon users decide what to buy, you can also add your own ratings and reviews.

5.1 Getting Started at the Store

This section tells you how to connect to the Kindle Store on your Kindle, and provides some ideas about the best ways to look for content once you are connected.

CONNECTING TO THE KINDLE STORE

You connect to the Kindle Store using your device’s built-in Whispernet service. To go to the Kindle Store, follow these steps:

1. If Whispernet is not already on, press the Menu button, move the 5-way controller up so that “Turn Wireless On” is underlined, and then press the 5-way controller to turn on Whispernet.
2. Press the Menu button and move the 5-way controller down to underline “Shop in Kindle Store.”
3. Press the 5-way controller to select “Shop in Kindle Store.”

You will see this icon  in the upper left corner of the page, if you are not already connected. The Kindle Storefront will appear as shown later in this chapter and serves as a launch point for all of the Kindle Store services.

5.2 Kindle Store Pages

This section describes the different pages you will find at the Kindle Store, like the Kindle Storefront, the Browse pages, and the product detail pages for individual pieces of content.

Note: Kindle Store pages can only be viewed in portrait mode.

THE KINDLE STOREFRONT

When you select “Shop in Kindle Store” from any menu, you will be taken to the Kindle Storefront. An example is shown below, the storefront you see may be different as we update it often.

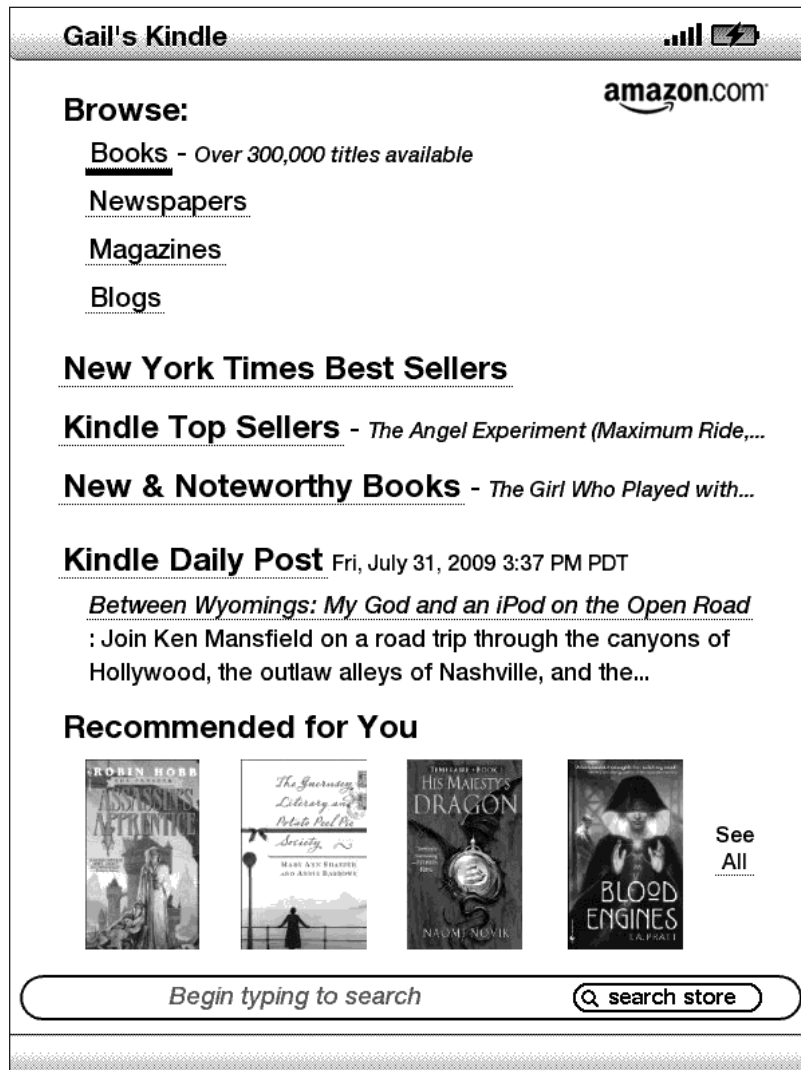

Search Store — enter your search criteria here and Amazon will search the entire Kindle Store for matches and return the search results.

Once you are in the Kindle Store, you can move around using links on the pages of the store such as New & Noteworthy Books or Top Sellers, by using the Store menu, or by searching the Kindle Store for specific titles.

THE STORE MENU

The menu you see while you are connected to the Kindle Store allows you to go to other places in the store easily and includes the selections listed below.



Turn Wireless Off — turns the Whispernet connection off. If you turn wireless off, you will not be able to access the Kindle Store.

Kindle Storefront — takes you to the Kindle Storefront.

Books — displays the books currently available in the Kindle Store.

Newspapers — displays the newspapers currently available in the Kindle Store.

Magazines — displays the magazines currently available in the Kindle Store.

Blogs — displays the blogs currently available in the Kindle Store.

Top Sellers — displays a list of Amazon best sellers. Outside the U.S., Kindle with international wireless will display Kindle Best Sellers instead.

New & Noteworthy — displays a list of new or noteworthy content on the Kindle Store. Outside the U.S., Kindle with international wireless will display Kindle Best Sellers instead.

Recommended for You — displays items recommended for you by Amazon based on your previous digital and physical purchases.

“Save For Later” Items — displays items you have previously noted as something that might be of interest to you.

BROWSING THE STORE

Another way to find reading material in the Kindle Store is to browse through the different content categories such as books or newspapers. Once inside a category, you can further refine your browse by topic. For example, within “Books,” you can refine listings to “Fiction,” “Nonfiction,” “Advice & How-to,” etc. Each browse page shows the path that you have taken at the top so you can easily retrace your steps.

BROWSE LISTINGS SAMPLE

The example below shows you the type of listings you will see on the Books browse page.

Browse path — shows the steps on the path you used to get to the current page.

Number of titles in the category — shows the number of items available in the particular category.

Categories — groups the content by topics of interest to make browsing easier. Select the category you are interested in to show only items in that particular subject. You can also select subcategories within the main category by selecting “View subcategories within...” in the upper right corner of the screen.

The screenshot shows the Kindle Books browse page for 'Gail's Kindle'. The page title is 'Books, 24 Categories'. The categories are listed in two columns, each with a title and a count in parentheses. The categories are: All Books (339,641), Fiction (119,357), Nonfiction (215,327), Advice & How-to (23,554), Business & Investing (28,737), Politics & Current Events (12,214), Literary Fiction (11,733), Biographies & Memoirs (13,017), Religion & Spirituality (27,842), Science Fiction (8,368), Fantasy (5,692), Mystery & Thrillers (15,550), Romance (18,400), Science (38,225), History (26,377), Children's Chapter Books (12,584), Reference (11,342), Travel (4,220), Sports (4,517), Humor (8,474), Computers & Internet (14,250), Arts & Entertainment (27,961), Lifestyle & Home (16,105), and Parenting & Families (6,620). At the bottom, there is a search bar with the text 'Begin typing to search' and a 'search store' button. The page number 'Page 1 of 1' is displayed at the bottom.

Browse Path — points to the top bar showing 'Gail's Kindle' and 'Books, 24 Categories'.

Category — points to the category list.

Number of Titles in Category — points to the count in parentheses next to a category name.

Category	Number of Titles
All Books	(339,641)
Fiction	(119,357)
Nonfiction	(215,327)
Advice & How-to	(23,554)
Business & Investing	(28,737)
Politics & Current Events	(12,214)
Literary Fiction	(11,733)
Biographies & Memoirs	(13,017)
Religion & Spirituality	(27,842)
Science Fiction	(8,368)
Fantasy	(5,692)
Mystery & Thrillers	(15,550)
Romance	(18,400)
Science	(38,225)
History	(26,377)
Children's Chapter Books	(12,584)
Reference	(11,342)
Travel	(4,220)
Sports	(4,517)
Humor	(8,474)
Computers & Internet	(14,250)
Arts & Entertainment	(27,961)
Lifestyle & Home	(16,105)
Parenting & Families	(6,620)

GETTING THE DETAILS

The product detail page for books and periodicals provides the most pertinent information about an item. To get to the product detail page for a particular item, use the 5-way controller to select it.

PRODUCT DETAIL PAGE EXAMPLE

The example below shows you a product detail page for a book available at the Kindle Store. The features on this page are explained in the list below.

Gail's Kindle [Signal strength icon] [Battery icon]

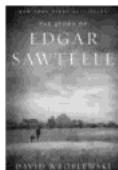
 **The Story of Edgar Sawtelle** — **Title**
by David Wroblewski — **Author**

Born mute, speaking only in sign, Edgar Sawtelle leads an idyllic life with his parents on their farm in remote northern Wisconsin. For generations, the Sawtelles have... [More](#) — **Description**

Publisher's Digital List Price: \$25.99

Print List Price: ~~\$25.95~~

Kindle Price: \$9.99* — **Buy**

You Save: \$15.96 (62%)

*Includes free wireless delivery via *Amazon Whispernet*

[1,347 Customer Reviews](#) :★★★★☆ — **Reviews**

Sales Rank: #328 in Kindle Store — [Try a Sample](#) — **Try a Sample**

Publisher: HarperCollins e-books — [Save for Later](#) — **Save for Later**

Published: Jun 10, 2008

Print Length: 576 pages

Text-to-Speech: Enabled — **Text-to-Speech**

Customers who bought this book also bought: — **Recommendations**

★★★★★ [The Guernsey Literary and Potato Peel Pie Society](#), ...

★★★★★ [Art of Racing in the Rain, The](#), by *Garth Stein*

[See more](#)

Begin typing to search [Search icon] **search store**

Author — searches the Kindle Store for other books by the author when selected.

Description — describes the item. Select “more” to see the full text.

Buy — purchases the item using your default Amazon 1-Click payment method and sends it wirelessly to your Kindle.

Reviews — displays the customer reviews for this item. Provides links to editorial reviews and for writing your own review.

Try a Sample — downloads the beginning of the book for free so you can sample it before buying.

Save for Later — adds the item to your “Save for Later Items” list so you can peruse or purchase it later.

Text-to-Speech — indicates whether Text-to-Speech is allowable by the book’s rights holder.

Customers who bought this book also bought: — displays a list of items purchased by Amazon customers who also bought this item.

ADDITIONAL DETAILS FOR PERIODICALS

The product detail page for newspapers, magazines, and blogs is similar to the product detail page for books, but it contains different purchasing options:

Subscribe now with 14-day Free Trial —select this to start your subscription. All newspapers, magazines, and blogs come with a free trial to start your subscription, and you can cancel your subscription on the Manage Your Kindle page on Amazon at any time during this period. After the trial period, your subscription will automatically be delivered at the regular monthly price.

Buy Current Issue — purchases the current issue of the newspaper or magazine and sends it to your Kindle.

Note that if you have already subscribed to or purchased an item, you will see the word “Already Subscribed” in gray letters next to the periodical on the product detail page.

SAVING ITEMS FOR LATER

The Kindle Store provides a “Save for Later Items” page for you to save items that you want to look at or purchase later. This page lists the item’s title, author, and average customer rating.

To add an item to your list, select “Save for Later” from the product detail page for the item. You will see a confirmation message that your addition was successful. To see your list of saved items, select “Save for Later Items” from the Store menu. To display the product detail page for this item, select “Details.” To remove the item from your list, select “Delete.”

5.3 Recommendations, Reviews, and Ratings

The Kindle Store provides several features to help you decide which reading materials you may want to purchase. This section describes the various ways you can find what is available.

RECOMMENDED FOR YOU

The Recommendations page provides a list of things that you might enjoy based on the types of materials (digital and printed) you have purchased in the past either on Kindle or on Amazon.com. To get to this page, select “Recommended for You” from the Kindle Storefront or from the Kindle Store menu.

LOOKING UP REVIEWS

The Reviews page lists Customer Reviews for items. To get to the Reviews page for a specific item, select “Customer Reviews” from the product detail page for that item.

To see Editorial Reviews from publications, select “Editorial Reviews” from the Reviews page. For the complete text of a particular review, select the review excerpt using the 5-way controller.

Gail's Kindle .lll 🔋

Write a Review **Editorial Reviews**

Customer Reviews: The Story of Edgar Sawtelle

★★★★★ *Here* is a writer...
 Reviewer: *Schmadrian*

...and *here* is a novel.

Chock-full of a love of language, a robust narrative style, but moreover, more importantly, here is an actual *story*,...

★★★★★ Dramatic and Compelling
 Reviewer: *CFE (Colorado)*

This is a wonderful read. The story blends an authentic portrayal of the cultural and geographic landscape of the midwest with completely new and unexpected elements. The access the story gives you to the feelings and perceptions of...

★★★★★ Its understated elegance shines through
 Reviewer: *Yesh Prabhu, author of The Beech Tree (Plainsboro,...*

This is an astonishing, mysterious, bewildering and profound novel. And even though the story is sad and heart-breaking, it is written so well that it has resulted in a deeply satisfying novel as well. Not since I read Yann Martel's mesmerizing...

Begin typing to search 🔍 search store

Page 1 of 439

WRITING YOUR OWN RATINGS AND REVIEWS

You can share your opinions with other readers by rating and reviewing the materials that you have read. To get to this page, select “Customer Reviews” from the product detail page for the item you want to critique, and then select “Write a Review”

The sample screen below shows you the type of information you can enter.

The screenshot shows a Kindle interface for rating and reviewing an item. At the top, it says 'Gail's Kindle' and has signal and battery icons. The main title is 'My Rating and Review' with a 'Cancel' link. Below this is the 'Rate This Item' section for 'The Story of Edgar Sawtelle' by David Wroblewski, published on June 10, 2008. The average customer review is shown as four stars. There are five star rating options, with the top one being selected. The 'Review This Item' section has 'Title: -None-' and 'Review: -None-'. A 'Submit' button is at the bottom right. At the very bottom, there is a search bar with the text 'Begin typing to search' and a 'search store' button.

ENTERING A RATING AND REVIEW

1. Indicate the rating you think this item deserves by selecting the line with the appropriate number of stars.
2. Select "Title" and enter a title for your review. Select "ok" to submit your title.
3. Select "Review" and type your review on the lines provided. Select "ok."
4. To submit your rating and review, select "Submit." If you want to close this page without submitting your rating or review, select "Cancel."

5.4 Making Purchases

This section explains various aspects of purchasing items from the Kindle Store.

TRYING A SAMPLE BOOK

Most Kindle books allow you to download a sample before you decide to buy the item. The end of the sample book has a link to revisit the product detail page for the item or a link to purchase the item directly. In addition, while reading a sample, the Menu shows “Buy this Book Now” so you can purchase the book at any time during your reading.

BUYING YOUR SELECTIONS

All of your Kindle Store purchases use Amazon 1-Click, which allows you to purchase reading materials with a single selection. To make your purchase, select “Buy” from any product detail page for the item you want. Your item will be auto-delivered wirelessly to your Kindle and also added to the Manage Your Kindle page on Amazon.com. You will see an “items downloaded” message at the top of the screen when your item has arrived on your Kindle.

 *Tip: Once your item has been downloaded, the original is retained in the Manage Your Kindle page on Amazon.com. If the download is not successful, or if it is interrupted, Kindle will attempt to download again without any action required from you.*

RETURNING AN ITEM

All of your Kindle Store purchases present an order cancellation feature at the time of purchase in case you change your mind or made a mistake. Just select “Purchase by Accident? Cancel this Order” on the order confirmation page. If you are a U.S. customer, you can also contact Kindle Support using Amazon’s Click-to-Call service on the Web at: <http://www.amazon.com/kindlesupport>

For customers outside the U.S., Kindle Support can be reached via e-mail at: kindle-cs-support@amazon.com or by phone at 1-206-266-0927(charges will apply). U.S. customers can reach Kindle Support by phone at 1-866-321-8851. 

CHAPTER 6: Accessing the Web

Your Kindle comes with an Experimental application called Basic Web, which is a Web browser optimized to read Web sites that are primarily text-based. It supports JavaScript, SSL and cookies but does not support media plug-ins (Flash, Shockwave, etc.) or Java applets. You can also change your Kindle screen orientation from portrait to landscape to see the entire width of a web page.

6.1 Using Basic Web

There are four ways to open the Basic Web browser. The two main ways are to select “Basic Web” from the Experimental screen or to follow a link from within your reading material. Many of the blogs that you subscribe to from the Kindle Store have links to Web sites. Selecting these links will open Basic Web and take you to the URL associated with the link. If you select “Basic Web” from the Experimental page, you will open to the last Web site you were viewing in your browser.

One other way of accessing the Basic Web browser is to type in a word anytime from Home or any book, blog, newspaper, or magazine you happen to be reading. When you begin typing, a search box will pop up at the bottom of the screen, and you can move the 5-way controller to the right and select “google” or “wikipedia” from the menu to search those sites directly for the word you typed.

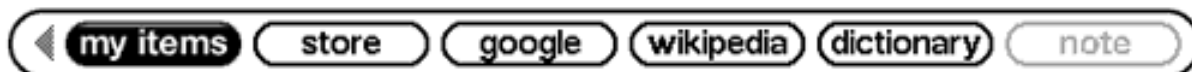

You can also enter a URL in the Search bubble from the Home page. Type the URL and move the 5-way to select “go to” and then press the 5-way.

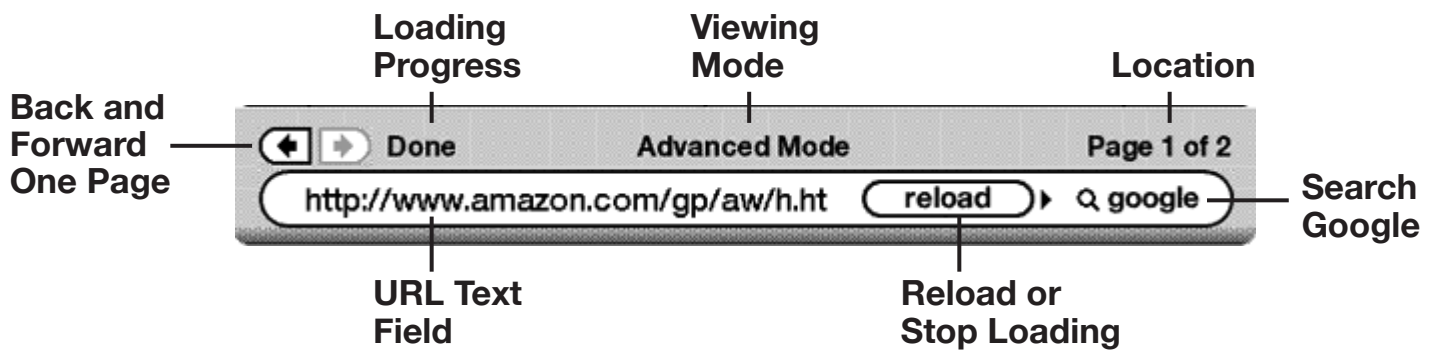

ENTERING A URL

To enter the URL for a Web site, navigate to the top of the screen or press Menu and select "Enter URL" from the menu options. Begin typing when the cursor is located in the URL text field. When you are done typing, press the 5-way controller to view that Web site.

The URL text field retains the last URL you entered in case you want to quickly edit the same address and submit it again. If you want to enter a secure site with an "https" address, use the backspace key to delete the automatically entered "://" and type the address you want.

The URL text field is embedded in a navigation bar with a few other key shortcuts. To the right of the URL text field there is a button to stop loading or reload the current page. From there, move your 5-way to the right, and you can select the Google search engine or Wikipedia for searching on the text entered in the URL text field. Above the URL text field are shortcuts to navigate back and forward one page, an indication of how much of the page has been loaded, whether you are viewing the page in Basic or Advanced Mode, and where you are in the web page.

USING BOOKMARKS AND ADDING YOUR OWN

Bookmarks let you easily access a Web page without needing to type the address every time. When you open Basic Web from the Experimental page for the first time, you will see a list of default bookmarks with links to information such as daily news and weather. While browsing, you can also access the same list of bookmarks by selecting "Bookmarks" from the browser menu (just press the Menu button).

To add a Web site to the Bookmarks page, simply navigate to the site that you want to bookmark and press the Menu button. Move the cursor to “Bookmark this page” and press the 5-way controller. Any new bookmarks that you select will be added to the existing list on your Kindle.

You can remove a bookmark by going to your Bookmarks lists and moving the 5-way controller until the item you want to delete is underlined. Move the 5-way left to display “delete bookmark.” Press the 5-way and the site will be deleted from your Bookmarks. From the Bookmarks list, moving the 5-way to the right lets you edit the name of the bookmark.

USING NEXT PAGE AND PREVIOUS PAGE

Most Web pages you find on the Internet will have more content than can be displayed on one page. Use the Next Page and Previous Page buttons to move through these pages. This is equivalent to using your mouse on a computer to move up and down through a Web page. You can also move the cursor down with the 5-way controller until it reaches the bottom of the page.

SELECTING LINKS, BUTTONS, AND BOXES

You can navigate the links on a Web page by using the 5-way controller to move the cursor around the page. Links in Basic Web are shown as underlined words, just like in the Reader. Below is a Web page with multiple selectable links.

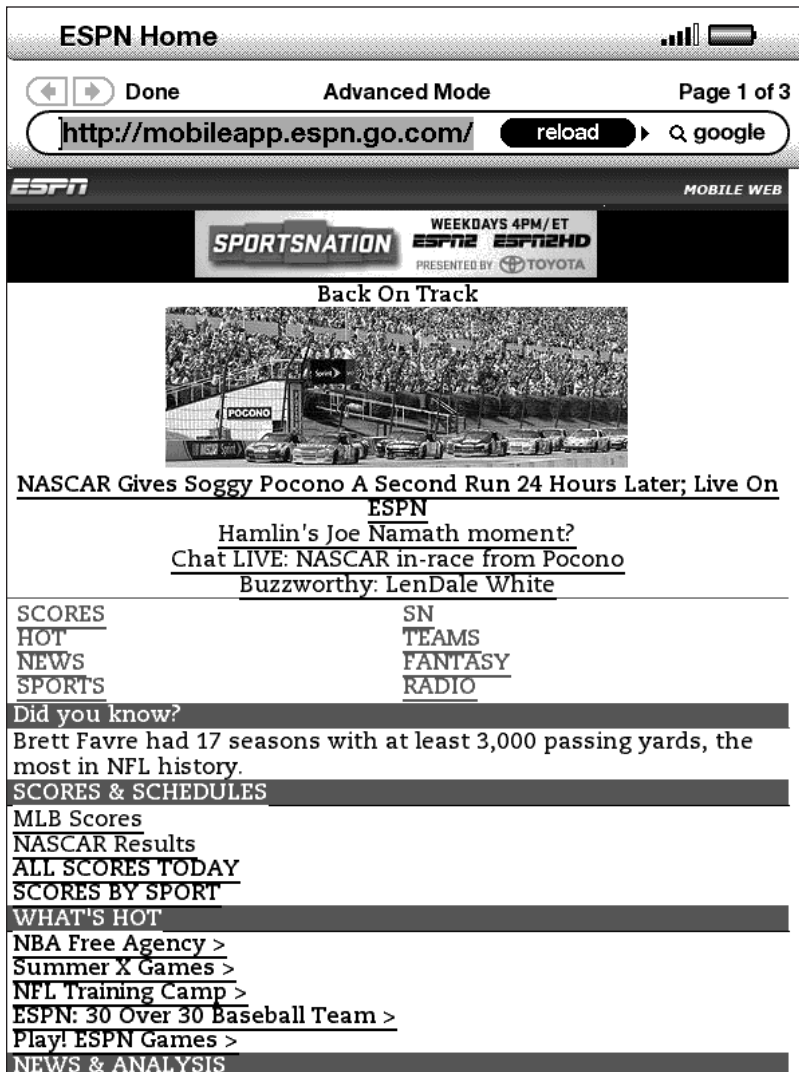

Using the 5-way controller, highlight the link you want to go to and press the 5-way. The browser will open that page.

If you want to enter information in an input field in a Web page to search that site, for example, you should move the cursor to that input field and begin typing. When you finish typing, press down on the nearby Go or Enter or Search button to retrieve the results. If there are radio buttons embedded within a Web page, you can change the input by maneuvering the cursor to the button you want to change and press the 5-way to "push" this button.

USING HISTORY

You can easily return to Web sites you recently viewed by pressing the Menu button and selecting "History." You will then see a list of recently visited Web sites to select from. As noted above, you can also use this list to add a site to your Bookmarks by moving the 5-way to the right.

THE BASIC WEB MENU

The Basic Web menu contains other items you can select, many of which also appear in the Browser's navigation bar. To view the menu, press the Menu button when the Basic Web browser is on the screen.

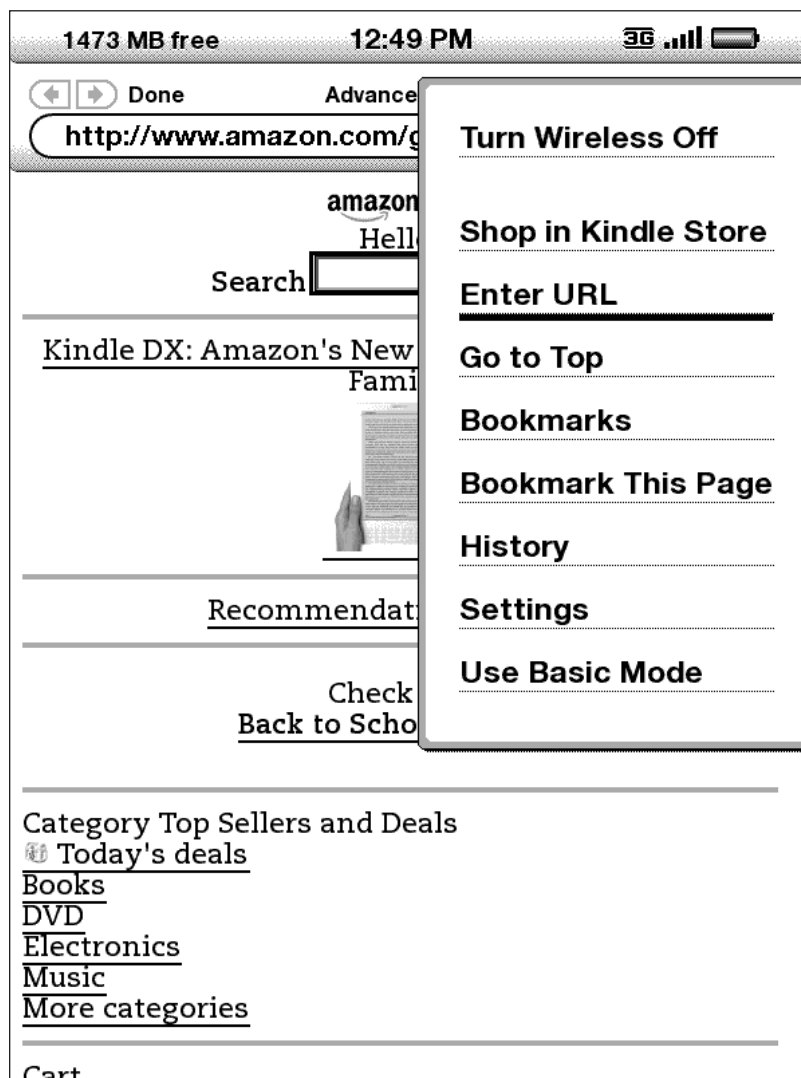

Turn Wireless Off — turns the Whispernet connection off. If you turn the wireless off, you will not be able to use the browser.

Shop in Kindle Store — takes you to the Kindle Storefront.

Enter URL — takes you directly to the URL field where you can enter a web address to visit.

Go to Top — returns you to the top of the current Web page.

Bookmarks — displays your list of Web bookmarks.

Bookmark This Page — adds the current page to the bottom of your list of bookmarks.

History — displays your History page, which keeps track of the sites you have visited.

Settings — displays your list of settings where you can change the options for Basic Web.

Use Advanced Mode — for complex Web sites. This mode squeezes pages down to fit the width of the Kindle screen. In this mode, JavaScript can also be enabled. When this mode is selected, the menu selection then changes to “Use Basic Mode” which optimizes the Kindle’s browser for viewing most pages.

6.2 Other Features

As you become more familiar with the Basic Web browser, the following topics may be of interest to you.

TEXT SIZE

Just like when you are reading a book or periodical, you can adjust the size of the text when viewing Web pages. See Chapter 3 for details on how to change text size.

DOWNLOADING FILES

Some Web sites may have books or documents you can download and read on your Kindle. When you select these books or documents using Basic Web, you will be asked to confirm if you want to download these to your Kindle Home. The types of files you can download include Kindle content (.AZW, .AZW1), unprotected Mobipocket books (.MOBI, .PRC) and text files (.TXT).

BASIC WEB SETTINGS

You can modify the default browser behaviors and perform simple maintenance procedures using Basic Web Settings. To display the Settings screen, press the Menu button while in the browser and then use the 5-way to select "Settings."

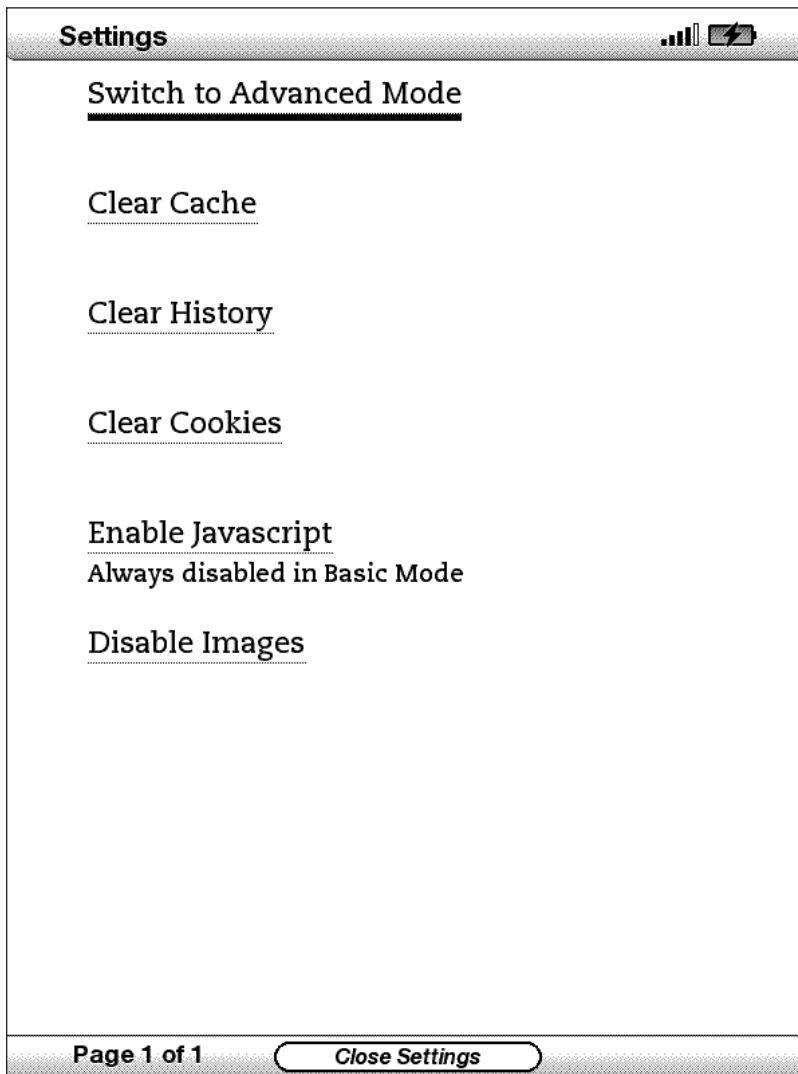

Switch to Advanced Mode — switches between Basic and Advanced modes, when you view Basic Web.

Clear Cache — removes temporary Internet files from your Kindle. Move the on-screen highlight to “Clear Cache” and press the 5-way controller to clear the cache.

Clear History — removes cached Internet address entries from your Kindle. Move the on-screen highlight to “Clear History” and press the 5-way to clear this list.

Clear Cookies — removes cookies from your Kindle. Move the on-screen highlight to “Clear Cookies” and press the 5-way to remove the cookies.

Enable Javascript — enables or disables Javascript to be executed on the pages you visit. Note that if Javascript is disabled, Web pages will load faster. The view mode must be set to Advanced Mode to use this feature.

Disable Images — select whether you want images to appear when you load a Web page. Note that if you do not show images, Web pages will load faster. 

CHAPTER 7: Settings and Experimental

Use the Kindle Settings page to personalize items on Kindle such as the name of your Kindle, automatic backup, personal information, etc. The Settings page also gives you information about your Kindle, such as the software version number. The Experimental page contains a number of prototype concepts we are working on.

7.1 Adjusting Your Kindle Settings

The Settings page is shown below and the features are explained in the list that follows. To go to the Settings page, press the Menu button while on your Home screen. Use the 5-way controller to underline “Settings” and press to select.

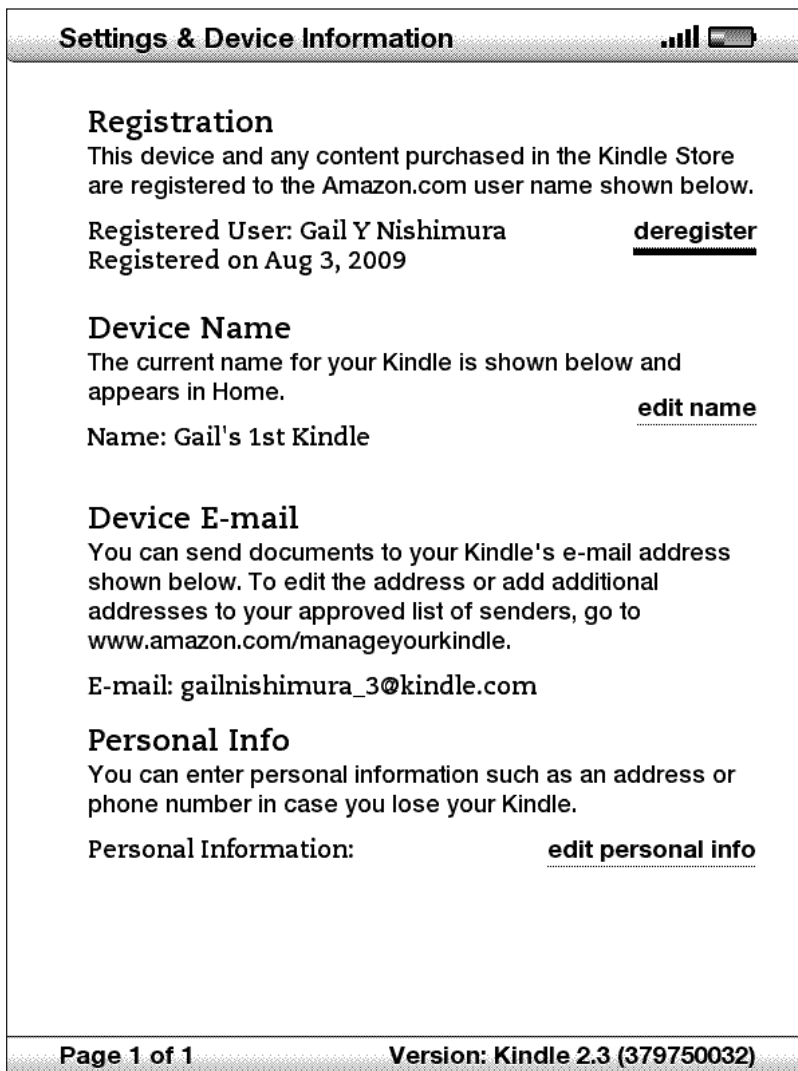

Registration — this is the Amazon.com account name to which your Kindle is registered. All Kindle Store and other charges will be applied to the credit card associated with your 1-Click account.

Device Name — you can change the name of your device to anything you want. This name shows at the top of the Home screen.

Device E-mail — this is the e-mail address of your Kindle. You and your friends can send documents to this address and they will be converted by Amazon and sent to your Kindle. To edit this e-mail address, go to:

<http://www.amazon.com/manageyourkindle>

Personal Info — enter any personal or contact information here such as an address or phone number in case you lose your Kindle.

Version — indicates which version of software your Kindle is using.

REGISTERING OR DEREGISTERING KINDLE

Your Kindle needs to be registered with your Amazon.com account information to use many of the Kindle features such as purchasing content. If your Kindle is lost or transferred to another user, you should deregister your Kindle from your account. The process to register or deregister is described below. You can also register or deregister your Kindle on the Manage Your Kindle page on:

<http://www.amazon.com/manageyourkindle>

REGISTERING YOUR KINDLE

If your Kindle is not already registered, follow these steps:

1. If you are not already on the Home screen, press the Home button.
2. Press the Menu button. Make sure that Whispernet is turned on.
3. Move the 5-way down until “Settings” is underlined and press to select.
4. Press the 5-way to select “Register.”
5. You will see a text entry box at the bottom of the screen to enter your Amazon.com user name and password (the e-mail address and password associated with your Amazon account). Use the keyboard to enter in your information.
6. Navigate the 5-way to select “OK” to finish the registration process or “Cancel” to cancel your registration.



Tip: If your Amazon user name or password contains characters not present on the Kindle keyboard, press the Symbol key  on the bottom of the keyboard to see a menu of additional characters and select the character you require.

Once registered, you can make purchases on the Kindle Store, convert personal documents on Amazon, use Basic Web, and take advantage of other Amazon-sponsored services. If your Kindle has incorrect registration information, deregister the device and then reregister it.

DEREGISTERING YOUR KINDLE

If you want to transfer ownership of your Kindle or return it for service or recycling, you should deregister it to prevent unauthorized purchases. The process is similar to the registration process described above. Just select “deregister” from the Registration section and select “ok” to confirm. Note that you will not be able to buy or download samples from the store, or use Basic Web if your Kindle is not registered.

You can also deregister your Kindle from the Manage Your Kindle page on Amazon.com.

PERSONALIZING YOUR KINDLE

Your Kindle acquires a default name when it is first registered. This name is based on your Amazon.com account name, and is displayed at the top of your Home screen. If you want to edit this name on your Kindle only, follow these steps:

1. If you are not already on the Home screen, press the Home button.
2. Press the Menu button.
3. Move the 5-way down until “Settings” is underlined and press to select.
4. Move the 5-way down until “Edit name” is underlined. Press the 5-way to open the text entry box.
5. Use the keyboard to change the device name.
6. When you have finished, move the 5-way to the right to highlight “Submit” and press the 5-way to submit the change.



Tip: To add any personal information such as your contact information, navigate with the 5-way so that “Edit personal info” is underlined then press the 5-way. Use the keyboard to add your information, then select “Submit” when you have finished.

CHOOSING YOUR PRIMARY DICTIONARY

You can choose the dictionary you want to use when you look up words while you are reading. The default is *The New Oxford American Dictionary* included on your Kindle, but you can change your dictionary choice by purchasing a supported dictionary on the Kindle Store and then following these steps:

1. If you are not already on the Home screen, press the Home button.
2. Press the Menu button.
3. Move the 5-way to underline "Settings" and press to select.
4. Press the Menu button.
5. Move the 5-way to underline "Change Primary Dictionary" and press to select.
6. Move the 5-way to underline the dictionary you want to use and press to select.

CHANGING AUTOMATIC BACKUP

Automatic Backup will backup your last location read, all of your notes, and bookmarks you make to Amazon.com on any of your purchased content. If you delete an item from your Kindle or your Kindle is lost, stolen, or damaged, you can automatically restore your annotations, bookmarks, and the last location you read by downloading the item from the Manage Your Kindle page on Amazon.com.

You can enable or disable automatic backup by following the steps below:

1. If you are not already on the Home screen, press the Home button.
2. Press the Menu button.
3. Move the 5-way to underline "Settings" and press to select.
4. Press the Menu button.
5. Move the 5-way to underline "Disable/Enable Annotations Backup" and press to select.

THE SETTINGS MENU

The Settings menu allows you to go to other places on your Kindle as well as update your software or restart your device. These menu options are defined below. To display the Settings menu, press the Menu button while you are on the Settings screen.



Turn Wireless Off — turns off Whispernet. When Whispernet is off, this option will change to Turn Wireless On.

Shop in Kindle Store — takes you to the storefront of the Kindle Store.

Disable Annotations Backup — by default the last location read on your content and any annotations you've made to Kindle Store content is backed-up at Amazon. You can disable the automatic backup by selecting this option.

Change Primary Dictionary — change the dictionary you are using for the built-in Lookup function. This menu option is only present if you have at least one additional dictionary loaded on your Kindle.

Update Your Kindle — installs the latest software for your Kindle. When an update is loaded on your device, this menu option becomes available, otherwise it is grayed out.

Restart — restarts your Kindle.

Reset to Factory Defaults — resets your Kindle to its original factory settings. You should only select this action if instructed to do so by Kindle Customer Service.

Legal — provides trademark, copyright, and other notices about the software installed on your Kindle.

Sync & Check for Items — connects to Amazon.com to download any newly available items and sync the furthest page read and annotations for all the books on your device.

7.2 Experimental

The Experimental page is a place for you to try out and experiment with some of the concepts we have under development. We encourage you to send us your feedback to help us decide how to improve the concepts and whether or not you think we should make them part of the Kindle product. To open Experimental, follow the steps below.

1. If you are not already on the Home screen, press the Home button.
2. Press the Menu button.
3. Move the 5-way down until “Experimental” is underlined and press the 5-way to select.
4. Select the concept you would like to try.

To give us feedback on items on the Experimental page, send an e-mail to kindle-feedback@amazon.com. We are really interested in hearing what you have to say, so type as much as you want. Based on your feedback, we may add or remove content from the Experimental page, so let your thoughts be known. 

CHAPTER 8:

Kindle and Your Computer

You can download and read text-based content on your Kindle without using your computer. However, if you want to access audiobooks or MP3 files, you need to transfer them by connecting Kindle to your computer over USB. In addition, there are other tasks you can accomplish using your computer as described in this chapter.

8.1 Getting Started

This section lists the requirements for connecting Kindle to your computer. The USB cable you use with your power adapter can also be used to connect your Kindle to a computer, so there is nothing additional to buy.

SYSTEM REQUIREMENTS

Both Macintosh and Windows users can manage Kindle files through the USB connection. When your Kindle is plugged into your computer, your Kindle will appear as a removable mass storage device. If your computer is Windows-based, you need to be using Windows 2000 or later. If your computer is a Macintosh, you should be using Mac OS X 10.2 or later. With either computer, you must have an available USB port or an attached USB hub with an available port.

MAKING THE CONNECTION

To connect Kindle to your computer, follow these steps:

1. Plug the larger end of the USB cable into an available USB port or a powered USB hub connected to your computer.
2. Connect the other end of the USB cable to the micro-USB port on the bottom of your Kindle.

The illustration below shows a Kindle and a laptop computer connected through the USB cable.

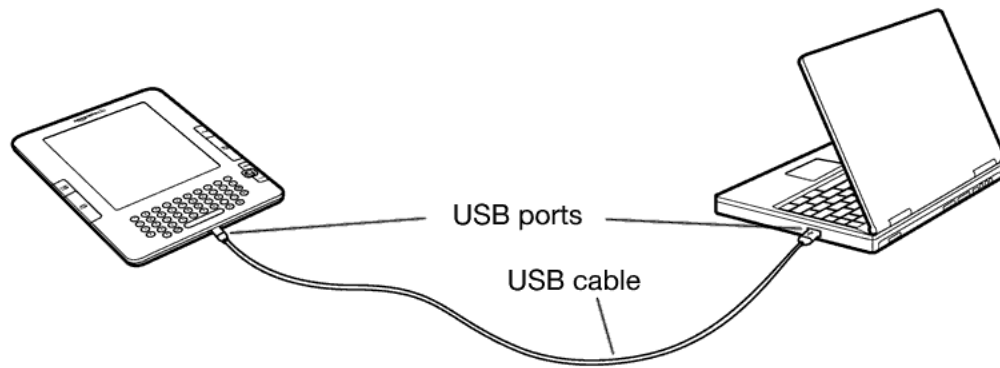

When you are connected to your PC, your Kindle will go into USB drive mode and its battery will be recharged by the computer. Your Whispernet service is temporarily shut off and you will not receive any of your subscriptions while in this mode. Also, your Kindle is not usable as a reading device while you are in USB drive mode, but will return right to where you were when you unmount the device from your computer.



Tip: If you'd like to continue reading your Kindle while its battery is being charged by the computer, you will need to release it from USB drive mode by unmounting or ejecting the Kindle from the computer. Note that it is always best to use your computer to unmount or eject your Kindle before disconnecting the USB cable. Consult your computer manual for details on how to properly disconnect a USB storage device.

8.2 Transferring Files When Whispernet is Unavailable

MANAGING YOUR DOCUMENTS

If your Kindle is out of Whispernet coverage, you can still add content to your device by connecting it to a computer to mount it as a USB drive. After your Kindle mounts on the computer, you will see three default directories or folders. The one called “documents” contains all of your digital reading materials like books, newspapers, your My Clippings file, etc. The “Audible” directory is for your audiobooks, and “music” is for your MP3 files. You can add Kindle-compatible files to these directories, and you can copy, move, or delete the files that are already there. The computer file formats that you can read or listen to on your Kindle are listed below:

- Kindle (.AZW, .AZW1)
- PDF (.PDF)
- Text (.TXT)
- Unprotected Mobipocket (.MOBI, .PRC)
- Audible (.AA, .AAX)
- MP3 (.MP3)

See Managing Your Orders for further information on transferring content you’ve already purchased to your device.



Tip: Mobipocket files must have no Digital Rights Management (DRM) protection applied to be readable on your Kindle. If you purchased a Mobipocket file from a Mobipocket retailer, you will not be able to open the file on your Kindle.

TRANSFERRING YOUR CLIPPINGS

Your clippings are stored in a file called “My Clippings.txt,” which is located in the “documents” directory. If you want to copy the clippings from your Kindle to your computer so you can edit them, e-mail a passage to a friend, or just archive your clippings, you can drag and drop the “My Clippings.txt” file onto your computer. Clippings and other annotations are described in more detail in Chapter 3.

8.3 Converting and Transferring Your Documents

In addition to reading commercially available materials, you can have Amazon convert your personal documents into a Kindle-compatible format for reading on your Kindle. You can have the converted files sent wirelessly to your Kindle via Whispernet for a fee or to the e-mail address associated with our Amazon account for free.

SUPPORTED FORMATS FOR CONVERSION

In addition to the file formats listed above, you can also convert other personal documents to read on your Kindle. The supported file formats are listed below:

- Microsoft Word (.DOC, .DOCX)
- RTF (.RTF)
- Structured HTML (.HTML, .HTM)
- JPEG (.JPEG, .JPG)
- GIF (.GIF)
- PNG (.PNG)
- BMP (.BMP)
- Compressed ZIP (.ZIP)

Note: DOCX conversion is currently an experimental feature on Kindle. Some DOCX files might not format correctly on your Kindle.



Tip: ZIP files are automatically opened up by the conversion service if you choose to compress your documents. Any enclosed files listed above inside the ZIP file will be converted and sent to your Kindle or computer as specified.

SENDING YOUR DOCUMENTS FOR CONVERSION

Each Kindle has its own unique e-mail address. When you e-mail personal documents to your Kindle, they are automatically converted to a Kindle-friendly format.

To set up your Kindle e-mail address, follow the steps below:

1. On your computer, open your Web browser and go to:
<http://www.amazon.com/manageyourkindle>
2. Sign-in to your Amazon.com account.
3. In the Your Kindle(s) section, select "Edit Info."
4. In the Kindle E-mail Address text field, change the first part of the e-mail address to what you would like it to be. The @kindle.com will automatically be appended.
5. Select "Update information" to save your changes and close the text entry box.

Your Kindle will only receive converted files from e-mail addresses you have authorized on the Manage Your Kindle page to help prevent spam. The default setting dictates that only items sent from your Amazon.com account e-mail address will be forwarded. You can add e-mail addresses to the list by visiting :

<http://www.amazon.com/manageyourkindle>

In Manage Your Kindle, add the addresses of your friends, co-workers, or anyone else you would like to enable to send you files:

1. In the Your Kindle approved e-mail list section from <http://www.amazon.com/manageyourkindle>, enter the e-mail address in the blank box.
2. Select "Add Address."

Once you have set up the e-mail addresses, you can send and convert your personal documents by following the steps below:

1. Attach your document to a new e-mail or forward an existing e-mail that has a document attached. A subject is not necessary.
2. Address the e-mail to your Kindle e-mail address for wireless delivery directly to your Kindle; a fee will be charged.
3. Send the e-mail.



Tip: You can choose to convert PDF file(s) that are sent to your device by adding the word "convert" in the email subject line.

For details on fees, click on the Learn more link in the “Your individual charges” section of your Manage Your Kindle page for your Kindle on Amazon.com.



Tip: If you would like to avoid the fee, address the e-mail so that the second part of your Kindle e-mail address is @free.kindle.com. After sending to the @free.kindle.com address, a link to the converted file will be e-mailed to your Amazon.com e-mail address. You can then download the file to your Kindle’s documents folder via USB using your computer.

The conversion service on Your Kindle is meant for the receipt of personal, non-commercial documents only. You may not authorize the sending of documents from automated distribution services.

8.4 Audiobooks and MP3s

You can purchase, transfer, and play audiobooks from Audible.com as well as transfer MP3 files to Kindle to play as background audio while you read.

AUDIOBOOKS FROM AUDIBLE.COM

Kindle supports the thousands of audiobooks available through Audible.com. You can purchase and download one or more of these books from Audible.com through your Windows or Mac-based computer and then transfer these books over USB to your Kindle’s “Audible” folder, and listen to them on your Kindle. Once on your Kindle, an Audible file will be displayed on your Home screen with your other documents. The file will have the word “audio” next to the title to indicate that it is an audiobook.

AUDIOBOOK FORMATS FOR KINDLE

Audible offers five versions of its audiobook format. Kindle is compatible with formats 4 and Audible Enhanced (AAX). Formats 1, 2, 3 and audiobooks provided from other sources are not supported.

ACTIVATION, PURCHASE, DOWNLOAD, AND TRANSFER

The first time you play an Audible audiobook, you will be prompted to register your Kindle with Audible. Make sure you register with your Audible account name and password, not your Amazon account credentials.

To transfer audiobooks to your Kindle, follow these steps:

1. Connect your Kindle to your computer, using the USB cable that came with the device.
2. Your Kindle should appear on your computer in the same location you would normally find an external USB drive.
3. Open your Kindle. You should see a folder entitled "Audible." Drag any audiobooks you want to play on your Kindle into this folder.
4. Using your computer, unmount your Kindle from your computer. The content you transferred should now appear in Home.



Tip: To pause the playing of Audible, press the space bar on the keyboard and press the spacebar again to resume.

TRANSFERRING MP3s

You can transfer your MP3 files to Kindle by copying them to the "music" folder on your Kindle over USB. For more information on connecting your computer over USB, see Making the Connection earlier in this chapter.

Kindle only supports MP3 audio files; AAC, WAV, MP3 with DRM and other music file formats are not supported.

To transfer MP3s to your Kindle, follow these steps:

1. Connect your Kindle to your computer, using the USB cable that came with the device.
2. Your Kindle should appear on your computer in the same location you would normally find an external USB drive.
3. Open your Kindle. You should see a folder entitled "music." Drag any MP3s you'd like to play on your Kindle, into this folder.
4. Using your computer, unmount your Kindle from your computer.

For more information on playing background music, see Chapter 3.



Tip: While there is no limit to the number of MP3 files and audiobooks that you can transfer to your Kindle, keep in mind that these files are larger, and space may become a consideration. 

CHAPTER 9:

Your Kindle and Amazon.com

In addition to shopping directly from your device, you can acquire the same books, magazines, newspaper subscriptions, and other content you find on the Kindle Store using a Web browser on your computer. You can also go to the Manage Your Kindle page on Amazon.com to manage your Kindle account, change or cancel a subscription, or look up a past Kindle order. If you need help, Kindle Support on Amazon.com gives you information, e-mail, and phone access to dedicated customer service representatives.

9.1 Shopping for Kindle Content on Amazon.com

This section shows you how to purchase content for your Kindle on Amazon.com. As with purchases on the Kindle Store, Kindle content is auto-delivered wirelessly to your Kindle.

BROWSING THE KINDLE STORE

When browsing the Kindle Store on Amazon.com, you use categories and sub-categories to find content that suits your interests. Each page shows listings of content relevant to the categories or sub categories you have navigated to and clicked on. Once inside a category, you can further refine your browse by topic. Each page shows the path taken so you can easily retrace your steps.

SEARCHING THE KINDLE STORE

When searching the Kindle Store on Amazon.com, you use the Amazon.com search engine to find relevant Kindle content associated with the keyword or phrase that you type into the search box. The search engine finds and displays lists of content along with descriptive images, titles, authors and ratings. You can narrow down the results by categories by clicking on the link located in the left side of of the search results page.

GETTING THE DETAILS

The product detail page for Kindle content provides the most pertinent information to help you make a purchase decision. In addition to cover image, title, author and pricing information, the product detail page gives you insight into the content from other readers. For example, you can read customer reviews and check out “Customers Who Bought This Book Also Bought” to find out what other customers have enjoyed. From the product detail page you can purchase Kindle books, newspapers, blogs and other periodicals with Amazon.com 1-Click.

ORDERING CONTENT

Ordering content from the product detail page is as easy as the click of a button. Similar to ordering directly from your Kindle, you can place orders from detail pages on Amazon.com and receive your content in typically under a minute. Once you make a selection, your order is auto-delivered wirelessly to your Kindle. You do not need to use your computer to download your content. If you have more than one Kindle, you can use the drop-down menu below the Buy Box to choose which Kindle should receive your order.

The following describes the “buy box” actions:

Buy now with 1-Click: — click this button to purchase a Kindle book or current periodical issue. Your order will be auto-delivered wirelessly to your Kindle in under a minute.

Subscribe now with 1-Click — click this button to start a newspaper, magazine, or blog subscription with a 14-day free trial. Your subscription will be auto-delivered wirelessly to your Kindle. You can cancel at any time during your 14-day free trial and you will not be charged.

Send sample now — click this button to receive a free sample of a book on your Kindle. You can read the beginning of the book for free. If you enjoy it, you can make a purchase directly from your Kindle or return to the Kindle Store on Amazon.com if you prefer to purchase from your computer.

9.2 Managing Your Kindle on Amazon.com

This section gives you instructions on how to find and use the Manage Your Kindle page on Amazon.com. The Manage Your Kindle page is a versatile online tool you can use to view and manage your Kindle content, personal settings, and account information. It can be found at:

<http://www.amazon.com/manageyourkindle>

Below are some of the tasks you can manage:

MANAGING YOUR DEVICE

Your Kindle(s)

Edit Info: manages the same options available on Kindle's Settings menu such as the name that appears on the top of your Kindle Home screen; allows you to change your Kindle e-mail address to which you or others can send e-mail attachments to be read on your Kindle (see Chapter 8 for more information on converting personal documents).

Deregister: disassociates the Kindle from your account if you transfer ownership of the device to someone else.

Register a new Kindle: registers your Kindle to your personal Amazon.com account.

Your iPhone(s) and iPod Touch(es)

Edit Info: allows you to change the current name of your iPhone or iPod Touch.

Deregister: disassociates the iPhone or iPod Touch from your account if you transfer ownership of the device to someone else.

Your Kindle approved e-mail list — allows you to maintain a list of e-mail addresses authorized to send e-mail personal documents to your Kindle.

Your Country — allows you to change the country associated with your Kindle account. Due to copyright restrictions, you will only be able to purchase Kindle titles available in your country. When you move to a new country, you should update the country setting to be able to purchase Kindle titles available in your new location.

MANAGING YOUR ORDERS

Delivery status for — view the status of recently ordered books and your subscriptions to determine what content has been recently delivered wirelessly to your Kindle(s).

Your default 1-Click payment method — allows you to update the payment method Kindle uses to make purchases on Amazon.com. All Kindle transactions are completed with 1-Click. Changes made to your default 1-Click method will apply to your future Amazon.com 1-Click transactions, but will not change your current active Kindle subscriptions.

Your active Kindle subscriptions — view which subscriptions are currently active, change payment information, and see billing details, and re-download past issues up to seven issues prior. You can see all of your active and inactive subscriptions by going to “Manage Your Kindle Subscriptions,” which you access from the Your Account or Manage Your Kindle pages. Click the “+” located next to the name of the periodical to download individual editions to your computer or to a specific Kindle.

Your orders — view your purchase history and re-download past orders. You can view details of individual orders, including information such as order date. Click the “+” located next to the name of a title to download individual orders to your computer or to a specific Kindle device.

Your individual charges — individual charges include fees for Personal Document Service (via Whispernet). Click the “+” located next to a date to see more details about converted documents.

Manage synchronization between devices. — allows you to turn Whispersync off or on. When Whispersync is off, your book will still open to the last page read on that Kindle, but Whispersync will no longer sync its annotations or furthest page read with other Kindles. If you plan to read the same book on more than one Kindle at a time, it is recommended that you keep synchronization on.

DOWNLOADING CONTENT FROM YOUR COMPUTER

To transfer content downloaded to your computer, over to your Kindle, follow these steps:

1. Connect the USB cable (provided with your Kindle) to the Kindle and your computer.
2. Your Kindle should appear on your computer in the same location you would normally find an external USB drive.
3. Open your Kindle. You should see a folder entitled "documents."
4. Transfer the downloaded files into the "documents" folder of your Kindle.
5. Using your computer, unmount your Kindle from your computer. The content you transferred should now appear in Home.

9.3 Contacting Kindle Support

If you have problems with your Kindle, please contact one of our Customer Service members who will be happy to assist you.

From within the U.S.:

web: <http://www.amazon.com/kindlesupport>

e-mail: kindle-cs-support@amazon.com

phone: **1-866-321-8851** (toll free)

Outside the U.S.:

phone: **1-206-266-0927** (charges will apply) 

CHAPTER 10: Migrating Content to Your New Kindle

If you already own another Kindle, this section will help you understand how to transfer your content to your new device. Copies of all your books and recent issues of newspapers and magazines purchased from the Kindle Store are kept on Amazon.com.



Tip: You can download and share Kindle books with multiple Kindles registered to your Amazon account.

10.1 Transferring Books

To transfer Kindle books to your new device, follow these steps:

1. Press the Home button.
2. Use the 5-way to underline “Archived Items” and press the 5-way to select.
3. Use the 5-way to underline the book you want to transfer.
4. Move the 5-way to the right and “add to home” will appear under the title.
Press the 5-way to download the item to your new Kindle.

You can also transfer books to your device by visiting the Manage Your Kindle page on Amazon.com with your computer. From your computer’s Web browser, open:

<http://www.amazon.com/manageyourkindle>

Scroll down to the section entitled “Your orders.” This lists the Kindle books you have purchased. Clicking the “+” sign next to a book expands the item’s window.

On the right side of the window are two boxes, one called “Download to computer” and another with the name of one of your Kindle devices. (The device name is listed in the upper left corner of the device’s Home screen.)

To transfer your purchased Kindle content using Whispernet:

1. Pull down on the box containing the name of one of your Kindles and select the Kindle to which you want to download the content.
2. Select “Go.”
3. The content you transferred should now appear in Home.

To transfer your purchased Kindle content over USB:

1. Select "Download to computer" and the file will appear on your desktop.
2. Connect the USB cable (provided with your Kindle) to the Kindle and your computer.
3. Your Kindle should appear on your computer in the same location you would normally find an external USB drive.
4. Open your Kindle. You should see a folder entitled "documents."
5. Transfer the downloaded files into the "documents" folder of your Kindle.
6. Using your computer, unmount your Kindle from your computer. The content you transferred should now appear in Home.

10.2 Transferring Periodical Subscriptions

To transfer a periodical subscription from one Kindle to another, follow these steps:

1. From your computer's Web browser, open:
<http://www.amazon.com/manageyourkindle>
2. Scroll down to the section entitled "Your Active Kindle subscriptions."
3. Under "Deliver future editions," select the Kindle to which you'd like the subscription to be transferred and select "Save."
4. Upon the next delivery of your subscription, the periodical will appear in the designated Kindle.

10.3 Transferring Personal Documents

To transfer personal documents you have stored on a Kindle to another Kindle, follow these steps:

1. Connect the Kindle you want to transfer information from to your computer using the USB cable provided for that particular Kindle.
2. Your Kindle should appear on your computer in the same location you would normally find an external USB drive.
3. Open your Kindle. You should see a folder entitled "documents." Transfer your personal documents from this folder to the computer's desktop.
4. Using your computer, unmount your Kindle from your computer.
5. Connect the Kindle you want to receive the personal documents to your computer using the USB cable provided for that particular Kindle.
6. Open your Kindle. Transfer your personal documents from your computer desktop to your Kindle's "documents" folder.
7. Using your computer, unmount your Kindle from your computer. The content you transferred should now appear in Home.

10.4 Transferring Audiobooks

To transfer audiobooks you have stored on a Kindle to another Kindle, follow these steps:

1. Connect the Kindle you want to transfer an audiobook from, to your computer using the USB cable provided for that particular Kindle.
2. Your Kindle should appear on your computer in the same location you would normally find an external USB drive.
3. Open your Kindle. You should see a folder entitled "Audible." Transfer this folder to the computer's desktop.
4. Using your computer, unmount your Kindle from your computer.
5. Connect the Kindle you want to receive the audiobooks to your computer using the USB cable provided for that particular Kindle.
6. Open your Kindle. Transfer the "Audible" folder from your computer desktop to your Kindle. You may receive a message asking if you want to replace the folder already on the Kindle, select "Replace" or "Yes."
7. Using your computer, unmount your Kindle from your computer. The content you transferred should now appear in Home.

The first time you play an audiobook on your new Kindle, you will be prompted to register the device with Audible. Make sure you register with your Audible account name and password, not your Amazon account credentials.

10.5 Transferring MP3s

To transfer MP3s you have stored on a Kindle to another Kindle, follow these steps:

1. Connect the Kindle you want to transfer an MP3 from, to your computer using the USB cable provided for that particular Kindle.
2. Your Kindle should appear on your computer in the same location you would normally find an external USB drive.
3. Open your Kindle. You should see a folder entitled "music." Transfer this folder to the computer's desktop.
4. Using your computer, unmount your Kindle from your computer.
5. Connect the Kindle you want to receive the music folder to your computer using the USB cable provided for that particular Kindle.
6. Open your Kindle. Transfer the "music" folder from your computer desktop to your Kindle. You may receive a message asking if you want to replace the folder already on the Kindle, select "Replace" or "Yes."
7. Using your computer, unmount your Kindle from your computer. 

CHAPTER 11:

Troubleshooting

You can resolve many problems with your Kindle, quickly and easily. If you encounter any of the following problems with your Kindle, click on the issue for help.

- **My Kindle won't turn on/My Kindle is unresponsive or appears frozen.**
- **My wireless isn't working.**
- **I'm unable to download a book even though I see strong wireless signal strength**
- **I only received a partial download of my Kindle Content or my Kindle Content seems to be corrupted.**
- **I'm having problems transferring content from my computer to my Kindle**
- **Text-to-speech sounds distorted.**
- **My Kindle doesn't charge when using the power adapter.**
- **I can't open any of my books and receive an error message instead.**
- **None of my problems are listed above. What should I do?**

MY KINDLE WON'T TURN ON/MY KINDLE IS UNRESPONSIVE OR APPEARS FROZEN.

Recharge your Kindle using the power adapter that came with the device and plug it into an AC outlet. Make sure that the charging light next to the micro-USB port lights up while you are charging. Allow the device to be charged in this manner for at least 30 minutes.

Slide and release the power switch. If your Kindle does not turn on then try resetting it by doing the following:

1. Disconnect your Kindle from any power source.
2. Slide and hold the power switch for 15 seconds, then release.

Note that the screen will be blank for about 30 seconds while your Kindle restarts.

MY WIRELESS ISN'T WORKING.

Try restarting your Kindle by doing the following:

1. Press the Home button.
2. Press the Menu button.
3. Select "Settings."
4. Press the Menu button.
5. Select "Restart."

I'M UNABLE TO DOWNLOAD A BOOK EVEN THOUGH I SEE STRONG WIRELESS SIGNAL STRENGTH.

Try restarting your Kindle by doing the following:

1. Press the Home button.
2. Press the Menu button.
3. Select "Settings."
4. Press the Menu button.
5. Select "Restart."

[Back to List](#)

I ONLY RECEIVED A PARTIAL DOWNLOAD OF MY KINDLE CONTENT OR MY KINDLE CONTENT SEEMS TO BE CORRUPTED.

Delete the content and re-download from Archived Items by following these steps:

1. Use the 5-way controller to select the content from Home.
2. Move the 5-way to the left to delete and press the 5-way to confirm.
3. Open Archived Items in Home and select the content.
4. Press the 5-way to re-download the content.

I'M HAVING PROBLEMS TRANSFERRING CONTENT FROM MY COMPUTER TO MY KINDLE.

Try connecting your Kindle directly to your computer's USB port instead of a USB hub or keyboard. If your Kindle was already connected directly to your computer's USB port, then try a different port on your computer. If you have anti-virus software installed on your computer, turn it off temporarily prior to transferring content from your computer to your Kindle.

TEXT-TO-SPEECH SOUNDS DISTORTED.

Try switching between male and female voices and then back again. If that does not resolve the issue then try restarting your Kindle by doing the following:

1. Press the Home button.
2. Press the Menu button.
3. Select "Settings."
4. Press the Menu button.
5. Select "Restart."

If that does not solve the issue, play an MP3 or Audible file on your Kindle using the device's built-in speakers. If the audio still sounds distorted, contact Customer Service.

For instructions on downloading an MP3 or Audible file, see Section 8.4.

[Back to List](#)

MY KINDLE DOESN'T CHARGE WHEN USING THE POWER ADAPTER.

Check to see if the charging light next to your Kindle's micro-USB port is lit. If not, then try another AC outlet. If the charging light still does not come on, then try restarting your Kindle by doing the following:

1. Press the Home button.
2. Press the Menu button.
3. Select "Settings."
4. Press the Menu button.
5. Select "Restart."

I CAN'T OPEN ANY OF MY BOOKS AND RECEIVE AN ERROR MESSAGE INSTEAD.

Try restarting your Kindle by doing the following:

1. Press the Home button.
2. Press the Menu button.
3. Select "Settings."
4. Press the Menu button.
5. Select "Restart."

If restarting your Kindle does not resolve the issue, then try doing a factory reset of your Kindle. Prior to doing so, back up any personal documents, periodical issues older than the past seven issues that you'd like to keep, MP3, and Audible files. To do a factory reset

1. Press the Home button.
2. Press the Menu button.
3. Select "Settings."
4. Press the Menu button.
5. Select "Reset to Factory Defaults."
6. After your Kindle restarts, go to Archived Items in Home and re-download the items you'd like to read. Transfer back the personal documents and other files you had previously backed up.

[Back to List](#)

NONE OF MY PROBLEMS ARE LISTED ABOVE. WHAT SHOULD I DO?

Many issues can be resolved by restarting your Kindle. Try the following:

1. Press the Home button.
2. Press the Menu button.
3. Select "Settings."
4. Press the Menu button.
5. Select "Restart."

If restarting your Kindle doesn't work, then try resetting your Kindle by doing the following:

1. Disconnect your Kindle from any power source.
2. Slide and hold the power switch for 15 seconds before releasing.

Note that the screen will be blank for approximately 30 seconds while your Kindle restarts. 

[Back to List](#)

APPENDIX

SAFETY AND COMPLIANCE INFORMATION

Use Responsibly. Read all instructions and safety information before use to avoid injury.

 **CAUTION! FAILURE TO FOLLOW THESE SAFETY INSTRUCTIONS COULD RESULT IN FIRE, ELECTRIC SHOCK, OR OTHER INJURY OR DAMAGE.**

MAINTAINING YOUR KINDLE

Do not use your Kindle or its accessories in rain, or near sinks or other wet locations. Take care not to spill any food or liquid in your Kindle. If your device does get wet, unplug all cables, turn off the wireless (go to Menu, and choose Turn Wireless Off) and let the screen revert to the screen saver. Wait for the device to dry completely before sliding the switch to wake again. Do not attempt to dry your Kindle with an external heat source, such as a microwave oven or hair dryer. Clean the screen with a soft cloth; be careful not to wipe it with anything abrasive. When carrying your Kindle in a bag or briefcase, keep a book cover on to avoid scratches.

Don't expose your Kindle to extreme heat or cold. For example, don't leave it in the trunk of your car in sub-zero or high-heat conditions.

SERVICING YOUR DEVICE

If your device needs service, consult only Amazon.com authorized personnel by contacting us through Customer Support:

e-mail: kindle-cs-support@amazon.com

phone: within the U.S.: 1-866-321-8851 (toll free)
outside the U.S.: 1-206-266-0927 (charges will apply)

Faulty service may void the warranty.

BATTERY SAFETY

The rechargeable battery in your Kindle should be replaced only by an authorized service provider. For more information about batteries, go to:

<http://www.amazon.com/kindleterms>

HEADPHONE SAFETY

Listening to audio at high volume for extended periods of time can cause hearing damage. To avoid this problem, consider the tips below:

1. Keep the volume down;
2. Avoid prolonged, continuous listening; and
3. Wear headphones that isolate the wanted audio from background noise.

WIRELESS SAFETY AND COMPLIANCE

Turn Amazon Whispernet off in areas where wireless use is forbidden or when it may cause interference or danger. Some specific situations are described below. In general, you should not use your Kindle with Whispernet turned on any place you are not allowed to use a cellular device.

TURN OFF WIRELESS WHEN FLYING

To prevent possible interference with aircraft systems, the U.S. Federal Aviation Administration regulations require you to have permission from a crew member to use your device's wireless service. If you have your wireless service turned off, you can use your Kindle for reading once a crew member has said it is okay to use electronic devices.

BE CAREFUL AROUND OTHER ELECTRONIC DEVICES

Kindle generates, uses, and can radiate radio frequency (RF) energy and, if not used in accordance with its instructions, may cause harmful interference to radio communications and electronic equipment. External RF signals may affect improperly installed or inadequately shielded electronic operating systems, entertainment systems and personal medical devices. While most modern electronic equipment is shielded from external RF signals, if in doubt, check with the manufacturer. For personal medical devices (such as pacemakers and hearing aids), consult with your physician or the manufacturer to determine if they are adequately shielded from external RF signals.

STEPS TO MINIMIZE INTERFERENCE

If your Kindle does cause harmful interference to radio or television reception (which you can determine by turning your Kindle off and on), you can try to correct the interference by one or more of the following measures: reorient or relocate the receiving antenna for the radio or television; increase the separation between the radio or television and your Kindle; connect equipment and receivers to different outlets; or consult the radio or television manufacturer or an experienced radio/TV technician for help.

WATCH FOR SIGNS

There are some places where RF signals could constitute a hazard, such as health care facilities, and construction sites. If you are not sure, look around for signs indicating that two-way radios or cell phones should be turned off.

INFORMATION REGARDING EXPOSURE TO RADIO FREQUENCY ENERGY AND FCC COMPLIANCE STATEMENT FOR MODEL NUMBER D00501, FCC ID: WI5-1210

EXPOSURE TO RADIO FREQUENCY ENERGY

Your Kindle device meets the U.S. government's requirements for exposure to radio waves. Kindle is designed and manufactured not to exceed the emission limits for exposure to RF energy set by the U.S. FCC.

The exposure standard for wireless devices employs a unit of measurement known as the specific absorption rate, or SAR. The SAR limit set by the FCC is 1.6 watts per kilogram (W/kg). Tests for SAR are conducted using standard operating positions accepted by the FCC with the device transmitting at its highest certified power level in all tested frequency bands.

Although the SAR is determined at the highest certified power level, the actual SAR level of Kindle while operating can be well below the maximum value. This is because Kindle is designed to operate at multiple power levels so as to use only the power required to reach the network. In general, the closer you are to a wireless base-station antenna, the lower the power output. The highest measured SAR value for this model Kindle as reported to the FCC when held at least 0.39 of an inch (1.0 cm) from the body is 1.32W/kg.

The FCC has granted an Equipment Authorization for this Kindle with all reported SAR levels evaluated as in compliance with the FCC RF exposure guidelines. SAR information on this Kindle is on file with the FCC and can be found under the Display Grant section of <http://www.fcc.gov/oet/ea/> after searching on FCC ID: WI5-1210.

This Kindle meets RF exposure guidelines when positioned at least 0.39 of an inch (1.0 cm) away from the body. Amazon sells Kindle-branded accessories that can be used to position the device at least 0.39 of an inch (1.0 cm) away from the body.

FCC COMPLIANCE STATEMENT

This device complies with part 15 of the FCC rules. Operation is subject to the following two conditions: (1) This device may not cause harmful interference; and (2) this device must accept any interference received, including interference that may cause undesired operation.

This device has been tested and found to comply with the limits for a Class B digital device, pursuant to part 15 of the FCC rules. These limits are designed to provide reasonable protection against harmful interference in a residential installation. However, there is no guarantee that interference will not occur in a particular installation.

This device meets the FCC Radio Frequency Emission Guidelines and is certified with the FCC as the FCC ID number found on the back of the device.

INFORMATION REGARDING EXPOSURE TO RADIO FREQUENCY ENERGY AND FCC COMPLIANCE STATEMENT FOR MODEL NUMBER D00701, FCC ID: W82-0725

EXPOSURE TO RADIO FREQUENCY ENERGY MODEL NO. D00701

Your Kindle is designed and manufactured not to exceed the emission limits for exposure to RF energy set by the Federal Communications Commission of the United States (FCC). Information on your Kindle is on file with the FCC and can be found under the Display Grant section of <http://www.fcc.gov/oet/ea/> after searching on the FCC ID for this device, which can be found on the back of the device.

FCC COMPLIANCE STATEMENT

This device complies with part 15 of the FCC rules. Operation is subject to the following two conditions: (1) This device may not cause harmful interference; and (2) this device must accept any interference received, including interference that may cause undesired operation.

This device has been tested and found to comply with the limits for a Class B digital device, pursuant to part 15 of the FCC rules. These limits are designed to provide reasonable protection against harmful interference in a residential installation. However, there is no guarantee that interference will not occur in a particular installation.

This device meets the FCC Radio Frequency Emission Guidelines and is certified with the FCC as the FCC ID number found on the back of the device.

COMPLIANCE INFORMATION FOR KINDLE USERS OUTSIDE THE US

You can see additional information for Kindle users outside the US by clicking on this link: <http://www.amazon.com/kindletermsandconditions>

RECYCLING KINDLE PROPERLY



In some areas, the disposal of certain electronic devices is regulated. Make sure you dispose of or recycle Kindle in accordance with your local laws and regulations. For information about recycling Kindle, go to: <http://www.amazon.com/kindle-recycling>

UL CERTIFICATION NUMBER

The UL Certification Number for this Kindle can be found on the back of the device.

PRODUCT SPECIFICATIONS

Model Number

Kindle – D00511

Kindle with international wireless - D00701

Display — 6" diagonal electrophoretic display, 600 x 800 pixel resolution, 167 pixels per inch, 16-level gray scale.

Size — 8 inches by 5.3 inches by 0.36 inches (203.2mm x 134.6mm x 9.1mm).

Weight — 10.2 ounces (289.2g).

Storage — 2GB internal storage, approximately 1.4GB available to the user.

Audio — 3.5mm stereo headphone jack, built-in stereo speakers.

Power — AC power adapter and rechargeable lithium polymer battery.

Connectivity — USB 2.0 (micro-B connector). EVDO/CDMA in Kindle and HSDPA/GSM wireless modem in Kindle with international wireless.

Operating temperature — 32°F to 95°F (0°C to 35°C).

Storage temperature — 14°F to 113°F (-10°C to 45°C).

KINDLE LICENSE AGREEMENT AND TERMS OF USE

THIS IS AN AGREEMENT BETWEEN YOU AND AMAZON DIGITAL SERVICES, INC. (WITH ITS AFFILIATES, "AMAZON" OR "WE"). PLEASE READ THIS LICENSE AGREEMENT AND TERMS OF USE, AND ALL RULES AND POLICIES FOR THE KINDLE DEVICE AND SERVICES RELATED TO THE DEVICE (INCLUDING, BUT NOT LIMITED TO, ANY RULES OR USAGE PROVISIONS SPECIFIED ON THE AMAZON.COM WEBSITE OR THE KINDLE STORE, AND THE AMAZON.COM PRIVACY NOTICE LOCATED AT WWW.AMAZON.COM/PRIVACY) (COLLECTIVELY, THIS "AGREEMENT") BEFORE USING THE KINDLE DEVICE. BY USING THE KINDLE DEVICE, YOU AGREE TO BE BOUND BY THE TERMS OF THIS AGREEMENT.

IF YOU DO NOT ACCEPT THE TERMS OF THIS AGREEMENT, YOU MAY RETURN THE KINDLE DEVICE AND ASSOCIATED SOFTWARE (WITH ALL ORIGINAL PACKAGING, MANUALS, AND ACCESSORIES) WITHIN THIRTY (30) DAYS OF PURCHASE FOR A REFUND OF ITS PURCHASE PRICE IN ACCORDANCE WITH THE KINDLE RETURN POLICY.

The Device and Related Services. The Kindle Device (the "Device") is a portable electronic reading device that utilizes wireless connectivity to enable users to shop for, download, browse, and read books, newspapers, magazines, blogs, and other materials, all subject to the terms and conditions of this Agreement. The "Service" means the wireless connectivity, provision of digital content, software and support, and other services and support that Amazon provides Device users.

WIRELESS CONNECTIVITY

General. Amazon provides wireless connectivity free of charge to you for certain content shopping and downloading services on your Device. You may be charged a fee for your use of other services on your Device, such as Web browsing and downloading of personal files, should you elect to use those services. We will maintain a list of current fees for such services in the Kindle Store. Amazon reserves the right to discontinue wireless connectivity at any time or to otherwise change the terms for wireless connectivity at any time, including, but not limited to (a) limiting the number and size of data files that may be transferred using wireless connectivity and (b) changing the amount and terms applicable to receive services wirelessly.

Coverage and Service Interruptions. You acknowledge that if your Device is located in any area without applicable wireless connectivity, you may not be able to use some or all elements of the wireless services. We are not responsible for the unavailability of wireless service or any interruptions of wireless connectivity.

Your Conduct. You agree you will use the wireless connectivity provided by Amazon only in connection with Services Amazon provides for the Device. You may not use the wireless connectivity for any other purpose.

DIGITAL CONTENT

The Kindle Store. The Kindle Store enables you to download, display and use on your Device a variety of digitized electronic content, such as books, subscriptions to magazines, newspapers, journals and other periodicals, blogs, RSS feeds, and other digital content, as determined by Amazon from time to time (individually and collectively, "Digital Content").

Use of Digital Content. Upon your payment of the applicable fees set by Amazon, Amazon grants you the non-exclusive right to keep a permanent copy of the applicable Digital Content and to view, use, and display such Digital Content an unlimited number of times, solely on the Device or as authorized by Amazon as part of the Service and solely for your personal, non-commercial use. Digital Content will be deemed licensed to you by Amazon under this Agreement unless otherwise expressly provided by Amazon.

Restrictions. Unless specifically indicated otherwise, you may not sell, rent, lease, distribute, broadcast, sublicense or otherwise assign any rights to the Digital Content or any portion of it to any third party, and you may not remove any proprietary notices or labels on the Digital Content. In addition, you may not, and you will not encourage, assist or authorize any other person to, bypass, modify, defeat or circumvent security features that protect the Digital Content.

Subscriptions. The following applies with respect to Digital Content made available to you on a subscription basis, including, but not limited to, electronic newspapers, magazines, journals and other periodicals (collectively, “Periodicals”): (i) you may request cancellation of your subscription by following the cancellation instructions in the Kindle Store; (ii) we may terminate a subscription at our discretion without notice, for example, if a Periodical is no longer available; (iii) if we terminate a subscription in advance of the end of its term, we will give you a prorated refund; (iv) we reserve the right to change subscription terms and fees from time to time, effective as of the beginning of the next term; and (v) taxes may apply to subscription fees and will be added if applicable.

SOFTWARE

Definitions. The following terms apply to the Device and to (a) all software (and the media on which such software is distributed) of Amazon or third parties that is pre-installed on the Device at time of purchase or that Amazon provides as updates/upgrades to the pre-installed software (collectively, the “Device Software”), unless you agree to other terms as part of an update/upgrade process; and (b) any printed, on-line or other electronic documentation for such software (the “Documentation”). As used in this Agreement, “Software” means, collectively, the Device Software and Documentation.

Use of the Device Software. You may use the Device Software only on the Device. You may not separate any individual component of the Device Software for use on another device or computer, may not transfer it for use on another device or use it, or any portion of it, over a network and may not sell, rent, lease, lend, distribute or sublicense or otherwise assign any rights to the Software in whole or in part.

No Reverse Engineering, Decompilation, Disassembly or Circumvention. You may not, and you will not encourage, assist or authorize any other person to, modify, reverse engineer, decompile or disassemble the Device or the Software, whether in whole or in part, create any derivative works from or of the Software, or bypass, modify, defeat or tamper with or circumvent any of the functions or protections of the Device or Software or any mechanisms operatively linked to the Software, including, but not limited to, augmenting or substituting any digital rights management functionality of the Device or Software.

Automatic Updates. In order to keep your Software up-to-date, Amazon may automatically provide your Device with updates/upgrades to the Software.

Export Regulations. You agree to comply with all export and re-export restrictions and regulations of the Department of Commerce and other United States agencies and authorities, and not to transfer, or encourage, assist or authorize the transfer of the Software to a prohibited country or otherwise in violation of any such restrictions or regulations.

Government End Users. The Software is a “Commercial item” as that term is defined at 48 C.F.R. § 2.101, consisting of “Commercial Computer Software” and “Commercial Computer Software Documentation,” as such terms are used in 48 C.F.R. §12.212 or 48 C.F.R. § 227.7202, as applicable. Consistent with these provisions, the Software is being licensed to U.S. Government end users (a) only as a Commercial item and (b) with only those rights as are granted to all other end users pursuant to the terms and conditions of this Agreement.

GENERAL

No Illegal Use and Reservation of Rights. You may not use the Device, the Service or the Digital Content for any illegal purpose. You acknowledge that the sale of the Device to you does not transfer to you title to or ownership of any intellectual property rights of Amazon or its suppliers. All of the Software is licensed, not sold, and such license is non-exclusive.

Information Received. The Device Software will provide Amazon with data about your Device and its interaction with the Service (such as available memory, up-time, log files and signal strength) and information related to the content on your Device and your use of it (such as automatic bookmarking of the last page read and content deletions from the Device). Annotations, bookmarks, notes, highlights, or similar markings you make in your Device and other information you provide may be stored on servers in the US. Information we receive is subject to the Amazon.com Privacy Notice.

Patents. The Device and/or methods used in association with the Device may be covered by one or more patents or pending patent applications.

Changes to Service. Amazon reserves the right to modify, suspend, or discontinue the Service at any time, and Amazon will not be liable to you should it exercise such right.

Termination. Your rights under this Agreement will automatically terminate without notice from Amazon if you fail to comply with any term of this Agreement. In case of such termination, you must cease all use of the Software and Amazon may immediately revoke your access to the Service or to Digital Content without notice to you and without refund of any fees. Amazon's failure to insist upon or enforce your strict compliance with this Agreement will not constitute a waiver of any of its rights.

Disclaimer of Warranties. YOU EXPRESSLY ACKNOWLEDGE AND AGREE THAT USE OF THE SERVICE, DEVICE, DIGITAL CONTENT AND SOFTWARE IS AT YOUR SOLE RISK. EXCEPT FOR THE ONE-YEAR LIMITED WARRANTY, THE SERVICE, DEVICE, DIGITAL CONTENT AND SOFTWARE ARE PROVIDED "AS IS" WITH ALL FAULTS AND WITHOUT WARRANTY OF ANY KIND AND AMAZON AND ITS SUPPLIERS AND LICENSORS DISCLAIM ALL WARRANTIES, EXPRESS OR IMPLIED, INCLUDING, BUT NOT LIMITED TO, THE IMPLIED WARRANTIES OF MERCHANTABILITY, FITNESS FOR A PARTICULAR PURPOSE, ACCURACY, QUIET ENJOYMENT AND NON-INFRINGEMENT OF THIRD-PARTY RIGHTS. NO ORAL OR WRITTEN INFORMATION OR ADVICE GIVEN BY AMAZON OR AN AUTHORIZED REPRESENTATIVE OF AMAZON SHALL CREATE A WARRANTY. THE LAWS OF CERTAIN JURISDICTIONS DO NOT ALLOW THE DISCLAIMER OF IMPLIED WARRANTIES. IF THESE LAWS APPLY TO YOU, SOME OR ALL OF THE ABOVE DISCLAIMERS, EXCLUSIONS OR LIMITATIONS MAY NOT APPLY TO YOU, AND YOU MAY HAVE ADDITIONAL RIGHTS.

Limitation of Liability. TO THE EXTENT NOT PROHIBITED BY LAW, NEITHER AMAZON NOR ITS SUPPLIERS OR LICENSORS SHALL BE LIABLE TO YOU FOR ANY INCIDENTAL OR CONSEQUENTIAL DAMAGES FOR BREACH OF ANY EXPRESS OR IMPLIED WARRANTY, BREACH OF CONTRACT, NEGLIGENCE, STRICT LIABILITY OR ANY OTHER LEGAL THEORY RELATED TO THE SERVICE, DEVICE, DIGITAL CONTENT OR SOFTWARE, INCLUDING, BUT NOT LIMITED TO, ANY DAMAGES ARISING OUT OF LOSS OF PROFITS, REVENUE, DATA OR USE OF THE DEVICE OR SOFTWARE OR ANY ASSOCIATED PRODUCT, EVEN IF AMAZON HAS BEEN ADVISED OF THE POSSIBILITY OF SUCH DAMAGES. IN ANY CASE, AMAZON'S AGGREGATE LIABILITY UNDER THIS AGREEMENT SHALL BE LIMITED TO THE AMOUNT ACTUALLY PAID FOR THE DEVICE. THE LAWS OF CERTAIN JURISDICTIONS DO NOT ALLOW THE EXCLUSION OR LIMITATION OF INCIDENTAL OR CONSEQUENTIAL DAMAGES. IF THESE LAWS APPLY TO YOU, SOME OR ALL OF THE ABOVE EXCLUSIONS OR LIMITATIONS MAY NOT APPLY TO YOU, AND YOU MAY HAVE ADDITIONAL RIGHTS.

Washington Law Applies. The laws of the state of Washington, without regard to principles of conflict of laws, will govern this Agreement and any dispute of any sort that might arise between you and Amazon.

Disputes. ANY DISPUTE ARISING OUT OF OR RELATING IN ANYWAY TO THIS AGREEMENT SHALL BE SUBMITTED TO CONFIDENTIAL ARBITRATION IN SEATTLE, WASHINGTON, EXCEPT THAT, TO THE EXTENT YOU HAVE IN ANY MANNER VIOLATED OR THREATENED TO VIOLATE AMAZON'S INTELLECTUAL PROPERTY RIGHTS, AMAZON MAY SEEK INJUNCTIVE OR OTHER APPROPRIATE RELIEF IN ANY STATE OR FEDERAL COURT IN THE STATE OF WASHINGTON, AND YOU CONSENT TO EXCLUSIVE JURISDICTION AND VENUE IN SUCH COURTS. The arbitrator's award shall be binding and may be entered as a judgment in any court of competent jurisdiction. To the fullest extent permitted by applicable law, no arbitration under this Agreement shall be joined to an arbitration involving any other party subject to this Agreement, whether through class arbitration proceedings or otherwise.

Severability. If any term or condition of this Agreement shall be deemed invalid, void, or for any reason unenforceable, that part shall be deemed severable and shall not affect the validity and enforceability of any remaining term or condition.

Amendment. Amazon reserves the right to amend any of the terms of this Agreement at its sole discretion by posting the revised terms on the Kindle Store or the Amazon.com website. Your continued use of the Device and Software after the effective date of any such amendment shall be deemed your agreement to be bound by such amendment.

Contact Information. For communications concerning this Agreement, you may contact Amazon by writing to Amazon.com, Attn: Legal Department, 1200 12th Avenue South, Suite 1200, Seattle, WA, 98144-2734.

WARRANTY INFORMATION FOR MODEL NUMBER D00501

ONE-YEAR LIMITED WARRANTY

This Warranty is provided by Amazon Fulfillment Services, Inc. for the Kindle Device Model Number D00501 (the "Device").

We warrant the Device against defects in materials and workmanship under ordinary consumer use for one year from the date of original retail purchase. During this warranty period, if a defect arises in the Device, and you follow the instructions for

returning the Device, we will, at our option, either (i) repair the Device using either new or refurbished parts, (ii) replace the Device with a new or refurbished Device, or (iii) refund the purchase price of the Device.

This limited warranty applies to any repair, replacement part or replacement Device for the remainder of the original warranty period or for ninety days, whichever period is longer. All replaced parts and Devices for which a refund is given shall become our property. This limited warranty applies only to hardware components of the Device that are not subject to accident, misuse, neglect, fire or other external causes, alterations, repair, or commercial use.

Instructions. Please contact Customer Service for specific instructions about how to obtain warranty service for your Device:

In the United States: 1-866-321-8851

Outside the United States: 1-206-266-0927

In general, you will need to deliver your Device, postage paid, in either its original packaging or in equally protective packaging to the address specified by Customer Service. Before you deliver your Device for warranty service, it is your responsibility to back up any data, software, or other materials you may have stored or preserved on your Device. It is possible that such data, software or other materials will be lost or reformatted during service, and we will not be responsible for any such damage or loss.

LIMITATIONS.

TO THE EXTENT PERMITTED BY LAW, THE WARRANTY AND REMEDIES SET FORTH ABOVE ARE EXCLUSIVE AND IN LIEU OF ALL OTHER WARRANTIES AND REMEDIES, AND WE SPECIFICALLY DISCLAIM ALL STATUTORY OR IMPLIED WARRANTIES, INCLUDING, BUT NOT LIMITED TO, WARRANTIES OF MERCHANTABILITY, FITNESS FOR A PARTICULAR PURPOSE AND AGAINST HIDDEN OR LATENT DEFECTS. IF WE CANNOT LAWFULLY DISCLAIM STATUTORY OR IMPLIED WARRANTIES, THEN TO THE EXTENT PERMITTED BY LAW, ALL SUCH WARRANTIES SHALL BE LIMITED IN DURATION TO THE DURATION OF THIS EXPRESS LIMITED WARRANTY AND TO REPAIR OR REPLACEMENT SERVICE AS DETERMINED BY US IN OUR SOLE DISCRETION. SOME STATES DO NOT ALLOW LIMITATIONS ON HOW LONG AN IMPLIED WARRANTY LASTS, SO THE ABOVE LIMITATION MAY NOT APPLY TO YOU.

WE ARE NOT RESPONSIBLE FOR DIRECT, SPECIAL, INCIDENTAL OR CONSEQUENTIAL DAMAGES RESULTING FROM ANY BREACH OF WARRANTY OR UNDER ANY OTHER LEGAL THEORY. SOME STATES DO NOT ALLOW THE EXCLUSION OR LIMITATION OF INCIDENTAL OR CONSEQUENTIAL DAMAGES, SO THE ABOVE EXCLUSION OR LIMITATION MAY NOT APPLY TO YOU.

This limited warranty gives you specific legal rights, and you may have other rights which vary from state to state.

WARRANTY INFORMATION FOR MODEL NUMBER D00701

ONE-YEAR LIMITED WARRANTY

This Warranty is provided by Amazon Fulfillment Services, Inc., 1200 12th Ave South, Suite 1200, Seattle, WA 98144-2734, United States, for the Kindle Device (the "Device").

We warrant the Device against defects in materials and workmanship under ordinary consumer use for one year from the date of original retail purchase. During this warranty period, if a defect arises in the Device, and you follow the instructions for returning the Device, we will, at our option and to the extent permitted by law, either (i) repair the Device using either new or refurbished parts, (ii) replace the Device with a new or refurbished Device, or (iii) refund to you all or part of the purchase price of the Device.

This limited warranty applies to any repair, replacement part or replacement Device for the remainder of the original warranty period or for ninety days, whichever period is longer. All replaced parts and Devices for which a refund is given shall become our property. This limited warranty applies only to hardware components of the Device that are not subject to accident, misuse, neglect, fire or other external causes, alterations, repair, or commercial use.

Instructions. Please contact Customer Service for specific instructions about how to obtain warranty service for your Device:

e-mail: kindle-cs-support@amazon.com

phone: within the U.S.: 1-866-321-8851 (toll free)
outside the U.S.: 1-206-266-0927 (charges will apply)

In general, you will need to deliver your Device in either its original packaging or in equally protective packaging to the address specified by Customer Service. Before you deliver your Device for warranty service, it is your responsibility to back up any data, software, or other materials you may have stored or preserved on your Device. It is possible that such data, software or other materials will be lost or reformatted during service, and we will not be responsible for any such damage or loss.

LIMITATIONS.

TO THE EXTENT PERMITTED BY LAW, THE WARRANTY AND REMEDIES SET FORTH ABOVE ARE EXCLUSIVE AND IN LIEU OF ALL OTHER WARRANTIES AND REMEDIES, AND WE SPECIFICALLY DISCLAIM ALL STATUTORY OR IMPLIED WARRANTIES, INCLUDING, BUT NOT LIMITED TO, WARRANTIES OF MERCHANTABILITY, FITNESS FOR A PARTICULAR PURPOSE AND AGAINST HIDDEN OR LATENT DEFECTS. IF WE CANNOT LAWFULLY DISCLAIM STATUTORY OR IMPLIED WARRANTIES, THEN TO THE EXTENT PERMITTED BY LAW, ALL SUCH WARRANTIES SHALL BE LIMITED IN DURATION TO THE DURATION OF THIS EXPRESS LIMITED WARRANTY AND TO REPAIR OR REPLACEMENT SERVICE AS DETERMINED BY US IN OUR SOLE DISCRETION. SOME JURISDICTIONS DO NOT ALLOW LIMITATIONS ON HOW LONG A STATUTORY OR IMPLIED WARRANTY LASTS, SO THE ABOVE LIMITATION MAY NOT APPLY TO YOU.

WE ARE NOT RESPONSIBLE FOR DIRECT, SPECIAL, INCIDENTAL OR CONSEQUENTIAL DAMAGES RESULTING FROM ANY BREACH OF WARRANTY OR UNDER ANY OTHER LEGAL THEORY. IN SOME JURISDICTIONS THE FOREGOING LIMITATION DOES NOT APPLY TO DEATH OR PERSONAL INJURY CLAIMS, OR ANY STATUTORY LIABILITY FOR INTENTIONAL AND GROSS NEGLIGENT ACTS AND/OR OMISSIONS, SO THE ABOVE EXCLUSION OR LIMITATION MAY NOT APPLY TO YOU. SOME JURISDICTIONS DO NOT ALLOW THE EXCLUSION OR LIMITATION OF DIRECT, INCIDENTAL OR CONSEQUENTIAL DAMAGES, SO THE ABOVE EXCLUSION OR LIMITATION MAY NOT APPLY TO YOU.

This limited warranty gives you specific legal rights. You may have additional rights which vary from jurisdiction to jurisdiction and this limited warranty does not affect those rights.

PATENT NOTICES

The Kindle device and/or methods used in association with the Kindle device may be covered by one or more patents or pending patent applications.

MPEG Layer-3 audio decoding technology licensed from Fraunhofer IIS and Thomson.

COPYRIGHT AND TRADEMARK NOTICES

Amazon Kindle device software, the Amazon Kindle Quick Start Guide, and the Amazon Kindle User's Guide © 2004 - 2009 Amazon Technologies, Inc. or its affiliates. All rights reserved.

1-CLICK, AMAZON, the AMAZON.COM LOGO, the AMAZONKINDLE LOGO, AMAZON KINDLE, AUDIBLE, KINDLE, MOBIPOCKET, WHISPERNET AND WHISPERSYNC are trademarks of Amazon Technologies, Inc. or its affiliates.



Java and all Java based trademarks and logos are trademarks or registered trademarks of Sun Microsystems, Inc. in the U.S. and other countries.

NF Browser v3.4 © 1996 – 2008 ACCESS Co., Ltd. ACCESS is a trademark or registered trademark of ACCESS Co., Ltd. in Japan and other countries.

RealSpeak™ Solo © 2008 Nuance Communications, Inc. RealSpeak™ and Nuance® are trademarks or registered trademarks of Nuance Communications, Inc. in the United States and/or other countries.

Native PDF support via Adobe® Reader® technology.

All other brands, product names, company names, trademarks, and service marks are the properties of their respective owners.

OTHER LANGUAGE VERSIONS

You can see a version of the *Kindle License Agreement and Terms of Use, One-Year Limited Warranty* and other Kindle information in other languages by clicking on this link: <http://www.amazon.com/kindletermsandconditions> 

Free Manuals Download Website

<http://myh66.com>

<http://usermanuals.us>

<http://www.somanuals.com>

<http://www.4manuals.cc>

<http://www.manual-lib.com>

<http://www.404manual.com>

<http://www.luxmanual.com>

<http://aubethermostatmanual.com>

Golf course search by state

<http://golfingnear.com>

Email search by domain

<http://emailbydomain.com>

Auto manuals search

<http://auto.somanuals.com>

TV manuals search

<http://tv.somanuals.com>