

# APC

AMERICAN POWER CONVERSION

## POWERCELL<sup>®</sup>

**Models**

Network

Professional

Personal

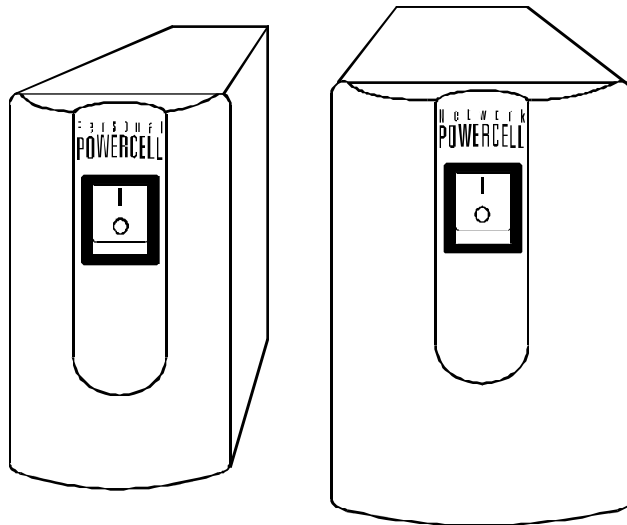

## User's Manual

# ***Important safety instructions!***

---

***Please read this manual!***

***Veillez lire ce manuel!***

***¡Se ruega leer este manual de instrucciones!***

Thank you for selecting this American Power Conversion Uninterruptible Power System (UPS). It has been designed for many years of reliable, maintenance free service. American Power Conversion is dedicated to the development of high performance electrical conversion and control products and we hope that you will find this UPS a valuable, convenient addition to your computing system.

This manual provides safety, installation and operating instructions that will help you derive the fullest performance and service life that the UPS has to offer. In addition, the manual describes the inner workings of the UPS and how they relate to providing superior protection from utility power problems such as blackouts, brownouts, sags, EMI/RFI noise and surges.

***Please save this manual!***

It includes important instructions for the safe use of this UPS and for obtaining factory service should the proper operation of the UPS come into question. Down the road, service or storage issues may arise and require reference to this manual.

***Conserver ces instructions!***

Cette notice contient des instructions importantes concernant la sécurité.

***Please save or recycle the packaging materials!***

The UPS's shipping materials were designed with great care to provide protection from transportation related damage. The shipping materials will become invaluable to you in case the UPS must be returned to the factory for service (damages sustained in transit when shipped from the user are not covered under warranty).

Entire contents copyright © 1993 American Power Conversion. All rights reserved; reproduction in whole or in part without permission is prohibited. PowerCell and PowerChute are registered trademarks of APC. All other trademarks are the property of their respective owners.

# **Table of contents**

---

<b>1.0</b>	<b>Introduction .....</b>	<b>2</b>
<b>2.0</b>	<b>Safety! .....</b>	<b>5</b>
	Sécurité! (Français) .....	6
	Seguridad! (Español) .....	7
<b>3.0</b>	<b>Installation .....</b>	<b>8</b>
<b>4.0</b>	<b>Principles of operation .....</b>	<b>13</b>
<b>5.0</b>	<b>Controls and indicators .....</b>	<b>19</b>
<b>6.0</b>	<b>UPS monitoring .....</b>	<b>20</b>
<b>7.0</b>	<b>Difficulty .....</b>	<b>22</b>
	Difficulté (Français) .....	23
	Dificultad (Español) .....	24
<b>8.0</b>	<b>Storing the UPS .....</b>	<b>29</b>
<b>9.0</b>	<b>Run time versus load .....</b>	<b>30</b>
<b>10.0</b>	<b>Specifications .....</b>	<b>31</b>
<b>10.0</b>	<b>Warranty, Life support policy .....</b>	<b>cover</b>

*This page intentionally left blank.*

# **1.0 Introduction**

---

## **1.1 Overview**

Your PowerCell is a high performance standby uninterruptible power system designed to protect computers and peripheral devices such as monitors, modems, tape drives, etc. from utility line failures which could result in the loss or corruption of valuable data. In the event of a utility failure such as a blackout, brownout or sag, the PowerCell rapidly transfers loads (computer equipment) to an alternative power source. This alternative power is derived from a battery within the PowerCell and provides the user with ample time to save files and properly close operations. A chart in section 9.0 shows how much time your equipment can remain operating during a utility failure before your PowerCell's batteries are drained. Under normal conditions when the utility voltage is within limits which are safe for your equipment, your PowerCell maintains the battery in a charged condition and serves to isolate your equipment from surges and high frequency electrical noise.

After following the installation procedures and reading all the safety instructions, you're ready to enjoy computing free from the worry of power problems and the time consuming process of constantly saving your files!

## **1.2 User replaceable battery**

Your PowerCell provides user-safe access to the batteries for quick, easy replacement. When it has been determined that the UPS's battery is weak and requires replacement, a new battery kit can be obtained from the factory - simply call the Customer Service number on the cover of this manual. Your PowerCell's old, worn battery can be returned to the factory for recycling in the new battery kit's packaging.

## **1.3 Site wiring fault indicator**

A site wiring fault indicator warns you of hot-neutral reversal, open ground and overloaded neutral faults. Faulty wiring prevents the safety features and surge protection circuits built into this UPS from operating properly. Check this indicator during installation or whenever your building's wiring has been serviced - call a qualified electrician if the indicator is illuminated.

# **1.0 Introduction**

---

## **1.4 Surge suppression and EMI/RFI filtering**

Your PowerCell provides high performance surge suppression and EMI/RFI (electromagnetic and radio frequency interference) filtering. The UPS suppresses surges defined by the ANSI C62.41 (formerly IEEE 587) Category A and B standard to levels well below that which is compatible with your computer.

## **1.5 Remote interface - Network model**

A remote computer interface port capable of signalling utility failure and low battery conditions is provided for unattended shutdown of computer operations. When teamed with American Power Conversion's PowerChute UPS monitoring software, you may select operation of power event logging, power event notification, automatic restart upon power restoration, and battery conservation features.

## 2.0 Safety !

ENGLISH

**Caution!**



### **CAUTION !**

- To reduce the risk of electric shock, disconnect the Uninterruptible Power Source from the mains before installing a computer interface signal cable (when used). Reconnect the power cord only after all signalling interconnections have been made.
- Connect the Uninterruptible Power Source to a two-pole, three-wire grounding mains receptacle. The receptacle must be connected to appropriate branch protection (fuse or circuit breaker). Connection to any other type of receptacle may result in a shock hazard and may violate local electrical codes.
- This Uninterruptible Power Source has an internal energy source (the battery) that cannot be de-energized by the user. **The output may be energized when the unit is not connected to a mains supply.**
- To properly de-energize the Uninterruptible Power Source in an emergency, move the I/O switch to the O (off) position and disconnect the power cord from the mains.
- Avoid installing the Uninterruptible Power Source in locations where there is water or excessive humidity.
- Do not allow water or any foreign object to get inside the Uninterruptible Power Source. Do not put objects containing liquid on or near the unit.
- To reduce the risk of overheating the Uninterruptible Power Source, avoid exposing the unit to the direct rays of the sun. Avoid installing the unit near heat emitting appliances such as a room heater or stove.

**Attention!**



### **ATTENTION!**

- Pour réduire le risque d'électrocution, débranchez la prise principale de la source d'alimentation permanente (Uninterruptible Power Source), avant d'installer le câble d'interface allant à l'ordinateur (si utilisé). Ne rebranchez le bloc d'alimentation qu'après avoir effectué toutes les connections.
- Branchez la source d'alimentation permanente (UPS) dans une prise de courant à 3 dérivations (deux pôles et la terre). Cette prise doit être munie d'une protection adéquate (fusible ou coupe-circuit). Le branchement dans tout autre genre de prise pourrait entraîner un risque d'électrocution et peut constituer une infraction à la réglementation locale concernant les installations électriques.
- Cette source d'alimentation permanente (UPS) est munie d'une source d'énergie interne (accumulateur) qui ne peut pas être désactivée par l'utilisateur. La prise de sortie peut donc être sous tension même lorsque l'appareil n'est pas branché.
- En cas d'urgence, pour désactiver correctement la source d'alimentation permanente (UPS), poussez l'interrupteur sur la position O (Off) et débranchez le cordon d'alimentation principal.
- Ne pas installer la source d'alimentation permanente (UPS) dans un endroit où il y a de l'eau ou une humidité excessive.
- Ne pas laisser de l'eau ou tout objet pénétrer dans la source d'alimentation permanente (UPS). Ne pas placer de récipients contenant un liquide sur cet appareil, ni à proximité de celui-ci.
- Pour éviter une surchauffe de la source d'alimentation permanente (UPS), conservez-la à l'abri du soleil. Ne pas installer à proximité d'appareils dégageant de la chaleur tels que radiateurs ou appareils de chauffage.





### **¡ATENCIÓN!**

- Para reducir el riesgo de descarga eléctrica, desconecte de la red la Fuente de energía ininterrumpible antes de instalar el cable de señalización de interfaz de la computadora (si se usa). Vuelva a conectar el conductor flexible de alimentación solamente una vez efectuadas todas las interconexiones de señalización.
- Conecte la Fuente de energía ininterrumpible a un tomacorriente bipolar y trifilar con neutro de puesta a tierra. El tomacorriente debe estar conectado a la protección de derivación apropiada (ya sea un fusible o un disyuntor). La conexión a cualquier otro tipo de tomacorriente puede constituir peligro de descarga eléctrica y violar los códigos eléctricos locales.
- Esta Fuente de energía ininterrumpible tiene una fuente de energía interna (la batería) que no puede ser desactivada por el usuario. La salida puede tener corriente aun cuando la unidad no se encuentre conectada al suministro de red.
- Para desactivar correctamente la Fuente de energía ininterrumpible en una situación de emergencia, coloque el interruptor I/O en la posición O (Off - desconectado) y desconecte de la red el conductor flexible de alimentación.
- No instale la Fuente de energía ininterrumpible en lugares donde haya agua o humedad excesiva.
- No deje que en la Fuente de energía ininterrumpible entre agua ni ningún objeto extraño. No ponga objetos con líquidos encima de la unidad ni cerca de ella.
- Para reducir el riesgo de sobrecalentamiento, no exponga la unidad a los rayos directos del sol ni la instale cerca de artefactos que emiten calor, como estufas o cocinas.

# 3.0 Installation

---

## 3.1 Receiving inspection

Once your PowerCell has been removed from its shipping container, it should be inspected for damage that may have occurred while in transit. Immediately notify the carrier and place of purchase if any damage is found. The packing materials are made from recyclable materials and should be saved for reuse or disposed of properly.

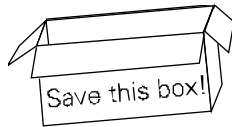

## 3.2 Placement

Your PowerCell may be installed in any protected environment. The location should provide adequate air flow around the unit, in an atmosphere free from excessive dust, corrosive fumes and conductive contaminants. Do not operate your PowerCell in an environment where the ambient temperature or humidity is outside the limits given in the **Specifications** section of this manual.

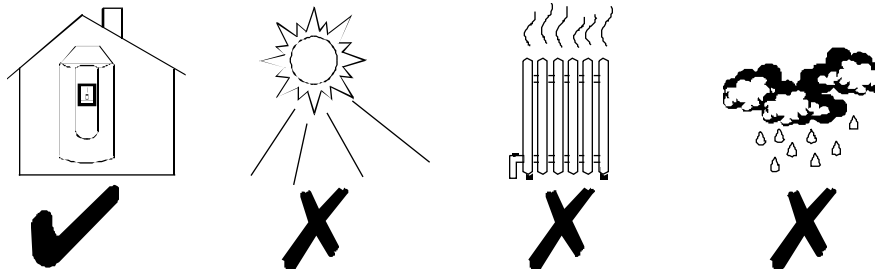

## 3.3 Load types

The PowerCell is designed to power all modern computer loads and associated peripheral devices such as monitors, modems, cartridge tape drives, external floppy drives, etc. The PowerCell is not rated to power life support equipment (as described on the rear cover of this manual).

**Caution:** *The output waveform of this UPS is a sine wave approximation suitable for use with modern computer power supplies. Other loads may malfunction or the UPS could be damaged. In particular, ferroresonant type regulating transformers are not recommended. Use of a surge suppressor connected to the output of this UPS may unnecessarily load the UPS when on-battery. This UPS contains high performance surge suppression - additional suppression components are not required and are not recommended. If in doubt, please consult the equipment manufacturer or the factory.*

# 3.0 Installation

---

## 3.4 Connecting to the utility

Your PowerCell is furnished with a 6 foot line cord terminated with a standard NEMA 5-15P three pronged plug. The UPS must be plugged into a 2 pole, 3 wire grounding receptacle. If an extension cord must be used between the UPS and the nearest wall outlet, use a 3 wire grounding type rated for at least 10 Amps.



Your PowerCell is provided with a rear SITE WIRING FAULT indicator. Once loads are connected, the indicator illuminates when the UPS is turned on and connected to an outlet whose wiring is improper or inadequate. This could mean that the “hot” and “neutral” wires at the wall receptacle are reversed, the ground wiring is missing, or the “neutral” wiring is overloaded.

**Note:** *If your PowerCell indicates a site wiring fault, a qualified electrician should be summoned to correct the service wiring.*

## 3.5 Battery charging

Your PowerCell is shipped from the factory with its internal battery in a fully charged state. However, the battery may lose some charge during shipping and storage. The battery should be recharged before conducting the following **Test for proper operation** (section 3.7) and to ensure that your PowerCell will provide expected run time. The battery is automatically charged by the UPS whenever the PowerCell is plugged in (the power I/O switch does not have to be on). You can be sure that the battery is fully recharged if the PowerCell is left plugged in for at least 6 hours. Your PowerCell may be used immediately upon receipt, but may not provide expected run time in the event of a utility power failure.

# 3.0 Installation

---

## 3.6 Connecting equipment to the PowerCell

To ensure that your computer equipment will be protected during a utility failure and that you receive expected run time, it is important that you determine the total power needs of the equipment you wish to protect with the PowerCell. The power requirements of your equipment should be less than or equal to the capacity of the PowerCell. The capacity rating of your PowerCell, in both Volt-Amperes (VA) and Watts (W), is given in the **Specifications** section of this manual.

The power demands of your equipment can be read from the **Run Time Verses Load** (section 9.0) chart or may be deduced from the equipment name plates. The **Run Time Versus Load** chart gives equipment power requirements (load) in VA for computer systems common in the office environment today. If your equipment is not listed in the chart, the following instructions will help you to determine their power needs.

**3.6.1** Computer equipment manufacturers must provide a load rating for their products. Usually, the rating is written on a name plate or label near the power input to the device. The rating may be given in units of Amps (A or Amax), Volt-Amperes (VA) or Watts (W). Jot down the load rating of all the equipment you wish to protect.

**3.6.2** All noted load ratings should be converted to Volt-Amperes (VA) so that equipment power requirements can be added together using the same units of measure.

**3.6.3** If load ratings are given in Watts (W), convert to an estimate of power requirements in VA by multiplying the value in Watts by 1.4.

**3.6.4** If load ratings are given in Amps (A or Amax), convert to an estimate of power requirements in VA by multiplying the value in Amps by 120. Unfortunately, many computer manufacturers overrate the power requirements of their equipment in order to be conservative and to cover the extra power demand of user added expansion boards. If the VA requirement that you have computed seems high or is already greater than the capacity of the UPS, don't worry. The next section describes a test that you can perform to determine whether or not your equipment and the PowerCell are compatible, even if the *computed* power

# 3.0 Installation

---

## 3.6 Connecting equipment to the PowerCell (continued)

requirement of your equipment is 50% greater than the capacity of the UPS!

**3.6.5** Once all power requirement figures have been converted to VA units and added together, simply determine whether the power requirements of your equipment is less than or equal to the capacity of your PowerCell. If this is not the case, then it must be decided which equipment should be left unprotected by the UPS. Many times, the system printer may be left unprotected. Print jobs lost in the event of utility failure can always be re-queued. See section 3.8 covering overloads.

**3.6.6** An example of how to determine the power requirements of a computer system is given below.

*Example - labels found at system equipment rear panels*

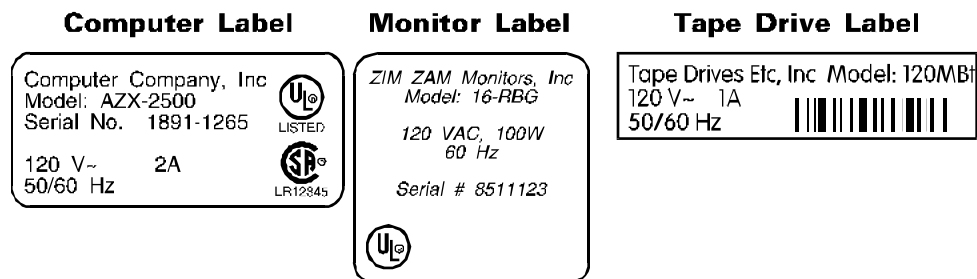

The power requirements of the example computer, monitor and external tape drive may be calculated as follows:

$$\begin{aligned} \text{Computer VA} &= 120 \times 2 \text{ A} = 240 \text{ VA} \\ \text{Monitor VA} &= 100 \times 1.4 = 140 \text{ VA} \\ \text{Tape Drive VA} &= 120 \times 1 \text{ A} = 120 \text{ VA} \\ \hline \text{Total} &= 500 \text{ VA} \end{aligned}$$

In this example, a UPS with at least 500 VA capacity can be employed to protect the computer, monitor and external tape drive. However, a UPS with somewhat lower capacity may still be used if the following test for proper operation is successful.

## 3.0 Installation

---

### 3.6 Connecting equipment to the PowerCell (continued)

3.6.7 Once you have determined that your equipment and the UPS are compatible, plug your equipment into the UPS's rear panel output receptacles.

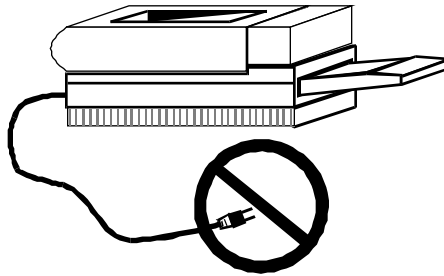

**Note:** Do not plug laser printers into your PowerCell! The power requirements of a typical laser printer are much larger than the requirements of other computer peripherals and may trip the UPS's rear panel circuit breaker. Plug laser printers into an APC SurgeArrest® surge suppressor. Remember that print jobs can be re-queued when the power is restored!

### 3.7 Test for proper operation

After your PowerCell has had a chance to recharge its battery, turn on the UPS's power I/O control and switch on your computer equipment. The indicator within the switch should be illuminated and your equipment should operate normally.

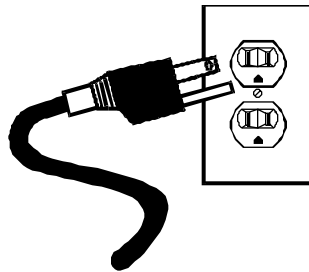

To test the operation of your PowerCell, simply unplug its input cord to simulate a utility blackout. The PowerCell will immediately transfer your equipment to power derived from the UPS's internal battery. During this time, the PowerCell will emit a beep once every five seconds to remind you that your equipment is operating from a source of power that is limited in duration. Restore power to the PowerCell by plugging in the line cord. Observe that your equipment operates normally during both transfer from utility power to UPS power and back again. Repeat this test four or five times to ensure proper operation. See the

## 3.0 Installation

---

### 3.7 Test for proper operation (continued)

following section covering **Overloads** if abnormal operation is encountered.

The power I/O control switches power to your equipment. If you leave your equipment power switches on, the I/O power control can be used as a master on/off switch!

### 3.8 Overloads

If the total power requirement of your equipment is much greater than the capacity of your PowerCell, its rear panel circuit breaker may trip. This is called an overload situation. Once the circuit breaker trips, the PowerCell will attempt to operate the load using its internal power source. This may result in an unexpectedly short run time or, if the overload is severe, the UPS will immediately shut down and cease to power the load. In this case, your PowerCell will emit a loud tone to alert you of the overload. If this occurs during your test, turn off the PowerCell and decide which equipment will be left unprotected by the UPS. The circuit breaker may be reset (press button) when the overload is removed.

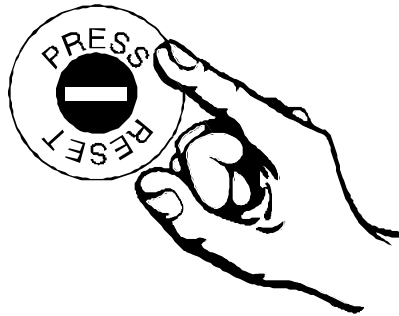

## 4.0 Principles of operation

---

Below is a block diagram showing the major components of your PowerCell UPS. These blocks are described on the following pages.

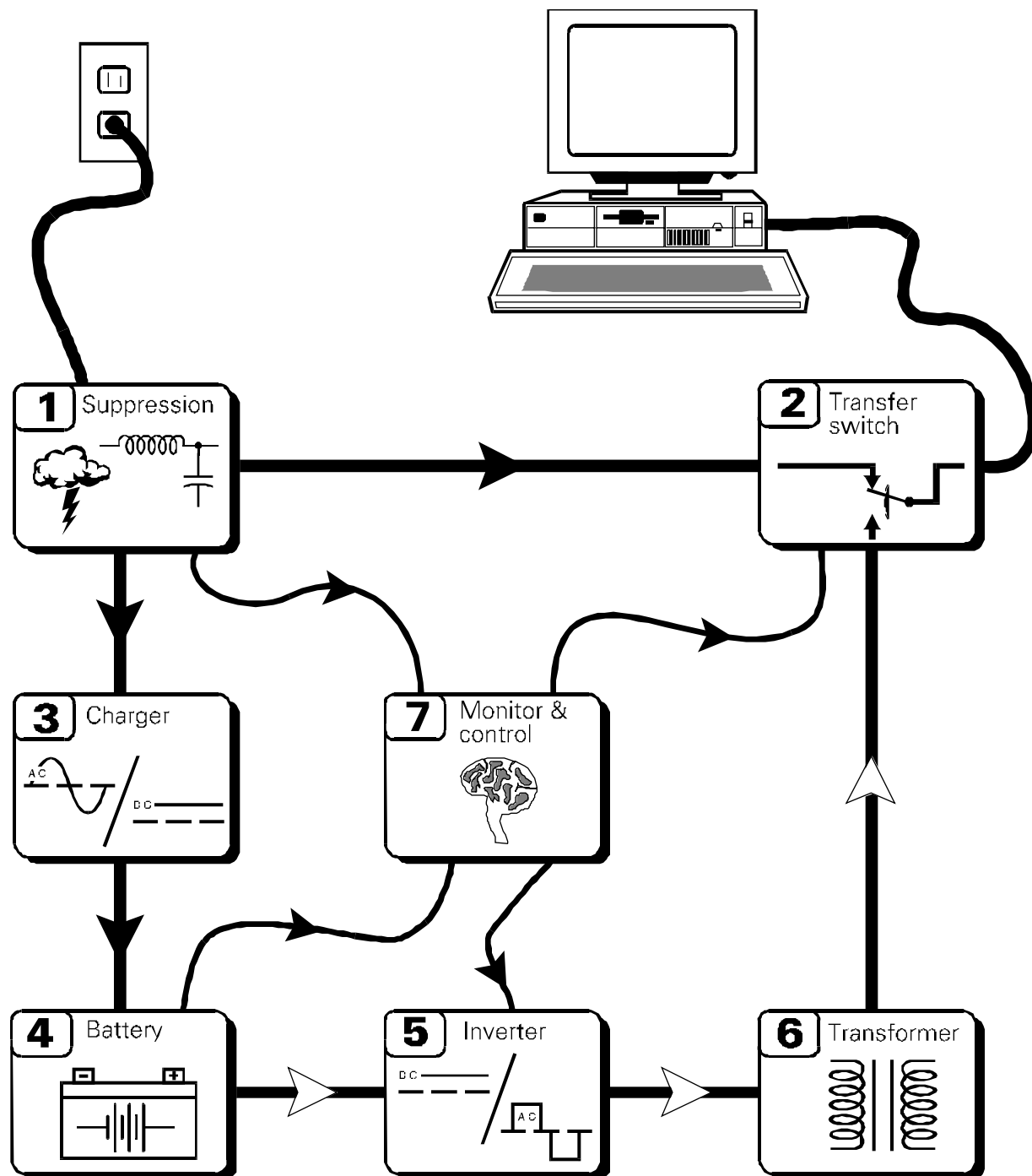

**Block diagram showing all major components of your UPS.**



# 4.0 Principles of operation

---

## 4.1 Noise and surge suppression

Your PowerCell contains high performance EMI/RFI (Electro-Magnetic and Radio Frequency Interference) noise and surge suppression circuitry to protect your computer equipment. The PowerCell provides this suppression continuously, whether or not it is turned on. Normally, your PowerCell suppresses noise and surges without your notice; that is, the UPS doesn't transfer your load to its internal power source. Instead, the suppression circuitry reduces the amplitude of noise and surges to a level well below that which can be tolerated by your relatively delicate computing equipment.

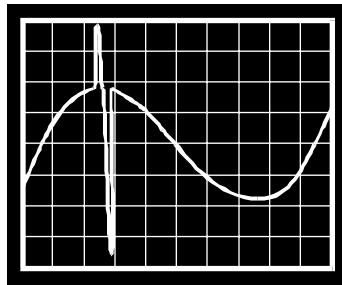

**Surge**

The illustration above shows what a typical “medium” amplitude surge or spike looks like when present on the utility voltage. Surges up to 15 times larger than this are easily suppressed by the PowerCell. Surges are commonly caused by nearby lightning activity and motor load switching created in air conditioners, elevators and heat pumps.

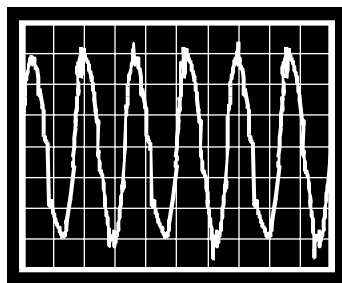

**EMI/RFI Noise**

The illustration above shows what EMI/RFI noise looks like when present on the utility voltage. The PowerCell “filters” out this noise with components whose electrical resistance is very high at radio frequencies. EMI/RFI noise is commonly created by the same activity which produces surges but can also be caused by nearby radio transmitters and blinking neon bulbs and signs.

# **4.0 Principles of operation**

---

## **4.2 Load transfer switch**

The load transfer switch is actually an electro-dynamic relay which serves to rapidly transfer your computer equipment (load) from the utility to the PowerCell's alternate power source in the event of a utility failure. When the utility is restored to within safe limits, the switch acts to re-transfer the load to the utility. Except for the user control switches, the transfer switch is the only moving part in the PowerCell. The time required for the relay to transfer your load to either power source is much, much faster than that which is required by any modern computer or computer peripheral device.

## **4.3 Battery charger**

In the event of utility failure, the PowerCell supplies power to your equipment derived from energy taken from a battery. The PowerCell's battery charger converts the alternating current (AC) supplied by the utility to a direct current (DC) which is compatible with the battery. The charger maintains the battery at a constant voltage to ensure that the battery will have the capacity to support your load as often as possible. This charging method, known as "float" charging, provides maximum battery service life and minimal internal heating. The battery charger operates whenever the PowerCell is plugged in, whether or not the UPS is turned on.

## **4.4 Battery**

The PowerCell's battery is an energy source much like the battery in an automobile. Also, like most automobile batteries, the PowerCell's battery is a modern maintenance free lead-acid type; it is sealed and leakproof. The battery has a typical service life of 3 to 6 years. The service life is extended when the PowerCell is kept in a cool environment, below 30°C or 86°F.

## **4.5 Inverter**

The PowerCell must convert the battery's energy into a form that your computer equipment can rely upon during a utility failure. This is the job of the UPS's inverter. The PowerCell converts the battery's DC to AC using solid state devices (transistors), controlled using a technique known technically as "pulse width modulation". This technique is highly efficient which means that little battery power is wasted in the conversion process. Hence, your equipment can run for long periods from the PowerCell before the battery's capacity is spent.

# **4.0 Principles of operation**

---

## **4.6 Transformer**

The PowerCell's transformer is an electrical component which "steps up" the output voltage of the inverter to the normal utility line voltage (115 Vac). In addition, it serves to isolate the PowerCell from equipment failures.

## **4.7 Monitoring and control electronics**

This block is the "brain" of the PowerCell. The monitoring and control circuitry detects utility failures such as blackouts, sags and brownouts; synchronizes the inverter's output frequency and phase to that of the utility; detects low battery voltage conditions; directs the load transfer switch; and governs all user controls, indicators and computer interface functions.

## **4.8 Operation during a utility failure**

In anticipation of a utility failure such as a blackout, sag or brownout, the PowerCell continuously monitors the utility voltage and readies the inverter for "synchronous" transfer. This means the inverter's phase and frequency is adjusted to exactly match the phase and frequency of the utility. If the utility voltage falls outside acceptable limits, the PowerCell rapidly transfers your equipment to power derived from the UPS's battery via the inverter and transformer described earlier. This transfer typically takes place within 3 milliseconds. Once operating in this mode, the PowerCell will emit a beep once every five seconds to remind you that the continuation of power is limited in duration. If the utility power is not restored to normal, the PowerCell will eventually sound a loud tone to alert you that less than two minutes remain before the UPS shuts down and ceases to power your equipment. This is called a low battery condition which means that the PowerCell's usable battery capacity is nearly spent. The PowerCell will automatically shut down if it is not turned off during the low battery alarm.

If the PowerCell detects the return of normal utility voltages at any time during operation using its alternate power source, the inverter voltage will be smoothly re-synchronized to match the phase and frequency of the utility. Once synchronized, the load transfer switch will re-transfer your equipment to power supplied by the utility. After an extended utility outage, the battery charger resupplies the battery with energy at a pace which is consistent with maximizing the service life

# 4.0 Principles of operation

---

## 4.8 Operation during a utility failure (continued)

of the battery (the battery *could* be charged faster, but wouldn't last as long).

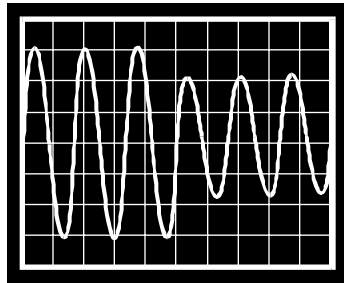

**Brownout**

Utility voltage sags are temporary amplitude reductions of the normal 120 Vac line. Utility voltage sags can be caused by local high power demand equipment such as elevators, air conditioners, shop tools and electric heaters. Brownouts, defined as long lasting utility voltage reductions, are sometimes initiated by the power company itself. During the hot season, the utility may choose to reduce the line voltage in order to cope with the huge power requirements of home and commercial use air conditioners.

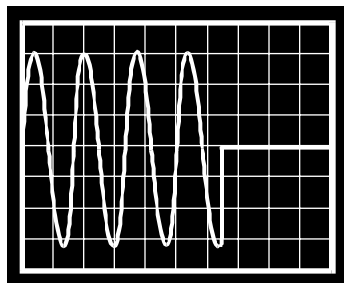

**Blackout**

Blackouts are defined by a complete loss of power. Often, blackouts are caused by accidents or acts of nature. However, they can also be created by overloaded "branch" circuits (building wiring segregated by fuses or circuit breakers), faulty circuit breakers or even a tripped-over line cord!

# 5.0 Controls and indicators

---

## 5.1 Power I/O switch

The power I/O switch controls power to the PowerCell and its output receptacles. When the switch is on, the PowerCell operates and your computer equipment will be powered. When the switch is off, the PowerCell is de-energized and your equipment is unpowered. If your equipment switches are left on, the entire system can be operated by using just the power I/O switch! The lamp within the power I/O switch illuminates whenever normal voltages are present at the output receptacles. When the switch is in the on position and the lamp is extinguished, the UPS has shut down due to overload or low battery.

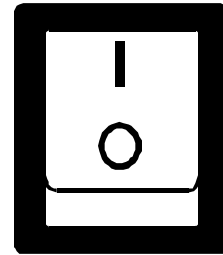

## 5.2 Audible alarm

During a utility failure, your PowerCell emits a beep once every five seconds to warn you that your equipment is operating from a source of power which is limited in duration. In the event of an extended utility failure, the PowerCell will sound a loud tone 2 minutes in advance of shut down due to battery capacity exhaustion. Once shut down, the UPS will return to the periodic beep. The PowerCell should be turned off at this point to cease the alarm. If your PowerCell is overloaded, it will shut down and emit a loud tone. The alarm is reset when the UPS is turned off.

## 5.3 Site wiring fault indicator

The site wiring fault indicator warns you of wiring conditions which could be hazardous and impair the UPS's ability to provide the highest degree of surge and noise suppression. The indicator will illuminate when the UPS is turned on and connected to an outlet in which the "hot" and "neutral" wires are reversed, the ground wiring is missing, or whose "neutral" wiring is overloaded. Normally, the indicator need only be checked at installation.

**Note:** *A qualified electrician should be summoned to correct the service wiring if the UPS detects a fault.*

# 6.0 UPS monitoring

---

***This applies to the NETWORK PowerCell only.***

*American Power Conversion offers a UPS monitoring / computer shut down solution for most all applications. After taking a look at the descriptions in this section, please call our toll-free number for additional technical and ordering information!*

## 1-800-4APC

### 6.1 Overview

A UPS system alone provides excellent protection from brief power problems. However, during an extended power outage an unattended computer system will eventually shut down due to battery capacity exhaustion. To prevent data corruption when the UPS shuts down, the computer must be informed by the UPS of *impending* shut down and take appropriate file-saving measures. This important function is called “UPS monitoring.” The UPS’s computer interface port is the means by which your UPS communicates with a computer system.

Some computer operating systems have built-in UPS monitoring. These systems require various hardware interfaces. Interface kits for all operating systems that support UPS monitoring are available from American Power Conversion. In addition, APC offers PowerChute® software which enhances such built-in UPS monitoring. Versions of PowerChute are available which add the UPS monitoring function to the many operating systems which do not inherently provide UPS monitoring.

### 6.2 Interface Kits

A series of interface kits is available for operating systems that provide UPS monitoring. Each interface kit includes the special interface cable required to convert status signals from the UPS into signals which individual operating systems recognize. Each kit includes all necessary installation instructions. Systems for which interface kits are offered include Novell, LAN Manager, LANtastic, Banyan VINES and IBM AS/400.

# 6.0 UPS monitoring

## 6.3 PowerChute® Software

PowerChute software provides complete data protection for most operating systems. This software is a background process that monitors the UPS through a RS-232 serial port on the host. PowerChute offers user notification of impending shutdown, power event logging, auto-restart upon power return and UPS battery conservation features. PowerChute is available for many platforms including Novell, LAN Manager, AppleShare, XENIX, most UNIX-based operating systems, and DEC VAX/VMS.

**Caution:** Use only factory supplied or authorized UPS monitoring cables!

## 6.4 Computer interface port

The NETWORK PowerCell computer interface port is diagramed below for reference. Those with technical abilities wishing to use this port in a special application should be aware of the following limitations and capabilities of the interface.

**6.4.1** Outputs at pins 3, 5 and 6 are actually open collector outputs which must be pulled up to a common referenced supply no greater than +40 Vdc. The transistors are capable of a maximum non-inductive load of 25 mAdc. Use only Pin 4 as the common.

**6.4.2** The output at Pin 2 will generate a LO to HI RS-232 level upon transfer of the output load to power derived from the UPS's battery. The pin is normally at a LO RS-232 level.

**6.4.3** The UPS will shut down when a HI RS-232 level, sustained for 0.5 s, is applied to Pin 1. The UPS responds to this signal, following a delay, only during utility failures.

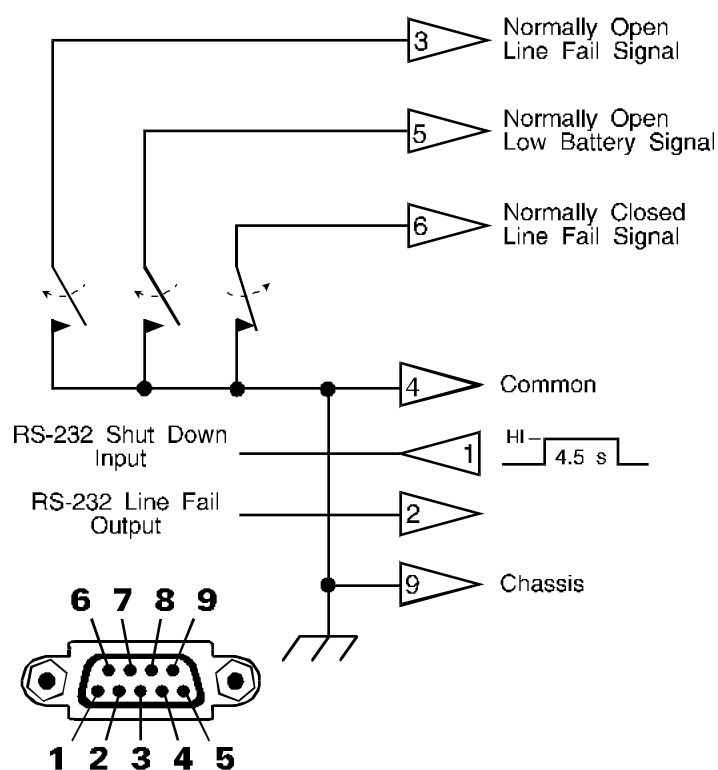



## 7.0 Difficulty

ENGLISH

**Caution !**



### **CAUTION !**

■ This Uninterruptible Power Source contains potentially hazardous voltages. Do not attempt to disassemble the unit. The unit contains no user serviceable parts. Repairs are performed only by factory trained service personnel.

■ This Uninterruptible Power Source uses batteries. The batteries will eventually become too weak to provide rated autonomous operation. To obtain battery replacement or repair service, please call the Customer Service telephone number written on the cover of this manual for information on the Service Center nearest you.

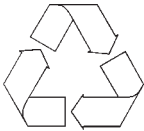

■ **The batteries used by this Uninterruptible Power Source are recyclable. Proper disposal of the batteries is required. The batteries contain lead and pose a hazard to the environment and human health if not disposed of properly. Please refer to local codes for proper disposal requirements or return the unit to a factory authorized Service Center for battery replacement or disposal.**

■ Battery replacement should be performed or supervised by personnel familiar with the danger of batteries and the required precautions. Keep unauthorized personnel away from batteries. When replacing batteries, use the same number and type of sealed lead acid batteries as were originally contained in your UPS.

■ **CAUTION** - Do not dispose of battery in a fire. The batteries may explode.

■ **CAUTION** - Do not open or mutilate the battery or batteries. They contain an electrolyte which is toxic and harmful to the skin and eyes.

■ **CAUTION** - A battery can present a risk of electrical shock and high short circuit current. When replacing batteries, wrist watches and jewelry such as rings should be removed. Use tools with insulated handles.



**Attention !**



### **ATTENTION!**

■ Cette source d'alimentation permanente (UPS) contient des circuits haute tension présentant un danger. Ne jamais essayer de le démonter. Il n'y a aucun composant qui puisse être réparé par l'utilisateur. Toutes les réparations doivent être effectuées par du personnel qualifié et agréé par le constructeur.

■ Cette source d'alimentation permanente (UPS) contient des accumulateurs. Ces accumulateurs deviendront un jour trop faibles pour pouvoir assurer un fonctionnement autonome correct. Pour toute réparation ou remplacement des accumulateurs, composez le numéro du Service à la clientèle inscrit sur la couverture de ce manuel afin d'obtenir les coordonnées du Centre de Service le plus proche.

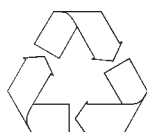

■ **Les accumulateurs contenus dans cette source d'alimentation sont recyclables. L'élimination des batteries est réglementée. Consulter les codes locaux à cet effet. Ils contiennent du plomb et représentent donc un risque pour l'homme et pour l'environnement si les règles de mise au rebut ne sont pas respectées. Veuillez retourner l'unité à un Centre de Service agréé lorsque vous désirerez remplacer ou vous débarrasser des accumulateurs usagés.**

■ **ATTENTION** - Pour le remplacement, utiliser le même nombre de batteries du modèle suivant: accumulateur au plomb.

■ **ATTENTION** - Une batterie peut présenter un risque de choc électrique, de brûlure par transfert d'énergie. Suivre les précautions qui s'imposent.

**¡Cuidado!**



**¡CUIDADO!**

■ Esta Fuente de energía ininterrumpible contiene niveles de voltaje peligrosos en potencia. No intente desarmar la unidad, pues no contiene piezas que puedan ser reparadas por el usuario. Las reparaciones deben efectuarse únicamente por parte del personal de mantenimiento capacitado en la fábrica.

■ Esta Fuente de energía ininterrumpible contiene baterías. Con el tiempo las baterías se gastan demasiado para poder sustentar el funcionamiento autónomo a la capacidad nominal. Para solicitar el reemplazo de baterías o servicio de reparaciones, se ruega llamar al número telefónico de Atención a los Clientes indicado en la tapa de este manual y averiguar el Centro de Servicio más cercano.

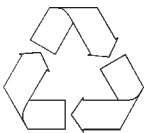

■ Las baterías que se encuentran en esta Fuente de energía ininterrumpible son reciclables. Las baterías contienen plomo y constituyen un peligro para el medio ambiente y para la salud de las personas si no se las desechan como corresponde. Se ruega devolver la unidad a un Centro de Servicio autorizado por la fábrica para el reemplazo o la eliminación de las baterías.

# 7.0 Difficulty

## 7.1 Troubleshooting chart

PROBLEM	POSSIBLE CAUSE	ACTION TO TAKE
UPS will not turn on (lamp within power I/O switch is not illuminated), but beeps when power I/O switch is on.	1. Line cord plug is loose.	1. Check fit of line cord plug.
	2. Rear panel circuit breaker is tripped.	2. Circuit breaker is tripped when button is extended. Unplug excessive loads and reset breaker (press button).
	3. Dead wall socket.	3. Check wall socket with a table lamp.
UPS operates normally, but SITE WIRING FAULT indicator is illuminated.	1. Building wiring error such as missing ground, hot and neutral polarity reversal, or overloaded neutral wiring.	1. A qualified electrician should be summoned to correct the building wiring. The UPS will not provide rated noise and surge suppression with incorrect building wiring.
	2. "Cheater" plug or adapter installed onto line cord plug (ground not connected).	2. Plug the UPS into 2 pole, 3 wire grounding outlet only.
UPS occasionally emits beep, computer equipment operates normally.	The UPS is briefly transferring your equipment to its alternate power source due to utility voltage sags or spikes.	This operation is normal. The UPS is protecting your computer equipment from abnormal utility voltages. If the audible alarm becomes annoying, set option switch #1 to the up position.
UPS emits beep very often, more than once or twice an hour. Computer equipment operates normally.	Utility voltage is distorted or branch circuits are heavily loaded.	Have your line voltage checked by an electrician. Operating your UPS from an outlet which is wired to a different branch fuse or circuit breaker may help. Adjust transfer voltage via option switches #2 or #3 if it is known that your equipment will operate normally at the utility voltages given in section 5.5.
UPS emits loud tone. Power I/O switch is on but computer equipment is not powered. UPS's rear panel circuit breaker is tripped (button is extended). Normal utility voltages are known to be present.	UPS has shut down due to severe overload.	Turn off UPS and unplug excessive loads. Laser printers will overload the UPS and should be plugged into a quality surge suppressor. See the section covering Overloads. Once overload is removed, reset the circuit breaker (press button).

# 7.0 Difficulty

## 7.1 Troubleshooting chart (continued)

PROBLEM	POSSIBLE CAUSE	ACTION TO TAKE
UPS emits loud tone during utility failure. Power I/O switch is on but computer equipment is not powered. Rear panel circuit breaker is not tripped.	UPS has shut down due to overload.	Turn off UPS and unplug excessive loads. Recheck computer system power requirements as described in installation instructions. UPS may be turned on when utility has been restored.
UPS does not provide expected run time. Low battery warning is sounded prematurely.	1. Excessive loads connected at UPS's output receptacles.	1. Unplug excessive loads from UPS. Recheck computer system power requirements as described in installation instructions.
	2. Battery is weak due to wear or recent operation during utility power outage.	2. The battery should be recharged by leaving the UPS plugged in for 12 hours - do not operate Test control during recharge. If UPS sounds low battery warning prematurely when retested, battery should be replaced.
UPS beeps continuously. Lamp within I/O power switch is illuminated. Utility is not failed.	1. Line cord plug is loose.	1. Check fit of line cord plug.
	2. Circuit breaker is tripped.	2. Unplug excessive loads and reset circuit breaker (press button).
UPS does not shut down when RS-232 HI level is applied to computer interface port pin 1.	1. Signal not applied during utility failure.	1. The UPS responds to this signal only during utility failures (load is operating from the UPS's internal power source).
	2. Signal is not referenced to UPS common.	2. Signal must be referenced to the UPS's common at pins 4 or 9.
Low battery warning interval is shorter than 2 or 5 minutes (according to option switch #4 setting).	1. Excessive loads connected at UPS's output receptacles.	1. Excessive loading may shorten run time to below 2 or 5 minute low battery warning interval - remove excessive loads.
	2. Battery capacity low due to consecutive utility failures.	2. Consecutive utility failures may not allow time for the battery to recharge thereby causing shortened run time.
Low battery warning interval is much longer than 2 or 5 minutes (according to option switch #4 setting).	UPS is loaded to less than 10% of rated capacity.	This operation is normal. The low battery warning interval is adjusted at the factory for consistent operation at loads above 10% of rated capacity.

# 7.0 Difficulty

---

## 7.2 Replacing the battery

You can expect to receive 3 to 6 years of service life from the PowerCell's battery when installed in a cool, dry location. If you suspect the battery is weak, allow the UPS to charge the battery for at least 12 hours and perform the **Test for proper operation** described in section 3.7. If after repeating the test you find that the run time is still too short, follow the procedures below to replace the battery.

*Note: Please read the cautions at the beginning of this section.*

**7.2.1** Turn off the UPS and unplug it from service. Lay the UPS on its left side and remove the two battery door screws. Remove only the screws indicated on the battery door.

**7.2.2** Gently pull out the battery by grasping the white tab.

**7.2.3** Remove the two wires connecting the battery to the UPS. To loosen the wire connectors, gently wiggle the connectors side-to-side while pulling straight back from the mating battery connector.

**7.2.4** Connect the battery wires to the new battery. The red wire is positive (+), the black wire is negative (-).

**7.2.5** Position the new battery as shown below and place it into the UPS. Arrange the wires so that they will not interfere with the battery installation.

**7.2.6** Close the battery door and fasten the two battery door screws.

**7.2.7** Return the worn battery to the factory for recycling.

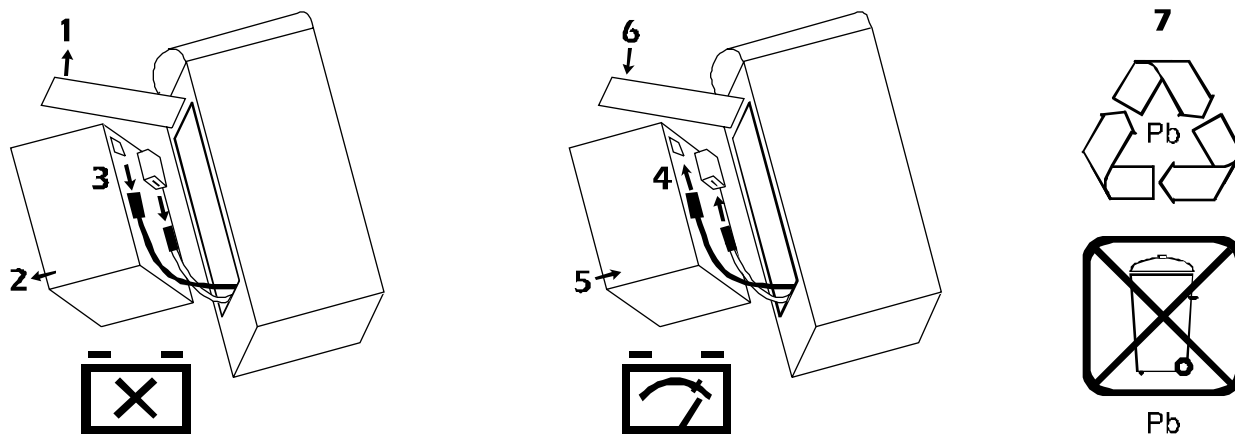

# 7.0 Difficulty

---

## 7.3 Obtaining Service

The troubleshooting chart in section 7.1 covers most of the difficulties that a user may encounter under conditions other than a failure of the PowerCell itself. For problems not covered in the chart, follow the below listed instructions.

■ See the troubleshooting chart and eliminate the obvious. **A tripped UPS circuit breaker is the most common problem encountered and is user resettable once excessive loads are unplugged from the UPS.**

■ If the circuit breaker is OK, note your UPS model, serial number and date of purchase. Contact the Customer Service Department at the phone number given on the cover of this manual.

■ Be prepared to provide a description of the problem. A technician will help you solve the problem over the phone if possible, or will give you a Return Material Authorization Number (RMA#).

■ If the UPS is within the warranty period, repairs will be performed free of charge. If it is not within the warranty period, there will be a charge for repair.

■ Pack the UPS in its original packaging. If you no longer have the original shipping materials, ask the technician about obtaining a new set. It is very important that you pack the UPS properly to avoid damage in transit. Never use styrofoam beads for packing because the UPS will settle through beads and become damaged. *Damages sustained in transit are not covered under warranty.* Enclose a letter in the package with your name, RMA#, address, copy of sales receipt, description of trouble, phone number and check (if necessary).

■ Mark your RMA# on the outside of the package. *The factory cannot accept any package without this marking.*

■ Return your UPS via insured, prepaid carrier to the address on the rear of this booklet.

# **8.0 Storing the UPS**

---

## **8.1 Storage conditions**

The PowerCell should be covered and stored in an upright position, in a cool, dry location. The PowerCell should be stored with the battery in a fully charged state. This means that the UPS should be allowed to charge the battery for at least 6 hours before the PowerCell is switched off for storage.

## **8.2 Extended storage**

To achieve expected run time following extended storage, the PowerCell should be allowed to refresh the battery for 12 hours once every 6 months in environments where the ambient temperature is  $-15^{\circ}\text{C}$  to  $+30^{\circ}\text{C}$  ( $5^{\circ}\text{F}$  to  $86^{\circ}\text{F}$ ). For extended storage in environments where the ambient temperature is  $+30^{\circ}\text{C}$  to  $+45^{\circ}\text{C}$  ( $86^{\circ}\text{F}$  to  $113^{\circ}\text{F}$ ), the UPS should be allowed to refresh the battery for 12 hours once every month.

## 9.0 Run time versus load

Load	PowerCell Models			Typical computer load
	PCPER	PCPRO	PCNET	
50 VA	37 min	100 min	145 min	Typical ASCII terminal
75 VA	29 min	72 min	105 min	Macintosh SE/30
100 VA	23 min	47 min	79 min	IBM PS/2 30 w/ monochrome monitor
150 VA	14 min	30 min	54 min	IBM PS/2 30 with 14" VGA monitor
200 VA	8 min	19 min	41 min	IBM PS/2 55sx with 14" VGA monitor
250 VA	5 min	13 min	31 min	Compaq 386/25e with 14" VGA monitor
300 VA		9 min	22 min	Compaq 386/33 with 14" VGA monitor
350 VA		7 min	17 min	IBM PS/2 80 file server
400 VA		5 min	13 min	Compaq 386/33 with 19" VGA monitor
450 VA			10 min	Compaq 486/33 with 19" VGA monitor
500 VA			7 min	Compaq Systempro server
550 VA			6 min	(2) Compaq 386/25e with VGA monitor
600 VA			5 min	(2) Compaq 386/33 with VGA monitor

**Note:** Run times are given at 25°C (77°F). Load values given in VA (Volt-Amps).



# 10.0 Specifications

---

## 9.1 Input

**Nominal input voltage:** single phase 120 Vac.

**Nominal input frequency:** 60 Hz.

## 9.2 Transfer Characteristics

**Frequency limits for on-line operation:** 60 Hz,  $\pm 5\%$ .

**Low input voltage limit for on-line operation:** 103 Vac.

## 9.3 Output Characteristics

**Maximum load:** 250 VA or 170 W, 400 VA or 250 W, and 600 VA or 400 W for models PERSONAL, PROFESSIONAL, and NETWORK respectively.

**Nominal output voltage:** 115 Vac,  $\pm 5\%$ .

**Frequency regulation:** 60 Hz,  $\pm 3\%$  Hz unless synchronized to the utility.

**Waveshape:** stepped approximation to sine wave, peak and rms values equivalent to the utility.

**Protection:** electronically overcurrent and short circuit protected, overload shutdown is latched.

## 9.4 Battery and charger

**Battery type:** maintenance free lead-acid, sealed and leakproof.

**Typical service life:** 3-6 years, dependent on number of discharges, temperature.

**Low battery signalling:** audible tone, computer interface port (NETWORK).

**Recharge time:** 6 to 10 hours, dependent on load and length of utility outage.

## 9.5 Surge and noise suppression

**Surge energy rating:** 240 Joules (one time, 10/1000 $\mu$ s waveform).

**Surge current capability:** 6500 Amp peak (one time, 8/20 $\mu$ s waveform).

**Surge response time:** 0 ns (instantaneous) normal mode, < 5 ns common mode.

**Noise filter:** full time EMI/RFI suppression, 100 kHz to 10 MHz.

## 9.6 Operating environment and physical dimensions

**Operating Environment:** 0°C - 40°C (32°F - 104°F); 0 - 95% RH, non condensing.

**Size:** 6.0" H x 3.4" W x 13.1" D (15 cm x 9 cm x 33 cm) for the PERSONAL and PROFESSIONAL; 6.6" H x 4.7" W x 14.2" D (17 cm x 12 cm x 36 cm) for the NETWORK.

**Weight:** 10 lb (4.6 kg), 18 lb (8.2 kg) and 25 lb (11.3 kg) for the PERSONAL, PROFESSIONAL, and NETWORK. Add 2 lb (1 kg) for shipping.

# **Notes**

---

# **Limited Warranty**

---

American Power Conversion (APC) warrants its products to be free from defects in materials and workmanship for a period of two years from the date of purchase. Its obligation under this warranty is limited to repairing or replacing, at its own sole option, any such defective products. To obtain service under warranty you must obtain a Returned Material Authorization (RMA) number from APC or an APC service center. Products must be returned to APC or an APC service center with transportation charges prepaid and must be accompanied by a brief description of the problem encountered and proof of date and place of purchase. This warranty does not apply to equipment which has been damaged by accident, negligence, or mis-application or has been altered or modified in any way. This warranty applies only to the original purchaser who must have properly registered the product within 10 days of purchase.

EXCEPT AS PROVIDED HEREIN, AMERICAN POWER CONVERSION MAKES NO WARRANTIES, EXPRESS OR IMPLIED, INCLUDING WARRANTIES OF MERCHANTABILITY AND FITNESS FOR A PARTICULAR PURPOSE. Some states do not permit limitation or exclusion of implied warranties; therefore, the aforesaid limitation(s) or exclusion(s) may not apply to the purchaser.

EXCEPT AS PROVIDED ABOVE, IN NO EVENT WILL APC BE LIABLE FOR DIRECT, INDIRECT, SPECIAL, INCIDENTAL, OR CONSEQUENTIAL DAMAGES ARISING OUT OF THE USE OF THIS PRODUCT, EVEN IF ADVISED OF THE POSSIBILITY OF SUCH DAMAGE. Specifically, APC is not liable for any costs, such as lost profits or revenue, loss of equipment, loss of use of equipment, loss of software, loss of data, costs of substitutes, claims by third parties, or otherwise. This warranty gives you specific legal rights and you may also have other rights which vary from state to state.

# **Life support policy**

---

As a general policy, American Power Conversion (APC) does not recommend the use of any of its products in life support applications where failure or malfunction of the APC product can be reasonably expected to cause failure of the life support device or to significantly affect its safety or effectiveness. APC does not recommend the use of any of its products in direct patient care. APC will not knowingly sell its products for use in such applications unless it receives in writing assurances satisfactory to APC that (a) the risks of injury or damage have been minimized, (b) the customer assumes all such risks, and (c) the liability of American Power Conversion is adequately protected under the circumstances.

Examples of devices considered to be life support devices are neonatal oxygen analyzers, nerve stimulators (whether used for anesthesia, pain relief, or other purposes), autotransfusion devices, blood pumps, defibrillators, arrhythmia detectors and alarms, pacemakers, hemodialysis systems, peritoneal dialysis systems, neonatal ventilator incubators, ventilators for both adults and infants, anesthesia ventilators, and infusion pumps as well as any other devices designated as "critical" by the U.S. FDA.

Hospital grade wiring devices and leakage current may be ordered as options on many APC UPS systems. APC does not claim that units with this modification are certified or listed as Hospital Grade by APC or any other organization. Therefore these units do not meet the requirements for use in direct patient care.



**AMERICAN POWER CONVERSION**

 **PHONE**

**(800) 800-4272 in USA, Canada**  
**(401) 789-5735 world wide**

 **MAILING**

**American Power Conversion**  
**132 Fairgrounds Road**  
**P.O. Box 278**  
**West Kingston, Rhode Island**  
**02892 USA**

***Note:*** *The troubleshooting chart in section 7.0 offers solutions for most of the difficulties you may encounter with this UPS. Before calling the customer service number, please have available your UPS's serial number (see the label at the rear of the UPS).*

Serial number: \_\_\_\_\_

990-2011-A-3 9/93

## Free Manuals Download Website

<http://myh66.com>

<http://usermanuals.us>

<http://www.somanuals.com>

<http://www.4manuals.cc>

<http://www.manual-lib.com>

<http://www.404manual.com>

<http://www.luxmanual.com>

<http://aubethermostatmanual.com>

Golf course search by state

<http://golfingnear.com>

Email search by domain

<http://emailbydomain.com>

Auto manuals search

<http://auto.somanuals.com>

TV manuals search

<http://tv.somanuals.com>