

RESIDENTIAL GAS WATER HEATERS



www.americanwaterheater.com
American Water Heater
Johnson City, TN 37605

GAS-FIRED



Low Lead Content

WARNING: If the information in these instructions is not followed exactly, a fire or explosion may result causing property damage, personal injury or death.

- Do not store or use gasoline or other flammable vapors and liquids in the vicinity of this or any other appliance.
- **WHAT TO DO IF YOU SMELL GAS:**
 - Do not try to light any appliance.
 - Do not touch any electrical switch; do not use any phone in your building.
 - Immediately call your gas supplier from a neighbor's phone. Follow the gas supplier's instructions.
 - If you cannot reach your gas supplier, call the fire department.
- Installation and service must be performed by a qualified installer, service agency or the gas supplier.

Thank you for buying this energy efficient water heater. We appreciate your confidence in our products.

**POWER VENT/POWER DIRECT VENT GAS MODELS
WITH HOT SURFACE IGNITION
MODEL VG6250T100 SERIES 124/125**
Complies with SCAQMD Low NOx Rule 1146.2





⚠ WARNING

Read and understand instruction manual and safety messages before installing, operating or servicing this water heater.

Failure to follow instructions and safety messages could result in death or serious injury.

Instruction manual must remain with water heater.

• For Your Safety •
AN ODORANT IS ADDED TO THE GAS USED
BY THIS WATER HEATER.

ALL TECHNICAL AND WARRANTY QUESTIONS: SHOULD BE DIRECTED TO THE LOCAL DEALER FROM WHOM THE WATER HEATER WAS PURCHASED. IF YOU ARE UNSUCCESSFUL, CALL THE TECHNICAL SUPPORT PHONE NUMBER SHOWN ON THE WATER HEATER LABELING.

**KEEP THIS MANUAL IN THE POCKET ON HEATER FOR FUTURE REFERENCE
WHENEVER MAINTENANCE ADJUSTMENT OR SERVICE IS REQUIRED.**





TABLE OF CONTENTS

SAFE INSTALLATION, USE AND SERVICE.....	3	Commonwealth of Massachusetts.....	22
APPROVALS.....	3	Installation of Carbon Monoxide Detectors.....	22
GENERAL SAFETY INFORMATION.....	4	Approved Carbon Monoxide Detectors.....	22
Precautions.....	4	Signage.....	22
Grounding Instructions.....	4	Exemptions.....	22
Hydrogen Gas Flammable.....	4	Manufacturer Requirements - Gas Equipment Venting System Provided.....	22
INTRODUCTION.....	7	Manufacturer Requirements - Gas Equipment Venting System Not Provided.....	22
Abbreviations Used.....	7	Termination Clearances Sidewall Power Vent.....	23
Qualifications.....	7	Termination Clearances Sidewall Direct Vent.....	24
Preparing For The Installation.....	7	Installation Sequence.....	25
FEATURES AND COMPONENTS.....	8	DIRECT VENT DIAGRAM.....	30
Get To Know Your Water Heater - Gas Models.....	8	Vent Pipe Preparation.....	31
INSTALLATION CONSIDERATION.....	9	Controls and Switches.....	33
Rough In Dimensions.....	9	Power Vent Wiring Schematic - Figure 34.....	34
Locating The Water Heater.....	10	TEMPERATURE REGULATION.....	36
Insulation Blankets.....	11	CONTROL SYSTEM OPERATION.....	37
Combustion Air and Ventilation.....	11	Overview.....	37
Unconfined Space.....	11	Control System Navigation.....	37
Confined Space.....	12	User Settings & Control System Menus.....	40
Fresh Air Openings For Confined Spaces.....	12	FOR YOUR INFORMATION.....	45
Outdoor Air Through Two Openings.....	12	Start Up Conditions.....	45
Outdoor Air Through One Opening.....	12	Operational Conditions.....	45
Outdoor Air Through Two Horizontal Ducts.....	13	PERIODIC MAINTENANCE.....	46
Air From Other Indoor Spaces.....	13	Venting System Inspection.....	46
Chemical Vapor Corrosion.....	14	Anode Rod Inspection.....	46
Water Piping.....	14	Temperature-Pressure Relief Valve Operation.....	46
Power Supply.....	14	Draining and Flushing.....	47
INSTALLING THE NEW WATER HEATER.....	14	Service.....	47
Mixing Valves.....	15	MAINTENANCE.....	48
Dishwashing Machines.....	15	Temperature-Pressure Relief Valve Test.....	48
Space Heating and Potable Water System.....	15	LEAKAGE CHECKPOINTS.....	49
Closed Water Systems.....	16	TROUBLESHOOTING.....	50
Thermal Expansion.....	16	Installation Checklist.....	50
Temperature-Pressure Relief Valve.....	17	Installation Checklist.....	50
Gas Piping.....	18	Sequence Of Operation Flow Chart.....	51
Supply Gas Regulator.....	18	Operational Problems.....	52
Condensate Piping.....	18	Fault and Alert Conditions.....	52
High Altitude Installations.....	19	NOTES.....	56
Filling the Water Heater.....	19	LIMITED RESIDENTIAL GAS WARRANTY.....	59
Venting.....	20		
INSTALLATION REQUIREMENTS - COMMONWEALTH OF MASSACHUSETTS.....	22		

SAFE INSTALLATION, USE AND SERVICE

The proper installation, use and servicing of this water heater is extremely important to your safety and the safety of others. Many safety-related messages and instructions have been provided in this manual and on your own water heater to warn you and others of a potential injury hazard. Read and obey all safety messages and instructions throughout this manual. It is very important that the meaning of each safety message is understood by you and others who install, use, or service this water heater.

	<p>This is the safety alert symbol. It is used to alert you to potential personal injury hazards. Obey all safety messages that follow this symbol to avoid possible injury or death.</p>
---	---

	<p>DANGER indicates an imminently hazardous situation which, if not avoided, will result in injury or death.</p>
	<p>WARNING indicates a potentially hazardous situation which, if not avoided, could result in injury or death.</p>
	<p>CAUTION indicates a potentially hazardous situation which, if not avoided, could result in minor or moderate injury.</p>
	<p>CAUTION used without the safety alert symbol indicates a potentially hazardous situation which, if not avoided, could result in property damage.</p>

All safety messages will generally tell you about the type of hazard, what can happen if you do not follow the safety message, and how to avoid the risk of injury.

The California Safe Drinking Water and Toxic Enforcement Act requires the Governor of California to publish a list of substances known to the State of California to cause cancer, birth defects, or other reproductive harm, and requires businesses to warn of potential exposure to such substances.

This product contains a chemical known to the State of California to cause cancer, birth defects, or other reproductive harm. This appliance can cause low level exposure to some of the substances listed in the Act.

APPROVALS

GAS-FIRED



LISTED



Low Lead Content

GENERAL SAFETY INFORMATION

PRECAUTIONS

DO NOT USE THIS APPLIANCE IF ANY PART HAS BEEN UNDER WATER. Immediately call a qualified service agency to inspect the appliance and to make a determination on what steps should be taken next.

If the unit is exposed to the following, do not operate heater until all corrective steps have been made by a qualified service agency.

1. External fire.
2. Damage.
3. Firing without water.

GROUNDING INSTRUCTIONS

This water heater must be grounded in accordance with the National Electrical Code and/or local codes. These must be followed in all cases. Failure to ground this water heater properly may also cause erratic control system operation.

This water heater must be connected to a grounded metal, permanent wiring system; or an equipment grounding conductor must be run with the circuit conductors and connected to the equipment grounding terminal or lead on the water heater.

HYDROGEN GAS FLAMMABLE

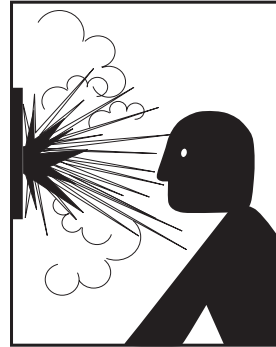

⚠️ WARNING

Explosion Hazard

- Flammable hydrogen gases may be present.
- Keep all ignition sources away from faucet when turning on hot water.

Hydrogen gas can be produced in a hot water system served by this appliance that has not been used for a long period of time (generally two weeks or more). Hydrogen gas is extremely flammable. To reduce the risk of injury under these conditions, it is recommended that a hot water faucet served by this appliance be opened for several minutes before using any electrical appliance connected to the hot water system. If hydrogen is present there will probably be an unusual sound such as air escaping through the pipe as the water begins to flow. THERE SHOULD BE NO SMOKING OR OPEN FLAME NEAR THE FAUCET AT THE TIME IT IS OPEN.

Verify the power to the water heater is turned off before performing any service procedures.



⚠️ WARNING

Read and understand this instruction manual and the safety messages herein before installing, operating or servicing this water heater.

Failure to follow these instructions and safety messages could result in death or serious injury.

This manual must remain with the water heater.

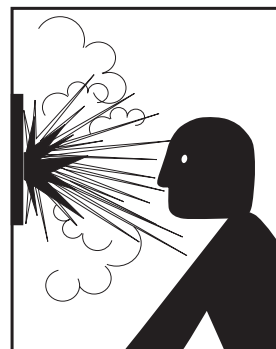

⚠️ WARNING

Explosion Hazard

- Overheated water can cause water tank explosion.
- Properly sized temperature and pressure relief valve must be installed in the opening provided.

⚠️ DANGER

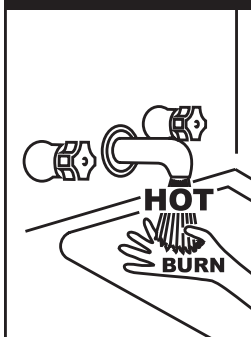

Water temperature over 125°F (52°C) can cause severe burns instantly resulting in severe injury or death.

Children, the elderly and the physically or mentally disabled are at highest risk for scald injury.

Feel water before bathing or showering.

Temperature limiting devices such as mixing valves must be installed when required by codes and to ensure safe temperatures at fixtures.

CAUTION

Improper installation, use and service may result in property damage.

- Do not operate water heater if flood damaged.
- Inspect and anode rods regularly, replace if damaged.
- Install in location with drainage.
- Fill tank with water before operation.
- Properly sized thermal expansion tanks are required on all closed water systems.

Refer to this manual for installation and service.

GENERAL SAFETY INFORMATION

⚠ **WARNING**



- Before servicing the water heater, make sure the blower assembly is unplugged or the electrical supply to the water heater is turned "OFF".
- Label all wires prior to disconnection when servicing controls. Wiring error can cause improper and dangerous operation. Verify proper operation after servicing.
- Failure to do this could result in death, serious bodily injury, or property damage.

⚠ **WARNING**

Breathing Hazard - Carbon Monoxide Gas



- Install vent system in accordance with codes.
- Do not operate water heater if flood damaged.
- Special Consideration must be taken with installations above 10,100' (3,078m) for standard models.
- Do not operate if soot buildup is present.
- Do not obstruct water heater air intake with insulating jacket.
- Do not place chemical vapor emitting products near water heater.
- Gas and carbon monoxide detectors are available.
- No vent damper installation is compatible with this power vented water heater.
- Form an approximately 8" diameter loop in the condensate hoses on top of the water heater to trap water and prevent the escape of combustion by-products.
- Do not elevate the condensate hose on the bottom of the water heater above the bracket attached to the side of the unit. This must be true for the entire length of the hose including the exit into an appropriate drain.
- Condensate lines must be free and clear of debris and must not allow back flow through the hose. The condensate lines must be able to flow freely to an appropriate drain.
- Do not allow condensate lines to become crimped closed.
- Analyze the entire vent system to make sure that condensate will not become trapped in a section of vent pipe and therefore reduce the open cross sectional area of the vent.

Breathing carbon monoxide can cause brain damage or death.
 Always read and understand instruction manual.

⚠ **DANGER**



FLAMMABLE



Flammable Vapors

⚠ Vapors from flammable liquids may explode and catch fire causing death or severe burns.

Water heater has a main burner and hot surface igniter. The hot surface igniter:

1. can come on at any time and
2. will ignite flammable vapors.

Vapors:

1. cannot be seen,
2. are heavier than air,
3. go a long way on the floor and
4. can be carried from other rooms to the hot surface igniter by air currents.

Do not use or store flammable products such as gasoline, solvents or adhesives in the same room or area near the water heater.

Keep flammable products:

1. far away from heater,
2. in approved containers,
3. tightly closed and
4. out of children's reach.

Installation:

Do not install the water heater where flammable products will be stored or used unless the main burner and hot surface igniter are at least 18" above the floor. This will reduce, but not eliminate, the risk of vapors being ignited by the main burner or hot surface igniter.

GENERAL SAFETY INFORMATION

WARNING

Fire or Explosion Hazard

- Do not store or use gasoline or other flammable vapors and liquids in the vicinity of this or any other appliance.
- Avoid all ignition sources if you smell gas.
- Do not expose water heater controls to excessive gas pressure.
- Use only the gas shown on the water heater rating plate.
- Maintain required clearances to combustibles.
- Keep ignition sources away from faucets after extended periods of non-use.



Read instruction manual before installing, using or servicing water heater.



WARNING

Breathing Hazard - Carbon Monoxide Gas

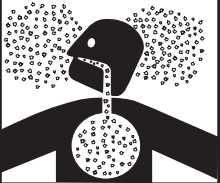

- Do not obstruct water heater air intake with insulating blanket.
- Gas and carbon monoxide detectors are available.
- Install water heater in accordance with the instruction manual.

Breathing carbon monoxide can cause brain damage or death. Always read and understand instruction manual.

CAUTION

Property Damage Hazard

- All water heaters eventually leak.
- Do not install without adequate drainage.

WARNING

Electrical Shock Hazard



- Turn off power to the water heater before performing any service.
- Label all wires prior to disconnecting when performing service. Wiring errors can cause improper and dangerous operation.
- Verify proper operation after servicing.
- Failure to follow these instructions can result in personal injury or death.

WARNING

Fire Hazard



For continued protection against risk of fire:

- Do not install water heater on carpeted floor.
- Do not operate water heater if flood damaged.

WARNING

Fire and Explosion Hazard



- Use joint compound or Teflon tape compatible with propane gas.
- Leak test before placing the water heater in operation.
- Disconnect gas piping and main gas shutoff valve before leak testing.
- Install sediment trap in accordance with NFPA 54.

WARNING

Fire and Explosion Hazard



- Do not use water heater with any gas other than the gas shown on the rating plate.
- Excessive gas pressure to gas valve can cause serious injury or death.
- Turn off gas lines during installation.
- Contact a qualified installer or service agency for installation and service.

WARNING

Jumping out control circuits or components can result in property damage, personal injury or death.

- Service should only be performed by a qualified service agent using proper test equipment.
- Altering the water heater controls and/or wiring in any way could result in permanent damage to the controls or water heater and is not covered under the limited warranty.
- Altering the water heater controls and/or wiring in any way could result in altering the ignition sequence allowing gas to flow to the main burner before the hot surface igniter is at ignition temperature causing delayed ignition which can cause a fire or explosion.



Any bypass or alteration of the water heater controls and/or wiring will result in voiding the appliance warranty.



INTRODUCTION

Thank You for purchasing this water heater. Properly installed and maintained, it should give you years of trouble free service.

ABBREVIATIONS USED

Abbreviations found in this Instruction Manual include :

- ANSI - American National Standards Institute
- ASME - American Society of Mechanical Engineers
- GAMA - Gas Appliance Manufacturer's Association
- NEC - National Electrical Code
- NFPA - National Fire Protection Association
- UL - Underwriters Laboratory
- CSA - Canadian Standards Association

QUALIFICATIONS

QUALIFIED INSTALLER OR SERVICE AGENCY

Installation and service of this water heater requires ability equivalent to that of a Qualified Agency (as defined by ANSI below) in the field involved. Installation skills such as plumbing, air supply, venting, gas supply and electrical supply are required in addition to electrical testing skills when performing service.

ANSI Z223.1 2006 Sec. 3.3.83: "Qualified Agency" - "Any individual, firm, corporation or company that either in person or through a representative is engaged in and is responsible for (a) the installation, testing or replacement of gas piping or (b) the connection, installation, testing, repair or servicing of appliances and equipment; that is experienced in such work; that is familiar with all precautions required; and that has complied with all the requirements of the authority having jurisdiction."

If you are not qualified (as defined by ANSI above) and licensed or certified as required by the authority having jurisdiction to perform a given task do not attempt to perform any of the procedures described in this manual. If you do not understand the instructions given in this manual do not attempt to perform any procedures outlined in this manual.

PREPARING FOR THE INSTALLATION

1. Read the entire manual before attempting to install or operate the water heater. Pay close attention to the General Safety Information on page 4 through 6. If you don't follow the safety rules, the water heater may not operate safely. It could cause property damage, injury and/or death.

This manual contains instructions for the installation, operation, and maintenance of the water heater. It also contains warnings throughout the manual that you must read and be aware of. All warnings and all instructions are essential to the proper operation of the water heater and your safety.

Detailed installation diagrams are also found in this manual. These diagrams will serve to provide the installer with a reference. It is essential that all venting, water piping, gas piping and wiring be installed as shown.

The principal components of the water heater are identified in Features And Components on page 8 in this manual. Use this reference to locate and identify various components on the water heater.

See the Installation Checklist and Troubleshooting on page 50. By using this checklist the user may be able to make minor operational adjustments and avoid unnecessary service calls. However, service and diagnostic procedures should only be performed by a Qualified Service Agency.

NOTE: Costs to correct installation errors are not covered under the limited warranty.

2. Be sure to turn off power when working on or near the electrical system of the water heater. Never touch electrical components with wet hands or when standing in water.
3. The installation must conform to all instructions contained in this manual and the local code authority having jurisdiction. These shall be carefully followed in all cases. Authorities having jurisdiction should be consulted before installation begins if there are any questions regarding compliance with local, state or national codes.

In the absence of local codes, the installation must comply with the current editions of the National Fuel Gas Code, ANSI Z223.1/NFPA 54 and the National Electrical Code, NFPA 70. All documents are available from National Fire Protection Association, 1 Batterymarch Park, Quincy, MA 02269.

4. If after reading this manual you have any questions or do not understand any portion of the instructions, call the toll free number on the back cover of this manual for technical assistance. In order to expedite your request, please have the full Model, Serial and Series number of the water heater you are working with available for the technician. This information is located on the water heater's rating plate.
5. Carefully plan the placement of the water heater. Examine the location to ensure that it complies with the requirements in Locating The Water Heater on page 10 and the Rough In Dimensions on page 9.
6. For installation in California this water heater must be braced or anchored to avoid falling or moving during an earthquake. See instructions for correct installation procedures. Instructions may be obtained from California Office of the State Architect, 1102 Q Street, Suite 5100, Sacramento, CA 95811.
7. Massachusetts Code requires this water heater to be installed in accordance with Massachusetts 248-CMR 2.00: State Plumbing Code and 248-CMR 5. See Commonwealth of Massachusetts on page 22.

FEATURES AND COMPONENTS

GET TO KNOW YOUR WATER HEATER - GAS MODELS

A	Control Assembly	M	Display Enclosure	Z	Temperature and Pressure Relief Valve
B	Blocked Inlet Switch	**N	Exhaust Elbow Assembly	AA	Rating Plate
C	Blocked Outlet Switch	**O	Condensate Tubing	BB	Labels
D	Blower Prover Switch	P	Off/On Switch	CC	Drain Valve
E	Blower Assembly	Q	Display Label	**DD	Vent Terminal
F	Burner Assembly	R	Hot Water Outlet	EE	Drain Pan
G	Flame Sensor	T	Gas Supply	FF	Anode
H	Hot Surface Igniter	U	Main Manual Gas Shutoff Valve	GG	Insulation
I	Junction Box	V	Union	HH	Upper Temperature Probe
J	Gas Control Valve Assembly	W	Inlet Water Shutoff Valve	II	Access Door
K	Display Board	X	Cold Water Inlet		
L	Top Plastic Enclosure	Y	Inlet Dip Tube		

REPLACEMENT PARTS AND DELIMITING PRODUCTS

Replacement parts and recommended delimer may be ordered through authorized servicers or distributors. When ordering parts, provide complete model and serial numbers (see rating plate), quantity and name of part desired. Standard hardware items may be purchased locally.

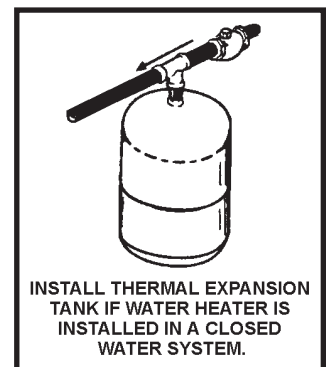
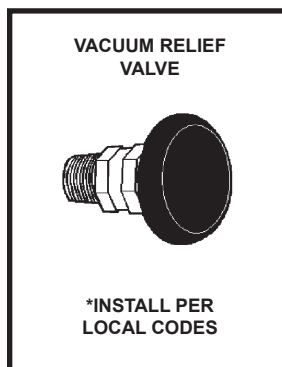
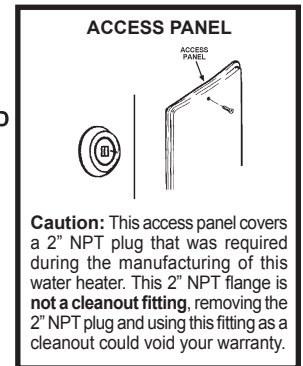
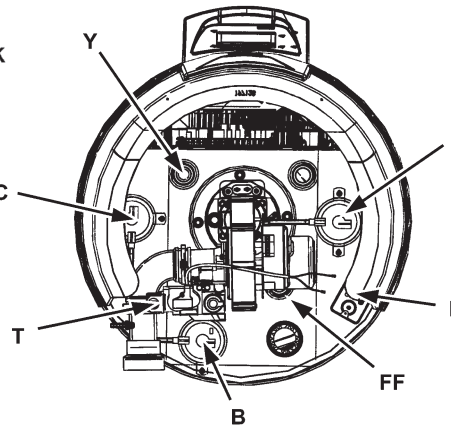
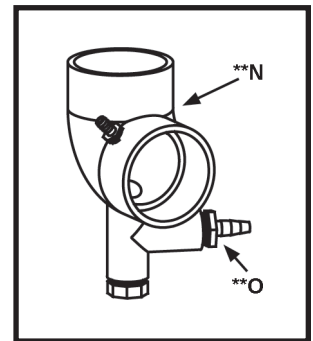
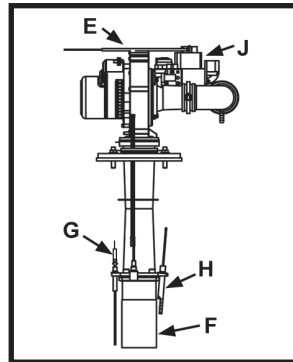
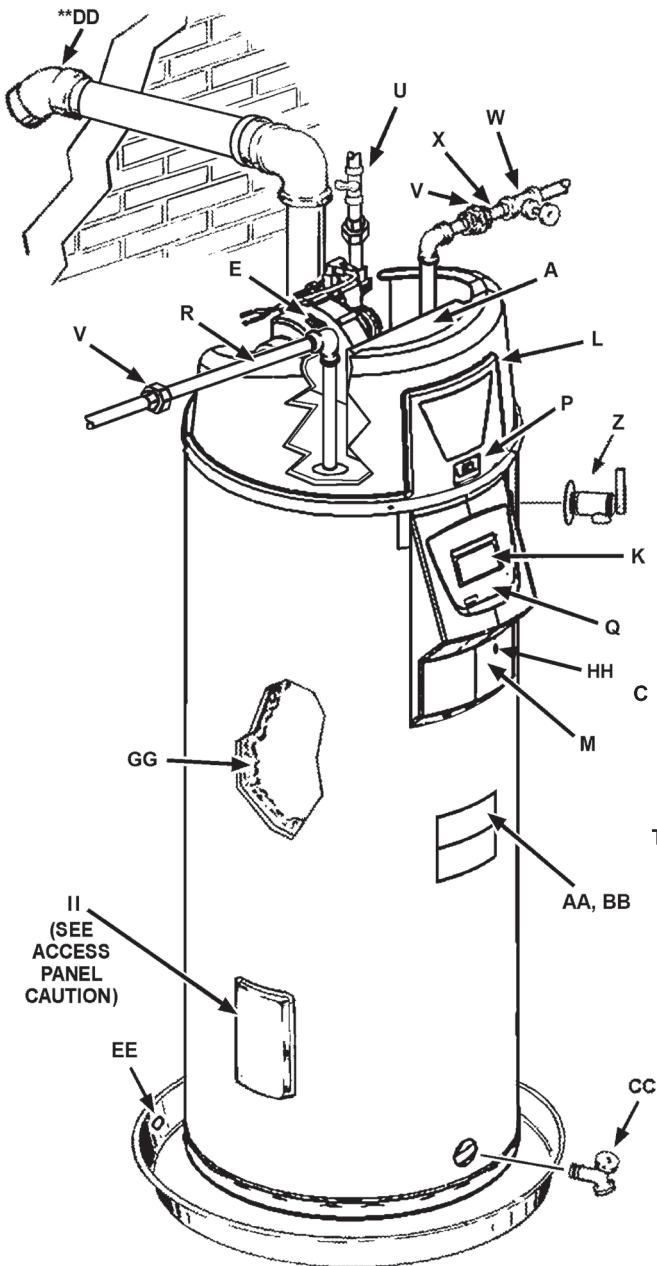

* CAUTION HARNESS HAS 120 VAC. IN OPERATION.

** See "Planning the Vent System," "Installation of Vent System" and "Condensate Piping" for more information.

FIGURE 1.

INSTALLATION CONSIDERATION

ROUGH IN DIMENSIONS

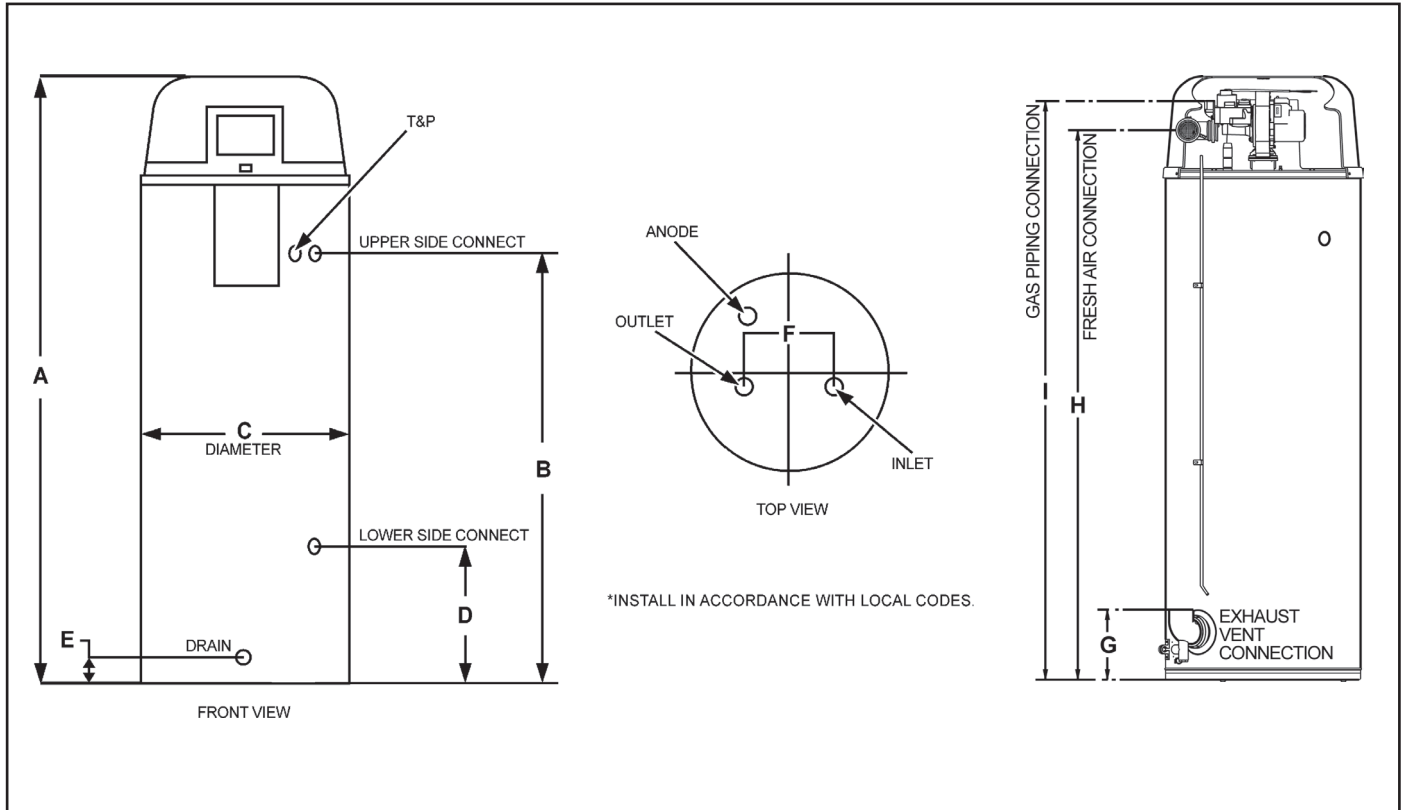

FIGURE 1A.

TABLE 1 – Rough-In-Dimensions

Units	A	B	C	D	E	F	G	H	I
Inches	66.75	49.25	22.00	15.75	3.00	8.00	8.00	62.00	65.00
cm	169.5	125.09	55.88	40.00	7.62	20.32	20.32	157.48	165.1

Top/Side Inlet and Outlet: 3/4" NPT

Gas Inlet: 1/2" NPT

TABLE 2 – Capacity, Gas and Electrical Characteristics

Approximate Capacity		Manifold Pressure			Electrical Characteristics	
U.S. Gals.	Liters	Gas Type	"WC	kPA	Volts/Hz	Amperes
50	189	Nat./LP	0"	0"	120/60	<5

All models - Maximum Supply Pressure: 14 inches W.C. (3.48kPa)

Minimum Supply Pressure for Natural Gas: 3.50" (.87kPa)

Minimum Supply Pressure for Propane Gas: 8.00" (1.99kPa)

Minimum pressure must be maintained under both load and no load (dynamic and static) conditions.

TABLE 3 – Recovery Capacities - U.S. Gallons/Hr. and Liters/Hr. at Temperature Rise Indicated

Input		Recovery Capacities													
Rating (Btu/hr)	Rating (kW)	Temp. Rise	F	30	40	50	60	70	80	90	100	110	120	130	140
			C	17	22	28	33	39	44	50	56	61	67	72	78
100,000	29.3	GPH	387	291	233	194	166	145	129	116	106	97	90	83	
		LPH	1465	1102	882	734	628	549	488	439	401	367	341	314	

Recovery capacity based on 96% thermal efficiency

LOCATING THE WATER HEATER

Carefully choose a location for the new water heater. The placement is a very important consideration for the safety of the occupants in the building and for the most economical use of the appliance.

CAUTION

Property Damage Hazard

- All water heaters eventually leak.
- Do not install without adequate drainage.

Whether replacing an existing water heater or installing the water heater in a new location observe the following critical points:

1. The water heater must be located indoors.
2. The water heater must not be located in an area where it will be subject to freezing temperatures.
3. Locate the water heater so it is protected and not subject to physical damage by a moving vehicle.
4. Locate the water heater on a level surface.
5. Locate the water heater near a floor drain. The water heater should be located in an area where leakage of the tank or connections will not result in damage to the area adjacent to the water heater or to lower floors of the structure. When such locations cannot be avoided, it is recommended that a metal drain pan, adequately drained, be installed under the appliance.
6. Locate the water heater close to the point of major hot water usage.
7. Locate the water heater close to a 120 VAC power supply. See Power Supply on page 14 for requirements.
8. Locate the water heater where an adequate supply of fresh air for combustion and ventilation can be obtained. See Combustion Air and Ventilation on page 11.
9. Locate the water heater where the vent and intake air piping, when installed, will remain within the maximum equivalent lengths allowed. See Venting on page 20.
10. Do not locate the water heater where noise (such as the Combustion Blower) during normal operation will be objectionable in adjacent areas.
11. Do not locate the water heater where the subsequent installation of the vent (exhaust) or intake air terminations would be objectionable due to noise at the termination(s). This includes locations close to or across from windows and doors. See Venting starting on page 20.

INSTALLATIONS IN AREAS WHERE FLAMMABLE LIQUIDS (VAPORS) ARE LIKELY TO BE PRESENT OR STORED (GARAGES, STORAGE AND UTILITY AREAS, ETC.): Flammable liquids (such as gasoline, solvents, propane (LP or butane, etc.) and other substances (such as adhesives, etc.) emit flammable vapors which can be ignited by a gas water heater's hot surface igniter or main burner. The resulting flashback and fire can cause death or serious burns to anyone in the area.

⚠ WARNING

Fire or Explosion Hazard

- Do not store or use gasoline or other flammable vapors and liquids in the vicinity of this or any other appliance.
- Avoid all ignition sources if you smell LP gas.
- Do not expose water heater control to excessive gas pressure.
- Use only gas shown on rating plate.
- Maintain required clearances to combustibles.
- Keep ignition sources away from faucets after extended period of non-use.

Read instruction manual before installing, using or servicing water heater.

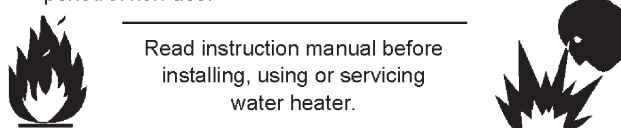

⚠ DANGER



⚠ Vapors from flammable liquids may explode and catch fire causing death or severe burns.

Water heater has a main burner and hot surface igniter. The hot surface igniter:

1. can come on at any time and
2. will ignite flammable vapors.

Do not use or store flammable products such as gasoline, solvents or adhesives in the same room or area near the water heater.

Keep flammable products:

1. far away from heater,
2. in approved containers,
3. tightly closed and
4. out of children's reach.

Vapors:

1. cannot be seen,
2. are heavier than air,
3. go a long way on the floor and
4. can be carried from other rooms to the hot surface igniter by air currents.

Installation:
Do not install the water heater where flammable products will be stored or used unless the main burner and hot surface igniter are at least 18" above the floor. This will reduce, but not eliminate, the risk of vapors being ignited by the main burner or hot surface igniter.

⚠ WARNING

Fire Hazard

For continued protection against risk of fire:

- Do not install water heater on carpeted floor.
- Do not operate water heater if flood damaged.



This water heater must not be installed directly on carpeting. Carpeting must be protected by metal or wood panel beneath the appliance extending beyond the full width and depth of the appliance by at least 3" (7.6 cm) in any direction, or if the appliance is installed

in an alcove or closet, the entire floor must be covered by the panel. Failure to heed this warning may result in a fire hazard.



Minimum clearances between the water heater and combustible construction are 0 inch at the sides and rear, 5.5" (14.0 cm) from the front and 18" (45.7 cm) from the top. (Standard clearance.) If clearances stated on the heater differ from standard clearances, install water heater according to clearances stated on the heater.

Adequate clearance 30" (76 cm) for servicing this appliance should be considered before installation, such as changing the anodes, control system components and gas control assembly.

A minimum clearance of 5.5" (14.0 cm) must be allowed for access to replaceable and/or serviceable parts such as the thermostats, drain valve, condensate drain, relief valve, clean out opening, and the vent connection (exhaust elbow).

When installing the heater, consideration must be given to proper location. Location selected should be as close to the wall as practicable and as centralized with the water piping system as possible.

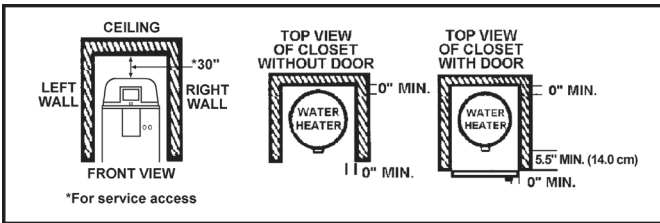
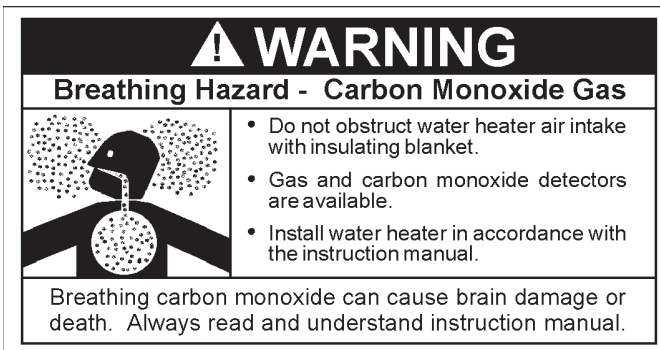

FIGURE 2.

INSULATION BLANKETS

Insulation blankets are available to the general public for external use on gas water heaters but are not necessary with these products. The purpose of an insulation blanket is to reduce the standby heat loss encountered with storage tank heaters. Your water heater meets or exceeds the Energy Policy Act standards with respect to insulation and standby loss requirements, making an insulation blanket unnecessary.

Should you choose to apply an insulation blanket to this heater, you should follow these instructions (For identification of components mentioned below, see Figure 1). Failure to follow these instructions can restrict the air flow required for proper combustion, potentially resulting in fire, asphyxiation, serious personal injury or death.



- Do not apply insulation to the top of the water heater, as this will interfere with safe operation of the blower assembly.
- Do not cover the outer door, thermostat or temperature & pressure relief valve.
- Do not cover the instruction manual. Keep it on the side of the water heater or nearby for future reference.
- Do obtain new warning and instruction labels from the manufacturer for placement on the blanket directly over the existing labels.

COMBUSTION AIR AND VENTILATION

A gas water heater cannot operate properly without the correct amount of air for combustion. Do not install in a confined area such as a closet, unless you provide air as shown in the "Facts to Consider About Location" section. Never obstruct the flow of ventilation air. If you have any doubts or questions at all, call your gas supplier. Failure to provide the proper amount of combustion air can result in a fire or explosion and cause death, serious bodily injury, or property damage.

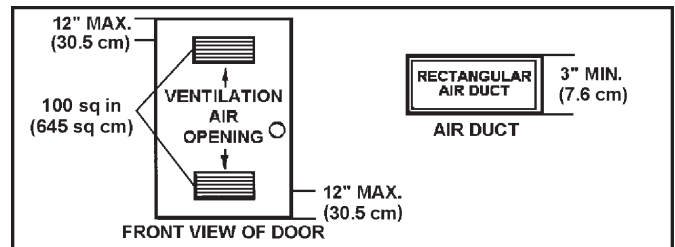
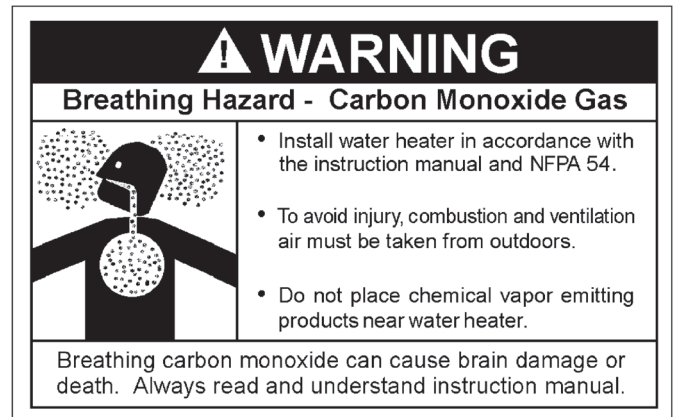

FIGURE 3.

If this water heater will be used in beauty shops, barber shops, cleaning establishments, or self-service laundries with dry cleaning equipment, it is imperative that the water heater(s) be installed direct vent so that all air for combustion and ventilation is taken from outdoors.

Propellants of aerosol sprays and volatile compounds, (cleaners, chlorine based chemicals, refrigerants, etc.) in addition to being highly flammable in many cases, will also react to form corrosive hydrochloric acid when exposed to the combustion products of the water heater. The results can be hazardous, and also cause product failure.

UNCONFINED SPACE

An Unconfined Space is one whose volume IS NOT LESS THAN 50 cubic feet per 1,000 Btu/hr (4.8 cubic meters per kW) of the total input rating of all appliances installed in the space. Rooms communicating directly with the space, in which the appliances are installed, through openings not furnished with doors, are considered a part of the unconfined space.

Makeup air requirements for the operation of exhaust fans, kitchen

ventilation systems, clothes dryers and fireplaces shall also be considered in determining the adequacy of a space to provide combustion, ventilation and dilution air.

UNUSUALLY TIGHT CONSTRUCTION

In unconfined spaces in buildings, infiltration may be adequate to provide air for combustion, ventilation and dilution of flue gases. However, in buildings of unusually tight construction (for example, weather stripping, heavily insulated, caulked, vapor barrier, etc.) additional air must be provided using the methods described in the Confined Space section that follows.

CONFINED SPACE

A Confined Space is one whose volume IS LESS THAN 50 cubic feet per 1,000 Btu/hr (4.8 cm per kW) of the total input rating of all appliances installed in the space.

Openings must be installed to provide fresh air for combustion, ventilation and dilution in confined spaces. The required size for the openings is dependent on the method used to provide fresh air to the confined space AND the total Btu/hr input rating of all appliances installed in the space.

DIRECT VENT APPLIANCES

Appliances installed in a Direct Vent configuration that derive all air for combustion from the outdoor atmosphere through sealed intake air piping are not factored in the total appliance input Btu/hr calculations used to determine the size of openings providing fresh air into confined spaces.

EXHAUST FANS

Where exhaust fans are installed, additional air shall be provided to replace the exhausted air. When an exhaust fan is installed in the same space with a water heater, sufficient openings to provide fresh air must be provided that accommodate the requirements for all appliances in the room and the exhaust fan. Undersized openings will cause air to be drawn into the room through the water heater's vent system causing poor combustion. Sooting, serious damage to the water heater and the risk of fire or explosion may result. It can also create a risk of asphyxiation.

LOUVERS AND GRILLES

The free areas of the fresh air openings in the instructions that follow do not take in to account the presence of louvers, grilles or screens in the openings.

The required size of openings for combustion, ventilation and dilution air shall be based on the "net free area" of each opening. Where the free area through a design of louver or grille or screen is known, it shall be used in calculating the size of opening required to provide the free area specified. Where the louver and grille design and free area are not known, it shall be assumed that wood louvers will have 25% free area and metal louvers and grilles will have 75% free area. Non motorized louvers and grilles shall be fixed in the open position.

FRESH AIR OPENINGS FOR CONFINED SPACES

The following instructions shall be used to calculate the size, number and placement of openings providing fresh air for combustion, ventilation and dilution in confined spaces. The illustrations shown in this section of the manual are a reference for the openings that provide fresh air into confined spaces only. **DO NOT** refer to these illustrations for the purpose of vent installation. See Venting Installation on page 20 for complete venting installation instructions.

OUTDOOR AIR THROUGH TWO OPENINGS

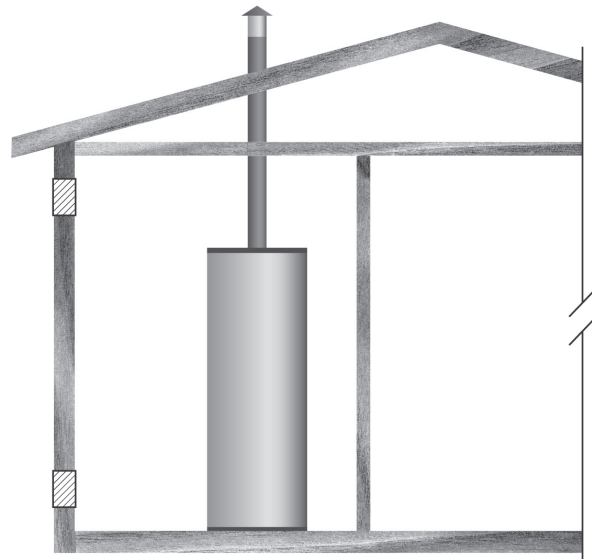

FIGURE 4.

The confined space shall be provided with two permanent openings, one commencing within 12 inches (300 mm) of the top and one commencing within 12 inches (300 mm) of the bottom of the enclosure. The openings shall communicate directly with the outdoors. See Figure 4.

Each opening shall have a minimum free area of 1 square inch per 4,000 Btu/hr (550 mm² per kW) of the aggregate input rating of all appliances installed in the enclosure. Each opening shall not be less than 100 square inches (645 cm²).

OUTDOOR AIR THROUGH ONE OPENING

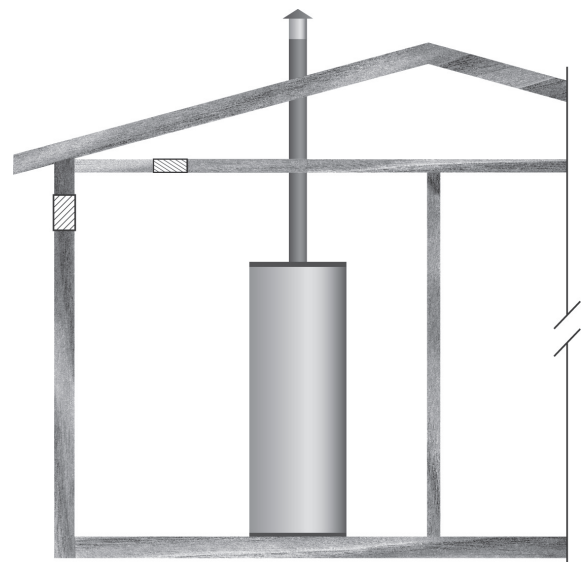

FIGURE 5.

Alternatively a single permanent opening, commencing within 12 inches (300 mm) of the top of the enclosure, shall be provided. See Figure 5. The water heater shall have clearances of at least 1 inch (25 mm) from the sides and back and 6 inches (150 mm) from the front of the appliance. The opening shall directly communicate with the outdoors or shall communicate through a vertical or horizontal duct to the outdoors or spaces that freely communicate with the outdoors and shall have a minimum free area of the following:

- 1 square inch per 3000 Btu/hr (700 mm² per kW) of the total input rating of all appliances located in the enclosure, and
- Not less than the sum of the areas of all vent connectors in the space.

OUTDOOR AIR THROUGH TWO HORIZONTAL DUCTS

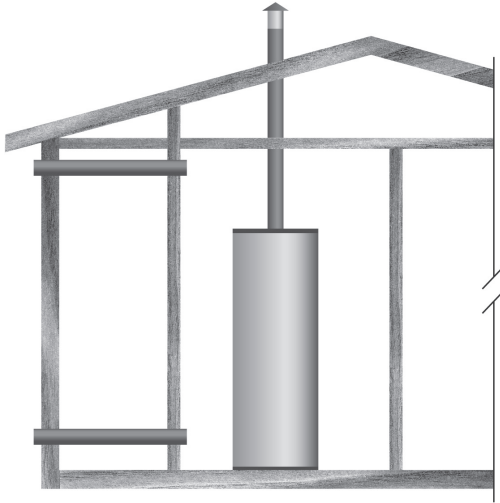

FIGURE 6.

The confined space shall be provided with two permanent horizontal ducts, one commencing within 12 inches (300 mm) of the top and one commencing within 12 inches (300 mm) of the bottom of the enclosure. The horizontal ducts shall communicate directly with the outdoors. See Figure 6.

Each duct opening shall have a minimum free area of 1 square inch per 2,000 Btu/hr (1100 mm² per kW) of the aggregate input rating of all appliances installed in the enclosure.

When ducts are used, they shall be of the same cross sectional area as the free area of the openings to which they connect. The minimum dimension of rectangular air ducts shall be not less than 3 inches.

AIR FROM OTHER INDOOR SPACES

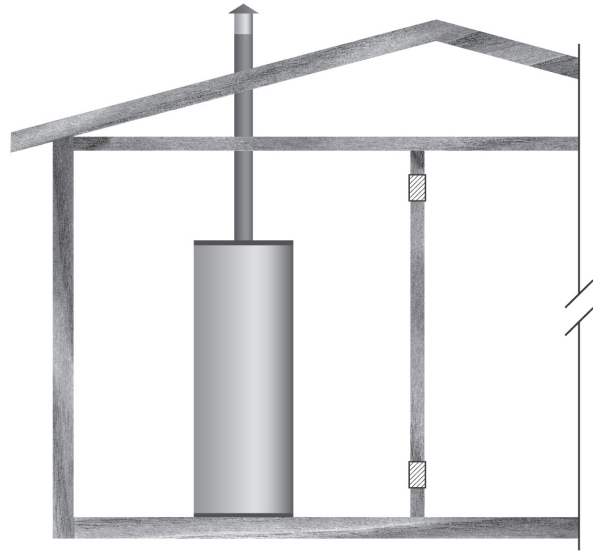

FIGURE 7.

The confined space shall be provided with two permanent openings, one commencing within 12 inches (300 mm) of the top and one commencing within 12 inches (300 mm) of the bottom of the enclosure. See Figure 7.

Each opening shall communicate directly with an additional room(s) of sufficient volume so that the combined volume of all spaces meets the criteria for an Unconfined Space.

Each opening shall have a minimum free area of 1 square inch per 1,000 Btu/hr (1100 mm² per kW) of the aggregate input rating of all appliances installed in the enclosure. Each opening shall not be less than 100 square inches (645 cm²).

INSTALLING THE NEW WATER HEATER

CHEMICAL VAPOR CORROSION

CORROSION OF THE FLUEWAYS AND VENT SYSTEM MAY OCCUR IF AIR FOR COMBUSTION CONTAINS CERTAIN CHEMICAL VAPORS. SUCH CORROSION MAY RESULT IN FAILURE AND RISK OF ASPHYXIATION.

Spray can propellants, cleaning solvents, refrigerator and air conditioning refrigerants, swimming pool chemicals, calcium and sodium chloride (water softener salt), waxes, and process chemicals are typical compounds which are potentially corrosive.

Do not store products of this sort near the heater. Also, air which is brought in contact with the heater should not contain any of these chemicals. If necessary, uncontaminated air should be obtained from remote or outside sources. The limited warranty is voided when failure of water heater is due to a corrosive atmosphere. (See limited warranty for complete terms and conditions).

WATER PIPING

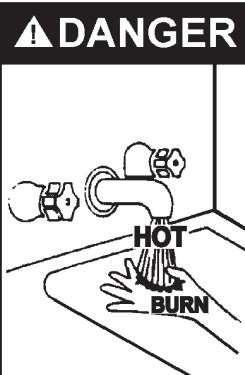

⚠ DANGER Water temperature over 125°F (52°C) can cause severe burns instantly resulting in severe injury or death.

Children, the elderly, and the physically or mentally disabled are at highest risk for scald injury.

Feel water before bathing or showering.

Temperature limiting valves are available.

Read instruction manual for safe temperature setting.

HOTTER WATER CAN SCALD:

Water heaters are intended to produce hot water. Water heated to a temperature which will satisfy space heating, clothes washing, dish washing, cleaning and other sanitizing needs can scald and permanently injure you upon contact. Some people are more likely to be permanently injured by hot water than others. These include the elderly, children, the physically or developmentally disabled. If anyone using hot water fits into one of these groups or if there is a local code or state law requiring a certain temperature water at the hot water tap, then you must take special precautions. In addition to using the lowest possible temperature setting that satisfies your hot water needs, a means such as a mixing valve should be used at the hot water taps used by these people or at the water heater, see Figure 8. Valves for reducing point of use temperature by mixing cold and hot water are also available:

Consult a Qualified Installer or Service Agency. Follow manufacturer's instructions for installation of the valves. Before changing the factory setting on the thermostat, read the "Temperature Regulation" section in this manual.

⚠ WARNING

Toxic Chemical Hazard

- Do not connect to non-potable water system.

This water heater shall not be connected to any heating systems or component(s) used with a non-potable water heating appliance.

All piping components connected to this unit for space heating applications shall be suitable for use with potable water.

Toxic chemicals, such as those used for boiler treatment shall not be introduced into this system.

When the system requires water for space heating at temperatures higher than required for domestic water purposes, a mixing valve must be installed. Please refer to Figure 8 for suggested piping arrangement.

POWER SUPPLY

The water heaters covered in this manual require a 120 VAC, 1Ø (single phase), 60Hz, 15 amp power supply and must also be electrically grounded in accordance with local codes or, in the absence of local codes, with the National Electrical Code, ANSI/NFPA 70.

POWER FLUCTUATIONS AND ELECTRICAL NOISE

The water heater's control system requires a source of stable clean electricity for proper operation. Connecting the water heater to a branch circuit that is subject to fluctuations in voltage level or electrical line noise such as EMI (electro magnetic interference) or RFI (radio frequency interference) may cause erratic control system operation and malfunction.

A high quality power supply filter/suppressor such as the Kleen Line model SELF/T-10 Series SC-L or equivalent must be installed if the above conditions exist. Call the technical support phone number listed on the back cover of this manual for more information.

NOTE: Malfunctions caused by the power supply and the costs to install power supply filters are not covered under the limited warranty.

DEDICATED POWER WIRING AND BREAKERS

Dedicated power supply wires, ground wiring and dedicated circuit breakers often prevent electrical line noise and should be considered when installing the water heater.

POLARITY SENSITIVE

The control system on the water heaters covered in this manual is polarity sensitive; electronic flame sensing requires correct polarity. The control system is programmed to monitor the incoming power supply. If the Hot and Neutral wires in the 120 VAC power supply are reversed, the control system will declare a Fault condition and lock out, heating operation will be disabled until the power supply is correctly wired. The control system will display the "AC Reversed" Fault message on the LCD.

MIXING VALVES

⚠ DANGER

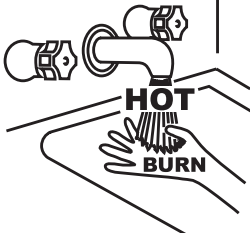

Water temperature over 125°F (52°C) can cause severe burns instantly resulting in severe injury or death.

Children, the elderly and the physically or mentally disabled are at highest risk for scald injury.

Feel water before bathing or showering.

Temperature limiting devices such as mixing valves must be installed when required by codes and to ensure safe temperatures at fixtures.

Water heated to a temperature which will satisfy clothes washing, dish washing, and other sanitizing needs can scald and cause permanent injury upon contact. Short repeated heating cycles caused by small hot water uses can cause temperatures at the point of use to exceed the water heater's temperature setting by up to 20°F (11°C).

Some people are more likely to be permanently injured by hot water than others. These include the elderly, children, the infirm and the physically/mentally disabled. Table 4 shows the approximate time-to-burn relationship for normal adult skin. If anyone using hot water provided by the water heater being installed fits into one of these groups or if there is a local code or state law requiring a certain water temperature at the point of use, then special precautions must be taken.

In addition to using the lowest possible temperature setting that satisfies the demand of the application a Mixing Valve should be installed at the water heater (see Figure 8) or at the hot water taps to further reduce system water temperature.

Mixing valves are available at plumbing supply stores. Consult a Qualified Installer or Service Agency. Follow mixing valve manufacturer's instructions for installation of the valves.

Table 4

Water Temperature	Time to Produce 2nd & 3rd Degree Burns on Adult Skin
160°F (71°C)	About 1/2 second
150°F (66°C)	About 1-1/2 seconds
140°F (60°C)	Less than 5 seconds
130°F (54°C)	About 30 seconds
120°F (49°C)	More than 5 minutes

DISHWASHING MACHINES

All dishwashing machines meeting the National Sanitation Foundation requirements are designed to operate with water flow pressures between 15 and 25 pounds per square inch (103 kPa and 173 kPa). Flow pressures above 25 pounds per square inch (173 kPa), or below 15 pounds per square inch (103 kPa), will result in improperly sanitized dishes. Where pressures are high, a water

pressure reducing or flow regulating control valve should be used in the line to the dishwashing machine and should be adjusted to deliver water pressure between these limits.

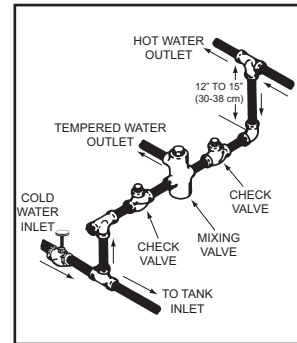

FIGURE 8.

SPACE HEATING AND POTABLE WATER SYSTEM

Your water heater is equipped with inlet/outlet connections for use in space heating applications (see Figure 9). If this water heater is to be used to supply both space heating and potable (drinking) water, the instructions listed below must be followed:

- Be sure to follow the manual(s) shipped with the air handler or other type heating system.
- This water heater cannot be used in space heating applications only.
- This water heater is not to be used as a replacement for an existing boiler installation.
- Do not use with piping that has been treated with chromates, boiler seal or other chemicals and do not add any chemicals to the water heater piping
- If the space heating system requires water temperatures in excess of 120°F, a mixing valve must be installed per the manufacturer's instructions in the potable hot water supply to limit the risk of scald injury.
- Pumps, valves, piping and fittings must be compatible with potable water.
- A properly installed flow control valve is required to prevent thermosiphoning. Thermosiphoning is the result of a continuous flow of water through the air handler circuit during the off cycle. Weeping (blow off) of the temperature and pressure relief valve (T & P) or higher than normal water temperatures are the first signs of thermosiphoning.
- The hot water line from the water heater should be vertical past any mixing valve or supply line to the heating system to remove air bubbles from the system.
- Do not connect the water heater to any system or components previously used with non-potable water heating appliances when used to supply potable water.

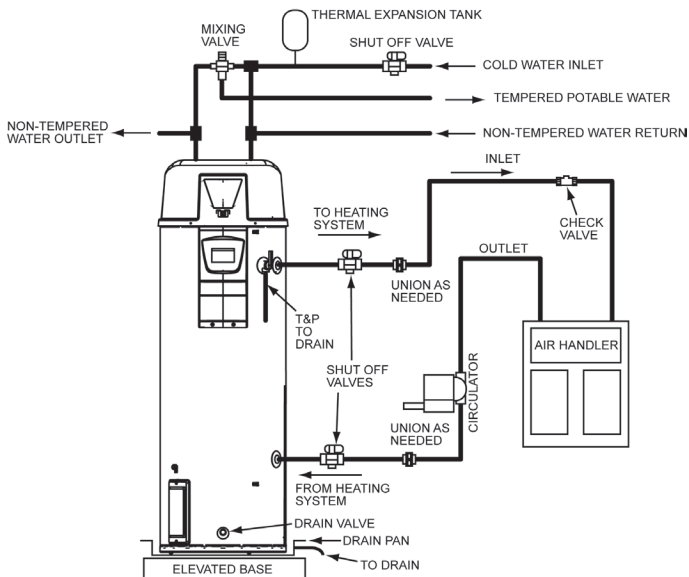

FIGURE 9.

CLOSED WATER SYSTEMS

Water supply systems may, because of code requirements or such conditions as high line pressure, among others, have installed devices such as pressure reducing valves, check valves, and back flow preventers. Devices such as these cause the water system to be a closed system.

THERMAL EXPANSION

As water is heated, it expands (thermal expansion). In a closed system the volume of water will grow when it is heated. As the volume of water grows there will be a corresponding increase in water pressure due to thermal expansion. Thermal expansion can cause premature tank failure (leakage). This type of failure is not covered under the limited warranty. Thermal expansion can also cause intermittent temperature-pressure relief valve operation: water discharged from the valve due to excessive pressure build up. This condition is not covered under the limited warranty. The temperature-pressure relief valve is not intended for the constant relief of thermal expansion.

A properly sized thermal expansion tank should be installed on all closed systems to control the harmful effects of thermal expansion.

<h1>CAUTION</h1> <h2>Property Damage Hazard</h2>
<ul style="list-style-type: none"> • Avoid water heater damage. • Install thermal expansion tank if necessary. • Do not apply heat to cold water inlet. • Contact qualified installer or service agency.

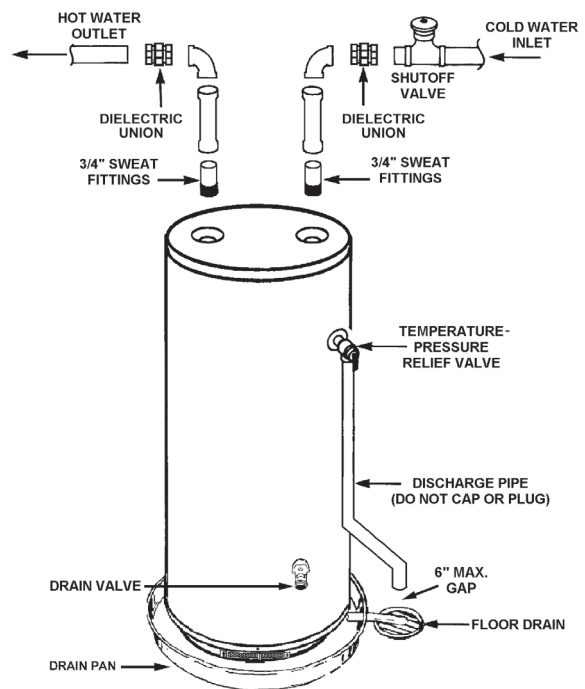

FIGURE 10.

NOTE: To protect against untimely corrosion of hot and cold water fittings, it is strongly recommended that di-electric unions or couplings be installed on this water heater when connected to copper pipe, see Figure 10 also.

Figures 9 and 10 show the typical attachment of the water piping to the water heater. The water heater is equipped with 3/4 inch NPT water connections.

NOTE: If using copper tubing, solder tubing to an adapter before attaching the adapter to the water heater connections. Do not solder the water lines directly to the water heater connections. It will harm the dip tube and damage the tank.

T & P Valve and Pipe Insulation (if supplied)

Remove insulation for T & P valve and pipe connections from carton.

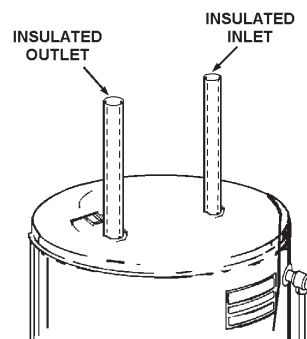
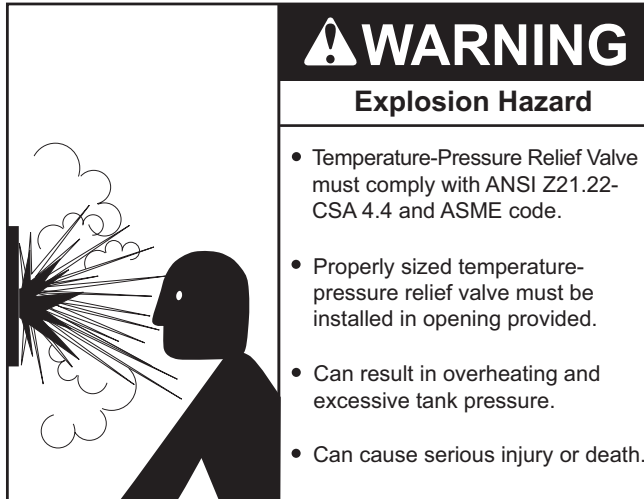

FIGURE 11.

Fit pipe insulation over the incoming cold water line and the hot water line. Make sure that the insulation is against the top cover of the heater. Fit T & P valve insulation over valve. Make sure that the insulation does not interfere with the lever of the T & P valve.

Secure all insulation using tape.

TEMPERATURE-PRESSURE RELIEF VALVE



This water heater is provided with a properly rated/sized and certified combination Temperature-Pressure Relief Valve (T&P valve) by the manufacturer. The valve is certified by a nationally recognized testing laboratory that maintains periodic inspection of production of listed equipment of materials as meeting the requirements for Relief Valves for Hot Water Supply Systems, ANSI Z21.22 • CSA 4.4, and the code requirements of ASME.

If replaced, the new T&P valve must meet the requirements of local codes, but not less than a combination Temperature-Pressure Relief Valve rated/sized and certified as indicated in the above paragraph. The new valve must be marked with a maximum set pressure not to exceed the marked hydrostatic working pressure of the water heater (150 psi = 1,035 kPa) and a discharge capacity not less than the water heater Btu/hr or kW input rate as shown on the water heater's model rating plate.

NOTE: In addition to the factory installed Temperature-Pressure Relief Valve on the water heater, each remote storage tank that may be installed and piped to a water heating appliance must also have its own properly sized, rated and approved Temperature-Pressure Relief Valve installed. Call the toll free technical support phone number listed on the back cover of this manual for technical assistance in sizing a Temperature-Pressure Relief Valve for remote storage tanks.

For safe operation of the water heater, the Temperature-Pressure Relief Valve must not be removed from its designated opening nor plugged. The Temperature-Pressure Relief Valve must be installed directly into the fitting of the water heater designed for the relief valve. Install discharge piping so that any discharge will exit the pipe within 6 inches (15.2 cm) above an adequate floor drain, or external to the building. In cold climates it is recommended that it be terminated at an adequate drain inside the building. Be certain that no contact is made with any live electrical part. The discharge opening must not be blocked or reduced in size under any circumstances. Excessive length, over 30 feet (9.14 m), or use of more than four elbows can cause restriction and reduce the discharge capacity of the valve.

No valve or other obstruction is to be placed between the Temperature-Pressure Relief Valve and the tank. Do not connect discharge piping directly to the drain unless a 6" (15.2 cm) air gap is provided. To prevent bodily injury, hazard to life, or property damage, the relief valve must be allowed to discharge water in adequate quantities should circumstances demand. If the discharge pipe is not connected to a drain or other suitable means, the water flow may cause property damage.

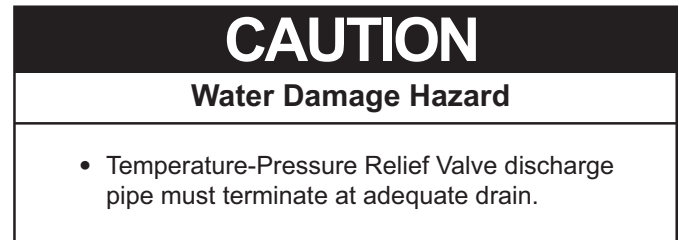

T&P VALVE DISCHARGE PIPE REQUIREMENTS:

- Shall not be smaller in size than the outlet pipe size of the valve, or have any reducing couplings or other restrictions.
- Shall not be plugged or blocked.
- Shall not be exposed to freezing temperatures.
- Shall be of material listed for hot water distribution.
- Shall be installed so as to allow complete drainage of both the Temperature-Pressure Relief Valve and the discharge pipe.
- Must terminate a maximum of six inches above a floor drain or external to the building. In cold climates, it is recommended that the discharge pipe be terminated at an adequate drain inside the building.
- Shall not have any valve or other obstruction between the relief valve and the drain.

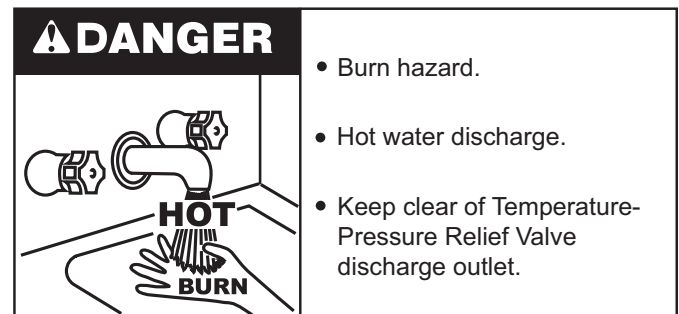

The Temperature-Pressure Relief Valve must be manually operated at least twice a year. Caution should be taken to ensure that (1) no one is in front of or around the outlet of the Temperature-Pressure Relief Valve discharge line, and (2) the water manually discharged will not cause any bodily injury or property damage because the water may be extremely hot. If after manually operating the valve, it fails to completely reset and continues to release water, immediately close the cold water inlet to the water heater, follow the draining instructions in this manual, and replace the Temperature-Pressure Relief Valve with a properly rated/sized new one.

NOTE: The purpose of a Temperature-Pressure Relief Valve is to prevent excessive temperatures and pressures in the storage tank. The T&P valve is not intended for the constant relief of thermal expansion. A properly sized thermal expansion tank must be installed on all closed systems to control thermal expansion, see Closed Water Systems and Thermal Expansion on pages 15 and 16.

If you do not understand these instructions or have any questions regarding the Temperature-Pressure Relief Valve call the toll free number listed on the back cover of this manual for technical assistance.

GAS PIPING

	⚠ WARNING
	Fire and Explosion Hazard <ul style="list-style-type: none">• Do not use water heater with any gas other than the gas shown on the rating plate.• Excessive pressure to gas control valve can cause serious injury or death.• Turn off gas lines during installation.• Contact qualified installer or service agency.

Make sure gas supplied is same type listed on model rating plate. The inlet gas pressure must not exceed 14 inch water column (3.5 kPa) for natural and propane gas (L.P.). The minimum inlet gas pressure shown on rating plate is that which will permit firing at rated input.

SEDIMENT TRAPS

	⚠ WARNING
	Fire and Explosion Hazard <ul style="list-style-type: none">• Contaminants in gas lines can cause fire or explosion.• Clean all gas piping before installation.• Install drip leg in accordance with NFPA54.

A sediment trap shall be installed as close to the gas inlet of the water heater as practical at the time of water heater installation. The sediment trap shall be either a tee fitting with a capped nipple in the bottom outlet or other device recognized as an effective sediment trap.

Contaminants in the gas lines may cause improper operation of the gas control valve that may result in fire or explosion. Before attaching the gas line be sure that all gas pipe is clean on the inside. To trap any dirt or foreign material in the gas supply line, a drip leg (sometimes called a sediment trap) must be incorporated in the piping. The drip leg must be readily accessible. Install in accordance with the "Gas Piping" section. Refer to the current edition of the National Fuel Gas Code (ANSI Z223.1/NFPA 54).

	⚠ WARNING
	Fire and Explosion Hazard <ul style="list-style-type: none">• Use joint compound or tape compatible with propane.• Leak test before operating heater.• Disconnect gas piping and shut-off valve before pressure testing system.

Use pipe joint compound or teflon tape marked as being resistant to the action of petroleum [Propane (L.P.)] gases.

The water heater and its gas connection must be leak tested

before placing the water heater in operation.

The water heater and its individual Shut-off valve shall be disconnected from the gas supply piping system during any pressure testing of that system at test pressures in excess of 1/2 pound per square inch (3.5 kPa). It shall be isolated from the gas supply piping system by closing its individual manual Shut-off valve during any pressure testing of the gas supply piping system at test pressures equal to or less than 1/2 pound per square inch (3.5 kPa).

IMPORTANT: MAKE SURE THE GAS LINE IS PIPED IN WITH HARD PIPE. AVOID FLEX LINE CONSTRUCTION FOR GAS DUE TO POSSIBLE GAS FLOW PROBLEMS..

SUPPLY GAS REGULATOR

The maximum allowable gas supply pressure for this water heater is 14 inches W.C. (3.5 kPa). Install a positive lock-up gas pressure regulator in the gas supply line if inlet gas pressure can exceed 14 inches W.C. (3.5 kPa) at any time.

If a positive lock-up regulator is required follow these instructions:

1. Positive lock-up gas pressure regulators must be rated at or above the input Btu/hr rating of the water heater they supply.
2. Positive lock-up gas pressure regulator(s) should be installed no closer than 3 feet (1 meter) and no farther than 8 feet (2.4 meters) from the water heater's inlet gas connection.
3. After installing the positive lock-up gas pressure regulator(s) an initial nominal supply pressure setting of 7.0" W.C. while the water heater is operating is recommended and will generally provide good water heater operation. Some additional adjustment may be required later to maintain a steady gas supply pressure.
4. When installing multiple water heaters in the same gas supply system it is recommended that individual positive lock-up gas pressure regulators be installed at each unit.

All gas piping must comply with local codes and ordinances or with the current edition of National Fuel Gas Code (ANSI Z223.1/NFPA-54). Copper or brass tubing and fittings (except tin lined copper tubing) shall not be used.

If the gas control valve is subjected to pressures exceeding 1/2 psi (3.5 kPa), the damage to the gas control valve could result in a fire or explosion from leaking gas.

If the main gas line Shut-off serving all gas appliances is used, also turn "off" the gas at each appliance. Leave all gas appliances shut "off" until the water heater installation is complete.

A gas line of sufficient size must be run to the water heater. Consult the current edition of National Fuel Gas Code (ANSI Z223.1/NFPA 54) and your gas supplier concerning pipe size.

There must be:

- A readily accessible manual shut off valve in the gas supply line serving the water heater, and
- A drip leg (sediment trap) ahead of the gas control valve to help prevent dirt and foreign materials from entering the gas control valve.
- A ground joint union of proper size between the shut off valve and control valve to permit servicing of the unit.

Be sure to check all the gas piping for leaks before lighting the water heater. Use a soapy water solution, not a match or open flame. Rinse off soapy solution and wipe dry.

CONDENSATE PIPING

This water heater is a condensing unit and requires a drain to be located in close proximity to allow the condensate to drain safely. The condensate drains from the unit at the exhaust tee located at

the bottom of the unit (see figure 12). Condensate from this water heater is mildly acidic. Please note that some local codes require that condensate is treated by using a pH neutralizing filter prior to disposal.

Caution must be used to ensure that the drain is free and clear of debris and will not allow backflow through the condensate hose. Consideration must be given to avoid freezing of the condensate lines which could result in excessive build up of condensate inside the water heater. Waterproof heat tape may be required to prevent freezing of the condensate lines. Please ensure that the outlet of the condensate drain does not create a slippery condition which could lead to personal injury.

⚠ WARNING

Breathing Hazard - Carbon Monoxide Gas

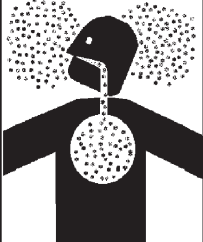

- Form an approximately 8" diameter loop in the condensate hoses on top of the water heater to trap water and prevent the escape of combustion by-products.
- Do not elevate the condensate hose on the bottom of the water heater above the bracket attached to the side of the unit. This must be true for the entire length of the hose including the exit into an appropriate drain.
- Condensate lines must be free and clear of debris and must not allow back flow through the hose. The condensate lines must be able to flow freely to an appropriate drain.
- Do not allow condensate lines to become crimped closed.
- Analyze the entire vent system to make sure that condensate will not become trapped in a section of vent pipe and therefore reduce the open cross sectional area of the vent.

Breathing carbon monoxide can cause brain damage or death.
 Always read and understand instruction manual.

CONDENSATION WARNING: THIS WATER HEATER IS A CONDENSING UNIT AND REQUIRES A DRAIN TO BE LOCATED IN CLOSE PROXIMITY TO ALLOW CONDENSATE TO DRAIN SAFELY. THE CONDENSATE DRAINS FROM UNIT AT THE EXHAUST ELBOW LOCATED AT BOTTOM OF UNIT. NOTE: IT IS IMPORTANT THAT THE CONDENSATE HOSE NOT BE ELEVATED ABOVE THE EXHAUST ELBOW, SEE FIGURE 12. CONDENSATE BUILD-UP WILL BLOCK THE EXHAUST OUTLET, WHICH WILL CAUSE IMPROPER OPERATION.

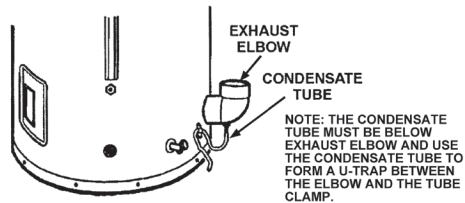

FIGURE 12.

The condensate drain line must be routed to a suitable drain. If no floor drain is available or the drain is above the level of the condensate line, install a condensate pump that is resistant to the acidic condensate. These pumps are available from local distributors. If the pump is not resistant to acidic water, a condensate neutralizer must be used ahead of the pump. When installing the drain line, note the following:

- Plastic pipe or tubing must be used to connect the condensate drain to a suitable drain or condensate pump. Do not use copper tubing, iron, or steel pipe for the condensate drain line.
- Condensate drain lines should be installed in conditioned areas only. Drain lines installed in areas that are subject to freezing temperatures should be wrapped with a nationally recognized/listed heat tape and/or approved insulation for freeze protection. Install per manufacturer's instructions.
- Do not common drain with the temperature and pressure relief valve or the condensate line from an air conditioner evaporator coil.

- Slope the condensate drain toward the inside floor drain or condensate pump.
- The condensate drain line and connection to the drain piping must comply with all local codes.

HIGH ALTITUDE INSTALLATIONS

⚠ WARNING

Breathing Hazard - Carbon Monoxide Gas



- Special consideration must be taken with installations above 10,100 feet (3,079m).
- Please contact an AO Smith qualified service agent to obtain the proper setup and instructions before lighting.
- Failure to implement the proper setup will result in improper and inefficient operation of the appliance resulting in production of increased levels of carbon monoxide gas in excess of the safe limits which could result in serious personal injury or death.

Breathing carbon monoxide can cause brain damage or death.
 Always read and understand instruction manual.

This high efficiency water heater is certified for use without modification for an altitude of 10,000 feet (3,079 meters). Consult the factory for installation at altitudes over 10,100 feet (3,079m).

Some gas utility companies derate their gas for altitude, making it unnecessary to install high altitude orifices. Call the local gas or utility company to verify BTU content.

Due to the input ration reduction at high altitudes, the output rating of the appliance is also reduced and should be compensated for in the sizing of the equipment for applications.

FILLING THE WATER HEATER

CAUTION

Property Damage Hazard

- Avoid water heater damage.
- Fill tank with water before operating.

Never use this water heater unless it is completely full of water. To prevent damage to the tank, the tank must be filled with water. Water must flow from the hot water faucet before turning "ON" gas to the water heater.

To fill the water heater with water:

1. Close the water heater drain valve by turning the handle to the right (clockwise). The drain valve is on the lower front of the water heater.
2. Open the cold water supply valve to the water heater. **NOTE: The cold water supply valve must be left open when the water heater is in use.**
3. To insure complete filling of the tank, allow air to exit by opening the nearest hot water faucet. Allow water to run until a constant flow is obtained. This will let air out of the water heater and the piping.
4. Check all water piping and connections for leaks. Repair as needed.

⚠ **WARNING**

Breathing Hazard - Carbon Monoxide Gas



- Install vent system in accordance with codes.
- Do not operate water heater if flood damaged.
- Special Consideration must be taken with installations above 10,100' (3,078m) for standard models.
- Do not operate if soot buildup.
- Do not obstruct water heater air intake with insulating jacket.
- Do not place chemical vapor emitting products near water heater.
- Gas and carbon monoxide detectors are available.
- Never operate the heater unless it is vented to the outdoors and has adequate air supply to avoid risks of improper operation, fire, explosion or asphyxiation.
- Analyze the entire vent system to make sure that condensate will not become trapped in a section of vent pipe and therefore reduce the open cross sectional area of the vent.

Breathing carbon monoxide can cause brain damage or death.
Always read and understand instruction manual.

Never operate the water heater unless it is vented to the outdoors.

The instructions in this section of the manual must be followed to avoid choked combustion or recirculation of flue gases. Such conditions cause sooting of the combustion chamber, burners and flue tubes and creates a risk of asphyxiation.

For direct vent application where combustion air might be supplied from extremely cold ambient through fresh air intake piping system, it is recommended that a backflow preventer be installed at the intake vent terminal close to the blower before proceeding with installation of the rest of the fresh air intake piping. Call the technical support phone number listed on the back cover of this manual for more information.

VENT PIPE TERMINATION

The first step is to determine where the vent pipe will terminate. See Figures 15, 16, 17 and 18. The vent may terminate through a sidewall as shown in Figures 15 and 16 or through the roof as shown in Figures 17 and 18.

The vent system must terminate so that proper clearances are maintained as cited in local codes or the current edition of the National Fuel Gas Code, (ANSI Z223.1, 12.9.1 through 12.9.4). See Figures 13 and 14.

Instructions on proper installation through a sidewall are provided in Figures 15A, 15B, 15C, and 16.

Plan the vent system layout so that proper clearances are maintained from plumbing and wiring.

Vent pipes serving power vented appliances are classified by building codes as "vent connectors". Required clearances from combustible materials must be provided in accordance with information in this manual under FACTS TO CONSIDER ABOUT LOCATION and INSTALLING THE WATER HEATER, and with the National Fuel Gas Code and local codes.

PLANNING THE VENT SYSTEM

Plan the route of the vent system from the exhaust elbow to the planned location of the vent terminal.

1. Layout total vent system to use a minimum of vent pipe and elbows.
2. This water heater is capable of venting flue gases equivalent to 45' (13.7 m) of 2" pipe, 128' (39 m) of 3" pipe as listed in Table 5.

Table 5

Number of 90° Elbows	2" Maximum Pipe - ft. (m)	3" Maximum Pipe - ft. (m)
1	40 (12.19)	120 (36.57)
2	35 (10.66)	115 (35.05)
3	30 (9.14)	110 (33.52)
4	25 (7.62)	105 (32)
5	20 (6.09)	100 (30.48)
6	15 (4.57)	95 (28.95)

The minimum vent length for each pipe size is one 90° plus 2' (61 cm) of straight pipe and the appropriate termination.

NOTE: The equivalent feet (m) of pipe listed above are exclusive of the termination. That is, the termination, with an installed screen, is assumed to be in the system and the remainder of the system must not exceed the lengths discussed above.

3. The exhaust elbow assembly is designed to accept only straight sections of 2" pipe. To start, a minimum 2" (5.1cm) maximum 6" long of 2" pipe must be inserted and glued to the exhaust elbow assembly if utilizing 3" vent pipe. Use the same method with the blower inlet if a direct vent configuration is utilized.

If using 2" inch vent pipe:

A minimum of 2" (5.1cm) diameter vent pipe must be attached to the exhaust elbow assembly. The total system cannot exceed the lengths discussed above, where each elbow is equal to 5 equivalent feet (1.5m) of straight pipe.

If using 3" inch vent pipe:

Two inches (5.1cm) of 2" pipe must be attached to the exhaust elbow assembly before adding a reducer to acquire the desired pipe diameter. An appropriately sized 45 degree elbow (supplied locally-a schedule 40 DWV) vent terminal must be obtained with an equivalent screen (supplied in vent kit). The total system cannot exceed the equivalent pipe lengths discussed above where each elbow is equal to 5 feet (1.5m) of straight pipe (3" vent pipe).

NOTE: This unit can be vented with PVC pipe materials (DWV ASTM-D2665 or CSA B181.2; Schedule 40, 80, 120 ASTM-D1785 or CSA B137.3; or SDR Series ASTM-D2241 or CSA B137.3), CPVC pipe materials (CPVC41 ASTM-D2846 or CSA B137.6; Schedule 40, 80 ASTM-F441 or CSA B137.6; or SDR Series ASTM-F442), ABS pipe materials (Schedule 40 DWV ASTM-D2661 or CSA B181.1). The fittings, other than the TERMINATION should be equivalent to PVC-DWV fittings meeting ASTM D-2665 (Use CPVC fittings, ASTM F-438 for CPVC pipe and ABS fittings, ASTM D-2661/3311 for ABS pipe). If CPVC or ABS pipe and fittings are used, then proper cement must be used for all joints, including joining the pipe to Termination (PVC Material). If local codes do not allow the use of the PVC termination when a material other than PVC is used for venting, then an equivalent fitting of that material may be substituted if the screen in the PVC terminal is removed and inserted into the new fitting.

PVC Materials should use ASTM D-2564 Grade Cement; CPVC Materials should use ASTM F-493 Grade Cement and ABS Materials should use ASTM D-2235 Grade Cement.

If the water heater is being installed as a replacement for an existing power vented heater in pre-existing venting, a thorough inspection of existing venting system must be performed prior to any installation work. Verify that correct material as detailed above has been used, and that the minimum or maximum vent lengths and terminal location as detailed in this manual have been met. Carefully inspect the entire venting system for any signs of cracks or fractures, particularly at joints between elbows and other fittings and straight runs of vent pipe. Check system for signs of sagging or other stresses in joints as a result of misalignment of any components in the system. If any of these conditions are found, they must be corrected in accordance with the venting instructions in this manual before completing installation and putting the water heater into service.

NOTE: For water heaters in locations with high ambient temperatures (above 100°F) it is recommended that CPVC or ABS pipe and fittings be used.

4. All vent (exhaust) pipes must be pitched a minimum of a 1/4" per foot back to the water heater to allow drainage of condensation.

INSTALLATION OF VENT SYSTEM

Before beginning installation of piping system thoroughly read the section of this manual VENT PIPE PREPARATION.

If you are installing your system so that it vents through roof, please refer to section titled INSTALLATION OF VERTICAL VENT SYSTEM.

VENT TERMINAL INSTALLATION, SIDEWALL

1. Install the vent terminal by using the cover plate as a template to mark the hole for the vent pipe to pass through the wall. BEWARE OF CONCEALED WIRING AND PIPING INSIDE THE WALL.
2. If the Vent Terminal is being installed on the outside of a finished wall, it may be easier to mark both the inside and outside wall. Align the holes by drilling a hole through the center of the template from the inside through to the outside. The template can now be positioned on the outside wall using the drilled hole as a centering point for the template.
3. A) MASONRY SIDE WALLS
Chisel an opening approximately one half inch (1.3 cm) larger than the marked circle.

B) WOODEN SIDE WALLS

Drill a pilot hole approximately one quarter inch (0.64 cm) outside of the marked circle. This pilot hole is used as a starting point for a saws-all or sabre saw blade. Cut around the marked circle staying approximately one quarter inch (0.64 cm) outside of the line. (This will allow the vent to easily slide through the opening. The resulting gap will be covered up by the Vent Terminal cover plate.) Repeat this step on inside wall if necessary.

INSTALLATION REQUIREMENTS - COMMONWEALTH OF MASSACHUSETTS

COMMONWEALTH OF MASSACHUSETTS

For all side wall terminated, horizontally vented power vent, direct vent, and power direct vent gas fueled water heaters installed in every dwelling, building or structure used in whole or in part for residential purposes, including those owned or operated by the Commonwealth and where the side wall exhaust vent termination is less than seven (7) feet above finished grade in the area of the venting, including but not limited to decks and porches, the following requirements shall be satisfied:

INSTALLATION OF CARBON MONOXIDE DETECTORS

At the time of installation of the side wall horizontal vented gas fueled equipment, the installing plumber or gasfitter shall observe that a hard wired carbon monoxide detector with an alarm and battery back-up is installed on the floor level where the gas equipment is to be installed. In addition, the installing plumber or gasfitter shall observe that a battery operated or hard wired carbon monoxide detector with an alarm is installed on each additional level of the dwelling, building or structure served by the sidewall horizontal vented gas fueled equipment. It shall be the responsibility of the property owner to secure the services of qualified licensed professionals for the installation of hard wired carbon monoxide detectors.

In the event that the side wall horizontally vented gas fueled equipment is installed in a crawl space or an attic, the hard wired carbon monoxide detector with alarm and battery back-up may be installed on the next adjacent floor level.

In the event that the requirements of this subdivision can not be met at the time of completion of installation, the owner shall have a period of thirty (30) days to comply with the above requirements provided that during said thirty (30) day period, a battery operated carbon monoxide detector with an alarm shall be installed.

APPROVED CARBON MONOXIDE DETECTORS

Each carbon monoxide detector as required in accordance with the above provisions shall comply with NFPA 720 and be ANSI/UL 2034 listed and CSA certified.

SIGNAGE

A metal or plastic identification plate shall be permanently mounted to the exterior of the building at a minimum height of eight (8) feet above grade directly in line with the exhaust vent terminal for the horizontally vented gas fueled heating appliance or equipment. The sign shall read, in print size no less than one-half (1/2) inch in size, "**GAS VENT DIRECTLY BELOW. KEEP CLEAR OF ALL OBSTRUCTIONS.**" Inspection The state or local gas inspector of the side wall horizontally vented gas fueled equipment shall not approve the installation unless, upon inspection, the inspector

observes carbon monoxide detectors and signage installed in accordance with the provisions of 248 CMR 5.08(2)(a) 1 through 4.

EXEMPTIONS

The following equipment is exempt from 248 CMR 5.08(2)(a)1 through 4:

1. The equipment listed in Chapter 10 entitled "Equipment Not Required To Be Vented" in the most current edition of NFPA 54 as adopted by the Board; and
2. Product Approved side wall horizontally vented gas fueled equipment installed in a room or structure separate from the dwelling, building, or structure used in whole or in part for residential purposes.

MANUFACTURER REQUIREMENTS - GAS EQUIPMENT VENTING SYSTEM PROVIDED

When the manufacturer of Product Approved side wall horizontally vented gas equipment provides a venting system design or venting system components with the equipment, the instructions provided by the manufacturer for installation of the equipment and the venting system shall include:

1. Detailed instructions for the installation of the venting system design or the venting system components; and
2. A complete parts list for the venting system design or venting system.

MANUFACTURER REQUIREMENTS - GAS EQUIPMENT VENTING SYSTEM NOT PROVIDED

When the manufacturer of a Product Approved side wall horizontally vented gas fueled equipment does not provide the parts for venting the flue gases, but identifies "special venting systems," the following requirements shall be satisfied by the manufacturer:

1. The referenced "special venting system" instructions shall be included with the appliance or equipment installation instructions; and
2. The "special venting systems" shall be Product Approved by the Board, and the instructions for that system shall include a parts list and detailed installation instructions.

A copy of all installation instructions for all Product Approved side wall horizontally vented gas fueled equipment, all venting instructions, all parts lists for venting instructions, and/or all venting design instructions shall remain with the appliance or equipment at the completion of the installation.

TERMINATION CLEARANCES SIDEWALL POWER VENT

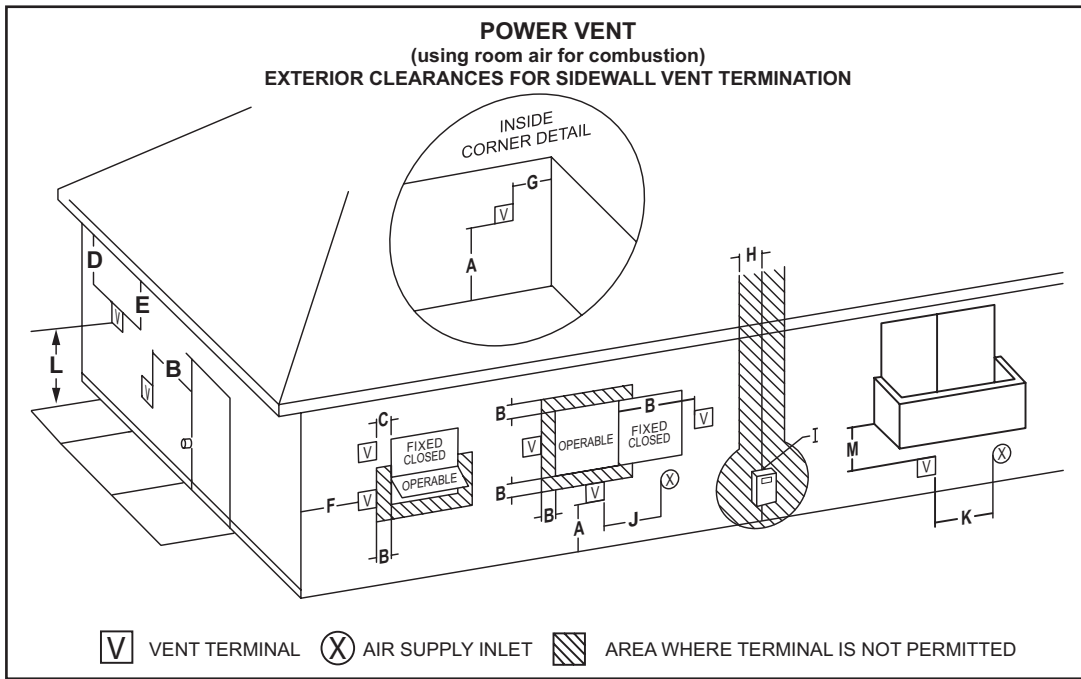

FIGURE 13

Vent terminal clearances for “Power Vent” installations. Power Vent configurations use room air for combustion.

US INSTALLATIONS ¹			US INSTALLATIONS ¹		
A	Clearance above grade, veranda, porch, deck or balcony	12 inches (30 cm)	H	Clearance to each side of center line extended above meter/regulator assembly	3 feet (91 cm) within a height 15 feet (4.5 m) above the meter/regulator assembly*
B	Clearance to window or door that may be opened	4 feet (1.2 m) below or to side of opening; 1 foot (30 cm) above opening	I	Clearance to service regulator vent outlet	3 feet (91 cm)*
C	Clearance to permanently closed window	12 inches (30 cm)*	J	Clearance to a non mechanical air supply inlet into building or combustion air inlet to any other appliance	4 feet (1.2 m) below or to side of opening; 1 foot (30 cm) above opening.
D	Vertical clearance to ventilated soffit located above the terminal within a horizontal distance of 2 feet (61 cm) from the center line of the terminal	12 inches (30 cm)*	K	Clearance to a mechanical air supply inlet	3 feet (91 cm) above if within 10 feet (3 m) horizontally
E	Clearance to unventilated soffit	12 inches (30 cm)*	L	Clearance above paved sidewalk or paved driveway located on public property	7 feet (2.13 m)
F	Clearance to outside corner	2 feet (60 cm)*	M	Clearance under veranda, porch, deck, or balcony	12 inches (30 cm) ‡
G	Clearance to inside corner	18 inches (45 cm)*			

¹ In accordance with the current ANSI Z223.1/NFPA 54, National Fuel Gas Code.

† A vent shall not terminate directly above a sidewalk or paved driveway that is located between two single family dwellings and serves both dwellings.

‡ Permitted only if veranda, porch, deck, or balcony is fully open on a minimum of two sides beneath the floor.

* Clearance in accordance with local installation codes and the requirements of the gas supplier and the manufacturer’s installation instructions.

TERMINATION CLEARANCES SIDEWALL DIRECT VENT

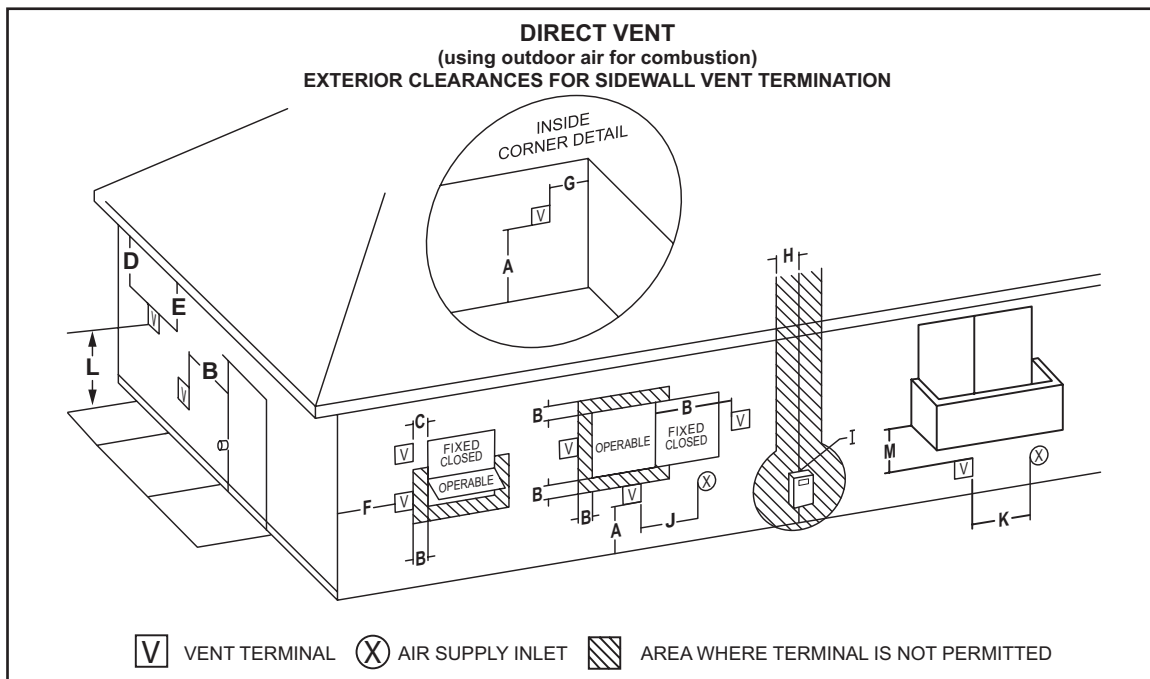

FIGURE 14

Vent terminal clearances for “Direct Vent” installations. Direct Vent configurations use outdoor air for combustion.

		US INSTALLATIONS ¹			US INSTALLATIONS ¹
A	Clearance above grade, veranda, porch, deck or balcony	12 inches (30 cm)	H	Clearance to each side of center line extended above meter/regulator assembly	3 feet (91 cm) within a height 15 feet (4.5 m) above the meter/regulator assembly*
B	Clearance to window or door that may be opened	6 inches (15 cm) for appliances up to 10,000 Btu/hr (3 kW), 9 inches (23 cm) for appliances between 10,000 Btu/hr (3 kW) and 50,000 Btu/hr (15 kW), 12 inches (30 cm) for appliances above 50,000 Btu/hr (15 kW)	I	Clearance to service regulator vent outlet	3 feet (91 cm)*
C	Clearance to permanently closed window	6 inches (15 cm)*	J	Clearance to a non mechanical air supply inlet into building or combustion air inlet to any other appliance	6 inches (15 cm) for appliances up to 10,000 Btu/hr (3 kW), 9 inches (23 cm) for appliances between 10,000 Btu/hr (3 kW) and 50,000 Btu/hr (15 kW), 12 inches (30 cm) for appliances above 50,000 Btu/hr (15 kW)
D	Vertical clearance to ventilated soffit located above the terminal within a horizontal distance of 2 feet (61 cm) from the center line of the terminal	12 inches (30 cm)*	K	Clearance to a mechanical air supply inlet	3 feet (91 cm) above if within 10 feet (3 m) horizontally
E	Clearance to unventilated soffit	12 inches (30 cm)*	L	Clearance above paved sidewalk or paved driveway located on public property	7 feet (2.13 m)††
F	Clearance to outside corner	2 feet (60 cm)*	M	Clearance under veranda, porch, deck, or balcony	12 inches (30 cm) ‡*
G	Clearance to inside corner	18 inches (45 cm)*			

¹ In accordance with the current ANSI Z223.1/NFPA 54, National Fuel Gas Code.

† A vent shall not terminate directly above a sidewalk or paved driveway that is located between two single family dwellings and serves both dwellings.

‡ Permitted only if veranda, porch, deck, or balcony is fully open on a minimum of two sides beneath the floor.

* Clearance in accordance with local installation codes and the requirements of the gas supplier and the manufacturer’s installation instructions.

SEQUENCE OF INSTALLATIONS, FIGURE 15A

Cut a length of PVC pipe about 3.5 inches (8.9 cm) longer than the wall thickness at the opening. Glue the vent terminal to this section of pipe. Slide the wall plate over the pipe to stop against the vent terminal. Place a bead of caulking (not supplied) around the gap between the pipe and cover plate. Apply enough to fill some of the gap between the pipe and wall. Place some of the caulking on the back of the plate to hold it against the wall after installation. If the vent pipe is installed up to the wall, with a coupling on the end against the wall opening, the pipe with the vent terminal can be prepared for gluing before inserting through the wall. Slide the pipe through the wall and insert into the coupling on the other side of the wall, making sure that the vent terminal ends up pointed in the correct position, see Figure 15A.

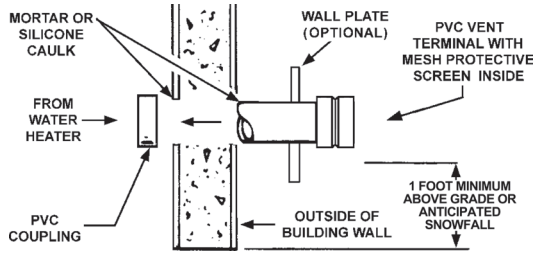

VENT TERMINATION - FIGURE 15A

DIRECT VENT TERMINAL INSTALLATION

The intake vent terminal provided on the unit contains an air intake screen to prevent large particles from entering the unit.

BLOWER AIR INLET ASSEMBLY



FIGURE 15B

WHEN THE UNIT IS TO BE SETUP AS A DIRECT VENT, THE AIR INTAKE SCREEN MUST BE REMOVED. THE INLET VENT PIPE MAY THEN BE GLUED TO THE INTAKE VENT TERMINAL (See Figure 15B) PROVIDED ON THE UNIT.

THIS UNIT CONSISTS OF TWO VENT TERMINALS - AN INTAKE VENT TERMINAL AND AN EXHAUST VENT TERMINAL. THE INTAKE VENT TERMINAL IS A 2" 90° PVC ELBOW(-) WITH AN AIR INTAKE SCREEN AND THE EXHAUST VENT TERMINAL IS A 2" 22.5° PVC COUPLING WITH AN AIR INTAKE SCREEN.

NOTE: TO PREVENT EXHAUSTING PRODUCTS FROM CIRCULATING TO THE INTAKE VENT TERMINAL IN WINDY/COLD AREAS, THE MAXIMUM PRACTICAL DISTANCE BETWEEN THESE TWO TERMINALS IS RECOMMENDED.

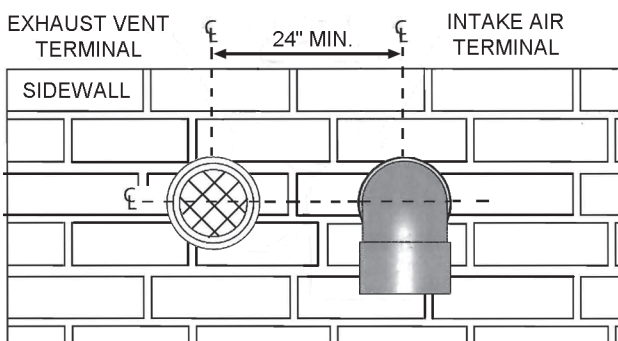

FIGURE 15C

INSTALLATION SEQUENCE

VENT TERMINALS SUPPLIED WITH HEATER MUST BE USED.

NOTE: BEFORE BEGINNING INSTALLATION OF ANY VENT PIPE READ THE VENT PIPE MANUFACTURER'S INSTALLATION INSTRUCTIONS.

1. After the points of termination have been determined, use the cover plates as templates to mark the holes for the vent pipes to be inserted through the wall. BEWARE OF CONCEALED WIRING AND PIPING INSIDE OF WALL. If the vent terminals are being installed on the outside of a finished wall, it may be easier to mark both the inside and outside wall. Align the holes by drilling a hole through the center of the template from the inside through to the outside. The template can now be positioned on the outside wall using the drilled holes as a centering point for the template.

- A.) MASONRY SIDE WALLS Chisel an opening approximately 1/2" (1.3 cm) larger than the marked circle.
- B.) WOODEN SIDE WALLS Drill a pilot hole approximately one quarter inch outside of the marked circle. This pilot hole is used as a starting point for a saws-all or sabre saw blade. Cut around the marked circle staying approximately one quarter inch outside of the line. (This will allow the vent pipe to easily slide through the opening. The resulting gap will be covered by the vent terminal cover plates.) Repeat this step on the inside wall if necessary.

2. Cut a length of 3" PVC pipe about 3.5" (8.9 cm) longer than the wall thickness at the opening.
3. Glue the intake vent terminal to the section of the pipe.
4. Slide the wall plate over pipe to stop against intake vent terminal.
5. Place a bead of caulking (not supplied) around the gap between the pipe and the wall. Place some of the caulking on the back of the plate to hold it against the wall after installation.
6. If the vent pipe is installed up to the wall, with a coupling on the end against the wall opening, the pipe with the vent terminal can be prepared for gluing before inserting through the wall. Slide the pipe through the wall and insert into coupling on the other side of the wall, making sure that the vent terminal ends up pointed in the correct position (Figure 15C and 16).

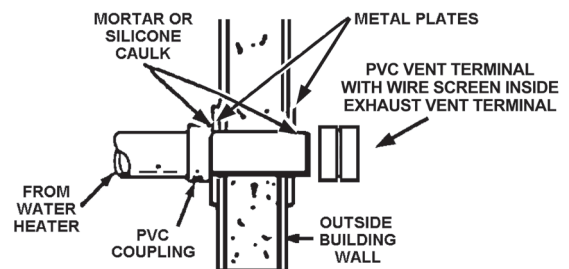

EXHAUST VENT TERMINAL - ALL MODELS

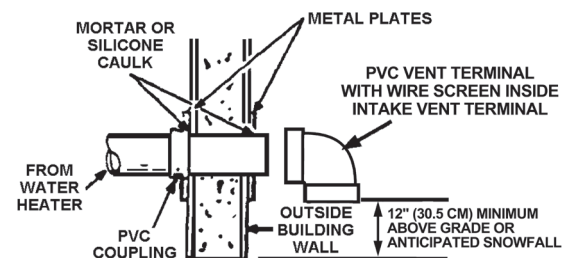

INTAKE VENT TERMINAL - ALL MODELS

FIGURE 16

VERTICAL VENT TERMINAL INSTALLATION

WHEN TERMINATING THROUGH A ROOF, THE FOLLOWING SPECIFICATIONS PERTAINING TO TERMINAL LOCATION MUST BE FOLLOWED.

1. Proper support must be provided for all pipe protruding through the roof.
2. The vertical roof terminations should be sealed with a plumbing roof boot or equivalent flashing.
3. The intake vent terminal and the exhaust vent termination must penetrate the same side of roof.
4. The center line of the intake vent terminal and the center line of the exhaust vent termination must be no closer than 24" (61cm).

The specifications are displayed in Figures 17 and 18.

NOTE: Exhaust vent terminal is installed using the same procedure.

FLAT ROOF INSTALLATION

On flat roof installations the intake air and the vent terminations must be a minimum of 24 inches (60 cm) above any parapet, vertical wall or structure within 10 feet (3 m) horizontally. See figure 19.

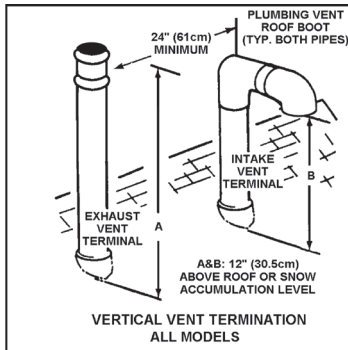

FIGURE 17.

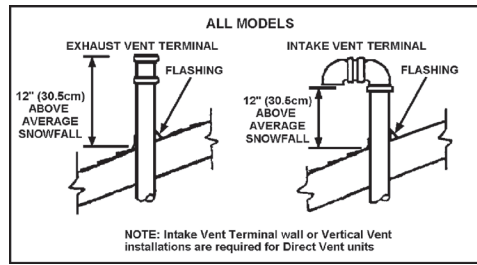
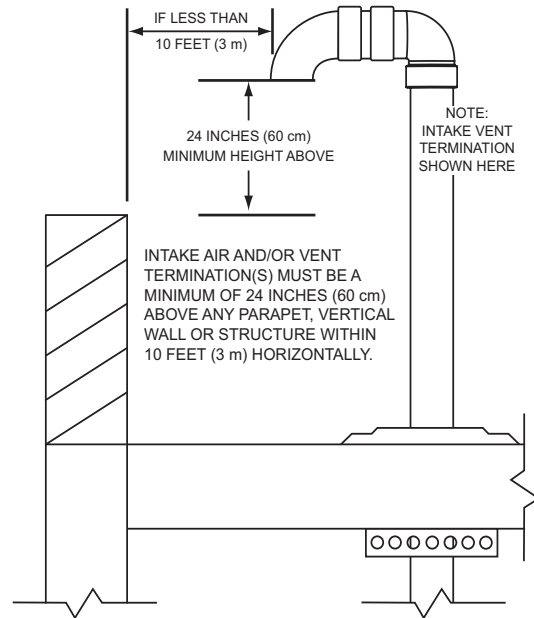

FIGURE 18.



VERTICAL TERMINATION(S) FLAT ROOF CLEARANCE
INTAKE VENT TERMINAL AND/OR VENT (EXHAUST)

FIGURE 19.

CONCENTRIC VENT INSTALLATION

This appliance is certified for concentric venting with concentric vent kit #9006328005. Follow instructions below for proper installations.

Table 6 - KIT COMPONENTS

Each kit is comprised of the following:

Item	Description	Qty.
Rain Cap	3 in.	1
SDR-26 pipe	4 in. dia.	1
SDR-26 pipe	2½ in. dia.	1
Y Concentric Fitting	3 in.	1
Installation Instructions	194504	1

Field supplied pipe and fittings are required to complete the installation.

This concentric vent termination kit may be used with 3 inch diameter pipe systems.

SAFETY CONSIDERATIONS

Installing and servicing water heating equipment can be hazardous due to gas and electrical components. Installation and service of the concentric vent termination requires ability equivalent to that of a qualified installer or service agent, see page 7. All precautions in the literature, on tags, and labels attached to the unit must be observed.

Follow all safety codes. Wear safety glasses and work gloves.

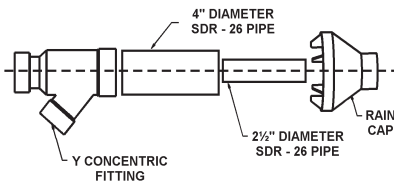

FIGURE 20.

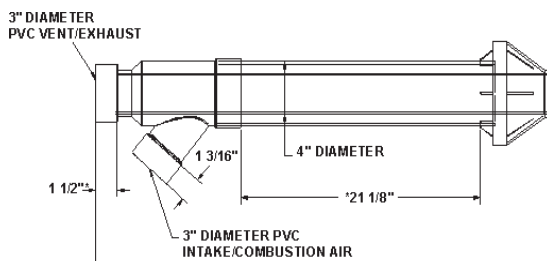

FIGURE 21.

* Dimension 21 1/8 in. may be lengthened to 60 in. maximum. Dimension 21 1/8 in. may also be shortened by cutting the pipes, provided in the kit, to 12 in. minimum.

** Dimension 39 will change accordingly as dimension 21 1/8 in. is lengthened or shortened.

Do not use field-supplied couplings to extend pipes. Airflow restriction will occur and the heater pressure switch may cause intermittent operation.

INSTALLATION PROCEDURE 1 ROOF TERMINATION, see Figure 23.

1. Determine best location for termination kit.

NOTE: Roof termination is preferred since it is less susceptible to damage, has reduced chances to intake contaminants, and less visible vent vapors.

2. Cut 1 hole (5 in. diameter)

3. Partially assemble concentric vent termination kit.

- Cement Y concentric fitting to larger diameter kit pipe, see Figure 20.
- Cement rain cap to smaller diameter kit pipe, see Figure 22.

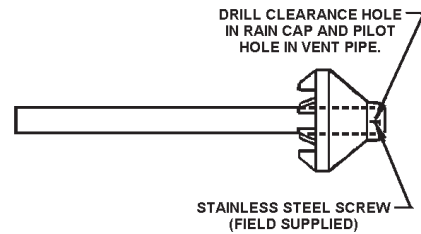

FIGURE 22.

NOTE: Instead of cementing the smaller pipe to the rain cap, a field-supplied stainless steel screw may be used to secure the 2 components together when field disassembly is desired for cleaning, see Figure 22.

When using alternate screw method, drill clearance hole in rain cap and pilot hole in vent pipe for screw size being used. Failure to drill adequate holes may cause cracking of PVC components, allowing combustion products to be recirculated. Failure to follow this warning could result in personal injury or death.

Do not operate the heater with rain cap removed or recirculation of combustion products may occur. Water may also collect inside larger combustion-air pipe and flow to the burner enclosure. Failure to follow this warning could result in product damage or improper operation, personal injury or death.

4. Install Y concentric fitting and pipe assembly through structure's hole and field supplied roof boot/flashing.

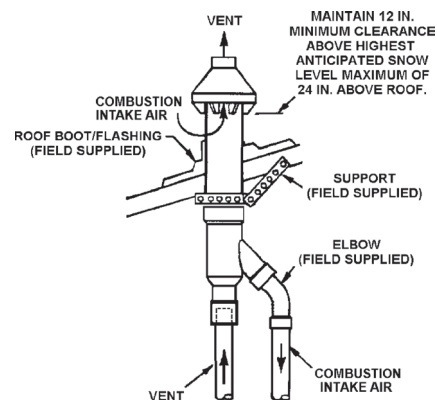

FIGURE 23.

NOTE: Do not allow insulation or other materials to accumulate inside pipe assembly when installing through hole.

- Secure assembly to roof structure as shown in Figure 23 using field supplied metal strapping or equivalent support material.

NOTE: Ensure termination height is above the roof surface or anticipated snow level as shown in Figure 23.

- Install rain cap and small diameter pipe assembly in roof penetration assembly, Ensure small diameter pipe is cemented and bottomed in Y concentric fitting.
- Cement water heater combustion air intake and vent pipes to concentric vent termination assembly. See Figure 23 for proper pipe attachment.
- Operate heater through 1 heat cycle to ensure combustion air and vent pipes are properly connected to concentric vent termination connections.

FLAT ROOF INSTALLATION

When installing a concentric termination vertically through a flat roof, the termination's vent cap must be a minimum of 10 feet (3 m) away from any parapet, vertical wall or structure as shown in Figure 23A.

If this required 10 foot (3 m) distance to a parapet, vertical wall or structure cannot be maintained, standard terminations must be used. See Vertical Termination Installation.

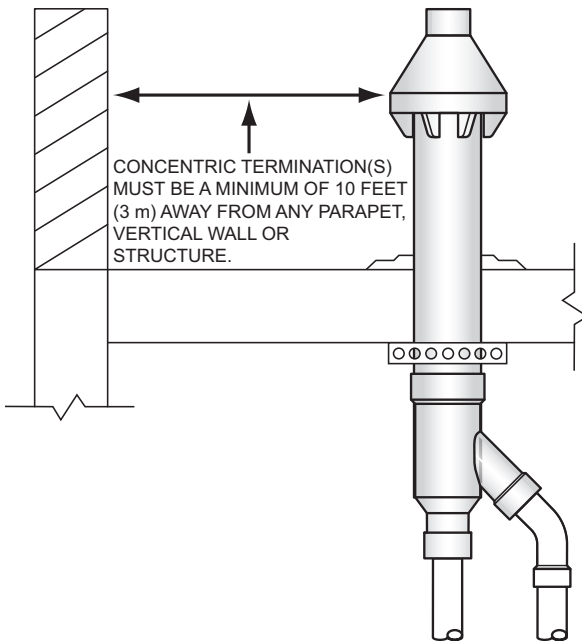

**CONCENTRIC TERMINATION
FLAT ROOF CLEARANCE**

FIGURE 23A.

PROCEDURE 2 SIDE WALL TERMINATION, SEE FIGURE 24.

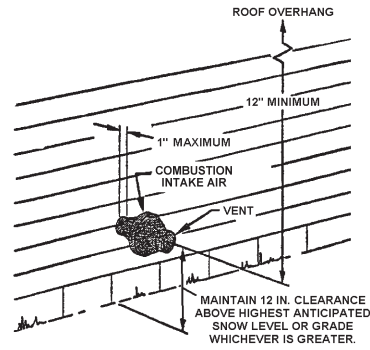

FIGURE 24.

- Determine best location for termination kit.
NOTE: Consideration for the following should be used when determining an appropriate location for the termination kit:

- Termination kit positioned where the vent vapors will not damage plants/shrubs or air conditioning equipment.
- Termination kit positioned so it will not be affected by wind eddy that may allow recirculation of combustion products, or airborne leaves, or light snow.
- Termination kit positioned where it will not get damaged or be subjected to foreign objects, such as stones, balls, etc.
- Termination kit positioned where the vent vapors will not be objectionable.

NOTE: See the venting information (starting on page 20) in this manual for additional vent location requirements.

- Cut 1 hole (5 in. diameter)
- Partially assemble concentric vent termination kit.
 - Cement the Y concentric fitting to larger diameter kit pipe, see Figure 19.
 - Cement the rain cap to the smaller diameter kit pipe, see Figure 22.

NOTE: Instead of cementing the smaller pipe to the rain cap, a field-supplied stainless steel screw may be used to secure the 2 components together when field disassembly is desired for cleaning, see Figure 22.

When using alternate screw assembly method, drill clearance hole in rain cap and pilot hole in vent pipe for screw being used. Failure to drill adequate holes may cause cracking of PVC components, allowing combustion products to be recirculated. Failure to follow this warning could result in personal injury or death.

Do not operate the heater with rain cap removed or recirculation of combustion products may occur. Water may also collect inside larger combustion-air pipe and flow to the burner enclosure. Failure to follow this warning could result in product damage or improper operation, personal injury or death.

- Install Y concentric fitting and pipe assembly through structure's hole.

NOTE: Do not allow insulation or other materials to accumulate inside pipe assembly when installing through hole.

5. Install rain cap and small diameter pipe assembly in Y concentric fitting and large pipe assembly. Ensure small diameter pipe is bottomed and cemented in Y concentric fitting.
6. Secure assembly to structure as shown in Figure 24 using field-supplied metal strapping or equivalent support material.

NOTE: Ensure termination location clearance dimensions are as shown in the diagrams found in Figure 24 and 25. When extending the length of the 4" pipe, the added length beyond 21-1/8" must be deducted from the maximum equivalent feet of vent pipe.

NOTE: If assembly needs to be extended to allow side wall thickness requirement, the 2 pipes supplied in the kit may be replaced by using same diameter, field-supplied SDR-26 PVC (D2241) pipe. Do not extend 21 1/8" dimension more than 60 in. (See Figure 20.)

Do not use field-supplied couplings to extend pipes. Airflow restriction will occur and the heater pressure switch may cause intermittent operation.

7. Cement heater combustion-air and vent pipes to concentric vent termination assembly. See Figure 25 for proper pipe attachment.
8. Operate heater through 1 heat cycle to ensure combustion-air and vent pipes are properly connected to concentric vent termination connections.

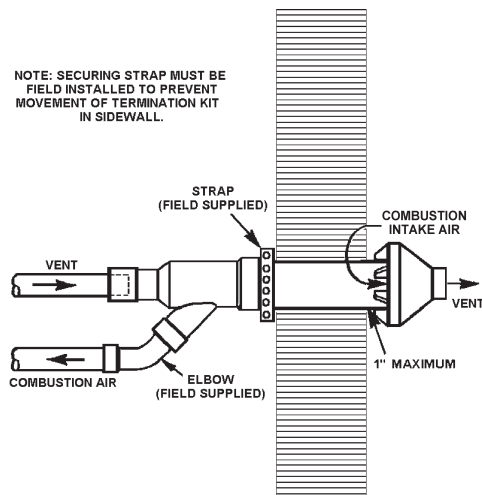

FIGURE 25.

MULTI-CONCENTRIC VENT TERMINATIONS

When two or more appliances are direct vented with concentric vent terminations near each other, each appliance must be individually vented. NEVER common vent this appliance. When two or more appliances are direct vented using concentric vent terminations, the appliances may be vented as shown in Figure 26 and 27.

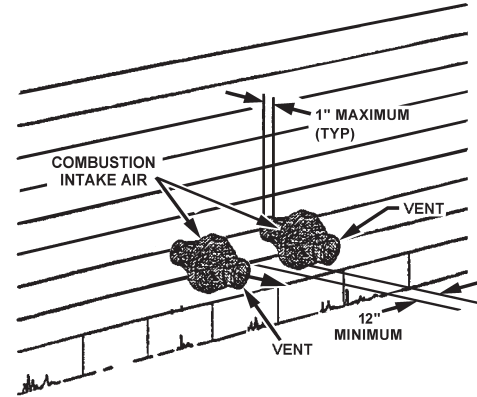

FIGURE 26.
Concentric Vent Terminations for Horizontal Direct Venting.

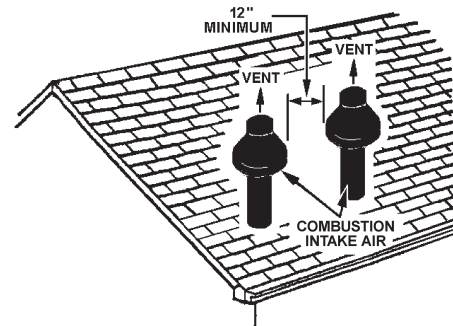

FIGURE 27.
Concentric Vent Terminations for Vertical Direct Venting through a roof.

DIRECT VENT DIAGRAM

ROOF VENT

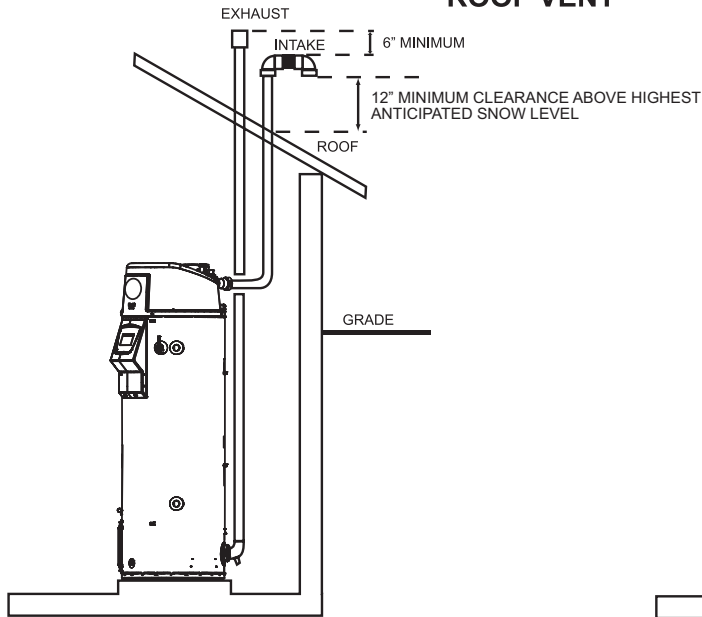

FIGURE 28.

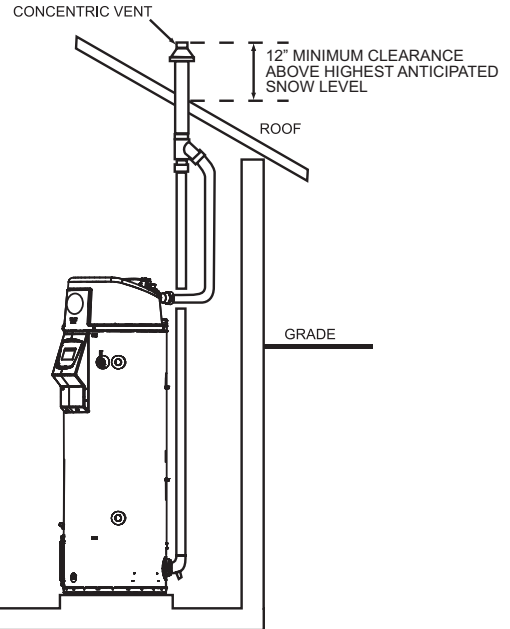

FIGURE 29.

SIDEWALL VENT

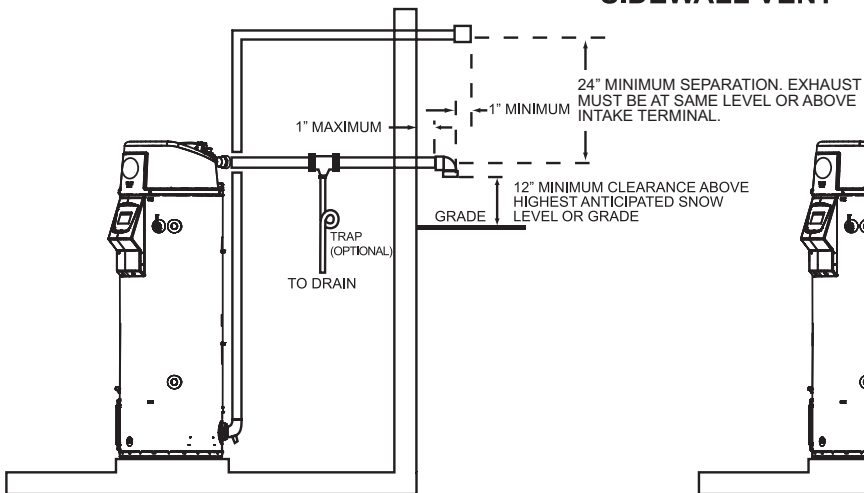

FIGURE 30.

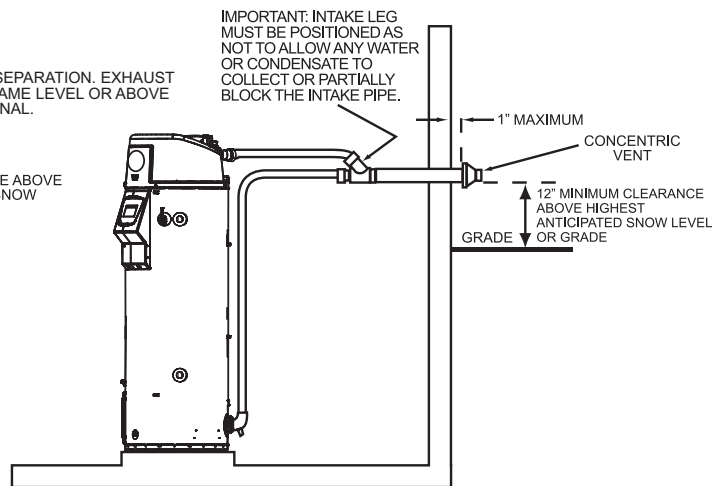

FIGURE 31.

SIDEWALL VENT FOR COLD CLIMATE

When direct venting through the wall, as shown in Figure 32, the exhaust should terminate a minimum of 24" from the intake vent terminal. The exhaust may be rotated up to 45 degrees left or right as long as the 24" distance is maintained.

The wire screen can be removed for space heating at cold climate installation to prevent potential air intake freeze up. If wire screen is removed during winter to prevent freezing it is recommended to re-install the screen during non-space heating seasons.

If necessary to achieve the 12" minimum clearance above the highest anticipated snow level or grade for the intake vent terminal install a snorkel, similar to the exhaust, in the up position. Maintain the 24" distance between the intake and exhaust terminations.

Optional cold climate sidewall direct vent kits are available: 318221-000 for 2" vent systems and 318222-000 for 3" vent systems.

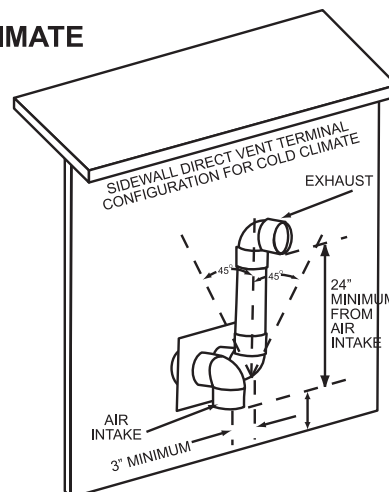

FIGURE 32.

VENT PIPE PREPARATION

1. INITIAL PREPARATION.

- A.) Make sure the solvent cement you are planning to use is designed for the specific application you are attempting.
- B.) Know the physical and chemical characteristics and limitations of the PVC and CPVC piping materials that you are about to use.
- C.) Know the reputation of your manufacturer and their products.
- D.) Know your own qualifications or those of your contractor. The solvent welding technique of joining PVC and CPVC pipe is a specialized skill just as any other pipe fitting technique.
- E.) Closely supervise the installation and inspect the finished job before start-up.
- F.) Contact the manufacturer, supplier, or competent consulting agency if you have any questions about the application or installation of PVC and CPVC pipe.
- G.) Take the time and effort to do a professional job. Shortcuts will only cause you problems and delays in start-up. By far, the majority of failures in PVC and CPVC systems are the result of shortcuts and/or improper joining techniques.

2. SELECTION OF MATERIALS.

- Cutting Device - Saw or Pipe Cutter.
- Deburring Tool, Knife, File, or Beveling Machine (2" and above).
- Brush - Pure Bristle.
- Rag - Cotton (Not Synthetic).
- Primer and Cleaner.
- Solvent Cement - PVC for PVC Components and CPVC for CPVC Components.
- Containers - Metal or Glass to hold Primer and Cement. Select the type of PVC or CPVC materials to be used on the basis of their application with respect to chemical resistance, pressure rating, temperature characteristics, etc.
- Insertion Tool - Helpful for larger diameter pipe and fittings 6 inches (15.2cm) and above.

⚠ WARNING

Fire or Explosion Hazard

- Do not store or use gasoline or other flammable vapors and liquids in the vicinity of this or any other appliance.
- Avoid all ignition sources if you smell LP gas.
- Do not expose water heater control to excessive gas pressure.
- Use only gas shown on rating plate.
- Maintain required clearances to combustibles.
- Keep ignition sources away from faucets after extended period of non-use.



Read instruction manual before installing, using or servicing water heater.



PRIMER

It is recommended that Tetrahydrofuran (THF) be used to prepare the surfaces of pipe and fittings for solvent welding. Do not use water, rags, gasoline or any other substitutes for cleaning PVC or CPVC surfaces. A chemical cleaner such as MEK may be used.

PRIMER AND CEMENT

Tetrahydrofuran (THF) primer should be used to prepare the surfaces of pipe and fittings for solvent welding. If CPVC or ABS pipe and fittings are used, then the proper cement must be used for all joints, including joining the pipe to the factory provided terminations (PVC material). PVC Materials should use ASTM D-2564 Grade Cement; CPVC Materials should use ASTM F-493 Grade Cement and ABS Materials should use ASTM D-2235 Grade Cement.



⚠ WARNING

Fire Hazard

- Primers and cements are extremely flammable, and must not be stored or used near heat or open flame.
- Also, use only in a well ventilated area.

APPLICATORS

Select a suitable pure bristle type paint brush. Use a proper width brush or roller to apply the primer and cement (see chart below). Speedy application of cement is important due to its fast drying characteristics. **IMPORTANT NOTE:** A dauber type applicator should only be used on pipe sizes 2" and below. For larger diameter pipe, a brush or roller must be used.

Table 7

RECOMMENDED BRUSH* SIZE FOR PRIMER AND CEMENT APPLICATIONS	
Nominal Pipe (IPS)	Size Brush Width
2	1.5" (3.8cm)
3	1.5"-2.5" (3.8cm - 6.4cm)

***USE ONLY NATURAL BRISTLE**

3. MAKING THE JOINT.

- A.) Cutting Pipe must be squarely cut to allow for the proper interfacing of the pipe end and the fitting socket bottom. This can be accomplished with a miter box saw or wheel type cutter. Wheel type cutters are not generally recommended for larger diameters since they tend to flare the corner of the pipe end. If this type of cutter is used, the flare on the end must be completely removed.

NOTE: Power saws should be specifically designed to cut plastic pipe.

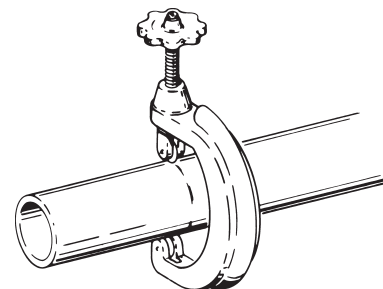

STEP A

B. Deburring

Use a knife, plastic pipe deburring tool, or file to remove burrs from the end of small diameter pipe. Be sure to remove all burrs from around the inside as well as the outside of the pipe. A slight chamfer (bevel) of about 10°-15° should be added to the end to permit easier insertion of the pipe into the end of the fitting. Failure to chamfer the edge of the pipe may remove cement from the fitting socket, causing the joint to leak.

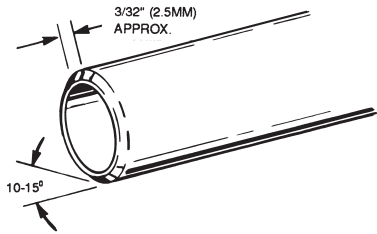

STEP B

C. Test dry fit of the joint

Tapered fitting sockets are designed so that an interfaced fit should occur when the pipe is inserted about 1/3 to 2/3 of the way into the socket. Occasionally, when pipe fitting dimensions are at the tolerance extremes, it will be possible to fully insert dry pipe to the bottom of the fitting socket. When this happens, a sufficient quantity of cement must be applied to the joint to fill the gap between the pipe and fitting. The gap must be filled to obtain a strong, leak-free joint.

D. Inspection, cleaning, priming

Visually inspect the inside of the pipe and fitting sockets and remove all dirt, grease or moisture with a clean dry rag. If wiping fails to clean the surfaces, a chemical cleaner must be used. Check for possible damage such as splits or cracks and replace if necessary.

Depth-of-entry

Marking the depth of entry is a way to check if the pipe has reached the bottom of the fitting socket in Step F. Measure the fitting depth and mark this distance on the pipe O.D. You may want to add several inches to the distance and make a second mark as the primer and cement will most likely destroy your first one.

Apply primer to the surface of the pipe and fitting socket with a natural bristle brush. This process softens and prepares the PVC or CPVC for the solvent cementing step. Move quickly and without hesitation to the cementing procedure while the surfaces are still wet with primer.

E. Application of solvent cement

- Apply the solvent cement evenly and quickly around the outside of the pipe at a width a little greater than the depth of the fitting socket.
- Apply a light coat of cement evenly around the inside of the fitting socket. Avoid puddling.
- Apply a second coat of cement to the pipe end.

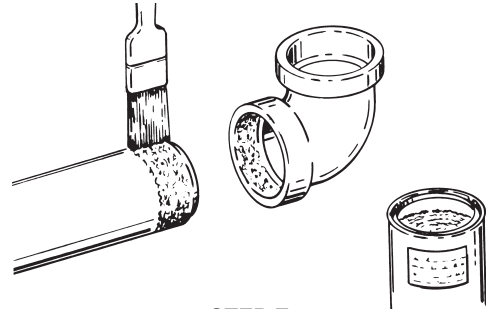

STEP E

F. Joint assembly

Working quickly, insert the pipe into the fitting socket bottom and give the pipe or fitting a 1/4 turn to evenly distribute the cement. Do not continue to rotate the pipe after it has hit the bottom of the fitting socket. A good joint will have sufficient cement to make a bead all the way around the outside of the fitting hub. The fitting will have a tendency to slide back while the cement is still wet so hold the joint together for about 15 seconds.

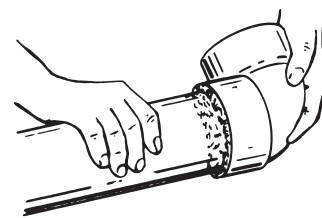

STEP F

G. Cleanup and joint movement

Remove all excess cement from around the pipe and fitting with a dry cotton rag. This must be done while the cement is still soft.

The joint should not be disturbed immediately after the cementing procedure, and sufficient time should be allowed for proper curing of the joint. Exact drying time is difficult to predict because it depends on variables such as temperature, humidity and cement integrity. For more specific information, you should contact your solvent cement manufacturer.

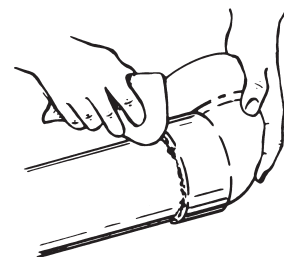

STEP G

CONTROLS AND SWITCHES

This model is provided with three pressure switches. These switches are essential to the safe and proper operation of the unit. All switches are wired in series. The controller is set up to shut the unit down whenever there is a failure of any of the switches. It is important to understand the purpose of each switch.

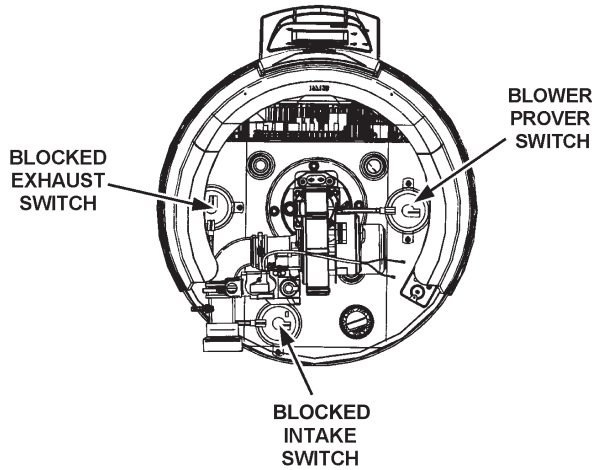

FIGURE 33.

BLOWER PROVER SWITCH

(SEE FIGURE 33)

The Blower Prover Switch is provided on the heater to verify that the fan is operating. It is a positive pressure switch whose electrical contacts are normally open. When the fan increases the pressure in the burner, the pressure switch will allow the electrical contacts to close. The pressure switch is connected to the burner tap by a piece of tygon tubing. This tubing must be connected in order for the switch to change the electrical contacts. The controller requires that the electrical contacts on this air flow switch be open before it will allow the blower to come on.

BLOCKED EXHAUST SWITCH

(SEE FIGURE 33)

The Blocked Exhaust Switch is set up to shut the unit off when a build-up of positive pressure in the exhaust vent pipe occurs. This switch is a positive pressure switch that requires an increase in

pressure to change the electrical contacts from normally closed to open. When this switch prevents the unit from igniting, most likely the exhaust is blocked by some means. Check to see if the condensate is allowed to flow freely from the exhaust elbow and for obstructions in the exhaust venting and exhaust vent terminal. Also verify that the vent length does not exceed the maximum allowed as shown in the Vent Section of this manual.

BLOCKED INTAKE SWITCH

(SEE FIGURE 33)

The Blocked Intake Switch is set up to shut the unit off when a build-up of negative pressure in the intake air pipe occurs. This switch is a negative pressure switch that requires an increase in negative pressure to change the electrical contacts from normally closed to open. The switch is connected to the pressure tap on the PVC pipe connected to the inlet of the blower. When this switch prevents the unit from igniting, most likely the intake is blocked. Verify that the screen on the intake air connection (conventional vent), the intake air pipe and termination (direct vent installations) are free of obstructions that may prevent air from entering the unit. Insure the screen on intake air connection has been removed on direct vent installations, see Figure 15. Also verify the intake air pipe length does not exceed the maximum allowed as shown in the Venting Section (See Table 5) of this manual.

ON/OFF SWITCH

The ON/OFF Switch is a single-pole, single-throw rocker switch. This switch provides 120V from the line source to the heater.

CAUTION

THE WATER HEATER IS POLARITY SENSITIVE. BEFORE APPLYING ELECTRICITY TO THIS HEATER BE CERTAIN THAT SUPPLY NEUTRAL WIRE TO GROUND CHECK INDICATES ZERO VOLTAGE.

HOT SURFACE IGNITER

The Hot Surface Igniter is a device that ignites the main burner by high temperature (>1800°F or >982°C). When 120VAC is applied to the igniter, sufficient heat is generated to ignite the main burner.



LABEL ALL WIRES PRIOR TO DISCONNECTION WHEN SERVICING CONTROLS. WIRING ERRORS CAN CAUSE IMPROPER AND DANGEROUS OPERATION. VERIFY PROPER OPERATION AFTER SERVICING.

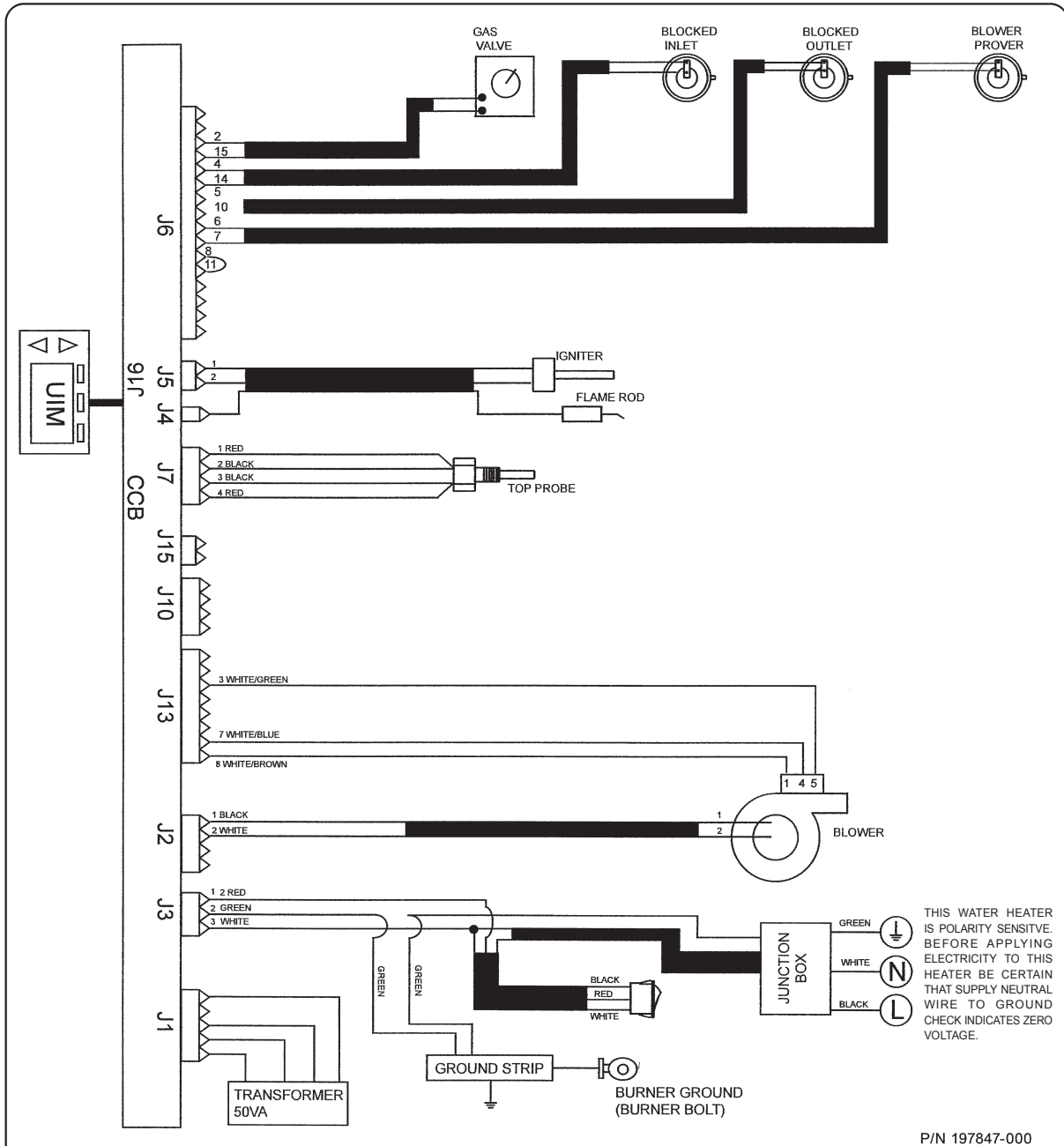

WARNING

DISCONNECT FROM ELECTRICAL SUPPLY BEFORE SERVICING UNIT.
REPLACE ALL DOORS AND PANELS BEFORE OPERATING HEATER.

IF ANY OF THE ORIGINAL WIRES SUPPLIED WITH THE APPLIANCE MUST BE REPLACED, IT MUST BE REPLACED WITH APPLIANCE WIRE MATERIAL WITH MINIMUM TEMPERATURE RATING OF 105°C AND A MINIMUM SIZE OF NO. 18 AWG.

POWER VENT WIRING SCHEMATIC - FIGURE 34.

FOR YOUR SAFETY READ BEFORE LIGHTING



WARNING: If you do not follow these instructions exactly, a fire or explosion may result causing property damage, personal injury or loss of life.



BEFORE OPERATING: ENTIRE SYSTEM MUST BE FILLED WITH WATER AND AIR PURGED FROM ALL LINES.

- A. This appliance does not have a pilot. It is equipped with an ignition device which automatically lights the burner.
Do NOT try to light the burner by hand.
- B. **BEFORE OPERATING** smell all around the appliance area for gas. Be sure to smell next to the floor because some gas is heavier than air and will settle on the floor.
- WHAT TO DO IF YOU SMELL GAS:**
- Do not try to light any appliance.
 - Do not touch any electric switch; Do not use any phone in your building.
 - Immediately call your gas supplier from a neighbor's phone. Follow the gas supplier's instructions.
- C. If you cannot reach your gas supplier, call the fire department.
- C. Use only your hand to push in the gas control buttons. Never use tools. If the control buttons will not push in, don't try to repair them, call a qualified service technician. Force or attempted repair may result in a fire or explosion.
- D. Do not use this appliance if any part has been under water. Immediately contact a qualified installer or service agency to replace a flooded water heater. Do not attempt to repair the unit! It must be replaced!

OPERATING INSTRUCTIONS

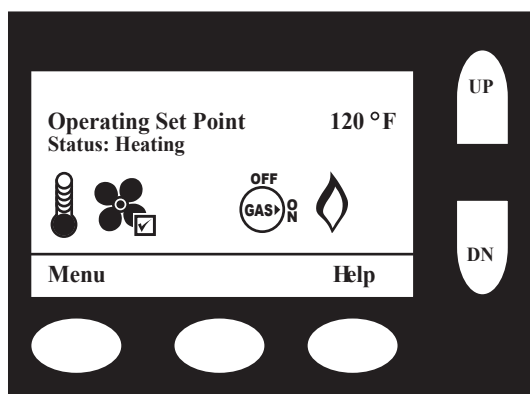

ON/OFF SWITCH

1. STOP! Read the safety information above, on this label.
2. Set the ON/OFF switch on the control panel to the "ON" position.
3. Set the thermostat to the lowest setting.
4. Set the ON/OFF switch on the control box to the "OFF" position.
5. This appliance is equipped with a device which automatically lights the burner.
DO NOT TRY TO LIGHT THE BURNER BY HAND.
6. Wait five (5) minutes to clear out any gas. If you smell gas, STOP! Follow "B" in the safety information above on this label. If you don't smell gas.
7. Turn on all electrical power to the appliance.
8. Set the ON/OFF switch on the control box to the "ON" position.
9. Set the thermostat to the desired setting.
 CAUTION: Hotter water increases the risk of scald injury. Consult the instruction manual before changing temperature.
10. If the appliance will not operate, follow the instructions "TO TURN OFF GAS TO APPLIANCE" and call your technician or gas supplier.
 WARNING: TURN OFF ALL ELECTRIC POWER BEFORE SERVICING

TO TURN OFF GAS TO APPLIANCE

1. Set the thermostat to the lowest setting.
2. Set the ON/OFF switch on the control panel to the "OFF" position.
3. Turn off all electrical power to the appliance if service is to be performed.

TEMPERATURE REGULATION

It is recommended that lower water temperatures be used to avoid the risk of scalding. It is further recommended, in all cases, that the water temperatures be set for the lowest temperature which satisfies your hot water needs. This will also provide the most energy efficient operation of the water heater.

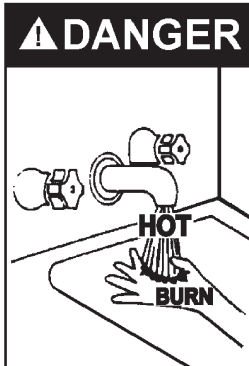

Water temperature over 125°F (52°C) can cause severe burns instantly resulting in severe injury or death.

Children, the elderly, and the physically or mentally disabled are at highest risk for scald injury.

Feel water before bathing or showering.

Temperature limiting valves are available.

Read instruction manual for safe temperature setting.

HOT WATER CAN SCALD: Water heaters are intended to produce hot water. Water heated to a temperature which will satisfy space heating, clothes washing, dish washing, and other sanitizing needs can scald and permanently injure you upon contact. Some people are more likely to be permanently injured by hot water than others. These include the elderly, children, the infirm, or physically/mentally handicapped. If anyone using hot water from this heater fits into one of these groups or if there is a local code or state law requiring a certain temperature water at the hot water tap, then you must take special precautions. In addition to using the lowest possible temperature setting that satisfies your hot water needs, a means such as a mixing valve, should be used at the hot water taps used by these people or at the water heater. Mixing valves are available at plumbing supply or hardware stores, see Figure 8. Follow manufacturer's instructions for installation of the valves. Before changing the factory setting on the thermostat, read the "Temperature Regulation" section in this manual.

Never allow small children to use a hot water tap, or to draw their own bath water. Never leave a child or handicapped person unattended in a bathtub or shower.

SETTING THE WATER HEATER TEMPERATURE AT 120°F/49°C WILL REDUCE THE RISK OF SCALDS. Some states require settings at specific lower temperatures.

The water temperature is controlled using the Temperature Control on the Display at the front of the unit (See Figure 1). This control utilizes a temperature probe to determine the tank temperature. The temperature probe is located behind the heater's front display.

The temperature may be adjusted from 90°F/32°C to 160°F/71.1°C. The temperature was preset to 120°F/49°C before the heater was shipped from the factory. It is recommended that lower water temperature be used to avoid the risk of scalding. It is further recommended, in all cases, that the water temperature be set

for the lowest temperature which satisfies your hot water needs. This will also provide the most energy efficient operation of the water heater and minimize scale formation.

Valves for reducing the point-of-use temperature by mixing cold and hot water are available, see Figure 8. Also available are inexpensive devices that attach to faucets to limit hot water temperatures. Contact a licensed plumber or the local plumbing authority.

The table below shows the approximate time-to-burn relationship for normal adult skin. Short repeated heating cycles caused by small hot water uses can cause temperatures at the point of use to exceed the thermostat setting by up to 20°F/11°C. If you experience this type of use, you should consider using lower temperature settings to reduce scald hazards.

Table 8

Water Temperature	Time to Produce 2nd & 3rd Degree Burns on Adult Skin
160° (71°C)	About 1/2 Second
150° (65°C)	About 1 1/2 Seconds
140° (60°C)	Less than 5 Seconds
130° (54°C)	More than 30 Seconds
120° (49°C)	More than 5 Minutes

HI LIMIT SWITCH (ECO)

This water heater is equipped with an ECO (energy cut out) non adjustable high temperature limit switch. The ECO is a normally closed switch that opens (activates) on a rise in temperature. The ECO is located inside the Temperature Probe (two red wires). The ECO switch contacts will open when the water temperature reaches approximately 202°F (94°C) and close at approximately 140°F (49°C).

If the ECO activates (contacts open) due to abnormally high water temperatures in the storage tank the control system will immediately de-energize the 24 VAC Gas Valve and end the current heating cycle. The control system will "lock out" disabling further heating operation. The control system will display the "Energy Cut Out (ECO)" Fault message on the LCD screen. It is important that a Qualified Service Agent be contacted to determine the reason for the ECO activation before resetting the ECO. Once the reason has been determined and corrected the ECO can be reset as follows:

Should the ECO activate, the water temperature must drop below 140°F (49°C) before the control system can be reset. Once the water temperature has cooled below this point the power supply to the water heater must be turned off and on again to reset the control system.

Contact your dealer or servicer if continued high limit switch operation occurs.

CONTROL SYSTEM OPERATION

OVERVIEW

The water heaters covered in this manual are equipped with an electronic control system that regulates water temperature inside the storage tank. Heating cycles and ignition are managed by the control system. The ECO (energy cut out), Flame Sensor, pressure switches and Temperature Probe is monitored by the control system. The Combustion Blower, Igniter and the 24 Volt Gas Valve are all energized by the control system.

The main components of the control system are a UIM (user interface module) and a CCB (central control board). The UIM is located on the top front side of the water heater. The CCB is mounted on top of the water heater inside a protective enclosure.

COMMERCIAL AND RESIDENTIAL MODELS

The water heaters covered by this manual are produced for commercial and residential use. The control system is programmed differently for commercial and residential models. There are two differences in control system operation between the residential and commercial products:

- Commercial models will display Tank Temperature on the Desktop screen, residential models will not.
- Commercial models can regulate tank temperature up to a maximum of 180°F (82°C), residential maximum is 160°F (71°C).

CONTROL SYSTEM NAVIGATION

All operational information and user settings are displayed and accessed from the UIM. The UIM houses the control system's LCD (liquid crystal display) and five snap acting (momentary) user input buttons; an up, down and three multifunction operational buttons below the LCD, see Figure 35.

USER INPUT BUTTONS

- The up and down buttons are used to navigate menus and adjust user settings.
- The operational buttons are used to enter/exit menus, select menu items, activate adjustment modes and confirm or cancel new user settings. The operational buttons are multifunctional, their current function is defined by the text that appears directly above each button on the LCD screen.

THE DESKTOP SCREEN

During normal operation the control system will display the "Desktop" screen on the LCD which is the default screen. The control system will return to the Desktop screen when there are no active Fault or Alert conditions or when there has been no user input for several minutes.

- Manufacturer and water heater model information is displayed in Title Bar at the top of the Desktop screen. Menu titles are displayed in the Title Bar when navigating the control system menus.
- The first temperature shown on the Desktop screen, Tank Temperature, is the temperature of the water inside the water heater's storage tank - commercial models only.
- The Operating Set Point is also shown on the Desktop screen. The Operating Set Point is the temperature at which the control system will maintain the water inside the storage tank.
- Beneath the Operating Set Point is the "Status" line. The Status line shows the current operational state of the control system in real time. See Table 10 for a description of the various operating states.
- The Desktop screen also displays animated "Status Icons" to convey operational information, see Table 9 for a complete list and description of the Status Icons.

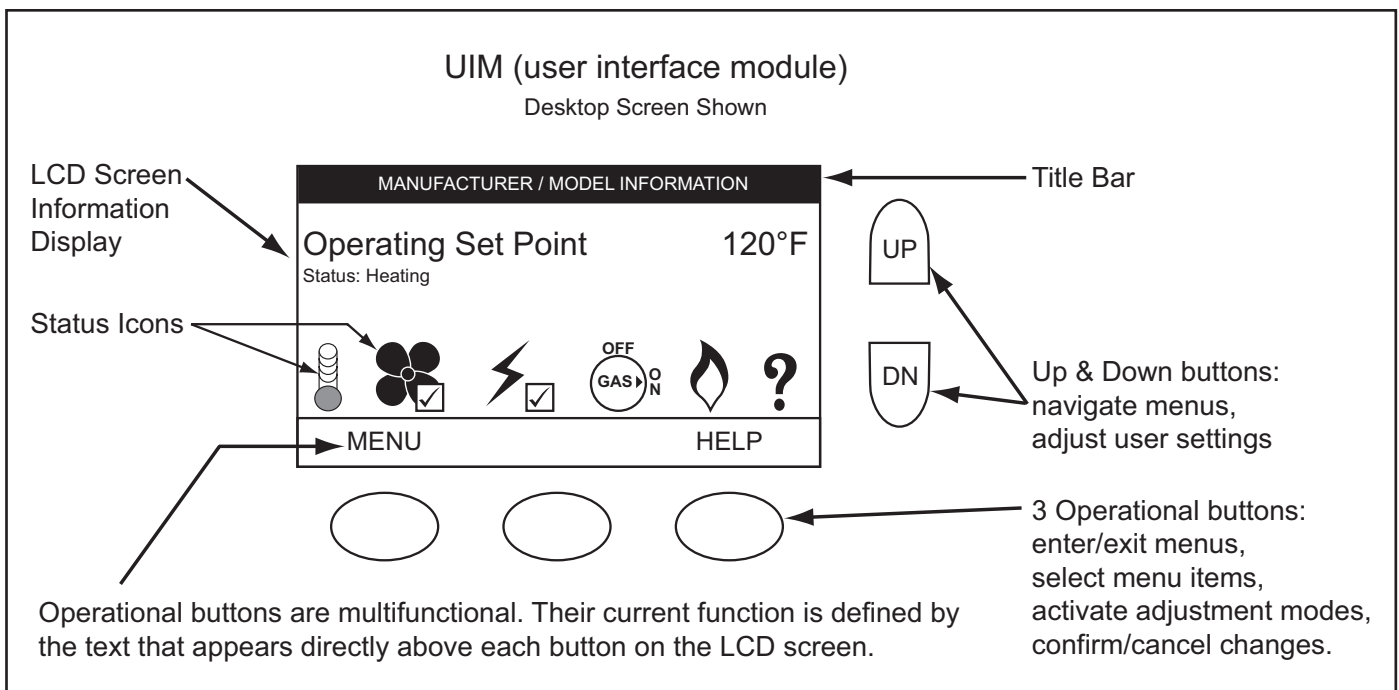













FIGURE 35.

STATUS ICONS

The Status Icons are displayed on the Desktop screen and convey operational and diagnostic information. The icons are described in the table below.

TABLE 9.

Icon	Description
	Water temperature in the tank has fallen. Shaded area of the animated thermometer icon will rise and fall in response to water temperature in the storage tank as sensed from the Temperature Probe.
	Water temperature in the tank has reached the Operating Set Point. The control system enters the Standby mode.
	The control is unable to initiate a heating cycle. This will happen whenever a Fault condition is detected by the control system.
	The Combustion Blower is being energized.
	The Blower Prover pressure switch contacts have closed. The check mark icon is visual confirmation of contact closure.
	The Igniter is being energized.
	The Igniter has been energized and the control system has sensed the required minimum igniter current. The check mark icon is visual confirmation of minimum igniter current.
	The 24 Volt Gas Valve is being energized.
	The control system has sensed flame at the Main Burner from the Flame Sensor.
	The control system has declared a Fault condition and must be inspected/serviced by a Qualified Service Agent. Fault message details can be viewed in the Current Fault menu. Heating operation is disabled (control system lock out) until the condition that caused the Fault is corrected. Power to the water heater must be cycled off and on to reset the control system. NOTE: Cycling power will not reset the control system if the condition that caused the Fault has not been corrected.
	The control system has declared an Alert condition and must be inspected/serviced by a Qualified Service Agent. The water heater will continue to operate during an Alert condition.

OPERATING STATES

The current operational state of the water heater is displayed on the Desktop screen as the "Status." The common operational states are described in the table below.

TABLE 10.

State	Description
Standby	The water heater is not in an active heating cycle. IE: the Tank Temperature is at or above the Operating Set Point.
Input Verification	The control system is conducting a diagnostic check at the beginning of a heating cycle.
Short Cycle Delay	The control system is waiting for a pre-defined time period to expire before initiating a heating cycle. This prevents "short-cycling" which can greatly accelerate wear on components such as the Igniter and Combustion Blower. NOTE: If the control system is in this operational state increase the Differential setting in the Temperatures menu to lengthen heating cycles.
Pre-Purge	The Combustion Blower is energized to flush residual flue gases from the combustion chamber prior to ignition.
Igniter Warm Up	The Igniter is energized and is currently warming up to ensure proper ignition.
Ignition Activation	The 24 Volt Gas Valve is energized and opens to allow fuel gas to flow to the Main Burner.
Ignition Verification	The control system is monitoring the Flame Sensor for the required minimum flame sensing current.
Inter-Purge	The Combustion Blower is energized to flush residual fuel gas from the combustion chamber after a failed ignition attempt.
Heating	Ignition was successful, flame sensing current has been established. The water in the storage tank is being heated.
Post-Purge	The Combustion Blower is energized to flush residual flue gases from the combustion chamber at the end of a heating cycle.
Fault	The control system has detected a Fault condition. Heating operation is disabled (control system lock out) until the Fault condition is corrected. Power to the water heater must be cycled off and on to reset the control system. NOTE: Cycling power will not reset the control system if the condition that caused the Fault has not been corrected.

CONTROL SYSTEM MENUS

From the Desktop screen pressing the Operational button directly below "Menu" on the LCD will display the "Main Menu" this is where all control system menus are located. The table below describes the control system menus.

TABLE 11.

Menu	Description
Temperatures	Most commonly accessed menu. Contains the Operating Set Point and Differential user settings.
Heater Status	This menu displays the current state of all pressure switches and the ECO (open/closed). The on/off status of the Combustion Blower, 24 Volt Gas Valve, Igniter, Flame Sensor and other monitored water heater components are displayed in this menu.
Display Settings	Temperature units (°F or °C), the LCD appearance (brightness/contrast) and backlight delay user adjustable settings are located in this menu.
Heater Information	Elapsed time of operation, total heating cycle time, heating cycle count, heating on time along with UIM and CCB software revisions can be viewed in this menu.
Current Fault	Displays any current Alert or Fault messages.
Fault History	This control system menu retains a list of the last nine (9) Fault and Alert messages with a time stamp. The newest event will replace the oldest. Fault history memory is cleared after 30 days.
Fault Occurrence	This control system menu retains a running total of how many times each Fault condition has occurred since the water heater was first installed. Fault occurrences numbers are saved in the CCB memory indefinitely. NOTE: if the CCB is replaced during service the fault occurrence historical information for the water heater is lost.
Restore Factory Defaults	This control system feature allows the user to restore control system user settings to their factory default settings. Display Settings preferences ARE NOT changed when factory defaults are restored.
Help Screens	Text based operational and user information explaining how to change user settings, navigate the control system menus and icon descriptions.

USER SETTINGS & CONTROL SYSTEM MENUS

TEMPERATURES

OPERATING SET POINT AND DIFFERENTIAL ADJUSTMENT

The Operating Set Point is adjustable from 90°F (42°C) to 180°F (82°C) for commercial and 160°F (71°C) on residential models. The factory setting is 120°F (49°C). The Differential is adjustable from 2° to 20°. The factory setting is 8°. These user settings are accessed from the Temperatures menu. These instructions explain how to adjust these settings and navigate the control system.

When the water temperature sensed by the control system from the Temperature Probe reaches the Operating Set Point the control system will end the heating cycle. A heating cycle will be activated again when the sensed water temperature drops below the Operating Set Point minus the Differential setting.

NOTE: Set the Operating Set Point to the lowest setting which produces an acceptable hot water supply for most efficient use. Lower Differential settings may cause excessive heating cycles (short-cycling) which can cause premature failure of components such as the igniter. Set the Differential at the highest setting which produces an acceptable hot water supply to prevent short cycling.

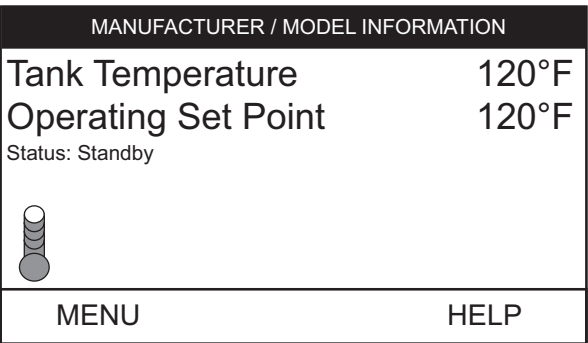
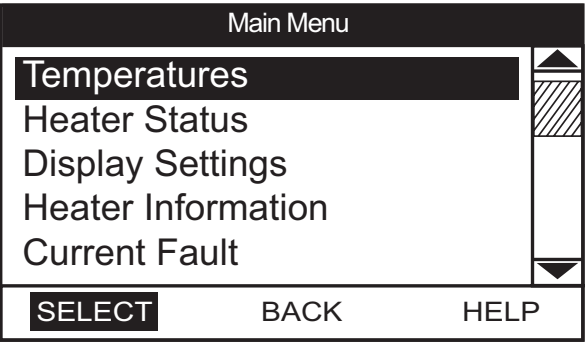
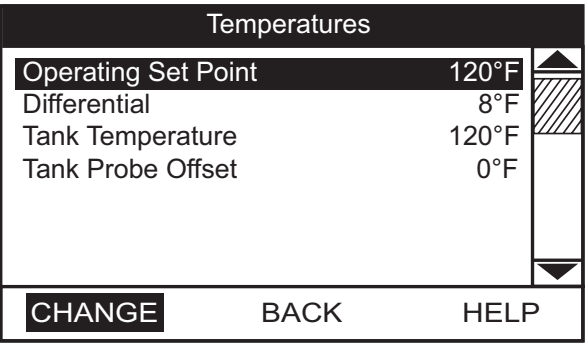
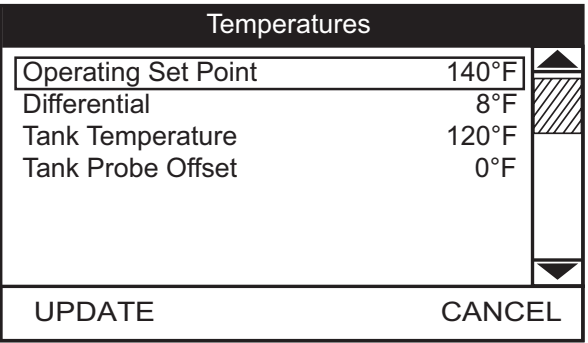
DESCRIPTION/ACTION	DISPLAY
From the Desktop screen, press the Operational Button under MENU. The "Main Menu" screen will be displayed.	
<p>The Main Menu is where all control system menus are listed, see Table 11 for a complete list and description of control system menus. Use the Up and Down Buttons to view all control system menus from the Main Menu.</p> <p>With Temperatures menu selected (highlighted in black) in the Main Menu screen, press the Operational Button under "SELECT" to enter the Temperatures menu.</p> <p>If the Temperatures menu is not selected use the Up and Down Buttons to select this menu item.</p>	
<p>With the Operating Set Point selected in the Temperatures menu, press the Operational Button underneath "CHANGE" to activate the adjustment mode for this menu item.</p> <p>If Operating Set Point is not selected use the Up and Down Buttons to select this menu item.</p> <p>NOTE: Higher Temperature settings increase wear and operating costs. Set the Operating Set Point to the lowest setting which produces an acceptable hot water supply. This will always provide the most energy efficient operation and longer life.</p>	
<p>With the adjustment mode for the Operating Set Point activated the selection bar will change from a black fill to a black outline.</p> <p>Use the Up and Down Buttons to change the current setting.</p> <p>Press the Operational Button under "UPDATE" to save the new setting. Press the Operational Button under "CANCEL" to discard changes and return to the previously saved setting.</p> <p>NOTE: Use this same procedure to change the Differential setting and other adjustable user settings in the control system menus.</p>	

TEMPERATURES (CONT)

DESCRIPTION/ACTION	DISPLAY												
<ul style="list-style-type: none"> • Tank Temperature - non adjustable - control system sensed temperature from the Temperature Probe. • Tank Probe Offset - adjustable user setting, range -5° to +5° (factory setting 0°). <p>The Tank Probe Offset is used to calibrate control system temperature sensing. This can improve the precision of temperature control in the storage tank and at points of use. This feature can also be used to compensate for building recirculation loops (hot water returning to the storage tank) that may cause the heating cycles to terminate prematurely.</p> <p>Example: If the current sensed temperature from the temperature probe is 120°F (49°C) and the Offset setting for the probe is adjusted to a value other than 0°, the control system would calibrate or "offset" the sensed temperature from the probe. Heating cycles would be activated and deactivated based on the calibrated (offset) temperature.</p> <p>NOTE: The Tank Probe Offset should only be used if the hot water supply temperature varies greatly from the Operating Set Point setting. These settings are adjusted in the same way described for the Operating Set Point and Differential Adjustment.</p>	<p style="text-align: center;">Temperatures</p> <table border="1" style="width: 100%; border-collapse: collapse;"> <tr> <td style="padding: 2px;">Operating Set Point</td> <td style="text-align: right; padding: 2px;">140°F</td> <td style="text-align: center; padding: 2px;">▲</td> </tr> <tr> <td style="padding: 2px;">Differential</td> <td style="text-align: right; padding: 2px;">8°F</td> <td style="text-align: center; padding: 2px;">▨</td> </tr> <tr> <td style="padding: 2px;">Tank Temperature</td> <td style="text-align: right; padding: 2px;">120°F</td> <td style="text-align: center; padding: 2px;">▼</td> </tr> <tr> <td style="padding: 2px;">Tank Probe Offset</td> <td style="text-align: right; padding: 2px;">0°F</td> <td style="text-align: center; padding: 2px;">▼</td> </tr> </table> <p style="text-align: center; margin-top: 5px;">CHANGE BACK HELP</p>	Operating Set Point	140°F	▲	Differential	8°F	▨	Tank Temperature	120°F	▼	Tank Probe Offset	0°F	▼
Operating Set Point	140°F	▲											
Differential	8°F	▨											
Tank Temperature	120°F	▼											
Tank Probe Offset	0°F	▼											

HEATER STATUS

DESCRIPTION/ACTION	DISPLAY																																										
<p>Select Heater Status from the Main Menu and press the Operational Button under "SELECT" to enter this menu. This menu contains non adjustable operational information. Use the Up & Down Buttons to navigate the menu.</p> <ul style="list-style-type: none"> • Status - displays the current Operating State, see Table 10 for a description of the various operational states. • ECO Contact, Blocked Inlet PS, Blocked Outlet PS, Blower Prover PS - displays the current state of the switch contacts; open or closed. • Blower Low On, Blower High On - displays whether the blower is running at high speed during Pre/Post purge and the Heating operational states or the blower is running at low speed during the Igniter Warm Up operational state; yes = blower is running at the designated speed, no = blower is not running at the designated speed. • Igniter On, Gas Valve On - displays whether or not the control system is currently energizing these water heater components; yes = energized, no = de-energized. • Igniter Current - displays whether or not the control system has detected the required minimum current. • Flame Detected - displays whether or not the control system has detected Main Burner flame during ignition from the Flame Sensor. • External Input Enable - displays whether or not the S1 dipswitches have been configured to activate the Enable/Disable circuit; yes = the Enable/Disable circuit has been activated, no = the Enable/Disable circuit has not been activated. The factory setting is "no" or deactivated. • Ignition Trials - displays whether or not the S1 dipswitches have been configured to allow 1 or 3 trials for ignition before declaring an "Ignition Failure" Fault condition. The factory setting is for 3 trials. 	<p style="text-align: center;">Top of Menu</p> <p style="text-align: center;">Heater Status</p> <table border="1" style="width: 100%; border-collapse: collapse;"> <tr> <td style="padding: 2px;">Status</td> <td style="text-align: right; padding: 2px;">Standby</td> <td style="text-align: center; padding: 2px;">▲</td> </tr> <tr> <td style="padding: 2px;">ECO Contact</td> <td style="text-align: right; padding: 2px;">Closed</td> <td style="text-align: center; padding: 2px;">▨</td> </tr> <tr> <td style="padding: 2px;">Blocked Inlet PS</td> <td style="text-align: right; padding: 2px;">Closed</td> <td style="text-align: center; padding: 2px;">▨</td> </tr> <tr> <td style="padding: 2px;">Blocked Outlet PS</td> <td style="text-align: right; padding: 2px;">Closed</td> <td style="text-align: center; padding: 2px;">▨</td> </tr> <tr> <td style="padding: 2px;">Blower Prover PS</td> <td style="text-align: right; padding: 2px;">Open</td> <td style="text-align: center; padding: 2px;">▼</td> </tr> <tr> <td style="padding: 2px;">Blower Low On</td> <td style="text-align: right; padding: 2px;">No</td> <td style="text-align: center; padding: 2px;">▼</td> </tr> <tr> <td style="padding: 2px;">Blower High On</td> <td style="text-align: right; padding: 2px;">No</td> <td style="text-align: center; padding: 2px;">▼</td> </tr> </table> <p style="text-align: center; margin-top: 5px;">BACK HELP</p> <p style="text-align: center;">Bottom of Menu</p> <p style="text-align: center;">Heater Status</p> <table border="1" style="width: 100%; border-collapse: collapse;"> <tr> <td style="padding: 2px;">Blower High On</td> <td style="text-align: right; padding: 2px;">No</td> <td style="text-align: center; padding: 2px;">▲</td> </tr> <tr> <td style="padding: 2px;">Igniter On</td> <td style="text-align: right; padding: 2px;">No</td> <td style="text-align: center; padding: 2px;">▼</td> </tr> <tr> <td style="padding: 2px;">Igniter Current</td> <td style="text-align: right; padding: 2px;">No</td> <td style="text-align: center; padding: 2px;">▼</td> </tr> <tr> <td style="padding: 2px;">Gas Valve On</td> <td style="text-align: right; padding: 2px;">No</td> <td style="text-align: center; padding: 2px;">▼</td> </tr> <tr> <td style="padding: 2px;">Flame Detected</td> <td style="text-align: right; padding: 2px;">No</td> <td style="text-align: center; padding: 2px;">▨</td> </tr> <tr> <td style="padding: 2px;">External Input Enable</td> <td style="text-align: right; padding: 2px;">No</td> <td style="text-align: center; padding: 2px;">▨</td> </tr> <tr> <td style="padding: 2px;">Ignition Trials</td> <td style="text-align: right; padding: 2px;">3</td> <td style="text-align: center; padding: 2px;">▼</td> </tr> </table> <p style="text-align: center; margin-top: 5px;">BACK HELP</p>	Status	Standby	▲	ECO Contact	Closed	▨	Blocked Inlet PS	Closed	▨	Blocked Outlet PS	Closed	▨	Blower Prover PS	Open	▼	Blower Low On	No	▼	Blower High On	No	▼	Blower High On	No	▲	Igniter On	No	▼	Igniter Current	No	▼	Gas Valve On	No	▼	Flame Detected	No	▨	External Input Enable	No	▨	Ignition Trials	3	▼
Status	Standby	▲																																									
ECO Contact	Closed	▨																																									
Blocked Inlet PS	Closed	▨																																									
Blocked Outlet PS	Closed	▨																																									
Blower Prover PS	Open	▼																																									
Blower Low On	No	▼																																									
Blower High On	No	▼																																									
Blower High On	No	▲																																									
Igniter On	No	▼																																									
Igniter Current	No	▼																																									
Gas Valve On	No	▼																																									
Flame Detected	No	▨																																									
External Input Enable	No	▨																																									
Ignition Trials	3	▼																																									

DISPLAY SETTINGS

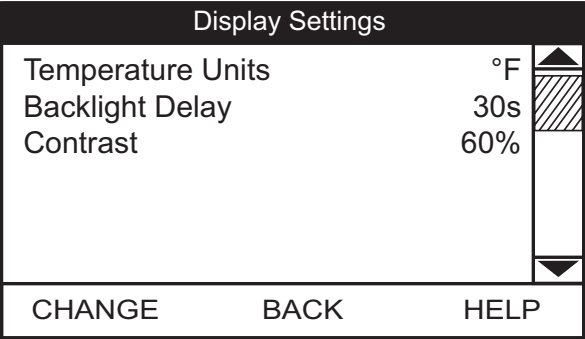
DESCRIPTION/ACTION	DISPLAY
<p>Select Display Settings from the Main Menu and press the Operational Button under "SELECT" to enter this menu. This menu contains adjustable display options for viewing information on the LCD screen. Use the Up & Down Buttons to navigate the menu.</p> <ul style="list-style-type: none"> • Temperature Units - Adjustable user setting that changes temperature units display to Celsius °C or Fahrenheit °F. • Backlight Delay - Adjustable user setting that determines how long the LCD backlight remains illuminated after a key has been pressed. Available settings are; Always Off, 10, 30 or 60 seconds and Always On. • Contrast - Adjustable user setting to adjust the LCD screen contrast between text and background. <p>NOTE: These settings are adjusted in the same way described for the Operating Set Point and Differential Adjustment.</p>	

HEATER INFORMATION

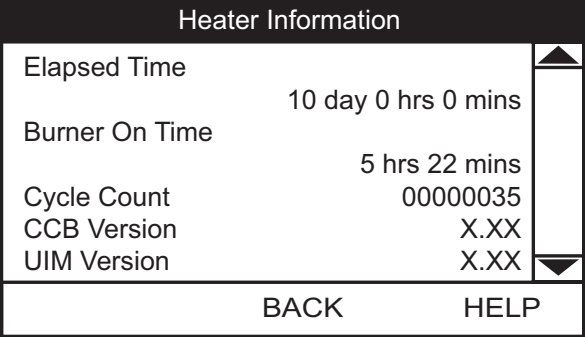
DESCRIPTION/ACTION	DISPLAY
<p>Select Heater Information from the Main Menu and press the Operational Button under "SELECT" to enter this menu. This menu contains non adjustable operational information.</p> <ul style="list-style-type: none"> • Elapsed Time - Total accumulated time the control system (water heater) has been energized. • Burner On Time - Total accumulated time the control system has been in the heating operating state; burner run time. • Cycle Count - Total accumulated count of heating cycles. • CCB Version - Software version for central control board. • UIM Version - Software version for user interface module. <p>NOTE: Historical data is stored in the CCB's memory. If this CCB is replaced during servicing the historical data on the CCB being replaced will be lost. The data stored in the new circuit board will no longer reflect the entire history of the water heater.</p> <p>The Elapsed Time, Burner On Time and Cycle Count indicate age, usage and wear.</p> <p>If the Cycle Count per day is high (divide cycle count by days to determine cycles per day) or the cycle duration is short (determine burner on time total minutes, divide burner on time total minutes by cycle count) consider raising the Differential setting to avoid short cycling and excessive component wear, see Operating Set Point and Differential Adjustment.</p> <p>This historical data can also be used to assist facilities managers in forecasting planned replacement of equipment to help avoid lengthy and costly hot water supply interruptions.</p>	

CURRENT FAULT

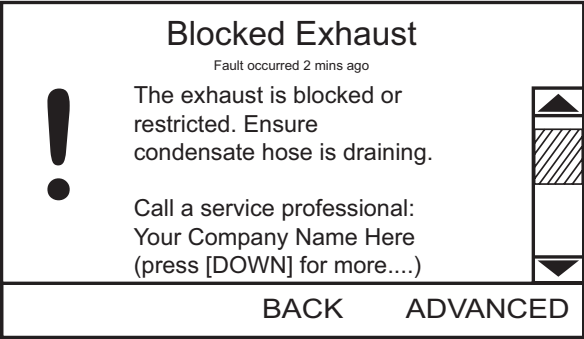
DESCRIPTION/ACTION	DISPLAY
<p>Select Current Fault from the Main Menu and press the Operational Button under "SELECT" to enter this menu. This menu contains non adjustable operational information. Use the Up & Down Buttons to navigate the menu.</p> <p>This menu contains the current Fault or Alert error message. The time the Fault or Alert message occurred appears directly below. A brief description of what causes the particular Fault or Alert condition appears below that. Pressing the Operational Button under "ADVANCED" will give more detailed service information and a list of possible causes for the Fault or Alert condition.</p> <p>If there is no Fault or Alert condition active this menu will not contain any information, "(none)" will be shown next to Current Fault in the Main menu.</p>	 <p>The display shows a large exclamation mark icon on the left. The title is "Blocked Exhaust" with a subtitle "Fault occurred 2 mins ago". The main text reads: "The exhaust is blocked or restricted. Ensure condensate hose is draining." Below this is a call to action: "Call a service professional: Your Company Name Here (press [DOWN] for more....)". On the right side, there is a vertical scroll bar with up and down arrows. At the bottom, there are two buttons: "BACK" and "ADVANCED".</p>

FAULT HISTORY

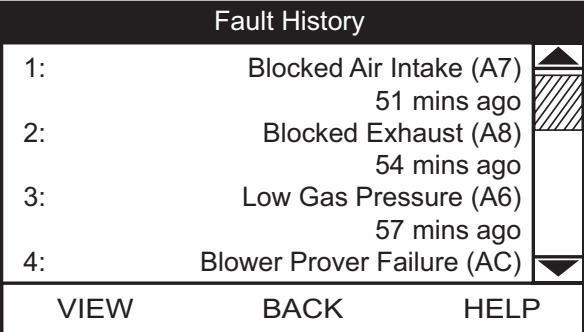
DESCRIPTION/ACTION	DISPLAY
<p>Select Fault History from the Main Menu and press the Operational Button under "SELECT" to enter this menu. This menu contains non adjustable operational information. Use the Up & Down Buttons to navigate the menu.</p> <p>This menu contains a list of the last nine (9) Fault and Alert messages with a time stamp. The newest event will replace the oldest.</p> <p>Press the Operational Button under "VIEW" to view details for each Fault or Alert message stored.</p> <p>NOTE: fault history memory is cleared after 30 days.</p>	 <p>The display shows a title "Fault History" at the top. Below it is a list of four items:</p> <ul style="list-style-type: none"> 1: Blocked Air Intake (A7) 51 mins ago 2: Blocked Exhaust (A8) 54 mins ago 3: Low Gas Pressure (A6) 57 mins ago 4: Blower Prover Failure (AC) <p>On the right side, there is a vertical scroll bar with up and down arrows. At the bottom, there are three buttons: "VIEW", "BACK", and "HELP".</p>

FAULT OCCURENCE

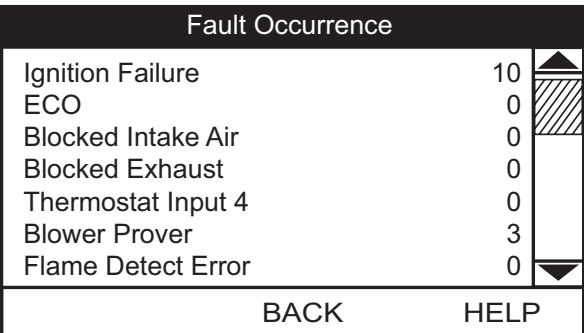
DESCRIPTION/ACTION	DISPLAY
<p>Select Fault Occurrence from the Main Menu and press the Operational Button under "SELECT" to enter this menu. This menu contains non adjustable operational information. Use the Up & Down Buttons to navigate the menu.</p> <p>This menu contains a running total of how many times each Fault condition has occurred since the water heater was first installed.</p> <p>NOTE: Historical data is stored in the CCB's memory. If this CCB is replaced during servicing the historical data on the CCB being replaced will be lost. The data stored in the new circuit board will no longer reflect the entire history of the water heater.</p>	 <p>The display shows a title "Fault Occurrence" at the top. Below it is a list of fault types and their occurrence counts:</p> <ul style="list-style-type: none"> Ignition Failure: 10 ECO: 0 Blocked Intake Air: 0 Blocked Exhaust: 0 Thermostat Input 4: 0 Blower Prover: 3 Flame Detect Error: 0 <p>On the right side, there is a vertical scroll bar with up and down arrows. At the bottom, there are two buttons: "BACK" and "HELP".</p>

RESTORE FACTORY DEFAULTS

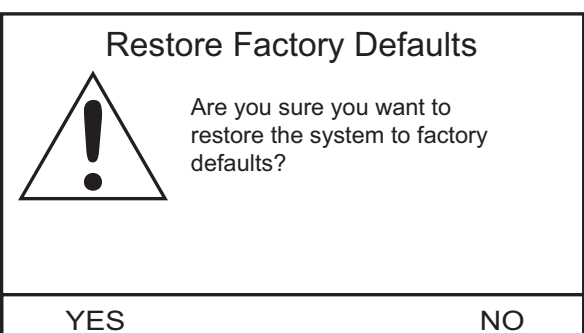
DESCRIPTION/ACTION	DISPLAY
<p>Select Restore Factory Defaults from the Main Menu and press the Operational Button under "SELECT" to enter this menu.</p> <p>To restore the adjustable user settings to their factory default settings press the Operational Button underneath "YES." The display will show text confirming the factory default settings have been restored.</p> <p>Press the Operational Button underneath "BACK" to exit the Restore Factory Defaults menu.</p>	 <p>The display shows a large warning triangle icon with an exclamation mark on the left. The title is "Restore Factory Defaults". The main text asks: "Are you sure you want to restore the system to factory defaults?". At the bottom, there are two buttons: "YES" and "NO".</p>

SERVICE CONTACT INFORMATION

The control system has a discrete menu that Installing contractors and/or service agents can access to enter contact information for their customers. This contact information will be displayed with all Fault and Alert messages.

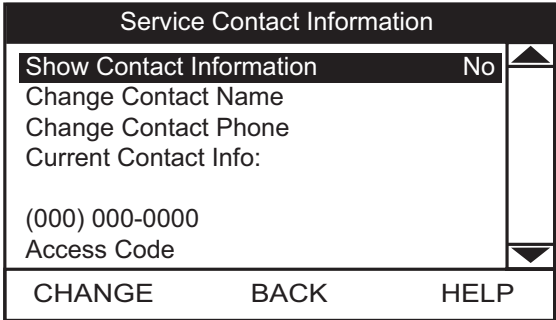
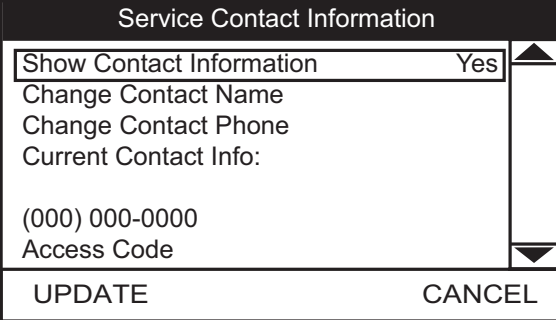
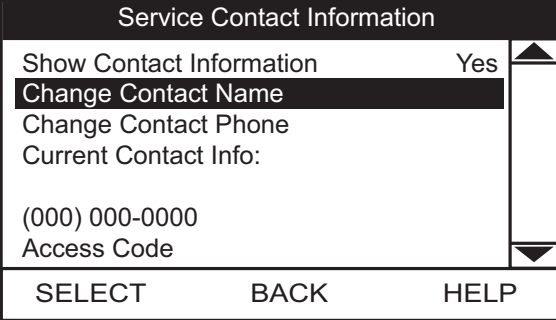
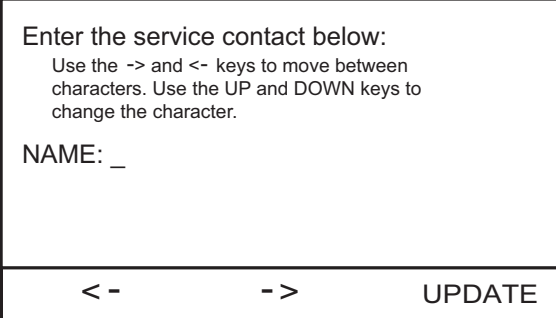
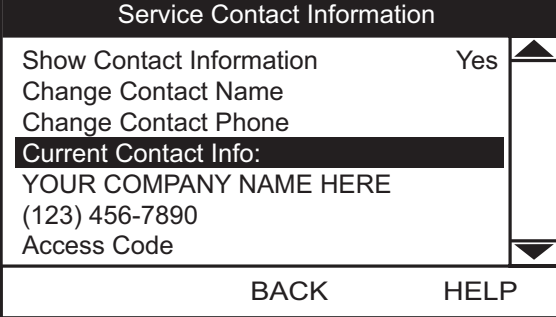
DESCRIPTION/ACTION	DISPLAY
<p>From the Desktop Screen press and hold down the middle (unmarked) Operational Button for 30 seconds and then release it. This will launch a discrete menu where personalized contact information can be entered.</p> <p>Using the UP and DOWN buttons select (highlighted in black) the "Show Contact Information" menu item.</p> <p>Press the Operational Button under "CHANGE" to activate the adjustment mode for this parameter.</p>	 <p>The screenshot shows a menu titled "Service Contact Information". The first item, "Show Contact Information", is highlighted in black and has a status of "No". Other items include "Change Contact Name", "Change Contact Phone", and "Current Contact Info:". Below these is the text "(000) 000-0000" and "Access Code". At the bottom are buttons for "CHANGE", "BACK", and "HELP".</p>
<p>With the adjustment mode for "Show Contact Information" activated the selection bar will change from a black fill to a black outline.</p> <p>Use the Up and Down Buttons to change the setting from "No" to "Yes" and press the Operational Button underneath "UPDATE" to save the new setting.</p> <p>NOTE: The Access Code at the bottom of the Service Contact Information screen is for manufacturing purposes only. There are no user settings or information accessed through this menu item.</p>	 <p>The screenshot shows the same menu as above, but the "Show Contact Information" item now has a status of "Yes" and a black outline. The "CHANGE" button has been replaced by "UPDATE", and "BACK" has been replaced by "CANCEL".</p>
<p>Using the UP and DOWN buttons select (highlighted in black) the "Change Contact Name" menu item.</p> <p>Press the Operational Button under "SELECT" to open the Change Contact Name menu.</p>	 <p>The screenshot shows the menu with "Change Contact Name" highlighted in black. The status of "Show Contact Information" is now "Yes". The "UPDATE" button has been replaced by "SELECT".</p>
<p>Follow the on screen instructions to enter your name or the name of your company. There is a maximum of 20 character spaces for this purpose.</p> <p>When finished press the Operational Button "UPDATE" to save the new Contact Name. The control system will return to the discrete menu.</p>	 <p>The screenshot shows a screen titled "Enter the service contact below:". It contains instructions: "Use the -> and <- keys to move between characters. Use the UP and DOWN keys to change the character." Below this is a label "NAME: _" followed by a blank space for input. At the bottom are buttons for "< -", "- >", and "UPDATE".</p>
<p>Using the UP and DOWN buttons select (highlighted in black) the "Change Contact Phone" menu item and press the Operational Button under "SELECT".</p> <p>Follow the on screen instructions to enter a new Contact Phone number and press the Operational Button under "UPDATE" to save the new phone number.</p> <p>When the new Contact Name and Contact Phone number have both been updated, press the Operational Button under "BACK" to return to the Desktop screen.</p>	 <p>The screenshot shows the menu with "Current Contact Info:" highlighted in black. The status of "Show Contact Information" is "Yes". The text below "Current Contact Info:" reads "YOUR COMPANY NAME HERE", "(123) 456-7890", and "Access Code". The "SELECT" button has been replaced by "BACK".</p>

FOR YOUR INFORMATION

START UP CONDITIONS

SMOKE/ODOR

It is not uncommon to experience a small amount of smoke and odor during the initial start-up. This is due to burning off of oil from metal parts, and will disappear in a short while.

THERMAL EXPANSION

CAUTION

Improper installation and use may result in property damage.

- Avoid water heater damage.
- Install thermal expansion tank or device if necessary.
- Contact qualified installer or service agency.

Water supply systems may, because of such events as high line pressure, frequent cut-offs, the effects of water hammer among others, have installed devices such as pressure reducing valves, check valves, back flow preventers, etc. to control these types of problems. When these devices are not equipped with an internal by pass, and no other measures are taken, the devices cause the water system to be closed. As water is heated, it expands (thermal expansion) and closed systems do not allow for the expansion of heated water.

The water within the water tank expands as it is heated and increases the pressure of the water system. If the relieving point of the water heater's temperature-pressure relief valve is reached, the valve will release excess pressure. The temperature-pressure relief valve is not intended for the constant relief of thermal expansion. This is an unacceptable condition and must be corrected. It is recommended that any devices installed which could create a closed system have a by-pass and/or the system have an expansion tank or device to relieve the pressure built by thermal expansion in the water system. Expansion tanks are available for ordering through a local plumbing contractor. Contact the local water heater supplier or qualified service agency for assistance in controlling these situations.

OPERATIONAL CONDITIONS

SMELLY WATER

In each water heater there is installed at least one anode rod (see Figure 1) for corrosion protection of the tank. Certain water conditions will cause a reaction between this rod and the water. The most

common complaint associated with the anode rod is one of a "rotten egg smell" in the hot water. The smell is a result of four factors which must all be present for the odor to develop:

- a. A concentration of sulfate in the supply water.
- b. Little or no dissolved oxygen in the water.
- c. A sulfate reducing bacteria which has accumulated within the water heater (this harmless bacteria is nontoxic to humans).
- d. An excess of active hydrogen in the tank. This is caused by the corrosion protective action of the anode.

Smelly water may be eliminated or reduced in some water heater models by replacing the anode(s) with one of less active material, and then chlorinating the water heater tank and all water lines. Contact the local water heater supplier or a qualified service agency for further information concerning an Anode Replacement Kit and this chlorination treatment.

If the smelly water persists after the anode replacement and chlorination treatment, we can only suggest that chlorination or aeration of the water supply be considered to eliminate the water problem.

Do not remove the anode leaving the tank unprotected. By doing so, all warranty on the water heater tank is voided.

"AIR" IN HOT WATER FAUCETS

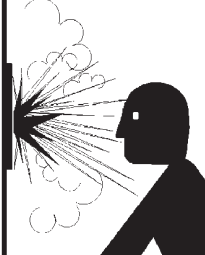

WARNING

Explosion Hazard

- Flammable hydrogen gases may be present.
- Keep all ignition sources away from faucet when turning on hot water.

HYDROGEN GAS: Hydrogen gas can be produced in a hot water system that has not been used for a long period of time (generally two weeks or more). Hydrogen gas is extremely flammable and explosive. To prevent the possibility of injury under these conditions, we recommend the hot water faucet, located farthest away, be opened for several minutes before any electrical appliances which are connected to the hot water system are used (such as a dishwasher or washing machine). If hydrogen gas is present, there will probably be an unusual sound similar to air escaping through the pipe as the hot water faucet is opened. There must be no smoking or open flame near the faucet at the time it is open.

PERIODIC MAINTENANCE

VENTING SYSTEM INSPECTION

⚠ WARNING

Breathing Hazard - Carbon Monoxide Gas



- Flue gases may escape if vent pipe is not connected.
- Be alert for obstructed, sooted or deteriorated vent system to avoid serious injury or death.
- Do not store corrosive chemicals in vicinity of water heater.
- Chemical corrosion of flue and vent system can cause serious injury or death.
- Analyze the entire vent system to make sure that condensate will not become trapped in a section of vent pipe and therefore reduce the open cross sectional area of the vent.

Breathing carbon monoxide can cause brain damage or death.
Always read and understand instruction manual.

At least once a year a visual inspection should be made of the venting system. You should look for:

1. Obstructions which could cause improper venting. The combustion and ventilation air flow must not be obstructed.
2. Damage or deterioration which could cause improper venting or leakage of combustion products.

Be sure the vent piping is properly connected to prevent escape of dangerous flue gasses which could cause deadly asphyxiation.

Obstructions and deteriorated vent systems may present serious health risk or asphyxiation.

Chemical vapor corrosion of the flue and vent system may occur if air for combustion contains certain chemical vapors. Spray can propellants, cleaning solvents, refrigerants and air conditioner refrigerants, swimming pool chemicals, calcium and sodium chloride, waxes, bleach and process chemicals are typical compounds which are potentially corrosive.

If after inspection of the vent system you found sooting or deterioration, something is wrong. Call the local gas utility to correct the problem and clean or replace the flue and venting before resuming operation of the water heater.

ANODE ROD INSPECTION

CAUTION

Property Damage Hazard

- Avoid water heater damage.
- Inspection and replacement of anode rod required.

Each water heater contains at least one anode rod, which will slowly deplete (due to electrolysis) prolonging the life of the water heater by protecting the glass-lined tank from corrosion. Adverse water quality, hotter water temperatures, high hot water usage, hydronic heating devices, and water softening methods can increase the rate of anode rod depletion. Once the anode rod is depleted, the tank will start to corrode, eventually developing a leak.

Certain water conditions will cause a reaction between the anode rod and the water. The most common complaint associated with

the anode rod is a "rotten egg smell" produced from the presence of hydrogen sulfide gas dissolved in the water. **IMPORTANT:** Do not remove this rod permanently as it will void any warranties. A special anode rod may be available if water odor or discoloration occurs. **NOTE:** This rod may reduce but not eliminate water odor problems. The water supply system may require special filtration equipment from a water conditioning company to successfully eliminate all water odor problems.

Artificially softened water is exceedingly corrosive because the process substitutes sodium ions for magnesium and calcium ions. The use of a water softener may decrease the life of the water heater tank.

The anode rod should be inspected after a maximum of three years and annually thereafter until the condition of the anode rod dictates its replacement.

NOTE: Artificially softened water requires the anode rod to be inspected annually.

The following are typical (but not all) signs of a depleted anode rod:

- The majority of the rods diameter is less than 3/8".
- Significant sections of the support wire (approx. 1/3 or more of the anode rod's length) are visible.

If the anode rod show signs of either or both it should be replaced. **NOTE:** Whether re-installing or replacing the anode rod, check for any leaks and immediately correct if found.

In replacing the anode:

1. Turn off electric supply to the water heater.
2. Shut off the water supply and open a nearby hot water faucet to depressurize the water tank.
3. Drain approximately 5 gallons of water from tank. (Refer to "Draining and Flushing" for proper procedures). Close drain valve.
4. Remove old anode rod.
5. Use Teflon® tape or approved pipe sealant on threads and install new anode rod.
6. Turn on water supply and open a nearby hot water faucet to purge air from water system. Check for any leaks and immediately correct any if found.
7. Restart the water heater as directed in this manual. See the Repair Parts Illustration for anode rod location.

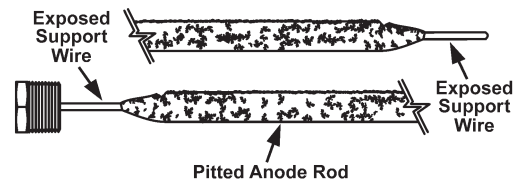
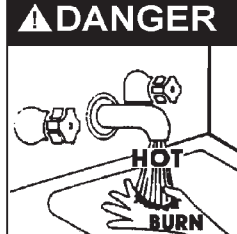

FIGURE 36.

TEMPERATURE-PRESSURE RELIEF VALVE OPERATION

⚠ DANGER



- Burn hazard.
- Hot water discharge.
- Keep clear of relief valve discharge outlet.

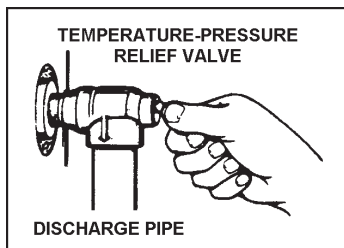

FIGURE 37.

When checking the temperature-pressure relief valve operation, make sure that (1) no one is in front of or around the outlet of the temperature-pressure relief valve discharge line, and (2) that the water discharge will not cause any property damage, as the water may be extremely hot, see Figure 37.

If after manually operating the valve, it fails to completely reset and continues to release water, immediately close the cold water inlet to the water heater, follow the draining instructions, and replace the temperature-pressure relief valve with a new one.

If the temperature-pressure relief valve on the appliance weeps or discharges periodically, this may be due to thermal expansion. You may have a check valve installed in the water line or a water meter with a check valve. Consult your local water supplier or a qualified service agency for further information. Do not plug the temperature-pressure relief valve.

DRAINING AND FLUSHING

It is recommended that the water heater storage tank be drained and flushed every 6 months to reduce sediment buildup. The water heater should be drained if being shut down during freezing temperatures. See Figure 1, Features And Components in this manual for the location of the water heater components described below.

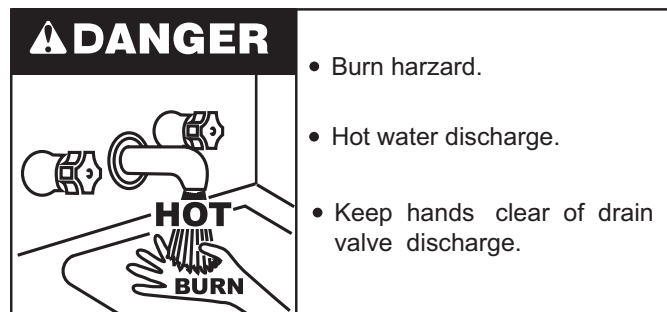

TO DRAIN THE WATER HEATER STORAGE TANK:

1. Turn off the electrical supply to the water heater.
2. Turn off the gas supply at the Main Gas Shutoff Valve if the water heater is going to be shut down for an extended period.
3. Ensure the cold water inlet valve is open.

4. Open a nearby hot water faucet and let the water run until the water is no longer hot.
5. Close the cold water inlet valve to the water heater.
6. Connect a hose to the water heater drain valve and terminate it to an adequate drain.
7. Open the water heater drain valve and allow all the water to drain from the storage tank.
8. Close the water heater drain valve when all water in the storage tank has drained.
9. Close the hot water faucet opened in Step 4.
10. If the water heater is going to be shut down for an extended period, the drain valve should be left open.

TO FLUSH THE WATER HEATER STORAGE TANK:

1. Turn off the electrical supply to the water heater.
2. Ensure the cold water inlet valve is open.
3. Open a nearby hot water faucet and let the water run until the water is no longer hot. Then close the hot water faucet.
4. Connect a hose to the drain valve and terminate it to an adequate drain.
5. Ensure the drain hose is secured before and during the entire flushing procedure. Flushing is performed with system water pressure applied to the water heater.
6. Open the water heater drain valve to flush the storage tank.
7. Flush the water heater storage tank to remove sediment and allow the water to flow until it runs clean.
8. Close the water heater drain valve when flushing is completed.
9. Remove the drain hose.
10. Fill the water heater - see Filling The Water Heater in this manual.
11. Turn on the electrical supply to place the water heater back in operation.
12. Allow the water heater to complete several heating cycles to ensure it is operating properly.

SERVICE

If a condition persists or you are uncertain about the operation of the water heater contact a qualified service agency.

Use this guide to check a "Leaking" water heater. Many suspected "Leakers" are not leaking tanks. Often the source of the water can be found and corrected.

If you are not thoroughly familiar with gas codes, your water heater, and safety practices, contact your gas supplier or qualified installer to check the water heater.

Read this manual first. Then before checking the water heater make sure the gas supply has been turned "OFF", and never turn the gas "ON" before the tank is completely full of water.

TEMPERATURE-PRESSURE RELIEF VALVE TEST

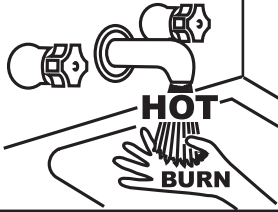
	<p>⚠ DANGER</p> <ul style="list-style-type: none"> • Burn hazard. • Hot water discharge. • Keep clear of Temperature-Pressure Relief Valve discharge outlet.
--	--

It is recommended that the Temperature-Pressure Relief Valve should be checked to ensure that it is in operating condition every 6 months.

When checking the Temperature-Pressure Relief Valve operation, make sure that (1) no one is in front of or around the outlet of the Temperature-Pressure Relief Valve discharge line, and (2) that the water discharge will not cause any property damage, as the water may be extremely hot. Use care when operating valve as the valve may be hot.

To check the relief valve, lift the lever at the end of the valve several times, see Figure 37. The valve should seat properly and operate freely.

If after manually operating the valve, it fails to completely reset and continues to release water, immediately close the cold water inlet to the water heater and drain the water heater, see Draining And Flushing on page 47. Replace the Temperature-Pressure Relief Valve with a properly rated/sized new one, see Temperature-Pressure Relief Valve on page 17 for instructions on replacement.

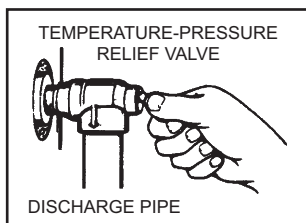

FIGURE 38.

If the Temperature-Pressure Relief Valve on the water heater weeps or discharges periodically, this may be due to thermal expansion.

NOTE: Excessive water pressure is the most common cause of Temperature-Pressure Relief Valve leakage. Excessive water system pressure is most often caused by “thermal expansion” in a “closed system.” See Closed Water Systems and Thermal Expansion on pages 15 and 16. The Temperature-Pressure Relief Valve is not intended for the constant relief of thermal expansion.

Temperature-Pressure Relief Valve leakage due to pressure build up in a closed system that does not have a thermal expansion tank installed is not covered under the limited warranty. Thermal expansion tanks must be installed on all closed water systems.

DO NOT PLUG THE TEMPERATURE-PRESSURE RELIEF VALVE OPENING. THIS CAN CAUSE PROPERTY DAMAGE, SERIOUS INJURY OR DEATH.

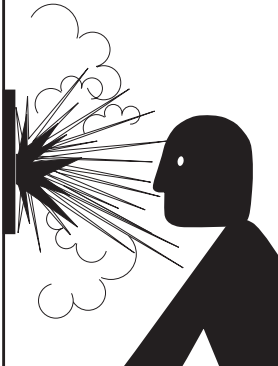
	<p>⚠ WARNING</p>
	<p style="text-align: center;">Explosion Hazard</p> <ul style="list-style-type: none"> • Temperature-Pressure Relief Valve must comply with ANSI Z21.22- CSA 4.4 and ASME code. • Properly sized temperature-pressure relief valve must be installed in opening provided. • Can result in overheating and excessive tank pressure. • Can cause serious injury or death.

LEAKAGE CHECKPOINTS

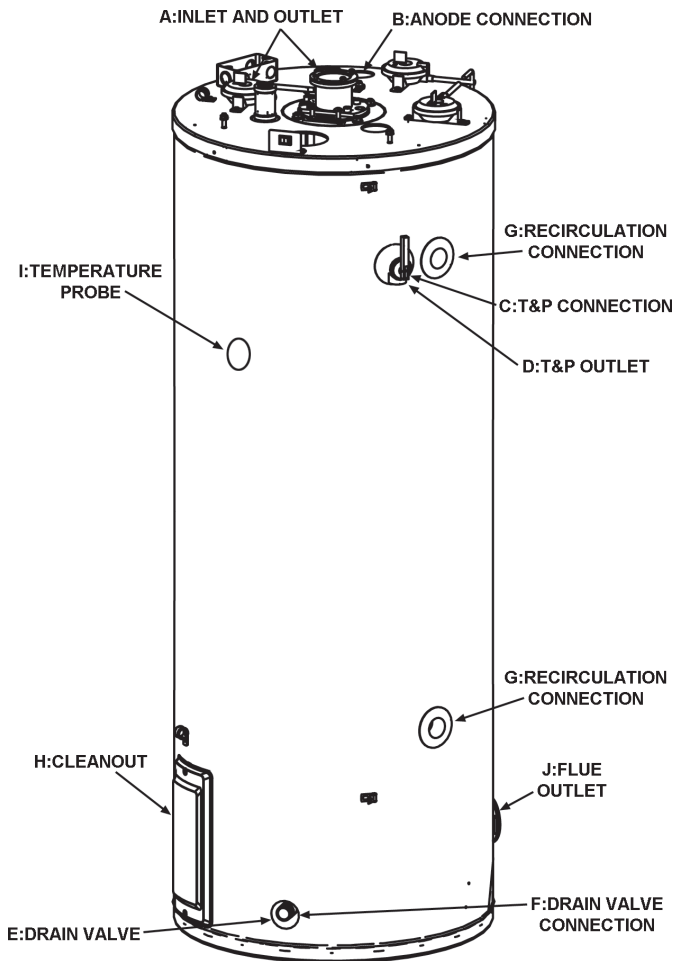
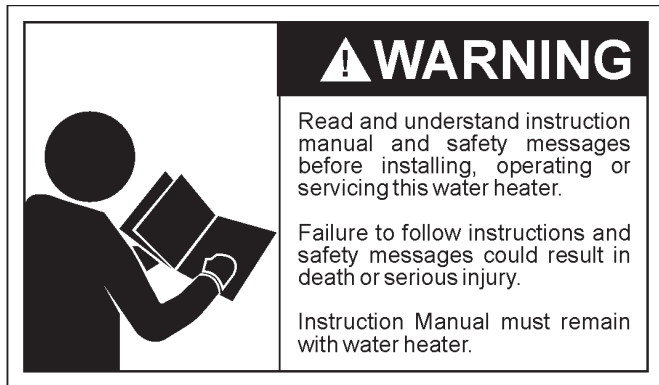

FIGURE 39.



Never use this water heater unless it is completely filled with water. To prevent damage to the tank, the tank must be filled with water. Water must flow from the hot water faucet before turning "ON" gas to the water heater.

- A. *Condensation may be seen on pipes in humid weather or pipe connections may be leaking.
- B. *The anode rod fitting may be leaking.
- C. Small amounts of water from temperature-pressure relief valve may be due to thermal expansion or high water pressure in your area.
- D. *The temperature-pressure relief valve may be leaking at the tank fitting.
- E. Water from a drain valve may be due to the valve being slightly opened.
- F. *The drain valve may be leaking at the tank fitting.
- G. Leakage from recirculation plug or pipe connection.
- H. Leakage from the plug under the cleanout cover.
- I. Leakage from the temperature probe connection.
- J. Condensate from the exhaust connection.

Leakage from other appliances, water lines, or ground seepage should also be checked.

- * To check where threaded portion enters tank, insert cotton swab between jacket opening and fitting. If cotton is wet, follow "Draining" instructions in the "Periodic Maintenance" section and then remove fitting. Put pipe dope or teflon tape on the threads and replace. Then follow "Filling the Water Heater" instructions in the "Installing the New Water Heater" section.

TROUBLESHOOTING

INSTALLATION CHECKLIST

The list below represents some of the most critical installation requirements that, when overlooked, often result in operational problems, down time and needless parts replacement. This is not a complete list. Before performing any troubleshooting procedures use the list below to check for installation errors. Costs to correct installation errors are not covered under the limited warranty. Ensure all installation requirements and instructions in this manual have been maintained and followed.

WATER HEATER LOCATION

1. Ensure proper clearances to combustibles are maintained and there is sufficient room to service the water heater.
2. Ensure the area is free of corrosive elements and flammable materials.

VENTING

3. Ensure the intake air and/or vent (exhaust) piping is the correct size for the installed length.
4. Ensure the maximum equivalent feet of pipe has not been exceeded for the intake air and/or vent pipe.
5. Ensure the maximum number of elbows has not been exceeded in the intake air and/or vent pipe.
6. Ensure all exterior clearances for the intake air, vent and concentric terminations are maintained. These clearances and those cited by local and national codes must be maintained.
7. If venting "direct vent", ensure the screen located in air intake at the water heater was removed.

GAS SUPPLY AND PIPING

8. Ensure the supply gas line to each water heater meets the minimum supply gas line size requirements.

CONDENSATE DRAIN

9. Ensure the condensate drain is properly connected to the exhaust elbow on the water heater with a water trap to prevent vent gases from escaping into the installed space and draining freely to a suitable floor drain.

ELECTRICAL CONNECTIONS

10. Ensure the power supply connections to the water heater are polarity correct.
11. Ensure the water heater is properly grounded. Flame sensing requires an adequate earth ground. If the water heater is not properly grounded it will cause Ignition Failure. Sequence Of Operation.

INSTALLATION CHECKLIST

Read the Sequence of Operation below before attempting to correct any operational problems. See the Sequence Of Operation

Flow Chart.

1. When the control system is first powered, during boot up, it will display water heater model information during initialization. After a few moments the control system LCD which is part of the UIM (user interface module) will display the default screen known as the "Desktop" screen.
2. If the control system determines that the actual water temperature inside the tank is below the programmed Operating Set Point minus the Differential setting, a heating cycle is activated.
3. The control system then performs selected diagnostic system checks. This includes confirming the blocked exhaust, blocked intake and ECO (energy cut out) switch contacts are closed. The Blower Prover Switch contacts are confirmed open.
4. If all diagnostic checks are successfully passed, the control system energizes the Combustion Blower for pre-purge.
5. The control system must confirm the Blower Prover Switch contacts close after the Combustion Blower is energized.
6. If the Blower Prover Switch contacts are confirmed closed the control system energizes the Hot Surface Igniter for the igniter warm-up period.
7. The control system monitors the igniter current and must sense a minimum of 0.6 AC amps during the igniter warm up period (10 seconds).
8. If igniter amperage is confirmed at or above the required minimum the control system energizes the 24 V Gas Valve allowing gas to flow to the Main Burner.
9. The control system de-energizes the Hot Surface Igniter.
10. The control system monitors the flame sensor to confirm a flame is present at the Main Burner. If a flame is not verified during the ignition trial period the control system will try for ignition up to two more times. If flame can not be verified after three trials for ignition, the control system will lock out and display the "Ignition Failure" Fault message.
11. If a flame is verified, the control system will enter the heating mode where it will continue heating the water until the Operating Set Point is reached. At this point, the control system will de-energize the 24 V Gas Valve and enter the post-purge cycle (60 seconds).
12. The Combustion Blower will run for the duration of the post-purge cycle to purge the water heater of all combustion gases. When the post-purge cycle is complete, the blower is de-energized and will coast to a stop.
13. The control system now enters the standby mode while continuing to monitor the internal storage tank water temperature and the state of other system devices. If the tank temperature drops below the Operating Set Point minus the Differential setting, the control will automatically return to Step 2 and repeat the operating cycle.

SEQUENCE OF OPERATION FLOW CHART

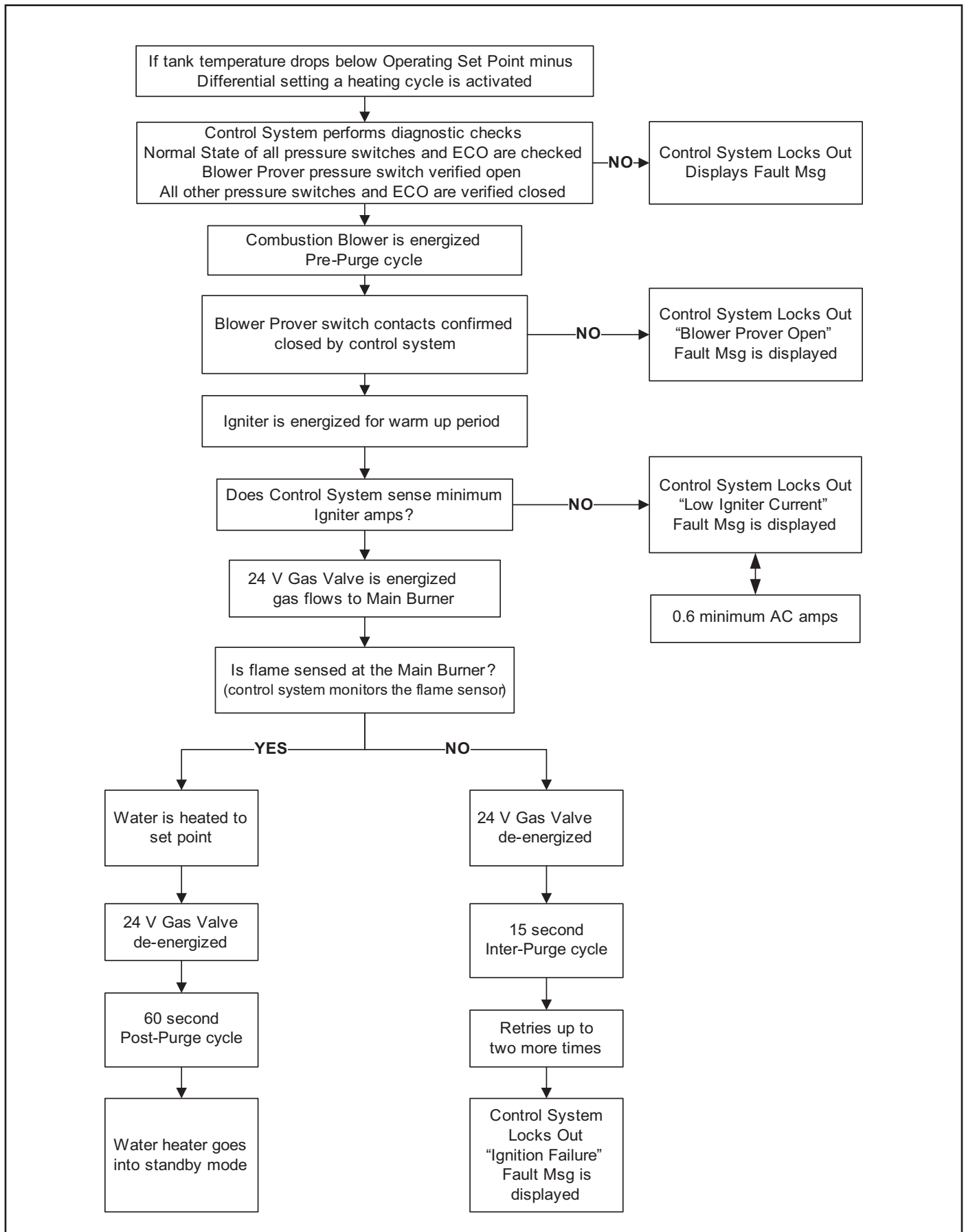

FIGURE 40.

OPERATIONAL PROBLEMS

	⚠ WARNING
	Read and understand this instruction manual and the safety messages herein before installing, operating or servicing this water heater.
	Failure to follow these instructions and safety messages could result in death or serious injury. This manual must remain with the water heater.

This section of the manual is intended to be an aid in correcting common operational problems, it is not all inclusive. The installer may be able to observe and correct certain problems which might arise when the water heater is first put into operation or when it is re-fired after a prolonged shutdown. However, only qualified service agents should perform any service procedures on the water heater.

NOTE: Call the technical support phone number listed on the back cover of this manual for further technical assistance or to locate a qualified service agent in your area.

ROUGH STARTING, ROUGH OPERATION

	⚠ WARNING
	Fire and Explosion Hazard <ul style="list-style-type: none">• Do not use water heater with any gas other than the gas shown on the rating plate.• Excessive gas pressure to gas valve can cause serious injury or death.• Turn off gas lines during installation.• Contact a qualified installer or service agency for installation and service.

- Undersized supply gas line (low volume of supply gas).
- Low Gas Pressure.
- Excessive supply gas pressure.
- Excessive manifold (offset) gas pressure.
- Incorrect Fuel Type
- Vent (exhaust) gas recirculation at the vent and intake air pipe terminations on Direct Vent installations.
- Excessive equivalent lengths of intake air and/or vent (exhaust) piping installed.
- Clogged/blocked wire screen(s).
- Clogged/blocked Main Burner.

MOMENTARY IGNITION

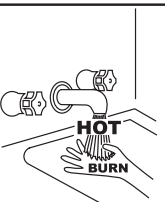
⚠ CAUTION	
Burn Hazard	
	<ul style="list-style-type: none">• The combustion chamber and burner sleeve and housing become very hot during operation.• Do not reach into the burner housing or combustion chamber if the water heater is still hot.• Allow the water heater to cool and always use gloves when handling the main burner.

If the Main Burner ignites momentarily but does not sustain ignition allow the water heater to try to ignite up to two more times until control system locks out and the Ignition Failure Fault message is displayed on the control system's LCD. If the water heater is experiencing rough starts - see Rough Starting, Rough Operation on this page. For momentary ignition problems without rough starting check the following:

- Incorrect manifold (offset) gas pressure.
- Undersized supply gas line (low volume of supply gas).
- Low Gas Pressure
- See the list of possible causes and things to check and repair for the Ignition Failure Fault message.
- Clogged/blocked wire screen(s).
- Clogged/blocked Main Burner.

NOT ENOUGH OR NO HOT WATER

- No power to the water heater, check breaker, fuses and the water heater on/off switch.
- Hot water supply valve(s) to fixtures closed.
- Operating Set Point is set too low, Differential setting is set too high.
- Temperature Probe Offset setting are causing the heating cycles to terminate prematurely.
- The heating capacity of the water heater has been exceeded, the water heater is unable to meet demand.
- Colder incoming water temperature lengthening the time required to heat water to desired temperature.
- Hot water piping leaks, open faucets, water heater drain valve leaking or open.
- Sediment or lime scale accumulation may be affecting water heater operation.

WATER IS TOO HOT

- Operating Set Point is set too high.
- Temperature Probe Offset settings improperly set.

NOISY OPERATION

- Normal operating noise of electrical components; Combustion Blower, transformer hum, relay contact closure.

REPLACEMENT PARTS

Replacement parts may be ordered from the manufacturer, authorized service agencies or distributors. When ordering parts be sure to have the complete water heater Model Number, Serial Number and Series Number available. This information can be found on the rating plate affixed to the water heater.

Refer to the parts list for more information or call the parts department or technical support phone number listed on the back cover of this manual for further assistance.

FAULT AND ALERT CONDITIONS

FAULT CONDITIONS

When the control system declares a Fault condition it will display a Fault message on the control system's LCD with an exclamation "!" mark. The control system will lock out and disable heating operation until the condition is corrected. The water heater must be serviced by a qualified service agent before operation can be restored.

ALERT CONDITIONS

When the control system declares an Alert condition it will display an Alert message on the control system's LCD with a question "?"

mark. The water heater will continue to operate during an Alert condition but the water heater must be serviced by a qualified service agent as soon as possible.

RESETTING CONTROL SYSTEM LOCK OUTS

To reset the control system from a lock out condition; turn the power supply off for approximately 20 seconds and then back on. Keep in mind; if the condition that caused the Fault has not been corrected, the control system will continue to lock out.

DIAGNOSTIC CHECKS

⚠ WARNING	
	<p style="text-align: center;">Electrical Shock Hazard</p> <ul style="list-style-type: none"> • Turn off power to the water heater before performing any service. • Label all wires prior to disconnecting when performing service. Wiring errors can cause improper and dangerous operation. • Verify proper operation after servicing. • Failure to follow these instructions can result in personal injury or death.



The following section, Fault And Alert Messages lists some of the messages the control system will display on the LCD when there are operational problems. This is not a complete list. Along with each of the Fault and Alert messages described there will be a list of possible causes and things to check and repair.

Only qualified service agents, as defined in Qualifications using appropriate test equipment, should perform any service procedures on the water heater.

NOTE: If you are not qualified and licensed or certified as required by the authority having jurisdiction to perform a given task do not attempt to perform any of the diagnostic or service procedures described in the following section.

If you do not understand the instructions in the following section do not attempt to perform any procedures.

Call the technical support phone number listed on the back cover of this manual for further technical assistance or to locate a qualified service agent in your area.

⚠ WARNING	
<p>Jumping out control circuits or components can result in property damage, personal injury or death.</p>	
<ul style="list-style-type: none"> • Service should only be performed by a qualified service agent using proper test equipment. • Altering the water heater controls and/or wiring in any way could result in permanent damage to the controls or water heater and is not covered under the limited warranty. • Altering the water heater controls and/or wiring in any way could result in altering the ignition sequence allowing gas to flow to the main burner before the hot surface igniter is at ignition temperature causing delayed ignition which can cause a fire or explosion. 	
	<p>Any bypass or alteration of the water heater controls and/or wiring will result in voiding the appliance warranty.</p>
	









FAULT AND ALERT MESSAGES

Call the technical support phone number listed on the back cover for further technical assistance or to locate a qualified service agent in your area.

POSSIBLE CAUSES - CHECK/REPAIR	DISPLAYED FAULT/ALERT MESSAGE
<ul style="list-style-type: none"> The water heater's control system is polarity sensitive and will lock out and disable heating operation if the polarity of the power supply is reversed. The control system will display the "AC Reversed" Fault message on the LCD in this condition. <p>NOTE: Electronic flame sensing requires correct power supply polarity AND a proper earth ground to the water heater and the Main Burner. The control system does not verify earth ground but this should be checked first if ignition failure occurs. See the Ignition Failure Fault message information below.</p>	<div style="border: 1px solid black; padding: 10px;"> <p style="text-align: center;">AC Reversed</p> <p style="text-align: center; font-size: small;">Fault occurred 2 mins ago</p> <div style="display: flex; justify-content: space-between; align-items: center;"> <div style="text-align: center;"> <p>Power supply to water heater has reversed polarity.</p> </div> </div> <div style="text-align: center; margin-top: 10px;"> <p>Call a service professional: Your Company Name Here (press [DOWN] for more....)</p> </div> <div style="border-top: 1px solid black; text-align: center; padding-top: 5px;"> BACK ADVANCED </div> </div>
<ul style="list-style-type: none"> The control system has failed to ignite the Main Burner. Water heater is not properly grounded, loose or open ground wire to the Main Burner. Dirty/corroded flame sensor, clean flame sensor with fine steel wool (replace if damaged). Loose or open wiring to the flame sensor. Loose or open wiring to the 24 V Gas Valve. Supply gas turned off, low gas volume. Intake air and/or vent piping is restricted or improperly installed. Low or no manifold gas pressure to the Main Burner. 	<div style="border: 1px solid black; padding: 10px;"> <p style="text-align: center;">Ignition Failure</p> <p style="text-align: center; font-size: small;">Fault occurred 2 mins ago</p> <div style="display: flex; justify-content: space-between; align-items: center;"> <div style="text-align: center;"> <p>The water heater has failed to ignite the burner.</p> </div> </div> <div style="text-align: center; margin-top: 10px;"> <p>Call a service professional: Your Company Name Here (press [DOWN] for more....)</p> </div> <div style="border-top: 1px solid black; text-align: center; padding-top: 5px;"> BACK ADVANCED </div> </div>
<ul style="list-style-type: none"> The control system has detected low current (AC amps) from the Hot Surface Igniter. The control system monitors igniter current and will declare this Fault condition if the current is not at or above the programmed minimum requirement. Loose or open wiring to the Hot Surface Igniter. Damaged, worn or open circuit Hot Surface Igniter. <p>NOTE: Hot surface igniters are wearing parts. Wear is directly related to heating cycle count. Heating cycle count can be viewed in the Heater Information menu. Increasing the Differential setting reduces heating cycle count.</p>	<div style="border: 1px solid black; padding: 10px;"> <p style="text-align: center;">Low Igniter Current</p> <p style="text-align: center; font-size: small;">Fault occurred 2 mins ago</p> <div style="display: flex; justify-content: space-between; align-items: center;"> <div style="text-align: center;"> <p>Igniter current is low.</p> </div> </div> <div style="text-align: center; margin-top: 10px;"> <p>Call a service professional: Your Company Name Here (press [DOWN] for more....)</p> </div> <div style="border-top: 1px solid black; text-align: center; padding-top: 5px;"> BACK ADVANCED </div> </div>
<ul style="list-style-type: none"> The control system has detected the Blocked Exhaust Switch contacts are open. The condensate drain is blocked filling the exhaust elbow with water - clear the condensate drain. Loose or open wiring to the Blocked Exhaust Switch. Restricted/blocked vent piping - condensate trapped in low point. Excessive equivalent pipe length, exceeded the maximum number of 90° elbows or wrong pipe size used in the vent piping system. Excessive wind outdoors pressurizing the vent system piping. Excessive negative air pressure in the installed space. 	<div style="border: 1px solid black; padding: 10px;"> <p style="text-align: center;">Blocked Exhaust</p> <p style="text-align: center; font-size: small;">Fault occurred 2 mins ago</p> <div style="display: flex; justify-content: space-between; align-items: center;"> <div style="text-align: center;"> <p>The exhaust is blocked or restricted. Ensure condensate hose is draining.</p> </div> </div> <div style="text-align: center; margin-top: 10px;"> <p>Call a service professional: Your Company Name Here (press [DOWN] for more....)</p> </div> <div style="border-top: 1px solid black; text-align: center; padding-top: 5px;"> BACK ADVANCED </div> </div>

FAULT AND ALERT MESSAGES (CONT)

Call the technical support phone number listed on the back cover for further technical assistance or to locate a qualified service agent in your area.

POSSIBLE CAUSES - CHECK/REPAIR	DISPLAYED FAULT/ALERT MESSAGE
<ul style="list-style-type: none"> The control system has detected the Blower Prover Switch contacts are closed when they should be open at the beginning of a heating cycle. Pinched/shorted Blower Prover Switch wiring. Jumper wire connected to the Blower Prover Switch - remove jumper wire. Jumper wires must never be used, read all Warnings. Excessive wind outdoors pressurizing the vent system piping. Excessive negative air pressure in the installed space. 	<div style="border: 1px solid black; padding: 10px;"> <p style="text-align: center;">Blower Prover Failure</p> <p style="text-align: center; font-size: small;">Fault occurred 2 mins ago</p> <div style="display: flex; justify-content: space-between;">  <div style="text-align: center;"> <p>The blower prover switch is closed out of sequence.</p> <p>Call a service professional: Your Company Name Here (press [DOWN] for more....)</p> </div>  </div> <div style="text-align: center; border-top: 1px solid black; margin-top: 5px;"> BACK ADVANCED </div> </div>
<ul style="list-style-type: none"> The control system has detected the Blower Prover Switch contacts are remaining open after the control system has energized the Combustion Blower. Loose or open wiring to the Blower Prover Switch. Blower Prover Switch air sensing tube disconnected, kinked, filed with condensate, damaged or leaking - repair or replace tube. Combustion Blower is not running when energized. Loose or open wiring to Combustion Blower. 	<div style="border: 1px solid black; padding: 10px;"> <p style="text-align: center;">Blower Prover Open</p> <p style="text-align: center; font-size: small;">Fault occurred 2 mins ago</p> <div style="display: flex; justify-content: space-between;">  <div style="text-align: center;"> <p>The blower prover switch remains open after the blower has been energized.</p> <p>Call a service professional: Your Company Name Here (press [DOWN] for more....)</p> </div>  </div> <div style="text-align: center; border-top: 1px solid black; margin-top: 5px;"> BACK ADVANCED </div> </div>
<ul style="list-style-type: none"> The control system has detected the Blocked Intake Air Switch contacts are open. Loose or open wiring to the Blocked Intake Air Switch. Excessive equivalent pipe length, exceeded the maximum number of 90° elbows or wrong pipe size used in the intake air piping system. Excessive negative air pressure in the installed space. 	<div style="border: 1px solid black; padding: 10px;"> <p style="text-align: center;">Blocked Air Intake</p> <p style="text-align: center; font-size: small;">Fault occurred 2 mins ago</p> <div style="display: flex; justify-content: space-between;">  <div style="text-align: center;"> <p>The combustion air intake is restricted.</p> <p>Call a service professional: Your Company Name Here (press [DOWN] for more....)</p> </div>  </div> <div style="text-align: center; border-top: 1px solid black; margin-top: 5px;"> BACK ADVANCED </div> </div>
<ul style="list-style-type: none"> The control system has detected the ECO (energy cut out) Switch contacts are open. The ECO switch is a normally closed switch that opens on a temperature rise to prevent excessive water temperature in the storage tank. The ECO switch is inside the Temperature Probe (two red wires). Loose or open wiring to the ECO switch in the Temperature Probe - two red wires. 	<div style="border: 1px solid black; padding: 10px;"> <p style="text-align: center;">Energy Cut Out (ECO)</p> <p style="text-align: center; font-size: small;">Fault occurred 2 mins ago</p> <div style="display: flex; justify-content: space-between;">  <div style="text-align: center;"> <p>Tank temperature is excessive. The water heater has been disabled.</p> <p>Call a service professional: Your Company Name Here (press [DOWN] for more....)</p> </div>  </div> <div style="text-align: center; border-top: 1px solid black; margin-top: 5px;"> BACK ADVANCED </div> </div>

NOTES

NOTES

NOTES

LIMITED RESIDENTIAL GAS WARRANTY

THIS WARRANTY IS APPLICABLE TO THE ORIGINAL OWNER ONLY. If the glass lined tank in this water heater shall prove upon examination by (the warrantor) to have leaked during the warranty period in normal residential use, due to natural corrosion from potable water therein, the warrantor will furnish the ORIGINAL OWNER a replacement water heater of equivalent size and current model, or a replacement part for any component part which fails in normal use, in accordance with the warranty terms and conditions specified below. THE WATER HEATER REPLACEMENT MODEL OR PART WILL BE WARRANTED FOR ONLY THE UNEXPIRED PORTION OF THE ORIGINAL WARRANTY. The warranty period will be determined by the original installation date of the water heater. PROOF-OF-PURCHASE AND PROOF-OF-INSTALLATION ARE NECESSARY TO VALIDATE THIS WARRANTY. This warranty is not transferable.

WARRANTY PERIOD		
Product Line	TANK ¹	PARTS ²
VG6250T100NV	6 YEARS	6 YEARS
VG6250T100PV	6 YEARS	6 YEARS

When the water heater has been used for other than single family residential application: 1. The Tank warranty shall be reduced to 3 years on 10 year models and 1 year on 6 and 8 year models. 2. The parts warranty shall be reduced to 1 year for all models. Returned parts which meet any of the following conditions are not covered by this warranty: 1) improper installation or removal; 2) damaged by other than normal wear; 3) replaced for cosmetic purposes; or 4) returned with defaced date codes.

CONDITIONS AND EXCEPTIONS

This warranty shall apply only when the water heater is installed and operated in accordance with: 1) all local fire codes and plumbing codes, ordinances and regulations; 2) the printed instructions provided with it; 3) good industry practices; and 4) proper safety practices such as but not limited to a properly sized drain pan if installed in an area where leakage from connections of the tank would result in damage to the area adjacent to the heater. In addition, a new temperature and pressure relief valve, certified by the Canadian Standards Association must have been properly installed and piped to the nearest drain.

This warranty shall apply only when the heater is:

- owned by the original purchaser;
- used at temperatures not exceeding the maximum calibrated setting of its thermostat;
- not subjected to excessive water pressure fluctuations and not subject to an operating pressure greater than 150 P.S.I.;
- filled with potable water, free to circulate at all times and with the tank free of damaging water sediment or scale deposits;
- used in a non-corrosive and non-contaminated atmosphere;
- used with factory approved anode(s) installed;
- in its original installation location;
- in the United States and its territories or possessions or Canada;
- sized in accordance with proper sizing techniques for residential water heaters;
- bearing a rating plate which has not been altered, defaced or removed except as required by the warrantor;
- used in an open system or in a closed system with a properly sized and installed thermal expansion tank;
- fired at the factory rated input using the fuel stated in the face of the rating plate;
- operated with inner and outer combustion chamber doors in place;
- maintained in accordance with the instructions printed in the manual included with the heater.

Any accident to the water heater or any part thereof (including freezing, fire, floods, or lightning), any misuse, abuse or alteration of it, any operation of it in a modified form, or any attempt to repair tank leaks or parts, will void this warranty.

SERVICE AND LABOR RESPONSIBILITY

UNDER THIS LIMITED WARRANTY, THE WARRANTOR WILL PROVIDE ONLY A REPLACEMENT WATER HEATER OR PART THEREOF. THE OWNER IS RESPONSIBLE FOR ALL OTHER COSTS. Such costs may include but are not limited to:

- Labor charges for service, removal, or reinstallation of the water heater or part thereof.

- Shipping and delivery charges for forwarding the new water heater or replacement part from the nearest distributor and returning the claimed defective heater or part to such distributor except in the state of California where such charges are the manufacturer's responsibility.
- All cost necessary or incidental for handling and administrative charges, and for any materials and/or permits required for installation of the replacement heater or part.

LIMITATION ON IMPLIED WARRANTIES

Implied warranties, including any warranty of merchantability imposed on the sale of this heater under state law are limited to one year duration for the heater or any of its parts. Some states do not allow limitations on how long an implied warranty lasts, so the above limitations may not apply to you.

CLAIM PROCEDURE

Any claim under this warranty should be initiated with the dealer who sold the heater, or with any other dealer handling the warrantor's products.

The warrantor will only honor replacement with identical or similar water heater or parts thereof which are manufactured or distributed by the warrantor.

Dealer replacements are made subject to in-warranty validation by warrantor.

PROOF-OF-PURCHASE AND PROOF-OF-INSTALLATION DATES ARE REQUIRED TO SUPPORT WARRANTY FOR CLAIM FROM ORIGINAL OWNER. THIS FORM DOES NOT CONSTITUTE PROOF-OF-PURCHASE OR PROOF-OF-INSTALLATION.

DISCLAIMERS

NO EXPRESS WARRANTY HAS BEEN OR WILL BE MADE IN BEHALF OF THE WARRANTOR WITH RESPECT TO THE MERCHANTABILITY OF THE HEATER OR THE INSTALLATION, OPERATION, REPAIR OR REPLACEMENT OF THE HEATER OR PARTS. THE WARRANTOR SHALL NOT BE RESPONSIBLE FOR WATER DAMAGE, LOSS OF USE OF THE UNIT, INCONVENIENCE, LOSS OR DAMAGE TO PERSONAL PROPERTY, OR OTHER CONSEQUENTIAL DAMAGE. THE WARRANTOR SHALL NOT BE LIABLE BY VIRTUE OF THIS WARRANTY OR OTHERWISE FOR DAMAGE TO ANY PERSONS OR PROPERTY, WHETHER DIRECT OR INDIRECT, AND WHETHER ARISING IN CONTRACT OR IN TORT.

Some states do not allow the limitation or exclusion of incidental or consequential damages, so the above limitation or exclusion may not apply to you.

This warranty gives you specific legal rights, and you may also have other rights which vary from state to state. Should governmental regulations or industry standards prohibit the Manufacturer from furnishing a comparable model replacement under this warranty, the Owner will be furnished with the closest comparable water heater meeting the current governmental regulations and industry standards. A supplementary fee may be assessed to cover the additional cost associated with the changes made to meet applicable regulations and standards.

Fill out and keep with water heater.

IMPORTANT INFORMATION

Model Number	_____
Serial Number	_____
Installation Information:	
Date Installed	_____
Company's Name	_____
Street or P.O. Box	_____
City, State, and Zip Code	_____
Phone Number	_____
Plumber's Name	_____



www.americanwaterheater.com

American Water Heater
Product Service and Support
PO Box 1597, 500 Princeton Road
Johnson City, TN 37605

Free Manuals Download Website

<http://myh66.com>

<http://usermanuals.us>

<http://www.somanuals.com>

<http://www.4manuals.cc>

<http://www.manual-lib.com>

<http://www.404manual.com>

<http://www.luxmanual.com>

<http://aubethermostatmanual.com>

Golf course search by state

<http://golfingnear.com>

Email search by domain

<http://emailbydomain.com>

Auto manuals search

<http://auto.somanuals.com>

TV manuals search

<http://tv.somanuals.com>