

# TEXT TELEPHONE

---

## Q90™

## Operating Instructions

English



## IMPORTANT SAFETY INSTRUCTIONS

When using your telephone equipment, always follow basic safety precautions to reduce the risk of fire, electric shock, and injury to persons, including the following:

1. Read and understand all instructions. Observe all warnings and other markings on the product.
2. During thunderstorms, avoid using telephones except cordless models. There may be a slight chance of electric shock from lightning.
3. Do not use a telephone near a gas leak. If you suspect a gas leak, report it immediately, but use a telephone away from the area where gas is leaking.
4. Do not use this product near water, or when you are wet. For example, do not use it in a wet basement or shower, or next to a swimming pool, bathtub, kitchen sink or laundry tub. Do not use liquids or aerosol sprays for cleaning. If the product comes in contact with any liquids, unplug any line or power cord immediately. Do not plug the product back in until it has dried thoroughly.
5. Install this product in a protected location where no one can trip over any line or power cord. Protect cords from damage or abrasion.
6. If this product does not operate normally, read "In Case of Difficulty" section. If you cannot resolve the problem, or if the product is damaged, refer to the Ameriphone Warranty. Do not open this product except as may be directed in this owner's manual. Opening this product or reassembling it incorrectly may expose you to hazardous voltage or other risks. Opening this product automatically voids the warranty.
7. If this product uses batteries as power back-up during power outages, replace batteries only as described in this owner's manual. Do not burn or puncture used batteries — they contain caustic chemicals.
8. Unplug this product from the wall outlet and refer servicing to qualified service personnel under the following conditions:
  - A. When the power supply cord or plug is damaged or frayed.
  - B. If liquid has been spilled on the product.
  - C. If the product has been exposed to rain or water.
  - D. If the product does not operate normally by following the operating instructions. Adjust only those controls that are covered by the operating instructions because improper adjustment of other controls may result in further damage.
  - E. If the product has been dropped or appears damaged.
  - F. If the product exhibits a distinct change in performance.
9. If this product has a polarized plug with one wide prong, it may not fit in non-polarized outlets. Do not defeat the purpose of these plugs. If they do not fit in your outlet, the outlet should be replaced by an electrician.

## ADDITIONAL SAFETY NOTES FOR CANADIAN USERS

**NOTICE:** The Canadian Department of Communications label identifies certified equipment. This certification means that the equipment meets certain telecommunications network protective, operational and safety requirements. The department does not guarantee the equipment will operate to the user's satisfaction.

Before installing the equipment, users should ensure that it is permissible to be connected to the facilities of the local telecommunications company. The equipment must also be installed using an acceptable method of connection. The customer should be aware that compliance with the above conditions may not prevent degradation of service in some situations. Repairs to certified equipment should be made by an authorized Canadian maintenance facility designated by the supplier. Any repairs or alteration made by the user to this equipment, or equipment malfunctions, may give the telecommunications company cause to request the user to disconnect the equipment.

Users should ensure for their own protection that the electrical ground connections of the power utility, telephone lines and internal metallic water pipe system, if present, are connected together. This precaution may be particularly important in rural areas.

**CAUTION:** Users should not attempt to make such connections themselves, but should contact the appropriate electric inspection authority, or electrician, as soon as possible.

**NOTICE:** The LOAD NUMBER (LN) assigned to each terminal device denotes the percentage of the total load to be connected to a telephone loop which is used by the device, to prevent overloading. The termination on a loop may consist of any combination of devices subject only to the requirement that the sum of the load numbers of all devices does not exceed 100.

**SAVE THESE INSTRUCTIONS**

# TABLE OF CONTENTS

<b>CHAPTER 1: INTRODUCTION</b>	2
<b>CHAPTER 2: PACKAGE CHECKLIST</b>	3
<b>CHAPTER 3: FEATURES IDENTIFICATION</b>	4
A. Primary Functions	5
B. Secondary Functions	6
<b>CHAPTER 4: INSTALLATION</b>	7
A. Power Connection	7
B. Direct Phone Line Connection	7
C. Telephone Connection	7
D. Cellular Phone and Cordless Phone Connection	8
<b>CHAPTER 5: SETTING UP YOUR Q90 TTY</b>	8
A. Adding Names and Numbers to the Phone Directory	8
B. Personalized Msg 1 & Msg 2	9
C. Factory Preset Modes of Operation	9
D. Changing Menu Mode Settings (Includes Answering Machine)	9
E. Changing Other Settings	12
<b>CHAPTER 6: OPERATING YOUR Q90 TTY</b>	12
A. Making a Phone Call (Direct Connect)	12
B. Making a Phone Call (Cellular Phone or Cordless Phone)	14
C. <i>Hi-Speed™</i> Transmission	15
D. Transfer	15
E. Printing a Conversation	15
F. VCO ( Voice Carry Over ) Calls	16
G. HCO ( Hearing Carry Over ) Calls	17
H. Lock	18
I. Useful Tips	18
<b>CHAPTER 7: GLOSSARY OF PRIMARY FUNCTIONS</b>	19
<b>GLOSSARY OF SECONDARY FUNCTIONS</b>	20
<b>CHAPTER 8: GLOSSARY OF MENU MODE SETTINGS</b>	22
<b>CHAPTER 9: TROUBLE SHOOTING</b>	23
<b>CHAPTER 10: MAINTENANCE INFORMATION</b>	24
<b>CHAPTER 11: TTY USER'S ETIQUETTE</b>	25
<b>CHAPTER 12: WARRANTY INFORMATION</b>	26
<b>CHAPTER 13: REPAIR INFORMATION</b>	27
<b>CHAPTER 14: FCC REGISTRATION</b>	27
<b>CHAPTER 15: SPECIFICATIONS</b>	28
<b>CHAPTER 16: OTHER AMERIPHONE PRODUCTS</b>	28
<b>CHAPTER 17: AVAILABLE OPTIONAL ACCESSORIES</b>	29
<b>INDEX</b>	30

## CHAPTER 1 INTRODUCTION

Thank you for selecting your new Q90 Text Telephone (TTY) from AMERIPHONE Inc. It has been designed to meet the highest quality standards in order to provide you with years of convenient and trouble free service.

Please read these operation instructions thoroughly before using your Q90. Keep this manual for future reference.

You must save your sales receipt as proof of purchase in the event that you need warranty service. Mail in your Product Registration Card within ten days. Although registration is not required for warranty service, the information you provide will allow us to contact you with any new developments about your Q90's operation. Your Q90 comes with a one year warranty.

Throughout this manual, special characters are used to denote a key on the keyboard or text displayed on the Q90 screen. For example, **Return** represents the return key on the keyboard. **Dialing** means the word DIALING is displayed on the Q90 screen.

**Q90 Keyboard:** The following special keys are not presently functional in Baudot mode of transmission: @, %, ^, &, \*, \_, < and >.

If you have any questions about your Q90 TTY, please call our Customer Relations Department at (800) 772-2889, (714) 897-1111 (TTY) or (800) 874-3005, (714) 897-0808 (Voice).

## CHAPTER 2 PACKAGE CHECKLIST

Your Q90 TTY package should contain the following items:

Q90 TTY	AC Adapter
Phone Cord	Cell Cord
Operating Instructions	Quick Guide
Six NiCad Rechargeable Batteries	

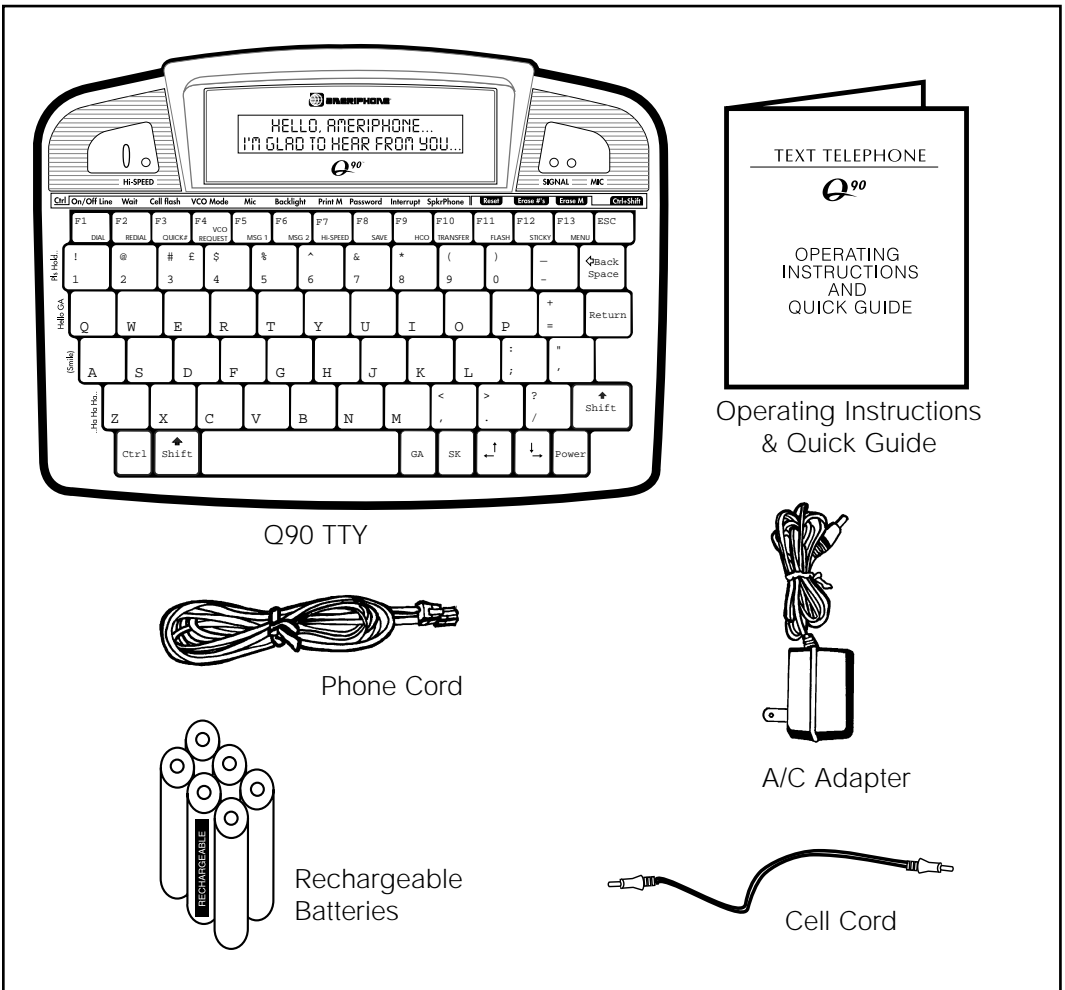
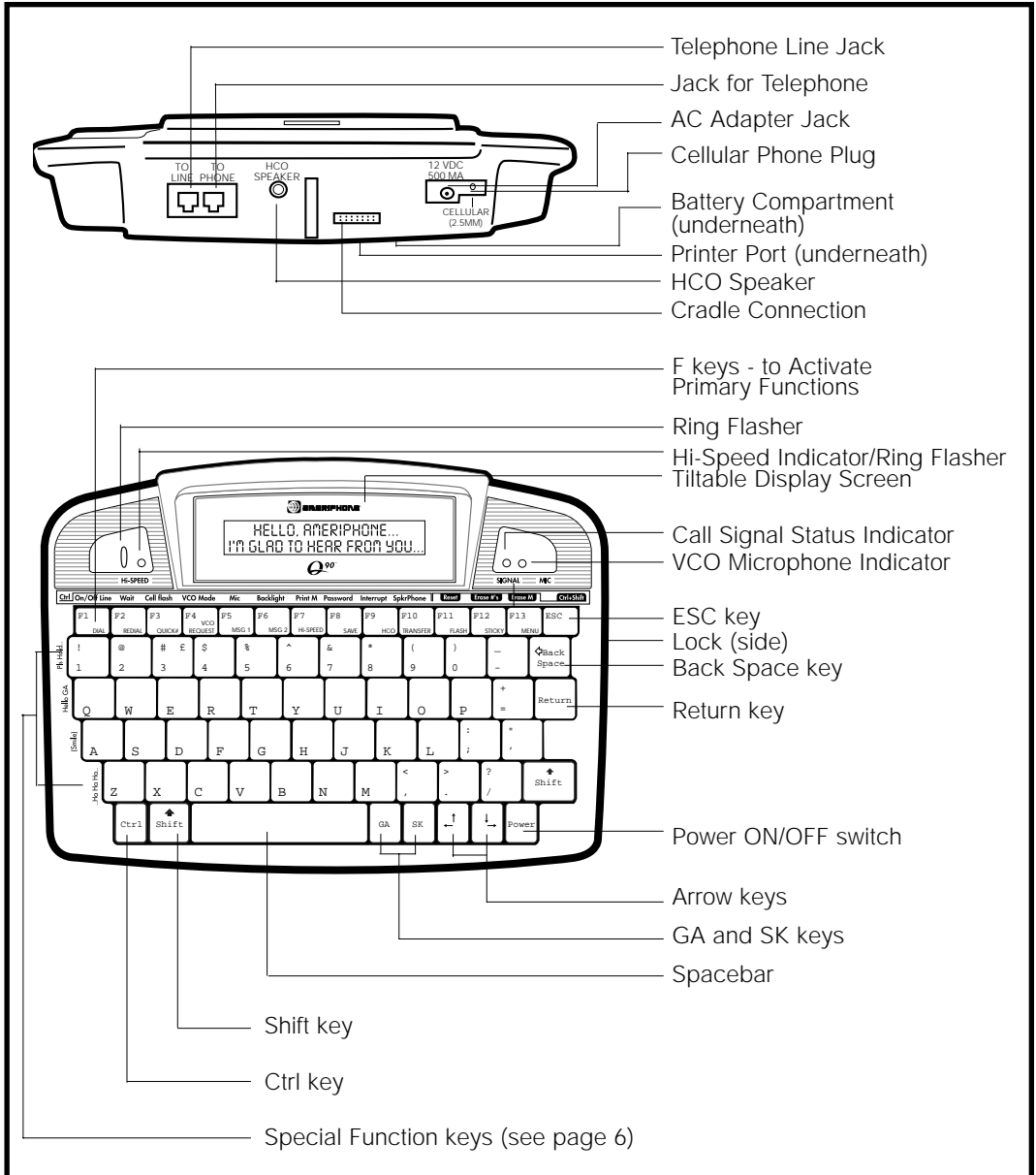















Figure 1 - Package Components

# CHAPTER 3 FEATURES IDENTIFICATION



## CHAPTER 3 (CONTINUED)

### PRIMARY FUNCTIONS

<b>Press...</b>	<b>And the Q90 will...</b>
	dial a phone number (page 19)
	redial the last dialed number (page 19)
	dial the number stored in phone directory #1 (page 19)
	request VCO call service (page 19)
	send programmed message (page 19)
	send programmed message (page 19)
	activate Hi-Speed (page 19)
	save MSG 1, MSG 2 or a phone number (page 19)
	activate HCO mode (page 19)
	hold a call before transferring to another TTY (page 19)
	activate telephone company features (call waiting, 3-way calling, etc.) (page 20)
	activate the "Sticky Keys" mode (page 20)
	review or change the operation settings of your Q90 TTY. (page 20)
	exit from special function mode and go back to normal Q90 TTY operation. (page 20)

For a detailed explanation of the Primary Functions, see Chapter 7.

# CHAPTER 3 (CONTINUED)

## SECONDARY FUNCTIONS

**Hold  
down...  
and  
press**



**and the Q90 will...**

**ON/OFF Line-** switch between on-line and off-line (page 20)



**Wait-** activate "Waiting for Response" function (page 20)



**Cell Flash-** turns on the ring flasher for incoming cell phone or cordless phone calls when the cradle is removed. (page 20)



**VCO Mode-** function in VCO mode (page 20)



**Mic-** turns on the microphone if the VCO mode is on. (page 20)



**Backlight-** turn the backlight on or off. (page 20)



**Print M-** print the conversation memory (page 21)



**Enter Password-** save a 10 digit password (page 21)



**Interruption-** turn interrupt function on or off (page 21)



**Speakerphone-** function in speakerphone mode (page 21)



**Pls Hold-** send "Pls Hold" message (page 21)



**Hello GA-** send "Hello GA" message (page 21)



**(Smile)-** send "(Smile)" message (page 21)



**..Ha Ha Ha..-** send "..Ha Ha Ha.." message (page 21)



**Send Buffer-** transmit conversation buffer content (page 21)



**Reset-** set Q90 to factory default settings (page 21)



**Erase #'s -** erase all programmed phone numbers (page 21)



**Erase M-** erase entire conversation memory (page 21)



## CHAPTER 4 INSTALLATION

### A. Power Connection

1. Connect the AC adapter plug into the back of the Q90 marked 12 VDC.
2. Plug the AC Adapter into your wall outlet (as shown below).

Note: The AC adapter provides power to operate the Q90 while automatically charging the rechargeable batteries in the battery compartment. You should only use the AC adapter supplied with your Q90. When the Q90 is not in use, turn the power off, but keep the AC Adapter plugged in.

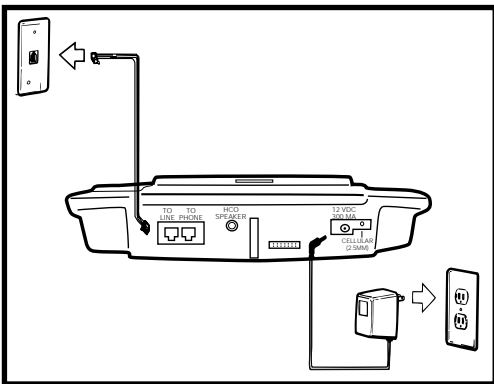

Figure 3 - Power and Phone Line Connection

### B. Direct Phone Line Connection

1. Connect one end of the phone cord into the back of the Q90 marked TO LINE.
2. Connect the other end of the phone cord to the telephone wall jack (as shown in Figure 3).

### C. Telephone Connection

The Q90 can share a telephone wall jack with a regular phone (or an external flashing device). This is especially useful for household members that do not use a TTY.

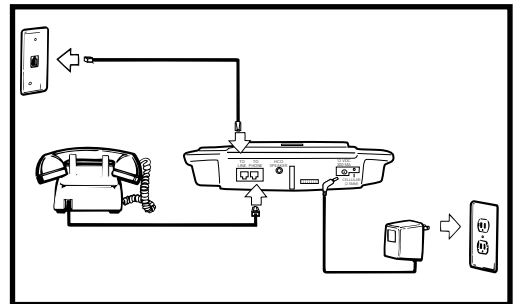

Figure 4 - Telephone Connection

Connect an external telephone to the jack in the back of the Q90 marked TO PHONE (as shown above).

Note: The Q90 can also be used with pay phones that have a data port. Plug one end of the phone cord into the TO LINE jack on Q90. Plug the other end of the phone cord into the data port on the pay phone.

## CHAPTER 4 (CONTINUED)

### D. Cellular Phone and Cordless Phone Connection

1. Connect one end of the Cell Cord into the jack in the back of the Q90 marked CELLULAR (2.5mm)
2. Connect the other end of the cord into the phone (as shown below).

Note: To work with your Q90, cell phones and cordless phones need a 2.5mm plug (commonly used for headphones) or a compatible adapter. Among cell phones, analog service works best with the Q90. Digital cellular phone service is not recommended due to high message error rates.

An optional car cigarette lighter adapter, available from Ameriphone, can provide power to operate the Q90 while automatically charging the Q90 batteries.

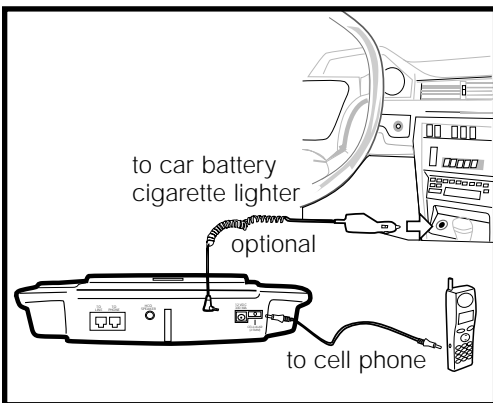

Figure 6- Cell Phone Connection

## CHAPTER 5 SETTING UP YOUR Q90 TTY

Your Q90 comes ready to use. However, for your convenience, we suggest you set up three basic features: Phone Directory for memory dialing, and MSG 1 and MSG 2 for user-programmed messages.

### A. Adding Names and Numbers to the Phone Directory

1. Press **(Power)** to turn on the Q90.
2. Press **(F1)** to enter dial mode.
3. Type the complete phone number sequence, (use space-bar for pauses).
4. Use **(1)** or **(2)** to select the directory (1 through 24) where you wish to store the number.
5. When finished, press **(F8)** to enter the save mode.
6. The screen displays **Edit Current Name Y/N?**
7. Press **(Y)** (Yes) and then type in a name for this number.
8. Press the **(Return)** key when done.
9. Repeat this process, starting at step 2 to add more numbers and names, or hold

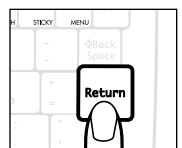
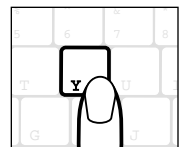
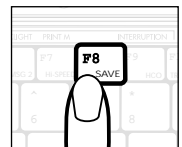
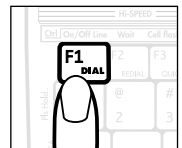
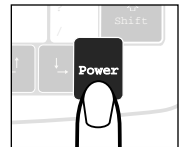

## CHAPTER 5 (CONTINUED)

down **Ctrl** and press **Power** when finished.

Note: The phone number stored in directory 1 will automatically dial when you press **F3**. Use this for your most frequently dialed number, such as your call relay service.

### B. Personalized MSG 1 & MSG 2

1. Press **Power** to turn on the Q90.
2. Press **F8** to select Save mode.
3. Press **F5** to select MSG 1 or **F6** for MSG 2.
4. Type the message. Use the Backspace key to erase errors. The message can be up to 503 characters long.
5. When the message is complete, press **Return** to save the message or press **ESC** to exit without saving.

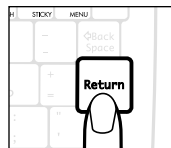
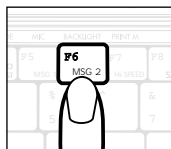
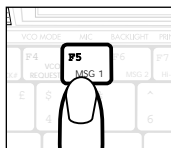
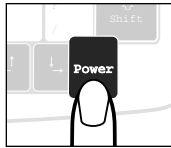

### C. Factory Preset Modes of Operation

Your Q90U comes preset with the following modes of operation:

#### Menu Mode Settings:

- |                                   |                 |
|-----------------------------------|-----------------|
| 1. Tone/Pulse Dialing             | [Tone]          |
| 2. Ringer (with external speaker) | [ON]            |
| 3. Ring Flasher                   | [ON]            |
| 4. International                  | [OFF]           |
| 5. Form Feed                      | [OFF]           |
| 6. Auto Return                    | [ON]            |
| 7. Repeat Key                     | [ON]            |
| 8. Mixed Case                     | [OFF]           |
| 9. Auto ID                        | [OFF]           |
| 10. Auto Answer                   | [OFF]           |
| 11. Auto Greeting                 | Default Message |
| 12. Rings Before Answer           | 5               |

#### Other Settings:

- |                  |       |
|------------------|-------|
| 13. Interrupt    | [ON]  |
| 14. HCO          | [ON]  |
| 15. VCO          | [OFF] |
| 16. Speakerphone | [OFF] |
| 17. Hi-Speed     | [OFF] |
| 18. Sticky Key   | [OFF] |
| 19. Auto Amplify | [OFF] |

For a detailed explanation of the functions of these preset modes, see the GLOSSARY in Chapters 7 and 8.

### D. Changing Menu Mode Settings

For a detailed explanation of the Menu Mode Settings, see Chapter 8.

#### 1. Entering Menu Mode

Press **F13** to enter Menu mode.

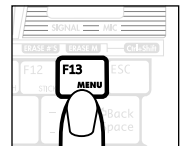

## CHAPTER 5 (CONTINUED)

### 2. Tone/Pulse Dialing

1. Press **Spacebar** to switch between Tone or Pulse.
2. Press **ESC** to finish or **Return** to continue to Ringer.

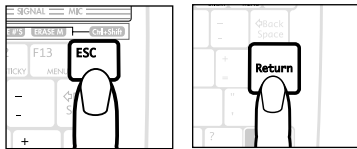
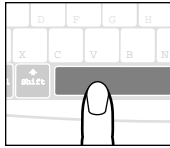

### 3. Ringer

1. Press **Spacebar** to turn Ringer on or off.
2. Press **ESC** to finish, or press **Return** to continue to Flasher.

### 4. Flasher

1. Press **Spacebar** to turn Flasher on or off.
2. Press **ESC** to finish, or press **Return** to continue to International.

### 5. International

1. Press **Spacebar** to turn International mode on or off.
2. Press **ESC** to finish, or press **Return** to continue to Form Feed.

### 6. Form Feed

1. Press **Spacebar** to turn Form Feed on or off.
2. Press **ESC** to finish, or press **Return** to continue to Repeat Key.

### 7. Repeat Key

1. Press **Spacebar** to turn Repeat Key on or off.
2. Press **ESC** to finish, or press **Return** to continue to Mixed Case.

### 8. Mixed Case

1. Press **Spacebar** to turn Mixed Case on or off.
2. Press **ESC** to finish, or press **Return** to continue to Auto ID.

### 9. Auto ID

1. Press **Spacebar** to turn Auto ID on or off.
2. Press **ESC** to finish.

### 10. Auto Return

1. Press **Spacebar** to turn Auto Return on or off.
2. Press **ESC** to finish, or press **Return** to continue to Repeat Key.

## CHAPTER 5 (CONTINUED)

**(Answering Machine includes: 11-13)**

### **11. Auto Answer**

1. Press **(Spacebar)** to turn Auto Answer on or off.
2. Press **(ESC)** to finish, or press **(Return)** to continue to Auto Greet.

### **12. \*Auto Greet**

1. Press **(Spacebar)** to select Greeting Message.
2. Press **(ESC)** to finish, or press **(Return)** to continue to Rings Before Answer.

### **13. \*Rings Before Answer**

1. Press **(Spacebar)** to select number of Rings.
2. Press **(ESC)** or **(Return)** to finish.

**\*Auto Greet and Rings Before Answer only appear on menu if Auto Answer is [ON].**

## E. Changing Other Settings

### 1. Interrupt

Hold down **(Ctrl)** and press **(F9)** to turn Interrupt on or off.

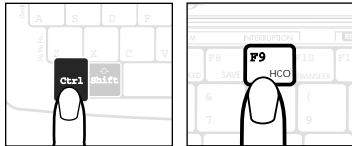

### 2. HCO

Press **(F9)** to turn HCO on or off.

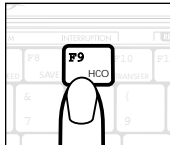

### 3. Hi-Speed

Press **(F7)** to turn Hi-Speed on or off.



### 4. Sticky Key

Press **(F12)** to turn Sticky Key on or off.

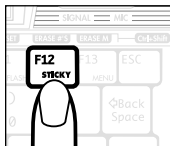

## A. Making a Phone Call (Direct Connect)

### 1. Manual Dialing from Keyboard

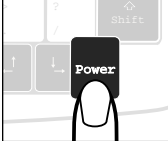
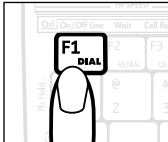
- Press the **(Power)** key to turn on the Q90. The opening screen will read **DIALOGUE Q90 By AMERIPHONE**. If no other function keys are pressed, after 2 seconds the display will change to **Off Line**.
 
- Press **(F1)** and **Enter Name or Number or Select Directory** with **(C)** will be displayed on the screen.
 
- Type in the desired telephone number. As you type in the number **Press Return to Dial** will be displayed on the screen.
- If you make a mistake in typing, press **(BackSpace)** to delete one space at a time or press **(Esc)** to abort the entire sequence.
- After all numbers are entered, press **(Return)** to start the dialing sequence. **Dialing Entered Number 1234567** is displayed on the screen.
- If the line is busy, **Busy Signal!!!!** will be displayed and the SIGNAL light will blink quickly.

## CHAPTER 6 (CONTINUED)

Hold down **(Ctrl)** and press **(F1)** to hang up and try again.

7. If the line is not busy, **Silence!!!!** and **Ringing....** will be displayed alternately.

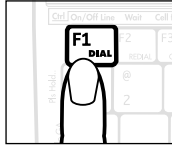
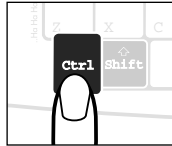

8. If the other party answers by TTY, the SIGNAL light will brighten and you'll see a greeting message on the screen.
9. If the party answers by voice, the SIGNAL light will flicker. If Auto ID is on, the Q90 will send Baudot tones to tell the person you are calling that this is a TTY call (see Auto ID page 22).
10. After the conversation is over, hold down **(Ctrl)** and press **(Power)** to turn off the Q90 or hold down **(Ctrl)** and press **(F1)** to hang up and make another call.

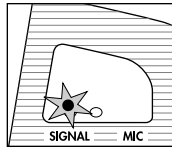

### 2. Dialing from the Phone Directory

To dial this way, you must first have names and phone numbers stored in the directory. See Chapter 5 to create a phone directory.

1. Press the **(Power)** key to turn on the Q90.

2. Press **(F1)** to enter Dial mode and **Enter Name or Number or Select Directory with** will be displayed.

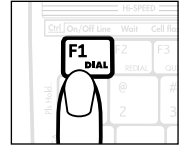

3. Type in the name of the person you are calling then press **(Return)** to enter your selection.  
Or:
4. Press **(G)** or **(G)** until the desired name appears. Then press **(Return)** to dial the directory number.
5. When the dialing sequence ends your Q90 will automatically display call status messages such as **Silence!!!!**, **Ringing...**, or **Busy Signal!!!!**.

### 3. Last Number Redial

With the Q90 turned on, press **(F2)** to redial the last dialed number. The number will be displayed below **Last Number Redial** on the screen.

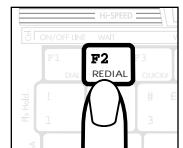

### 4. Answering a Phone Call

1. When there is an incoming call, the built-in ring flasher will flash.

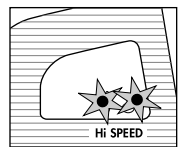

## CHAPTER 6 (CONTINUED)

2. Press any key to answer.
3. When you answer, the Q90 displays the message

**On Line Ready!**

You may now begin typing a greeting message or just hold down **Ctrl** and press **Q** to send the preset message, **HELLO GA**.

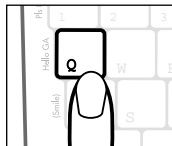

3. Make sure *Hi-Speed™* is off by pressing **F7** once or twice, as needed.

4. Hold down **Ctrl** and press **F3**. The display will show:

**Cell Phone Standby Mode**.

5. When a call comes in, the ring flasher will flash. The display will show :

**Ringin... Answer Your Cell Phone!**

6. Start typing.
7. When finished, hold down **Ctrl** and press **Power** to turn off the Q90 or hold down **Ctrl** and press **F3** to enter Standby mode again.

### B. Making a Phone Call (Cellular Phone or Cordless Phone)

#### 1. Dialing from a Cell Phone or Cordless Phone

1. Press **Power** to turn on the Q90.
2. Make sure *Hi-Speed™* is off by pressing **F7** once or twice, as needed.
3. Dial the phone number using the cell phone or cordless phone.
4. Start typing when answered.

Note: *Hi-Speed™* cannot be used during a cell phone call.

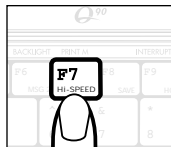

#### Notes:

1. Cell Phone Standby Mode turns off if you receive a call or if you touch a key. To reset it, repeat step 4 (above).
2. Some cell phones and cordless phones are designed so that the Q90 Ring Signaler will not flash when a call comes in. If your phone is like this, skip steps 4 and 5 (above) and watch the display on your phone to tell if a call is coming in.

#### 2. Answering a Cell phone or Cordless Phone

1. Turn on your cordless or cell phone and connect it to the Q90.
2. Press **Power** to turn on your Q90.



## CHAPTER 6 (CONTINUED)

### C. Hi-Speed™ Transmission

1. Press **(F7)** to turn on *Hi-Speed™*.
2. If both TTYs have *Hi-Speed™* capability and are in *Hi-Speed™* mode, the *Hi-Speed™* light will turn on and your call will proceed at the higher rate. If not, the Q90 will automatically use the normal transmission speed.

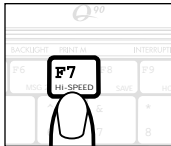

### D. Transfer

1. Press **(F10)** to send the message [Pls Hold...]. Your TTY sends the message and then displays [Hold Mode [ON]] [Press Any Key to Release].
2. Turn on another TTY on the same phone line. Using this TTY, press **(Return)** three times and the Q90 will automatically hang up and turn off. You can continue your call on the other TTY.

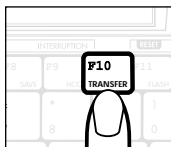

Note: If your TTY does not have a **(Return)** key, press **(Enter)** three times instead.

### E. Printing a Conversation

The Q90 can print conversations using most printers that have a 36 pin Centronics parallel port.

#### 1. Preparing to Print a Conversation

1. Make sure the Q90 and the printer are off. (If needed, hold down **(Ctrl)** and press **(Power)** to turn off the Q90.)
2. Connect one end of the printer cable to the printer port on the bottom of the Q90.
3. Connect the other end of the printer cable to the printer.

**Note:** An optional printer cable is available from Ameriphone.

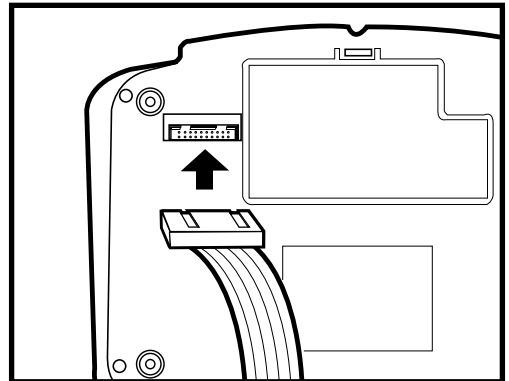

#### 2. Printing a Conversation with a Dot-Matrix Printer

1. Turn on the printer and the Q90.
2. If you are using continuous form-feed paper, follow

## CHAPTER 6 (CONTINUED)

instructions supplied with the printer to line up the top of the paper with the top of the printer head.

3. Make sure that the Q90 Form Feed function is on. (See "Changing Menu Mode Settings," page 9.)
4. Make a call as usual.

**Note:** Many printers will print a line of text after you have typed or received about 80 characters. Then they will pause until you have typed or received another 80 characters before printing the next line of text.

### 3. Printing a Conversation with a Laser Printer or Ink Jet Printer

1. Turn on the printer and the Q90.
2. Make a call as usual.

**Note:** Many laser printers and some ink jet printers will print one full page of text at a time. If your conversation fills less than a full page, send the printer a "Form Feed" command by holding **(Ctrl)** and pressing **(Return)**. Then, your conversation will be printed.

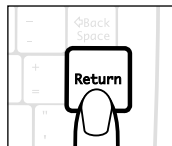
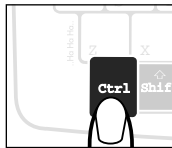

### 4. Printing a Conversation Stored in Memory

1. After you finish a conversation and hang up, press **(Ctrl)** **(F7)** and the Q90 will automatically print everything stored in conversation memory.

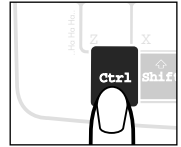

**Note:** The Q90 is compatible with many printers. However, due to the variety of printing methods used by different printer manufacturers, you may need to refer to the printer instruction manual and try different settings to get the best results.

### F. VCO (Voice Carry Over) Calls

1. Press **(Power)** to turn on the Q90.
2. Use the Q90 to dial your relay service number.
3. After your call is answered, press **(F4)** and the Q90 will automatically send text requesting VCO relay service.

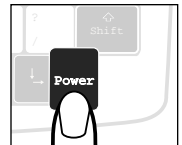

## CHAPTER 6 (CONTINUED)

4. When the relay service responds and sends "GA", the green Microphone indicator will light up.

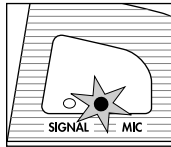

5. You may now voice your response.  
6. When you wish the other party to respond, say "go ahead".

7. The Q90 microphone will turn off automatically when the relay service sends text.

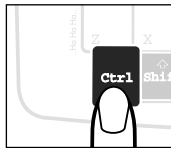

8. When finished, hold down **Ctrl** and press **Power** to turn off the Q90.

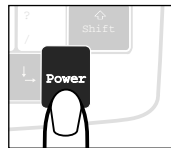

**Note:** If the microphone does not turn on automatically, hold down **Ctrl** and press **F5** to turn it on manually. If the microphone does not turn off automatically, press **Esc** to turn it off manually.

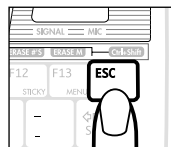
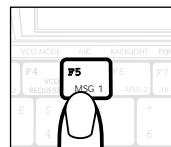
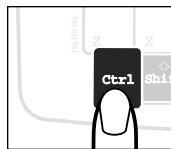

### G. HCO (Hearing Carry Over) Calls

**Note:** To use the HCO function you must have a stereo headset or amplified speaker plugged into the HCO output jack.

1. Press **Power** to turn on the Q90.
2. Make sure HCO is on by pressing **F9** once or twice, as needed.



3. Use the Q90 to dial your relay service number.
4. The Q90 will automatically mute the audio while you type and un-mute the audio when you stop.
5. When finished, hold down **Ctrl** and press **Power** to turn off the Q90.

## CHAPTER 6 (CONTINUED)

### H. Lock

The Q90 has a LOCK switch on the right side. Turn the LOCK ON to prevent the Q90 from accidentally turning on and draining the battery. We strongly advise you turn the LOCK ON any time you move the Q90 from one place to another or carry it in your luggage or briefcase. Remember to turn the LOCK OFF before using your Q90.

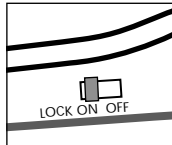

### I. Useful Tips

1. Background sounds will interfere with a VCO or HCO call, so it is very important to make these calls in a quiet area. During an HCO call, your caller should also be in a quiet room.
2. You can make VCO and HCO calls using a cordless or cellular phone.
3. When using a cellular phone for VCO calls, turn the *Hi-Speed*<sup>™</sup> mode OFF.
4. During a VCO or HCO call, if you suspect there is static or other noise on the phone line, turn the *Hi-Speed*<sup>™</sup> mode OFF.
5. For VCO calls, make sure the green color microphone indicator is ON before you speak.

## CHAPTER 7 GLOSSARY OF PRIMARY FUNCTIONS



**Dial** - This key toggles the Q90 in or out of dialing mode. After turning on the Q90, press **Dial** once to select a phone number from the directory or to dial manually. See "Making a Phone Call," page 12. Pressing the key a second time or pressing the ESC key cancels dial mode.



**Redial** - Press this key to redial the last number you dialed.



**Quick #** - This key automatically dials the number in Directory 1. Use it for the number you dial most frequently, such as your call relay service. See page 8 to set up your Phone Directory.



**VCO Request** - When on line, press this key to transmit a factory defined message, "VCO CALL PLS GA", and automatically establish VCO mode. See "VCO (Voice Carry Over) Calls", page 16.



### **MSG 1 & MSG 2** -

Press these keys to send user-defined messages.

See "Personalized MSG 1 & 2" on page 9.



**Hi-Speed™** - Sends text at twice the normal speed, so you can type as fast as you want, for quicker, more economical calls.

Ameriphone has developed *Hi-Speed™* as an "open" format that can be licensed, at no charge, to other TTY manufacturers, relay services, etc. Our goal is to encourage an industry-wide standard that enables the greatest number of TTY users to communicate at new, higher speeds. See "Changing Other Settings," page 12.



**Save** - If this key is pressed while in dial mode, it saves a phone number sequence in the phone directory. If this key is pressed when not in dial mode, it saves a user message.



**HCO** - The Q90 allows you to type the outgoing conversation, while allowing you to hear the response through an accessory speaker or Walkman style headset. HCO is for people who can hear, but have difficulty speaking. These calls are usually made through the relay service. See "HCO (Hearing Carry Over) Calls," page 17.



**Transfer** - Allows a call to be transferred to another TTY on the same phone line. See "Transfer," page 15.

## CHAPTER 7 (CONTINUED)



**Flash** - Used to access telephone company features such as call-waiting, 3-way calls, etc. See "Answering a Cell Phone or Cordless Phone," page 14.



**Sticky** - This function makes it easier to operate the Q90 with just one hand. For example, when sticky key is on, pressing (Ctrl), releasing it and then pressing (F1) has the same effect as holding down (Ctrl) while pressing (F1). The sticky key works with the (Ctrl), (Shift), and (Ctrl) (Shift) key combinations. See "Changing Other Settings," page 12.



**Menu** - Pressing this key enters or exits the menu mode, which is used to change many of the settings used by the Q90. See "Changing Menu Mode Settings," page 9.



**ESC** - The ESC Key will cause the Q90 to exit Dial Mode, Save Mode, Review Mode, and user message sequences. The ESC Key does not cause the Q90 to hang up if on line.

## CHAPTER 7 GLOSSARY OF SECONDARY FUNCTIONS



**On/Off Line** - This key causes the Q90 to connect or disconnect from the telephone line.



**Wait** - This key is useful if you expect a long pause in a conversation. Activate this function and **Waiting for Response** will be displayed. Then, when your caller begins typing again, the ring signaler will flash.



**Cell Flash** - When Cell Flash is on, the Q90 ring flasher will flash to announce an incoming cell phone or cordless phone call.



**VCO Mode** - This allows the outgoing conversation to be voiced, while providing a text display of the incoming response. It is provided for Q90 users who can speak, but have difficulty hearing. These calls are usually made with the help a relay call assistant. See "VCO (Voice Carry Over) Calls," page 16.







**Mic** - This key turns on the VCO microphone if the Q90 is in VCO mode.







**Backlight** - This key turns the Q90 backlight on or off.



## CHAPTER 7 (CONTINUED)

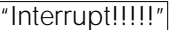

  **Print M** - When pressed this key sends the contents of the conversation memory to a printer. This key works off-line only.



  **Enter Password** - This key allows you to create a password for Remote message retrieval. Press  to save.



  **Interruption** - When the interrupt function is on and you are sending, the Q90 will pause every twenty characters to allow the other TTY to interrupt your transmission. This functions only if the other TTY has a compatible interrupt function. If your Q90 is interrupted it will briefly display the message , and flash the ring flasher.



  **Speakerphone** - When pressed, this key allows you to talk using the hands free speakerphone function.



  **Pls Hold** - Pressing this key causes the Q90 to send the "Pls Hold" message.



  **Hello GA** - Pressing this key causes the Q90 to send the "Hello GA" message.



  **(Smile)** - Pressing this key causes the Q90 to send the "(Smile)" message.

  **..Ha Ha Ha..** - Pressing the key causes the TTY to send "Ha Ha Ha" message.

  **Send Buffer** - Pressing this key causes the Q90 to transmit conversation buffer content.

   **Reset** - When pressed this key sets Q90 to the factory preset modes. This key functions off line only.

   **Erase #'s** - When pressed, this key erases all of the directory numbers and names. This key functions off line only.

   **Erase M** - This key erases the conversation memory. It functions off line only.

## CHAPTER 8 GLOSSARY OF MENU MODE SETTINGS

To learn how to operate the functions described in this section, see "Changing Menu Mode Settings," page 9.

**Tone/Pulse Dialing** - This allows you to select the way the Q90 dials telephone numbers. Almost all telephone companies use tone dialing.

**Ringer** - The Q90 can produce an audible ringing tone if it is connected to an optional HCO speaker.

**Flasher** - The Q90 has two lights that flash to announce an incoming call. The brightest light, on the left, does not operate when the Q90 is powered by batteries.

**International** - In the United States text messages are sent at a speed described as "45 Baud." Some other countries use "50 Baud." The Q90 can be set to operate at this "International" speed. The Q90 will automatically receive either speed. However, if you are sending to someone in another country and they have problems receiving your messages, you may want to try changing the transmission speed of the Q90.

**Form Feed** - The Q90 can be set to tell a printer when to move to the next page when connected to an optional printer.

**Repeat Key** - When this function is on, if you hold down a key, the Q90 will repeat that key until you release it.

**Mixed Case** - When this is on, your messages are in lower case and the messages you receive are in upper case, making it easier to follow the conversation. When it is off, all messages are in capital letters.

**Auto ID** - When this is on, the Q90 automatically sends Baudot tones every five seconds if your call is answered with a voice telephone. These notify hearing people and public dispatch facilities (such as 911) that you are calling with a TTY. The Signal light blinks when the Baudot tones are sent. The tones automatically stop when either party starts to type.



## CHAPTER 9 TROUBLE SHOOTING

If any problem should arise during operation of your TTY, go through the suggestions listed below. Should the difficulty persist, contact AMERIPHONE or your authorized dealer for assistance.

SYMPTOM	CAUSE AND CORRECTIVE ACTIONS
Keyboard "Lock Up" - Q90 not responding	First hold down <b>(Ctrl)</b> <b>(Shift)</b> and <b>(ESC)</b> simultaneously for about 2 seconds. Then, if the Q90 still does not respond, disconnect the AC adapter and momentarily remove one battery. This resets the internal microprocessor.
Nothing happens when Q90 is turned on	No power. Check to make sure that both ends of the AC adapter are firmly plugged in. If you are using batteries, make sure that each battery is properly installed and that they are properly charged.
Batteries run down too soon after charging	Batteries may not be charged properly. First, completely drain the batteries by following this procedure: Unplug the AC adapter, unplug the telephone line, turn on the Q90. Hold down <b>(Ctrl)</b> then press <b>(F1)</b> to place the Q90 on line. Leave the Q90 on until it automatically turns itself off. Next, plug in the AC adapter and the phone line and let the Q90 charge for 14 hours. If this does not work, your batteries may need to be replaced. Replace with NiCad rechargeable batteries. <b>NOTE:</b> To avoid losing conversations stored in memory, plug in the AC adapter before removing the batteries.
No dial tone for keyboard dialing	Check to make sure both ends of the telephone cord are firmly plugged in.
Nothing happens after you dial from keyboard	Make sure you press <b>(Return)</b> after dialing the number. Pressing <b>(Return)</b> completes the dialing sequence.

## CHAPTER 10 MAINTENANCE INFORMATION

### A. Caring for Your Q90

Even though your Q90 TTY is built to last and is designed to be maintenance free, it contains sensitive and delicate electronic parts. To protect your investment and ensure the best performance, treat it with care.

- Avoid dropping your Q90 or subjecting it to any impact. Use the carrying case when traveling.
- Clean your Q90 plastic case regularly and use only a slightly damp, soft cloth. To remove stains, use mild soap. Never use detergents, excessive water or harsh cleaning agents.
- Do not allow dust to build up in the gaps around the keys. Vacuum the keyboard regularly. For best protection, keep the dust cover on when your Q90 is not in use.

### B. Recharging Batteries

Rechargeable batteries usually last longer when they are used and recharged regularly. For best results, they should be completely drained and then recharged every six months or so. To drain the batteries, unplug the AC adapter/charger, remove the telephone line from the modular phone jack, turn on the Q90 and use **Ctrl**(F1) to select the On Line condition. Leave the Q90 on until it automatically turns itself off.

#### **WARNING...**

**DO NOT** leave batteries drained of power for more than 1 1/2 hours as your conversation memory will be lost.

The batteries can normally be used and recharged hundred of times. If they run down quickly soon after charging, they may need to be replaced.

NOTE: Before removing the batteries, be sure to plug in the AC adapter to avoid erasing the conversation memory.

## CHAPTER 11 TTY USER'S ETIQUETTE

Here are some commonly accepted abbreviations that reduce the need to type long phrases.

GA means "Go Ahead". When you finish typing your sentence or message, press GA key or type GA to show it's the other party's turn to respond. For example, "**HI, THIS IS JANE, HOW CAN I HELP YOU? GA**". When you see GA at the end of an incoming sentence or message, it is your turn to respond.

Q is often used instead of a question mark. For example, "**HOW ARE YOU Q**".

SK means "Stop Keying". Press SK key or type SK when you are ready to end the conversation. Typing GA followed by SK is a polite way to say good-bye and to give the other party a last chance to respond before hanging up. For example, "**NICE TALKING WITH YOU SK**".

Type SKSK to show that you're hanging up. For example, "**BYE NOW SKSK**".

Here are more abbreviations which are commonly used by TTY users.

ASAP	As soon as possible
ASST	Assistant
BIZ	Business
CA	Communication assistant
CD or CLD	Could
CUZ	Because
DR	Doctor
ED	Education
FIGS	Figures

HD	Hold
ILY	I love you
IMPT	Important
LTRS	Letters
MSG	Message
MISC	Miscellaneous
MTG	Meeting
NBR	Number
OIC	Oh I see
OPR	Operator
PLS	Please
SVC	Service
THKS	Thank you
THRU	Through
TMW	Tomorrow
U	You
UR	Your
URS	Yours
XXX	Erases an error

## CHAPTER 12 WARRANTY INFORMATION

This warranty applies only to AMERIPHONE products that are purchased and used in the United States or Canada.

AMERIPHONE warrants our TTY against defects in materials or workmanship for the period of one year from the date of purchase. If our extended warranty is purchased, this same warranty also applies to the period covered by the extended warranty. For information on our exclusive Protection Plus Extended Warranty Program and how to sign up for it, please call us at (800) 874-3005.

If your AMERIPHONE product is defective and returned within 30 days of the date of purchase, your Q90 dealer will replace it at no charge.

If returned after 30 days but within one year from the date of purchase, we will repair or replace it at no charge. In the repair of your AMERIPHONE product, we may use new or reconditioned replacement parts. If we elect to replace your AMERIPHONE product, we may replace it with a new or reconditioned product of the same or similar design. Repair or replacement will be warranted for either (a) 90 days or (b) the remaining time on the warranty period, whichever is longer. AMERIPHONE is not responsible for and will not pay for loss of time or inconvenience, loss of use of your AMERIPHONE product, or any property damage caused by your AMERIPHONE product or its failure to work, or any other incidental or consequential damages.

For warranty service for your AMERIPHONE product, you must provide proof of the date of purchase. Within 30 days of the date of purchase, return your AMERIPHONE product to the place where you purchased it for immediate replacement. After 30 days, call us, at (714) 897-1111 (TTY) or (714) 897-0808 (voice) for address of an authorized service location.

If you ship your AMERIPHONE product to an authorized service location, you must prepay all shipping costs. We suggest that you retain the original packing material in the event of shipment.

When sending your AMERIPHONE product to a service location, include your name, address, phone number, proof of purchase, and a description of the problem. Upon repairing or replacing your AMERIPHONE product, we will ship it to your home in the United States or Canada at no cost to you. This warranty does not cover defects resulting from accidents, damage while in transit, alterations, unauthorized repair, failure to follow operating instructions, misuse, use outside the United States or Canada, fire, flood, and acts of God. Nor do we warrant your AMERIPHONE product to be compatible with any particular telephone equipment systems or more sophisticated switching systems.

This warranty is the only one we shall give on your AMERIPHONE product, and it sets forth all our responsibilities regarding that product. There are no other expressed warranties. This warranty gives you specific legal rights, and there may also be other rights which vary from state to state.

## CHAPTER 13 REPAIR INFORMATION

If your Q90 TTY is still in warranty, follow the directions in Chapter 12 for repair service.

If your AMERIPHONE product is not covered by our warranty, call us at (714) 897-1111 TTY or (714) 897-0808 (voice) for advice and other repair information, including charges. At our option, we may replace rather than repair your AMERIPHONE product with a new or reconditioned one of the same or similar design.

Repair or replacement will be warranted for 90 days or remainder of warranty, whichever is longer.

## CHAPTER 14 FCC REGISTRATION

This TTY complies with the standards in part 68 of the Federal Communications Commission (FCC) rules and has been approved by the FCC for direct connection to telephone lines. The Registration Number and Ringer Equivalence Number (REN) are noted on the label at the bottom of the unit.

Before connecting the unit to your phone line, notify your local telephone company of the Federal Communications Commission (FCC) Registration Number and the Ringer Equivalence Number (REN) of your TTY.

Your local telephone company is required by the FCC to allow you to connect FCC registered telephone equipment to their telephone lines. Your notification helps your local telephone company to continue to provide the best possible service.

Your AMERIPHONE product has also been tested and found to meet the standards for a Class B digital device, as specified in Part 15 of the FCC Rules. These specifications are designed to provide against interference to a radio and television reception in a residential installation. However, there is no guarantee that interference will not occur in a particular installation. If your AMERIPHONE product causes interference to a radio or television reception when in use, you might correct that interference with any one or all of these measures:

1. Where it can be done safely, reorient the receiving television or radio antenna.
2. To the extent possible, relocate the television, radio or other receiver with respect to the telephone equipment.
3. If your telephone product runs on AC power, plug it into an AC outlet that's not on the same circuit as the one used by your radio or television.

## CHAPTER 15 SPECIFICATIONS

### PHYSICAL DIMENSIONS

Size: 10" w x 7.3" d x 2.3" h

Weight: 1.75 lbs. with batteries

### POWER

UL/CSA listed AC Adapter: 12VDC, 300 or 500 ma, Rechargeable batteries: Six NiCad Size AA powers unit for up to 30 hours.

### KEYBOARD

68 ergonomic keys

### DISPLAY

Transflective LCD with backlight  
2 lines by 24 characters

### COMMUNICATION CODES

Baudot Code: 45.5 or 50 Baud

*Hi-Speed*<sup>™</sup> = 90 Baud

### CSA/NRTL LISTED

### FCC AND DOC APPROVED

## CHAPTER 16 OTHER AMERIPHONE PRODUCTS

Ameriphone, Inc. is an internationally known manufacturer of communication devices for people with special needs. We attribute our success to a powerful, yet simple business philosophy: integrate the latest technology into the development of superior quality products, offer them at competitive prices and support them with excellent customer service.

In addition to the exciting new Q90, our product line includes:

- TTYs (text telephones)
- Notification systems for the deaf and hard-of-hearing
- Amplified telephones and portable telephone amplifiers for the hard of hearing
- Hands-free speakerphones for those with mobility loss
- Speaking telephone for people with low vision

For more information or the location of your nearest Authorized Ameriphone Dealer, please call us, visit our website or send us an e-mail.



12082 Western Avenue, Garden Grove CA 92841-2913  
(800) 874-3005 • (800) 772-2889 TTY • (714) 897-4703 Fax  
ameriphone@ameriphone.com • www.ameriphone.com

Q90 and AMERIPHONE are registered trademarks of AMERIPHONE, INC. Precision engineered in U.S.A.

**CHAPTER 17  
AVAILABLE OPTIONAL  
ACCESSORIES**

Make your new Q90 even more enjoyable! Print your messages, charge your batteries while in the car, make an HCO call or protect your new Q90. These high quality accessories make the most of "Tomorrow's TTY .... TODAY!"

PRINTER CABLE

Print your conversations using your own printer. (Printer must have a 36 pin Centronics parallel port.)

CIGARETTE LIGHTER ADAPTER

Recharge the Q90 while in your car. Coiled cord eases storage. Indicator light shows it is ready to use.

SOFT CARRYING CASE

Attractive but durable material custom fitted to protect your Q90.

EXTERNAL HCO SPEAKER

Plugs into the Q90 for hands-free Hearing Carry-Over calls. Compact size and adjustable volume.

CELL CORD

The genuine Ameriphone replacement for lost or worn out original Q90 Cell Cords.

RECHARGEABLE BATTERIES

These genuine Ameriphone replacements are ideal when it is time to replace your original Q90 batteries (Set of 6 NR-AA).

## Accessories Order Form

Name \_\_\_\_\_ Phone (    ) \_\_\_\_\_  
 Address \_\_\_\_\_ Phone is:  TTY  Voice  
 City \_\_\_\_\_ State \_\_\_\_\_ Zip \_\_\_\_\_

	Price	Qty	Cost	Total
Printer Cable	\$14.95			
Cigarette Lighter Adapter	\$19.95			
Soft Carrying Case	\$14.95			
External HCO Speaker	\$34.95			
Cell Cord	\$ 9.95			
Rechargeable Batteries (6 NR-AA)	\$11.95			

Check/Money Order Enclosed

C.O.D.  VISA  M/C  DISCOVER

Card No. \_\_\_\_\_

Exp. Date \_\_\_\_\_

Signature \_\_\_\_\_

Shipping Charges	Add
Order Under \$10.00	\$2.00
\$10.00 to \$100.00	\$4.50
\$101.00 to \$1,000.00	\$7.50

2nd Day Express Delivery Add \$4.00

Sub Total \_\_\_\_\_

Sales Tax (CA only) \_\_\_\_\_

Shipping \_\_\_\_\_

C.O.D. add \$4.75 \_\_\_\_\_

Total \_\_\_\_\_

**Order Today!**

12082 Western Ave. • Garden Grove, CA 92841-2913 • (800) 772-2889 TTY •  
 (800) 874-3005 Voice • (714) 897-4703 Fax

## INDEX

Abbreviations .....	25	Menu mode settings .....	9
Answering a phone call, cell or cordless call .....	14	Messages .....	9
Answering a phone call, direct connect .....	13	Microphone.....	16, 20
Auto ID .....	10, 22	Mixed case .....	10, 22
Backlight .....	20	MSG 1 and MSG 2 .....	9, 19
Batteries .....	24	On/Off line .....	20
Cell Flash .....	20	Pay phone connection .....	7
Cell phone standby mode .....	14	Personalized messages .....	9
Cellular phone connection .....	8	Phone call, answering .....	13, 14
Cellular phone service .....	8	Phone call, cellular or cordless .....	14
Cordless phone connection .....	8	Phone call, direct connect .....	12
Dial mode .....	19	Phone directory .....	8
Dialing, cell phone or cordless phone .....	14	Pls Hold .....	21
Dialing, from phone directory .....	13	Primary functions .....	5, 19-20
Dialing, manual .....	12	Print M .....	21
Erase .....	21	Printing .....	15-16
ESC .....	20	Quick number.....	19
Escape key .....	20	Redial .....	13, 19
Factory preset modes .....	9	Repeat key .....	10, 22
Flash .....	20	Reset .....	21
Flasher .....	10, 20	Ringer .....	10, 22
Form feed .....	10, 22	Safety instructions .....	Inside cover
Ha Ha Ha .....	21	Safety instructions, Canadian.....	Inside cover
HCO .....	12, 19	Save .....	19
HCO calls .....	17	Secondary functions .....	6, 20
Hello GA .....	21	Settings, changing other settings .....	12
Hi-Speed .....	12, 15, 19	Settings, other .....	9
International .....	10, 22	Smile .....	21
Interrupt .....	12, 21	Sticky .....	12, 20
Keyboard .....	2	Telephone connection .....	7
Lock .....	18	Tone/pulse dialing .....	10, 22
Making a phone call, cellular or cordless .....	14	Transfer .....	15, 19
Making a phone call, direct connect .....	12	VCO calls .....	16
Menu .....	20	VCO mode .....	20
		VCO request .....	19
		Wait .....	20



## Free Manuals Download Website

<http://myh66.com>

<http://usermanuals.us>

<http://www.somanuals.com>

<http://www.4manuals.cc>

<http://www.manual-lib.com>

<http://www.404manual.com>

<http://www.luxmanual.com>

<http://aubethermostatmanual.com>

Golf course search by state

<http://golfingnear.com>

Email search by domain

<http://emailbydomain.com>

Auto manuals search

<http://auto.somanuals.com>

TV manuals search

<http://tv.somanuals.com>