

User's Guide

for the



Ampeg

B1RE

Bass Amplifier





TABLE OF CONTENTS

Important Safeguards and Precautions	2
Introduction	3
Features	3
The Front Panel Controls and Their Use	4
The Rear Panel	5
Some Suggested Settings	6
Rack Mounting	6
Troubleshooting	7
System Block Diagram	7
Technical Specifications	back cover

Declaration of Conformity

Manufacturer's Name: SLM Electronics
Corporate Headquarters: 1901 Congressional Drive, St. Louis, Missouri 63146
Primary Production Facility: 700 Hwy 202 W, Yellville, Arkansas, 72687
Product Type: Audio Amplifier

Products meet the regulations for compliance marking under:

- ETL standards UL6500, UL60065, or UL813
- CSA standards E60065 or C22.2 No.1-M90
- CE safety standard EN60065
- CE EMC standards EN55103 or EN55013 and EN61000
- FCC standards 47CFR 15.107 and 15.109 Class A
- C-tick designation Level 2, ABN #56748810738, ARBN# N222
- KETI standard K60065 (limited model approval)

Compliance Support Contact: SLM Electronics, Attn: R&D Compliance Engineer
 1901 Congressional Drive, St Louis, Missouri, 63146 • Tel.: 314-569-0141, Fax: 314-569-0175

	CAUTION RISK OF ELECTRIC SHOCK DO NOT OPEN	
<small>WARNING: TO REDUCE THE RISK OF FIRE OR ELECTRIC SHOCK, DO NOT EXPOSE THIS APPARATUS TO RAIN OR MOISTURE. TO REDUCE THE RISK OF ELECTRIC SHOCK, DO NOT REMOVE COVER. NO USER-SERVICEABLE PARTS INSIDE. REFER SERVICING TO QUALIFIED SERVICE PERSONNEL.</small>		

	PRECAUCION RIESGO DE CORRIENTAZO NO ABRA	
<small>PRECAUCION: PARA REDUCIR EL RIESGO DE INCENDIOS O DESCARGAS ELECTRICAS, NO PERMITA QUE ESTE APARATO QUEDA EXPUESTO A LA LLUVIA O LA HUMEDAD. PARA DISMINUIR EL RIESGO DE CORRIENTAZO, NO ABRA LA CUBIERTA. NO HAY PARTES ADJUSTO QUE EL USUARIO.</small>		

	ATTENTION RISQUE D'ELECTROUCTION NE PAS OUVRIR	
<small>ATTENTION: PROTEGEZ CET APPAREL DE LA PLUIE ET DE L'HUMIDITE AFIN D'EVITER TOUT RISQUE D'INCENDIE OU D'ELECTROUCTION. POUR REDUIRE D'ELECTROUCTION NE PAS ENLEVER LE COUVERCLE. AUCUNE PIECE INTERNE N'EST REPARABLE PAR L'UTILISATEUR. POUR TOUTE REPARATION, S'ADRESSER A UN TECHNICIEN QUALIFIE.</small>		

IMPORTANT SAFETY INSTRUCTIONS

- READ, FOLLOW, HEED, AND KEEP ALL INSTRUCTIONS AND WARNINGS.
- DO NOT OPERATE NEAR ANY HEAT SOURCE AND DO NOT BLOCK ANY VENTILATION OPENINGS ON THIS APPARATUS. FOR PROPER OPERATION, THIS UNIT REQUIRES 3" (75CM) OF WELL VENTILATED SPACE AROUND HEATSINKS AND OTHER AIR FLOW PROVISIONS IN THE CABINET.
- DO NOT USE THIS APPARATUS NEAR SPLASHING, FALLING, SPRAYING, OR STANDING LIQUIDS.
- CLEAN ONLY WITH LINT-FREE DAMP CLOTH AND DO NOT USE CLEANING AGENTS.
- ONLY CONNECT POWER CORD TO A POLARIZED, SAFETY GROUNDED OUTLET WIRED TO CURRENT ELECTRICAL CODES AND COMPATIBLE WITH VOLTAGE, POWER, AND FREQUENCY REQUIREMENTS STATED ON THE REAR PANEL OF THE APPARATUS.
- PROTECT THE POWER CORD FROM DAMAGE DUE TO BEING WALKED ON, PINCHED, OR STRAINED.
- UNPLUG THE APPARATUS DURING LIGHTNING STORMS OR WHEN UNUSED FOR LONG PERIODS OF TIME.
- ONLY USE ATTACHMENTS, ACCESSORIES, STANDS, OR BRACKETS SPECIFIED BY THE MANUFACTURER FOR SAFE OPERATION AND TO AVOID INJURY.
- WARNING: TO REDUCE THE RISK OF ELECTRIC SHOCK OR FIRE, DO NOT EXPOSE THIS UNIT TO RAIN OR MOISTURE.
- SERVICE MUST BE PERFORMED BY QUALIFIED PERSONNEL.
- OUR AMPLIFIERS ARE CAPABLE OF PRODUCING HIGH SOUND PRESSURE LEVELS. CONTINUED EXPOSURE TO HIGH SOUND PRESSURE LEVELS CAN CAUSE PERMANENT HEARING IMPAIRMENT OR LOSS. USER CAUTION IS ADVISED AND EAR PROTECTION IS RECOMMENDED IF UNIT IS OPERATED AT HIGH VOLUME.
- WARNING: THIS UNIT REQUIRES A SAFETY GROUNDED OUTLET WIRED TO CURRENT ELECTRIC CODES HAVING THE LINE SUPPLY VOLTAGE, POWER, AND FREQUENCY IDENTIFIED ON THE REAR OF THE UNIT. THE OUTLET MUST REMAIN ACCESSIBLE TO DISCONNECT THE UNIT IF A FAULT SHOULD ARISE WHILE IN USE. THIS UNIT SHOULD BE UNPLUGGED WHEN NOT IN USE.



EXPLANATION OF GRAPHICAL SYMBOLS:
 EXPLICACION DE SIMBOLOS GRAFICOS:
 EXPLICATION DES SYMBOLES GRAPHIQUES:

= "DANGEROUS VOLTAGE"
 "VOLTAJE PELIGROSO"
 "DANGER HAUTE TENSION"

= "IT IS NECESSARY FOR THE USER TO REFER TO THE INSTRUCTION MANUAL"
 "ES NECESARIO QUE EL USUARIO SE REFIERA AL MANUAL DE INSTRUCCIONES."
 "REFERREZ-VOUS AU MANUAL D'UTILISATION"



An introduction To Your New Ampeg B1RE Bass Amplifier

Thank you for making one of the best choices you will ever make for your musical career – choosing one of the finest bass amplifiers available, the Ampeg B1RE.

Your new B1RE bass amplifier provides many outstanding features in a compact package that takes up only two standard rack spaces. Three hundred watts of pure bass energy, total tone control and rugged construction help make this a true performer's bass amp.

Features

In the world of high performance bass amps, Ampeg amplifiers stand alone. In true Ampeg tradition, the B1RE offers you more power, performance and flexibility than any other bass amplifier in its class. The outstanding features of your new amplifier, features which set it apart from the competition, are listed below.

- **THREE ROTARY EQ CONTROLS:** For quickly dialing in the tone you need.
- **BALANCED LINE OUTPUT:** XLR with independent level switch (20dB pad). Patch into house consoles, mixing boards, or external power amplifiers.
- **EFFECTS LOOP:** For increased intensity and quieter operation of external effects.
- **POWER AMP IN and PREAMP OUT:** Allows direct access into the power amp and a signal tap from the preamp section for even greater versatility.
- **MUSICIAN MADE IN THE U.S.A.**



The Front Panel Controls and Their Use

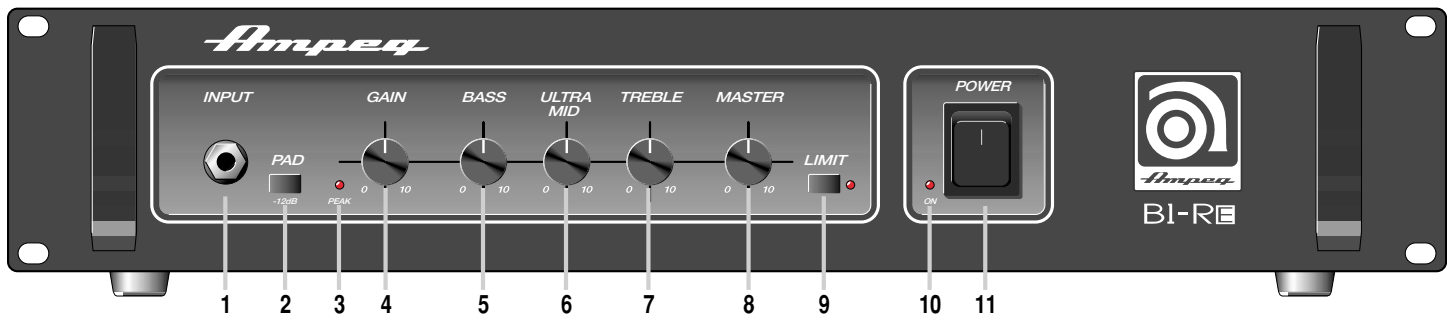

1. INPUT: Use this jack to connect your instrument to the amplifier by means of a shielded instrument cable.

2. -12dB PAD: This switch, when depressed, attenuates the input signal by 12dB. Attenuation allows the Gain control (#4) to be used over a larger portion of its range. If clipping is indicated with the Gain control near minimum, attenuation is needed.

3. PEAK: This LED illuminates when the signal level into the preamp approaches clipping. Adjust the Gain control (#4) until a strong signal from your instrument causes this LED to flash.

NOTE: If the LED flashes frequently with the Gain at a low setting, use the -12dB Pad (#2) to attenuate the input signal and readjust the Gain.

4. GAIN: Use this control to adjust the input signal level. For the best signal to noise ratio, adjust this control until the Peak LED (#3) flashes on strong signals.

5. BASS: This is the primary low frequency control which allows for 13dB of boost or 14dB of cut at 40Hz.

6. ULTRA-MID: This is the primary midrange control. Rotate the control to the left of center for a "contoured" sound (more distant, less midrange output) or to the right of center for a pronounced (more up-front) tone.

7. TREBLE: This is the primary high frequency control which allows for 18dB of boost or 23dB of cut at 8kHz.

8. MASTER: Set the overall output level of the amplifier with this control. The Effects Loop and Bal. Out (#18,19,22) are not affected by the Master control.

9. LIMITER: The B1RE uses an internal Optocoupler Limiter to assist in keeping the power amplifier's output "clean" at extreme volume levels. (All amplifiers begin to clip their output signals as they approach maximum output levels, resulting in distortion which may damage your speakers.) To engage the Limiter, depress the Limit switch. Whenever the amplifier is at full power, the adjacent Limit LED will flash. This is an indication that the limiter is keeping peak signals from clipping the output.

NOTE: Playing at full power with the Limiter off will give you increased output power, but the sound may be distorted. Use discretion when playing without the Limiter.

10. ON: This LED indicator illuminates when the POWER switch (#11) is ON.

11. POWER: This heavy-duty rocker switch applies the power to the amplifier. The amp is ON when the top of the switch is depressed, OFF when the bottom of the switch is depressed.



The Rear Panel



12. FAN: This temperature controlled, variable speed fan draws cool air into the amplifier, which forces heat out through the exhaust vents. Never block the vent holes or the fan opening.

13. FUSE: This protects the unit from damage due to overload conditions or power line surges. If the fuse blows, replace it only with the same size and type.

14. AC LINE IN: The grounded power cord should only be plugged into a grounded power outlet that meets all applicable electrical codes and is compatible with the voltage, power and frequency requirements stated on the rear panel. **Do not attempt to defeat the safety ground connection!**

15. SPEAKERS: Use these jacks to connect the amplifier to your speaker(s) using high quality speaker cables terminated with 1/4" connectors.

WARNING: The speaker output of this unit can exceed 10 Watts and could be a shock injury. Connection to speakers should be performed by a skilled person in compliance with local building codes. Class 2 wiring is required for speaker cables. Use of external speakers outside the ratings stated at the speaker jack may result in a shock injury or damage to the unit.

NOTE: When connecting multiple speaker cabinets to the B1RE, keep the overall impedance at or above four ohms! The following chart shows the total impedance load when connecting speaker cabinets in parallel:

Cabinet Impedance	# of Cabs	Total Impedance
8Ω	2	4Ω
16Ω	2	8Ω
16Ω	4	4Ω

16. POWER AMP IN: This mono jack allows you to feed the preamp output of another amplifier to the input of the B1RE's internal power amp. This bypasses the pre-amp circuitry of the B1RE.

WARNING: This jack goes directly into the power amplifier. DO NOT connect high level signals to it!

17. PREAMP OUT: A post-EQ signal may be taken from this jack and sent to the house mixing board, recording console or external power amplifier.

18. EFFECTS LOOP RETURN: To use an external effects device, connect the OUTPUT of the device to this jack by means of a shielded cable. This feeds the processed signal into the Master section of the B1RE.

19. EFFECTS LOOP SEND: Connect the output from this jack to the INPUT of your effects by means of a shielded cable. This sends a post-EQ signal to your effects.

20. -20dB/0dB: This switch sets the output level at the Bal. Out jack (#22). The control works independently from the front panel Master control. Depressing the switch activates the 20dB pad. The result is a signal that is more compatible with the microphone inputs on a mixer.

21. POST/PRE: You can select either Pre or Post EQ for the signal at the Bal. Out jack (#22) with this switch. With the switch in the OUT position, the signal at the jacks will be Pre-EQ. This is a direct output not affected by any EQ or boost settings. With the switch depressed, the signal is Post-EQ and is controlled and modified by the tone controls and Effects Loop.

22. BAL. OUT: This XLR-type connector supplies a balanced preamp output signal for connecting to a house mixing board, recording console or external amplifiers with balanced inputs. The signal can be set to Pre or Post EQ by the back panel Pre/Post switch (#21). The level can be adjusted for either mic or line type inputs using the -20dB/0dB switch (#20).



Some Suggested Settings

The setting of the Gain control depends on your particular instrument. The Master should be set to produce the appropriate output volume level. The Graphic EQ can be used to tailor the amplifier to your speaker cabinets, to compensate for room acoustics and to "fine tune" your sound.

ROCK:

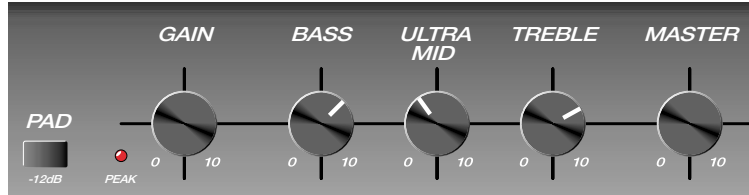

JAZZ:

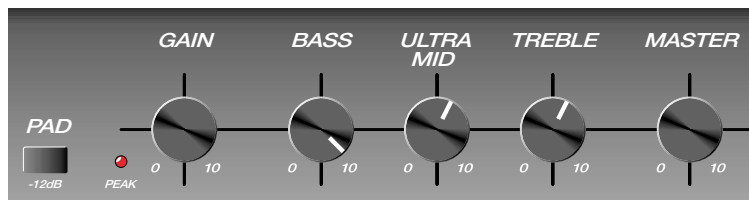

COUNTRY:

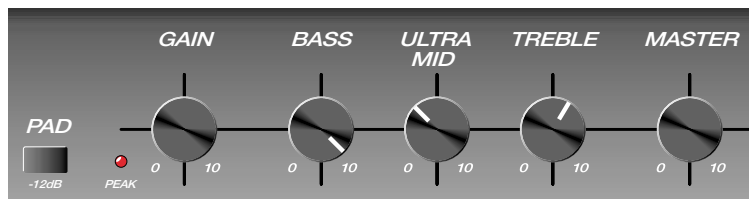

FUNK "POPPING:"

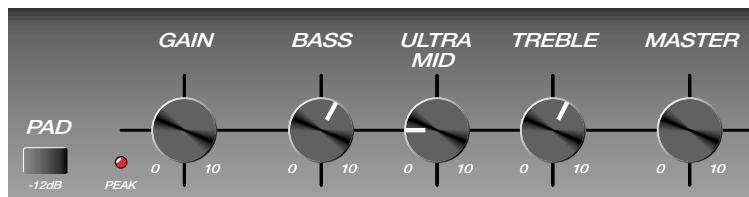

Rack Mounting:

When mounting the B1RE into a rack, the four bottom feet should be removed to maintain the two rack space height of the amplifier. Be sure to keep the feet and their attachment bolts for future use. If the feet are reinstalled, never use screws which will protrude farther into the amplifier than the original hardware.

The rack must be a high quality enclosure capable of securely supporting the weight of the amplifier. Tighten the mounting screws securely through the amplifier's face plate, into the rack rails. Check the rack and mounting screws occasionally to ensure a continually safe and secure installation.



Troubleshooting

In the unlikely event that your B1RE should malfunction, take a few minutes to troubleshoot it before you call for service. You can save yourself a lot of time and sometimes money by doing it yourself, and often the cure for the problem is something quite simple.

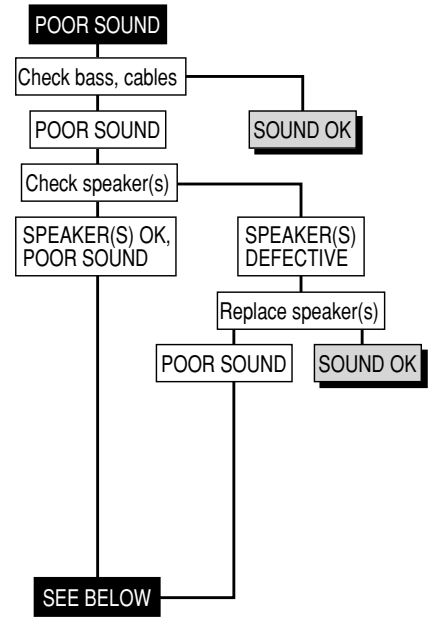
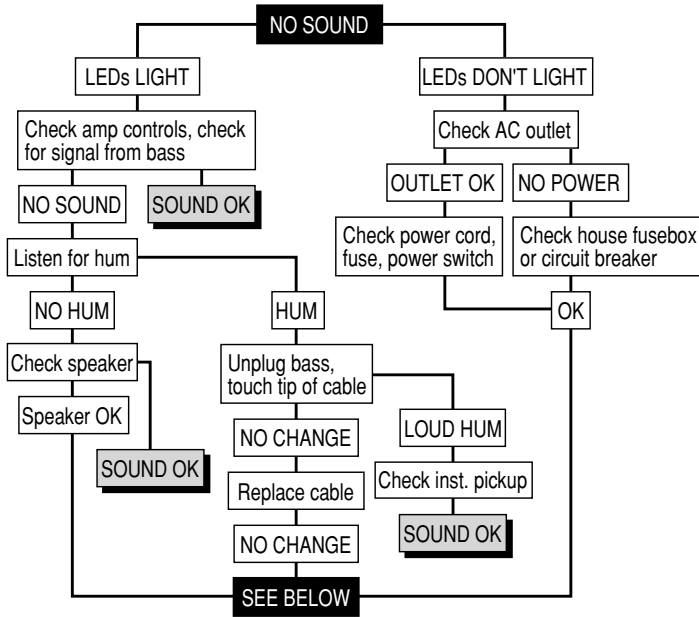

If the problem isn't covered above, or if the steps lead you here, then contact your Ampeg dealer for service information. Also, you should refer your amp to an authorized service center for servicing if it gets dropped, has liquid spilled into it, or sustains damage to its power cord.

System Block Diagram

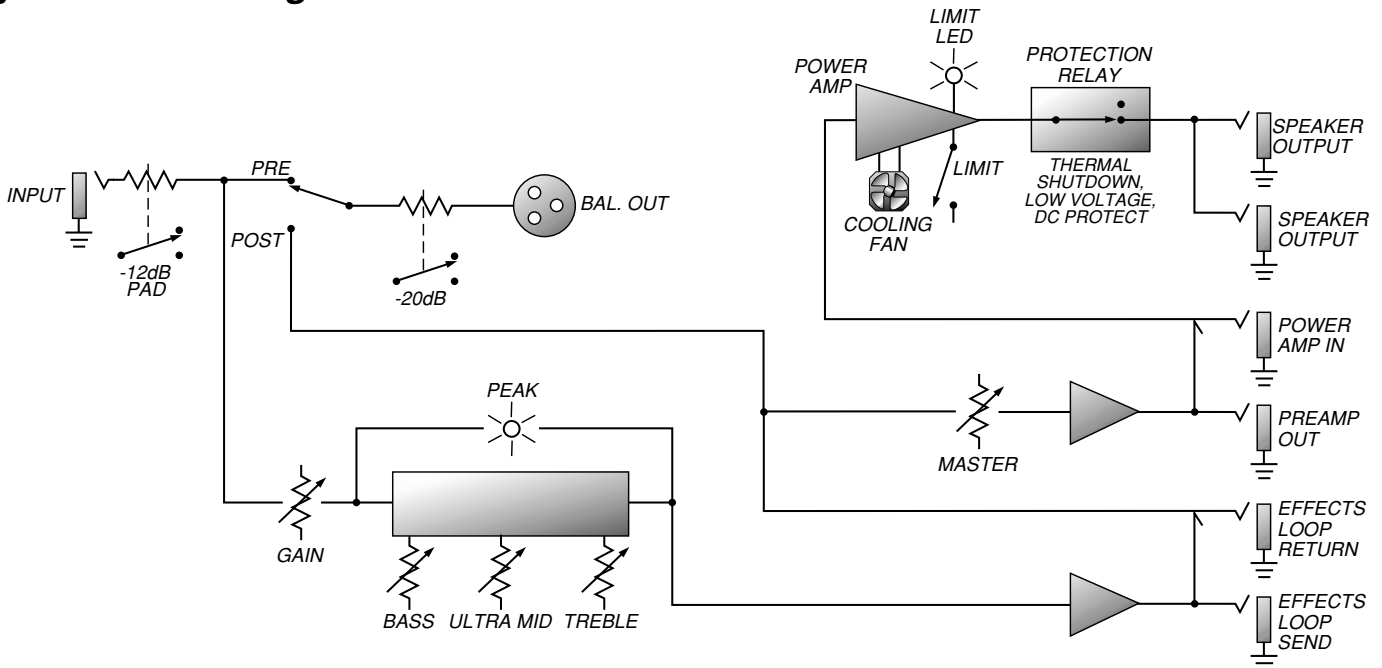



Technical Specifications

OUTPUT POWER RATING	300 Watts RMS, 4 ohm load
	175 Watts RMS, 8 ohm load

POWER REQUIREMENTS

Domestic:	120VAC, 60Hz, 300VA
Export:	100/120VAC, 50/60Hz, 300VA
	230-240VAC, 50/60Hz, 300VA

TONE CONTROL RANGE

Bass:	+14/-13dB @ 40Hz
Ultra Mid:	+5/-11dB @ 350Hz
Treble:	+18dB/-23dB @ 8kHz

GAIN	72dB
-------------	------

SIGNAL TO NOISE RATIO	80dB typical
------------------------------	--------------

SIZE AND WEIGHT	19" W x 3.25" H x 10" D; 18 lbs.
------------------------	----------------------------------

Ampeg reserves the right to change specifications without notice.



Free Manuals Download Website

<http://myh66.com>

<http://usermanuals.us>

<http://www.somanuals.com>

<http://www.4manuals.cc>

<http://www.manual-lib.com>

<http://www.404manual.com>

<http://www.luxmanual.com>

<http://aubethermostatmanual.com>

Golf course search by state

<http://golfingnear.com>

Email search by domain

<http://emailbydomain.com>

Auto manuals search

<http://auto.somanuals.com>

TV manuals search

<http://tv.somanuals.com>