

**MODEL  
ME7840A  
POWER AMPLIFIER TEST SYSTEM**

**OPERATION AND  
MAINTENANCE MANUAL**

---

---

The Anritsu logo is displayed in a bold, sans-serif font. It is centered horizontally and is flanked by two horizontal lines on each side, which extend towards the left and right margins of the page.

490 JARVIS DRIVE - MORGAN HILL, CA 95037-2809

P/N: 10410-00225  
REVISION: A  
PRINTED: JUNE 2000  
COPYRIGHT 2000 ANRITSU CO

### **WARRANTY**

The ANRITSU product(s) listed on the title page is (are) warranted against defects in materials and workmanship for three years from the date of shipment.

ANRITSU's obligation covers repairing or replacing products which prove to be defective during the warranty period. Buyers shall prepay transportation charges for equipment returned to ANRITSU for warranty repairs. Obligation is limited to the original purchaser. ANRITSU is not liable for consequential damages.

### **LIMITATION OF WARRANTY**

The foregoing warranty does not apply to ANRITSU connectors that have failed due to normal wear. Also, the warranty does not apply to defects resulting from improper or inadequate maintenance by the Buyer, unauthorized modification or misuse, or operation outside of the environmental specifications of the product. No other warranty is expressed or implied, and the remedies provided herein are the Buyer's sole and exclusive remedies.

### **TRADEMARK ACKNOWLEDGEMENTS**

V Connector and K Connector are registered trademarks of ANRITSU Company.

GPC-7 is a registered trademark of Amphenol Corporation.

Ink Jet and Think Jet are registered trademarks of Hewlett-Packard Co.

MS-DOS is a registered trademark of Microsoft Corporation.

### **NOTICE**

ANRITSU Company has prepared this manual for use by ANRITSU Company personnel and customers as a guide for the proper installation, operation and maintenance of ANRITSU Company equipment and computer programs. The drawings, specifications, and information contained herein are the property of ANRITSU Company, and any unauthorized use or disclosure of these drawings, specifications, and information is prohibited; they shall not be reproduced, copied, or used in whole or in part as the basis for manufacture or sale of the equipment or software programs without the prior written consent of ANRITSU Company.

## **DECLARATION OF CONFORMITY**

**Manufacturer's Name:** ANRITSU COMPANY

**Manufacturer's Address:** Microwave Measurements Division  
490 Jarvis Drive  
Morgan Hill, CA 95037-2809  
USA

declares that the product specified below:

**Product Name:** Power Amplifier Test System

**Model Number:** MS4782A, MS4782D

conforms to the requirement of:

EMC Directive 89/336/EEC as amended by Council Directive 92/31/EEC & 93/68/EEC  
Low Voltage Directive 73/23/EEC as amended by Council directive 93/68/EEC

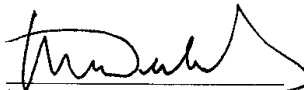
### **Electromagnetic Interference:**

**Emissions:** CISPR 11:1990/EN55011:1991 Group 1 Class A

**Immunity:** EN 61000-4-2:1995/EN50082-1:1997 - 4kV CD, 8kV AD  
EN 61000-4-3:1997/EN50082-1:1997 - 3V/m  
ENV 50204/EN50082-1:1997 - 3V/m  
EN 61000-4-4:1995/EN50082-1:1997 - 0.5kV SL, 1kV PL  
EN 61000-4-5:1995/EN50082-1:1997 - 1kV L-L, 2kV L-E

### **Electrical Safety Requirement:**

**Product Safety:** IEC 1010-1:1990 + A1/EN61010-1: 1993

  
Director of Corporate Quality

Morgan Hill, CA

07-JUN-00  
Date

European Contact: For Anritsu product EMC & LVD information, contact Anritsu LTD, Rutherford Close,  
Stevenage Herts, SG1 2EF UK, (FAX 44-1438-740202)



# Safety Symbols

To prevent the risk of personal injury or loss related to equipment malfunction, ANRITSU Company uses the following symbols to indicate safety-related information. For your own safety, please read the information carefully BEFORE operating the equipment.







## Symbols used in manuals

DANGER	This indicates a very dangerous procedure that could result in serious injury or death if not performed properly.
WARNING	This indicates a hazardous procedure that could result in serious injury or death if not performed properly.
CAUTION	This indicates a hazardous procedure or danger that could result in light-to-severe injury, or loss related to equipment malfunction, if proper precautions are not taken.

## Safety Symbols Used on Equipment and in Manuals

(Some or all of the following five symbols may or may not be used on all ANRITSU equipment. In addition, there may be other labels attached to products that are not shown in the diagrams in this manual.)

The following safety symbols are used inside or on the equipment near operation locations to provide information about safety items and operation precautions. Ensure that you clearly understand the meanings of the symbols and take the necessary precautions BEFORE operating the equipment.

	This indicates a prohibited operation. The prohibited operation is indicated symbolically in or near the barred circle.
	This indicates a compulsory safety precaution. The required operation is indicated symbolically in or near the circle.
	This indicates warning or caution. The contents are indicated symbolically in or near the triangle.
	This indicates a note. The contents are described in the box.
 	These indicate that the marked part should be recycled.

---

# For Safety

---

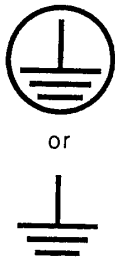
**WARNING**



Always refer to the operation manual when working near locations at which the alert mark, shown on the left, is attached. If the operation, etc., is performed without heeding the advice in the operation manual, there is a risk of personal injury. In addition, the equipment performance may be reduced.

Moreover, this alert mark is sometimes used with other marks and descriptions indicating other dangers.

**WARNING**



When supplying power to this equipment, connect the accessory 3-pin power cord to a 3-pin grounded power outlet. If a grounded 3-pin outlet is not available, use a conversion adapter and ground the green wire, or connect the frame ground on the rear panel of the equipment to ground. If power is supplied without grounding the equipment, there is a risk of receiving a severe or fatal electric shock.

**WARNING**

Repair



This equipment can not be repaired by the operator. DO NOT attempt to remove the equipment covers or to disassemble internal components. Only qualified service technicians with a knowledge of electrical fire and shock hazards should service this equipment. There are high-voltage parts in this equipment presenting a risk of severe injury or fatal electric shock to untrained personnel. In addition, there is a risk of damage to precision components.

**WARNING**



Use two or more people to lift and move this equipment, or use an equipment cart. There is a risk of back injury, if this equipment is lifted by one person.

# Table of Contents

---

## Chapter 1 General Information

SCOPE OF THIS MANUAL . . . . .	1-1
INTRODUCTION . . . . .	1-1
RELATED MANUALS . . . . .	1-1
CONVENTIONS . . . . .	1-2
SERIAL NUMBER . . . . .	1-2
ONLINE MANUALS . . . . .	1-2
PATS SYSTEM OVERVIEW . . . . .	1-2
HARDWARE DESCRIPTION . . . . .	1-2
SYSTEM DESCRIPTION . . . . .	1-5
DRA Scorpion . . . . .	1-5
<b>MS4782X Test Set . . . . .</b>	<b>1-6</b>
Connectors and Ports . . . . .	1-7
K FACTOR . . . . .	1-9
ADAPTIVE P STOP . . . . .	1-9
SOFTWARE DESCRIPTION . . . . .	1-9
TEST EXECUTIVE . . . . .	1-9
SOFTWARE STRUCTURE . . . . .	1-11
MS7840A OPTIONS . . . . .	1-12
OPTIONAL ACCESSORIES . . . . .	1-12
PREVENTIVE MAINTENANCE . . . . .	1-13
USER SUPPLIED TEST SET . . . . .	1-13
PERFORMANCE SPECIFICATIONS . . . . .	1-13
RECOMMENDED ITEMS . . . . .	1-15
USER SUPPLIED ITEMS . . . . .	1-15

## Chapter 2 Installation

INTRODUCTION . . . . .	2-1
EQUIPMENT COMPLEMENT . . . . .	2-1
UNPACKING and INSPECTION . . . . .	2-1
INSTALLATION - HARDWARE . . . . .	2-2
INSTALLATION - SOFTWARE . . . . .	2-7

Installation . . . . .	2-7
What else is on the CD?. . . . .	2-7
Uninstalling the software. . . . .	2-7
SERVICE CENTERS . . . . .	2-8

**Chapter 3 Operations, General**

INTRODUCTION . . . . .	3-1
PREPARING THE SYSTEM . . . . .	3-1
Unused Connections . . . . .	3-2
USING PATS SOFTWARE . . . . .	3-4
Software	
Organization. . . . .	3-4
COLLATERAL FUNCTIONS . . . . .	3-5
File. . . . .	3-5
Help . . . . .	3-6
Tools . . . . .	3-7

**Chapter 4 Operations, Calibration**

INTRODUCTION . . . . .	4-1
OPERATION, GENERAL . . . . .	4-1
PROGRAM FILES. . . . .	4-1
TEST EQUIPMENT. . . . .	4-2
GENERAL . . . . .	4-3
POWER LEVEL . . . . .	4-4
HOT S22 . . . . .	4-8
S-PARAMETERS CAL . . . . .	4-11
CAL FILE SETUP . . . . .	4-15

**Chapter 5 Operations, Measurement**

INTRODUCTION . . . . .	5-1
OPERATION, GENERAL . . . . .	5-1
MEASUREMENT CALIBRATION . . . . .	5-1
GENERAL . . . . .	5-1
Calibration(s) Completed . . . . .	5-1
Calibration(s) Not Completed . . . . .	5-2
S-PARAMETER TESTS: $S_{21}$ , $S_{11}$ , $S_{22}$ , $S_{12}$ , ALL . . . . .	5-4
S-PARAMETER TEST: K FACTOR. . . . .	5-7
POWER SWEEP, TWO TONE. . . . .	5-10
Single Frequency Power Sweep . . . . .	5-10
Multiple Frequency Power Sweep. . . . .	5-14



Gain and IMD Power Sweep . . . . .	5-18
POWER SWEEP, ONE TONE . . . . .	5-22
Single Frequency Power Sweep . . . . .	5-22
IMD . . . . .	5-26
HARMONICS . . . . .	5-29
HOT S22 . . . . .	5-32

**Chapter 6 Performance Verification Procedure**

INTRODUCTION . . . . .	6-1
CONVENTIONS . . . . .	6-1
TEST EQUIPMENT . . . . .	6-1
SOURCE OUTPUT ACCURACY . . . . .	6-2
Setup: . . . . .	6-2
Test Procedure . . . . .	6-2
RETURN LOSS CONFIDENCE TEST . . . . .	6-3
Setup. . . . .	6-3
Test Procedure: . . . . .	6-4
SYSTEM DYNAMIC RANGE . . . . .	6-6
Test Procedure: . . . . .	6-6
RECEIVER DISPLAY LINEARITY . . . . .	6-8
Setup: . . . . .	6-8

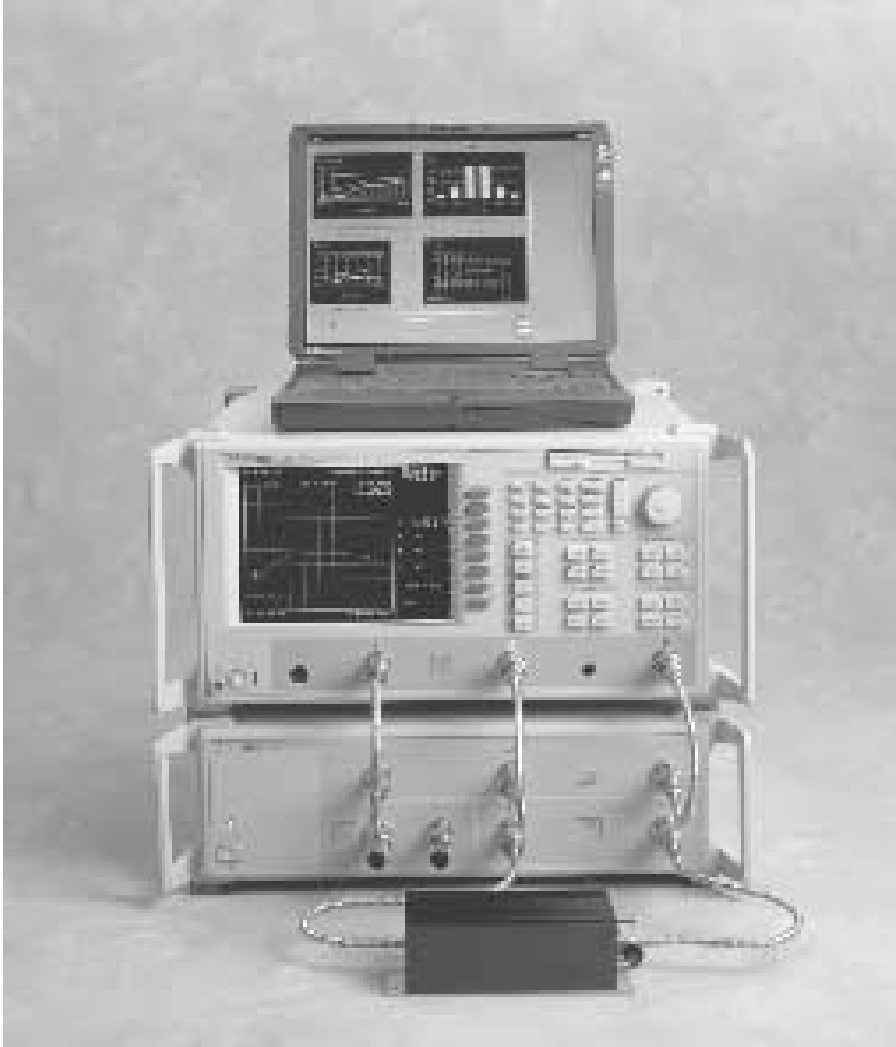
**Chapter 7 Preampfier Operations**

INTRODUCTION . . . . .	7-1
USE OF EXTERNAL PREAMPLIFIERS. . . . .	7-1
Alternative 1 . . . . .	7-1
Alternative 2 . . . . .	7-1

**Appendix A Calibration Specification Files**

INTRODUCTION . . . . .	A-1
FILE TYPES. . . . .	A-1
OPEN FILES . . . . .	A-1
TECHNICAL DETAILS. . . . .	A-1
POWER LEVE.TXT . . . . .	A-11
CAL FILES SETUP.TXT. . . . .	A-11
HOT S <sub>22</sub> .TXT . . . . .	A-13
S-PARAMETERS. TXT . . . . .	A-14





---

**Figure 1-1.** Model ME7840A Power Amplifier Test System (PATS)

# Chapter 1

## General Information

### **1-1** SCOPE OF THIS MANUAL

This manual provides operating and maintenance information for the ME7840A Power Amplifier Test System (PATS, Figure 1-1). The following topics are discussed:

- Equipment Description
- Equipment Installation and Connection
- Software Description
- Software Installation
- Calibration
- System Operation
- Test Procedures and Test Results Interpretation
- System Performance Verification

The procedures described in this manual presume a working knowledge of vector network analyzers and RF power amplifier testing procedures. Refer to the other manuals supplied with the ME7840A (see below) for more detailed explanations of the system equipment and procedures.

### **1-2** INTRODUCTION

This chapter provides information to familiarize the user with the basic ME7840A Power Amplifier Test System. Included is information about related manuals, and the available models and options.

### **1-3** RELATED MANUALS

The ME7840A manual set consists of the following manuals: The operating and programming manuals are supplied with the equipment; the maintenance manuals are optional items that may be purchased.

Manual Description	ANRITSU Part Number
ME7840A Operating & Maintenance Manual (OMM)	10410-00225
MS462XX Operating Manual (OM)	10410-00203
MS462XX Programming Manual (PM)	10410-00204
MS462XX Maintenance Manual (MM)	10410-00205 (Optional)
MS4782X Test Set Maintenance Manual (MM)	10410-00218 (Optional)

**1-4 CONVENTIONS**

Throughout this manual, the ME7840A Power Amplifier System may be referenced as PATS or ME7840A; the MS462XC may be referenced as Scorpion or MS462XC; and the MS4782X Test Set may be referenced as Test Set or MS4782X.

**1-5 SERIAL NUMBER**

All ANRITSU instruments are assigned a unique six-digit serial number, such as "940101." This number is affixed to a decal on the rear panel of each unit. In any correspondence with ANRITSU Customer Service, please use this number.

**1-6 ONLINE MANUALS**

This manual is available on CD ROM as an Adobe Acrobat™ (\*.pdf) file. The file can be viewed using Acrobat Reader™, a free program that is also available on the CD ROM. This file is "linked" such that the viewer can choose a topic to view from the displayed "bookmark" list and "jump" to the manual page on which the topic resides. The text can also be word-searched. CD ROM part numbers are available on ANRITSU's Internet home page (<http://www.global.anritsu.com/library/>). You can also contact ANRITSU Customer Service for price and availability.

**1-7 PATS SYSTEM OVERVIEW**

The ANRITSU ME7870A Power Amplifier Test System (PATS) is intended for the measurement and real-time graphical display of the following parameters of a power amplifier in the frequency range of 10 MHz to 6 GHz:

- S-Parameters including Hot S<sub>22</sub>
- K Factor
- Gain Compression and Phase Distortion
- Intermodulation Distortion
- Harmonics
- Drain Current and Power Added Efficiency (PAE)

PATS is designed to facilitate alignment, tuning and pass/fail testing of the components, modules and subassemblies of a power amplifier as well as the completed amplifier.

**1-8 HARDWARE DESCRIPTION**

The ME7840A hardware (Figure 1-1) consists of a MS462XC, Direct Receiver Access (DRA) Scorpion, a MS4782X Test Set, a customer supplied Personal Computer (PC), and an optional current probe (refer to Chapter 2, Figure 2-4). The MS462XC is available in two frequency ranges: 10 MHz to 3 GHz or 10 MHz to 6 GHz.

The Test Set is available in two configurations, as described in Table 1-1. The MS4782D is standard, and the MS4782A is Option 2. A block diagram of the PATS is shown in Figure 1-2 and the Option 2 system in Figure 1-3.

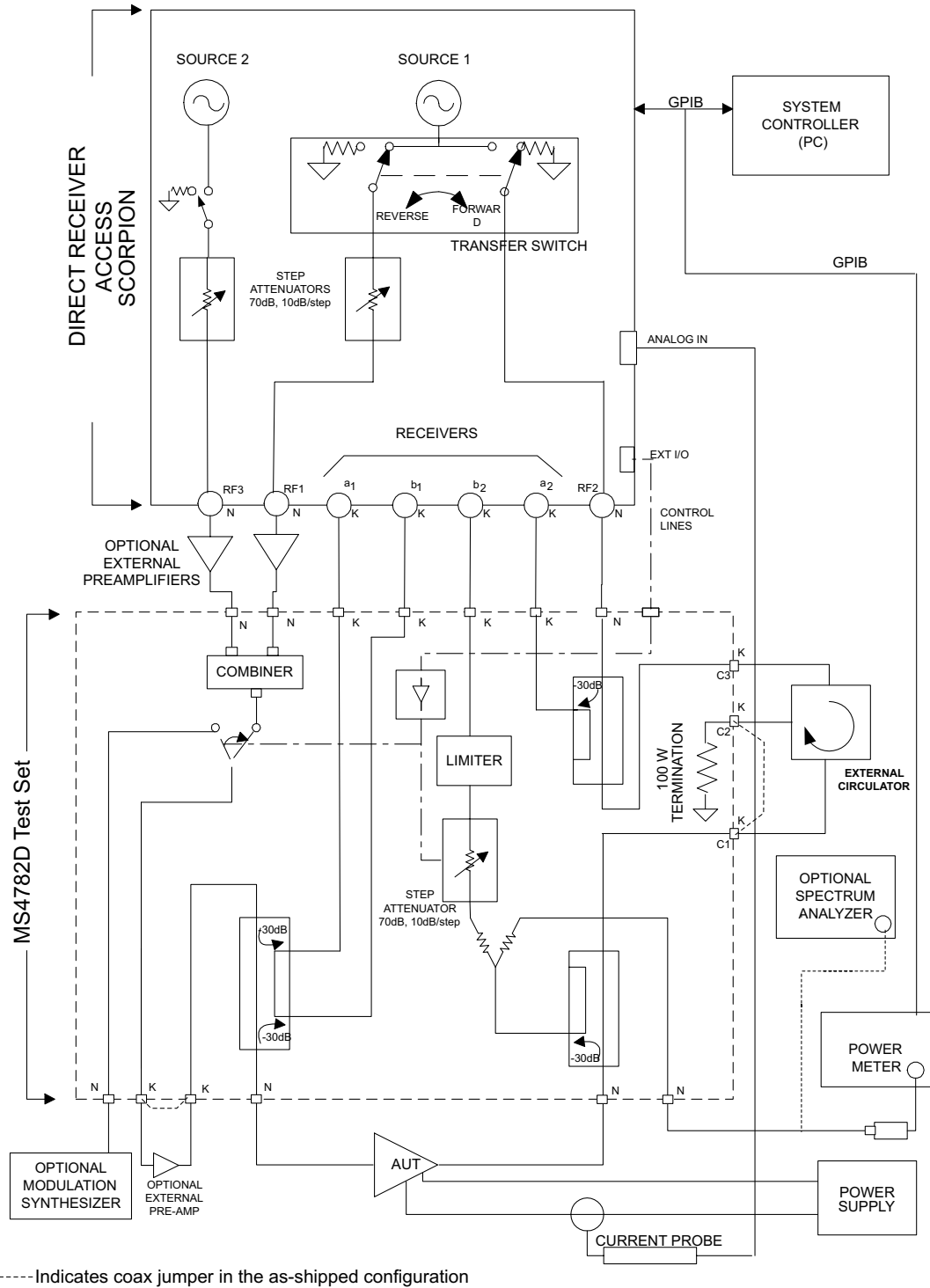
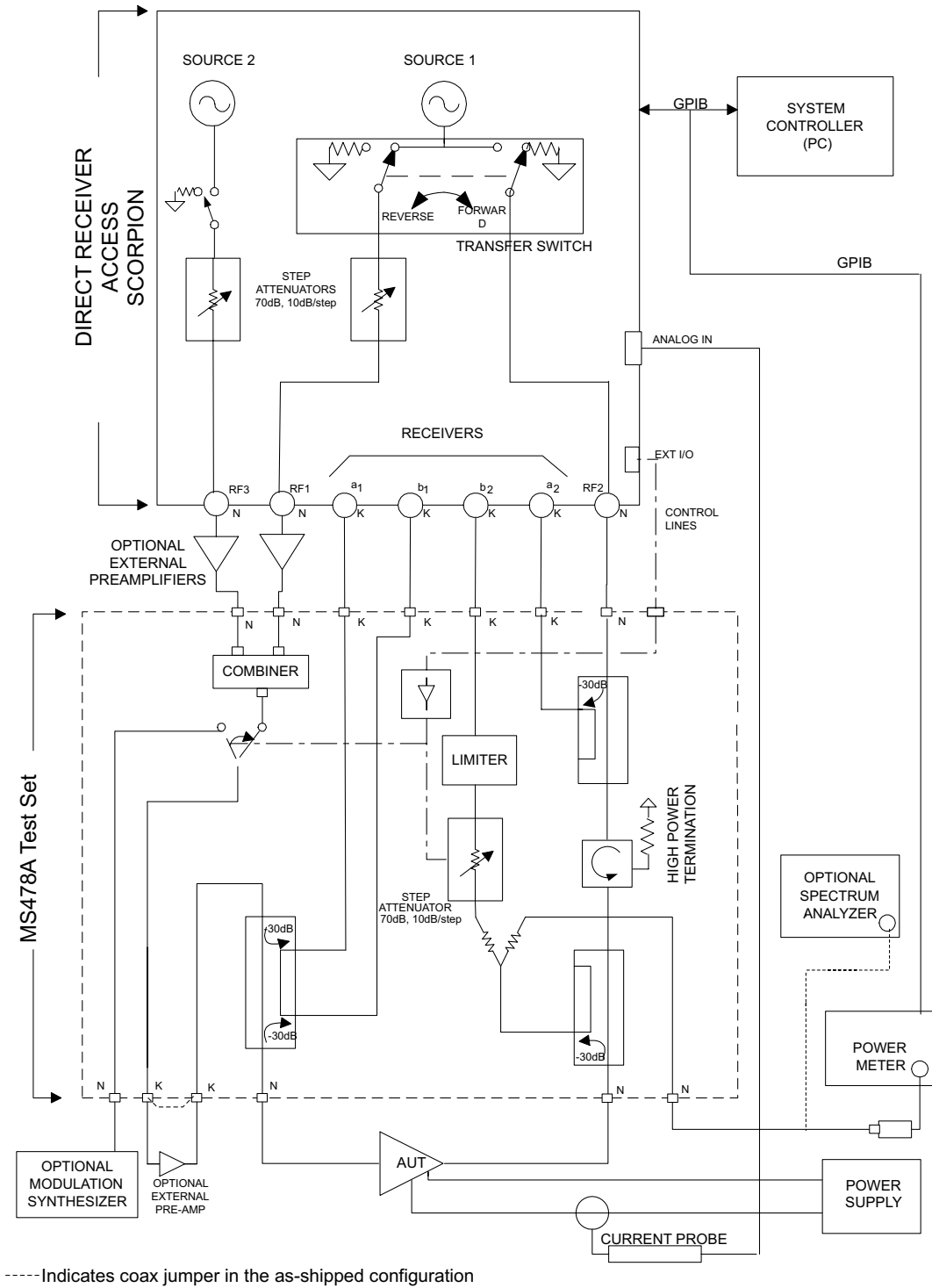


Figure 1-2. Overall Functional Block Diagram of the Basic Power Amplifier Test System (PATS) with MS4782D Test Set



**Figure 1-3.** Overall Functional Block Diagram of the Option 2 Power Amplifier Test System (PATS) with MS4782A Test Set

**Table 1-1. Test Set Configurations**

Model	Frequency Range (MHz)	Max AUT Power Output (Watts)	Reverse Measurements ( $S_{22}$ , Hot $S_{22}$ , $S_{12}$ Possible)	Circulator (at AUT Output Path)
MS4782A	800 to 1000	50	Yes	Internal
MS4782D	800 to 2400 (Note 1)	100 (Note 2)	Yes	External

**Notes:**

1. This frequency range does not account for any restricting effects caused by use of external circulator.
2. This Max AUT power assumes a minimum isolation of 23 dB provided by external circulator(s). Two circulators may have to be used to provide the required isolation.

**1-9 SYSTEM DESCRIPTION**

Brief descriptions of the DRA Scorpion (MS462XC) and MS4782X Test Set are given below.

**DRA Scorpion**

The Scorpion Direct Receiver Access (DRA) version Vector Network Measurement System (VNMS) (Figure 1-2) functions under control of the software residing in the PC through GPIB commands. The software supports tuning and alignment operations by generating real time graphic displays of the measured data on the PC screen.

Under software control, 3<sup>rd</sup>, 5<sup>th</sup> and 7<sup>th</sup> order IMD products can be measured and displayed. Also, the Upper and Lower Side Band (USB & LSB) components of the IMD products are measured and displayed separately.

The DRA Scorpion includes the following capabilities:

- ❑ Two internal, independent RF sources. Each source has a range of -15 dBm to +10 dBm. A 0dB to 70dB step attenuator (10 dB / step) is provided for each source resulting in a Power Output range of -85 dBm to +10 dBm from each source.

**NOTE**

After test set losses, the maximum net power at the input of the amplifier under test (AUT) is +5 dBm.

- ❑ Complete built-in capability for IMD measurements. A combiner is provided in the Test Set.
- ❑ Internal Transfer Switch enabling  $S_{22}$  and Hot  $S_{22}$  measurements. The reflectometer set-up is provided in the Test Set.
- ❑ Direct access to each of the four receiver channels (two reference channels and two test channels) for maximum flexibility in measuring forward and reverse S-parameters over a wide range of AUT output power. The Test Set provides incident and reflected signal separation.



**MS4782X Test Set**

The Series MS4782X Test Set contains a Wilkinson type combiner that combines the two RF signals from Ports 1 and 3 (RF1 & RF3) of the Scorpion. External preamplifiers can optionally be provided at the combiner input to boost the input RF power to the amplifier-under-test (AUT). The combiner has power input rating of 30-Watts maximum when terminated with a VSWR of 1.2:1. For an open or short at the combiner output, the combiner input power rating is 0.5 Watts maximum.

The output of the combiner is fed to a source selection switch that enables one of the following to be applied to the AUT:

- The combined signal from the Scorpion sources.
- A modulated signal from an optional external modulation synthesizer.

A provision for the insertion of an optional external pre-amplifier (after the combiner and source selection switch) is also provided. Refer to Chapter 7, "Preamplifier Operations," for details.

The test set includes a bi-directional coupler at the input of the AUT that separates the incident signal from the reflected signal. The power rating of this bi-directional coupler is 100 watts average. The  $-30$  dB portion of the incident and reflected signals are applied to the Scorpion reference port a<sub>1</sub> and test port b<sub>1</sub>, respectively, for  $S_{11}$  measurement. The  $S_{11}$  measurement determined by the DRA Scorpion is simply the ratio of the reflected signal to the incident signal.

The amplified output of the AUT is fed to a high power coupler in the test set. The power rating of this coupler is also 100-watts average. The  $-30$  dB coupled arm of this coupler is routed to the test port b<sub>2</sub> of the Scorpion through a 6 dB resistive divider and a 0-dB to 70-dB step attenuator (10dB/step). A limiter is also provided in this path provide added protection for the Scorpion reference channel .

The divider enables the connections of a power meter or Spectrum Analyzer, when desired, to measure the AUT b<sub>2</sub> output.

The through arm of the 100-W coupler is routed to a high power (100-Watt) termination through a circulator. In the MS4782A Test Set, the circulator is internal and has a rating of 100 watts average. This circulator has an isolation specification of 20-dB minimum. This means that the AUT output power is attenuated by 20 dB (plus other losses) before reaching the Scorpion port 2. Since the maximum (no-damage) power level for this port is 27 dBm (0.5 watt), this establishes the maximum AUT output power at 50 watts.

In the MS4782D Test Set, the circulator is external as shown in Figure 1-2. In selecting an external circulator, the following criteria should be used.

- *Power rating:* Should be no less than the power output of the amplifier-under-test (AUT). It should be noted that a 100 watt termination is provided in the Test Set for the termination port of the external circulator.

- *Bandwidth:* Should be sufficiently wide to cover the frequency band of the AUT.
- *Isolation:* Should be no less than  $(P_o - 27 \text{ dB})$ , where  $P_o$  is the power output in dBm of the AUT. Thus for  $P_o = 47 \text{ dBm}$  (50 watts), a 20 dB isolation is required. For a  $P_o$  greater than 47 dBm up to 50 dBm (100 watts), two circulators in series can be used.

Where  $S_{22}$  or Hot  $S_{22}$  measurements are not required, power amplifiers with up to 100 watts average output power can be tested with the MS4782D Test Set without any circulator by connecting the through arm of the output coupler directly to the 100 watt termination (Port C1 connected to Port C2 on the rear. The unit is shipped from the factory with this loop jumper.)

For  $S_{22}$  measurements, the transfer switch located within the Scorpion routes the source 1 output signal to the output port of the AUT via Port 2 (RF2) of the Scorpion. A separate 100-watt coupler in the test set applies the  $-30 \text{ dB}$  portion of this incident signal to the Scorpion reference port  $a_2$ . The  $-30 \text{ dB}$  portion of the signal reflected from the AUT output port is applied to the Scorpion test port  $b_2$  by means of the AUT output coupler.

The PATS calibration is performed with the test set in place, at the connectors where AUT will be connected directly. Therefore, the test set components and cables are included in the calibration loop and their effects are calibrated out, resulting in correct and accurate measurements of the AUT.

The software supplied by ANRITSU supports operator control of the source selection switch and step attenuator in the test set. This control is achieved through the parallel TTL control lines available at the Scorpion rear panel "External I/O" connector. The GPIB commands from the PC to the Scorpion set the TTL control lines to the desired states.

### **Connectors and Ports**

#### **CAUTION**

Connecting the external circulator incorrectly or placing a direct connection between C1 and C3 on MS4782D rear panel will cause permanent damage to MS462XC.

On the front panel of the Model MS4622/3C DRA Scorpion three Type N (female) connectors are provided for Ports 1, 2 and 3.

Port 1 provides RF source 1 when the transfer switch is in the forward position, and is terminated in 50 ohms to ground when the transfer switch is in the reverse position.

Port 2 provides RF source 1 when the transfer switch is in the reverse position, and is terminated in 50 ohms to ground when the transfer switch is in the forward position.

Port 3 is allocated to RF source 2. Under independent control, port 3 provides RF source 2, or is terminated in 50 ohms to ground.

On the rear of the unit, four SMA connectors (Figure 1-4) are provided for Reference ports  $a_1$  and  $a_2$  and Test Ports  $b_1$  and  $b_2$ . The front of the unit as well as all other mechanical specifications is the same as the model MS4623B.

On the MS4782D Test Set, three additional SMA connectors provide for connecting an external circulator. If reverse measurements ( $S_{22}$  and Hot

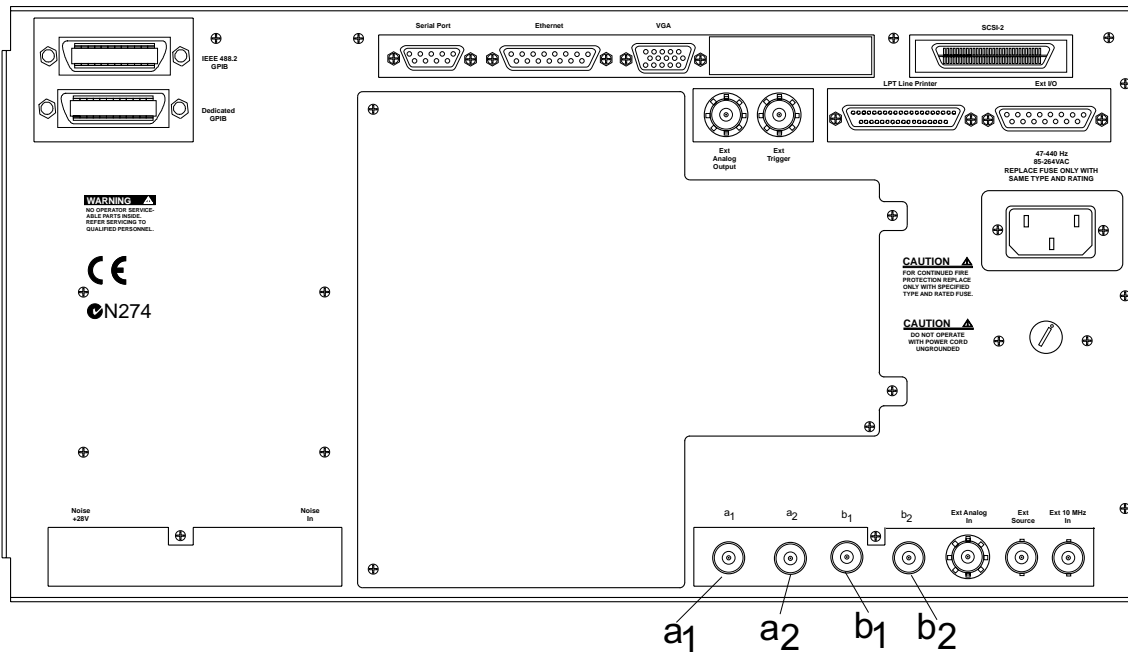


Figure 1-4. MS462XC Rear Panel Showing Ports a<sub>1</sub>, a<sub>2</sub>, b<sub>1</sub>, and b<sub>2</sub>

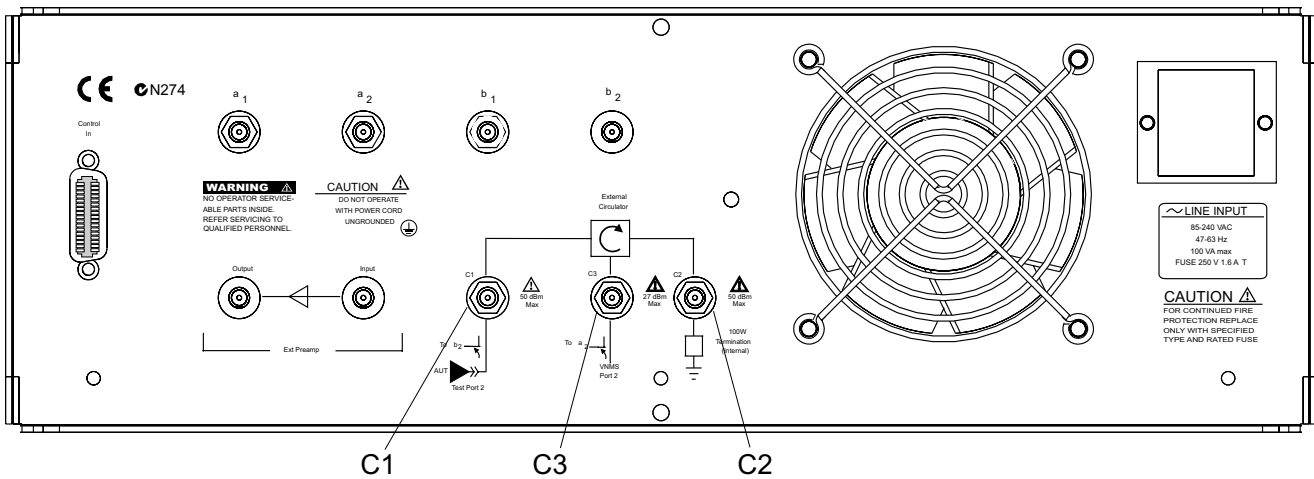


Figure 1-5. MS4782A Rear Panel Showing Circulator Connections C1, C2, and C3

$S_{22}$ ) are not desired, then a circulator is not required. Instead, a through line should be connected between connectors C1 and C2 (Figure 1-5). The MS4782A is shipped from the factory with this through line in place.

### 1-10 K FACTOR

K factor is a parameter which is sometimes used to indicate the stability of an amplifier. K factor is a function of all four S parameters and is defined by the formula

$$K = \frac{1 - |S_{11}|^2 - |S_{22}|^2 + |\Delta|^2}{2|S_{11}S_{21}|}$$

Where

$$\Delta = S_{11}S_{22} - S_{12}S_{21}$$

The necessary and sufficient condition for unconditional stability is that  $K > 1$  and  $|\Delta| < 1$ .

K factor is available as the sixth choice in the S parameters menu (first five choices are:  $S_{11}$ ,  $S_{22}$ ,  $S_{21}$ ,  $S_{12}$  and ALL). The same conditions and setup as S-parameter measurements including a full 12-term calibration applies to this measurement. The result is "dynamic" meaning that the above formula is applied at each point for each sweep as the S parameters are reported to the PC over the GPIB.

### 1-11 ADAPTIVE P STOP

Adaptive P stop lets users enter a gain compression value at which the program will adjust the final  $P_{in}$  value during a power sweep. For example, if user sets 3 dB P-stop, the program commands the execution of one sweep, find  $P_{in}$  value where 3 dB gain compression occurs, back up 1 increment, and reset this as the upper bound of the power sweep.

### 1-12 SOFTWARE DESCRIPTION

The ME7840A software exhibits an open architecture that has been developed using standard C++ and Visual Basic languages. The software is compiled as an Active X exe module.

The software resides in the System Controller (PC), and communicates with the Direct Receiver Access (DRA) Scorpion® Vector Network Measurement System (VNMS) via the GPIB bus. Optionally, the ME7840A software can also interface with additional GPIB capable test equipment, such as a multimeter or a power meter.

### 1-13 TEST EXECUTIVE

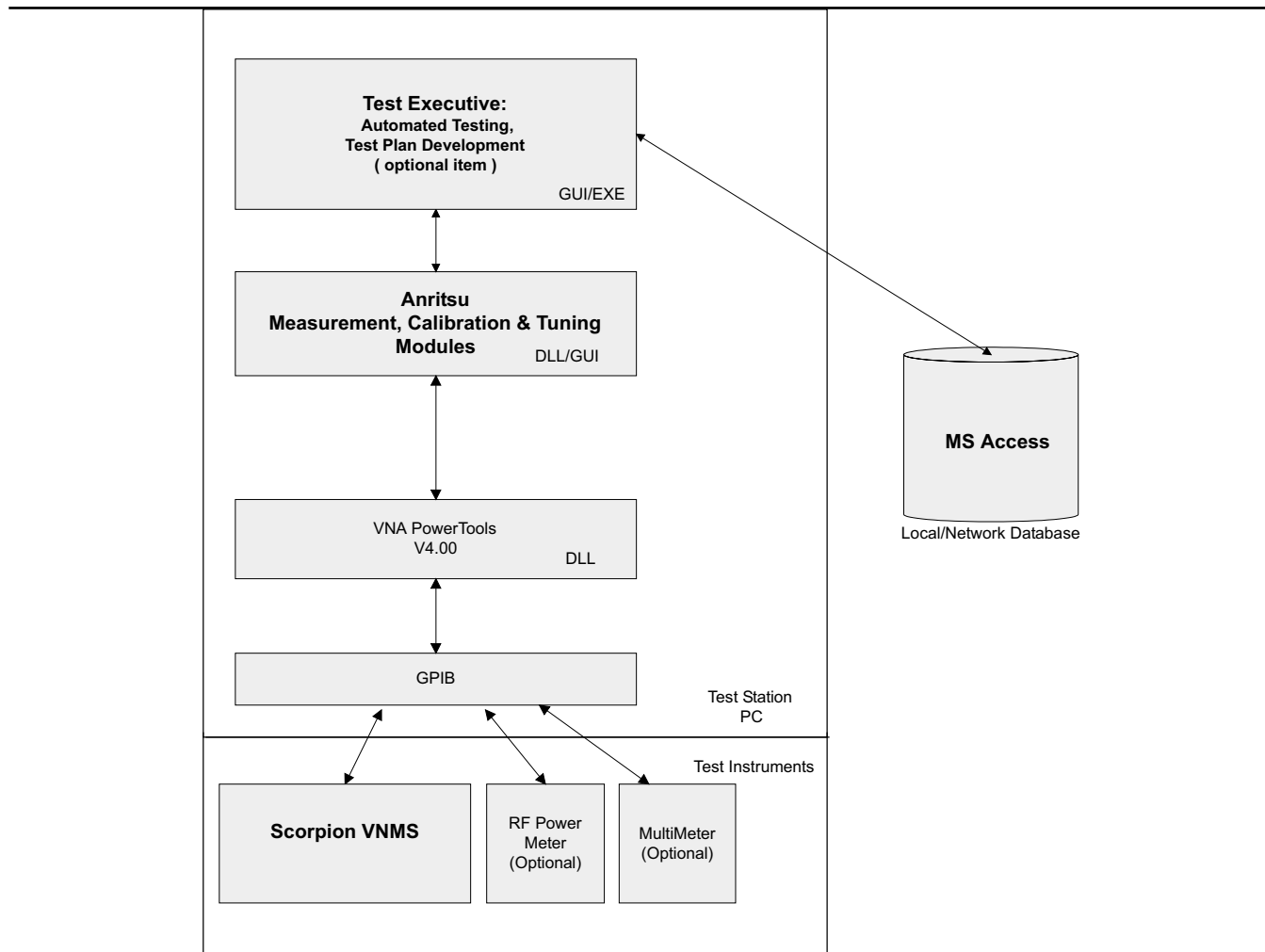
The Test Executive is an optional layer of test management software. The ANRITSU measurement and display software does not require a separate Test Executive, even though it can operate in conjunction with one such as the National Instruments TestStand or customer's proprietary Test Executive. In the absence of a separate test executive, the ANRITSU software can be operated on a stand-alone basis or can be called directly by a Microsoft Windows 95/98/2000 or NT program such as Word, Excel or Access that supports Visual Basic function calls.

The functions of the Test Executive, if supplied by ANRITSU or by the customer, would include:

- Test Sequence development and management
- Part number and serial number management
- Interface with the Database

**1-14 SOFTWARE STRUCTURE**

The software structure is illustrated in Figure 1-6 (below).



**Figure 1-6. PATS Software Structure**

**1-15 MS7840A OPTIONS**

The following options are available:

**Table 1-2.** MS7840A Options

Model	Option Number	Description
ME7840/1	1	Replaces MS4623C with MS4622C (3 Ghz option)
ME7840/2	2	Replaces MS4782D Test Set with MS4782A Test Set
ME7840/3	3	Delete Test Set (Note: The ND43425 Accessory and Inter-connect Kit will also be deleted with this option.)

**1-16 OPTIONAL ACCESSORIES**

The accessories described below are available from ANRITSU.

- Model ML2430A Power Meter
- Model MG3672A Digital Modulation Signal Generator/with MG0314A W-CDMA Modulation Unit
- Model MS2602A Spectrum Analyzer
- Model MS8607A Digital Mobile Radio Transmitter Tester
- AC/DC Current Probe (for AUT drain current and power-added-efficiency (PAE) measurements) (See below).

Max Current	Accuracy (at lesser current range setting)	ANRITSU Part Number
100 mV/A: 10A 10 mV/A: 100A	3% of reading $\pm$ 50 mA	2000-1067
1 mV/mA: 1A 10 mV/A: 80A	2% of reading $\pm$ 5 mA	2000-1085

- Circulators to be used externally with the MS4782D Test Set (see below).

Frequency Band	Isolation	Max AUT Power	ANRITSU Part Number
800 to 1000 MHz	20 dB min	50 watts	1000-50
1.8 to 2.5 GHz	20 dB min	50 watts	1000-52
1.8 to 2.5 GHz	22 dB min	79 watts	1000-53

Note: All circulators have 3 SMA female connectors.

- 15SS50-0.35B Cable Assembly. Three of these cables can be used to connect any one of the external circulators offered above to the

MS4782D Test Set. The same cable is also used to connect the Test Set to the MS462XC receivers on the rear panel.

**1-17 PREVENTIVE  
MAINTENANCE**

The ME7840A Power Amplifier Test System does not require any preventive maintenance.

**1-18 USER SUPPLIED  
TEST SET**

The ANRITSU MS4782X is the recommended test set for PATS; however, users supply their own test set. To ensure that such a test set will function properly with the PATS, a set of specifications and caveats is provided in Appendix B.

**1-19 PERFORMANCE  
SPECIFICATIONS**

Specifications for the M7840A Power Amplifier Test System are provided in Table 1-3.



**Table 1-3.** Performance Specifications for ME7840A Power Amplifier Test System

Characteristic	Value	Notes
Amplifier Under Test Power Output	100 W maximum	With MS4782D Test Set and with 23 dB isolation between AUT power output and MS4623C, Port 2
	50 W maximum	With MS4782A Test Set
Bandwidth through Test Set	800 MHz to 2.4 GHz	With MS4782D Test Set (Note 1)
	800 MHz to 1.0 GHz	With MS4782A Test Set
Amplifier Under Test Input Power range available from PATS	-85 to +5 dBm	At AUT input
IMD 3rd Order Dynamic Range	70 dB min	With 10 Hz IF Bandwidth @ 300 kHz tone separation and -20 dBm tone levels
Port Power Accuracy	±0.1 dB maximum	With flat power calibration
	±1 dB maximum	Without flat power calibration
Drift over 60 hours	0.15 dB maximum, peak to peak	
Dynamic Range	80 dB minimum	Overall system, including test set
Port Match (test ports 1 and 2)	40 dB minimum	Corrected value
	13 dB minimum	Uncorrected value
Directivity	40 dB minimum	Corrected value
Environmental	Storage Temperature Range	40° C to +75° C
	Operating Temperature Range	0° C to +50° C
	Range Over Which Specifications Apply	23 ±3° C
	Relative Humidity	5% to 95% at +40° C
Physical, MS4782X Test Set	Height	152.5 mm (6 in.)
	Width	444 mm (17.4 in.)
	Depth	500 mm (19.7)
	Weight	10 kg (22 pounds) or less

Note 1: This frequency range does not take into account any restricting effects of the external circulator (if one is used for reverse measurements)

**1-20 RECOMMENDED ITEMS**

Table 1-2 provides a list of test equipment and other items needed for calibration and performance verification.

**Table 1-4. Recommended Test Equipment**

Item	Critical Specification/Notes	Manufacturer/Model
Power Meter	GPIB capable	ANRITSU Model ML243XA
Power Sensor	10 MHz to 6 GHz	ANRITSU Model MA247XA
N connector Calibration Kit	Type N Open, Short, Broadband Load	ANRITSU Model 3653 or 3753LF
Offset Termination	6 dB	ANRITSU Model SC5237
Offset Termination	20 dB	ANRITSU Model SC5270
Power Divider		ANRITSU Model 11N50B
Cable	50 Ohm, N-male to N-male	ANRITSU Model 3670NN50-2
Adapter	50 Ohm, N-male to N-male	ANRITSU Model 34NN50A r
GPIB Cable	None	ANRITSU 2100-2
SMA/3.5 mm Connector Calibration Kit	Required if amplifier-under-test (AUT) has SMA/3.5 mm connectors	ANRITSU 3750LF

**1-21 USER SUPPLIED ITEMS**

The following items required for the operation of the ME7840A Power Amplifier Test System must be supplied by the user.

Item	Critical Specification
Personal Computer (PC)	Pentium II or better, 200 MHz or faster, with Windows® 95/98/2000 or NT operating system and National Instruments GPIB card installed.
GPIB Cable	None

# Chapter 2

## Installation

### 2-1 INTRODUCTION

This chapter describes the installation, connection and set-up of the equipment that comprises the ME7840A Power Amplifier Test Station.

### 2-2 EQUIPMENT COMPLEMENT

The ME7840A is made up of the following pieces of equipment:

- Scorpion® Vector Network Measurement System (VNMS), Direct Receiver Access (DRA) version:  
Model MS4622C (10 MHz to 3 GHz) or  
Model MS4623C (10 MHz to 6 GHz)
- Model MS4782X Power Amplifier Test Set
- System measurement software
- Current probe(s) (optional item)
- One or more external circulators (optional item, for use with MS4782D Test Set)
- Accessory Kit: Includes interconnect cables and 50Ω terminations for Aux ports

### 2-3 UNPACKING and INSPECTION

The ME7840A equipment has been securely packaged. The packaging material and container should be retained in case the equipment must be re-shipped or placed into storage.

The MS4622C or MS4623C DRA Scorpion® VNMS and the MS4782X Test Set are each packed within heavy cardboard boxes.



- Step 1.** Carefully cut the sealing tape on the top box surface with a packing knife.
- Step 2.** Open the box lids, and remove the upper layer of foam material.
- Step 3.** Lift the equipment from the boxes. Two persons should do this, as the equipment is heavy and bulky.

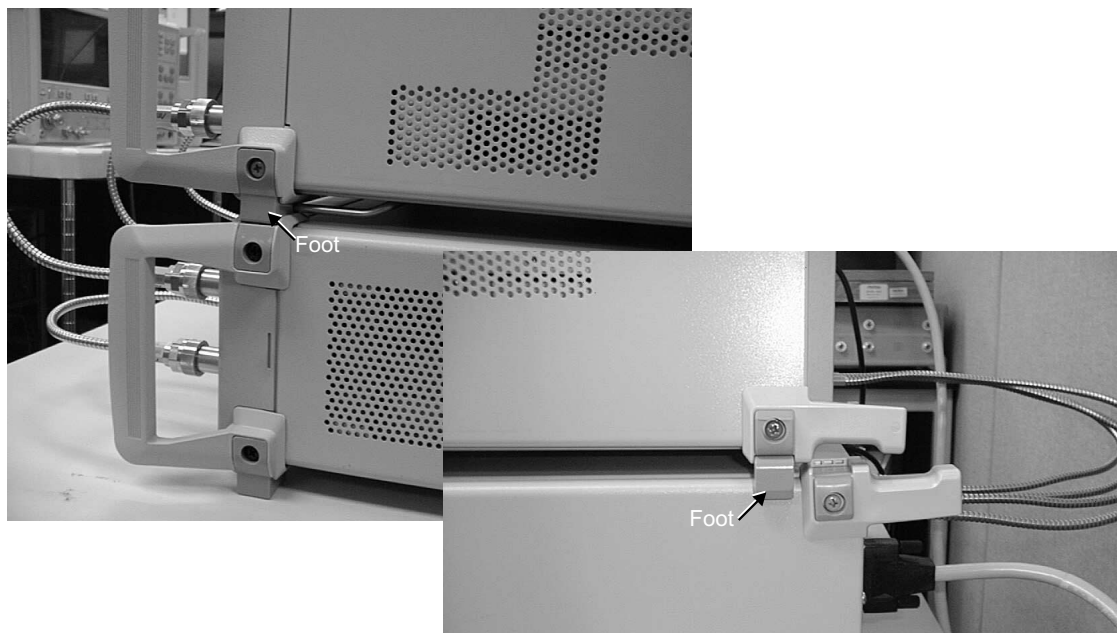
A listing of the non-optional-accessories always supplied with PATS is listed below. The cables and terminators are shown in Figures 2-3 and 2-2, on page 2-3.

Item	Part No.	Quantity
Broadband Termination	28N50LF	2
Control Cable	803-49	1
RF Cables, Type N connectors (front)	15NN50-0.25B	3
RF Cables, SMA connectors (rear)	15NN50-0.35B	4

**2-4** **INSTALLATION -  
HARDWARE**

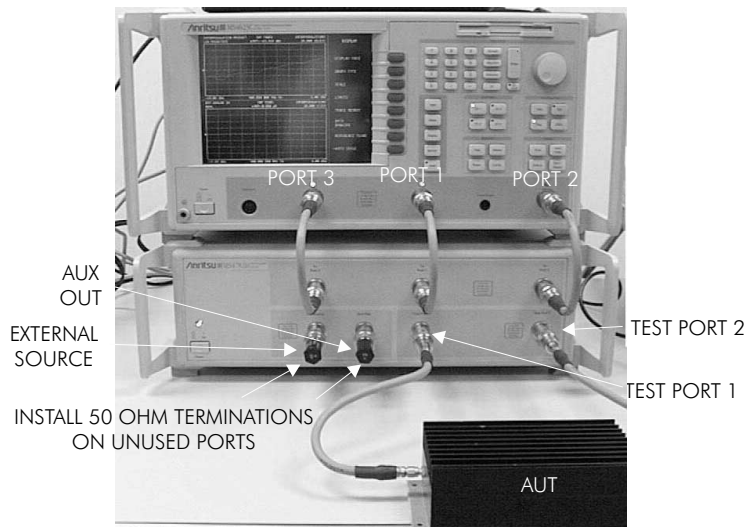
System hardware is set-up is a straight-forward process. Follow the steps below in sequence to ensure a trouble free installation.

**Step 1.** Place the MS462XC on top of the MS4782X Test Set. Figure 2-1 shows how the green colored feet on the case of each unit stack on each other.

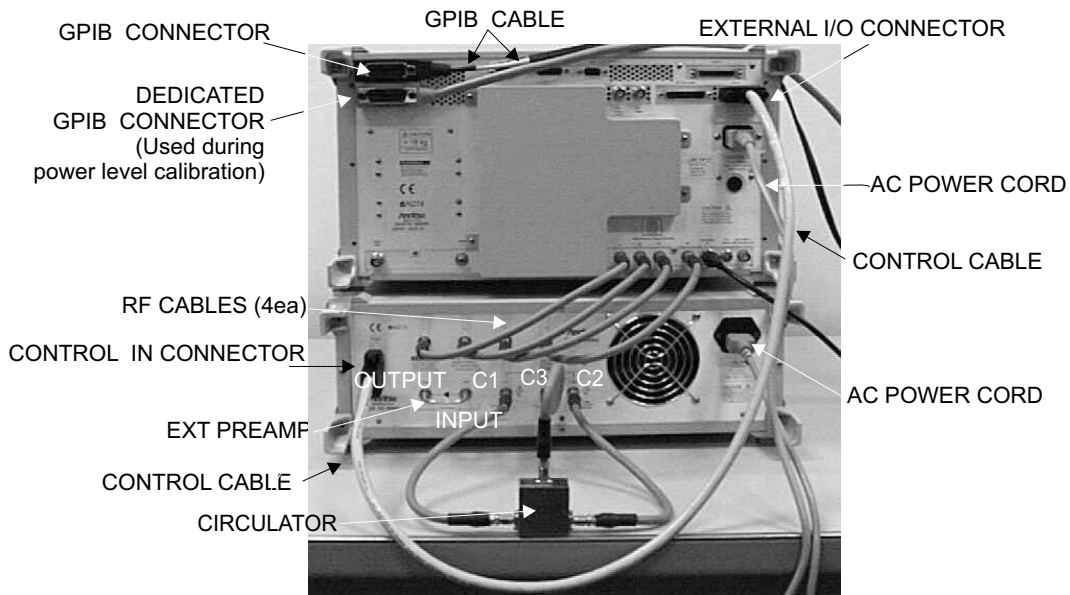


**Figure 2-1.** ME7840A Component Assembly

**Step 2.** Install the three front RF interconnect cables. Figure 2-3 (following page) shows the installation of the RF interconnect cables between the front panel of the MS462XC and the front panel of the Test Set. Table 2-1 lists the applicable connectors by designation or function.



**Figure 2-3.** ME7840A Front RF Cable Connections (through-line shown between test port 1 and test port 2)



**Figure 2-2.** ME7840A Rear Cable Connections

**Step 3.** Install the four RF cables between the rear of the MS462XC and the Test Set. Torque the cables to 8 inch-pounds (SMA Connectors) or 12 inch-pounds (Type N connectors). Table 2-1 lists the applicable connectors by designation or function.

**Table 2-1.** RF Cable Connection

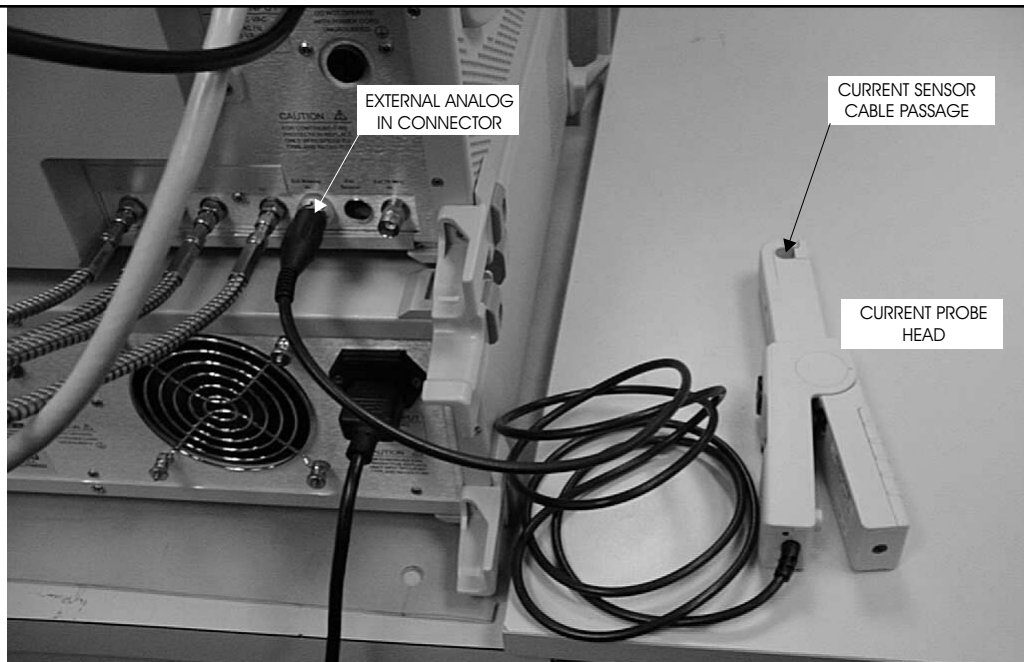
<b>VNMS - FRONT</b>	Connects To:	<b>TEST SET - FRONT</b>
PORT 1		"TO PORT 1"
PORT 2		"TO PORT 2"
PORT 3		"TO PORT 3"
<b>TEST SET - FRONT</b>	Connects To:	<b>DEVICE UNDER TEST</b>
TEST PORT 1		DUT INPUT
TEST PORT 2		DUT OUTPUT
<b>VNMS - REAR</b>	Connects To:	<b>MS4782X -REAR</b>
PORT a1		PORT a1
PORT a2		PORT a2
PORT b1		PORT b1
PORT b2		PORT b2
<b>MS4782D TEST SET - REAR</b>	Connects To (See Figure 1-2 for a block diagram)	<b>CIRCULATOR</b>
C1		Circulator 1 or C2
C2		Circulator 2 or C1
C3		Circulator 3 or Open

**Step 4.** Install the control cable between the External I/O connector on the rear panel of the MS462XC and the Control In connector on the rear panel of the Test Set.

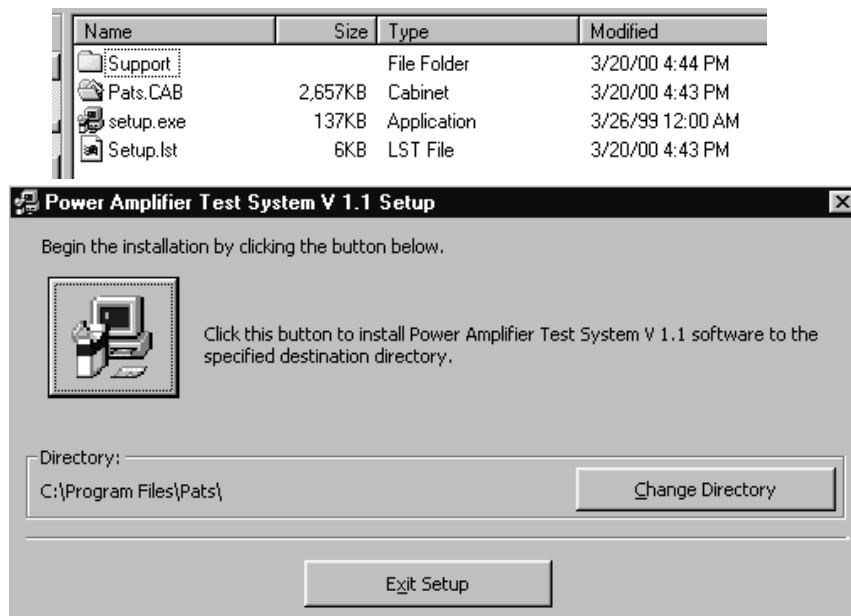
**Step 5.** Connect the GPIB cable from IEEE-488.2 connector on the rear panel of the MS462XC to the PC/System Controller. (Note: This cable is not supplied with the ME7840A PATS.)

**Step 6.** Connect an AC power cord to each of the three-prong connectors on the rear panel of the Test Set and the MS462XC.

**Step 7.** (Optional, for drain current PAE measurements) Connect the current probe cable BNC connector to the Ext. Analog In connector on the rear of the MS462XC as shown in Figure 2-4 (page 2-5).



**Figure 2-4.** *Current Probe Connection*



**Figure 2-5.** Software Installation Window



**2-5** **INSTALLATION - SOFTWARE**

**Installation**

ME7840A software is delivered on a CD. The ANRITSU Power Tools library Version 4.0 or higher, which is required to be installed on the target system (the PC which is receiving the installation of ME7840A software). Power Tools Version 4.0 is also included in the ME7840A Software CD.

Run the appropriate *Setup.exe* files to install Power Tools then the ME7840A software (Figure 2-5). During installation, the system may indicate that some files being installed already exist. In general it is best to accept copying newer versions of files and reject copying older versions. If in doubt, cancel the installation, backup the files in question, and try again. The Readme.txt file lists the files and versions copied to the target system during installation of ME7840A Software.

The system may also copy some files during ME7840A installation and then ask you to reboot. If this happens, reboot your Windows PC and run the ME7840A Setup.exe program again after rebooting.

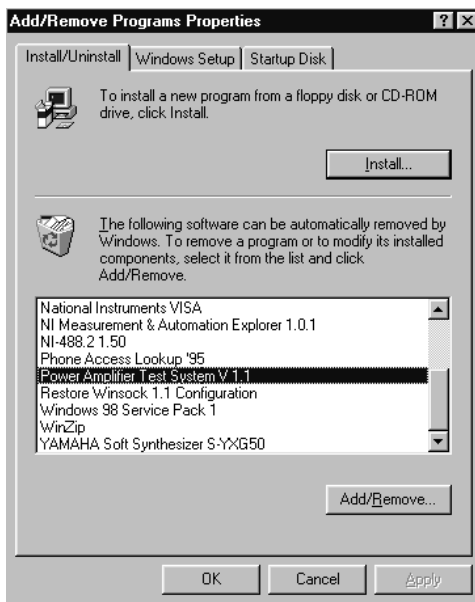
**What else is on the CD?**

The CD includes a Readme.txt file in the root directory and two folders. The readme file contains specific instructions for installing the software and a listing of the features in the version being installed. The folders are as follows:

- Power Tools Version 4.0 Installation files
- PATS Installation Files

**Uninstalling the software**

To uninstall ME7840A software or Power Tools go to the Windows Control Panel and click on "Add/Remove Programs." Select the programs you would like to remove and follow instructions.



**2-6 SERVICE CENTERS** ANRITSU Service Centers are listed in Table 2-2.

**Table 2-2. ANRITSU Service Centers**

**UNITED STATES**

ANRITSU COMPANY  
685 Jarvis Drive  
Morgan Hill, CA 95037-2809  
Telephone: (408) 776-8300  
1-800-ANRITSU  
FAX: 408-776-1744

ANRITSU COMPANY  
10 New Maple Ave., Unit 305  
Pine Brook, NJ 07058  
Telephone: (201) 227-8999, 1-800-ANRITSU  
FAX: 201-575-0092

ANRITSU COMPANY  
1155 E. Collins Blvd  
Richardson, TX 75081  
Telephone: 1-800-ANRITSU  
FAX: 972-671-1877

**AUSTRALIA**

ANRITSU PTY. LTD.  
Unit 3, 170 Foster Road  
Mt Waverley, VIC 3149  
Australia  
Telephone: 03-9558-8177  
FAX: 03-9558-8255

**BRAZIL**

ANRITSU ELECTRONICA LTDA.  
Praia de Botafogo, 440, Sala 2401  
CEP22250-040, Rio de Janeiro, RJ, Brasil  
Telephone: 021-527-6922  
FAX: 021-53-71-456

**CANADA**

ANRITSU INSTRUMENTS LTD.  
215 Stafford Road, Unit 102  
Nepean, Ontario K2H 9C1  
Telephone: (613) 828-4090  
FAX: (613) 828-5400

**CHINA**

ANRITSU BEIJING SERVICE CENTER  
Beijing Fortune Building  
1515, 5 Dong San Huan Bei Lu  
Chaoyang qu, Beijing 100004, China  
Telephone: 011861065909231  
FAX: 011861065909235

**FRANCE**

ANRITSU S.A  
9 Avenue du Quebec  
Zone de Courtaboeuf  
91951 Les Ulis Cedex  
Telephone: 016-09-21-550  
FAX: 016-44-61-065

**GERMANY**

ANRITSU GmbH  
Grafenberger Allee 54-56  
D-40237 Dusseldorf, Germany  
Telephone: 0211-968550  
FAX: 0211-968555

**INDIA**

MEERA AGENCIES (P) LTD.  
A-23 Hauz Khas  
New Delhi 110 016  
Telephone: 011-685-3959  
FAX: 011-685-2275

**ISRAEL**

TECH-CENT, LTD.  
4 Raul Valenberg St  
Tel-Aviv 69719  
Telephone: (03) 64-78-563  
FAX: (03) 64-78-334

**ITALY**

ANRITSU Sp.A  
Roma Office  
Via E. Vittorini, 129  
00144 Roma EUR  
Telephone: (06) 50-99-711  
FAX: (06) 50-22-4252

**KOREA**

ANRITSU CORPORATION LTD.  
14F, Hyunjuk Bldg  
832-41 Yeoksam-Dong  
Kangnam-Ku  
Seoul South Korea 150 010  
Telephone: 02-553-6603  
FAX: 02-553-6604, 02-553-6605

**JAPAN**

ANRITSU CUSTOMER SERVICE LTD.  
1800 Onna Atsugi-shi  
Kanagawa-Prf. 243 Japan  
Telephone: 0462-96-6688  
FAX: 0462-25-8379

**SINGAPORE**

ANRITSU (SINGAPORE) PTE LTD.  
6 New Industrial Road #06-01/02  
Hoe Huat Industrial Bldg  
Singapore 536199  
Telephone: 282-2400  
FAX: 282-2533

**SOUTH AFRICA**

ETECSA  
12 Surrey Square Office Park  
330 Surrey Avenue  
Ferndale, Randburt, 2194  
South Africa  
Telephone: 011-27-11-787-7200  
FAX: 011-27-11-787-0446

**SWEDEN**

ANRITSU AB  
Botivid Center  
Fittja Backe 1-3  
S145 84 Stockholm  
Telephone: (08) 534-707-00  
FAX: (08) 534-707-30

**TAIWAN**

ANRITSU CO., LTD.  
6F, No. 96, Section 3  
Chien Kuo N. Road  
Taipei, Taiwan, R.O.C.  
Telephone: (02) 515-6050  
FAX: (02) 509-5519

**UNITED KINGDOM**

ANRITSU LTD.  
200 Capability Green  
Luton, Bedfordshire  
LU1 3LU, England  
Telephone: 015-82-4332003  
FAX: 015-82-731303

# Chapter 3

## Operations, General

### 3-1 INTRODUCTION

The basic operation of the Model ME7840A Power Amplifier Test Station (without external preamplifiers) is described in this and the following two chapters: Calibration Operations and Measurement Operations. “Calibration Operations” describes the software measurement calibration function and “Measurement Operations” describes the software measurement function. This chapter describes the setup and general operation of the software. (See Chapter 7 for operation with external preamplifiers.)

### 3-2 PREPARING THE SYSTEM

Refer to Figure 3-1 to identify the equipment named in the recommended power-up sequence for the ME7840A.

- Step 1.** Connect the output of the AUT to Test Port 2 of the MS4782X.
- Step 2.** Connect the input of the AUT to Test Port 1 of the MS4782X.
- Step 3.** Ensure that the power rating of the cables is suitable for the test, and that the connections are tightened.
- Step 4.** Turn on the MS462XC then the MS4782X Test Set.
- Step 5.** Set the output of the MS462XC so that the AUT output power does not exceed the maximum Test Port 2 input level. See below.

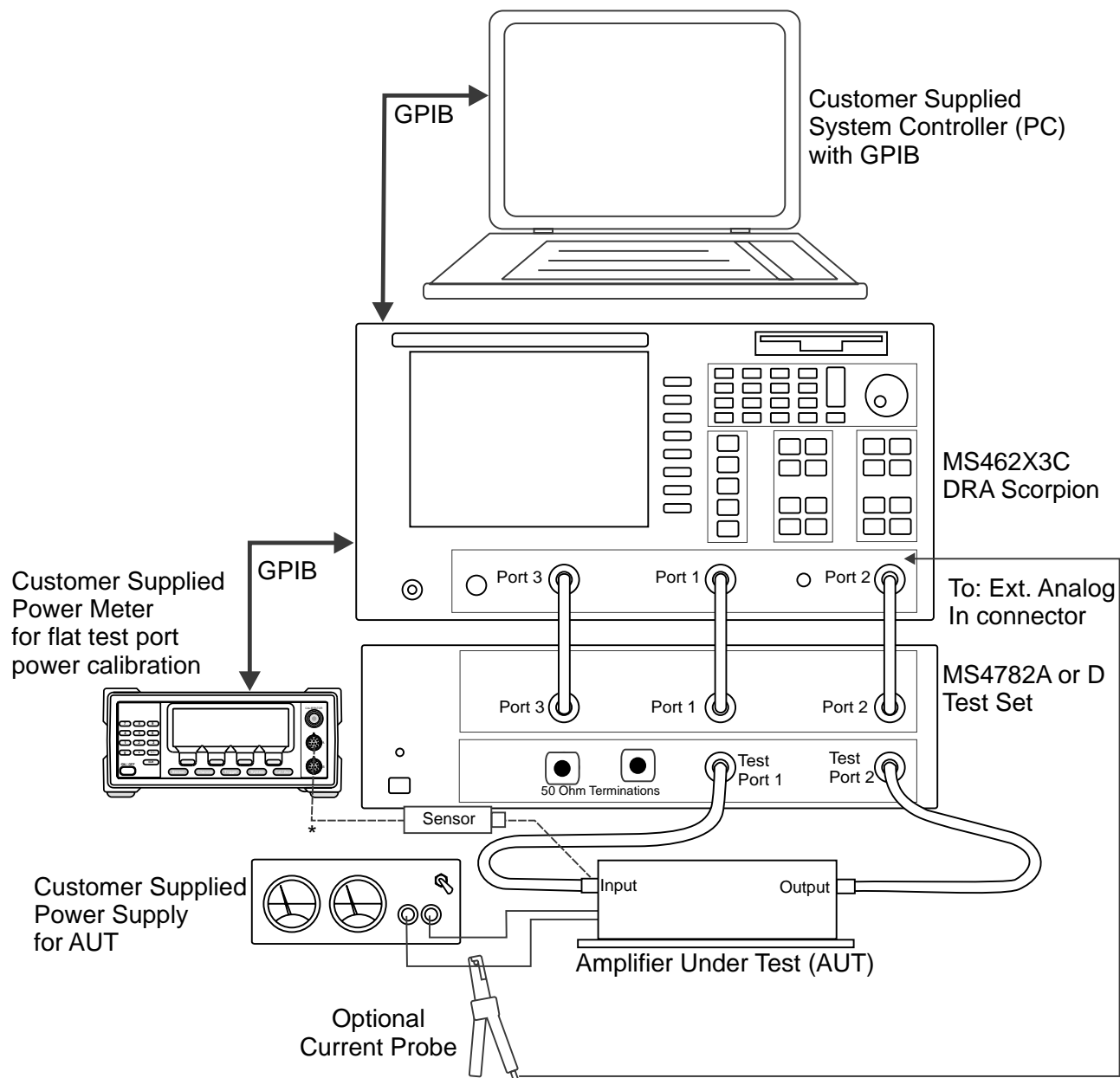
#### **CAUTION**

The AUT RF power output maximum level should be no more than the level shown in the tabulation at right. Otherwise, damage to equipment will occur.

Test Set Model	External Circulator Used	Test Port 2 Max Power
MS4782A	Not Applicable	50 watts
MS4782D	None (port C1 directly connected to port C2)	100 watts
MS4782D	1000-50 or 1000-52 (20 dB isolation)	50 watts
MS4782D	1000-53 (22 dB isolation)	79 watts
MS4782D	Two circulators providing greater than 23 dB isolation	100 watts

- Step 6.** When ready for measurements, cautiously apply DC power to the AUT.
- Step 7.** Check that the normally factory-installed RF coaxial “jumper” cable is installed on the rear panel of the Test Set:
- MS4782X: Between Ext Preamp Input and Output connectors.
  - MS4782D: Between connectors C1 and C2, unless a circulator is installed.
- Step 8.** If drain current and/or PAE measurements are desired, the optional current probe (ANRITSU part number 2000-1067 or -1085) can be used. Ensure the probe (Figure 3-1) has a fresh battery, and set the zero offset using the MS4623C as follows:
- a. Using Domain softkey, set to **Transmission & Reflection**; using the Display soft key, set for **Single Channel**; using the Graph Type softkey, set for **Real**; using the Scale softkey and Data Entry keys, set for 1 mU/Division. Use the Avg key and associated softkeys to set **Averaging** for 10 and **IF Bandwidth** for 300 Hz. Use the Config key, **DATA POINTS** and associated softkeys to set for 101 **Max Data Points**.
  - b. Use the Measure softkey and select **Ext. Analog In**.
  - c. Turn on the current probe and set it for the desired range.
  - d. Adjust the “Zero Adjustment” thumbwheel until the reading is minimum (typically  $0 \pm 100\mu\text{U}$ ).
  - e. On the current probe:  
Orient the probe such that the “Current Direction” arrow points away from the power supply.  
  
Place the jaws only over the DC wire (not both wires)..

**Unused Connections** The EXT. SOURCE and AUX. OUT connectors must be terminated with  $50\Omega$  terminations when not in use.

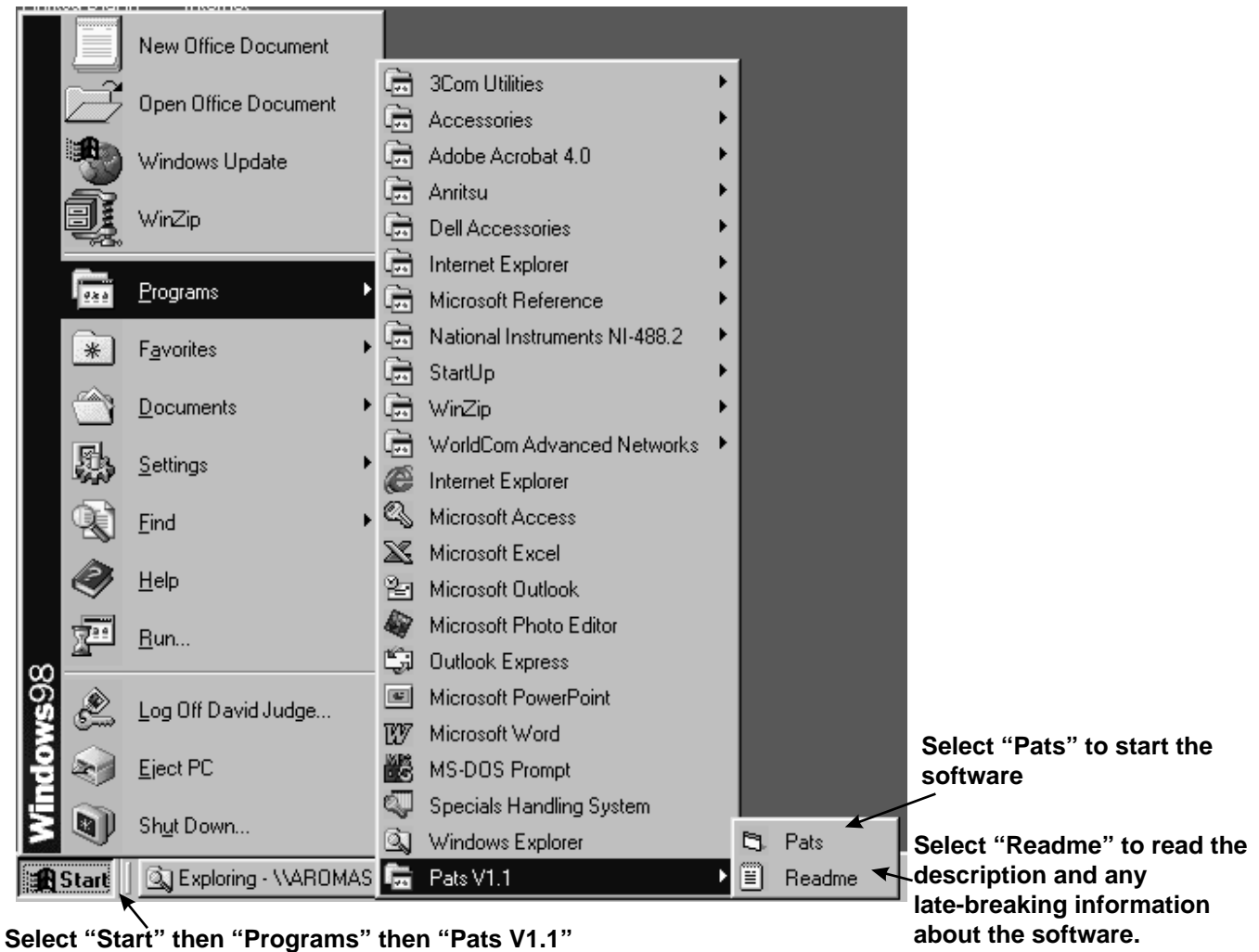


\* Connect when directed by procedure for power calibrations

**Figure 3-1.** PATS Power On Sequence

**3-3 USING PATS SOFTWARE**

PATS software requires a computer with GPIB capability running Windows 95 or better (98/NT/2000). The software is started by selecting the "Start" button, then "Programs," "Pats V1.1," then "Pats" (Figure 3-2).



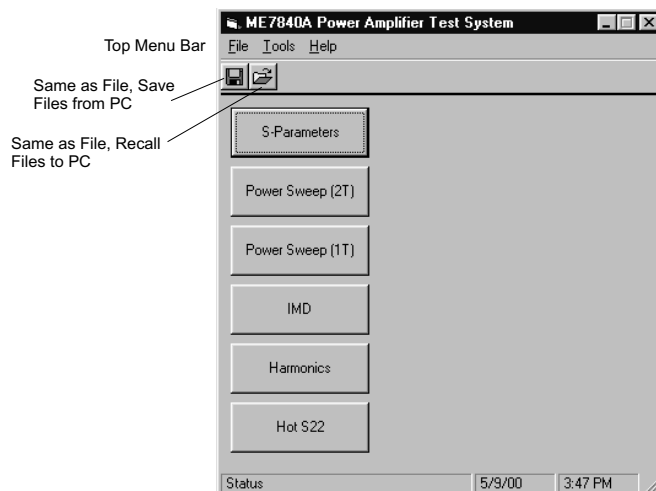
**Figure 3-2.** Starting the PATS Software

**Software Organization**

The PATS software has two main and three collateral functions. The two main functions, calibration and measurement, are described in Chapters 3 and 4, respectively. The collateral functions, accessed from the PATS program's top menu, are described in paragraph 3-6.

**3-4 COLLATERAL FUNCTIONS**

The PATS software collateral functions are found on the top menu bar under “Files,” “Tools,” and “Help.” (below)



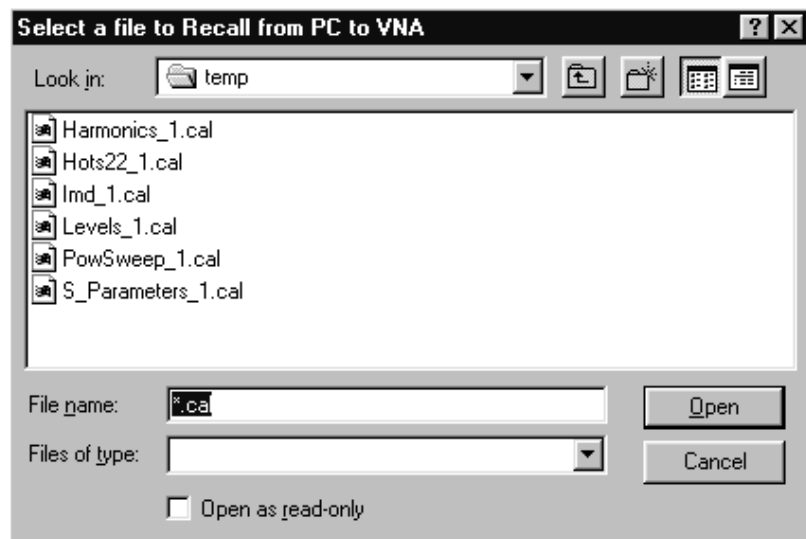
**File**

The file menu (below) provides for saving files from the PC to the MS462XC, recalling files from the MS462XC to the PC, and for exiting the system.



Click on File to display a drop-down list (above) that provides the three options described below. PATS Save and Recall functions have the exact same behaviors as the Save/Recall button on the Scorpion. However, instead of saving to the Scorpion hard disk or recalling from the hard disk, the PATS software allows users to Save to the PC’s hard disk and Recall from the PC’s hard disk.

- ❑ *Save Cal Files to PC*. Displays a dialog box (similar to that shown for *Recall Cal Files from PC*, below) showing the cal files stored in the default folder (Temp). This function is useful for saving the front panel setup and calibration data to a file on the PC. The user has the option of overwriting an existing file by selecting an existing file from the file listing or creating a new file by typing in a file name. The user must type in a “.cal” extension or the program will report an error. The calibration procedure automatically saves cal files to the PC. The file names of these files is specified in the calibration specification file (\*.txt file).
- ❑ *Recall Cal Files from PC*: Displays a dialog box similar to that shown below with the listing of file name. This function transfers a .cal file from the PC to the Scorpion over the GPIB bus (and names the file a.cal on the Scorpion's hard disk) and then recalls the front panel setup and cal data from a.cal.



- ❑ *Exit*: Exits the PATS software.

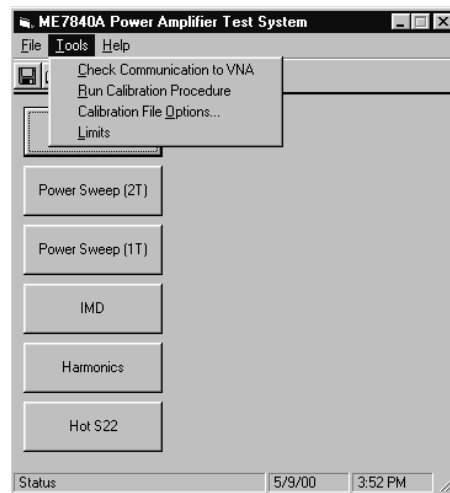
### **Help**

The “Help” function is not available in the current software. It will be available in future software versions.

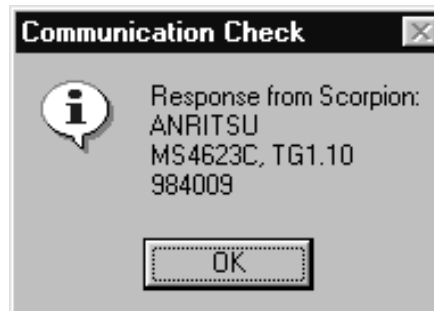


**Tools**

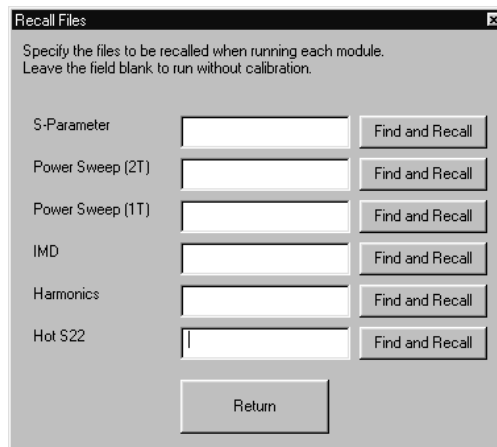
The “Tools” menu (below) displays a drop-down list that provides three collateral options described below. The “Run Calibration Files” option is described in Chapter 4.



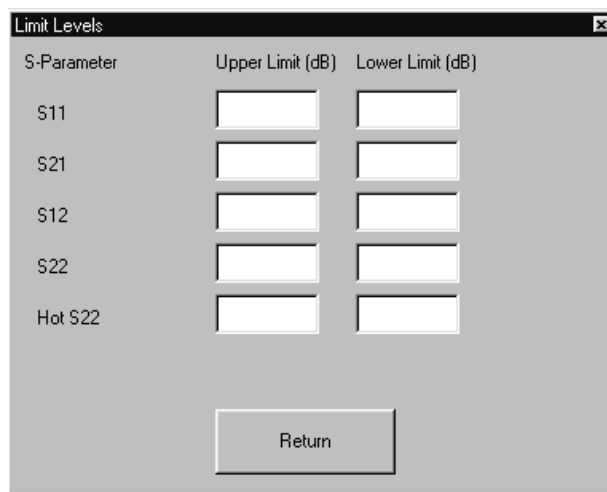
- a. *Check Communications to VNA:* Runs a test to check that the VNA communicates with the PC. Run this option first to ensure that the PATS setup is correct and functioning properly. If so, a dialog box appears like that shown below.



- b. *Calibration File Options:* Provides options for finding and recalling calibration files (below). These files are used to establish test setup for the measurements described in Chapter 5. If no file is selected in an area (S Parameter, Power Sweep, IMD, etc., the associated measurement will assume the PATS default setting. Clicking on “Find and Recall” button will display the list of files as was shown for “File”, Step 1a, above. Clicking on a filename will cause it to display in the associated window in this screen.



- c. *Limits:* Provides for setting limits for S-Parameter measurements.



# Chapter 4

## Operations, Calibration

### **4-1** INTRODUCTION

Measurements always include a degree of uncertainty due to imperfections in the measurement system. The measured value is always a combination of the actual value plus the systematic measurement errors. Calibration, as it applies to network analysis, characterizes the systematic measurement errors and subtracts them from the measured value to obtain the actual value. Each of the ME7840A measurements requires a calibration to account for measurement uncertainties. This chapter describes the measurement calibration operations of the Model ME7840A Power Amplifier Test System software.

### **4-2** OPERATION, GENERAL

Refer to Chapter 3 for general operation and setup of the ME7840A.

### **4-3** PROGRAM FILES

The PATS software sets up the MS462XC DRA Scorpion according to instructions in the "Calibration Specification" files, which are accessed from the "Tools," "Run Calibration Procedure" function that is described later in this chapter. These are user-editable text files that establish the conditions during calibration and measurement. How to edit these files is described in Appendix A.

The calibration data and Scorpion switch settings that result from following a "Run Calibration Procedure" specification file are saved as a \*.cal file. These \*.cal files are accessed using the "Tools," "Calibration File Option" function that was described in paragraph 3-6, page 3-8. When one of these files is recalled using the "Calibration File Option," the Scorpion is ready to acquire correct (calibrated) measurements.

Examples of instrument settings / conditions that reside in the Calibration Specification files include:

- Sweep start and stop frequencies
- Number of data points
- Source 1 and 2 power levels
- Scorpion IF bandwidth
- Averaging
- Scorpion display settings

Some of these parameters can also be specified / modified by the User Input window before each actual measurement so long as such modification is consistent with the calibration to be applied.

Alternatively, Scorpion front panel settings may be set manually and applied during the automated measurements under PATS software as follows:

- ❑ On the Measurement Window click the Pause button
- ❑ On the Scorpion front panel press the “Clr / Local” button to take manual control of the Scorpion.
- ❑ Use Scorpion front panel controls to set the desired settings and/or to perform a new calibration. (Note: Unless a new calibration is performed, the manual settings must be consistent with the calibration to be applied).
- ❑ Use the “Save Cal File to PC.” (Refer to Appendix A for detailed information on how to use the “Calibration Specification Files.”)

#### **4-4 TEST EQUIPMENT**

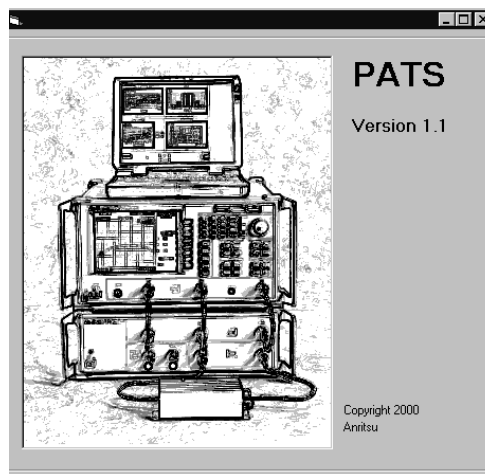
A power meter, power sensor, and Type N calibration component kit is required for power level and S-parameters calibrations. See Table 1-2, page 1-12.

**4-5 GENERAL**

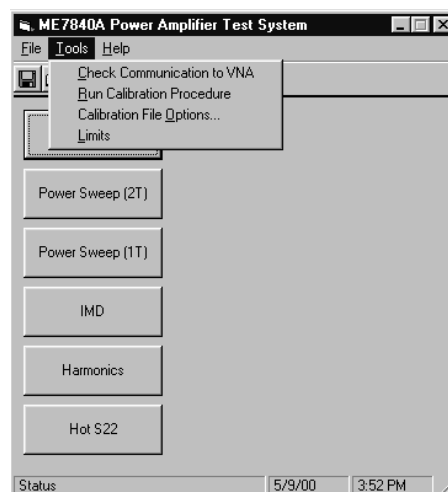
Calibration operations are described in this and the following paragraphs

**Step 1.** Click on “Start,” “Programs,” “Pats V1.1,” then “Pats” (Figure 3-2, page 3-4) to start the software.

*The PATS flash screen (below) briefly appears, then the main screen.*



*The main screen (below) provides access to all software options.*

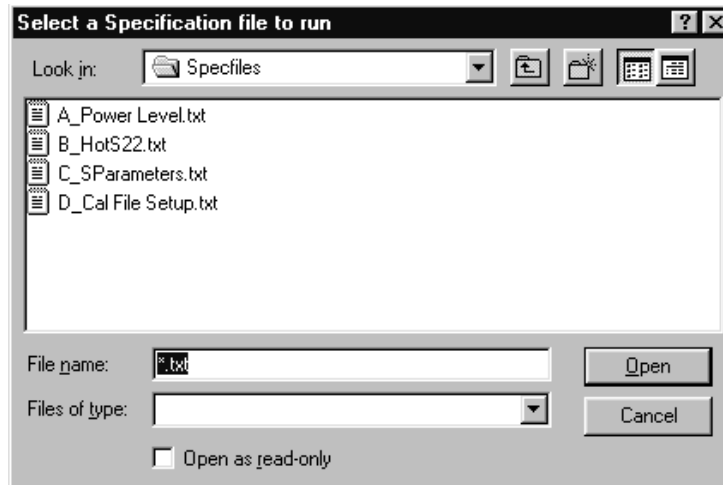


**Step 2.** Click on “Tools” then “Check Communications to VNA” to en-

sure that the equipment is properly connected to the bus. If so, the following screen will be displayed:



**Step 3.** Click on "Run Calibration Procedure" to display a list of calibration specification files (below). (Refer to paragraph 4-3 for a description of these files.) Running the files is described in succeeding numbered paragraphs.

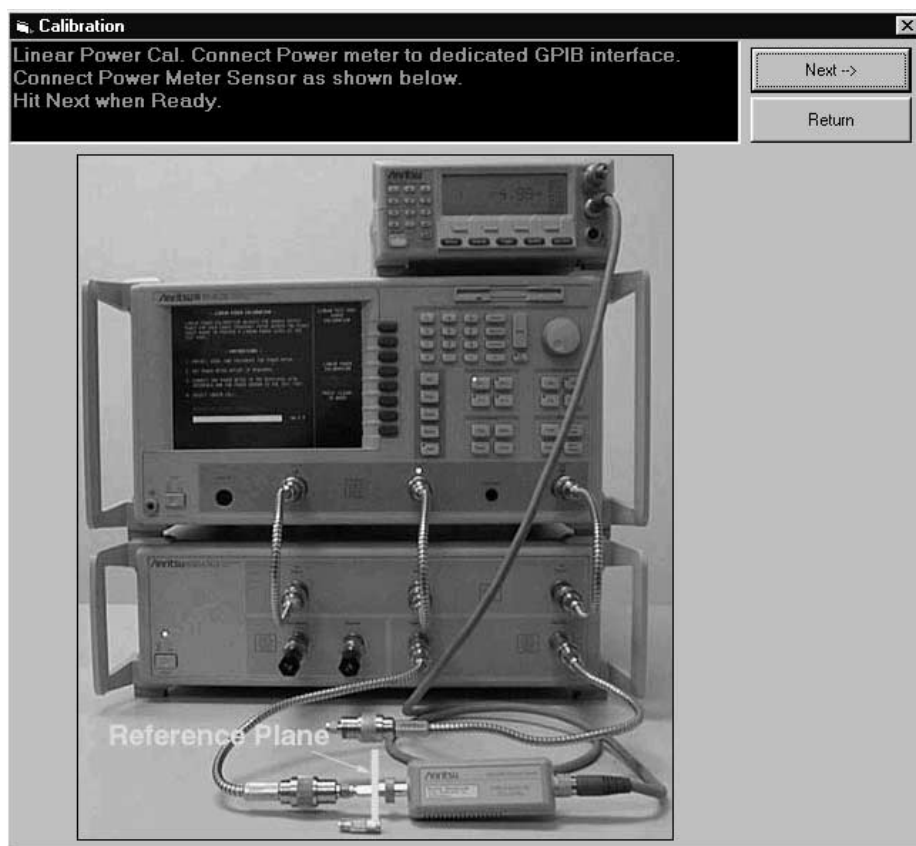


## 4-6 POWER LEVEL

The A\_Power Level.txt specification file provides prompts for a power level calibration. Proceed as follows:

- Step 1.** Zero-set the power sensor for accurate measurement in following steps.
- Step 2.** Select "Tools" then "Run Calibration Procedure."

- Step 3.** Double-click on “A\_Power Level.txt.” . The program starts with a linear power calibration (below).



- Step 4.** Before hitting the “Next” button, connect the power meter to at the point where power enters the device-under-test (AUT), which becomes the power reference plane as shown in the prompt.

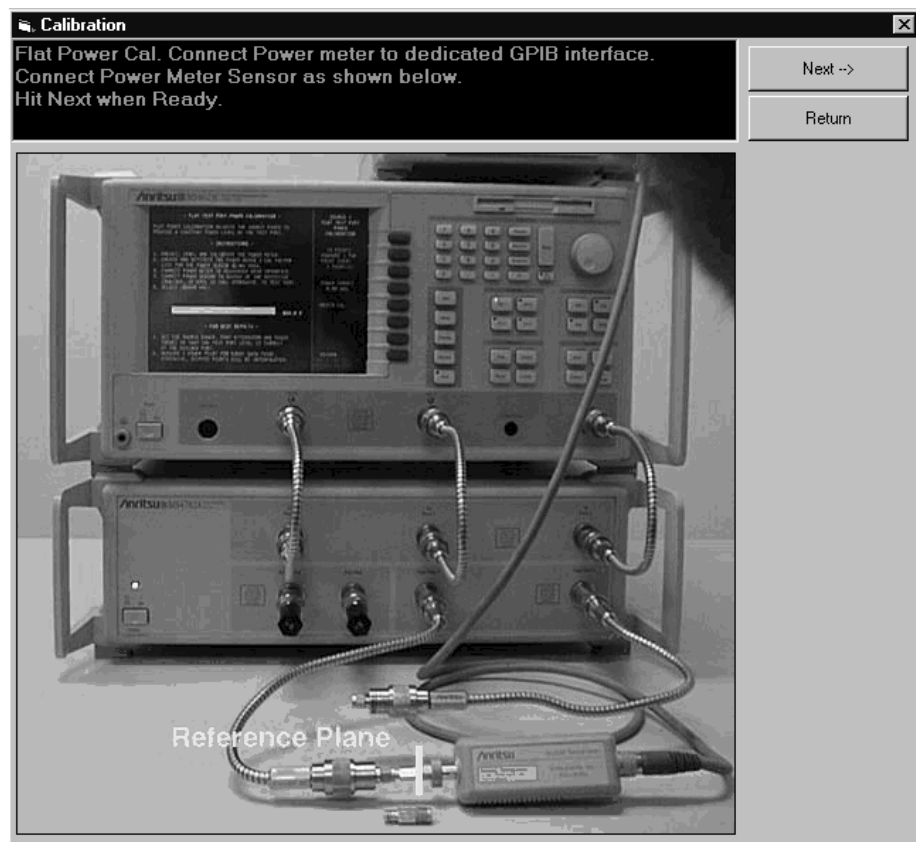
*The use of cables and/or adapters does not effect the final measurement result, if they are in place for the calibration process. The vector error corrections established during the calibration process eliminates cable and/or adapter effects as long as the ports used are stable and exhibit good repeatability, which is the case if good quality components are used.*

*Many calibration kits include adapters that are designed to have equal phase length. These parts are called phase equal adapters (PEA). ANRITSU designs in-series adapters (e.g., SMA Connector M-M, M-F, F-F) to be phase insertable when technically possible.*

**NOTE**

The linear power calibration takes up-to-5 minutes to complete. It calibrates the output power at the reference plane for both internal sources (power out of Port 1 then Port 3) according to the target power across the frequency range set in the calibration specification file. When the test completes, the “Next” button will become available.

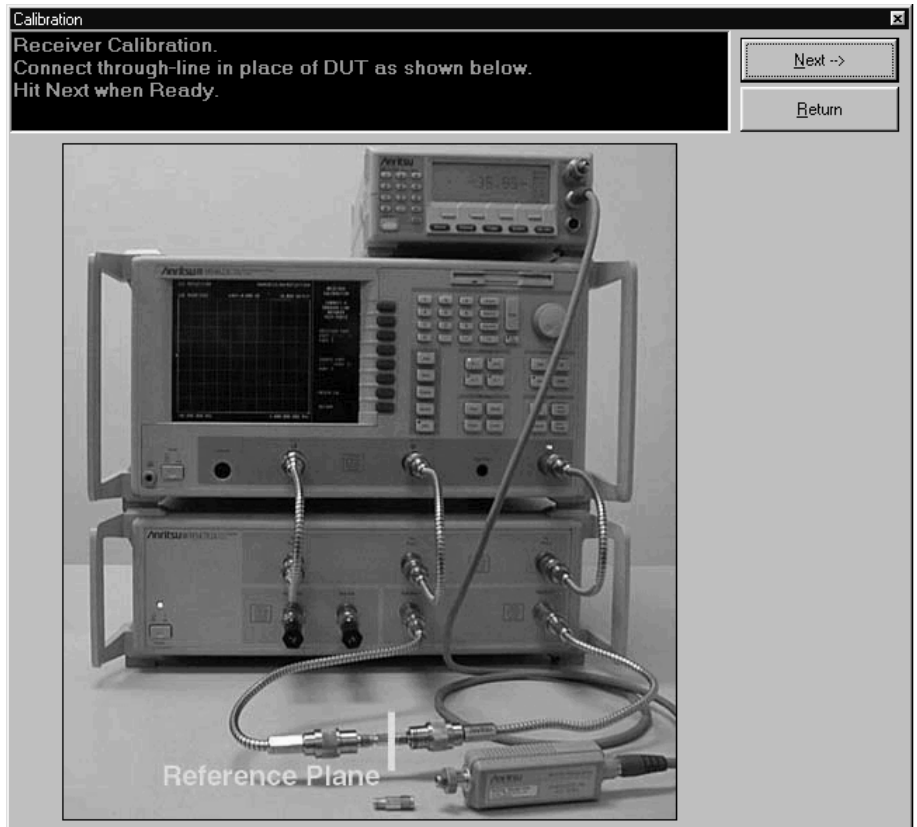
**Step 5.** Press “Next” to calibrate flat power response (below).

**NOTE**

The flat power calibration also takes less than 1 minute to complete. It calibrates the output power at the reference plane for both internal sources (power out of Port 1 then Port 3) according to the target power across the frequency range set in the calibration specification file. When the test completes, the “Next” button will become available.



**Step 6.** Before pressing “Next” disconnect the power sensor and connect a throughline between Test Ports 1 and 2 on the MS4782X Test Set, as shown below.



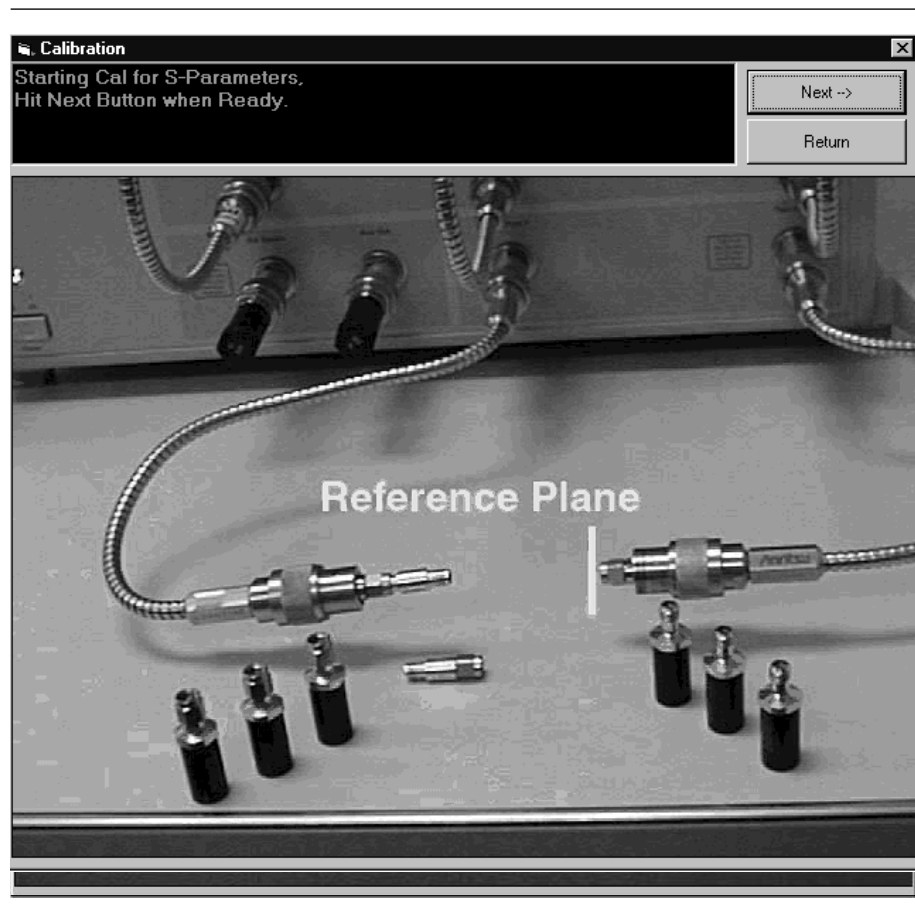
**Step 7.** Press “Next” to perform a receiver calibration. When this calibration finishes, the program returns to the main screen.

**4-7** HOT S22

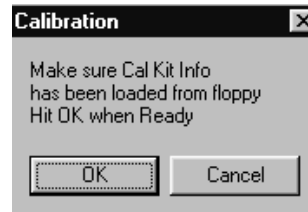
The "B\_HotS22.txt" file provides prompts for setting up a Hot  $S_{22}$  specification file. Hot  $S_{22}$  is a return loss measurement of an amplifier's output port (Port 2) while stimulus is applied to its input port. The prompts cause the Scorpion to be placed into a state where it is ready to make calibrated measurements on the user's AUT. At the completion of the program, the state information is saved to a \*.cal file. To run this program, proceed as follows.

**Step 1.** Select "Tools" then "Run Calibration Procedure."

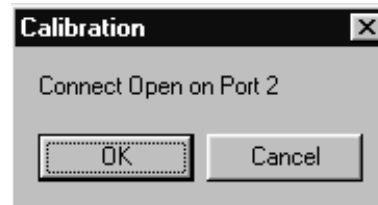
**Step 2.** Double-click on "C\_Hot S22.txt" to begin the Hot  $S_{22}$  cal file setup. Follow the prompt and connect open, short, and load to Port 2 as directed.



**Step 3.** Press “Next” for the next prompt (below). The 3653 or 3753LF Calibration Kits contain a disk with calibration data. The data has to be installed from the MS462C front panel. To do so, place the floppy disk from the kit into the MS462XC disk drive. Press the Cal key then COMPONENTS UTILITIES/INSTALL KIT INFO FROM FLOPPY DISK. softkeys.



**Step 4.** Press “OK” for the next step (below). Connect the Open to Port 2.



**Step 5.** Press “OK” for the next step (below). Connect the Short to Port 2.



**Step 6.** Press "OK" for the next step (below). Connect the Load to Port 2.



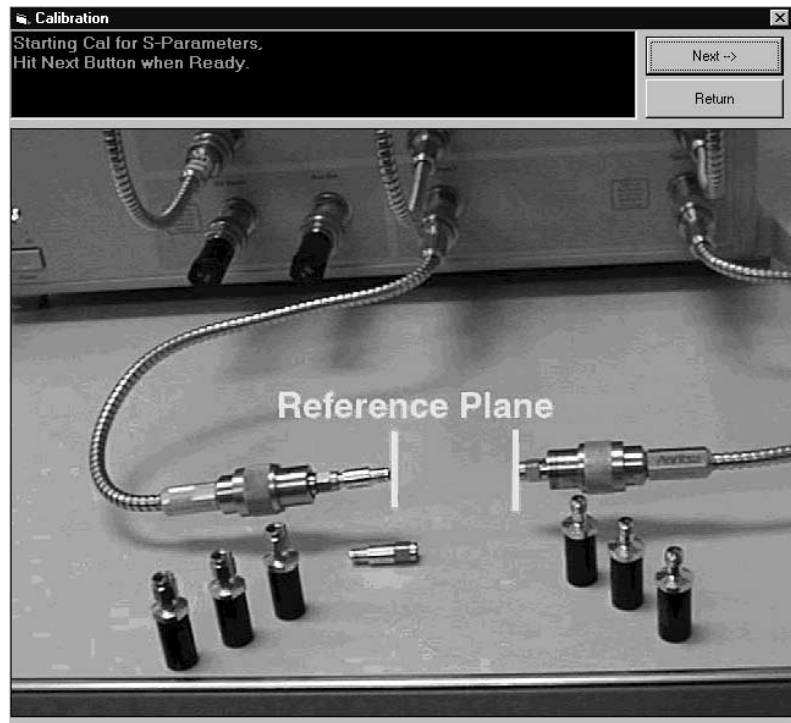
**Step 7.** Press "OK" to complete the Hot S<sub>22</sub> calibration.

**4-8** S-PARAMETERS  
CAL

The "C\_S-Parameters Cal.txt" file provides prompts for setting up S-parameters specification file. The prompts cause the Scorpion to be placed into a state where it is ready to make calibrated measurements on the user's AUT. At the completion of the program, the state information is saved to a \*.cal file. To run this program, proceed as follows.

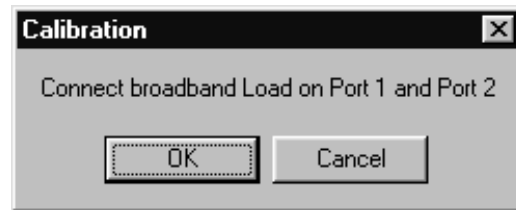
**Step 1.** Select "Tools" then "Run Calibration Procedure."

**Step 2.** Double-click on "D\_S Parameters.txt" to begin the file setup. Follow the prompt and connect open, short, and load to Ports 1 and 2 as directed.

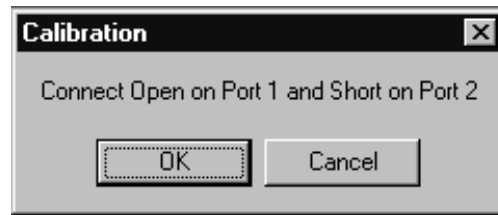


**Step 3.** Press “Next” for the next step (below). The 3653 or 3753LF Calibration Kits contain a disk with calibration data. The data has to be installed from the MS462C front panel. To do so, place the floppy disk from the kit into the MS462XC disk drive. Press the Cal key then COMPONENTS UTILITIES/INSTALL KIT INFO FROM FLOPPY DISK softkeys.

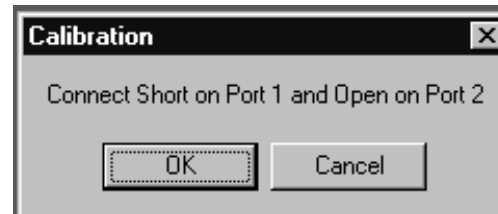
**Step 4.** Press “OK” for the next step (below). Connect the Broadband Load on Test Ports 1 and 2 on the ME7840A Test Set.



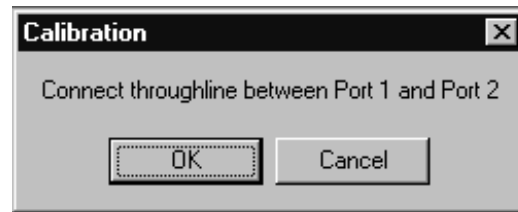
**Step 5.** Press “OK” for the next step (below). Connect the Open to Test Port1 and the Short to Test Port 2.



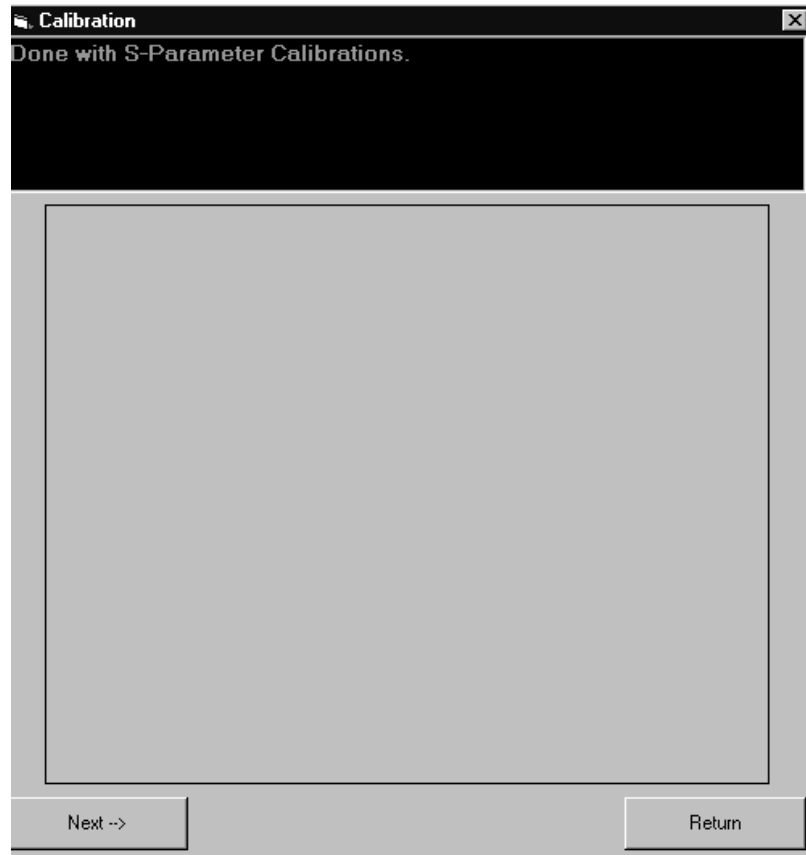
**Step 6.** Press "OK" for the next step (below). Connect the Short to Test Port 1 and the Open to Test Port 2.



**Step 7.** Press "OK" for the next step (below). Connect the Throughline between Test Ports 1 and 2.



**Step 8.** Press "OK" to complete the S Parameters calibration (below).



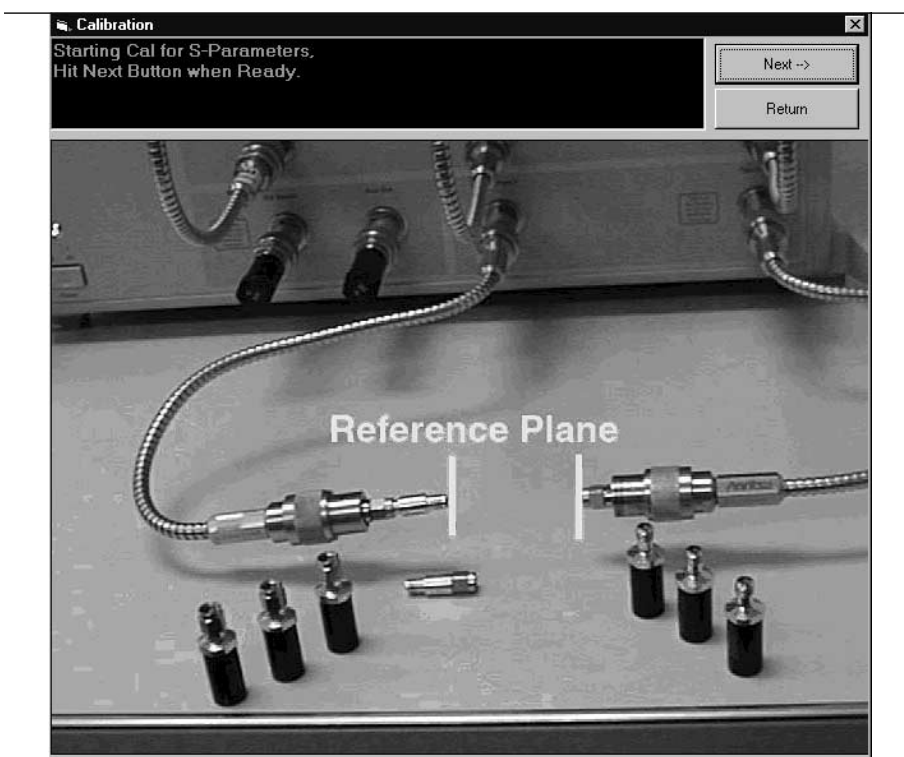


**4-9** CAL FILE SETUP

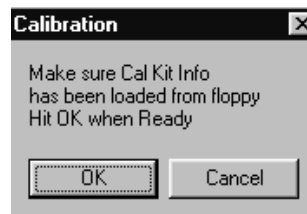
The "D\_Cal File Setup.txt" file provides prompts for setting up One-tone power sweep, IMD, Two-Tone Power Sweep, and Harmonic specification file. The prompts cause the Scorpion to be placed into a state where it is ready to make calibrated measurements on the user's AUT. At the completion of the program, the state information is saved to a \*.cal file. To run this program, proceed as follows.

**Step 1.** Select "Tools" then "Run Calibration Procedure."

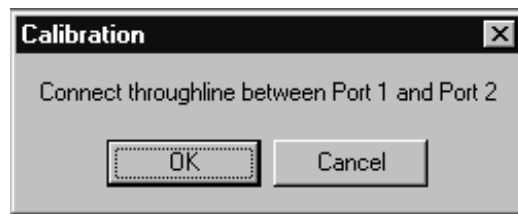
**Step 2.** Double-click on "B\_Cal Files Setup.txt." to begin with the file setup for a Transmission Frequency Response ( $S_{21}$  cal) for One-Tone Power Sweep. Connect a throughline when directed in a following step.



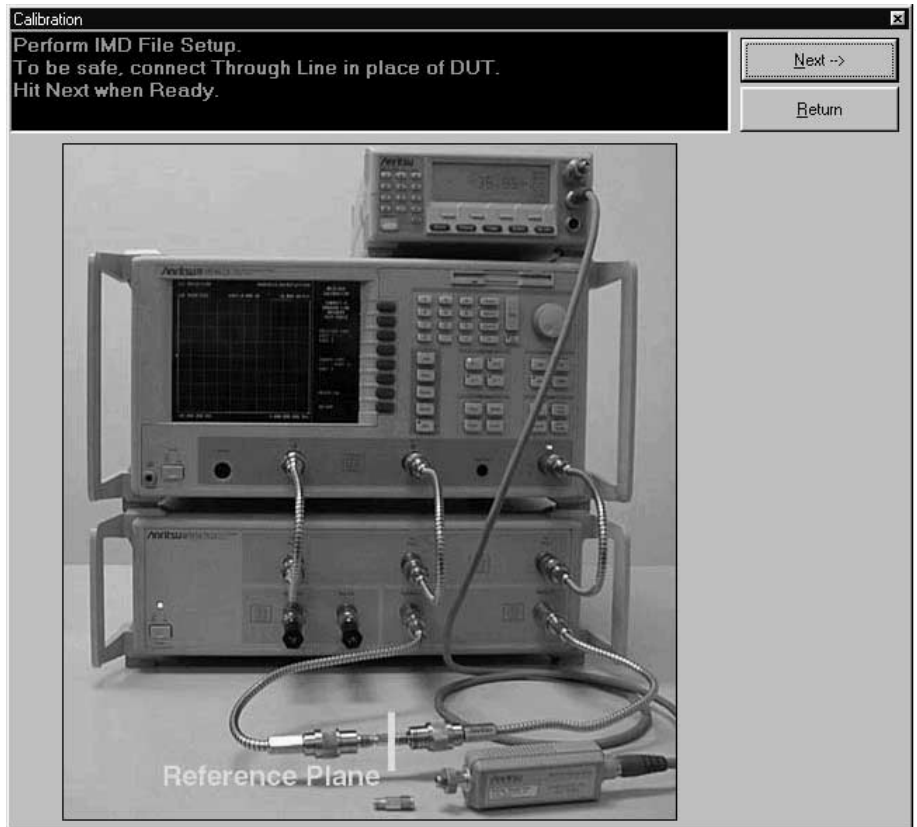
- Step 3.** Press "Next" for the next prompt (below). The 3653 or 3753LF Calibration Kits contain a disk with calibration data. The data has to be installed from the MS462C front panel. To do so, place the floppy disk from the kit into the MS462XC disk drive. Press the Cal key then COMPONENTS UTILITIES/INSTALL KIT INFO FROM FLOPPY DISK. softkeys. Press OK when ready to proceed.



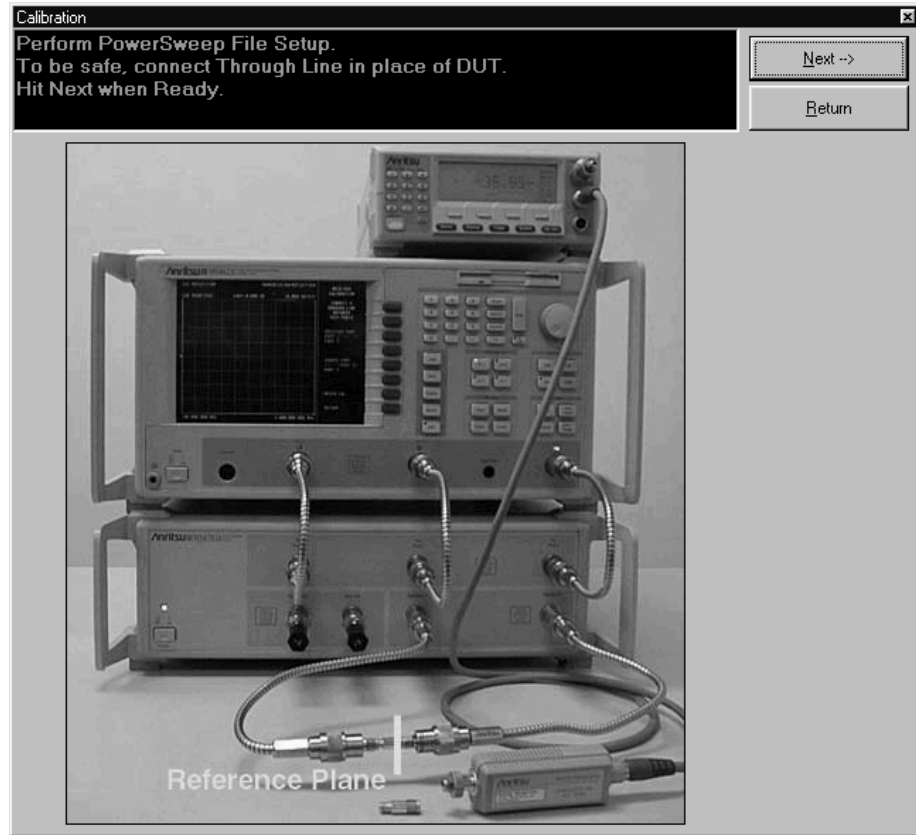
- Step 4.** Connect the Throughline between Test Ports 1 and 2 on the MS4782X Test Set.



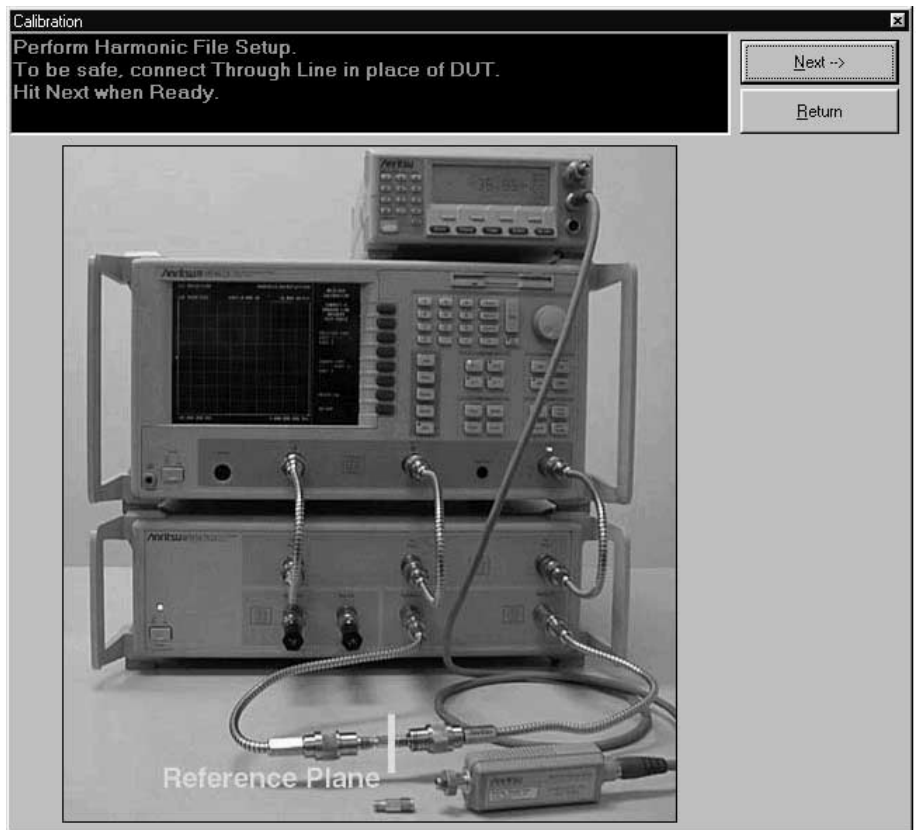
**Step 5.** Press “OK” to continue to the IMD cal file setup prompt (below). Follow the prompt and connect a throughline between Test Ports 1 and 2 on the MS4782X Test Set.



**Step 6.** Press "Next" to begin the Power Sweep cal file setup (below).



**Step 7.** Press “Next” to perform Harmonic Cal File Setup calibration (below).



**Step 8.** Press “Next” to end the calibration and return to the main screen.

# Chapter 5

## Operations, Measurement

### **5-1 INTRODUCTION**

This chapter describes the five measurements available with the ME7840A software: S-Parameters, Power Sweep, IMD (intermodulation distortion), Harmonics, and Hot  $S_{22}$ .

### **5-2 OPERATION, GENERAL**

Refer to Chapter 3 for general operation and setup of the ME7840A.

### **5-3 MEASUREMENT CALIBRATION**

Measurements always include a degree of uncertainty due to imperfections in the measurement system. The measured value is always a combination of the actual value plus the systematic measurement errors. Calibration, as it applies to network analysis, characterizes the systematic measurement errors and subtracts them from the measured value to obtain the actual value. Each of the ME7840A measurements requires a calibration to account for measurement uncertainties. Refer to Chapter 4 for measurement calibration procedures.

### **5-4 GENERAL**

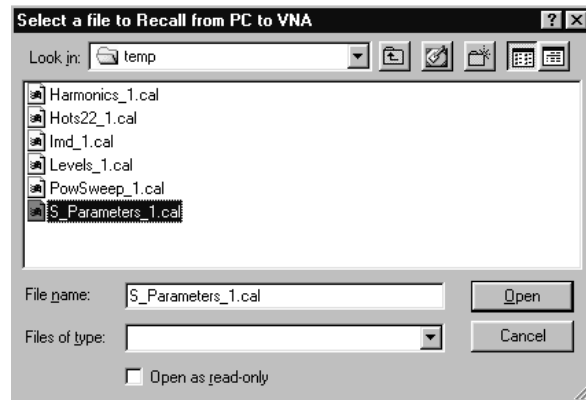
Measurements can be approached from two directions: calibration(s) completed, calibration(s) not completed.

#### ***Calibration(s) Completed***

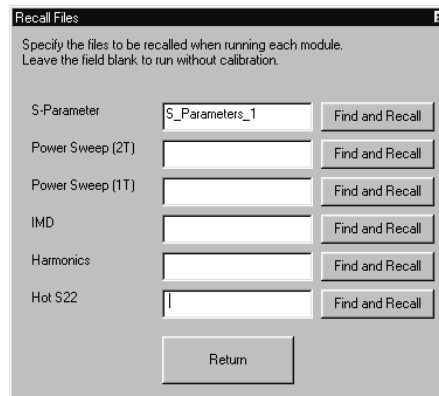
Proceed as follows:

- Step 1.** Click on “Tools,” and open “Check Communications to VNA.”
- Step 2.** Verify the communications are correct.
- Step 3.** Click on “Tools,” and open “Calibration File Options.”
- Step 4.** Click on “Find and Recall” and recall a \*.cal file for each module. Filenames are listed below and shown in graphic below last listing.
  - S Parameters: “S\_Parameters\_1.cal”
  - Power Sweep (2T): “PowSweep\_1.cal”
  - Power Sweep (1T): “PSweep1T\_1.cal”
  - C3, IMD: “Imd\_1.cal”
  - C4, Harmonics: “Harmonics\_1.cal”

■ C5, Hot  $S_{22}$  — “Hots22\_1.cal”



**Step 5.** Select appropriate file “Open” (below).



**Calibration(s) Not Completed**

Sometimes users may wish to run a measurement using default settings, that is, without spending the time required to calibrate. The procedure below gives instructions.

- Step 1.** Click on “Tools,” and open “Check Communications to VNA.”
- Step 2.** Verify the communications are correct.
- Step 3.** Click on “Tools,” and open “Calibration File Options.”
- Step 4.** Clear the text for all modules then select “Return.”
- Step 5.** Press any measurement button on main menu and measurement will be run using “PATS software” default values: Calibration Off on MS462XC and MS462XC Default parameters in place. The default values are shown below.

- D1, S-Parameters and Hot  $S_{22}$ 
  - ✓ Points = 201
  - ✓ Start Frequency = 800 MHz
  - ✓ Stop Frequency = 2400 MHz
  - ✓ Input Power = 0 dB
- D2, Power Sweep (2 tone power sweep)
  - ✓ Main Tone = 950 MHz
  - ✓ Offset = 971 kHz
  - ✓ Start Power = -15 dBm
  - ✓ Stop Power = 0 dBm
  - ✓ Data Points = 21
- D3, IMD
  - ✓ Main Tone = 900 MHz
  - ✓ Offset Frequency = 977 kHz
  - ✓ Input Power = 0 dBm
  - ✓ IMD Order = 9
- D4, Harmonics
  - ✓ Start Frequency = 100 MHz
  - ✓ Stop Frequency = 3000 MHz
  - ✓ Main Tone = 800 MHz
  - ✓ Input Power = 0 dBm



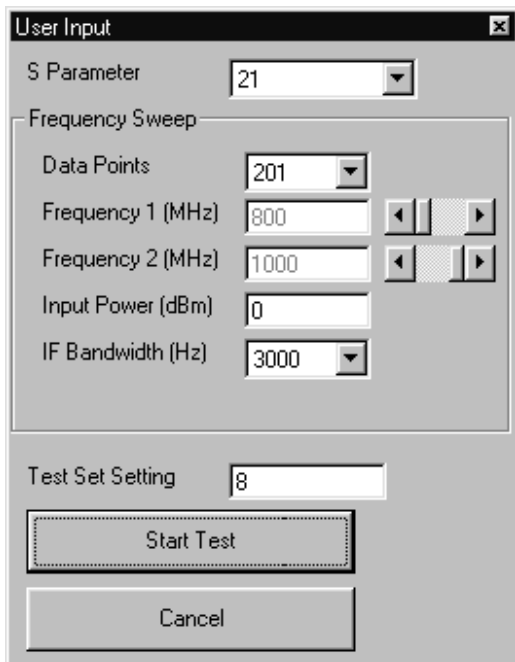
**5-5 S-PARAMETER TESTS:** This test measures the scattering parameters (S-parameters). The test module comprises six tests:  $S_{11}$ ,  $S_{12}$ ,  $S_{21}$ ,  $S_{22}$ , and ALL. (The K Factors test is described in paragraph 5-6.) In each case, the measurement screens are the similar. This procedure will present a test screen for the “ $S_{21}$ ” measurement and will describe certain differences at the end of the procedure.

$S_{21}$ ,  $S_{11}$ ,  $S_{22}$ ,  $S_{12}$ , ALL

**Procedure.**

Prepare the ME7840A as shown in Chapter 3.

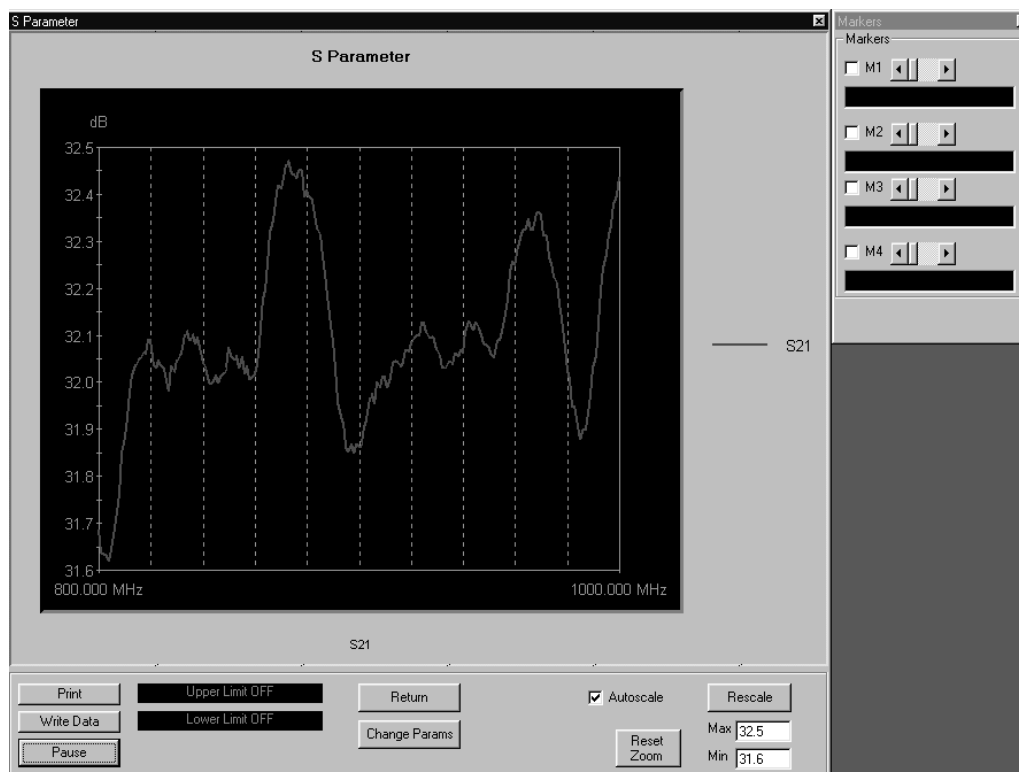
Enter the appropriate test values in the displayed User Input screen. The input fields are described below: The inputs required for this test are described below.



- **S-Parameter:** Drop down options. Set to  $S_{21}$  for this procedure. Other selections include  $S_{11}$ ,  $S_{12}$ ,  $S_{22}$ , ALL, and K Factor (paragraph 5-6).
- **Data Points:** Drop down options – number of data points in frequency sweep.
- **Frequency 1 (MHz):** Lower frequency or start frequency.
- **Frequency 2 (MHz):** Upper frequency or stop frequency.
- **Input Power (dBm):** Input power level, in dBm.
- **IF Bandwidth (Hz):** Intermediate frequency bandwidth for test, in Hertz.
- **Test Set Setting:** Byte value for setting test set attenuation and source switch (below).

Internal Source	Value	External Source	Value
0 dB	8	0 dB	0
10 dB	9	10 dB	1
20 dB	10	20 dB	2
30 dB	11	30 dB	3
40 dB	12	40 dB	4
50 dB	13	50 dB	5
60 dB	14	60 dB	6
70 dB	15	70 dB	7

- **Select Start Test:** Observe that the test screen (Figure 5-1) appears.



**Figure 5-1.** S-Parameters Test Screen for  $S_{21}$

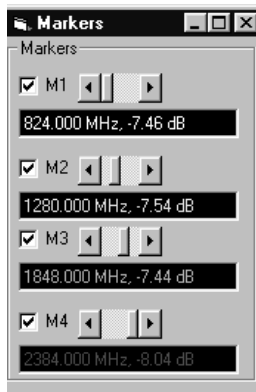
#### Button Panel Options:

- **Print:** Prints a copy of the screen graphic to a printer.
- **Write Data:** Two data files are written to the C:\Program Files\Pats\Datafiles folder; the file name will have a time stamp. One datafile has a “.csv” file extension and the other has a “.s2p” file extension. *For example:* “S17-16-19-29.csv (and s2p)” was created on the 17th day of the month at 4:19 PM and 49 seconds. CSV and S2P files are comma separated text and can be opened in the Windows Microsoft Excel spreadsheet.
- **Upper Limit/Lower Limit:** Limit values as set using Tools menus (Chapter 4).
- **Return:** Returns to the main PATS screen.

- Change Params:** Returns to User Input screen.
- Autoscale Checkbox:** Turns autoscale on or off. Autoscale automatically scales the measurement results.
- Reset/Zoom:** Disabled for this test.
- Max/Min:** Type in maximum and minimum display value. Use Rescale after changing values.
- Rescale:** Rescales the measurement results.

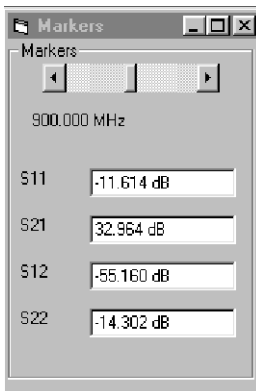
Markers Screen Options for  $S_{11}$ ,  $S_{21}$ ,  $S_{12}$ ,  $S_{22}$  (left):

- M1:** Turns marker on or off (checked or unchecked). If on: Slider moves marker between data points, and window below displays marker frequency and amplitude values amplitude value at the marker.
- M2:** Same as above.
- M3:** Same as above.
- M4:** Same as above.



Markers Screen Options for ALL (left):

- Marker Slider:** Moves marker between data points.
- Frequency Display:** Displays marker frequency.
- S11:**  $S_{11}$  input return loss.
- S21:**  $S_{21}$  gain.
- S12:**  $S_{12}$  output isolation.
- S22:**  $S_{22}$  output return loss.



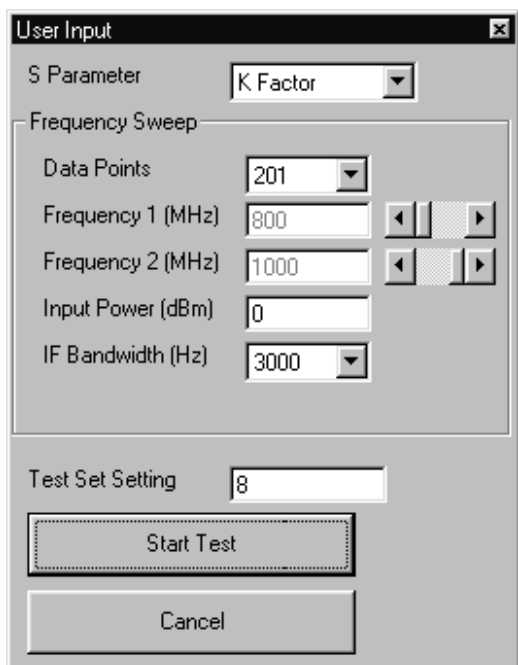
**5-6 S-PARAMETER TEST: K FACTOR**

This test describes the K Factors measurement. This measurement is described in Chapter 1, paragraph 1-10.

**Procedure.**

Prepare the ME7840A as shown in Chapter 3.

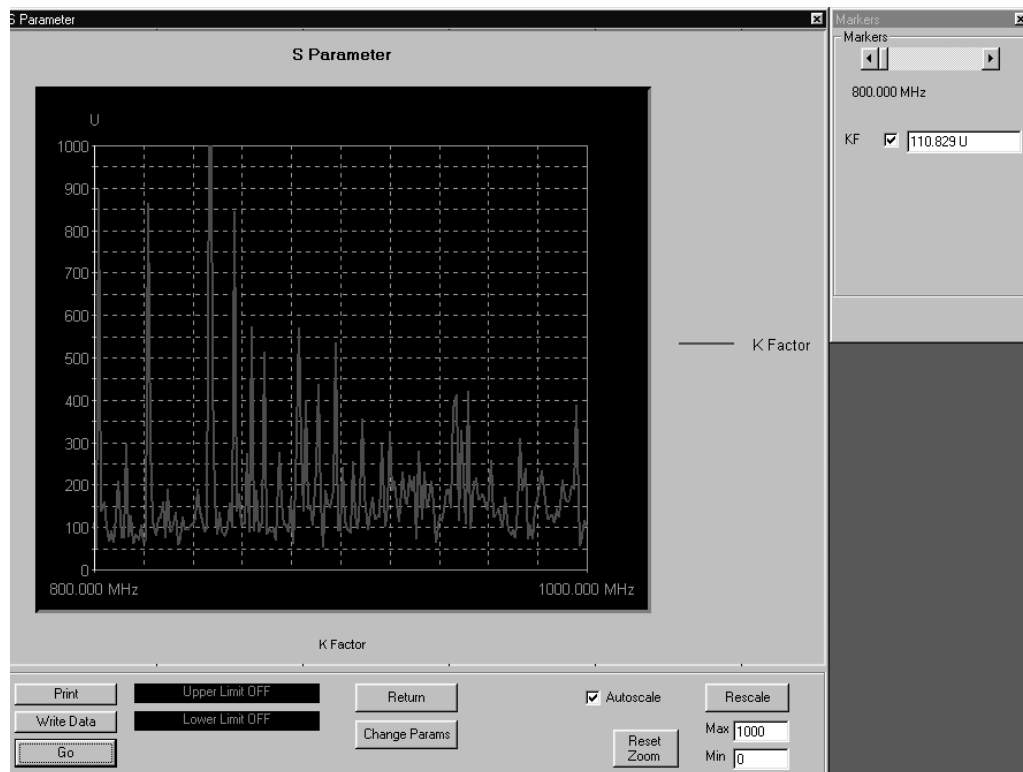
Enter the appropriate test values in the displayed User Input screen. The input fields are described below: The inputs required for this test are described below.



- **S-Parameter:** Drop down options. K Factor for this measurement.
- **Data Points:** Drop down options – number of data points in frequency sweep.
- **Frequency 1 (MHz):** Lower frequency or start frequency.
- **Frequency 2 (MHz):** Upper frequency or stop frequency.
- **Input Power (dBm):** Input power level, in dBm.
- **IF Bandwidth (Hz):** Intermediate frequency bandwidth for test, in Hertz.
- **Test Set Setting:** Byte value for setting test set attenuation and source switch (below).

Internal Source	Value	External Source	Value
0 dB	8	0 dB	0
10 dB	9	10 dB	1
20 dB	10	20 dB	2
30 dB	11	30 dB	3
40 dB	12	40 dB	4
50 dB	13	50 dB	5
60 dB	14	60 dB	6
70 dB	15	70 dB	7

- **Select Start Test:** Observe that the test screen (Figure 5-1) appears.



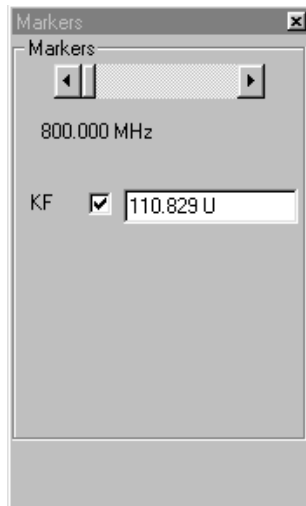
**Figure 5-2.** S-Parameters Test Screen for  $S_{21}$

#### Button Panel Options:

- ❑ **Print:** Prints a copy of the screen graphic to a printer.
- ❑ **Write Data:** Two data files are written to the C:\Program Files\Pats\Datafiles folder; the file name will have a time stamp. One datafile has a “.csv” file extension and the other has a “.s2p” file extension. *For example:* “S17-16-19-29.csv (and s2p)” was created on the 17th day of the month at 4:19 PM and 49 seconds. CSV and S2P files are comma separated text and can be opened in the Windows Microsoft Excel spreadsheet.
- ❑ **Upper Limit/Lower Limit:** Limit values as set using Tools menu (Chapter 4).
- ❑ **Return:** Returns to the main PATS screen.

- Change Params:** Returns to User Input screen.
- Autoscale Checkbox:** Turns autoscale on or off. Autoscale automatically scales the measurement results.
- Reset/Zoom:** Disabled for this test.
- Max/Min:** Type in maximum and minimum display value. Use Rescale after changing values.
- Rescale:** Rescales the measurement results.

Markers Screen Options for K Factor (left):



- Marker Slider:** Moves marker between data points.
- Frequency Display:** Displays marker frequency.
- KF:** Displays the K factor value. K factor is a stability factor of interest for amplifier designers.

**5-7 POWER SWEEP, TWO TONE**

This measurement module has three variations of possible Measurement Types: Power Sweep (single frequency), Multi Frequency Power Sweep, Gain and IMD.

**Single Frequency Power Sweep****Procedure.**

Prepare the ME7840A as shown in Chapter 3.

Enter the appropriate test values in the displayed User Input screen. The input fields are described below:

The screenshot shows a 'User Input' dialog box with the following fields and values:

- Measurement Type: Power Sweep (dropdown)
- Main Tone (MHz): 906
- Offset (kHz): 931
- Start power (dBm): -19 to 1
- Data Points: 26
- Increment Power: 0.8
- Source Attn (dB): 0 (dropdown)
- Test Set Setting: 8
- P Stop Level (dB): Off (dropdown)
- Drain Current
- DC Volts: 15.0

Buttons: Start Test, Cancel

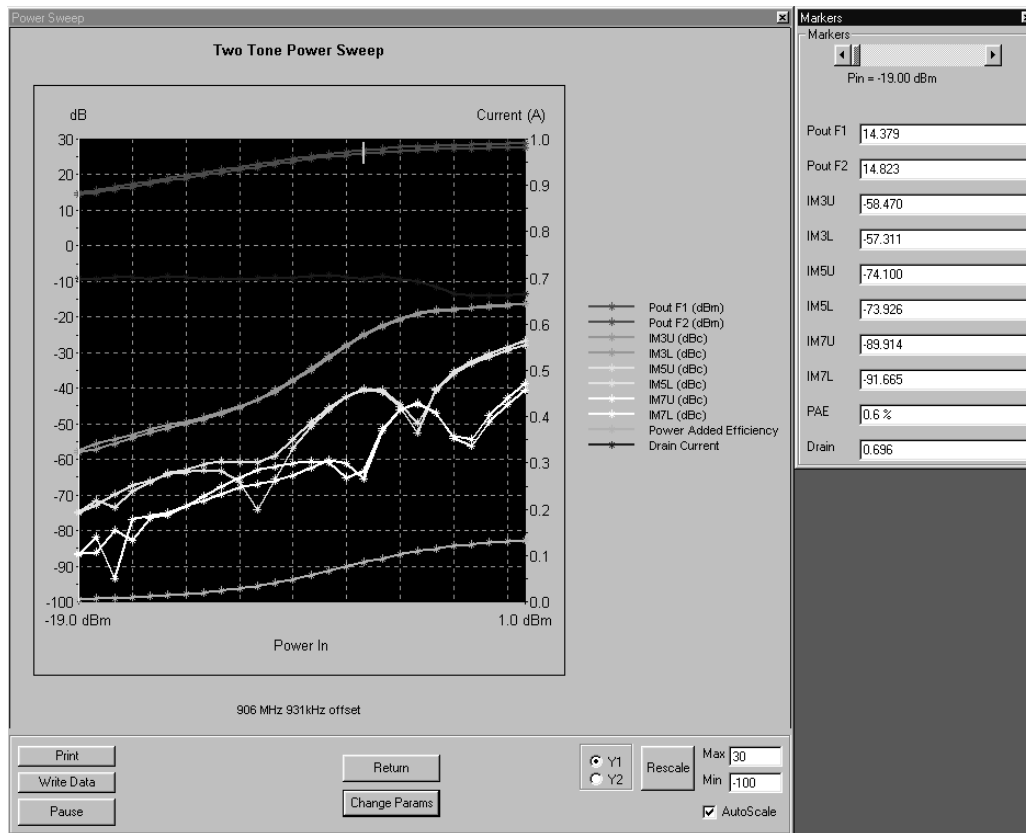
- **Measurement Type:** Drop down options showing Power Sweep (single frequency), Multi Freq Power Sweep (uses 3 frequencies), Gain & IMD. Set to "Power Sweep" for this test.
- **Main Tone (MHz):** CW Frequency setting for source 1.
- **Offset (kHz):** Offset frequency for Source 2 (Source 2 will be set to Main Tone + Offset).
- **Start Power (dBm):** Power will be swept starting at the start power (input RF power to AUT). Both sources are simultaneously set to each power setting. The stop power is also entered in the "to" window.
- **Data Points:** Number of data points in power sweep.
- **Increment Power (dBm):** Value to increment power for each data point (calculated and displayed only).
- **Source Attn (dB):** Value of Source attenuation, between 0 and -70 (calculated and displayed only).
- **Drain Current Checkbox:** When checked the drain current is measured and power added efficiency is calculated and displayed.
- **PStop Level (dB):** Provides the ability to set the PStop value based on the level of gain compression. Drop down options include compression levels of 1 dB through 10 dB in 1 dB increments, and OFF. If OFF is selected, then the P Stop equals the value entered in the "to" window above. If the selected compression occurs, PStop for all subsequent power sweeps is reset to one increment before the  $P_{in}$  value where this compression level is reached.

- **Test Set Setting:** Byte value for setting test set attenuation and source switch (below).

Internal Source	Value	External Source	Value
0 dB	8	0 dB	0
10 dB	9	10 dB	1
20 dB	10	20 dB	2
30 dB	11	30 dB	3
40 dB	12	40 dB	4
50 dB	13	50 dB	5
60 dB	14	60 dB	6
70 dB	15	70 dB	7



Select **Start Test** and observe that the test screen (Figure 5-3) appears.



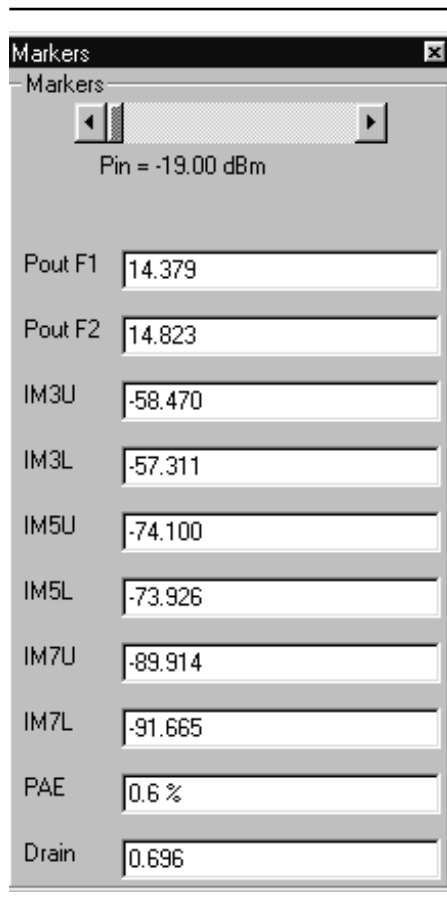
**Figure 5-3.** Single Frequency Power Sweep Test

#### Button Panel Options:

- Print:** Prints a copy of the screen graphic to a printer.
- Write Data:** Excel data is written to C:\Program Files\Pats\Datafiles - the file name will have a time stamp. *For example:* "S17-16-19-29.csv" was created on the 17th day of the month at 4:19 PM and 49 seconds. CSV files are comma separated text and can be opened in Windows Excel.
- Pause/Go:** Stops data transfer from VNA to PC and places MS4623C in "Local" mode.
- Return:** Returns to the main PATS screen.
- Change Params:** Returns to User Input screen.

- Autoscale Checkbox:** Turns autoscale on or off. Autoscale automatically scales the measurement results.
- Reset/Zoom:** Disabled for this test.
- Max/Min:** Type in maximum and minimum display value. Use Rescale after changing values.
- Rescale:** Rescales the measurement results.
- Pause/Go: Pause** stops data transfer from VNA to PC and places MS462XC in “Local” mode. **Go** starts data transfer to MS462XC in “Remote” mode.

Markers Screen Options (left):



- Markers slider:** Moves marker between data points.
- Power In Reading:** Indicates the input power value.
- Pout F1:** Power output at frequency 1.
- Pout F2:** Power output at frequency 2.
- IM3U:** Intermodulation product 3 upper side-band
- IM3L:**Intermodulation product 3 lower side-band
- IM5U:**Intermodulation product 5 upper side-band
- IM5L:**Intermodulation product 5 lower side-band
- IM7U:**Intermodulation product 7 upper side-band
- IM7L:**Intermodulation product 7 lower side-band
- PAE:** Power-added efficiency percentage.
- Drain:** Drain current value.

**NOTE**

**PAE** and **Drain** may be on or off according to check box in parameter screen.

### Multiple Frequency Procedure. Power Sweep

The screenshot shows a 'User Input' dialog box with the following fields and options:

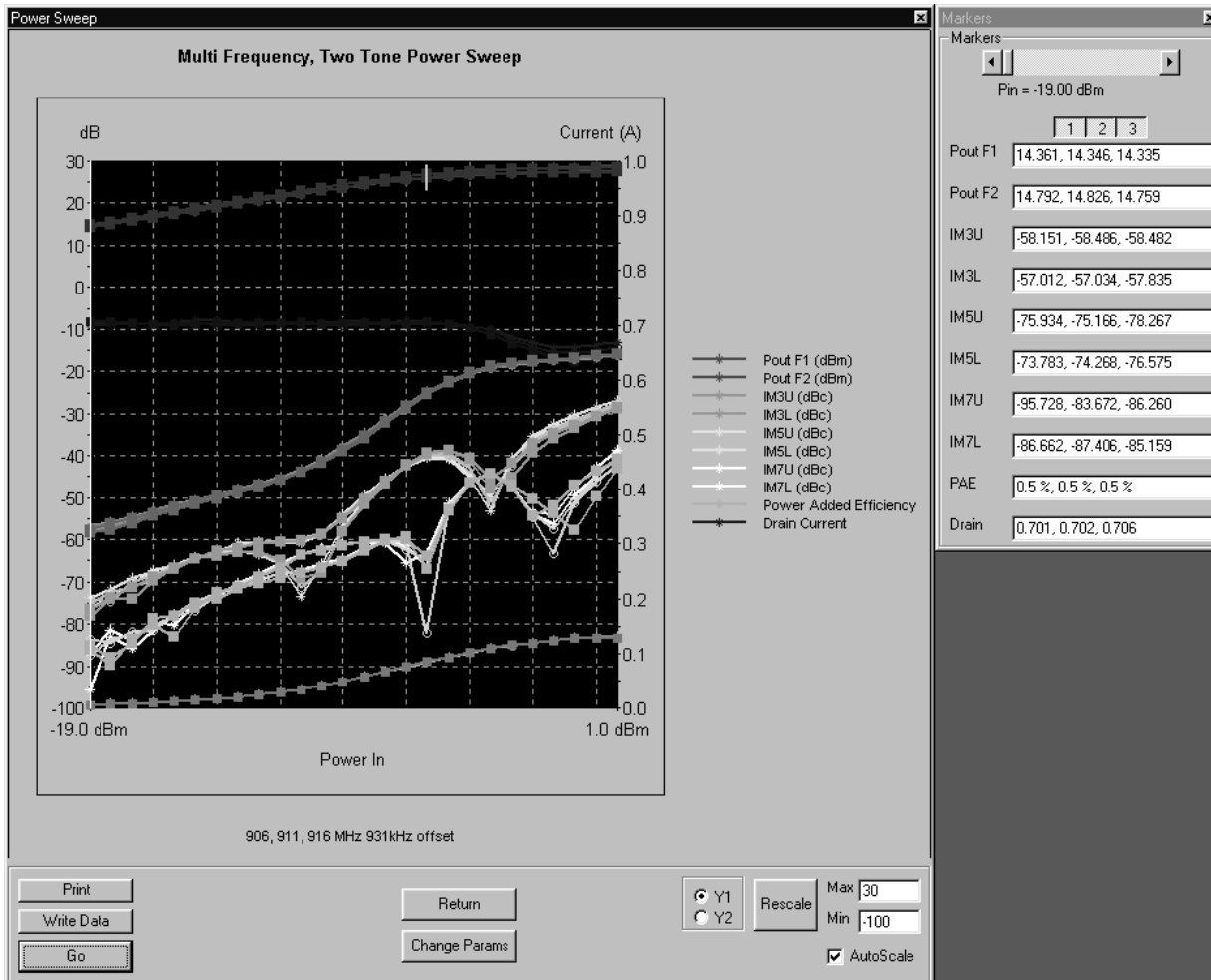
- Measurement Type: Multi Freq Pow Sweep (dropdown)
- Main Tone (MHz): 906 to 916
- Offset (kHz): 931
- Start power (dBm): -19 to 1
- Data Points: 26
- Increment Power: 0.8
- Source Attn (dB): 0 (dropdown)
- Test Set Setting: 8
- P Stop Level (dB): Off (dropdown)
- Drain Current
- DC Volts: 15.0
- Start Test button
- Cancel button

- **Measurement Type:** Drop down options. Set to “Multi Freq Power Sweep” for this test.
- **Main Tone (MHz):** CW Frequency setting for source 1. The user may set a lower tone and upper tone. The software will sweep three frequencies (the two input plus one between) and the RF input power to produce the display data.
- **Offset (kHz):** Offset frequency for Source 2 (Source 2 will be set to Main Tone + Offset).
- **Start Power (dBm):** Power will be swept starting at the start power (input RF power to AUT). Both sources are simultaneously set to each power setting. The stop power is also entered in the “to” window.
- **Data Points:** Number of data points in power sweep.
- **Increment Power (dBm):** Value to increment power for each data point (calculated and displayed only).
- **Source Attn (dB):** Value of Source attenuation, between 0 and -70 (calculated and displayed only).
- **Drain Current Checkbox:** When checked the drain current is measured and power added efficiency is calculated and displayed.
- **PStop Level (dB):** Provides the ability to set the PStop value based on the level of gain compression. Drop down options include compression levels of 1 dB through 10 dB in 1 dB increments, and OFF. If OFF is selected, then the P Stop equals the value entered in the “to” window above. If the selected compression occurs, PStop for all subsequent power sweeps is reset to one increment before the  $P_{in}$  value where this compression level is reached.

- **Test Set Setting:** Byte value for setting test set attenuation and source switch (below).

Internal Source	Value	External Source	Value
0 dB	8	0 dB	0
10 dB	9	10 dB	1
20 dB	10	20 dB	2
30 dB	11	30 dB	3
40 dB	12	40 dB	4
50 dB	13	50 dB	5
60 dB	14	60 dB	6
70 dB	15	70 dB	7

Select **Start Test**. Observe that the test screen (Figure 5-4) appears.



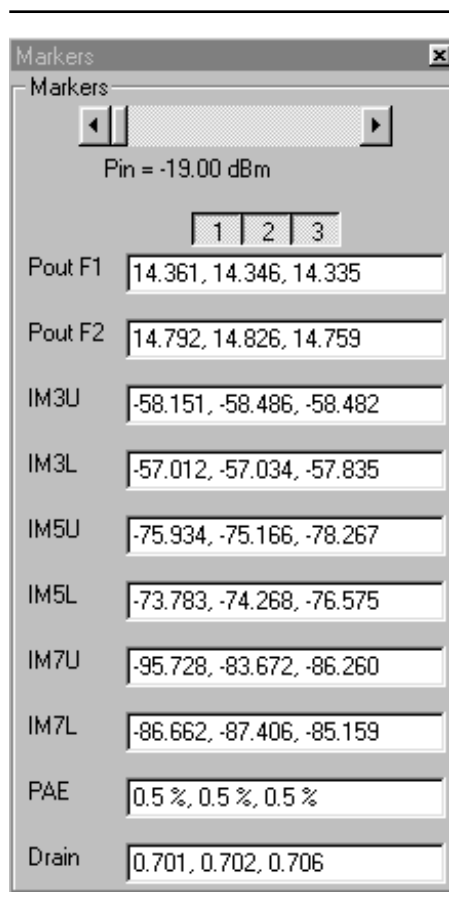
**Figure 5-4.** Multiple Frequency Power Sweep Test

#### Button Panel Options:

- ❑ **Print:** Prints a copy of the screen graphic to a printer.
- ❑ **Write Data:** Excel data is written to C:\Program Files\Pats\Datafiles - the file name will have a time stamp. *For example:* "S17-16-19-29.csv" was created on the 17th day of the month at 4:19 PM and 49 seconds. CSV files are comma separated text and can be opened in Windows Excel.

- ❑ **Pause/Go:** Stops data transfer from VNA to PC and places MS4623C in “Local” mode.
- ❑ **Return:** Returns to the main PATS screen.
- ❑ **Change Params:** Returns to User Input screen.
- ❑ **Y1, Y2:** Provides for rescaling the left or right axis.
- ❑ **Rescale:** Rescales the measurement results.
- ❑ **Max/Min:** Type in maximum and minimum display value. Use Rescale after changing values.

Markers Screen Options (left):



- ❑ **Markers slider:** Moves marker between data points.
- ❑ **Pout F1:** Power output at frequency 1.
- ❑ **Pout F2:** Power output at frequency 2.
- ❑ **IM3U:** Intermodulation product 3 upper side-band
- ❑ **IM3L:**Intermodulation product 3 lower side-band
- ❑ **IM5U:**Intermodulation product 5 upper side-band
- ❑ **IM5L:**Intermodulation product 5 lower side-band
- ❑ **IM7U:**Intermodulation product 7 upper side-band
- ❑ **IM7L:**Intermodulation product 7 lower side-band
- ❑ **PAE:** Power-added efficiency percentage.
- ❑ **Drain:** Drain current value.

**Gain and IMD Power Sweep****Procedure:**

The screenshot shows a 'User Input' dialog box with the following fields and options:

- Measurement Type: Gain and IMD (dropdown)
- Main Tone (MHz): 906
- Offset (kHz): 931
- Start power (dBm): -19 to 1
- Data Points: 26
- Increment Power: 0.8
- Source Attn (dB): 0 (dropdown)
- Test Set Setting: 8
- P Stop Level (dB): Off (dropdown)
- Drain Current
- DC Volts: 15.0
- Buttons: Start Test, Cancel

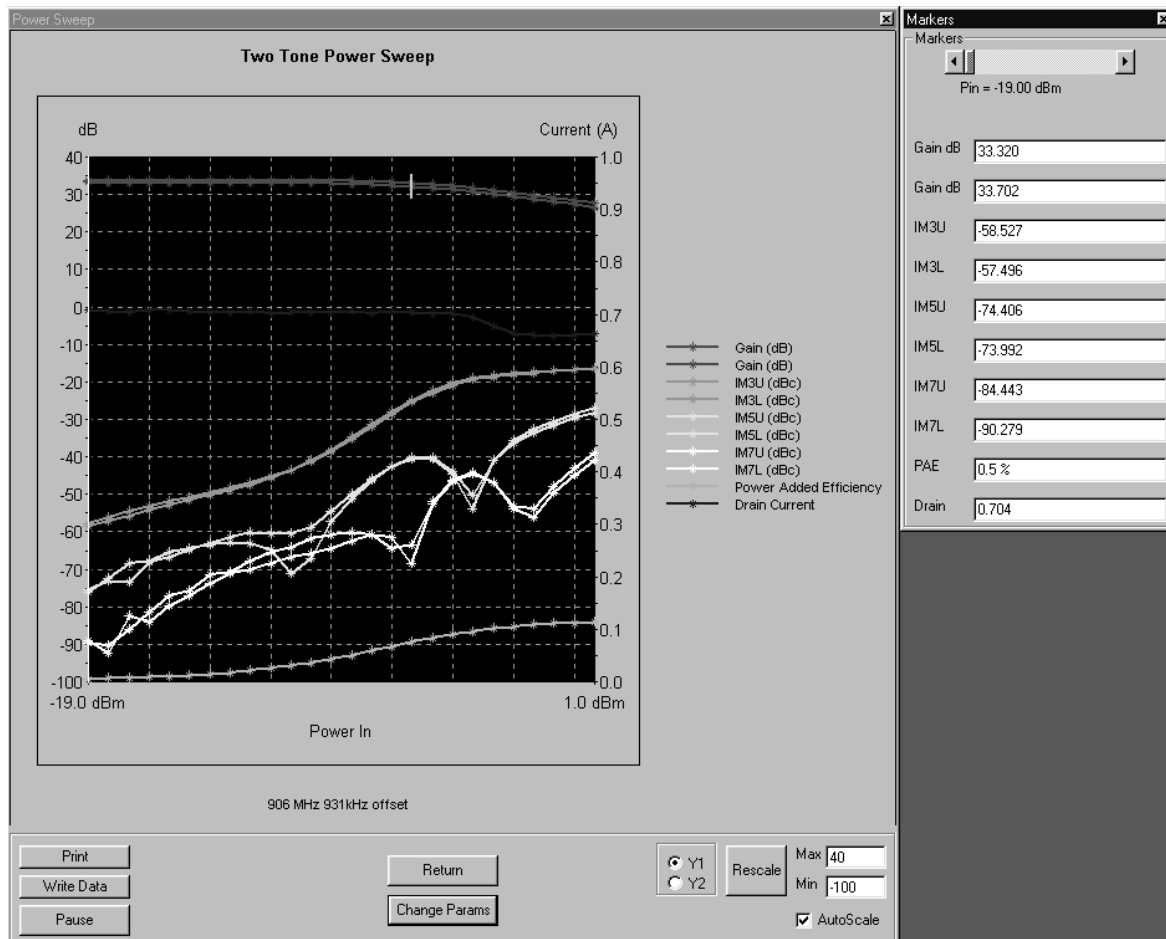
- **Measurement Type:** Drop down options. Set to “Gain and IMD ” for this test.
- **Main Tone (MHz):** CW Frequency setting for source 1.
- **Offset (kHz):** Offset frequency for Source 2 (Source 2 will be set to Main Tone + Offset)
- **Start Power (dBm):** Power will be swept starting at the start power (input RF power to AUT). Both sources are simultaneously set to each power setting. The stop power is also entered in the “to” window.
- **Data Points:** Number of data points in power sweep.
- **Increment Power (dBm):** Value to increment power for each data point (calculated and displayed only).
- **Source Attn (dB):**Value of Source attenuation, between 0 and -70 (calculated and displayed only).
- **Drain Current Checkbox:** When checked the drain current is measured and power added efficiency is calculated and displayed.
- **PStop Level (dB):**Provides the ability to set the PStop value based on the level of gain compression. Drop down options include compression levels of 1 dB through 10 dB in 1 dB increments, and OFF. If OFF is selected, then the P Stop equals the value entered in the “to” window above. If the selected compression occurs, PStop for all subsequent power sweeps is reset to one increment before the  $P_{in}$  value where this compression level is reached.

- **Test Set Setting:** Byte value for setting test set attenuation and source switch (below).

Internal Source	Value	External Source	Value
0 dB	8	0 dB	0
10 dB	9	10 dB	1
20 dB	10	20 dB	2
30 dB	11	30 dB	3
40 dB	12	40 dB	4
50 dB	13	50 dB	5
60 dB	14	60 dB	6
70 dB	15	70 dB	7



Select **Start Test**. Observe that the test screen (Figure 5-5) appears.



**Figure 5-5.** Power Sweep Gain and IMD Test Screen, with Markers Selected

#### Button Panel Options:

- Print:** Prints a copy of the screen graphic to a printer.
- Write Data:** Excel data is written to C:\Program Files\Pats\Datafiles - the file name will have a time stamp. *For example:* "S17-16-19-29.csv" was created on the 17th day of the month at 4:19 PM and 49 seconds. CSV files are comma separated text and can be opened in Windows Excel.
- Pause/Go:** Stops data transfer from VNA to PC and places MS4623C in "Local" mode.

- ❑ **Return:** Returns to the main PATS screen.
- ❑ **Change Params:** Returns to User Input screen.
- ❑ **Y1, Y2:** Provides for rescaling the left or right axis.
- ❑ **Rescale:** Rescales the measurement results.
- ❑ **Max/Min:** Type in maximum and minimum display value. Use Rescale after changing values.

Markers Screen Options (left):

Measurement	Value
Gain dB	33.320
Gain dB	33.702
IM3U	-58.527
IM3L	-57.496
IM5U	-74.406
IM5L	-73.992
IM7U	-84.443
IM7L	-90.279
PAE	0.5 %
Drain	0.704

- ❑ **Markers slider:** Moves marker between data points.
- ❑ **Gain dB:** Gain (or S21) is measured at each CW tone as the power is swept. The measurement is made in IMD mode. The Gain is actually measured by calculating the difference between Power In (in dBm) and Power Out (in dBm). Calibration applied is Linear Power Cal and Receiver Cal. (Could also be called Gain and compression measurement). The displayed Power In level is the power of each input tone.
- ❑ **Gain dB:** See above.
- ❑ **IM3U:** Intermodulation product 3 upper side-band
- ❑ **IM3L:** Intermodulation product 3 lower side-band
- ❑ **IM5U:** Intermodulation product 5 upper side-band
- ❑ **IM5L:** Intermodulation product 5 lower side-band
- ❑ **IM7U:** Intermodulation product 7 upper side-band
- ❑ **IM7L:** Intermodulation product 7 lower side-band
- ❑ **PAE:** Power-added efficiency percentage.
- ❑ **Drain:** Drain current value.

**5-8 POWER SWEEP, ONE TONE**

This measurement module has three variations of possible Measurement Types: Power Sweep (single frequency), Multi Frequency Power Sweep, Gain and IMD.

**Single Frequency Power Sweep****Procedure.**

Prepare the ME7840A as shown in Chapter 3.

Enter the appropriate test values in the displayed User Input screen. The input fields are described below:

The screenshot shows a 'User Input' dialog box with the following fields and options:

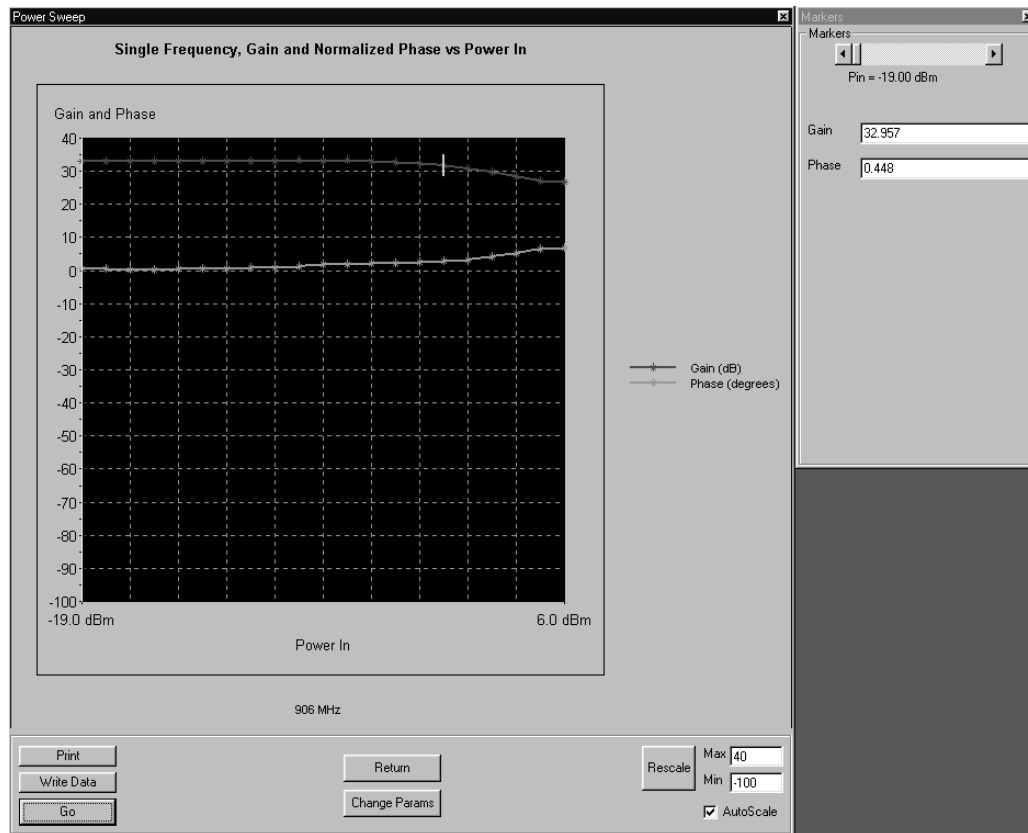
- Measurement Type: Gain and Phase (dropdown)
- Main Tone (MHz): 906 (text input)
- Start power (dBm): -19 to 6 (text inputs)
- Data Points: 21 (text input)
- Increment Power: 0.75 (text input)
- Source Attn (dB): 0 (dropdown)
- Test Set Setting: 8 (text input)
- P Stop Level (dB): Off (dropdown)
- Drain Current (checkbox)
- Start Test (button)
- Cancel (button)

- **Measurement Type:** Drop down options set to “Gain and Phase ” for this test.
- **Main Tone (MHz):** CW Frequency setting for source 1.
- **Start Power (dBm):** Power will be swept starting at the start power (input RF power to AUT). Both sources are simultaneously set to each power setting. The stop power is also entered in the “to” window.
- **Data Points:** Number of data points in power sweep.
- **Increment Power (dBm):** Value to increment power for each data point (calculated and displayed only).
- **Source Attn (dB):**Value of Source attenuation, between 0 and -70 (calculated and displayed only).
- **Drain Current Checkbox:** When checked the drain current is measured and power added efficiency is calculated and displayed.
- **PStop Level (dB):**Provides the ability to set the PStop value based on the level of gain compression. Drop down options include compression levels of 1 dB through 10 dB in 1 dB increments, and OFF. If OFF is selected, then the P Stop equals the value entered in the “to” window above. If the selected compression occurs, PStop for all subsequent power sweeps is reset to one increment before the  $P_{in}$  value where this compression level is reached.

- **Test Set Setting:** Byte value for setting test set attenuation and source switch (below).

Internal Source	Value	External Source	Value
0 dB	8	0 dB	0
10 dB	9	10 dB	1
20 dB	10	20 dB	2
30 dB	11	30 dB	3
40 dB	12	40 dB	4
50 dB	13	50 dB	5
60 dB	14	60 dB	6
70 dB	15	70 dB	7

Select **Start Test** and observe that the test screen (Figure 5-3) appears.



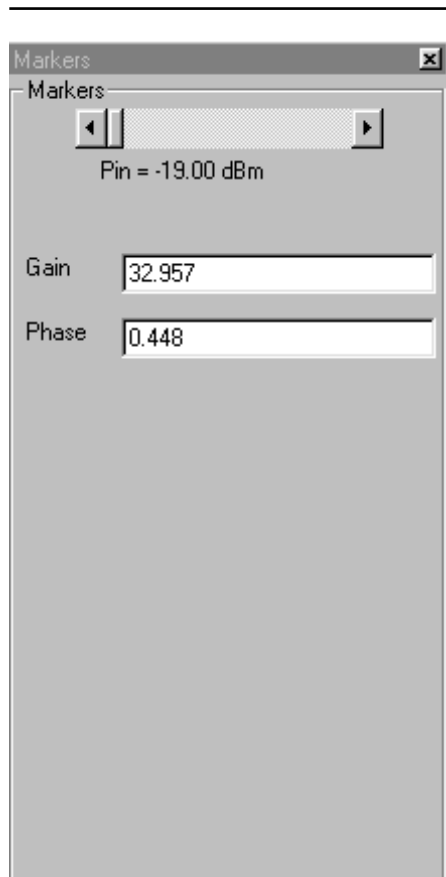
**Figure 5-6.** Single Frequency Power Sweep Test

#### Button Panel Options:

- Print:** Prints a copy of the screen graphic to a printer.
- Write Data:** Excel data is written to C:\Program Files\Pats\Datafiles - the file name will have a time stamp. *For example:* "S17-16-19-29.csv" was created on the 17th day of the month at 4:19 PM and 49 seconds. CSV files are comma separated text and can be opened in Windows Excel.
- Pause/Go:** Stops data transfer from VNA to PC and places MS4623C in "Local" mode.
- Return:** Returns to the main PATS screen.
- Change Params:** Returns to User Input screen.

- ❑ **Autoscale Checkbox:** Turns autoscale on or off. Autoscale automatically scales the measurement results.
- ❑ **Max/Min:** Type in maximum and minimum display value. Use Rescale after changing values.
- ❑ **Rescale:** Rescales the measurement results.

#### Markers Screen Options (left):



- ❑ **Markers slider:** Moves marker between data points.
- ❑ **Gain:** Gain is in dB and is the Gain, measured at the CW frequency for each power level in the power sweep. (Could also be called Gain compression measurement.) The displayed power in the power of 1 input tone.
- ❑ **Phase:** Phase is an AM/PM measurement/display – the phase at the initial power level of the power sweep is used as a normalized level (zero). As the power is swept, the Phase displayed is the difference from the normalized value.

**5-9** *IMD*

This test measures inter-modulation distortion.

**Procedure**

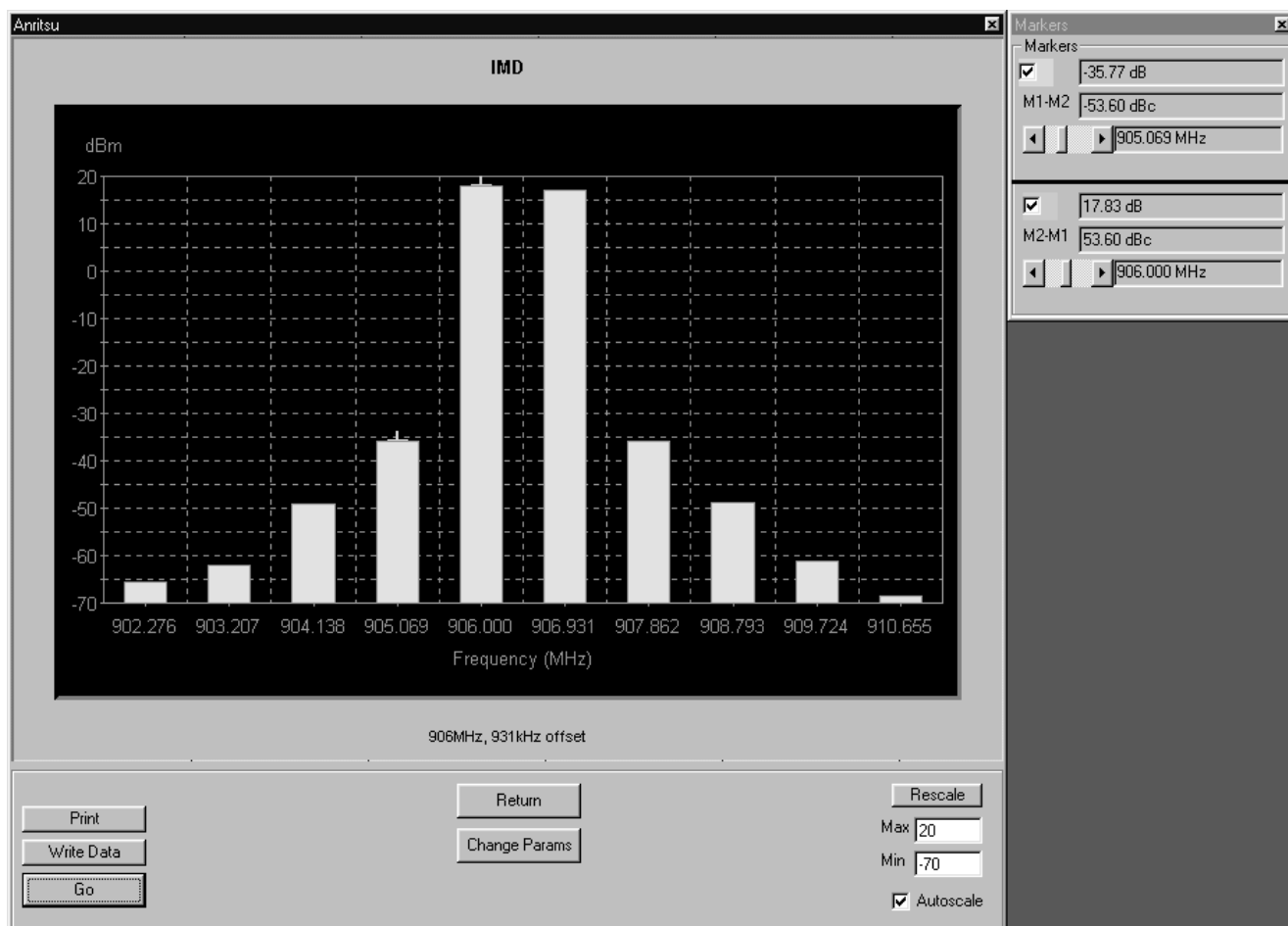
Prepare the ME7840A as shown in Chapter 3.

Enter the appropriate test values in the displayed User Input screen. The input fields are described below:

- **Measurement Type:** Already set to “IM” for IMD – input disabled.
- **Main Tone (MHz):** CW Frequency setting for source 1.
- **Offset (kHz):** Offset frequency for Source 2 (Source 2 will be set to Main Tone + Offset).
- **Input Power (dBm):** Input RF power to AUT.
- **IMD Order:**NEED
- **Test Set Setting:** Byte value for setting test set attenuation and source switch:

Internal Source	Value	External Source	Value
0 dB	8	0 dB	0
10 dB	9	10 dB	1
20 dB	10	20 dB	2
30 dB	11	30 dB	3
40 dB	12	40 dB	4
50 dB	13	50 dB	5
60 dB	14	60 dB	6
70 dB	15	70 dB	7

Select **Start Test**. Observe that the test screen (Figure 5-7) appears.



**Figure 5-7.** Intermodulation Distortion Test Screen

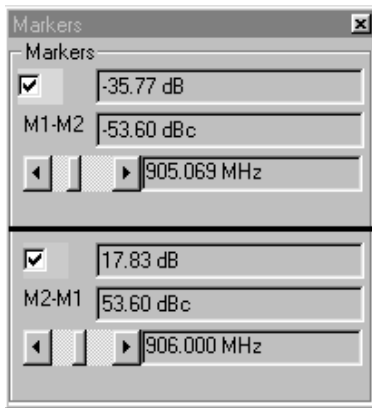
#### Button Panel Options:

- ❑ **Print:** Prints a copy of the screen graphic to a printer.
- ❑ **Write Data:** Excel data is written to C:\Program Files\Pats\Datafiles - the file name will have a time stamp. *For example:* "S17-16-19-29.csv" was created on the 17th day of the month at 4:19 PM and 49 seconds. CSV files are comma separated text and can be opened in Windows Excel.
- ❑ **Pause/Go:** Stops data transfer from VNA to PC and places MS4623C in "Local" mode.



- Return:** Returns to the main PATS screen.
- Change Params: Returns to the User Input screen.**
- Rescale:** Rescales the measurement results.
- Max/Min:** Type in maximum and minimum display value. Use Rescale after changing values.
- Autoscale Checkbox:** Turns autoscale on or off. Autoscale automatically scales the measurement results.

Markers Screen Options (left):



- M1-M2 Checkbox:** Turns M1-M2 feature on or off.
- M1-M2 Readout:** Displays the value of M1 minus M2.
- M1 Slider:** Moves M1 between displayed harmonics. A blue + symbol appears on the top of the selected harmonic.
- M2-M1 Checkbox:** Turns M2-M1 feature on or off.
- M2-M1 Readout:** Displays the value of M2 minus M1.
- M2-M1 Slider:** Moves M2 between displayed harmonics. A blue + symbol appears on the top of the selected harmonic.

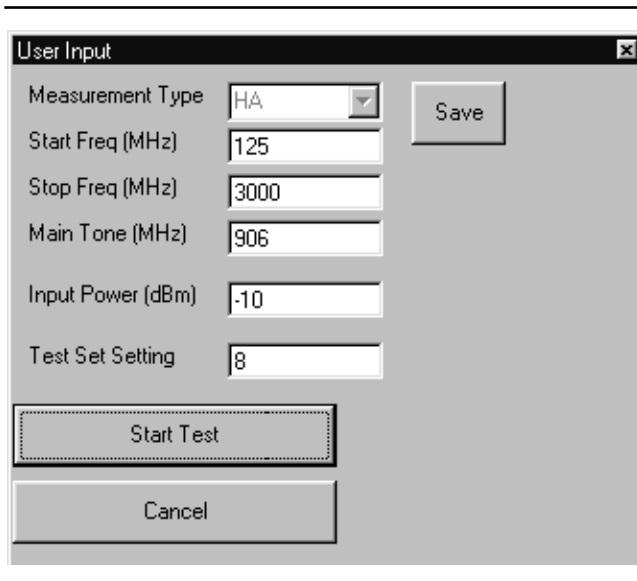
**5-10 HARMONICS**

The harmonics test measures and displays the harmonics in the device under test.

**Procedure**

Prepare the ME7840A as shown in Chapter 3.

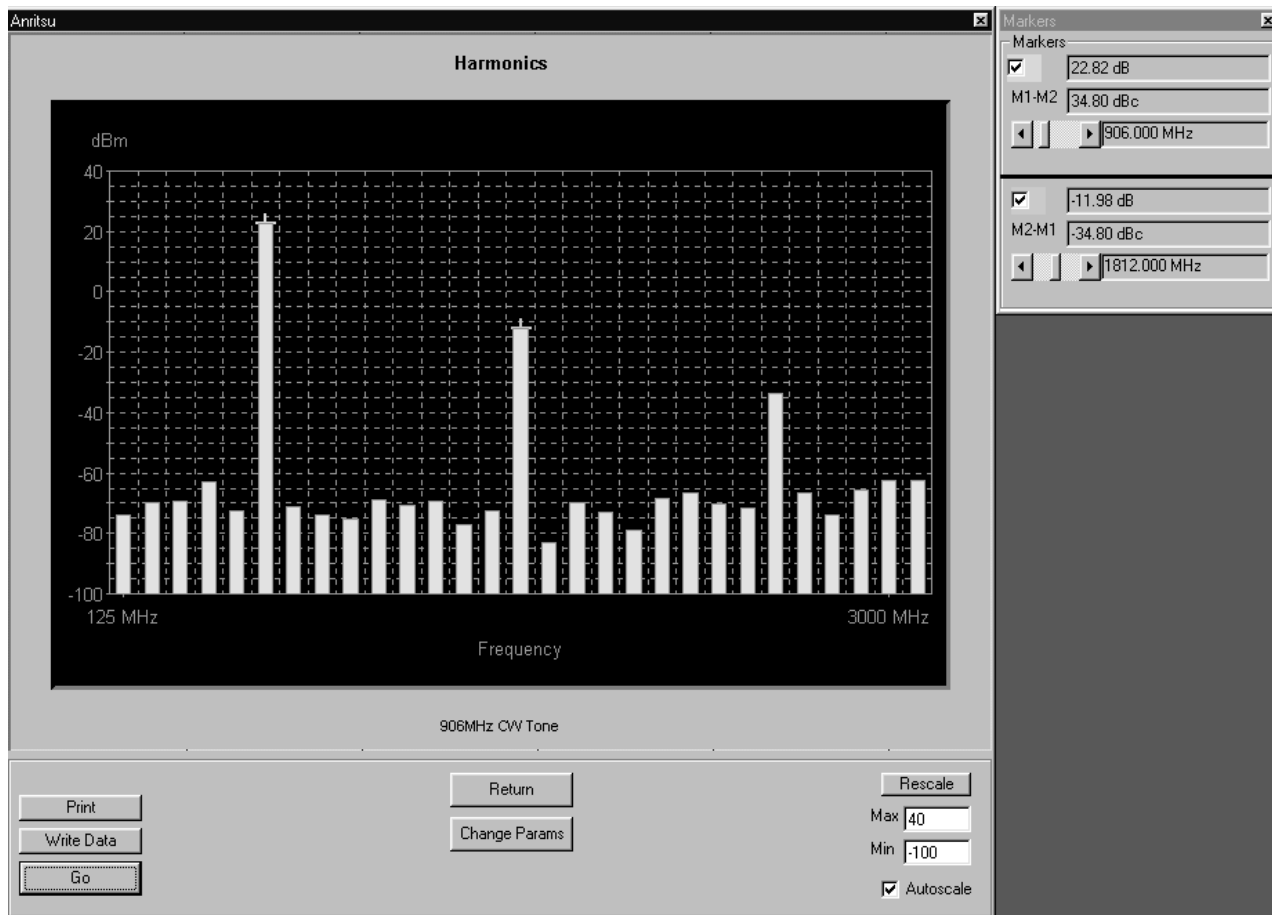
Enter the appropriate test values in the displayed User Input screen. The input fields are described below:



- **Measurement Type:** Already set to “HA” for Harmonics – input disabled.
- **Start Frequency (MHz):** Lower frequency to be displayed. Typically set to a value less than or equal to the main tone.
- **Stop Frequency (MHz):** Upper Frequency to be displayed. Set to a value less than the system’s maximum frequency (for example, for MS4623C set to a max of 5000 MHz).
- **Main Tone (MHz):** CW Frequency setting for source 1.
- **Input Power:** Input RF power to AUT.
- **Test Set Setting:** Byte value for setting test set attenuation and source switch:

Internal Source	Value	External Source	Value
0 dB	8	0 dB	0
10 dB	9	10 dB	1
20 dB	10	20 dB	2
30 dB	11	30 dB	3
40 dB	12	40 dB	4
50 dB	13	50 dB	5
60 dB	14	60 dB	6
70 dB	15	70 dB	7

Select **Start Test** and observe that the test screen (Figure 5-8) appears.



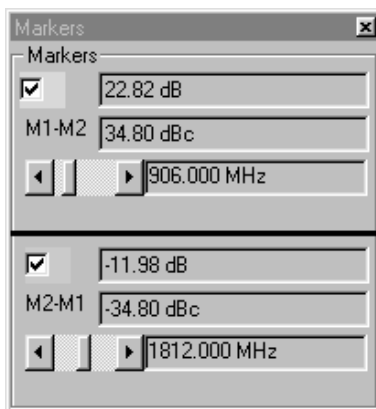
**Figure 5-8.** Initial Harmonics Test Screen

#### Button Panel Options:

- Print:** Prints a copy of the screen graphic to a printer.
- Write Data:** Excel data is written to C:\Program Files\Pats\Datafiles - the file name will have a time stamp. *For example:* "S17-16-19-29.csv" was created on the 17th day of the month at 4:19 PM and 49 seconds. CSV files are comma separated text and can be opened in Windows Excel.
- Pause/Go:** Stops data transfer from VNA to PC and places MS4623C in "Local" mode.
- Return:** Returns to the main PATS screen.

- Change Params:** Returns to User Input screen.
- Autoscale Checkbox:** Turns autoscale on or off. Autoscale automatically scales the measurement results.
- Max/Min:** Type in maximum and minimum display value. Use Rescale after changing values.
- Rescale:** Rescales the measurement results.

Markers Screen Options (left):



- M1-M2 Checkbox:** Turns M1-M2 feature on or off.
- M1-M2 Readout:** Displays the value of M1 minus M2.
- M1 Slider:** Moves M1 between displayed harmonics. A blue + symbol appears on the top of the selected harmonic.
- M2-M1 Checkbox:** Turns M2-M1 feature on or off.
- M2-M1 Readout:** Displays the value of M2 minus M1.
- M2-M1 Slider:** Moves M2 between displayed harmonics. A blue + symbol appears on the top of the selected harmonic.

**5-11** HOT S22

The output match of a power amplifier under excited conditions is critical information that has a strong bearing on efficiency, output power, stability, and often the economic viability of the design. One way of dealing with this information—primarily in power devices operating well away from compression or in somewhat matched amplifiers— is a quasi-linear measurement of  $S_{22}$  while the amplifier is operating under normal drive. Such a measurement is termed hot  $S_{22}$ , and it can provide (1) some information on the degree of mismatch in the system, (2) potential operational stability, and (3) the effects of the amplifier's performance on subsequent stages or an antenna. In the PATS, the Hot  $S_{22}$  measurement uses one source (Source 2) to provide stimulus to the amplifier-under-test (AUT) input port while the other source (Source 1) provides a pilot tone injected to the output of the AUT for measuring  $S_{22}$  at the AUT output port.

**Procedure**

Prepare the ME7840A as shown in Chapter 3.

Enter the appropriate test values in the displayed User Input screen. The input fields are described below:

- **S Parameter:** Already set to “Hot  $S_{22}$ ” for test – input disabled.
- **Data Points:** Drop down options – number of data points in frequency sweep.
- **Frequency 1 (MHz):** Lower frequency to be displayed. Typically set to a value less than or equal to the main tone. Can be reset using slider control.
- **Frequency 2 (MHz):** Upper Frequency to be displayed. Set to a value less than the system's maximum frequency (for example, for MS4623C set to a max of 5000 MHz). Can be reset using slider control.
- **Src 1 Power (dBm):**Source 1 power level, in dBm.
- **IF Bandwidth (Hz):**Intermediate frequency value, in Hertz.

- **Test Set Setting:** Byte value for setting test set attenuation and source switch:

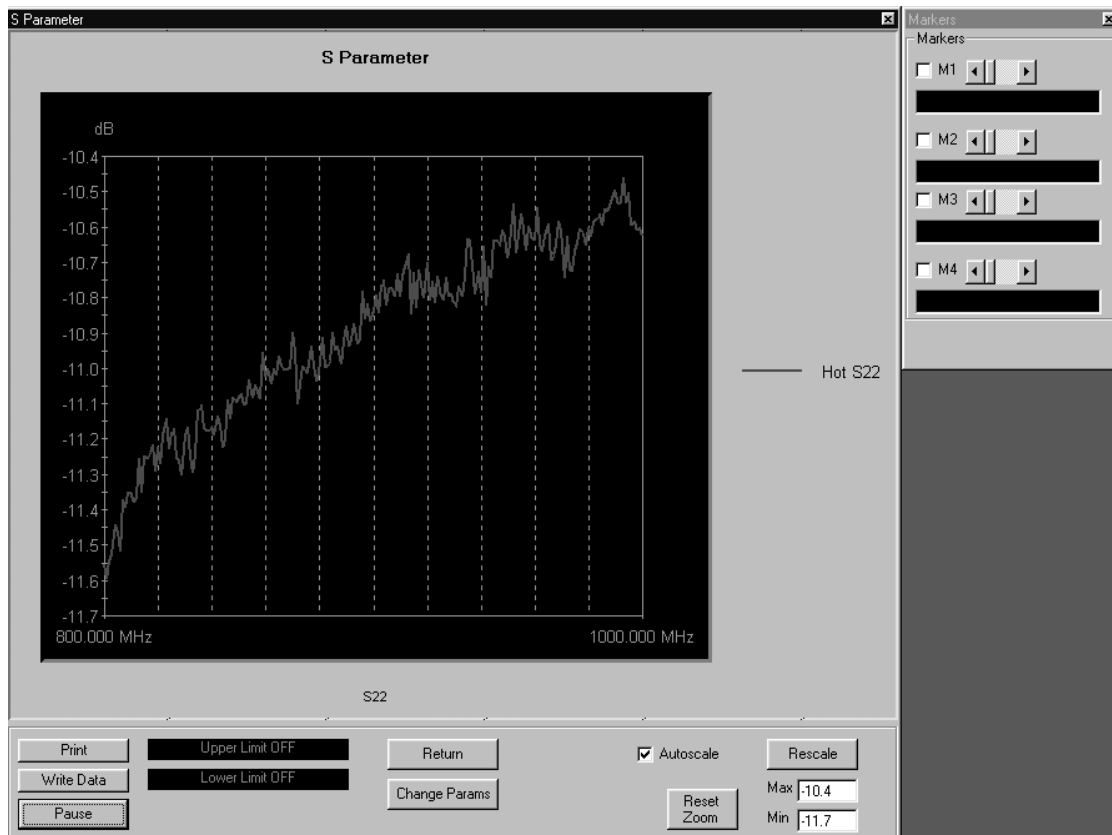
Internal Source	Value	External Source	Value
0 dB	8	0 dB	0
10 dB	9	10 dB	1
20 dB	10	20 dB	2
30 dB	11	30 dB	3
40 dB	12	40 dB	4
50 dB	13	50 dB	5
60 dB	14	60 dB	6

The PATS Hot S<sub>22</sub> measurement provides the following additional features:

- Ability to vary the AUT input excitation power level (Source 2 of Scorpion, at Port 1) while observing the Hot S<sub>22</sub> response. Pressing “U” on the PC keyboard increases the input excitation power level (U for up). Pressing “D” decreases it. The actual input excitation power in dBm is displayed on the PC screen.
- Ability to turn the amplifier input excitation source (Source 2 of Scorpion, at Port 1) ON and OFF while observing the Hot S<sub>22</sub>. Shift S turns Source 2 OFF. S turns it ON. This basically provides a comparison of “Cold” S<sub>22</sub> with Hot S<sub>22</sub>.
- Ability to capture the Hot S<sub>22</sub> plot at a given excitation level (history plot on the PC screen) for comparison with other levels. Press “C” captures (creates history plot). Press “Shift + C” removes it.
- Ability to show Hot S<sub>22</sub> Smith Chart on the Scorpion Screen while Log Magnitude is displayed on the PC screen. The Scorpion display can be selected by Scorpion front panel controls during the measurement.

The level of the tone injected to the output of the AUT (Source 1 of Scorpion, at Port 2) can be set by the user via the “Specification File”.

Select **Start Test** and observe that the test screen (Figure 5-9) appears.



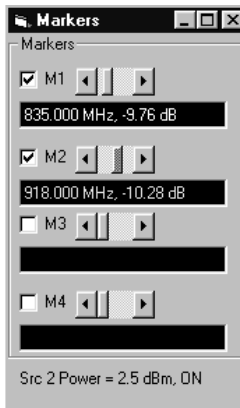
**Figure 5-9.** Hot  $S_{22}$  Test Screen

#### Button Panel Options:

- ❑ **Print:** Prints a copy of the screen graphic to a printer.
- ❑ **Write Data:** Excel data is written to C:\Program Files\Pats\Datafiles - the file name will have a time stamp. *For example:* "S17-16-19-29.csv" was created on the 17th day of the month at 4:19 PM and 49 seconds. CSV files are comma separated text and can be opened in Windows Excel.
- ❑ **Pause/Go:** Stops data transfer from VNA to PC and places MS4623C in "Local" mode.
- ❑ **Upper Limit/Lower Limit:** Limit values as set using Tools menus (Chapter 4).
- ❑ **Return:** Returns to the main PATS screen.

- Change Params:** Returns to User Input screen.
- Autoscale Checkbox:** Turns autoscale on or off. Autoscale automatically scales the measurement results.
- Reset/Zoom:** Disabled for this test.
- Max/Min:** Type in maximum and minimum display value. Use Rescale after changing values.
- Rescale:** Rescales the measurement results.

Markers Screen Options (left):



- M1:** Turns marker on or off (checked or unchecked). If on: Slider moves marker between data points, and window below displays marker frequency and amplitude values amplitude value at the marker.
- M2:** Same as above.
- M3:** Same as above.
- M4:** Same as above.



# Chapter 6

## Performance Verification Procedure

### 6-1 INTRODUCTION

The following are the specific tests that should be used to verify the performance of the Power Amplifier Test System (PATS)

- Source Output Level Accuracy Test
- Return Loss Measurement Confidence Test
- System Dynamic Range Test
- Receiver Magnitude Display Linearity Test

### 6-2 CONVENTIONS

In the tests in this chapter, instructions will direct use front panel hard keys and softkeys. The hard keys and softkeys will appear in a different typeface. For example:

**Step 1.** Press the Utility key and select:

DIAGNOSTICS  
TROUBLESHOOTING  
MORE  
VERIFY ALC CALIBRATION

The Utility key is a front panel hard key and DIAGNOSTICS, TROUBLESHOOTING, MORE, and VERIFY ALS CALIBRATION are all softkeys.

### 6-3 TEST EQUIPMENT

The following equipment is required to perform the verification procedures.

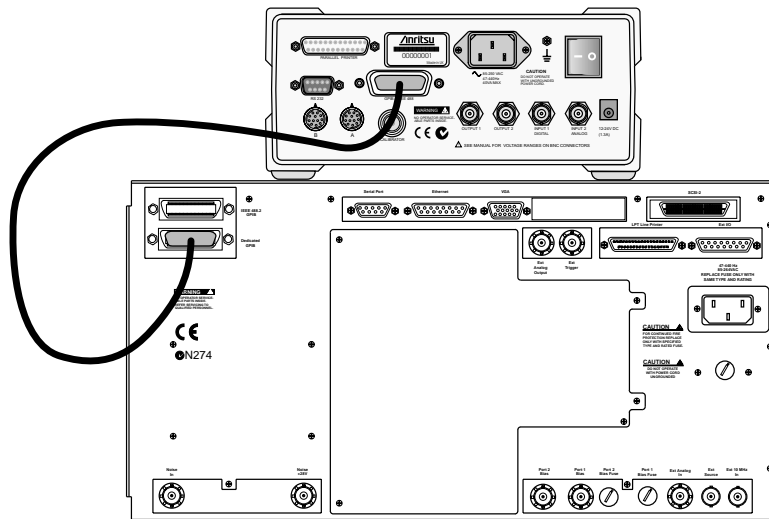
- ANRITSU Model ML243XA Power Meter
- ANRITSU Model MA247XA Power Sensor
- ANRITSU Model 3653 or 3753LF N connector Calibration Kit
- ANRITSU Model SC5237 6 dB Offset Termination
- ANRITSU Model SC5270 20 dB Offset Termination
- ANRITSU Model 11N50B Power Divider
- ANRITSU Model 3670NN50-2 Cable
- ANRITSU Model 34NN50A Adapter
- ANRITSU 2100-2 GPIB cable

**6-4** SOURCE OUTPUT ACCURACY

This test verifies the source output accuracy of the MS462XC. The test procedure uses the Power ALC Verification built-in function of the MS462XC Basic Measurement software.

**Setup:**

- Step 1.** Connect a GPIB cable between the power meter GPIB connector and the MS462XC dedicated GPIB connector, as shown in Figure 6-1.
- Step 2.** Turn on the MS462XC VNMS and allow it to warm-up at least one hour.



**Figure 6-1.** ML2430A Series Power Meter GPIB connection to the MS462XX Vector Network Measurement System

**Test Procedure**

- Step 1.** Disconnect cables between MS462XC Port 1 and Port 1 of MS4782 Test Set and between Port 3 of MS462XC and Port 3 of MS4782 Test Set.
- Step 2.** Press Utility key and select:
- DIAGNOSTICS
  - TROUBLESHOOTING
  - MORE
  - VERIFY ALC CALIBRATON
- Step 3.** Calibrate and zero the power sensor.

**NOTE**

The worst case test result will be displayed on the screen when the instrument fails this test only. The failed test result is also recorded in the Service Log.

**Step 4.** Connect power sensor to MS462XC Port 1 and select START VERIFICATION softkey.

**Step 5.** Verify that Source 1 passes this test.

**Step 6.** Press the SELECT SOURCE soft key to select 2

**Step 7.** Connect power sensor to MS462XC Port 3 and select START VERIFICATION soft key.

**CAUTION**

The TROUBLESHOOTING function must be properly exited to restore normal

**Step 8.** Verify that Source 2 passes this test.

**Step 9.** Select the menu soft key as follows to exit the TROUBLESHOOTING mode:

RETURN

RETURN

FINISHED, RECOVER FROM TROUBLESHOOTINGT

**Step 10.** Reconnect cables between MS462XC Port 1 and Port 1 of MS4782 Test Set and between Port 3 of MS462XC and Port 3 of MS4782 Test Set.

## **6-5** RETURN LOSS CONFIDENCE TEST

This test verifies the accuracy of return loss measurements.

**Setup**

Turn on the MS462XC VNMS and MS4782X Test Set and allow them to warm up for 30 minutes.

**Step 1.** Press Default key then 0 key.

**Step 2.** Press Seq key and .select:

TTL I/O.

PARALLEL OUT SETUP

SET PARALLEL OUT PORT (0-255)

**Step 3.** Change the value from 0 to 8.

**Step 4.** Select:

RETURN

RETURN

**Step 5.** Press Display key and select:

DISPLAY MODE

SINGLE CHANNEL

RETURN

**Step 6.** Press Ch 4 key and then Display key.

**Step 7.** Select:

GRAPH TYPE

LOG MAGNITUDE

**Step 8.** Press Ch 1 key and select LOG MAGNITUDE.

**Test Procedure:**

Insert the Calibration Component Coefficients disk into the MS462XC floppy disk drive.

**Step 1.** Press Cal key and select:

COMPONENT UTILITIES

INSTALL KIT INFO FROM FLOPPY DISK

RETURN

**Step 2.** Follow the prompts and select:

PERFORM CAL: 2 PORT

CAL METHOD: STANDARD

LINE TYPE: COAXIAL

SELECT CALIBRATION TYPE: REFLECTION ONLY –  
PORT 1 ONLY

FREQUENCY RANGE OF CALIBRATION: 800 MHz TO  
2400 MHz

SELECT CALIBRATION DATA POINTS: NORMAL

DATA POINTS: 401 POINTS

PORT 1 CONNECTOR TYPE: N (F)

LOAD TYPE: BROADBAND LOAD

**Step 3.** Select START CAL soft key to begin calibration.

**Step 4.** Install calibration device per instruction on the display. Select the appropriate soft key to measure the calibration device.

**Step 5.** When the “CALIBRATION SEQUENCE COMPLETED” message is displayed, press the Enter key to continue.

- Step 6.** Connect SC5237 6 dB Offset Termination to Test Port 1 of MS4782 Test Set. Record the measured value in Table 6-1 and verify the measured  $S_{11}$  value is  $6 \pm 0.4$  dB. Remove SC5237 Termination.
- Step 7.** Connect SC5270 20 dB Offset Termination to Test Port 1 of MS4782 Test Set. Record the measured value in Table 6-1 and verify the measured  $S_{11}$  value is  $20 \pm 1.0$  dB. Remove SC5270 Termination.
- Step 8.** If system does not have Hot  $S_{22}$  capability, skip steps 8 to 15.
- Step 9.** Press Cal key.
- Step 10.** Follow the prompts and select:
- PERFORM CAL: 2 PORT
  - CAL METHOD: STANDARD
  - LINE TYPE: COAXIAL
  - SELECT CALIBRATION TYPE: REFLECTION ONLY – PORT 2 ONLY
  - FREQUENCY RANGE OF CALIBRATION: 800 MHz TO 1000 MHz
  - SELECT CALIBRATION DATA POINTS: NORMAL
  - DATA POINTS: 401 POINTS
  - PORT 2 CONNECTOR TYPE: N (F)
  - LOAD TYPE: BROADBAND LOAD
- Step 11.** Select START CAL soft key to begin calibration.
- Step 12.** Install calibration device per instruction on the display. Select the appropriate soft key to measure the calibration device.
- Step 13.** When the “CALIBRATION SEQUENCE COMPLETED” message is displayed, press the Enter key to continue.
- Step 14.** Connect SC5237 6 dB Offset Termination to Test Port 2 of MS4782 Test Set. Record the measured value in Table 6-1 and verify the measured  $S_{22}$  value is  $6 \pm 0.4$  dB. Remove SC5237 Termination.
- Step 15.** Connect SC5270 20 dB Offset Termination to Test Port 2 of MS4782 Test Set. Record the measured value in Table 6-1 and verify the measured  $S_{22}$  value is  $20 \pm 1.0$  dB. Remove SC5270 Termination.

**Table 6-1.** Return Loss Specifications

Offset Termination	Measured S <sub>11</sub> Value	Measured S <sub>22</sub> Value*	Specification
SC5237			6 ±0.4 dB
SC5270			20 ±1.0 dB

\* Apply to Test Set with Hot S<sub>22</sub> Capability only.

## **6-6** SYSTEM DYNAMIC RANGE

This test verifies the PATS system dynamic range.

### **Test Procedure:**

**Step 1.** Press Default key then 0 key of MS462XC to reset the system.

**Step 2.** Press Seq key.

**Step 3.** Select:

TTL I/O.  
PARALLEL OUT SETUP  
SET PARALLEL OUT PORT (0-255)

**Step 4.** Change the value from 0 to 8.

**Step 5.** Select:

RETURN  
RETURN

**Step 6.** Press Ch 3 key.

**Step 7.** Press Display key and select:

DISPLAY MODE  
SINGLE CHANNEL  
RETURN  
GRAPH TYPE  
LOG MAGNITUDE  
RETURN

**Step 8.** Press Cal key.

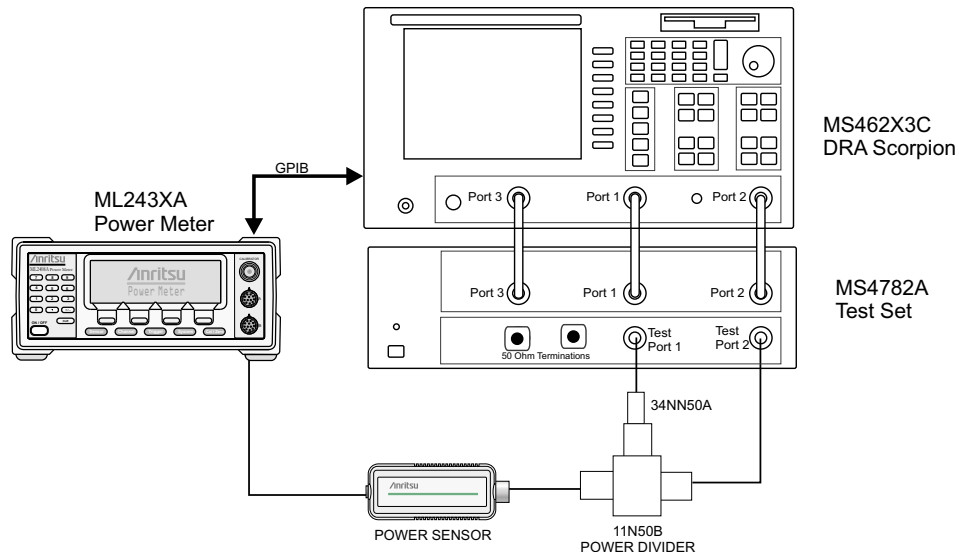
**Step 9.** Follow the prompts and select::

PERFORM CAL: 2 PORT  
CAL METHOD: STANDARD  
LINE TYPE: COAXIAL  
SELECT CALIBRATION TYPE: TRANSMISSION  
FREQUENCY RESPONSE  
PATH: FORWARD PATH ( $S_{21}$ )  
USE OF ISOLATION IN CALIBRATION: INCLUDE  
FREQUENCY RANGE: 800 MHz TO 2400 MHz  
SELECT CALIBRATION DATA POINTS: NORMAL  
DATA POINTS: 401 POINTS  
TEST SIGNAL/PORT 1 POWER: 10 dBm

- Step 10.** After the selections are complete, press the START CAL soft key to begin calibration.
- Step 11.** Install calibration device per instruction on the display. Select the appropriate soft key to measure. Connect a cable between Test Port 1 and Test Port 2 of MS4782X Test Set when the software prompts for a throughline on the display.
- Step 12.** When the “CALIBRATION SEQUENCE COMPLETED” message is displayed, press the Enter key to continue.
- Step 13.** Press Avg key and select:  
SELECT I.F. BANDWIDTH  
I.F. BW 10 Hz
- Step 14.** Remove the through cable between Test Port 1 and Test Port 2 of MS4782X Test Set and connect terminations to both ports.
- Step 15.** Press Display key and then select SCALE.
- Step 16.** Set REFERENCE VALUE to -80.
- Step 17.** Verify that the trace is less than -80 dB.

## 6-7 RECEIVER DISPLAY LINEARITY

This test verifies the magnitude display linearity of the receiver.



**Figure 6-2.** Receiver Magnitude Display Linearity Test Setup

### Setup:

#### NOTE

Zero and calibrate Power Sensor prior to connecting to the power divider.

- Step 1.** Setup the equipment as shown above.
- Step 2.** Allow the system to warm up for at least one hour.
- Step 3.** Press Default key then 0 key.
- Step 4.** Press Seq key and select:
  - TTL I/O.
  - PARALLEL OUT SETUP
  - SET PARALLEL OUT PORT (0-255)
- Step 5.** Change the value from 0 to 8.
- Step 6.** Select:
  - RETURN
  - RETURN
- Step 7.** Press Freq key.
- Step 8.** Change START FREQUENCY to 800 MHz and STOP FREQUENCY to 1 GHz.



**NOTE**  
Ensure that the Power Sensor Cal Factor is set for 1 GHz. Refer to the ML24XXA Operational

- Step 9.** Toggle C.W. MODE OFF soft key to C.W. MODE ON.
- Step 10.** Change C.W. Frequency to 1 GHz.
- Step 11.** Press Config key and select:  
DATA POINTS  
POINTS DRAW IN C.W. – 51 POINT(S)
- Step 12.** Press Avg key and select:  
SELECT I.F. BANDWIDTH  
I. F. BW 10 Hz
- Step 13.** Press Power key and select SOURCE 1 SETUP.
- Step 14.** Adjust SOURCE 1 POWER so that the power meter readout is 0 dBm ± 0.1 dB.
- Step 15.** Press Ch 3 key.
- Step 16.** Press Meas key and select USER DEFINED.
- Step 17.** Change RATIO to b<sub>2</sub>/1.
- Step 18.** Select S21/USER 1 soft key to use user defined parameter.
- Step 19.** Press Display key and select:  
GRAPH TYPE  
LOG MAGNITUDE  
RETURN  
TRACE MEMORY
- Step 20.** Allow the trace to sweep twice. Select:  
STORE DATA TO MEMORY  
VIEW DATE (/) MEMORY
- Step 21.** Press Marker key and select MARKER READOUT.
- Step 22.** Use the soft key to turn on Marker 1. Then use the numeric data entry key to change POINT to 25.
- Step 23.** Press Marker key again.
- Step 24.** Use the soft key to SCREEN DISPLAY ON.

**Step 25.** Press Power key and select SOURCE 1 SETUP.

**Step 26.** Set PORT 1 ATTN to 10 dB. Record the Power Meter Readout and the Marker 1 Readout to the table on next page. Repeat this step for other PORT 1 ATTN setting listed in the table.

**Step 27.** Verify if the difference of the two measured values are within specifications (Table 6-2).

**Table 6-2.** Receiver Magnitude Display Linearity Specifications

PORT 1 ATTN Setting (dB)	Power Meter Reading	MS462XC Marker 1 Reading	Difference Between Two Readings	Specification
10				≤0.1 dB
20				≤0.1 dB
30				≤0.1 dB
40				≤0.2 dB
50				≤0.2 dB
60				≤0.2 dB

# Chapter 7

## Preamplifier Operations

### 7-1 INTRODUCTION

This chapter describes the use of external preamplifiers to boost signal power at the input of an test amplifier.

### 7-2 USE OF EXTERNAL PREAMPLIFIERS

External preamplifiers can be used to boost signal level at the input of the Amplifier Under Test (AUT). The maximum power per tone at the AUT input without any external preamplifier is +5 dBm. Block diagrams showing this feature are contained in Figures 7-1 and 7-2.

As shown in Chapter 1, Figures 1-2 and 1-3, a single preamplifier can be used after the combiner and before the bi-directional input coupler. However the nonlinearity of this preamplifier may adversely affect the linearity measurements of the AUT, unless it is far below the AUT.

If an individual preamplifier for each tone is used at the input to the combiner, then this problem is avoided, but two other issues must be addressed:

- Driving the DRA Scorpion channels  $a_1$  and  $b_1$  into compression
- Possibility of damage to the combiner

The first issue is avoided by using an attenuator at the input of channels  $a_1$  and  $b_1$ . The value of this attenuator should be selected noting that the maximum operating signal level at  $a_1$  and  $b_1$  is  $-5$  dBm, and that the coupling factor between AUT input and channel  $a_1/b_1$  input is  $-30$  dB. Thus, if measurements with an AUT input power of 1 watt (30 dBm) is required, a 5 dB attenuator in each path is needed. In general, attenuators are needed if  $P_{in}$  (max power at AUT input) is greater than 25 dBm and the value of attenuator is given by  $A$  (dB) =  $P_{in}$  (dBm) - 25.

Depending on the power output level of the preamplifier, two alternatives exist for dealing with the second issue.

#### **Alternative 1**

For moderate power levels (say up to 34 dBm at each preamplifier output), the internal combiner can be used with a user-supplied circulator as shown in the Figure 7-1. This will protect the combiner against a disconnected or mismatched AUT (e.g. power off), but care must be exercised to ensure that the source switch in the test set is correctly positioned before power is applied to the preamplifier(s).

#### **Alternative 2**

For greater preamplifier power levels, an external combiner should be used. Figure 7-2 is a suggested block diagram for this configuration.

PATS is designed to enable power calibrations in the presence of external preamplifiers. For the flat power calibration, the user can specify his target power (at the AUT input which is the calibration reference plane) and

an approximate source power (at the Scorpion Port 1, Port 3, or both). For tests involving power sweep, the MS7840A enables a linear power calibration over the desired power range (and the frequency range). For this calibration, the user can specify his target power start and stop values and a nominal power offset between this reference plane and the Scorpion source (the net of preamplifier gain minus test setup losses).

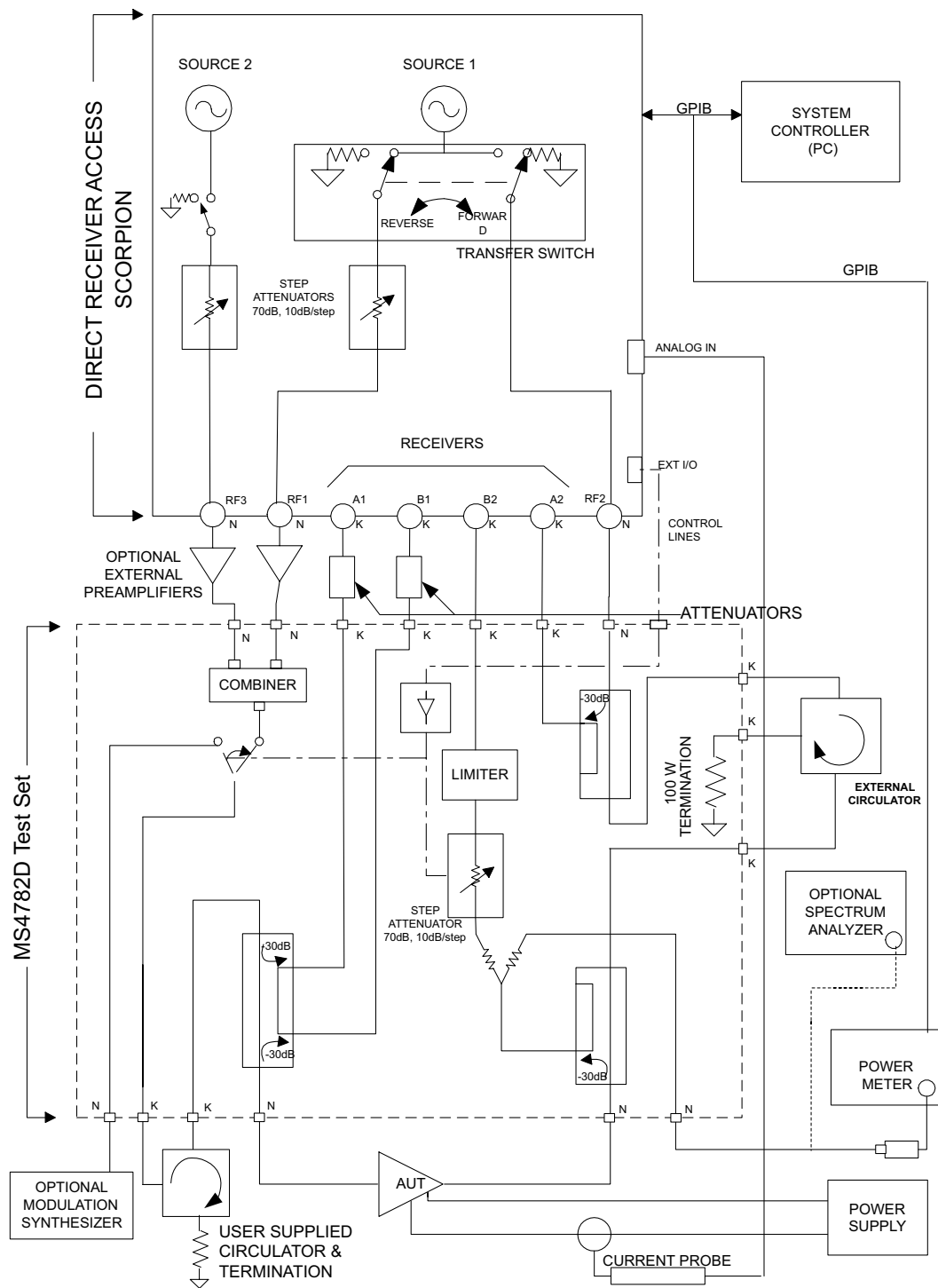


Figure 7-1. MS4782A with External Preamplifiers (Moderate Power)

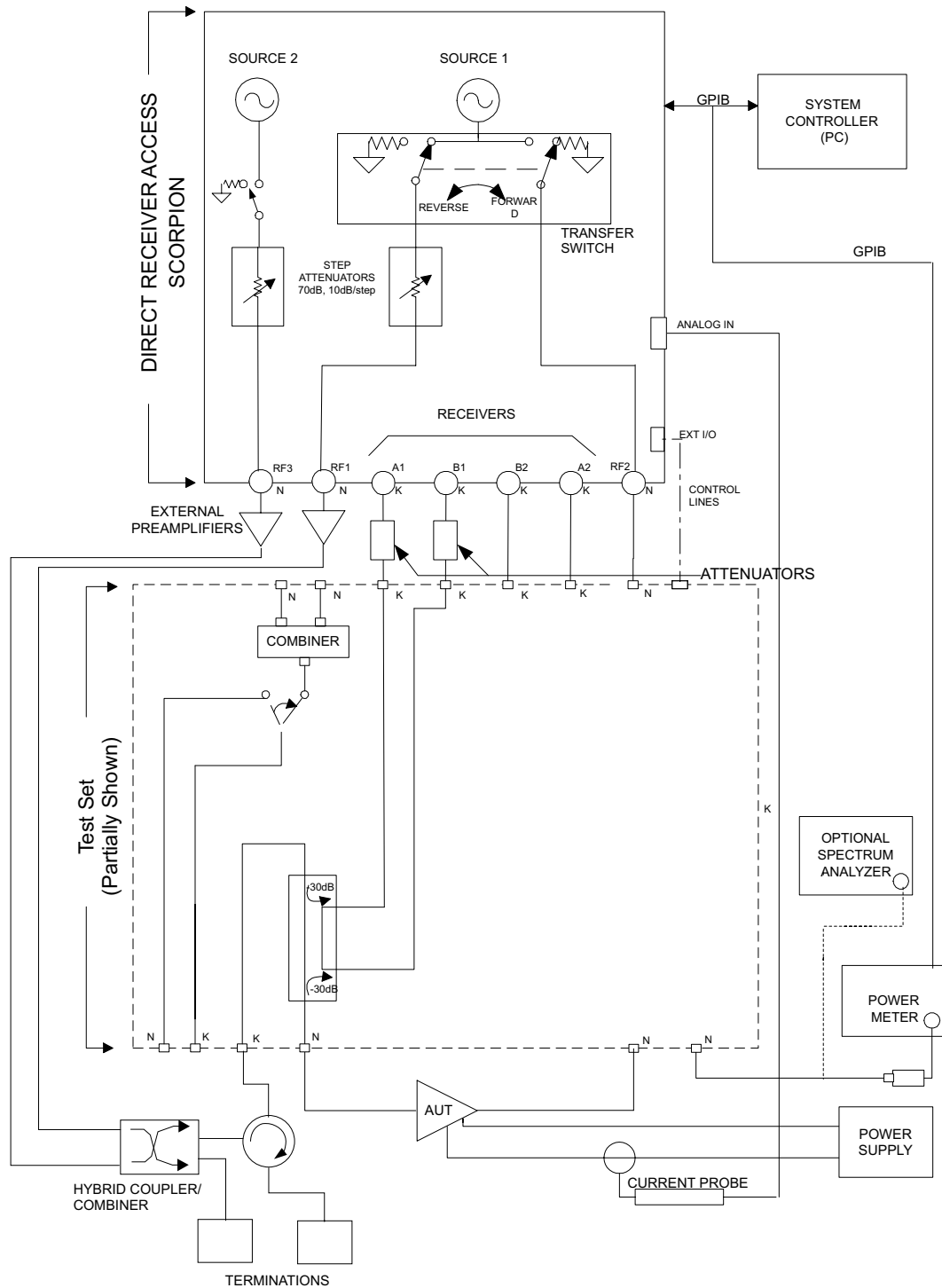


Figure 7-2. MS4782A with External Combiner

# **Appendix A**

## **Calibration Specification Files**

### **A-1 INTRODUCTION**

This appendix describes the Calibration Specification Files that are used to specify calibrations that are performed when accessing “Tools,” “Run Calibration Procedures” in the PATS software. It lists file types, describes how to open the files for edit, provides technical details of the files, and shows typical file listings.

### **A-2 FILE TYPES**

There are four files that specify calibrations for (A) Power Level; (B) Hot  $S_{22}$ ; and (C) S-Parameters; (D) Cal File Setup for Receiver Cal, IMD, Power Sweep, and Harmonics.

### **A-3 OPEN FILES**

To view or edit the specification files, highlight the filename and right click the mouse to display a dialog box. Left click on “Properties” then on “Open” to open the file in *Notepad*.

### **A-4 TECHNICAL DETAILS**

Technical details on how to construct and edit Calibration Specification Files are provided in Table A-1.

**Table A-1.** *Technical Details of Calibration Specification Files (1 of 9).*

---

**I GENERAL**

[ Header  
[ Calibration Specification Section 1  
[ Calibration Specification Section 2  
  
[ Calibration Specification Section N  
[ END

1. General Structure of file:
2. General syntax:

$\underbrace{\hspace{1cm}}_{\text{field}} \quad \underbrace{\hspace{1cm}}_{\text{field}}$   
<Keyword>, <value 1>, <value 2>, •••, <value n>, //comment

- a. Comma separates all fields.
- b. Spaces before or after a keyword or value in each field is acceptable.
- c. Place comma between last value and comment.
- d. Place a "/" before any comment.
- e. MUST have "END" as last line of specification.
- f. Comments are acceptable on any line after "END".
- g. Keywords are not case sensitive; upper or lower is acceptable. (Examples use case for structural clarity).
- h. If a keyword requires no values or comments, it does not need a comma. (Adding a comma, however, will not cause a problem.)
- i. Never place anything on the first line, except:  
    ndut, 1, //comment
- j. Unless using autocal, suggest always starting with:  
    ndut 1, //First line of calibration specification



**Table A-1.** *Technical Details of Calibration Specification Files (2 of 9).*

k. In each calibration specification/section, use the following structure:

```

<BEGIN>
  [ Header for section
  CAL, 1
  [ Details of 1st cal.
  CAL, 2
  [ Details of 2nd cal.
  .
  .
  .
  CAL, <N>
  [ Details of Nth cal.
<END>
    
```

3. Header:

```

one or more calibration sequence types { type, <value 1>, //comment
                                         .
                                         //comment
                                         .
                                         type, <value 1>, //comment
    
```

4. "Type" Keywords, Legal Values:

- a. pow                    Power Level Calibration
  - linear cal
  - flat power cal
  - receiver cal
- b. sp                    S Parameter Calibration
  - 12 term
  - Hot  $S_{22}$
  - Autocal
- c. imd                   Instrument Setup
  - Sets up instrument for IMD measurements. Uses Flat Power Cal and Receiver cal as they exist in the Scorpion's non-volatile memory.
- d. harm                   Instrument Setup
  - Sets up instrument for harmonic measurement. Uses Flat Power Cal and Receiver cal as they exist in the Scorpion's non-volatile memory.
- e. powsweep            Instrument Setup
  - Sets up instrument for IMD-mode power sweep.

**Table A-1.** *Technical Details of Calibration Specification Files (3 of 9).*

---

**II CALIBRATION SPECIFICATIONS, TYPES**

1. pow (Power Level)                      Equipment Required: Power meter connected to Dedicated GPIB port  
Power sensor with appropriate frequency range  
Throughline

POW\_START

[ Header

[ Details

POW\_END

Header Section Keywords

ncal	Number of calibration sequences of this type to run. For type = pow, each sequence consists of: linear cal (for power sweeps) flat power cal receiver cal NOTE: Since this attempts to be a "global" power level calibration, ncal should get a value of 1.
npts	Number of frequency points to use during the calibration sequence. Increasing this number will increase calibration time. Legal values are (3, 15, 51, 101, 201, 401, 801, 1601 <u>only</u> ) NOTE: Illegal value causes software to default to 51.
if	IF bandwidth: Legal values are 10, 30, 100, 300, 1000, 3000, 10000, 30000 NOTE: Illegal value causes software to default to 1000.
avgs	Averages: (Optional). Software will set averaging to value (and turn on) during cal.
pow	Source setting for each source during flat power cal.
target	Target power setting for each source during flat power cal.
noffset	Nominal offset value for use during linear cal. NOTE: During linear cal the software attempts to calibrate the sources from -15 dBm to +5 dBm at the input reference plane.
switch	Setting for test set. Corresponds to 0–15 settings.

**Table A-2.** *Technical Details of Calibration Specification Files (4 of 9).*

---

Detail Section Keywords

CAL, 1	First calibration
name, level	Name of *.cal file to save when calibration sequence completes.
f1	Start frequency in MHz for global calibration NOTE: Set a wide frequency range. Minimum value is 10; ensure f1 is less than 2.
f2	Stop frequency in MHz.
<u>Example</u>	Refer to Figure A-1 (page A-11).

**Table A-1.** *Technical Details of Calibration Specification Files (5 of 9).*

---

2. sp and Hot  $S_{22}$  (S Parameters & Hot  $S_{22}$ )

SP\_START

[ Header

[ Details

SP\_END

Header Section Keywords:

ncal	Number of calibration sequences of this type to run.
npts	Number of frequency points to use during the calibration sequence. Increasing this number will increase calibration time. Legal values are (3, 15, 51, 101, 201, 401, 801, 1601 <u>only</u> ) NOTE: Illegal value causes software to default to 51.
con	Connector syypes for Port 1 and Port 2: Options: MN, FN - Male/Female N type MK, FK - Male/Female K MS, FS - Male/Female SMA
if	IF bandwidth: Legal values are 10, 30, 100, 300, 1000, 3000, 10000, 30000 NOTE: Illegal value causes software to default to 1000.
avgs	Averages: (Optional). Software will set averaging to value (and turn on) during cal.
pow	Source power setting: during cal, Source 1.
switch	Setting for test set. Correponds to 0–15 settings.

Detail Section Keywords:

CAL, 1	First calibration
cal type	Type of calibration to perform: 12 - 12 term RR - Reflection Reverse RF - Reflection Forward 8T - 1 Path 2 Port Forward 8R - 1 Path 2 Port Reverse FT - Transmission Frequency Response
<name>	Name for Hot $S_{22}$
<hot>	For Hot $S_{22}$ only. Value = offset in kHz of 2nd Source

---

**Table A-2.** *Technical Details of Calibration Specification Files (6 of 9).*

---

<pow2>	For Hot $S_{22}$ only. Source 2 power setting.
f1	Start frequency in MHz for global calibration NOTE: Set a wide frequency range. Minimum value is 10; ensure f1 is less than 2.
f2	Stop frequency in MHz.
<u>Example</u>	Refer to Figure A-2 for Hot $S_{22}$ (page A-12) and Figure A-4 (page A-14) for S Parameters .

**Table A-3.** *Technical Details of Calibration Specification Files (7 of 9).*

---

## 3. powsweep (Power Sweep – IMD mode or 2-tone mode):

POWSWEEP\_START

[ Header

[ Details

POWSWEEP\_END

Header Section Keywords:

ncal	Number of calibration sequences of this type to run.
npts	NOTE: npts is IGNORED. Always uses 3, which refers to number of frequency values allowed (must be 3 in current software).
if	IF bandwidth: Legal values are 10, 30, 100, 300, 1000, 3000, 10000, 30000 NOTE: Illegal value causes software to default to 1000.
avgs	Averages: (Optional). Software will set averaging to value (and turn on) during cal.
pow	Start power level for sweep: Set on for Source 1 and Source 2.
switch	Setting for test set. Corresponds to 0–15 settings.

Detail Section Keywords:

CAL, 1	First calibration
name	Name of *.cal file to save when calibration sequence completes.
f1	Start frequency in MHz for global calibration NOTE: Set a wide frequency range. Minimum value is 10; ensure f1 is less than 2.
f2	Stop frequency in MHz.
<u>Example</u>	Refer to Figure A-2 (page A-12).

**Table A-1.** *Technical Details of Calibration Specification Files (8 of 9).*

---

## 4. harm (Harmonics):

HARM\_START

[ Header

[ Details

HARM\_END

Header Section Keywords:

ncal	Number of calibration sequences of this type to run.
if	IF bandwidth: Legal values are 10, 30, 100, 300, 1000, 3000, 10000, 30000
avgs	Averages: (Optional). Software will set averaging to value (and turn on) during cal.
pow	Start power level for sweep: Set on for Source 1.
switch	Setting for test set. Corresponds to 0–15 settings.

Detail Section Keywords:

CAL, 1	First calibration
name	Name of *.cal file to save when calibration sequence completes.
f1	Main tone, MHz
f2	Maximum display range, MHz NOTE: Minimum display range is automatically set to 100 MHz.
<u>Example</u>	Refer to Figure A-2 (page A-12).

**Table A-1.** *Technical Details of Calibration Specification Files (9 of 9).*

---

## 5. imd (Imodulation Distortion):

IMD\_START

[ Header

[ Details

IMD\_END

Header Section Keywords:

ncal	Number of calibration sequences of this type to run.
pow	Start power level for sweep: Set on for Source 1.
if	IF bandwidth: Legal values are 10, 30, 100, 300, 1000, 3000, 10000, 30000
avgs	Averages: (Optional). Software will set averaging to value (and turn on) during cal.
switch	Setting for test set. Corresponds to 0–15 settings.

Detail Section Keywords:

CAL, 1	First calibration
name	Name of *.cal file to save when calibration sequence completes.
f1	Main tone, MHz
f2	Maximum display range, MHz
<u>Example</u>	Refer to Figure A-2 (page A-12).



**A-5** **POWER LEVE.TXT**

The Power Level.txt file is shown in Figure A-1

---

```
ndut,1,           //Number of DUTs
type,pow,        //Power Level Calibration (requires Power Meter)
                //Perform Global Linear, Flat Power and Receiver
                //Calibrations

POW_START ncal,1, //Number of Power Level calibrations
npts,401,        //Number of points (default for all)
if,3000,         //IF default
avgs,0,         //averages default
pow,0,          //power level default
switch,8,       //switch setting
CAL,1, name,Levels, //File name root (append _1 for DUT1, _2 for DUT2, etc
f1,100,         //startf DUT1 DUT2 DUT3
f2,3000,        //stopf DUT1 DUT2 DUT3 POW_END

END
```

---

**Figure A-1.** Power Level Calibration Specification File

**A-6** **CAL FILES  
SETUP.TXT**

The Cal Files Setup.txt file is shown in Figure A-2.

<b>Calibration Specifications</b>	<b>Header</b>	<pre> ndut,1, //Number of DUTs type,powsweep type,harm type,imd         </pre>
	<b>Section 1</b>	<pre> POWSWEEP_START ncal,1, //Number of Power Sweep calibrations npts,3, //Number of points (default for all) if,3000, //IF default avgs,20, //averages default pow,-15, //powerlevel start default switch,8, //switch setting CAL,1, name,PowSweep, //File name root (append _1 for DUT1, _2 for DUT2, etc f1,900, //Main Tone MHz f2,931, //Offset KHz         </pre>
	<b>Section 2</b>	<pre> POWSWEEP_END  HARM_START ncal,1, //Number of Harmonic calibrations if,3000, //IF default avgs,20, //averages default pow,0, //power level start default switch,8, //switch setting CAL,1, name,Harmonics, //File name root (append _1 for DUT1, _2 for DUT2, etc f1,900 //Main Tone MHz f2,3000, //Max Range MHz         </pre>
<b>Section 3</b>	<pre> HARM_END  IMD_START ncal,1, //Number of IMD calibrations npts,4, // pow,-15, //power level setting dBm if,30000, //IF Bandwidth avgs,250, //Averages switch,8, //switch setting CAL,1, name,Imd, //File name root (append _1 for DUT1, _2 for DUT2, etc f1,900, //Main Tone MHz f2,977, //Offset KHz         </pre>	
		<pre> IMD_END         </pre>

**Figure A-2.** Cal Files Setup Calibration Specification File

**A-7** HOT S<sub>22</sub>.TXT

The HotS<sub>22</sub>.txt file is shown in Figure A-3.

```
ndut,1,           //Number of DUTs
type,sp,         //S Parameter calibration

SP_START
ncal,1,          //Number of S-Param calibrations
npts,201,        //Number of points (default for all)
con,FN,FN,       //Connector Type Options MN,FN,MK,FK,MS,FS
if,3000,         //IF default
avgs,0,          //averages default
pow,-5,          //power level default
switch,8,        //switch setting
CAL,1, caltype,RR, //12 = 12 Term, RR = Relection only Reverse, RF =
                  Relection only Forward
name,Hots22,     //File name root (append _1 for DUT1, _2 for DUT2, etc
hot,923,         //hot 0 means turn on 2nd source during cal (Hot S22
                  only),
                  //use value as offset (KHz)
pow2,-5,         //2nd source power in Hot S22
f1,800,          //startf DUT1 DUT2 DUT3
f2,1000,         //stopf DUT1 DUT2 DUT3

SP_END

END
```

**Figure A-3.** Hot S<sub>22</sub> Calibration Specification Program File

**A-8 S-PARAMETERS.TXT** The S-Parameters.txt file is shown in Figure A-4.

---

```
ndut,1,           //Number of DUTs
type,sp,         //S Parameter calibration

SP_START
ncal,1,          //Number of S-Param calibrations
npts,201,        //Number of points (default for all)
con,FN,FN,       //Connector Type Options MN,FN,MK,FK,MS,FS
if,3000,         //IF default
avgs,0,         //averages default
pow,0,          //power level default
switch,8,        //switch setting
CAL,1, caltype,12, //12 = 12 Term, RR = Relection only Reverse, RF =
                  Relection only Forward name,S_Parameters,
                  //File name root (append _1 for DUT1, _2 for DUT2, etc
f1,800,          //startf DUT1 DUT2 DUT3
f2,1200,         //stopf  DUT1 DUT2 DUT3

SP_END

END
```

---

**Figure A-4.** *S-Parameters Calibration Specification File*

# Index

## !

Cal Files Setup Calibration Specification File . A-12

## A

ADAPTIVE P STOP . . . . . 1-9

## C

CAL FILE SETUP . . . . . 4-15 - 19

CAL FILES SETUP.TXT . . . . . A-11 - 12

collateral functions . . . . . 3-4

COLLATERAL FUNCTIONS . . . . . 3-5 - 8

Connectors and Ports . . . . . 1-7

CONVENTIONS. . . . . 1-2,6-1

## D

DRA Scorpion . . . . . 1-5

## E

EQUIPMENT COMPLEMENT . . . . . 2-1

## F

FILE TYPES. . . . . A-1

## G

Gain and IMD Power Sweep . . . . . 5-18

GENERAL . . . . . 4-3,5-1 - 3

## H

HARDWARE DESCRIPTION . . . . . 1-2 - 4

HARMONICS TESTS . . . . . 5-29 - 31

HOT S22 . . . . . 4-8 - 10,5-32 - 35

Hot S22 Calibration Specification Program File A-13

HOT S22.TXT . . . . . A-13

## I

IMD. . . . . 5-26 - 28

IMD, HARMONICS, POWER SWEEP . . . . . 4-10

Installation. . . . . 2-7

INSTALLATION - HARDWARE. . . . . 2-2 - 6

INSTALLATION - SOFTWARE. . . . . 2-7

## K

K FACTOR . . . . . 1-9

## M

MEASUREMENT CALIBRATION . . . . . 5-1

measurement uncertainty. . . . . 4-1,5-1

MS462X3 OPTIONS . . . . . 1-12

MS4782X Test Set . . . . . 1-6

Multiple Frequency Power Sweep . . 5-12,5-14,5-24

## O

ONLINE MANUALS . . . . . 1-2

OPEN FILES . . . . . A-1

OPERATING REQUIREMENTS . . . . . 4-1,5-1

OPTIONAL ACCESSORIES. . . . . 1-12

## P

PATS SYSTEM OVERVIEW . . . . . 1-2

PERFORMANCE SPECIFICATIONS . . . 1-13 - 14

POWER LEVEL . . . . . 4-4 - 7

Power Level Calibration Specification File . . . A-11

POWER LEVEL.TXT . . . . . A-11

POWER SWEEP, ONE TONE . . . . . 5-22 - 25

POWER SWEEP, TWO TONE . . . . . 5-10 - 21

PREPARING THE SYSTEM. . . . . 3-1 - 3

PREVENTIVE MAINTENANCE . . . . . 1-12

## R

RECEIVER DISPLAY LINEARITY . . . . . 6-8 - 10

RECOMMENDED TEST EQUIPMENT . . . . 1-15

RELATED MANUALS . . . . . 1-1

RETURN LOSS CONFIDENCE TEST . . . . 6-3 - 5

**S**

SCOPE OF THIS MANUAL . . . . . 1-1  
SERIAL NUMBER . . . . . 1-2  
SERVICE CENTERS. . . . . 2-8 - 9  
Single Frequency Power Sweep . . . . . 5-10,5-22  
Software Organization. . . . . 3-4  
SOFTWARE STRUCTURE . . . . . 1-11  
SOURCE OUTPUT ACCURACY . . . . . 6-2  
S-PARAMETER TESTS . . . . . 5-4,5-7 - 9  
S-Parameters Calibration Specification File . . . A-14  
S-PARAMETERS.TXT . . . . . A-14  
Starting the PATS Software. . . . . 3-4  
SYSTEM DESCRIPTION . . . . . 1-5 - 8

SYSTEM DYNAMIC RANGE . . . . . 6-6 - 7

**T**

TECHNICAL DETAILS . . . . . A-1 - 10  
TEST EQUIPMENT . . . . . 4-2  
TEST EQUIPMENT . . . . . 6-1  
TEST EXECUTIVE. . . . . 1-9 - 10

**U**

Uninstalling the software . . . . . 2-7  
UNPACKING and INSPECTION. . . . . 2-1  
USE OF EXTERNAL PREAMPLIFIERS. . . . 7-1 - 4  
USER SUPPLIED TEST SET . . . . . 1-13  
USING PATS SOFTWARE . . . . . 3-4

## Free Manuals Download Website

<http://myh66.com>

<http://usermanuals.us>

<http://www.somanuals.com>

<http://www.4manuals.cc>

<http://www.manual-lib.com>

<http://www.404manual.com>

<http://www.luxmanual.com>

<http://aubethermostatmanual.com>

Golf course search by state

<http://golfingnear.com>

Email search by domain

<http://emailbydomain.com>

Auto manuals search

<http://auto.somanuals.com>

TV manuals search

<http://tv.somanuals.com>