



FT920

19" Flat CRT

User's Manual

By Envision Peripherals, Inc.

www.aocmonitor.com

AOC[®]
EYES VALUE

Thank you very much for choosing the AOC Color Monitor. We recommend that you take a few minutes to read carefully through this brief but comprehensive manual before installing and switching on the monitor. Please keep this manual in a safe place for your future reference. Plug & Play Drivers for the AOC Series Monitors are available at: www.aocmonitor.com

CHECKING THE CONTENTS OF THE MONITOR PACKAGE

The product package should include the following items:

1. Monitor
2. Owner's Manual
3. Power Cord
4. Swivel Base

FCC Class B Radio Frequency Interference Statement WARNING: (FOR FCC CERTIFIED MODELS)

NOTE: This equipment has been tested and found to comply with the limits for a Class B digital device, pursuant to Part 15 of the FCC Rules. These limits are designed to provide reasonable protection against harmful interference in a residential installation. This equipment generates, uses and can radiate radio frequency energy, and if not installed and used in accordance with the instructions, may cause harmful interference to radio communications. However, there is no guarantee that interference will not occur in a particular installation. If this equipment does cause harmful interference to radio or television reception, which can be determined by turning the equipment off and on, the user is encouraged to try to correct the interference by one or more of the following measures:

1. Reorient or relocate the receiving antenna.
2. Increase the separation between the equipment and receiver.
3. Connect the equipment into an outlet on a circuit different from that to which the receiver is connected.
4. Consult the dealer or an experienced radio/TV technician for help.

NOTICE :

1. The changes or modifications not expressly approved by the party responsible for compliance could void the user's authority to operate the equipment.
2. Shielded interface cables and AC power cord, if any, must be used in order to comply with the emission limits.
3. The manufacturer is not responsible for any radio or TV interference caused by unauthorized modification to this equipment. It is the responsibilities of the user to correct such interference.

WARNING :

To prevent fire or shock hazard, do not expose the monitor to rain or moisture. Dangerously high voltages are present inside the monitor. Do not open the cabinet. Refer servicing to qualified personnel only.

PRECAUTIONS

- Do not use the monitor near water, e.g. near a bathtub, washbowl, kitchen sink, laundry tub, swimming pool or in a wet basement.
- Do not place the monitor on an unstable cart, stand, or table. If the monitor falls, it can injure a person and cause serious damage to the appliance. Use only a cart or stand recommended by the manufacturer or sold with the monitor. If you mount the monitor on a wall or shelf, use a mounting kit approved by the manufacturer and follow the kit instructions.
- Slots and openings in the back and bottom of the cabinet are provided for ventilation. To ensure reliable operation of the monitor and to protect it from overheating, be sure these openings are not blocked or covered. Do not place the monitor on a bed, sofa, rug, or similar surface. Do not place the monitor near or over a radiator or heat register. Do not place the monitor in a bookcase or cabinet unless proper ventilation is provided.
- The monitor should be operated only from the type of power source indicated on the label. If you are not sure of the type of power supplied to your home, consult your dealer or local power company.
- The monitor is equipped with a three-pronged grounded plug, a plug with a third (grounding) pin. This plug will fit only into a grounded power outlet as a safety feature. If your outlet does not accommodate the three-wire plug, have an electrician install the correct outlet, or use an adapter to ground the appliance safely. Do not defeat the safety purpose of the grounded plug.
- Unplug the unit during a lightning storm or when it will not be used for long periods of time. This will protect the monitor from damage due to power surges.
- Do not overload power strips and extension cords. Overloading can result in fire or electric shock.
- Never push any object into the slot on the monitor cabinet. It could short circuit parts causing a fire or electric shock. Never spill liquids on the monitor.
- Do not attempt to service the monitor yourself; opening or removing covers can expose you to dangerous voltages and other hazards. Please refer all servicing to qualified service personnel.
- To ensure satisfactory operation, use the monitor only with UL listed computers which have appropriate configured receptacles marked between 100 - 240V AC, Min. 2.5A.
- The wall socket shall be installed near the equipment and shall be easily accessible.
- Attention: Disconnect the power cord to stop the power supply to the monitor.

Plug & Play DDC1/2B Feature

This monitor is equipped with VESA DDC1/2B capabilities according to the VESA DDC STANDARD. It allows the monitor to inform the host system of its identity and, depending on the level of DDC used, communicate additional information about its display capabilities. The communication channel is defined in two levels, DDC1 and DDC2B.

The DDC1 is a unidirectional data channel from the display to the host that continuously transmits EDID information. The DDC2B is a bidirectional data channel based on the I²C protocol. The host can request EDID information over the DDC2B channel.

USING THE RIGHT POWER CORD:

The accessory power cord for the Northern American region is the wall plug with NEMA 5-15 style and is UL listed and CSA labeled. The voltage rating for the power cord shall be 125 volts AC.

Supplied with units intended for connection to power outlet of personal computer:
Please use a cord set consisting of a minimum No. 18 AWG, type SJT or SVT three conductors flexible cord. One end terminates with a grounding type attachment plug, rated 10A, 250V, CEE-22 male configuration. The other end terminates with a molded-on type connector body, rated 10A, 250V, having standard CEE-22 female configuration.

TECHNICAL SUPPORT(FAQ)

Power LED is not on
*Power Cord should be connected
No Plug & Play
*Check if the PC System is Plug & Play compatible *Check if the Video Card is Plug & Play compatible *Check if the D-15 plug pin of Video Cable is bent *Make sure the AOC Monitor Drivers are installed (AOC Monitor Drivers are available at: www.aocmonitor.com)
Picture is fuzzy
*Adjust the Contrast and Brightness Controls.
Picture bounces or a wave pattern is present in the picture
*Move electrical devices that may cause electrical interference.
The power LED is ON (orange) but there's no video or no picture.
*Computer Power Switch should be in the ON position. *Computer Video Card should be snugly seated in its slot. *Make sure monitor's video cable is properly connected to the computer. *Inspect monitor's video cable and make sure none of the pins are bent. *Make sure computer is operational by hitting the CAPS LOCK key on the keyboard while observing the CAPS LOCK LED. The LED should either turn ON or OFF after hitting the CAPS LOCK key.
Missing one of the primary colors (RED, GREEN, or BLUE)
*Inspect the monitor's video cable and make sure that none of the pins are bent.

INSTALLATION INSTRUCTIONS

SWIVEL BASE

To attach the swivel base to the monitor, do the following:

- Carefully turn the monitor on its side or upside down.
(see figure 1)
- Locate the cavities at the bottom front of the monitor.
- Insert the pegs on the swivel base into these cavities. Push the swivel base forward until the swivel base locks in place.
- To remove the swivel base, hold the bottom of the swivel base, then push it out.

POWER CORD

Power Source:

1. Make sure the power cord is the correct type that required in your area.
2. This monitor has a universal power supply that allows operation in either 100/120V AC or 220/240V AC voltage area (No user adjustment is required).
3. Connect the power cord into your monitor's power input socket, and then plug the other end into a 3-pin AC power outlet. The power cord may be connected to either a wall power outlet or the power outlet socket on your PC, depending on the type of power cord supplied with your monitor.

VIDEO CABLE

Connecting the Video Cable: the monitor comes with a built-in video cable. Plug the signal cable's 15-pin connector into the computer's video port and tighten the two screws on the cable connector. (see figure 2)

Caution: Don't bend the signal cable, otherwise it will break the inner wire.

Connecting the Power Cord: Plug the power cord into the monitor's AC power socket. Then plug the power cord into a grounded AC outlet or UL-approved power strip or the power output socket on your PC.

Caution: If the AC outlet is not grounded, install the proper grounding adapter (not supplied).

OPERATING INSTRUCTIONS

GENERAL INSTRUCTIONS

The other control knobs are located at the base of the monitor (See Figure 3). By changing these settings, the picture can be adjusted to your personal preferences.

- The power cord should be connected.
- Connect the video cable from the monitor to the video card.
- To turn the monitor on, press the power switch to ON position. The power indicator will light up.
- Your monitor features a unique quick switch system which provides a picture within seconds after the monitor is switched on.

NOTES

- Do not install the monitor in a location near heat sources such as radiators or air ducts , or in a place subject to direct sunlight , or excessive dust or mechanical vibration or shock.
- Save the original shipping carton and packing materials, as they will come in handy if you ever have to ship your monitor.
- For maximum protection, repackage your monitor as it was originally packed at the factory.
- To keep the monitor looking new, periodically clean it with a soft cloth. Stubborn stains may be removed with a cloth lightly dampened with a mild detergent solution. Never use strong solvents such as thinner, benzene, or abrasive cleaners, since these will damage the cabinet. As a safety precaution, always unplug the monitor before cleaning it.

Figure 1: Installing and Removing the Swivel Base

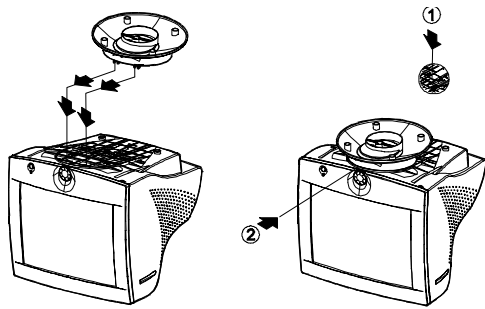
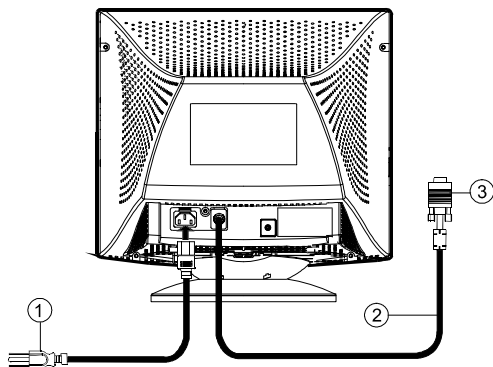
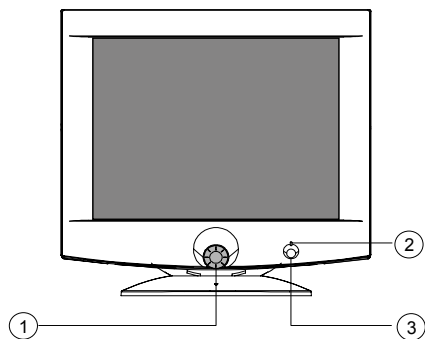

Figure 2: Connecting Cables



1. Power Cord
2. Signal Cable
3. VGA Card Connector

Figure 3: External Controls



1. Shuttle Knob
2. Power Indicator
3. Standby Switch

Figure 4: The OSD Menu

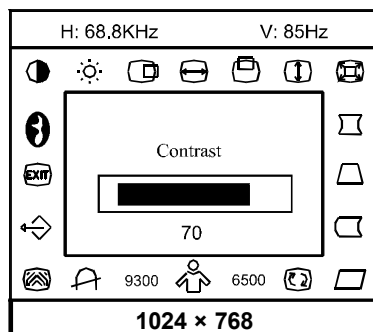



















FRONT PANEL CONTROL (see figure 3)

- **Standby Switch:** When pressed, the monitor enters the off mode, and the LED turns orange. Press again and hold to restore normal status.
- **Power Indicator :**
Green — Power On mode.
Orange — Off mode.
- **Shuttle Knob :** The Shuttle Knob is used to control the monitor functions. Rotate to switch functions or adjust settings. Press to select or execute a function.

HOW TO ADJUST A SETTING

1. Press the Shuttle Knob or OSD Key to make the OSD window appear. See figure 4.
2. Rotate the Shuttle Knob to select the desired function.
See figure 4.
3. Press the Shuttle Knob again to select the function that you want to adjust.
4. Rotate the Shuttle Knob to change the settings of the current function.
5. When the OSD window is active, it shows the input signal timing. The "H" stands for the horizontal frequency and "V" for the vertical frequency.
6. To exit and save, either press the OSD Key, select the exit function, or leave the monitor alone for 10 seconds.
If you want to adjust any other function, repeat steps 2-4.

ADJUSTING THE PICTURE (see figure 4)

1.		CONTRAST	Adjust the picture contrast.
2.		BRIGHTNESS	Adjust the picture brightness.
3.		H- CENTER	Adjust the horizontal position of the picture.
4.		H- SIZE	Adjust the picture's horizontal size.
5.		V- CENTER	Adjust the vertical position of the picture.
6.		V- SIZE	Adjust the picture's vertical size.
7.		ZOOM	Adjust the picture's horizontal and vertical size simultaneously.
8.		PINCUSHION	Adjust the pincushion and barrel.
9.		TRAPEZOID	Adjust the picture's trapezoid distortion.
10.		PIN-BALANCE	Adjust to compensate the pincushion unbalance.
11.		PARALLELO-GRAM	Adjust the picture to be a rectangle.
12.		ROTATION	Adjust the picture tilt to horizontal position.
13.		6500°K/9300°K (COLOR TEMPERATURE)	The color temperature for 6500°K is x=0.313, y=0.329 and 9300°K is x=0.283, y=0.297. It presents two different color sets on the screen.
14.		USER COLOR (Red / Blue)	If the 9300°K normal white or 6500°K warmer white do not satisfy your desire, properly adjust
15.		DEGAUSS	If color impurity occurs when moving or swiveling the monitor, press the Shuttle Knob
16.		MOIRE REDUCE	Moire is the result of interference between the phosphor layout and the video signal. In some
17.		RECALL	Press RECALL to restore the monitor to factory settings.
18.		EXIT	Close OSD window.
19.		SELECT LANGUAGE	Select the language as you like.

SPECIFICATION

CRT	48.3cm(19"), 90° deflection, 29mm neck, 21mm(H), 0.25mm(D) dot pitch	
Viewable Image Size	45.7cm (18"), diagonal	
Video	0.7Vpp, R, G, B Analog	
Separate Sync.	TTL Level	
H/V-sync.:	Positive/Negative	
Scanning Frequency:		
Horizontal	30kHz to 98kHz automatically	
Vertical	50Hz to 160Hz automatically	
Max. Resolution	1600 × 1200	
Video Dot Rate	200MHz	
Factory Preset Timings :	8	
User mode Timings :	20	
Power Source	Universal AC 100-240V, 50Hz/60Hz	
Operating	0°C to 40°C ambient	
Humidity	10% to 85% relative, non- condensing	
Dimension	(Monitor&Base) 446(W) × 436(H) × 455(D)mm	
Weight	20.0 kg(Net)	
Signal Cable	Attached Mini D-sub 15 Male	
Plug & Play	DDC1/2B	
Power Consumption	On mode	≤ 130W
	Off mode	≤ 5W
Preset display area	346mm × 2630mm	
Regulations	UL, CSA, FCC, FDA, MPR II	

Preset Timing Table

STANDARD	RESOLUTION	HORIZONTAL FREQUENCY	VERTICAL FREQUENCY
IBM	720 x 400	31.5kHz	70Hz
VGA	640 x 480	31.5kHz	60Hz
VESA/85	640 x 480	43.3kHz	85Hz
VESA/85	800 x 600	53.7kHz	85Hz
VESA/85	1024 x 768	68.7kHz	85Hz
VESA/85	1280 x 960	85.9kHz	85Hz
VESA/85	1280 x 1024	91.1kHz	85Hz
VESA/75	1600 x 1200	93.8kHz	75Hz

Connector Pin Assignment

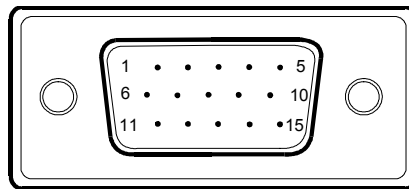

PIN NO.	DESCRIPTION	PIN NO. NO. de Terminal PIN NO.	DESCRIPTION
1.	Video-Red	9.	5V
2.	Video-Green	10.	GND
3.	Video-Blue	11.	BLANK
4.	BLANK	12.	SDA (serial data address)
5.	SENSES	13.	H-sync
6.	GND-R	14.	V-sync
7.	GND-G	15.	DDC clock
8.	GND-B		*For DDC

Free Manuals Download Website

<http://myh66.com>

<http://usermanuals.us>

<http://www.somanuals.com>

<http://www.4manuals.cc>

<http://www.manual-lib.com>

<http://www.404manual.com>

<http://www.luxmanual.com>

<http://aubethermostatmanual.com>

Golf course search by state

<http://golfingnear.com>

Email search by domain

<http://emailbydomain.com>

Auto manuals search

<http://auto.somanuals.com>

TV manuals search

<http://tv.somanuals.com>