

# Operation

## InRow<sup>®</sup> SC

**ACSC100**  
**ACSC101**

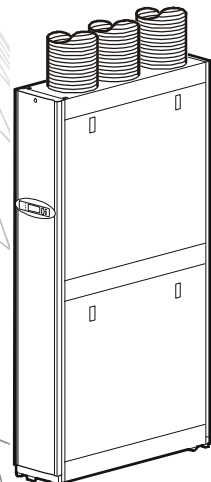



---

This manual is available in English on the enclosed CD.

Dieses Handbuch ist in Deutsch auf der beiliegenden CD-ROM verfügbar.

Deze handleiding staat in het Nederlands op de bijgevoegde cd.

Este manual está disponible en español en el CD-ROM adjunto.

Ce manuel est disponible en français sur le CD-ROM ci-inclus.

Questo manuale è disponibile in italiano nel CD-ROM allegato.

本マニュアルの日本語版は同梱の CD-ROM からご覧になれます。

Instrukcja Obsługi w języku polskim jest dostępna na CD.

O manual em Português está disponível no CD-ROM em anexo.

Данное руководство на русском языке имеется на прилагаемом компакт-диске.

您可以从包含的 CD 上获得本手册的中文版本。

您可以从附属的 CD 上获得本手册的中文版本。

동봉된 CD 안에 한국어 매뉴얼이 있습니다 .

# Contents

---

<b>General Information .....</b>	<b>1</b>
Overview .....	1
Safety .....	2
<b>Commissioning .....</b>	<b>3</b>
<b>Inspection Checklists .....</b>	<b>3</b>
Initial inspection checklist .....	3
Electrical inspection checklist .....	4
Mechanical inspection checklist .....	4
User interface inspection checklist .....	5
Start-up inspection checklist .....	5
Final inspection checklist .....	5
<b>Operation .....</b>	<b>6</b>
Display Interface .....	6
Using the Display Interface .....	7
Scrolling status screens .....	7
Main menu screens .....	7
Navigating the main menu .....	8
Navigating the sub-menus .....	8
Using the Path statement .....	9
Password entry .....	9
Start the cooling unit .....	10
Stop the cooling unit .....	10
General Configuration .....	11
Contacts .....	12
Cooling Group Configuration .....	13
Configure the cooling group .....	13
Identify the cooling unit .....	14
Configure Modbus .....	14

<b>Control the Environment</b> .....	<b>15</b>
Setpoints .....	15
Run hours .....	16
Thresholds .....	16
Service intervals .....	17
<b>Display Settings</b> .....	<b>18</b>
Password & time-out .....	18
Override the password time-out and require password entry immediately. ....	18
Date and time .....	18
Configure display .....	19
Display units .....	19
<b>Network Configuration</b> .....	<b>20</b>
<b>View Status Readings</b> .....	<b>21</b>
Scrolling status screens .....	21
Cooling unit status .....	21
Cooling group status .....	22
About the cooling unit .....	22
<b>Event Log</b> .....	<b>23</b>
<b>Respond to Alarms</b> .....	<b>23</b>
View alarms .....	23
Clear active alarms .....	23
Alarm messages and suggested actions .....	24
<b>Network Management Card</b> .....	<b>27</b>
<b>Quick Configuration</b> .....	<b>27</b>
Overview .....	27
TCP/IP configuration methods .....	27
APC Device IP Configuration Wizard .....	28
.ini file utility .....	28
BOOTP & DHCP configuration .....	28
Local access to the control console .....	30
Remote access to the control console .....	30
Control console .....	31

<b>Access a Configured Network Management Card</b> .....	<b>32</b>
Overview .....	32
Web interface .....	32
Telnet and SSH .....	33
Simple Network Management Protocol (SNMP) .....	34
FTP/SCP .....	34
Modbus .....	34
<b>Recover From a Lost Password</b> .....	<b>35</b>
<b>Maintenance</b> .....	<b>36</b>
Monthly Preventive Maintenance .....	36
Quarterly Preventive Maintenance .....	38
Semi-Annual Preventive Maintenance .....	39
<b>Troubleshooting</b> .....	<b>40</b>
<b>Warranty</b> .....	<b>42</b>

## American Power Conversion Legal Disclaimer

The information presented in this manual is not warranted by the American Power Conversion Corporation to be authoritative, error free, or complete. This publication is not meant to be a substitute for a detailed operational and site specific development plan. Therefore, American Power Conversion Corporation assumes no liability for damages, violations of codes, improper installation, system failures, or any other problems that could arise based on the use of this Publication.

The information contained in this Publication is provided as is and has been prepared solely for the purpose of evaluating data center design and construction. This Publication has been compiled in good faith by American Power Conversion Corporation. However, no representation is made or warranty given, either express or implied, as to the completeness or accuracy of the information this Publication contains.

**IN NO EVENT SHALL AMERICAN POWER CONVERSION CORPORATION BE LIABLE FOR ANY DIRECT, INDIRECT, CONSEQUENTIAL, PUNITIVE, SPECIAL, OR INCIDENTAL DAMAGES (INCLUDING, WITHOUT LIMITATION, DAMAGES FOR LOSS OF BUSINESS, CONTRACT, REVENUE, DATA, INFORMATION, OR BUSINESS INTERRUPTION) RESULTING FROM, ARISING OUT, OR IN CONNECTION WITH THE USE OF, OR INABILITY TO USE THIS PUBLICATION OR THE CONTENT, EVEN IF AMERICAN POWER CONVERSION CORPORATION HAS BEEN EXPRESSLY ADVISED OF THE POSSIBILITY OF SUCH DAMAGES. AMERICAN POWER CONVERSION CORPORATION RESERVES THE RIGHT TO MAKE CHANGES OR UPDATES WITH RESPECT TO OR IN THE CONTENT OF THE PUBLICATION OR THE FORMAT THEREOF AT ANY TIME WITHOUT NOTICE.**

Copyright, intellectual, and all other proprietary rights in the content (including but not limited to software, audio, video, text, and photographs) rests with American Power Conversion Corporation or its licensors. All rights in the content not expressly granted herein are reserved. No rights of any kind are licensed or assigned or shall otherwise pass to persons accessing this information.

# General Information

---

## Overview

Note the definitions for the icons here and be observant for them throughout this manual. They are intended to call attention to potential hazards and important information.

### Symbols used in this manual



**Electrical Hazard:** Indicates an electrical hazard which, if not avoided, could result in injury or death.



**Danger:** Indicates a hazard which, if not avoided, could result in severe personal injury or death.



**Warning:** Indicates a hazard which, if not avoided, could result in personal injury or damage to product or other property.



**Heavy:** Indicates a heavy load that should not be lifted without assistance.



**Caution:** Indicates a potential hazard which, if not avoided, could result in damage to the equipment or other property.



**Tip Hazard:** This equipment is easily tipped. Use extreme caution when unpacking or moving.



**Note:** Indicates important information.

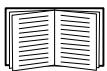

Indicates that more information is available on the same subject.

### Cross-reference symbol used in this manual

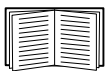

See another section of this document or another document for more information on this subject.

# Safety

Read and adhere to the following important safety considerations when working with this cooling unit.



**Note:** All work must be performed by American Power Conversion (APC<sup>®</sup>) authorized personnel only.



**Caution:** Keep your hands, clothing, and jewelry away from moving parts. Check the equipment for foreign objects before closing the doors and starting the equipment.



**Heavy:** The equipment is heavy. For safety purposes, at least two people must be present when moving this equipment.



**Tip Hazard:** This equipment has a high center-of-gravity. Use extreme caution when moving.



**Electrical Hazard:** Do not wear jewelry when working near energized components.



**Warning:** Before performing any service, properly de-energize and remove access to the equipment (Lockout). Physically label the equipment as intentionally out of service (Tagout).



# Commissioning

---



**Warning:** APC authorized personnel must perform the following procedures.



**Electrical Hazard:** Perform Lockout/Tagout procedures on the cooling unit before servicing the cooling unit. Failure to remove power before servicing this equipment could result in serious injury or death.

After installation is complete, verify that all components are working properly and that the cooling unit is ready to begin operation.

## Inspection Checklists

### Initial inspection checklist

The initial inspection ensures that the cooling unit has been properly installed, the location of the cooling unit has been properly prepared, and the cooling unit is free of damage.



**Warning:** The cooling unit operates under pressure. Take proper safety precautions when connecting gauges or servicing piping.

**Warning:** Do not operate the cooling unit with any cover, guard, door, or panel removed unless the instructions indicate otherwise. Then, proceed with extreme caution.

**Warning:** Do not run service utilities in front of the fan outlets.



**Caution:** The vapor barrier minimizes moisture infiltration. Without a vapor barrier, it will be difficult to maintain the humidity in the room.

**Caution:** Do not introduce unconditioned outside air into the space.



**Note:** A minimum of 900 mm (36 in) of clear floor space in front of and behind the cooling unit is required for service access. To roll the cooling unit out of the row, there must be a minimum of 1200 mm (48 in) of clear floor space in front of or behind the cooling unit. Out-of-row service requires 760 mm (30 in) of side clearance in addition to the front and rear clearance.

### Ensure that:

- 
- The installation procedure is complete according to the installation manual.

---

  - The walls, floor, and ceiling of the room where the cooling unit is located are sealed with a vapor barrier.

---

  - There is no evidence of damage to the cooling unit.

---

  - The cooling unit is level and joined to the adjacent racks or secured to the floor.

---

  - The clearance around the cooling unit is in accordance with local and national codes and regulations as well as the installation manual.

---

## Electrical inspection checklist

The electrical inspection verifies that all electrical connections are secure and correct and that the cooling unit is properly grounded.



**Electrical Hazard:** All electrical wiring must comply with local and national codes and regulations.

**Electrical Hazard:** The equipment must be grounded (do not use a water-pipe ground).

### Ensure that the:

- 
- Incoming voltages match the phase and voltage listed on the nameplate.

---

  - Electrical wiring complies with local and national codes and regulations.

---

  - Cooling unit is properly grounded.

---

  - Electrical connections are tight, including contactors, terminal blocks, controllers, switches, relays, auxiliary devices, and field connections.
- 

## Mechanical inspection checklist

The mechanical inspection verifies that all mechanical components and connections are secure and tight and ready for start-up and system charging. The inspection ensures that field piping is properly installed to promote oil return to the compressor.



**Caution:** Improperly installed piping may result in improper operation and possible damage to the cooling unit or surrounding equipment.

### Ensure that the:

- 
- Fans are turning freely and that the blades are not distorted or bent.

---

  - Condensate drain line is at least the size of the drain connection.

---

  - Mechanical connections are tight, including compressor and receiver connections.

---

  - Ceiling tile adapter is secured to the building structure with properly-sized safety wire.

---

  - Covers and guards are in place.
-

## User interface inspection checklist

The user interface inspection verifies that the sensors and internal communications links of the cooling unit are installed properly.

### Ensure that:

- 
- An A-Link bus is connected to each cooling unit in the group and a terminator is plugged into all unused A-Link connectors.

---

  - The input contacts and output relays are connected correctly.

---

  - The building management system (if used) is connected correctly.

---

  - The temperature sensor is properly routed and mounted on the front (entering air side) of the enclosure immediately to the left or right of the equipment (if InRow or RACS operating mode will be selected).

---

  - The network port is connected correctly and an IP address has been assigned to the equipment.

---

## Start-up inspection checklist

The start-up inspection ensures that the cooling unit is operating properly after the initial start-up. This inspection verifies that all modes of operation are working correctly and that the cooling unit is ready for normal operation.

### While the cooling unit is operating, ensure that the:

- 
- Cooling unit is free from malfunctions, unusual vibrations, or other irregularities in each mode of operation.

---

  - Cool cycles engage.

---

  - Cooling configuration matches the application of the cooling unit.

---

  - Air filters are clean and free of debris. Replace air filters with APC part number 875-2013.

---

  - Clogged filter alarm is operating properly:  
Cover 1/3 of the filter area and monitor alarm performance.

---

  - Compressor suction and discharge pressures are recorded.

---

## Final inspection checklist

The final inspection verifies that the system is clean and the start-up form has been sent to APC.

### Ensure that:

- 
- The interior and exterior of the cooling unit is clean and free from debris.

---

  - Packaging materials have been disposed of properly.

---

  - The Start-up form was completed and sent to APC.

---

# Operation

## Display Interface

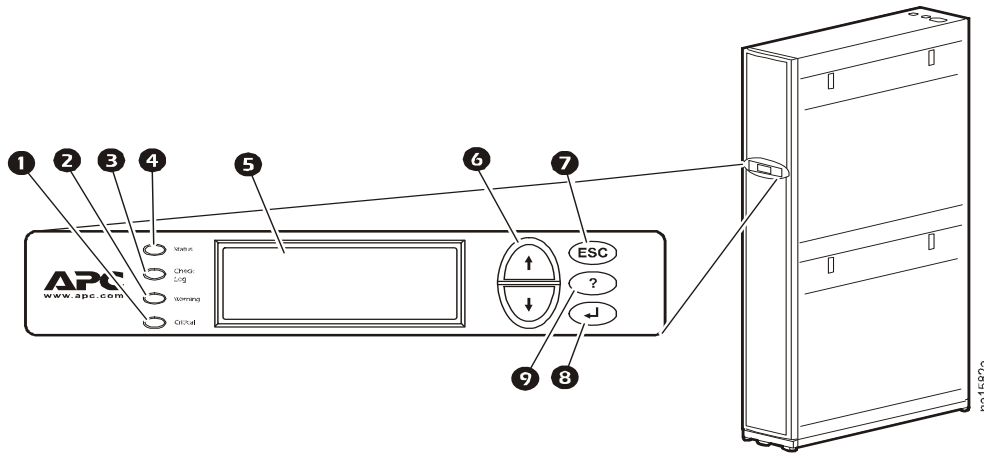

Item	Function
❶ Critical Alarm LED (red)	When illuminated, a critical alarm condition exists that requires your immediate attention.
❷ Warning Alarm LED (yellow)	When illuminated, a warning alarm condition exists. Failure to correct this condition could cause a critical alarm.
❸ Check Log LED (yellow)	When illuminated, at least one new event has been logged since the last time the log was checked. Only events that pertain to the operation of the cooling unit will activate this LED.
❹ Status LED (green)	When illuminated, the cooling unit is receiving electrical power. When the LED is flashing, the cooling unit is downloading firmware for the controller. This may take a few minutes.
❺ Liquid Crystal Display (LCD)	View alarms, status data, context-sensitive help, and modify configurable items.
❻ Up and down arrow keys	Select menu items and access information.
❼ ESC key	Return to previous screen or cancel current operation.
❽ Enter key	Open menu items and input changes to the cooling unit settings.
❾ Help key	Display context-sensitive help. Press the help key for information about each option on the screen and for instructions on performing the tasks.

# Using the Display Interface

Every time you apply power to the cooling unit, the display interface initializes, causing the LEDs to cycle and the alarm tone to activate.

## Scrolling status screens

After start-up, the interface displays the firmware revision number of the display interface. The display interface then scrolls automatically and continuously through screens of status information.

Status Screen Name	Status Information Displayed
APC InRow SC Status	<ul style="list-style-type: none"> <li>• On/Standby</li> <li>• Cooling unit name</li> <li>• Cooling unit location</li> </ul>
Group	<ul style="list-style-type: none"> <li>• Alarms/No Alarms</li> <li>• Cool Output kW</li> <li>• Cool Setpoint °C (or °F)</li> <li>• Max Rack (Maximum Rack Temperature) °C (or °F)</li> </ul>
Unit	<ul style="list-style-type: none"> <li>• Alarms/No Alarms</li> <li>• Cool Output kW</li> <li>• Air Flow CFM (cubic feet per minute) or L/s (liters per second)</li> <li>• Rack Inlet °C (or °F)</li> </ul>

Press the up or down arrow key to interrupt the automatic scrolling and view a specific status screen. Screens automatically begin to scroll after five seconds of inactivity. Press the ENTER or ESC key to return to the main menu screen.

## Main menu screens

On any top-level status screen, press the ENTER or ESC key to open the main menu screen.



**Note:** If the display interface is inactive for the time configured for the password time-out, it returns to the scrolling status screens.

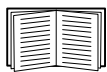

For information on setting the password time-out, see page 18.



**Note:** Pressing the up arrow key from the top line of the top screen of the main menu will take you to the top line of the bottom screen.

On/Standby	↑
View Alarms	
Clear Alarms	
View Event Log	↓
Clear Event Log	↑
Configure Modbus	
→ Set Date & Time	
Set Password	↓
Set Display Units	↑
Configure Display	
Configure Network	↓
About InRow SC	↑
Set Identification	
Service Intervals	↓
View Run Hours	
Configure Unit	↑
Configure Group	
Set Group Setpoints	↓
Set Unit Threshlds	
View Group Status	↑
View Unit Status	↓

na1636f

## Navigating the main menu

**Selector arrows.** Press the up or down arrow key to move the selector arrow ❶ to a menu option or setting. Press the ENTER key to view the selected screen or modify the setting.

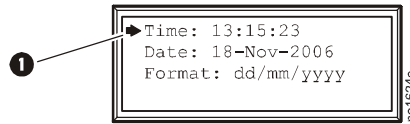

**Continue arrows.** Continue arrows ❷ indicate that additional options or settings are available on a menu or status screen. Press the up or down arrow key to view the additional items.

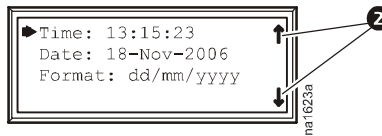

## Navigating the sub-menus

Selecting a main menu option displays the sub-menu screen for that option. Use the up or down arrow key to move the selector arrow to the setting that you wish to change, and press the ENTER key.

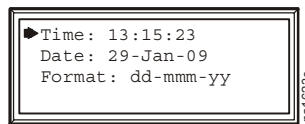

- **List of choices.** If the setting is a list of choices, an input arrow is displayed next to the setting. Press the up or down arrow key to select the choice you want, and then press the ENTER key to exit the input mode and save the setting. Press the ESC key to exit without saving.
- **Numbers or text fields.** If the setting is a number or text field, use the arrow keys to select the value of the first character, and press the ENTER key to move to the next. Press the ENTER key after the last character is set to exit the input mode and save the setting. Press the ESC key to exit without saving. If an invalid value is entered, the display beeps and restores the previous valid value to the field.
- **Input arrows ❸** next to a selected setting indicate that the setting can be modified by pressing the up or down arrow key. Press the ENTER key to save the change or the ESC key to cancel the change.

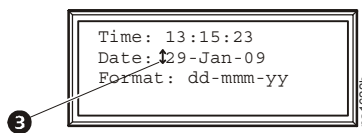

## Using the Path statement

Select the main- and sub-menu options specified in the path statement to view or configure a setting. The path statement lists the main- and sub-menu items you select to navigate to the item to view or modify. The parts of the path statement are defined below:

**Path: Main > Set Password >Change Passwords**

**Main >** Your starting point is the main menu.

**Set Password >** Scroll to and select this option from the main menu.

**Change Passwords >** Scroll to and select this option from the sub-menu.

Subsequent options are listed and defined under the path statement.

## Password entry

**Path: Main Menu > Set Password > Change Passwords**

The cooling unit has two levels of password protection:

- **Device password** for users who need to change basic and environmental settings.
- **Admin password** for users who need to modify settings that control the components in the cooling unit or change advanced options.

When you try to change any of the settings, the local display prompts you to enter your Admin password. The default value for both the Device and Admin passwords is **apc** (lower case). To enter your password, use the up or down arrow keys to scroll through the available character set. Press the ENTER key to select the current letter and move the cursor to the next letter position. After selecting the last letter of your password, press the ENTER key once more to submit your password. If the Device and Admin passwords have been configured to be unique, the Admin password can be entered for the Device password, and Admin privileges will be granted.

Once the password is entered, it remains in effect until the period of inactivity exceeds the **Password Time-out** setting.

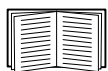

See “Password & time-out” on page 18.



**Note:** Passwords are case-sensitive.

## Start the cooling unit

**Path: Main Menu > On/Standby**

**Limiting access by requiring a password:** Selecting **On/Standby** will display the **Operate: On/Standby** screen. The second line on the screen is **Limit Access: Yes/No**. Select **Yes** to require a password in order to stop or start the unit. When the cursor is on **Operate: On/Standby** and the ENTER key is pressed, the screen will display **Enter Password**. The password must then be entered in order to continue. If **Limit Access: No** is selected, a password is not required.

To start the cooling unit, change the setting to **On** by pressing the ENTER key to toggle from **Standby** to **On**. At that point, the fans will start or **Unit startup in progress** will appear if the **Start-Up Delay** option is set to restart multiple cooling units sequentially.

The cooling unit will run according to the configured settings.

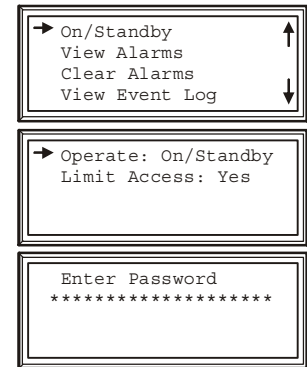

**Note:** **On/Standby** only affects the local cooling unit. You must set the **On/Standby** option for each cooling unit in the cooling group.

**Note:** To toggle between **On** and **Standby** from the scrolling status screens, press the ENTER key three times in rapid succession. This operation can only be done if **Limit Access: Yes/No** is set to **No**.

## Stop the cooling unit

**Path: Main Menu > On/Standby**



**Note:** The **Limit Access: Yes/No** information provided above is also applicable for shutting down the unit.

Press the ENTER key to change the setting to **Standby**. The cooling unit will enter the standby mode



**Electrical Hazard:** The Standby option does not remove power from the cooling unit. You must disconnect power at the mains to remove power from the cooling unit.



# General Configuration

The cooling group configuration options are set during the commissioning of the cooling units in the cooling group.



**Caution:** This procedure must be performed by APC authorized personnel only. Changing the settings incorrectly can cause malfunctions to your cooling unit.

## Cooling unit configuration

**Path:** Main > Configure Unit > General

Use the **General** menu to set the following:

**Start-up Delay.** The delay begins when the cooling unit is started and initialized. The cooling unit cannot begin operation until this delay expires. Use the start-up delay to restart equipment sequentially in your room after a scheduled downtime.

**Idle On Leak.** When set to **Yes**, the cooling unit will enter idle mode if a Water Detection Fault activates. Set to **No** to disable the cooling unit from entering idle mode if a leak is detected.



**Note:** The leak sensor (APC part number AP9325) is optional.

**Note:** There are three alarms that will cause the cooling unit to enter idle mode:

- Water Detection Fault (when **Idle On Leak** is set to **Yes**)
- Condensate Pump Fault
- Cooling Failure

# Contacts

## View the state of input and output contacts

**Path:** Main > Configure Unit > Discrete I/O

Each cooling unit supports a user-defined input contact and a user-defined output contact. Each contact monitors a sensor and responds to changes in the state of the sensor (open or closed).

**Input State.** Indicates the actual state of the input contact (**Open** or **Closed**). A cooling unit is **On** when the state is normal and in **Standby** when the state is not normal.

**Output State.** Indicates the actual state of the output contact (**Open** or **Closed**). An alarm will cause the output contact to change from the normal state.

## Edit the normal state of input and output contacts

**Path:** Main > Configure Unit > Discrete I/O > Normal State

Configure the input contacts to cause alarm conditions based on the user-defined normal state. Output contacts can map internal alarms and events to outside devices.

**Input Norm.** Set the normal state of the contact (**Open** or **Closed**). The cooling unit changes its operating mode to **Closed** when the actual state differs from the normal state.

**Output Norm.** Set the normal state of the contact (**Open** or **Closed**). If the state of an alarm or event mapped to this contact changes from the normal state, the contact also changes state.

**Outpt Src.** Define the type of output source (alarm), either **Any Alarm** or **Critical**, that causes the output to change from its normal state.

# Cooling Group Configuration

Use the cooling group configuration settings to add cooling units to the group and to define group operation.



**Caution:** APC recommends that this procedure be performed by APC authorized personnel only. The settings in the **Configure Group** menu are defined by APC authorized personnel when the cooling group is commissioned.

## Configure the cooling group

**Path:** Main > Configure Group

The **Configure Group** menu contains settings that identify the number of cooling units installed in this cooling group and the physical arrangement of those cooling units.

**Num Units.** Enter the number of cooling units in this cooling group. Up to 12 cooling units can be joined together to work as a single cooling group.

**Type.** Set the rack deployment strategy for the cooling units of this cooling group:

- **Spot:** The cooling unit is used as a stand-alone unit.
- **In-Row:** Air flow is not ducted. Hot-aisle air is cooled and the cooled-air supply is shared by all loads in the row.
- **RACS (Rack Air Containment System):** Air flow in the enclosure is controlled by a ducting system fitted to the enclosure.

**Capacity Ctrl.** Set the capacity control of the cooling unit:

- **Disc (Discrete):** The cooling unit operates as a room air conditioner. The evaporator fan speed will remain constant at the user setting and the compressor will cycle on and off to maintain the cool setpoint.



**Note:** The **Disc** mode is only available in a **Spot** cooling configuration.

- **Prop (Proportional):** The cooling unit matches the cooling output to the load demand. This is accomplished using hot gas adjustment and fan speed control. Load demand is determined by the cool setpoint and the temperature sensor at the rear of the cooling unit (in **Spot** configurations) or the temperature sensor at the front of the load rack (in **In-Row** and **RACS** configurations).

**Fan Cntrl.** This selection allows air flow to be controlled automatically by the cooling unit or manually by user-selected fan speed preference. This property only applies to **Spot** (Proportional), **In-Row**, and **RACS** deployments.

- **Auto:** Air flow is automatically controlled by the unit.
- **Manual:** the air flow is fixed to the value of the **Fan Speed Preference** property. See page 19 for more information.

**Altitude.** The height of the cooling unit above sea level. This number is used to estimate the density of the air and is a factor in calculating the output power. Enter the altitude to the nearest meter or foot for best results. Entries to the nearest 305 meters (1,000 feet) should be sufficient.

## Identify the cooling unit

### Path: Main >Set Identification

The **Set Identification** menu contains settings that identify the name and location of the cooling unit.

**Name.** Assign a **Name** of up to 40 alpha-numeric characters to this cooling unit.

**Location.** Enter the **Location**, up to 40 alpha-numeric characters, of the cooling unit.



**Note:** Only the first 19 characters (of the 40 that are possible to enter) will display on the display interface. You must use Telnet, the Control console or the Web to access all 40 characters. See page 33 for more information.

## Configure Modbus

### Path: Main > Configure Modbus

Use the **Configure Modbus** menu to set up communication between the cooling unit and the building management system.

**Modbus.** **Enable** or **Disable** the Modbus communication protocol.

**Target Id.** Each Modbus device must have a unique target identification number. Enter a unique number, from 1 to 247, for this cooling unit.

**Baud Rate.** Choose either 9600 bps or 19200 bps.

**Fixed settings:** 8 data bits, no parity, 1 stop bit. These settings cannot be modified.

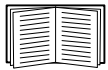

To access the Modbus register map, go to the APC Web site, **www.apc.com**. To access the Modbus register map, go to the APC Web site, **www.apc.com**.

# Control the Environment

The main function of the cooling unit is to remove waste heat and return treated air to the room at the required temperature. The control strategies employed by the cooling unit depend upon the deployment strategy of the cooling group.

In an **In-row** environment, the cooling unit supplies constant-temperature supply air to the common cold aisle. The fan speed is modulated to ensure that the required volume of air reaches the IT equipment. The fan speed is determined by the difference between the cooling setpoint and the maximum rack air inlet temperature of the cooling group.

In a **RACS** environment, the front and rear of the IT equipment racks are fully enclosed. Waste heat is funneled directly to the return air of the cooling unit so the heat cannot escape into the room. Cool air is delivered directly from the cooling unit to the IT equipment racks.

In a **Spot** cooling environment, the cooling unit operates like traditional computer room air conditioning (CRAC) equipment, providing a constant return air temperature. In **Disc** (Discrete) mode, the fans operate at a user-selectable speed (**Fan Control**) and the compressor operates at maximum capacity. In **Prop** (Proportional) mode, the fans are modulated to maintain the required return air temperature and the compressor output is modulated to maintain the necessary supply air temperature.

## Setpoints

### Path: Main > Set Group Setpoint

A setpoint is the target value that a cooling group will maintain. The default setpoints are appropriate for most cooling applications.

Default setpoints:

- **Cool:** 22.2°C (72.0°F)
- **Deadband:** 1.0°C (1.8°F)
- **Supply Air:**
  - 15.0°C (57 – 59.0°F) **Spot** (Proportional) only
  - 17.8°C (64.0°F) **RACS** or **In-Row**



**Note:** The **Supply Air** setting is defined by APC authorized personnel only when the cooling group is commissioned.

**Note:** The **Supply Air** setpoint must never be set higher than the **Cool** setpoint.

- **Fan Spd:** When the unit is programmed for **RACS** mode, this property specifies the necessary temperature difference (DT) across the IT equipment. When the cooling unit is programmed for **Spot** (Proportional), **In-Row**, or **RACS** with the **Fan Control** property set to **Manual**, this property defines the fan speed. When the cooling unit is programmed for **Spot** (Discrete), the fan speeds are also selected from the following table but the **Fan Control** property is irrelevant.
  - **Low:** 16.7°C (30°F) DT (60% of maximum fan speed)
  - **Med-Low:** 13.9°C (25°F) DT (70% of maximum fan speed)
  - **Med:** 11.1°C (20°F) DT (80% of maximum fan speed)
  - **Med-High:** 6.3°C (15°F) DT (90% of maximum fan speed)
  - **High:** 5.6°C (10°F) DT (100% of maximum fan speed)

## Run hours

### Path: Main > View Run Hours

The cooling unit records the number of hours each of its components has operated. When a component is replaced, use the **Reset** option to reset the run hours for the displayed component to zero.

### Path: Main > View Run Hours > Air Filter

- Air Filter
- Reset Run Hours

### Path: Main > View Run Hours > Fans > Condenser

- Fan n (n = 1, 2, or 3)
- Reset Run Hours

### Path: Main > View Run Hours > Fans > Evaporator

- Fan n (n = 1, 2, or 3)
- Reset Run Hours

### Path: Main > View Run Hours > Compressor

- Compressor
- Reset Run Hours

### Path: Main > View Run Hours > Condensate Pump

- Conds Pump (Condensate Pump)
- Reset Run Hours

### Path: Main > View Run Hours > Fan Power Supplies

- LT Fan PS (Left Fan Power Supply)
- RT Fan PS (Right Fan Power Supply)
- Reset LT PS Hours (Reset Left Fan Power Supply Hours)
- Reset RT PS Hours (Reset Right Fan Power Supply Hours)

## Thresholds

Set alarms to alert you when components require service or there are high temperature violations.

### Path: Main > Set Unit Thresholds

When the air temperature exceeds the temperature defined by the **High Temperature Threshold**, an alarm will occur. Set **High Temperature Thresholds** for the following:

- **Rack Inlet:** An alarm condition exists when the temperature of the air entering the rack at the rack inlet sensor exceeds the threshold.
- **Supply Air:** An alarm condition exists when the temperature of the air output from the cooling unit exceeds the threshold.
- **Return Air:** An alarm condition exists when the temperature of the air entering the cooling unit at the temperature sensor exceeds the threshold.

## Service intervals

### Path: Main > Service Intervals

The air filters should be serviced regularly. The service interval depends on environmental cleanliness.

- **Air Filter Interval:** Set the number of weeks before service is required for the **Air Filter Interval**. The default is 18 weeks.
- **Alarm:** The interval setting has an alarm (**Enable** or **Disable**). If enabled, an audible alarm activates when the interval has elapsed. The alarm is cleared by selecting **Clear Alarms** in the main menu.



**Note:** The **Air Filter** interval alarm is enabled by default.

# Display Settings

Set display settings, including the time and date, units, passwords, and time-out settings. You can also adjust contrast, key click, beeper volume, and beep on alarm.

## Password & time-out

**Path: Main > Set Password**



**Note:** The default user password is **apc** (lowercase).

**Change passwords.** Set the Admin and Device passwords.

1. Move the selector arrow next to the **Change Passwords** option and press the ENTER key.
2. Select the password to change (either **Admin** or **Device**).
3. Enter a new password (up to 8 characters).
4. Press the ENTER key to confirm.

**Time-out.** Set the length of time which can elapse when no keys are pressed before the display interface returns to the scrolling screen status. The password must then be entered to regain access.

**Invalidate Now.** Override the password time-out and require password entry immediately.

## Date and time

**Path: Main > Set Date & Time**

**Set the time.** Enter the correct time, and press the ENTER key. The **Time** is displayed on some status screens and is also used in the alarm/event log to time-stamp events.

**Set the date.** Enter the day, month, and year, and press the ENTER key. The **Date** is displayed on some status screens and is also used in the alarm/event log to date-stamp events.

**Set the format.** Use the up or down arrow keys to select the date **Format**.

- mm/dd/yyyy (02/10/2009) (Default)
- yyyy-mm-dd (2009-02-10)
- dd-mmm-yy (10-Feb-09)
- mmm-dd-yy (Feb-10-009)
- dd.mm.yyyy (10.02.2009)



## Configure display

### Path: Main > Configure Display

**Contrast.** Adjust the visibility of the screen text. Lower numbered settings provide darker text; higher numbers provide lighter text. Settings range from 0–7.

**Key Click.** Set to **ON** or **OFF** will enable or disable an audible tone that sounds every time a key is pressed on the display interface.

**Beeper Volume.** Set the volume (**Low, Medium, High** or **OFF**) of the audible tone that sounds every time a key is pressed on the display interface.

**Beep on Alarm.** Set to **ON** or **OFF**. When set to **ON**, the cooling unit will sound an audible tone every 30 seconds when a new alarm occurs. Silence the audible tone by pressing any key on the display interface. When the alarm clears itself, the tone will stop on its own.

## Display units

### Path: Main > Set Display Units

Set the units of measure for the cooling unit to either **US** or **Metric**.

# Network Configuration

The cooling unit is shipped with a Network Management Card that enables the cooling unit to be managed over a network. Configure the network settings for the Network Management Card for this cooling unit from the display interface. The management card allows remote control and configuration of the equipment.

## Configure network

**Path:** Main > Configure Network

**MAC Address.** Displays the unique network identifier assigned to each equipment at the factory.

**Boot Mode.** Set the method by which the cooling unit's Network Management Card will acquire its network settings.

- **Manual:** With **Manual** boot mode selected, enter the IP Address, Subnet Mask, and Default Gateway using the IP Address menu shown below.
- **BOOTP:** Set the Network Management Card to obtain its network settings from a BOOTP server.
- **DHCP:** Set the Network Management Card to obtain its network settings from a DHCP server.

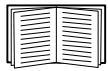

By default, **DHCP** requires an APC cookie before it will accept an IP address. See “DHCP” on page 29 for more information.

- **BOOTPDHCP:** Set the Network Management Card to search for its network settings from either a BOOTP or a DHCP server.

**IP Address.** You will be prompted to enter the Admin password. Enter the password and press ENTER to return to the **IP** screen. Press ENTER again to change the network settings for **Manual** boot mode only:

- **IP:** Enter the IP address assigned to the Network Management Card of this cooling unit.
- **SM:** Enter the subnet mask for the Network Management Card of this cooling unit.
- **GW:** Enter the default gateway for the Network Management Card of this cooling unit.

# View Status Readings

The display interface has several options for viewing the status of the cooling unit, the cooling group to which the cooling unit belongs, and the environment being controlled. The status readings for the cooling unit are available under the **View Unit Status** option in the main menu, and status readings for the cooling group are available under the **View Group Status** option on the main menu or on the scrolling status screens.

## Scrolling status screens

When the display interface is idle, it scrolls through screens of status information. Press the up or down arrow key to interrupt the automatic scrolling and view a specific status screen.

## Cooling unit status

**Path: Main > View Unit Status**

**Op Mode.** The cooling unit is in one of the following modes:

- **On:** The cooling unit is cooling.
- **Standby:** The cooling unit is receiving power but is not enabled for cooling.
- **Idle:** The cooling unit is on, but the compressor is not running because it has active alarms.

**Cool Output.** The actual cooling output of the cooling unit.

**Cool Demand.** The amount of cooling that the heat load currently requires.

**Rack Inlet.** The temperature of the air entering the rack at the remote temperature sensor.

**Supply Air.** The temperature of the air leaving the cooling unit.

**Return Air.** The temperature of the air entering the cooling unit.

**Cond Outlet.** The temperature of the air leaving the condenser.

**Cond Inlet.** The temperature of the air entering the condenser.

**Suction Temp.** The temperature of the low pressure refrigerant line.

**Air Flow.** The amount of air flowing through the evaporator required to maintain the setpoint temperature.

**Evap Fan Spd.** The speed of the fans that regulate the air flow through the evaporator.

**Cond Fan Spd.** The speed of the fans that regulate air flow through the condenser.

**Input State.** The actual state of the input contact (open or closed).

**Output State.** The actual state of the output contact (open or closed).

**Filter DP.** The filter differential pressure.

**Suction.** The pressure at the compressor inlet.

**Discharge.** The pressure at the compressor outlet.

**Superheat.** The difference between the **Suction Temp** and the evaporator dew point temperature

**Compressor.** The state of the compressor, either on or off.

## Cooling group status

### Path: Main > View Group Status

View information about the cooling group.

**Cool Output.** The combined output of the cooling group.

**Cool Demand.** The cooling output required to meet the current heat load of the conditioned space.

**Cool Setpt.** The temperature you set to maintain the room environment.

**Air Flow.** The combined airflow output of the cooling units in the cooling group.

**Max Rack.** The highest rack temperature reported by any cooling unit in the cooling group.

**Min Rack.** The lowest rack temperature reported by any cooling unit in the cooling group.

**Max Return.** The highest return temperature reported by any cooling unit in the cooling group.

**Min Return.** The lowest return temperature reported by any cooling unit in the cooling group.

## About the cooling unit

### Paths: Main > About InRow SC

View identifying information that is helpful when obtaining service:

- **Model**
- **S/N Number** (Serial Number)
- **F/W** (Firmware Version)
- **H/W** (Hardware Version)
- **Made** (Date of Manufacture)
- **SC App** (Application Version)
- **AOS Ver** (APC NMC Operating System Version)

# Event Log

The event log saves status information and a message each time a change in the cooling unit is detected. Alarms events are recorded in the log and displayed on the active alarm screens. Status (informational) events and system configuration changes are only displayed in the event log. The number of messages in the event log is limited to 500. When the number of messages in the event log reaches 500, the oldest message will be dropped from the list every time a new message is added to the log.

## View event log

**Path: Main > View Event Log**

The event log keeps a record of all alarms and events. The screen displays the following:

- The name of the event
- The time and date the event occurred

Use the arrow keys to scroll through the list of events and display the date and time for each event.

## Clear event log

**Path: Main > Clear Event Log**

A confirmation screen is displayed when you select this option. Enter the Admin password to erase the log. Select **YES** to erase all of the events in the log. Select **NO** to return to the main screen.

# Respond to Alarms

When an alarm is triggered, the cooling unit alerts you through the display by the following methods:

- Alarm screen entry on scrolling status screens
- LEDs on the front panel display
- An optional audible alarm every 30 seconds (if enabled)

## View alarms

**Path: Main > View Alarms**

The **View Alarms** screen provides the number of alarms, the severity, and a brief description of the alarm. Press the arrow keys to view the rest of the list.

## Clear active alarms

**Path: Main > Clear Alarms**

A confirmation screen is displayed when you select this option. Enter the Admin password to clear the alarm list. Select **YES** to clear all of the alarms in the list. Select **NO** to return to the main screen. If the conditions that caused the alarm still exist, those conditions cause the alarm to be regenerated.



**Note:** A Critical fault prevents the system from performing its primary function. A primary function is defined as any function that can effect the ability to deliver rated cooling performance. A Warning fault is a fault that is not critical.

## Alarm messages and suggested actions

Displayed Alarm Message	Severity	Action Required
Air Filter Clogged	Warning	<ul style="list-style-type: none"> <li>• Clean or replace the air filter.</li> <li>• If the problem persists, refer to the back page of this manual for contact information.</li> </ul>
Air Filter Run Hours Violation	Warning	<ul style="list-style-type: none"> <li>• Reset the Air Filter Run Hours after the air filter is cleaned or replaced.</li> </ul>
A-Link Isolation Relay Fault	Critical	<ul style="list-style-type: none"> <li>• A hardware failure exists. For assistance, refer to the back page of this manual for contact information.</li> </ul>
Condensate Pan Full Fault	Critical	<ul style="list-style-type: none"> <li>• Make sure the floats are operating correctly.</li> <li>• Clear debris from the condensate pan and drain lines.</li> <li>• If the problem persists, refer to the back page of this manual for contact information.</li> </ul>
Condensate Pump Fault	Warning	<ul style="list-style-type: none"> <li>• Clear debris from the condensate pump reservoir and the condensate removal lines.</li> <li>• Make sure the condensate removal lines are free of obstructions and the float switch moves freely.</li> <li>• For assistance, refer to the back page of this manual for contact information.</li> </ul>
Condenser Fan #n Fault	Warning	<ul style="list-style-type: none"> <li>• Make sure all air intakes are clear of any blockage.</li> <li>• <b>Note:</b> Fans are numbered sequentially, starting with Fan 1 at the front of the cooling unit.</li> <li>• If the problem persists, refer to the back page of this manual for contact information.</li> </ul>
Condenser Inlet Air Sensor Fault	Warning	<ul style="list-style-type: none"> <li>• A hardware failure exists. For assistance, refer to the back page of this manual for contact information.</li> </ul>
Condenser Outlet Air Sensor Fault	Warning	<ul style="list-style-type: none"> <li>• A hardware failure exists. For assistance, refer to the back page of this manual for contact information.</li> </ul>
Cooling Failure	Critical	<ul style="list-style-type: none"> <li>• A hardware failure exists. For assistance, refer to the back page of this manual for contact information.</li> </ul>
Discharge Pressure Sensor Fault	Warning	<ul style="list-style-type: none"> <li>• A hardware failure exists. For assistance, refer to the back page of this manual for contact information.</li> </ul>
Evaporator Fan #n Fault	Warning	<ul style="list-style-type: none"> <li>• Make sure all air intakes are clear of any blockage.</li> <li>• <b>Note:</b> Fans are numbered sequentially, starting with Fan 1 at the bottom.</li> <li>• If the problem persists, refer to the back page of this manual for contact information.</li> </ul>
External Communication Fault	Critical	<ul style="list-style-type: none"> <li>• A hardware failure exists. For assistance, refer to the back page of this manual for contact information.</li> </ul>
Fan Power Supply Left Fault	Warning	<ul style="list-style-type: none"> <li>• Replace the power supply.</li> <li>• For assistance, refer to the back page of this manual for contact information.</li> </ul>
Fan Power Supply Right Fault	Warning	<ul style="list-style-type: none"> <li>• Replace the power supply.</li> <li>• For assistance, refer to the back page of this manual for contact information.</li> </ul>

<b>Displayed Alarm Message</b>	<b>Severity</b>	<b>Action Required</b>
Filter Sensor Fault	Warning	<ul style="list-style-type: none"> <li>• A hardware failure exists. For assistance, refer to the back page of this manual for contact information.</li> </ul>
High Discharge Pressure Alarm	Critical	<ul style="list-style-type: none"> <li>• For assistance, refer to the back page of this manual for contact information.</li> </ul>
Internal Communication Fault	Critical	<ul style="list-style-type: none"> <li>• A hardware failure exists. For assistance, refer to the back page of this manual for contact information.</li> </ul>
Low Suction Pressure Alarm	Warning	<ul style="list-style-type: none"> <li>• For assistance, refer to the back page of this manual for contact information.</li> </ul>
Rtn Air High Temp (Return Air High Temperature Violation)	Warning	<ul style="list-style-type: none"> <li>• Make sure the <b>Return Air</b> threshold is set correctly in the <b>Set Unit Thresholds</b> screen.</li> <li>• If the problem persists, contact APC at a number on the back cover of this manual.</li> </ul>
Sply Air High Temp (Supply air High Temperature Violation)	Warning	<ul style="list-style-type: none"> <li>• Make sure the <b>Supply Air</b> threshold is set correctly in the <b>Set Unit Thresholds</b> screen.</li> <li>• If the problem persists, contact APC at a number on the back cover of this manual.</li> </ul>
Persistent High Discharge Pressure Alarm	Critical	<ul style="list-style-type: none"> <li>• For assistance, refer to the back page of this manual for contact information.</li> </ul>
Persistent Low Suction Pressure Alarm	Critical	<ul style="list-style-type: none"> <li>• Indicates there were 3 <b>Low Suction Pressure</b> shutdowns in 30 minutes. Alarms must be cleared manually.</li> <li>• For assistance, refer to the back page of this manual for contact information.</li> </ul>
Rack Inlet High Temperature Violation	Critical	<ul style="list-style-type: none"> <li>• Make sure the <b>Rack Inlet High Temperature Threshold</b> is set correctly in the "Thresholds" screen.</li> <li>• Make sure remote temperature sensor is installed correctly in the rack inlet air stream.</li> <li>• If the problem persists, refer to the back page of this manual for contact information.</li> </ul>
Rack Inlet Temperature Sensor Fault	Critical	<ul style="list-style-type: none"> <li>• For assistance, refer to the back page of this manual for contact information.</li> </ul>
Suction Pressure Sensor Fault	Warning	<ul style="list-style-type: none"> <li>• A hardware failure exists. For assistance, refer to the back page of this manual for contact information.</li> </ul>
Suction Temperature Sensor Fault	Warning	<ul style="list-style-type: none"> <li>• A hardware failure exists. For assistance, refer to the back page of this manual for contact information.</li> </ul>
Water Detection Fault	Warning	<ul style="list-style-type: none"> <li>• Identify the source of the leak.</li> <li>• For assistance, refer to the back page of this manual for contact information.</li> </ul>
Grp Comm Fault (Group Communication Fault)	Critical	<ul style="list-style-type: none"> <li>• Make sure the number of cooling units in the group is configured properly and the A-Link connections between cooling units are correct.</li> <li>• Make sure the system is receiving power and is connected properly.</li> <li>• A hardware failure exists. For assistance, contact APC at a number on the back cover of this manual.</li> </ul>

<b>Displayed Alarm Message</b>	<b>Severity</b>	<b>Action Required</b>
Input Contact Fault	Warning	<ul style="list-style-type: none"> <li>• Make sure the <b>Input Normal</b> state is defined correctly in the <b>Configure Unit&gt; Discrete I/O</b> screen. See page 17 for more information.</li> <li>• Clear the problem that caused the input contact switch to change from the normal state.</li> <li>• If the problem persists, refer to the back page of this manual for contact information.</li> </ul>
Cannot Start Due to Low Suction Pressure	Critical	<ul style="list-style-type: none"> <li>• The unit cannot start because the suction (low side) refrigerant pressure is too low.</li> <li>• If the problem persists, refer to the back page of this manual for contact information.</li> </ul>
Startup Line Pressure Imbalance Alarm	Critical	<ul style="list-style-type: none"> <li>• The unit cannot start because the line pressure is too low.</li> <li>• If the problem persists, refer to the back page of this manual for contact information.</li> </ul>
Return Air Sensor Fault	Critical	<ul style="list-style-type: none"> <li>• A hardware failure exists. For assistance, refer to the back page of this manual for contact information.</li> </ul>
Supply Air Sensor Fault	Critical	<ul style="list-style-type: none"> <li>• A hardware failure exists. For assistance, refer to the back page of this manual for contact information.</li> </ul>



# Network Management Card

---

## Quick Configuration

The cooling unit is shipped with a Network Management Card that enables the cooling unit to be managed over a network. Configure the Network Management Card to control this cooling unit through a network.

### Overview

You must configure the following TCP/IP settings before the Network Management Card can operate on a network:

- IP address of the Network Management Card
- Subnet mask
- Default gateway



**Caution:** Never use the loopback address (127.0.0.1) as the default gateway address for the Network Management Card. Doing so will disable the card and will require you to reset TCP/IP settings to their defaults using a local serial login.



**Note:** If a default gateway is unavailable, use the IP address of a computer that is located on the same subnet as the Network Management Card and that is usually running. The Network Management Card uses the default gateway to test the network when traffic is very light.

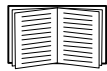

See “Watchdog Features” in the “Introduction” of the *User’s Guide* for more information about the watchdog role of the default gateway.

### TCP/IP configuration methods

Use one of the following methods to define the basic TCP/IP settings needed by the Network Management Card:

- APC Device IP Configuration Wizard (See “APC Device IP Configuration Wizard” on this page.)
- BOOTP or DHCP server (See “BOOTP & DHCP configuration” on page 28.)
- Networked computer (See “Remote access to the control console” on page 30.)

## APC Device IP Configuration Wizard

You can use the APC Device IP Configuration Wizard at a computer running Microsoft® Windows 2000, Windows Server 2003, or Windows XP to configure a Network Management Card.



**Note:** Most software firewalls must be temporarily disabled for the Wizard to discover unconfigured Network Management Cards.

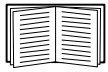

To configure one or more Network Management Cards from a user configuration file, see the *User's Guide* on the CD.

1. Insert the CD into a computer on your network.
2. If autorun is enabled, the user interface of the CD starts when you insert the CD. If autorun is not enabled, open the file **contents.htm** on the CD.
3. When the Wizard discovers the unconfigured Network Management Card, follow the on-screen instructions.



**Note:** If you leave the **Start a Web browser when finished** option enabled, you can use **apc** for both the user name and password to access the Network Management Card through your browser.

### .ini file utility

You can use the .ini file export utility to export .ini file settings from configured Network Management Cards to one or more unconfigured Network Management Cards. The utility and documentation are included on the CD.

### BOOTP & DHCP configuration

The default TCP/IP configuration setting, **BOOTP & DHCP**, assumes that a properly configured BOOTP or DHCP server is available to provide TCP/IP settings to Network Management Cards. The Network Management Card first attempts to discover a properly configured BOOTP server, and then a DHCP server. It repeats this pattern until it discovers a BOOTP or DHCP server.

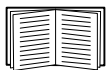

If neither of these servers is available, see “Local access to the control console” on page 30 or “Remote access to the control console” on page 30 to configure the needed TCP/IP settings.

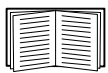

A user configuration (.ini) file can function as a BOOTP or DHCP boot file. For more information, see the TCP/IP configuration section of the *User's Guide*, available from the *Utility* CD or the APC Web site, [www.apc.com](http://www.apc.com).

**BOOTP.** For the Network Management Card to use a BOOTP server to configure its TCP/IP settings, it must find a properly configured RFC951-compliant BOOTP server.

1. In the BOOTPTAB file of the BOOTP server, enter the MAC address of the Network Management Card, the IP address, the subnet mask, default gateway, and an optional bootup file name. Look for the MAC address on the display interface (**Path: Main > Configure Network**) or on the label on the back of the Network Management Card.
2. When the Network Management Card reboots, the BOOTP server provides it with the TCP/IP settings.
  - If you specified a bootup file name, the Network Management Card attempts to transfer that file from the BOOTP server using TFTP or FTP. The Network Management Card assumes all settings specified in the bootup file.
  - If you did not specify a bootup file name, you can configure the other settings of the Network Management Card remotely through its Web interface or control console; user name and password are both **apc**, by default.

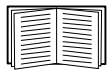

See your BOOTP server documentation to create a bootup file.

**DHCP.** You can use a RFC2131/RFC2132-compliant DHCP server to configure the TCP/IP settings for the Network Management Card.

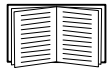

This section summarizes communication between the Network Management Card and a DHCP server. For more detail about how a DHCP server can configure the network settings for a Network Management Card, see “DHCP Configuration” in the *User’s Guide*.

1. A Network Management Card sends out a DHCP request that uses the following to identify itself:
  - A Vendor Class Identifier (APC by default)
  - A Client Identifier (by default, the MAC address value of the Network Management Card)
  - A User Class Identifier (by default, the identification of the application firmware of the Network Management Card)
2. A properly configured DHCP server responds with a DHCP offer that includes all of the settings that the Network Management Card needs for network communication. The DHCP offer also includes the Vendor Specific Information option (DHCP option 43). By default, the Network Management Card will ignore DHCP offers that do not encapsulate the APC cookie in the Vendor Specific Information option using the following hexadecimal format:

Option 43 = 01 04 31 41 50 43

where

- the first byte (01) is the code
- the second byte (04) is the length
- the remaining bytes (31 41 50 43) are the APC cookie



See your DHCP server documentation to add code to the Vendor Specific Information option.

To disable the requirement that a DHCP offer include the APC cookie, use the **DHCP Cookie Is** setting in the control console:

**Network>TCP/IP>Boot Mode>DHCP only>Advanced>DHCP Cookie Is.**

## Local access to the control console

You can use a computer connected to the serial port on the main board holding the Network Management Card to access the control console.

1. Select a serial port at the local computer, and disable any service that uses that port.
2. Use the provided configuration cable to connect the selected port to the serial port on the main board holding the Network Management Card.
3. Run a terminal program (such as HyperTerminal) and configure the selected port for 9600 or 19200 bps, 8 data bits, no parity, 1 stop bit, and no flow control. Save the changes.
4. Press ENTER to display the **User Name** prompt.
5. Use **apc** for the user name and password.

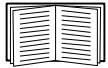

See “Control console” on page 31 to finish the configuration.

## Remote access to the control console

From any computer on the same subnet as the Network Management Card, you can use ARP and Ping to assign an IP address to a Network Management Card, and then use Telnet to access the control console of that Network Management Card and configure the needed TCP/IP settings.



**Note:** After the IP address of the Network Management Card is configured, you can use Telnet without first using ARP and Ping to access that Network Management Card.

1. Use the MAC address for the Network Management Card in the ARP command to define the IP address. For example, to define an IP address of 156.205.14.141 for a Network Management Card that has a MAC address of 00 c0 b7 63 9f 67, use one of the following commands:

– Windows command format:

```
arp -s 156.205.14.141 00-c0-b7-63-9f-67
```

– LINUX command format:

```
arp -s 156.205.14.141 00:c0:b7:63:9f:67
```



**Note:** The MAC address is available on the display interface at:

**Path:** **Main > Configure Network** or look at the label on the back of the Network Management Card for the MAC address.

1. Use Ping with a size of 113 bytes to assign the IP address defined by the ARP command. For the IP address defined in step 1, use one of the following Ping commands:

– Windows command format:

```
ping 156.205.14.141 -l 113
```

– LINUX command format:

```
ping 156.205.14.141 -s 113
```

2. Use Telnet to access the Network Management Card at its newly assigned IP address. For example:

```
telnet 156.205.14.141
```

3. Use **apc** for both user name and password.

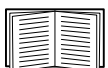

See “Control console” on page 31 to finish the configuration.

## Control console

After you log on at the control console, as described in “Local access to the control console” on page 30 or “Remote access to the control console” on page 30:

1. Choose **Network** from the **Control Console** menu.
2. Choose **TCP/IP** from the **Network** menu.
3. If you are not using a BOOTP or DHCP server to configure the TCP/IP settings, select the **Boot Mode** menu and then select **Manual boot mode**.
4. Set the **System IP**, **Subnet Mask**, and **Default Gateway** address values. (Changes will take effect when you log out.)
5. Press ENTER to return to the **TCP/IP** menu.
6. Press CTRL+C to exit to the **Control Console** menu.
7. Log out (option 4 in the **Control Console** menu).



**Note:** If you disconnected a cable from the local computer during the procedure described in “Local access to the control console” on page 30, reconnect that cable and restart the associated service.

# Access a Configured Network Management Card

## Overview

After the Network Management Card is running on your network, you can access the configured Network Management Card through the following interfaces:

- Web interface (HTTP or HTTPS protocol)
- Telnet or Secure SHell (SSH)
- SNMP
- FTP or Secure CoPy (SCP) to upgrade firmware
- Modbus

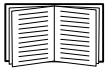

For more information on the interfaces, see the *User's Guide*.

## Web interface

Use Microsoft Internet Explorer® (IE) 5.5 and higher (on Windows operating systems only), Mozilla-based browsers that support Firefox 1.x (on all operating systems), or Netscape® 7.x and higher (on all operating systems) to access the Web interface of the cooling unit. Other commonly available browsers may also work but have not been fully tested by APC.

You can use either of the following protocols when you use the Web interface:

- The HTTP protocol (enabled by default), which provides authentication by user name and password but no encryption.
- The HTTPS protocol, which provides extra security through Secure Sockets Layer (SSL); encrypts user names, passwords, and data being transmitted; and authenticates the Network Management Card by means of digital certificates.

To access the Web interface and configure the security of your device on the network:

1. Address the Network Management Card by its IP address or DNS name (if configured).
2. Enter the user name and password (by default, **apc** and **apc** for an Administrator).
3. To enable or disable the HTTP or HTTPS protocols, use the **Network** menu on the **Administration** tab, and select the **Access** option under the **Web** heading on the left navigation menu.

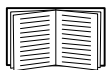

For more information on selecting and configuring network security, see the *Security Handbook*, available on the *Utility* CD or from the APC Web site, [www.apc.com](http://www.apc.com).

## Telnet and SSH

You can access the control console through Telnet or Secure SHell (SSH), depending on which is enabled. Select the **Administration** tab, the **Network** option on the top menu bar, and then the **Access** option under **Console** on the left navigation menu. By default, Telnet is enabled. Enabling SSH automatically disables Telnet.

**Telnet for basic access.** Telnet provides the basic security of authentication by user name and password, but not the high-security benefits of encryption. To use Telnet to access the control console of the Network Management Card:

1. At a command prompt, use the following command line, and press ENTER:

```
telnet address
```

As *address*, use the IP address of the Network Management Card (or DNS name if configured).

2. Enter the user name and password (by default, **apc** and **apc** for an Administrator, or **device** and **apc** for a Device User).

**SSH for high-security access.** If you use the high security of SSL for the Web interface, use Secure SHell (SSH) for access to the control console. SSH encrypts user names, passwords, and transmitted data.

The interface, user accounts, and user access rights are the same whether you access the control console through SSH or Telnet, but to use SSH, you must first configure SSH and have an SSH client program installed on your computer.

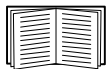

See the *User's Guide* for more information on configuring and using SSH.

## Simple Network Management Protocol (SNMP)

**SNMPv1 only.** After you add the PowerNet<sup>®</sup> MIB to a standard SNMP MIB browser, you can use that browser to access the Network Management Card. All user names, passwords, and community names for SNMP are transferred over the network as plain text. The default read community name is **public**; the default read/write community name is **private**.

**SNMPv3 only.** For SNMP GETs, SETs, and trap receivers, SNMPv3 uses a system of user profiles to identify users. An SNMPv3 user must have a user profile assigned in the MIB software program to perform GETs and SETs, browse the MIB, and receive traps. The default settings are **no authentication** and **no privacy**.



**Note:** To use SNMPv3, you must have a MIB program that supports SNMPv3.

**Note:** The Network Management Card supports only MD5 authentication and DES encryption.

**SNMPv1 and SNMPv3.** To use InfraStruXure Central or InfraStruXure Manager to manage the Network Management Card, you must have SNMPv1 enabled in the interface of the cooling unit. Read access allows InfraStruXure devices to receive traps from the cooling unit. Write access is required while you set the InfraStruXure device as a trap receiver.

To enable or disable SNMP access, you must be an Administrator. Select the **Administration** tab, select the **Network** menu on the top menu bar, and use the **access** option under **SNMPv1** or **SNMPv3** on the left navigation menu.

## FTP/SCP

You can use FTP (enabled by default) or Secure CoPy (SCP) to transfer downloaded firmware to the Network Management Card, or to access a copy of the event or data logs of the cooling unit. SCP provides the higher security of encrypted data transmission and is enabled automatically when you enable SSH.

To use InfraStruXure Central or Manager to manage the Network Management Card, you must have **FTP Server** enabled in the Network Management Card. To enable or disable **FTP Server** access, you must be an Administrator. On the **Administration** tab, select the **Network** menu on the top menu bar, and use the **FTP server** option on the left navigation menu.

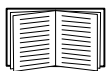

In the *User's Guide*, see the following sections:

- To transfer firmware, see “File Transfers.”
- To retrieve a copy of the event or data log, see “Use FTP or SCP to retrieve log files.”

## Modbus

Use Modbus to view the Network Management Card through the interface of your building management system. It is read-only.

The Modbus interface supports 2-wire RS-485, plus ground.



**Note:** Modbus can be configured to run at either 9600 or 19200 bps.



The Modbus register map is also available on the APC Web site, **www.apc.com**.



# Recover From a Lost Password

You can use a local computer (a computer that connects to the Network Management Card through the serial port) to access the control console.

1. Select a serial port at the local computer, and disable any service that uses that port.
2. Connect the provided RS-232 configuration cable to the selected port on the computer and to the RS-232 console port at the Network Management Card.
3. Run a terminal program (such as HyperTerminal) on your computer and configure the selected port for 9600 or 19200 bps, 8 data bits, no parity, 1 stop bit, and no flow control.
1. Press ENTER, repeatedly if necessary, to display the **User Name** prompt. If you are unable to display the **User Name** prompt, verify the following:
  - The serial port is not in use by another application.
  - The correct cable is being used as specified in step 2.
  - The terminal settings are correct as specified in step 3.
2. Press the **Reset** switch. The Status LED will flash alternately orange and green. Press the **Reset** button a second time immediately while the LED is flashing to reset the user name and password to their default values temporarily.
3. Press ENTER as many times as necessary to redisplay the **User Name** prompt, then use the default, **apc**, for the user name and password. (If you take longer than 30 seconds to log on after the **User Name** prompt is redisplayed, you must repeat step 5 and log on again.)
4. From the **Control Console** menu, select **System**, then **User Manager**.
5. Select **Administrator**, and change the **User Name** and **Password** settings, both of which are now defined as **apc**.
6. Press CTRL+C, log off, reconnect any serial cable you disconnected, and restart any service you disabled.

# Maintenance

---

## Monthly Preventive Maintenance

The following pages can be photocopied and used during the maintenance procedures. After they have been filled out, save them for future reference.

Prepared By: \_\_\_\_\_

Model Number: \_\_\_\_\_

Serial Number: \_\_\_\_\_

Date: \_\_\_\_\_

### Environment

- In what type of room is the cooling unit located?

\_\_\_\_\_

- Is the cooling unit maintaining the temperature setpoint?

\_\_\_\_\_

Temperature setpoint \_\_\_\_\_

- Is there visible damage to the cooling unit (dents, scratches)?

\_\_\_\_\_  
\_\_\_\_\_  
\_\_\_\_\_

- Check for environmental damage (dirt, dust, debris, liquid stains) around the cooling unit installation area.

\_\_\_\_\_  
\_\_\_\_\_

- Record the room temperature/humidity near the return of the cooling unit.

Temperature \_\_\_\_\_

- Record last month's alarm history.

\_\_\_\_\_  
\_\_\_\_\_  
\_\_\_\_\_

### Cleanliness

- Check the condition of return air filters. Change if necessary.

- Check the condition of the drain pan and accumulation of debris in the pan. Clean as required.

## Mechanical



**Electrical Hazard:** Turn off the cooling unit and disconnect all power sources. Perform Lockout/Tagout procedures before performing any electrical or mechanical service. Wear appropriate personal protective equipment when checking hazardous voltages.

- Check the fans. All components should be moving freely, with no signs of binding or damage.
- Verify that the condensate line is flowing freely.

## Electrical



**Electrical Hazard:** Turn off the cooling unit and disconnect all power sources. Perform Lockout/Tagout procedures before performing any electrical or mechanical service. Wear appropriate personal protective equipment when checking hazardous voltages.



**Electrical Hazard:** A Leakage Current Detector and Interrupter (LCDI) plug detects if there is damage to the power cord that could cause arcing between wires, resulting in a fire. The LCDI shuts off power if the power cord is damaged. The cooling unit should be in **Standby** mode before testing the LCDI plug.

- Inspect the power cord for damage. The power cord for the ACSC100 (60Hz) has a test button on the cord to test the LCDI plug.

# Quarterly Preventive Maintenance

\* Perform all the Monthly Preventive Maintenance items **and** the items below.

Prepared By: \_\_\_\_\_

Model Number: \_\_\_\_\_

Serial Number: \_\_\_\_\_

Date: \_\_\_\_\_

## Mechanical



**Electrical Hazard:** Turn off the cooling unit and disconnect all power sources. Perform Lockout/Tagout procedures before performing any electrical or mechanical service. Wear appropriate personal protective equipment when checking hazardous voltages.

- Verify that the fan hardware is tight.
- Clean/replace filters.
- Clean condensate pans.
- Clean condensate drain line.
- Remove any debris from condensate floats.
- Clean dust from door perforations.
- Clean dust from fan bezels.

## Functional tests

- Verify the cooling operation mode is functioning properly.

# Semi-Annual Preventive Maintenance

\* Perform all the Monthly/Quarterly Preventive Maintenance items **and** the items below.

Prepared By: \_\_\_\_\_

Model Number: \_\_\_\_\_

Serial Number: \_\_\_\_\_

Date: \_\_\_\_\_

## Cleanliness

- Check the cleanliness of the evaporator and condenser coils. Clean if required.

# Troubleshooting

---

<b>Problem</b>	<b>Possible Cause</b>	<b>Corrective Action</b>
Fans fail to start	<ul style="list-style-type: none"> <li>• Cooling Unit shutdown due to an external command</li> <li>• Single fan fails to start</li> </ul>	<ul style="list-style-type: none"> <li>• Temporarily remove the user contact cable, if it is connected.</li> <li>• Confirm that the fan is seated properly and fully engaged.</li> <li>• Replace the fan if it is faulty.</li> </ul>
Cooling unit cannot achieve setpoint	<ul style="list-style-type: none"> <li>• Improper placement of remote temperature sensor</li> <li>• Dirty filter</li> <li>• Dirty coil</li> <li>• Application error</li> <li>• Heat load is too far away</li> </ul>	<ul style="list-style-type: none"> <li>• Verify that the remote temperature sensor is properly located in the IT rack.</li> <li>• Clean the filter.</li> <li>• Clean the coil.</li> <li>• Contact APC Worldwide Customer Support at a number on the back cover of this manual.</li> <li>• Place the cooling unit closer to the heat load.</li> </ul>
Water carryover	<ul style="list-style-type: none"> <li>• Improper fan speed selected</li> <li>• Room humidity is too high</li> <li>• Dirty coil</li> <li>• Dirty filter</li> <li>• Room humidity is too high</li> </ul>	<ul style="list-style-type: none"> <li>• Select the next highest fan speed setting. For example, change the fan speed setting from Low to Med/Low.</li> <li>• Adjust setpoint on dehumidifying equipment.</li> <li>• Add additional dehumidifying equipment.</li> <li>• Clean the coil.</li> <li>• Clean the air filter.</li> <li>• Adjust setpoint on dehumidifying equipment.</li> <li>• Improve room sealing.</li> </ul>
Cooling unit noise level is higher than expected	<ul style="list-style-type: none"> <li>• Improper fan speed selected</li> <li>• Incorrect placement of rack inlet sensor</li> </ul>	<ul style="list-style-type: none"> <li>• Select a lower fan speed.</li> <li>• Verify that the rack inlet sensor is properly located in the cold aisle.</li> </ul>
Temperature control not precise enough	<ul style="list-style-type: none"> <li>• Improper placement of remote temperature sensor</li> </ul>	<ul style="list-style-type: none"> <li>• Verify that the remote temperature sensor is properly located in the IT rack.</li> </ul>
Water outside of Cooling unit	<ul style="list-style-type: none"> <li>• Condensate drain hose is not connected or not properly routed outside the cooling unit</li> <li>• Leak in drain system</li> <li>• Cooling unit not leveled properly</li> <li>• Damaged piping insulation</li> </ul>	<ul style="list-style-type: none"> <li>• Verify that the condensate drain hose is properly connected to the pump and properly routed outside of the cooling unit.</li> <li>• Verify that the condensate drain line does not exceed 4.9 meters (16.0 feet) lift and 15.2 meters (50.0 feet) horizontal run.</li> <li>• Locate and repair the leak.</li> <li>• Adjust the leveling feet of the cooling unit.</li> <li>• Identify damaged area and repair the insulation.</li> </ul>

<b>Problem</b>	<b>Possible Cause</b>	<b>Corrective Action</b>
Local display is not operational, but cooling unit operates	<ul style="list-style-type: none"> <li>Local display not connected properly</li> </ul>	<ul style="list-style-type: none"> <li>Verify that the local display cable is connected properly.</li> </ul>
Incorrect air pressure	<ul style="list-style-type: none"> <li>False filter clogs</li> </ul>	<ul style="list-style-type: none"> <li>Verify that the ends of the clear plastic air tubes are not obstructed.</li> <li>Verify that the clear plastic air tubes are connected to the controller.</li> <li>Verify that the clear plastic air tubes are not pinched.</li> </ul>
Alarms do not display on monitoring equipment (Customer Output Contact)	<ul style="list-style-type: none"> <li>External monitoring equipment is not receiving power or is not functioning properly</li> </ul>	<ul style="list-style-type: none"> <li>Confirm that power, if required, is being supplied to the external equipment.</li> <li>If the cooling unit is providing power (+12 V or +24 V) to the external equipment, verify that the external equipment is <math>\leq 20</math> mA.</li> <li>Test the external equipment by bypassing the customer output contact.</li> </ul>
Cooling unit does not shutdown on command	<ul style="list-style-type: none"> <li>Drive voltage</li> </ul>	<ul style="list-style-type: none"> <li>Verify that there is a drive voltage entering the cooling unit. You may use the available +12 V or +24 V power located near the cooling unit. You must then also use the ground.</li> </ul>
No communication with building management system (BMS) port	<ul style="list-style-type: none"> <li>Improper connection</li> </ul>	<ul style="list-style-type: none"> <li>Confirm that the cooling unit is connected to the BMS port and not to the Control port.</li> <li>Make sure that the wire polarity is correct. Using a DC voltmeter, test the signal with no transmissions in progress: Pin 2 should be greater than Pin 1 by at least 200 mV. Measure the cooling unit with the cable disconnected, and then measure it again with the cable connected. If the signal is less than 200 mV, the cooling unit may be reverse-wired.</li> <li>Make sure that every cooling unit has either two sets of wires in its connector OR one set of wires and a 150-ohm resistor.</li> </ul>
Cooling units are not communicating with each other	<ul style="list-style-type: none"> <li>A-Link failure</li> </ul>	<ul style="list-style-type: none"> <li>Verify that the actual number of cooling units in the group matches the group number setting.</li> <li>Verify that the A-Link ports of every cooling unit have either two cables or one cable and a terminator.</li> <li>Confirm that the A-Link cables are connected to the A-Link ports and that a network cable is connected to the network port.</li> </ul>
Output air is 17°C (62°F) and fans are running at a very high rate of speed.	<ul style="list-style-type: none"> <li>Upper or lower supply air sensor fault</li> </ul>	<ul style="list-style-type: none"> <li>Either the upper or lower supply air temperature sensor has a fault. Verify that both supply air temperature sensors are installed and working properly.</li> </ul>

# Warranty

---

## One-Year Factory Warranty

The limited warranty provided by American Power Conversion (APC<sup>®</sup>) in this Statement of Limited Factory Warranty applies only to products you purchase for your commercial or industrial use in the ordinary course of your business.

### Terms of warranty

American Power Conversion warrants its products to be free from defects in materials and workmanship for a period of one year from the date of purchase. The obligation of APC under this warranty is limited to repairing or replacing, at its sole discretion, any such defective products. This warranty does not apply to equipment that has been damaged by accident, negligence or misapplication or has been altered or modified in any way. Repair or replacement of a defective product or part thereof does not extend the original warranty period. Any parts furnished under this warranty may be new or factory-remanufactured.

### Non-transferable warranty

This warranty extends only to the original purchaser who must have properly registered the product. The product may be registered at the APC Web site, [www.apc.com](http://www.apc.com).

### Exclusions

APC shall not be liable under the warranty if its testing and examination disclose that the alleged defect in the product does not exist or was caused by end user's or any third person's misuse, negligence, improper installation or testing. Further, APC shall not be liable under the warranty for unauthorized attempts to repair or modify wrong or inadequate electrical voltage or connection, inappropriate on-site operation conditions, corrosive atmosphere, repair, installation, start-up by non-APC designated personnel, a change in location or operating use, exposure to the elements, Acts of God, fire, theft, or installation contrary to APC recommendations or specifications or in any event if the APC serial number has been altered, defaced, or removed, or any other cause beyond the range of the intended use.

**THERE ARE NO WARRANTIES, EXPRESS OR IMPLIED, BY OPERATION OF LAW OR OTHERWISE, OF PRODUCTS SOLD, SERVICED OR FURNISHED UNDER THIS AGREEMENT OR IN CONNECTION HERewith. APC DISCLAIMS ALL IMPLIED WARRANTIES OF MERCHANTABILITY, SATISFACTION AND FITNESS FOR A PARTICULAR PURPOSE. APC EXPRESS WARRANTIES WILL NOT BE ENLARGED, DIMINISHED, OR AFFECTED BY AND NO OBLIGATION OR LIABILITY WILL ARISE OUT OF, APC RENDERING OF TECHNICAL OR OTHER ADVICE OR SERVICE IN CONNECTION WITH THE PRODUCTS. THE FOREGOING WARRANTIES AND REMEDIES ARE EXCLUSIVE AND IN LIEU OF ALL OTHER WARRANTIES AND REMEDIES. THE WARRANTIES SET FORTH ABOVE CONSTITUTE APC'S SOLE LIABILITY AND PURCHASER'S EXCLUSIVE REMEDY FOR ANY BREACH OF SUCH WARRANTIES. APC WARRANTIES EXTEND ONLY TO PURCHASER AND ARE NOT EXTENDED TO ANY THIRD PARTIES.**



**IN NO EVENT SHALL APC, ITS OFFICERS, DIRECTORS, AFFILIATES OR EMPLOYEES BE LIABLE FOR ANY FORM OF INDIRECT, SPECIAL, CONSEQUENTIAL OR PUNITIVE DAMAGES, ARISING OUT OF THE USE, SERVICE OR INSTALLATION, OF THE PRODUCTS, WHETHER SUCH DAMAGES ARISE IN CONTRACT OR TORT, IRRESPECTIVE OF FAULT, NEGLIGENCE OR STRICT LIABILITY OR WHETHER APC HAS BEEN ADVISED IN ADVANCE OF THE POSSIBILITY OF SUCH DAMAGES. SPECIFICALLY, APC IS NOT LIABLE FOR ANY COSTS, SUCH AS LOST PROFITS OR REVENUE, LOSS OF EQUIPMENT, LOSS OF USE OF EQUIPMENT, LOSS OF SOFTWARE, LOSS OF DATA, COSTS OF SUBSTITUENTS, CLAIMS BY THIRD PARTIES, OR OTHERWISE.**

**NO SALESMAN, EMPLOYEE OR AGENT OF APC IS AUTHORIZED TO ADD TO OR VARY THE TERMS OF THIS WARRANTY. WARRANTY TERMS MAY BE MODIFIED, IF AT ALL, ONLY IN WRITING SIGNED BY AN APC OFFICER AND LEGAL DEPARTMENT.**

### **Warranty claims**

Customers with warranty claims issues may access the APC customer support network through the Support page of the APC Web site, [www.apc.com/support](http://www.apc.com/support). Select your country from the country selection pull-down menu at the top of the Web page. Select the Support tab to obtain contact information for customer support in your region.





# APC Worldwide Customer Support

Customer support for this or any other APC product is available at no charge in any of the following ways:

- Visit the APC Web site to access documents in the APC Knowledge Base and to submit customer support requests.
  - **www.apc.com** (Corporate Headquarters)  
Connect to localized APC Web sites for specific countries, each of which provides customer support information.
  - **www.apc.com/support/**  
Global support searching APC Knowledge Base and using e-support.
- Contact an APC Customer Support center by telephone or e-mail.
  - Local, country-specific centers: go to **www.apc.com/support/contact** for contact information.

For information on how to obtain local customer support, contact the APC representative or other distributor from whom you purchased your APC product.

Entire contents copyright 2009 American Power Conversion Corporation. All rights reserved.  
Reproduction in whole or in part without permission is prohibited. APC, the APC logo and InRow are trademarks of American Power Conversion Corporation. All other trademarks, product names, and corporate names are the property of their respective owners and are used for informational purposes only.



## Free Manuals Download Website

<http://myh66.com>

<http://usermanuals.us>

<http://www.somanuals.com>

<http://www.4manuals.cc>

<http://www.manual-lib.com>

<http://www.404manual.com>

<http://www.luxmanual.com>

<http://aubethermostatmanual.com>

Golf course search by state

<http://golfingnear.com>

Email search by domain

<http://emailbydomain.com>

Auto manuals search

<http://auto.somanuals.com>

TV manuals search

<http://tv.somanuals.com>