

# Getting Started

With Your Macintosh LC 575

*Includes setup instructions and important health-related information*

## Apple Computer, Inc.

This manual and the software described in it are copyrighted, with all rights reserved. Under the copyright laws, this manual or the software may not be copied, in whole or part, without written consent of Apple, except in the normal use of the software or to make a backup copy of the software. The same proprietary and copyright notices must be affixed to any permitted copies as were affixed to the original. This exception does not allow copies to be made for others, whether or not sold, but all of the material purchased (with all backup copies) may be sold, given, or loaned to another person. Under the law, copying includes translating into another language or format.

You may use the software on any computer owned by you, but extra copies cannot be made for this purpose.

The Apple logo is a trademark of Apple Computer, Inc., registered in the U.S. and other countries. Use of the "keyboard" Apple logo (Option-Shift-K) for commercial purposes without the prior written consent of Apple may constitute trademark infringement and unfair competition in violation of federal and state laws.

Every effort has been made to ensure that the information in this manual is accurate. Apple is not responsible for printing or clerical errors.

© 1993 Apple Computer, Inc.  
20525 Mariani Avenue  
Cupertino, CA 95014-6299  
(408) 996-1010

Apple, the Apple logo, AppleShare, AppleTalk, EtherTalk, LaserWriter, and Macintosh are trademarks of Apple Computer, Inc., registered in the U.S. and other countries.

Apple Desktop Bus, At Ease, and QuickTime are trademarks of Apple Computer, Inc.

AppleCare is a service mark of Apple Computer, Inc., registered in the U.S. and other countries.

Adobe, Adobe Illustrator, Adobe Photoshop, and PostScript are trademarks of Adobe Systems Incorporated, which may be registered in certain jurisdictions.

Exposure is a registered trademark of Preferred Publishers, Inc.

HyperCard is a registered trademark of Claris Corporation.

*Macintosh Basics* was developed using VideoWorks Interactive. MacroMind is a registered trademark and VideoWorks Interactive is a trademark of Macromedia, Inc. (formerly MacroMind, Inc.).

QMS is a registered trademark of QMS, Inc.

QuarkXPress is a registered trademark of Quark, Inc.

SuperPaint is a registered trademark of Aldus Corporation.

Tektronix is a registered trademark of Tektronix, Inc.

Trinitron is a registered trademark of Sony Corporation.

Simultaneously published in the United States and Canada.

Mention of third-party products is for informational purposes only and constitutes neither an endorsement nor a recommendation. Apple assumes no responsibility with regard to the performance or use of these products.

# Contents

Communications regulation information v

## ■ Setting Up 1

Plugging in the computer 2

Connecting the mouse and keyboard 3

Turning on your computer for the first time 4

Problems starting up? 5

Safety instructions 6

Health-related information about computer use 7

What's next? 11

## ■ Learning the Basics 12

Taking the *Macintosh Basics* tour 12

Turning the computer on and off 16

## ■ Your Computer at a Glance 18

## ■ Special Features 20

Adjusting the sound 20

Adjusting the screen 22

Disabling the buttons on the front of your computer 23

Saving energy 24

Using the built-in microphone 25

Installing an expansion card 25

Using memory efficiently 30

Using a RAM disk for temporary storage 30

Connecting to a network 31

Using a modem 32

Starting up your computer from an external  
hard disk 32

## ■ Installing System Software 33

Using the CD as your startup device 34

Reinstalling system software 36

Creating a set of backup floppy disks 38

Copying the *Macintosh Basics* tour 40

## Communications regulation information

This equipment has been tested and found to comply with the limits for a Class B digital device in accordance with the specifications in Part 15 of FCC rules. See instructions if interference to radio or television reception is suspected.

## Radio and television interference

The equipment described in this manual generates, uses, and can radiate radio-frequency energy. If it is not installed and used properly—that is, in strict accordance with Apple’s instructions—it may cause interference with radio and television reception.

This equipment has been tested and found to comply with the limits for a Class B digital device in accordance with the specifications in Part 15 of FCC rules. These specifications are designed to provide reasonable protection against such interference in a residential installation. However, there is no guarantee that interference will not occur in a particular installation.

You can determine whether your computer system is causing interference by turning it off. If the interference stops, it was probably caused by the computer or one of the peripheral devices.

If your computer system does cause interference to radio or television reception, try to correct the interference by using one or more of the following measures:

- Turn the television or radio antenna until the interference stops.
- Move the computer to one side or the other of the television or radio.
- Move the computer farther away from the television or radio.
- Plug the computer into an outlet that is on a different circuit from the television or radio. (That is, make certain the computer and the television or radio are on circuits controlled by different circuit breakers or fuses.)

If necessary, consult an Apple-authorized service provider or Apple. See the service and support information that came with your Apple product. Or, consult an experienced radio/television technician for additional suggestions. You may find the following booklet helpful: *Interference Handbook* (stock number 004-000-00493-1). This booklet, prepared by the Federal Communications Commission, is available from the U.S. Government Printing Office, Washington, DC 20402.

**△ Important:** Changes or modifications to this product not authorized by Apple Computer, Inc., could void the FCC Certification and negate your authority to operate the product.

This product was tested for FCC compliance under conditions that included the use of Apple peripheral devices and Apple shielded cables and connectors between system components. It is important that you use Apple peripheral devices and shielded cables and connectors between system components to reduce the possibility of causing interference to radios, television sets, and other electronic devices. You can obtain Apple peripheral devices and the proper shielded cables and connectors through an Apple-authorized dealer. For non-Apple peripheral devices, contact the manufacturer or dealer for assistance. △

## DOC statement

**DOC Class B Compliance** This digital apparatus does not exceed the Class B limits for radio noise emissions from digital apparatus as set out in the interference-causing equipment standard entitled “Digital Apparatus,” ICES-003 of the Department of Communications.

**Observation des normes—Classe B** Cet appareil numérique respecte les limites de bruits radioélectriques applicables aux appareils numériques de Classe B prescrites dans la norme sur le matériel brouilleur : “Appareils Numériques,” NMB-003 édictée par le ministre des Communications.

## VCCI statement

### 情報処理装置等電波障害自主規制について

この装置は、第二種情報装置（住宅地域又はその隣接した地域において使用されるべき情報装置）で住宅地域での電波障害防止を目的とした情報処理装置等電波障害自主規制協議会（VCCI）基準に適合しております。

しかし、本装置をラジオ、テレビジョン受信機に近接してご使用になると、受信障害の原因となることがあります。

取扱説明書に従って正しい取り扱いをしてください。

## CD-ROM drive

▲ **Warning:** Making adjustments or performing procedures other than those specified in your equipment's manual may result in hazardous exposure. ▲

▲ **Warning:** Do not attempt to disassemble the cabinet containing the laser. The laser beam used in this product is harmful to the eyes. The use of optical instruments, such as magnifying lenses, with this product increases the potential hazard to your eyes. For your safety, have this equipment serviced only by an Apple-authorized service provider. ▲

If you have an internal Apple CD-ROM drive in your computer, your computer is a Class 1 laser product. The Class 1 label, located on the computer, indicates that the drive meets minimum safety requirements.



Class 1 label

# Setting Up

Setting up your computer involves these steps:

- Plugging in the computer
- Connecting the mouse and keyboard
- Turning on your computer

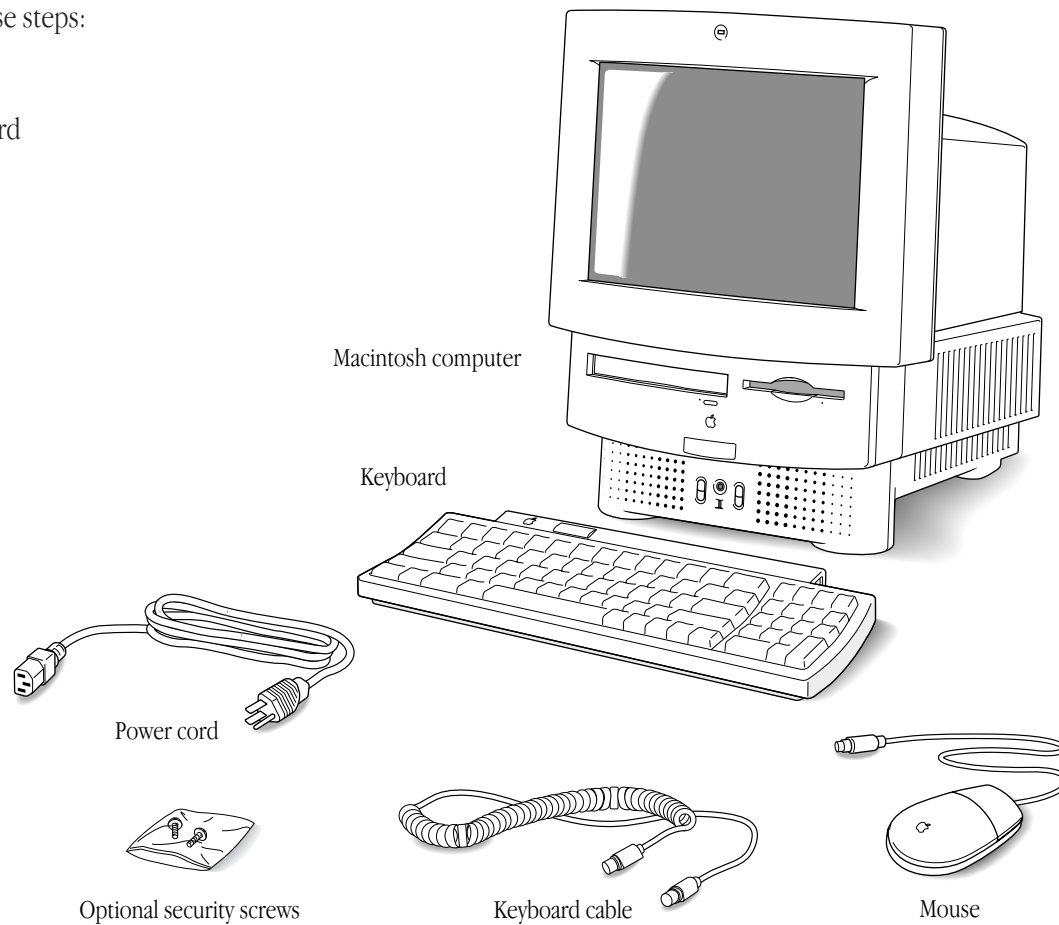

## Plugging in the computer

Plug in the Macintosh before connecting anything to it. The plug grounds the computer and protects it from electrical damage while you are setting up.

△ **Important:** To protect both yourself and the computer from electrical hazards, the computer should remain turned off until you are finished connecting its parts. Check the main power switch at the back of the computer. Make sure that the bottom of the switch (marked with an “O”) is pressed in. △

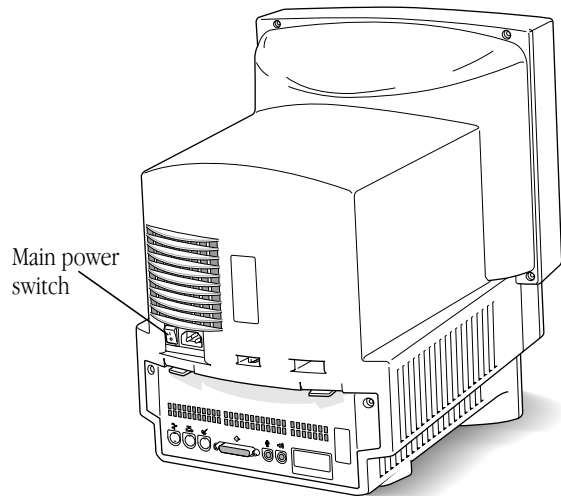

1. **Plug the socket end of the power cord into the recessed power plug (marked with the symbol ~) on the back of the computer.**

△ **Important:** Make sure at least one end of the power cord is within easy reach so that you can unplug the computer when you need to. △

2. **Plug the other end of the power cord into a three-hole grounded outlet or power strip.**

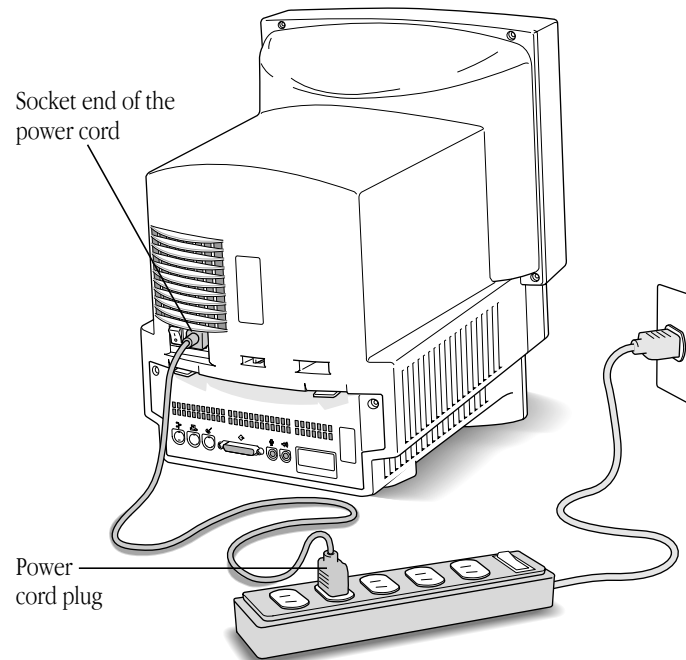



▲ **Warning:** This equipment is intended to be electrically grounded. Your Macintosh is equipped with a three-wire grounding plug—a plug that has a third (grounding) pin. This plug will fit only a grounded AC outlet. This is a safety feature. If you are unable to insert the plug into the outlet, contact a licensed electrician to replace the outlet with a properly grounded outlet. Do not defeat the purpose of the grounding plug! ▲

## Connecting the mouse and keyboard

Follow these steps to connect the mouse and keyboard:

1. **Plug the mouse cable into the port on the right side of the keyboard. (If you prefer to use the mouse with your left hand, plug the mouse cable into the port on the left side of the keyboard.)**

The plug and the port are marked with the same icon (⌘). Align the icons before you insert the plug.

- ❖ *By the way:* The ⌘ icon is often called the Apple Desktop Bus (ADB) icon. You may see this term in other places in the manuals that came with your computer. ❖

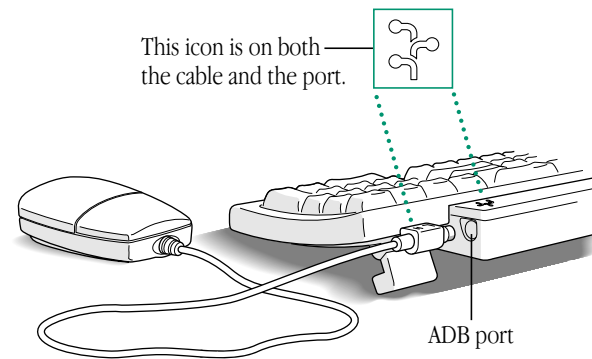

2. **Plug one end of the keyboard cable—both ends are the same—into the port on the other side of the keyboard.**

If you plugged the mouse cable in on the right, for example, plug the keyboard cable in on the left.

3. **Plug the other end of the keyboard cable into one of the ports marked with the ⌘ icon on the back of the computer.**

As you work with your Macintosh, you may find that you want to adjust the height of the keyboard. Your *Macintosh User's Guide* provides information on adjusting the keyboard so that you can work comfortably.

## Turning on your computer for the first time

In order to start up, your computer must have special software (called system software) installed on the hard disk. Your computer may have this software already installed.

To see if your hard disk already has system software installed, follow these *two* steps to turn on your computer.

1. **Press the top of the main power switch at the back of the computer. The top of the switch is marked with an “I”.**

This switch provides power to your computer, but doesn't turn it on.

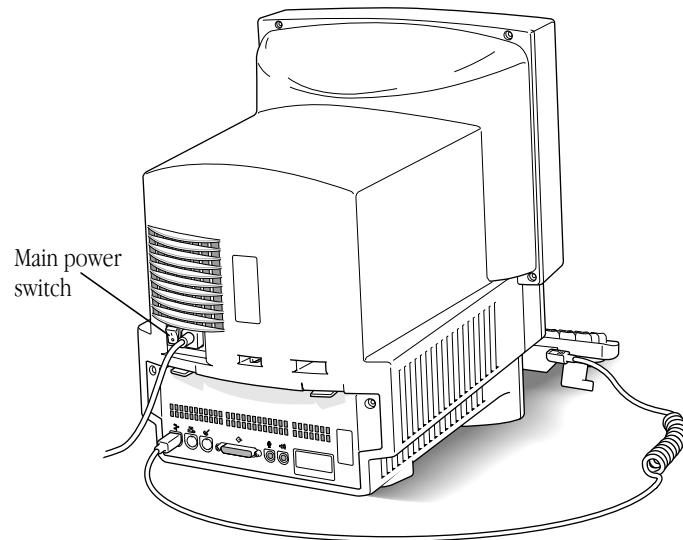

2. **Press the Power key (marked with the ◀ icon) on the keyboard to turn on your computer.**

Now your computer is on.

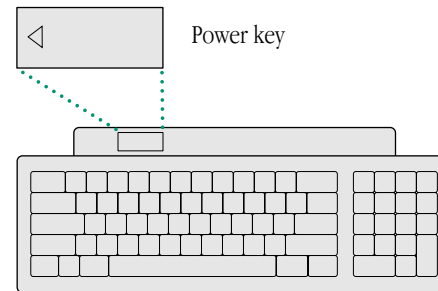

What you see after you turn on your computer depends on whether system software has already been installed on your hard disk.

If your screen looks like the one below, with a small, labeled picture (icon) at the top right, then your computer is ready to use. Look at “Safety Instructions,” later in this book, for important safety instructions.

△ **Important:** If your screen looks like the one below, system software has already been installed. You don’t need to install system software. Do not use the *Install Me First* floppy disk or CD. △

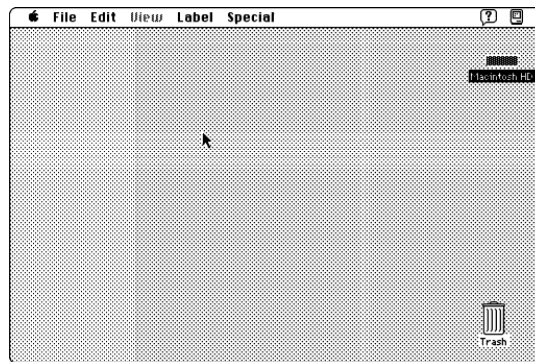

If the screen is dark or you see a blinking question mark on the screen, refer to the next section, “Problems Starting Up.”

## Problems starting up?

If you don’t see anything on the screen, check these items to see if you can identify the problem:

- Is the computer firmly plugged into a power source? If it is plugged into a power strip, is the power strip turned on?
- Is the computer itself turned on? Check to see if the power-on light on the front of your computer is green. If it’s not, you need to turn the computer on, using the main power switch at the back of the computer.
- Is the keyboard cable connected correctly? (Don’t disconnect the keyboard cable while your computer is on. You could damage your equipment.)
- If you have an external hard disk attached to your computer, is that hard disk turned on? Was it turned on before you turned on the computer? If you’re not sure, turn everything off as described in “Turning the Computer On and Off,” later in this book. Then turn on the external hard disk before you turn on your computer.

If you see a blinking question mark on the screen, you'll need to install system software in one of the following ways:

- If your computer came with a CD-ROM disc labeled *CD Install Me First*, see the section of this manual titled "Using the *CD Install Me First* Disc" for instructions on how to use the disc to install system software.
- If your computer came with a set of floppy disks, go to the chapter "Setting Up Your Macintosh System" in the *Macintosh User's Guide* for instructions on installing system software from floppy disks. Make sure that the label on the *Install Me First* disk says it is for your Macintosh model.

## Safety instructions

For your own safety and that of your equipment, always take the following precautions.

Turn off the computer completely and disconnect the power plug (by pulling the plug, not the cord) if any of the following conditions exists:

- the power cord or plug becomes frayed or otherwise damaged
- you spill something into the case
- your Macintosh is exposed to rain or any other excess moisture
- your Macintosh has been dropped or the case has been otherwise damaged
- you suspect that your Macintosh needs service or repair
- you want to clean the case (use only the recommended procedure described below)

For additional safety:

- Replace the back panel of the computer, if you ever need to remove it, before you use your computer.
- Never turn on your computer with any of the internal parts removed.

Be sure that you always do the following:

- Keep your Macintosh away from sources of liquids, such as wash basins, bathtubs, shower stalls, and so on.
  - Protect your Macintosh from dampness or wet weather, such as rain, snow, and so on.
  - Read all the installation instructions carefully before you plug your Macintosh into a wall socket.
  - Keep these instructions handy for reference by you and others.
  - Follow all instructions and warnings dealing with your system.
- ▲ **Warning:** Electrical equipment may be hazardous if misused. Operation of this product, or similar products, must always be supervised by an adult. Do not allow children access to the interior of any electrical product and do not permit them to handle any cables. ▲

To clean the case, do the following:

1. Turn off the computer completely and then disconnect the power plug. (Pull the plug, not the cord.)
2. Wipe the surfaces lightly with a clean, soft cloth dampened with water.

## Health-related information about computer use

Muscle soreness, eye fatigue, and other discomforts and injuries sometimes associated with using computers can occur from performing any number of activities. In fact, misuse of the same muscles during multiple activities can create a problem that might not otherwise exist. For example, if you engage in nonwork activities that involve repetitive stress on the wrist—such as bicycling—and also use your computer’s keyboard improperly, you may increase your likelihood of developing wrist problems. Some individuals are at greater risk of developing these problems because of their health, physiology, lifestyle, and general exposure to stress. Work organization and conditions, such as workstation setup and lighting, also play a part in your overall health and comfort. Preventing health problems is a multifaceted task that requires careful attention to the way you use your body every hour of every day.

The most common health effects associated with using a computer are musculoskeletal discomfort and eye fatigue. We’ll discuss each area of concern below. For information about electric and magnetic emissions, look in the reference material that comes with your computer.

## Musculoskeletal discomfort

As with any activity that involves sitting for long periods of time, using a computer can make your muscles sore and stiff. To minimize these effects, set up your work environment carefully, using the guidelines that follow, and take frequent breaks to rest tired muscles. To make working with your computer more comfortable, allow enough space in your work area so that you can change position frequently and maintain a relaxed posture.

Another type of musculoskeletal concern is repetitive stress injuries (RSIs), also known as cumulative trauma disorders (CTDs). These problems can occur when a certain muscle or tendon is repeatedly overused and forced into an unnatural position. The exact causes of RSIs are not totally understood, but in addition to awkward posture, such factors as the amount of repetition, the force used in the activity, the individual's physiology, workplace stress level, and lifestyle may affect the likelihood of experiencing an RSI.

RSIs did not suddenly arise when computers were invented; tennis elbow and writer's cramp, for example, are two RSIs that have been with us for a long time. Although less common than other RSIs, one serious RSI discussed more often today is a wrist problem called carpal tunnel syndrome, which may be aggravated by improper use of computer keyboards. This nerve disorder results from excessive pressure on the median nerve as it passes through the wrist to the hand.

This section offers advice on setting up your work area to enhance your comfort while you use your computer. Since the effects of repetitive movements associated with using a computer can be compounded by those of other work and leisure activities to produce or aggravate physical problems, proper use of your computer system must be considered as just one element of a healthy lifestyle.

No one, of course, can guarantee that you won't have problems even when you follow the most expert advice on using computer equipment. You should always check with a qualified health specialist if muscle, joint, or eye problems occur.

## Eye fatigue

Eye fatigue can occur whenever the eyes are focused on a nearby object for a long time. This problem occurs because the eye muscles must work harder to view an object that's closer than about 20 feet (6 meters). Improper lighting can hasten the development of eye fatigue. Although eye fatigue is annoying, there's no evidence that it leads to permanent damage.

Whenever you're engaged in an activity that involves close-up work—such as reading a magazine, doing craft work, or using a computer—be sure to have sufficient glare-free lighting and give your eyes frequent rest breaks by looking up and focusing on distant objects. Remember to have your eyes examined regularly.

To prevent discomfort and eye fatigue:

- Arrange your work space so that the furniture is properly adjusted for you and doesn't contribute to an awkward working posture.
- Take frequent short breaks to give your muscles and eyes a chance to rest.

## Arranging your office

Here are some guidelines for adjusting the furniture in your office to accommodate your physical size and shape.

- An adjustable chair that provides firm, comfortable support is best. Adjust the height of the chair so your thighs are horizontal and your feet flat on the floor.

The back of the chair should support your lower back (lumbar region). Follow the manufacturer's instructions for adjusting the backrest to fit your body properly.

- When you use the computer keyboard, your shoulders should be relaxed. Your upper arm and forearm should form an approximate right angle, with your wrist and hand in roughly a straight line.

You may have to raise your chair so your forearms and hands are at the proper angle to the keyboard. If this makes it impossible to rest your feet flat on the floor, you can use a footrest with adjustable height and tilt to make up for any gap between the floor and your feet. Or you may lower the desktop to eliminate the need for a footrest. Another option is to use a desk with a keyboard tray that's lower than the regular work surface.

- Position your mouse at the same height as your keyboard. Allow adequate space to use the mouse comfortably.
- Arrange the computer so the top of the screen is slightly below your eye level when you're sitting at the keyboard. The best distance from your eyes to the screen is up to you, although most people seem to prefer 18 to 28 inches (45 to 70 cm).
- Position the computer to minimize glare and reflections on the screen from overhead lights and windows.

## Avoiding fatigue

- Change your seated position, stand up, or stretch whenever you start to feel tired. Frequent short breaks are helpful in reducing fatigue.
- Use a light touch when typing or using a mouse and keep your hands and fingers relaxed.

Some computer users may develop discomfort in their hands, wrists, or arms after intensive work without breaks. If you begin to develop chronic pain or discomfort in your hands, wrists, or arms, consult a qualified health specialist.

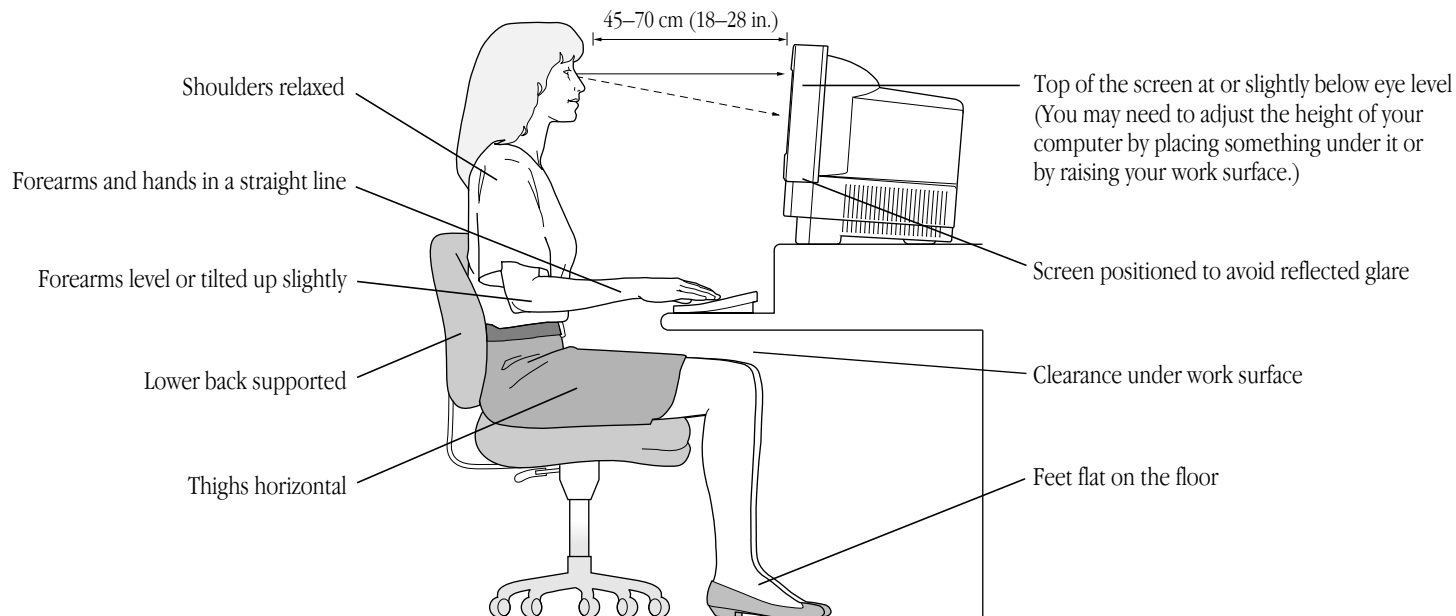



- Allow adequate workspace so that you can use your keyboard and mouse comfortably. Place papers or other items so you can view them easily while using your computer. A document stand may make reading papers more comfortable.
- Eye muscles must work harder to focus on nearby objects. Occasionally focus your eyes on a distant object, and blink often while you work.
- Clean your screen regularly. Keeping the screen clean helps reduce unwanted reflections.

## What's next?

You've completed setting up your computer. Continue with one of the following steps:

- If you are new to the Macintosh, continue with the next section, "Learning the Basics," to learn more about how to use your computer.
- Read "Turning the Computer On and Off," later in this book, for important information.
- Turn to "Your Computer at a Glance," later in this book, for an overview of major features of your computer and instructions on how to find out more about them.
- Read the "Special Features" section of this book for tips on how to use some of the important features of your computer.
- Start your own work. Consult the *Macintosh User's Guide* or this book if you have questions about your computer.

# Learning the Basics

The Macintosh comes with a tour and a tutorial to help you start using your computer as quickly as possible.

- The *Macintosh Basics* tour teaches the most basic skills you need to master before you can use your computer.
- The *Learning Macintosh* section of your *Macintosh User's Guide* is a tutorial that reinforces basic skills taught in the tour, and teaches a few additional skills you'll find helpful as you become more proficient.

Take the *Macintosh Basics* tour first.

## Taking the *Macintosh Basics* tour

Your *Macintosh Basics* tour can be found on the hard disk that's inside your computer.

To take the tour, follow these steps:

Make sure your computer is turned on. If the screen is dark, try adjusting the screen (as described in "Adjusting the Screen," later in this book) until you see the Macintosh desktop on your screen.

### 1. Use your hand to scoot the mouse along the table.

Hold the mouse as shown, cable pointing away from you. Slide it so that it stays in contact with the table. Don't press the mouse button. Watch the arrow (➤) on your screen to see if it moves when you move the mouse.

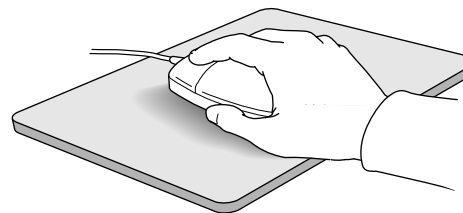

**2. Notice that the arrow (↔) moves in the direction you move the mouse.**

If the arrow doesn't move on the screen, make sure that the cable connecting the mouse to the keyboard is secure and that your mouse is positioned as shown in the picture. (Don't disconnect the cable while your computer is on; you could damage your equipment.)



You can move the arrow by moving the mouse.

**3. Move the mouse so that the arrow is over the picture labeled "Macintosh HD."**

Make sure the tip of the arrow is over the picture, not over the words "Macintosh HD."

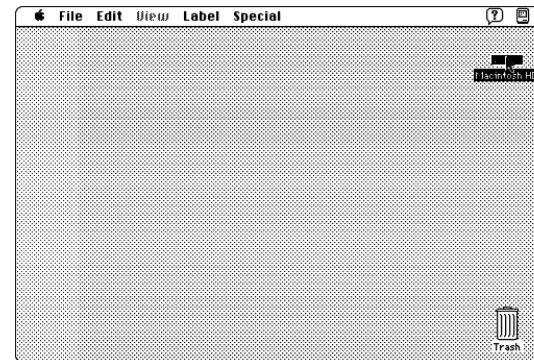

Put the tip of the arrow inside this picture.

❖ *By the way:* "Macintosh HD" stands for "Macintosh hard disk." ❖

*continues* ►

**4. Being careful not to move the mouse, click the mouse button twice in quick succession.**

Now your screen should look like the picture shown in this step. If it doesn't, try steps 3 and 4 again, paying special attention to the following:

- Make sure the tip of the arrow is touching the picture, not the words beneath it.
- Be sure to press the mouse button twice.
- Try pressing twice more quickly and be careful not to move the mouse while you press.

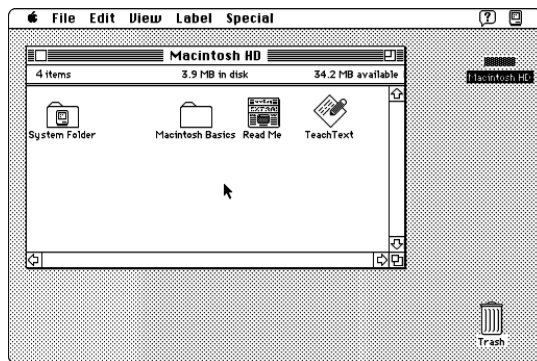

The items in this illustration may not exactly match those on your screen.

**5. Move the mouse to place the tip of the arrow inside the picture of the folder labeled “Macintosh Basics.”**

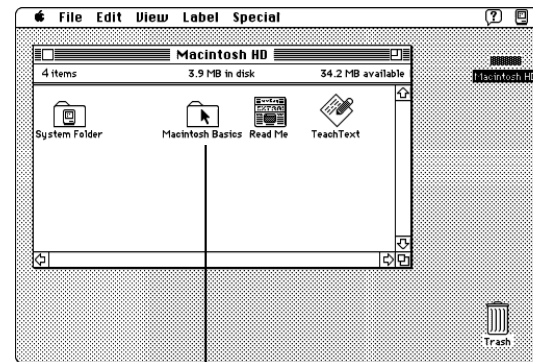

Put the tip of the arrow inside this picture.

Make sure the tip of the arrow is over the picture, not over the words “Macintosh Basics.”

6. Being careful not to move the mouse, press the mouse button twice in quick succession.

Now your screen should look like the following illustration:

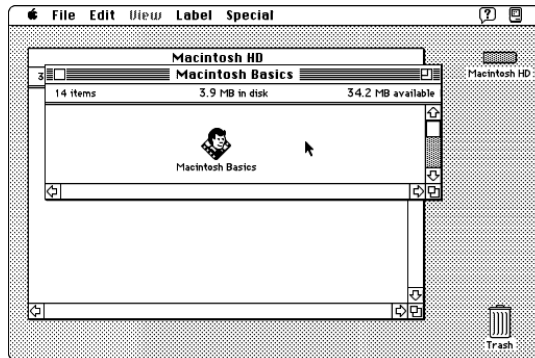

7. Move the mouse so that the arrow is over the picture of the man labeled "Macintosh Basics."

Make sure the tip of the arrow is over the picture of the man, not over the words "Macintosh Basics."

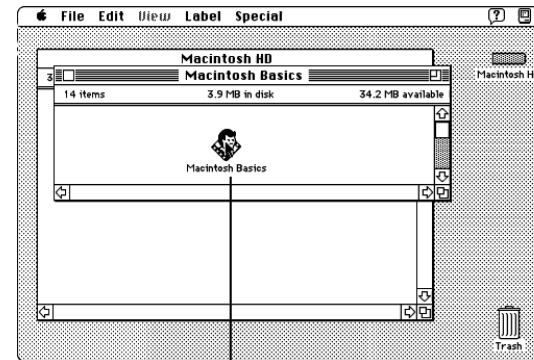

Put the tip of the arrow inside this picture.

*continues* ►

**8. Press the mouse button twice in quick succession.**

Now your screen should look like the following picture:

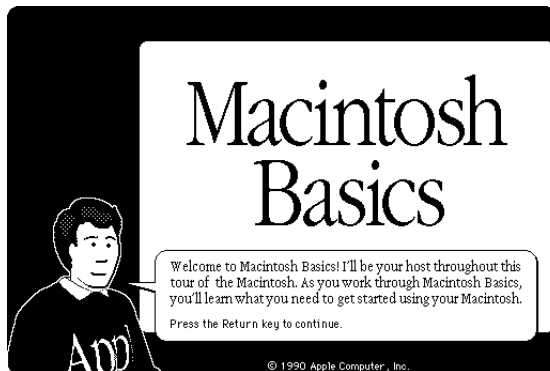

**9. Follow the instructions on the screen and work through the tour.**

When you finish the tour, continue with “Turning the Computer On and Off.” Read the rest of this book for information that can help you use your computer safely and efficiently. Then turn to the *Learning Macintosh* section of your *Macintosh User's Guide* and begin the learning exercises there.

## Turning the computer on and off

When you started up your computer for the first time, you pressed the main power switch at the back of the computer. From now on, you'll leave the main power switch on the back in the on position and shut down your computer with the keyboard or with a menu command. Both methods of shutting down are described in this section.

△ **Important:** Use the main power switch on the back of the computer to turn the computer completely off if you need to do any of the following:

- move the computer
- attach other equipment to the computer
- unplug the computer
- leave it for an extended period of time △

▲ **Warning:** If you turn off the computer by pressing the main power switch on the back of the computer *before* shutting it down by either of the methods described next, you will lose any work you haven't previously saved onto a disk, and you risk permanently losing open documents. ▲

## Shutting down the computer with the keyboard

To shut down the computer with the keyboard:

1. **Press the Power key (marked with the ◀ icon) on the keyboard.**

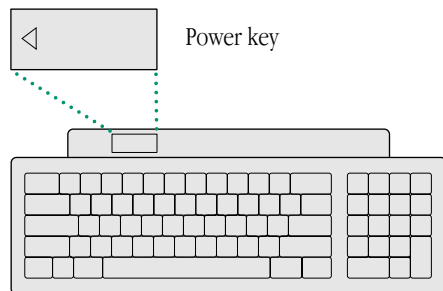

You see a message asking whether you want to shut down or continue working.

2. **Click Shut Down.**

You will be prompted to save your work, if you haven't already done so.

## Shutting down the computer with a menu command

- Use the mouse to choose the Shut Down command from the Special menu.



You will be prompted to save your work, if you haven't already done so.

## Turning on the computer

To turn on the computer after you have shut it down with either the menu command or the keyboard:

- Press the Power key (marked with the ◀ icon) on the keyboard. (Make sure that the main power switch on the back of the computer is in the "on" position. The top part of the switch, marked with an "I", should be pressed in.)

You'll find the Power key at the top of the keyboard. (Remember that the Power key works only if the main power switch on the back of the computer is turned on.)

# Your Computer at a Glance

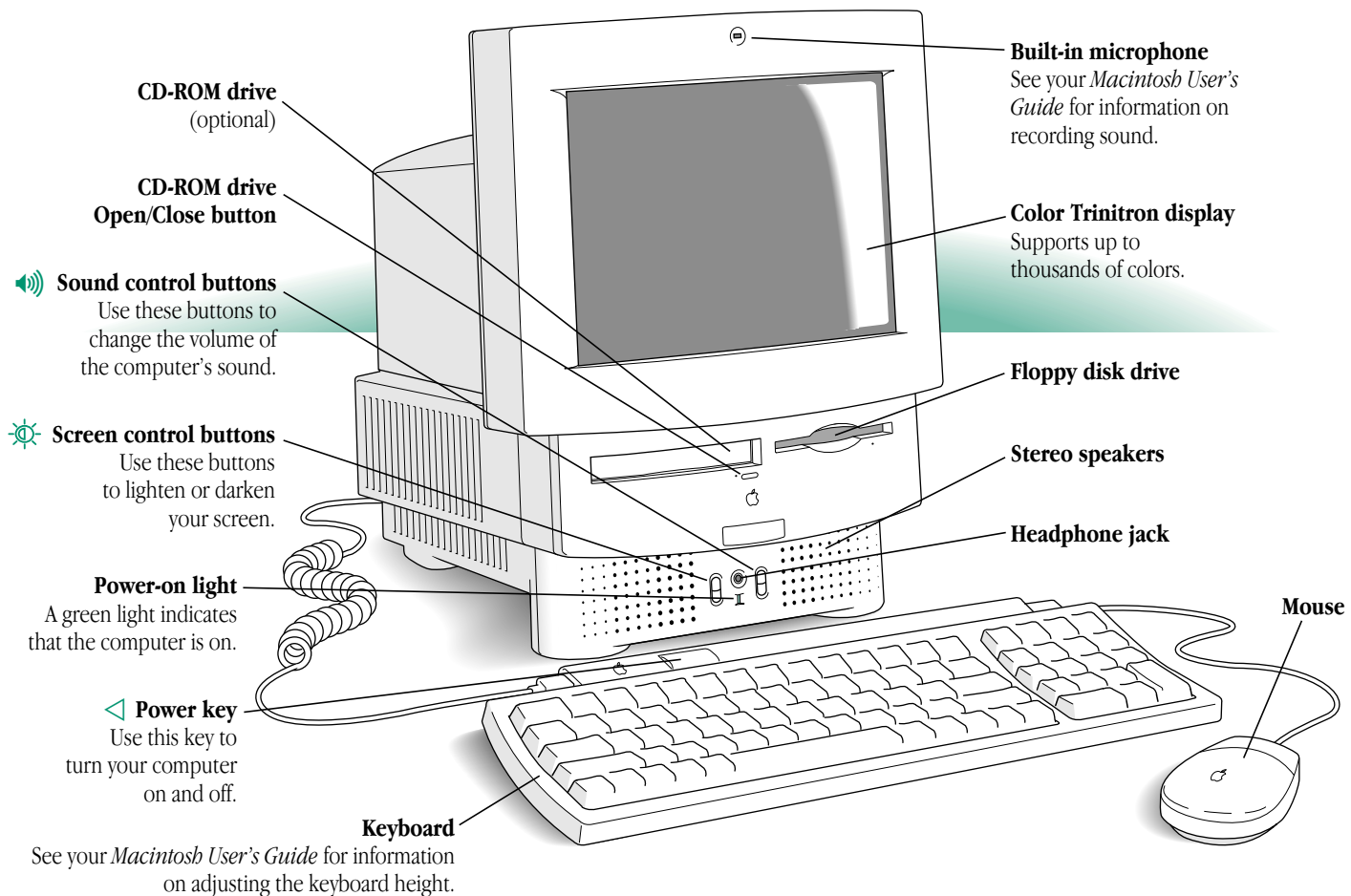



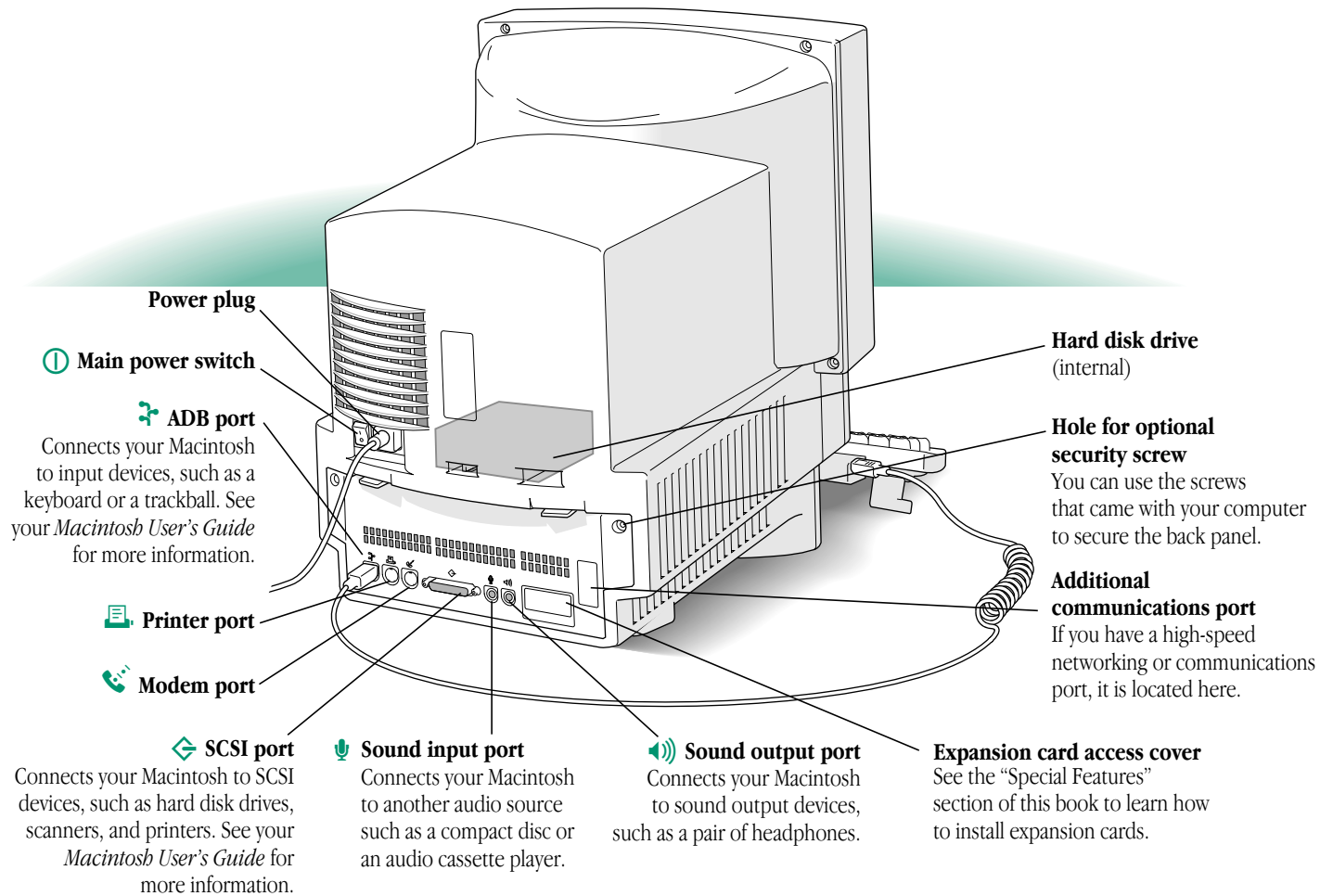

# Special Features

As you work with your Macintosh, you can consult your *Macintosh User's Guide* for answers to questions that you may have. This section provides information on features that are not covered in the user's guide.

The following topics are covered here:

- Adjusting the sound
- Adjusting the screen
- Disabling the buttons on the front of your computer
- Saving energy
- Using the built-in microphone
- Installing an expansion card
- Using memory efficiently
- Using a RAM disk for temporary storage
- Connecting to a network
- Using a modem
- Starting up your computer from an external hard disk

## Adjusting the sound

Many programs have the Macintosh make sounds when your attention is required or when you're giving a command or attempting an action that the computer cannot recognize or perform at that time.

There are two ways you can adjust the volume of the sounds that your Macintosh plays: by using the buttons on the front of the computer or by using the Sound control panel.

- ❖ *Note:* If you are playing an audio compact disc or an audio track on a CD-ROM disc, see the manual that came with your CD-ROM drive. ❖

## Using the sound control buttons on the computer

On the front of your Macintosh are two sets of buttons. The set on the right (marked with the ) is for sound control. To use these buttons to increase or decrease the volume of the sounds your Macintosh plays:

- Press the button on the top to make the sound louder.
- Press the button on the bottom to make the sound softer.

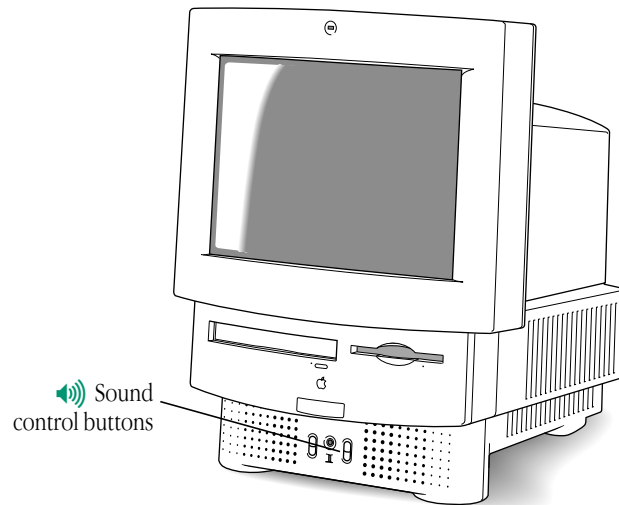

## Using the Sound control panel

You can also adjust the volume of the sounds your computer plays by using the Sound control panel. To use the Sound control panel:

1. **Choose Control Panels from the Apple () menu.**
2. **Open the Sound control panel.**
3. **Drag the slider of the Speaker Volume up or down to set the volume level.**

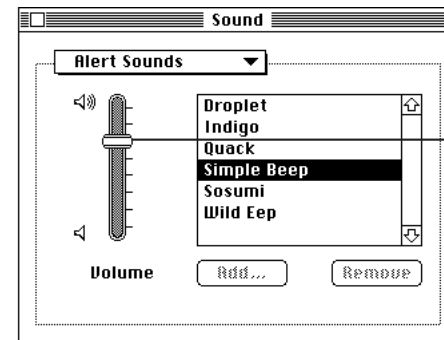

Drag the slider to adjust the volume.

After you release the mouse, the sound plays at the new volume.

## Adjusting the screen

You can adjust the level of light and dark on the screen of your built-in monitor (to change the contrast) either by using the buttons on the front of the computer or by using the Screen control panel.

### Using the screen contrast buttons on the computer

To use the screen contrast buttons (marked with the ☀ icon) on the computer:

- Press the button on the top to lighten your screen.
- Press the button on the bottom to darken your screen.

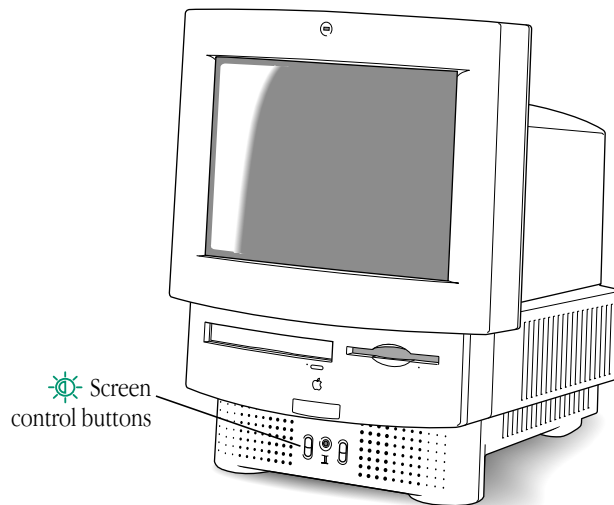

## Using the Screen control panel

You can also use the Screen control panel to adjust the lightness or darkness of your screen.

1. **Choose Control Panels from the Apple (🍏) menu.**
2. **Open the Screen control panel.**
3. **Drag the Screen Contrast slider to the right or left to adjust the level of light.**

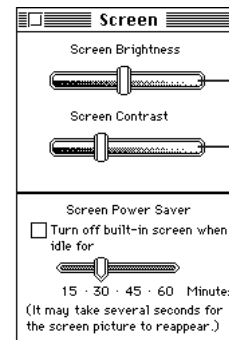

You should only use the Brightness control if your screen begins to appear dark after extended computer use (two to three years).

Drag the slider to adjust the contrast on your screen.

The screen changes as you drag the slider.

△ **Important:** Normally, use only the Screen Contrast control. Don't use the Screen Brightness control unless your screen appears dark even when the Screen Contrast slider is all the way to the right. △

## Disabling the buttons on the front of your computer

You can prevent other people from using the sound and screen contrast buttons on the front of your computer by using the Button Disabler control panel.

The Button Disabler control panel is already installed in your Control Panels folder. To use the Button Disabler control panel:

- 1. Pull down the Apple (🍏) menu and choose Control Panels.**
- 2. Double-click the Button Disabler control panel to open it.**
- 3. To turn off the contrast and volume buttons, click the Disable Buttons box until an “X” appears.**

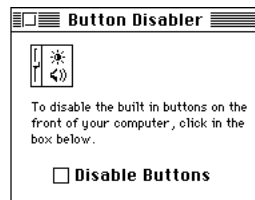

The buttons remain off until you turn them on again (by clicking the Disable Buttons box to remove the “X”).

- ❖ *By the way:* If you want to use a password to control access to the Button Disabler control panel, consider using At Ease, an application program available through Apple-authorized dealers. ❖

## Saving energy

Your Macintosh comes with software that reduces the amount of energy consumed when you are not using your computer. The software allows you to set the screen to turn off after a period of inactivity, the length of which you specify. The image on the screen reappears when you move the mouse or press any letter or number key on the keyboard. Because the screen needs to warm up, it will take up to 15 seconds for the picture to reappear.

Turning off the screen conserves energy. It also protects the screen from “burning in” images, which can occur if you leave an unchanging image on the screen for many hours or days.

**△ Important:** When the screen is off, the computer is still on. The green light on the front of the computer indicates that the computer is still on. △

To set the screen to turn off:

1. **Choose Control Panels from the Apple (Ⓜ) menu.**
2. **Open the Screen control panel.**

3. **Click the box labeled “Turn off built-in screen when idle.”**

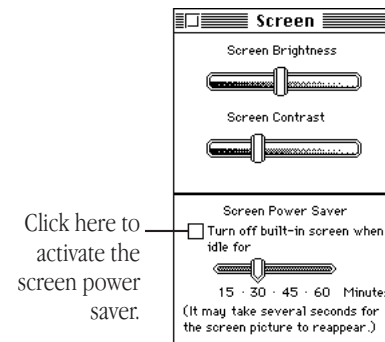

4. **Drag the slider to choose the number of minutes until the screen turns off.**

For example, if you choose 15 minutes, your screen will darken after your computer has been inactive for 15 minutes. The image will appear once again, exactly as you left it, if you move the mouse or press any letter or number on the keyboard.

Because the screen needs to warm up, it will take up to 15 seconds for the picture to reappear. During this warmup period, you will hear a beep.

## Using the built-in microphone

Your Macintosh comes with a built-in microphone to record live sounds. The microphone is highly sensitive. Once you've turned it on (which you do with a sound-recording program), it can pick up sounds within a range of several feet. See your *Macintosh User's Guide* for information on recording sound.

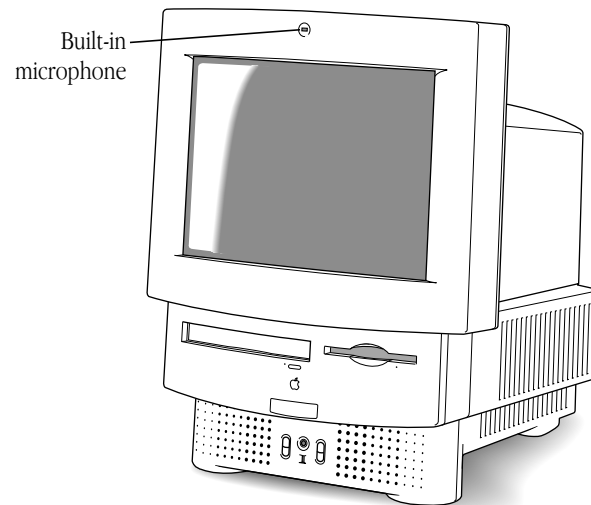

▲ **Warning:** Do not stick any small objects into the built-in microphone. Doing so may damage your equipment. ▲

## Installing an expansion card

The Macintosh comes with a slot inside called a processor-direct slot in which you can install a processor-direct expansion card for special purposes. Some expansion cards are designed so that you can install them yourself. Others can be installed only by an Apple-certified technician. To install a card, use the documentation supplied with the card you plan to install, or follow the instructions in this section.

▲ **Warning:** To avoid damaging your computer and expansion card, do not attempt to install any expansion card without first checking the documentation for that card. If the documentation specifies that an Apple-certified technician must install the card (usually because the installation requires special training or tools), consult the service and support information that came with your computer for instructions on how to contact an Apple-authorized service provider or Apple for service. If you attempt to install the card yourself, any damage you cause to your computer will not be covered by the limited warranty on your computer. If the card is not an Apple-labeled product, then check with an Apple-authorized dealer or service provider to see if you can install it yourself. ▲

To install an expansion card:

1. **Choose Shut Down from the Special menu or press the Power key on the keyboard.**
2. **Turn off the computer completely by pressing the main power switch at the back of the computer.**
3. **Unplug the cable that connects your keyboard to the computer.**
4. **If there are screws on either side of the back panel, remove them.**

5. **Place your thumbs on the two plastic tabs on the back panel of the computer.**

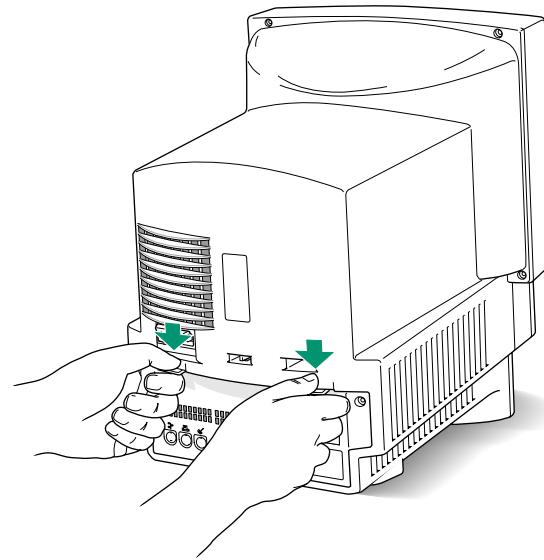

6. **Press down on the tabs and pull gently until the back panel opens.**



**7. Take the back panel off and set it aside.**

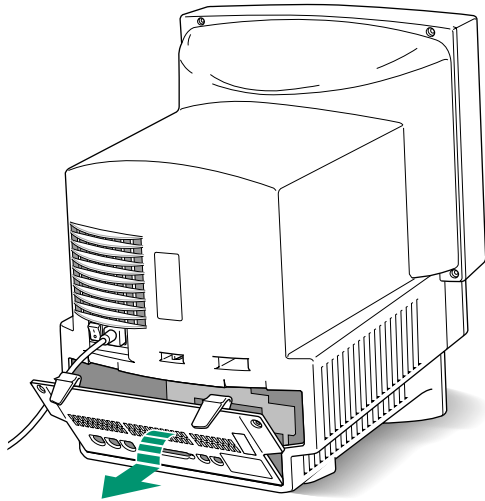

**8. Slide the logic board (the board that holds the components that make your computer work) partway out until you have access to the entire slot at the right side of the board.**

▲ **Warning:** Don't pull the board all the way out; this can damage your Macintosh. ▲

You'll need to hook your fingers around the little metal boxes to pull the logic board.

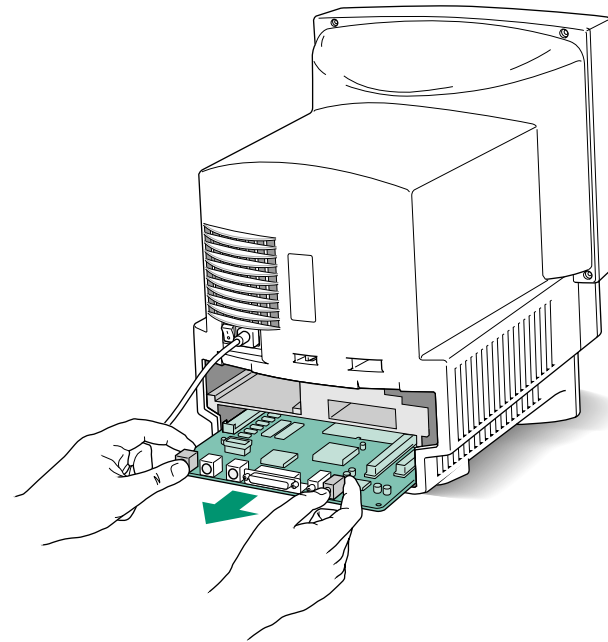

**9. Remove the processor-direct expansion card from its static-proof bag.**

Hold the card by its top edge to avoid touching the connector on the bottom of the card.

*continues* ►

**10. Align the card over the processor-direct expansion slot.**

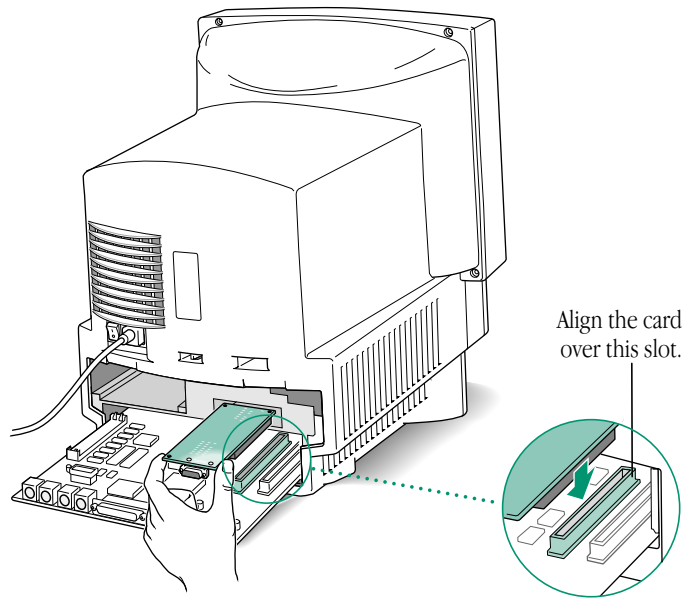

**11. Press down on the card until the connector is solidly in place.**

Don't force the card. If you meet resistance, pull the card out and try again. To see if the card is properly connected, lift it gently. If it resists and stays in place, it's connected.

**12. Slide the logic board back in.**

Push on the edge of the logic board until it is firmly in place.

**13. If there is a connector on the card that you just installed (for example, if you are installing an Apple IIe Card), remove the access cover on the back panel you removed earlier.**

Pinch together the plastic tabs on the access cover to remove it and pop it out. With the access cover off, you can use the port on the card you just installed.

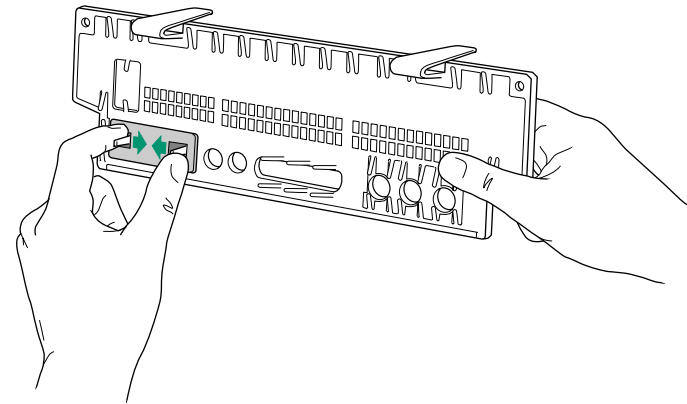

#### 14. Replace the back panel of the computer.

Slip the back cover over the prongs at the bottom edge of the back of the computer. If your back panel was held on by screws, replace them.

▲ **Warning:** Never turn on your computer unless all of its internal and external parts are in place. Operating the computer when it is open or missing parts can be dangerous, and can damage your computer. ▲

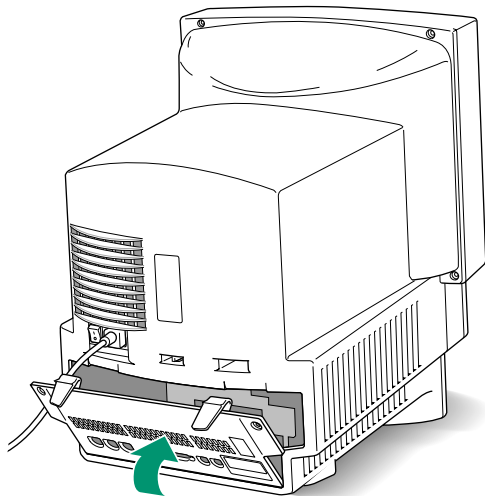

#### 15. Plug in your keyboard cable.

#### 16. Press the main power switch on the back of the computer.

Leave the switch on so you can use the Power key on the keyboard to turn your computer on and to shut it down without having to turn it completely off.

## Using memory efficiently

If you often see messages that there isn't enough memory, or if you have problems opening application programs, the tips in this section will help you use your computer's memory more efficiently.

- If you're using a RAM disk, make it smaller or turn it off entirely. (See the instructions in the next section about using a RAM disk for temporary storage.) The RAM disk reduces the amount of memory available to system software and application programs.
- Make the disk cache as small as possible. (See the instructions in your *Macintosh User's Guide*.)
- Turn off system extensions you don't need. For example, you may not need the QuickTime extension if you aren't using it. If your computer isn't connected to a network, you may not need the AppleShare extension. You'll find system extensions in the Extensions folder, which is inside the System Folder. You turn an extension off by dragging its icon out of the System Folder and restarting your computer.

## Using a RAM disk for temporary storage

For improved performance, you may want to set aside part of your random-access memory (RAM) to use as a temporary hard disk. Using a RAM disk improves performance because the computer can get data from a RAM disk much faster than from a hard disk or floppy disk.

You use a RAM disk exactly as you would use a hard disk or floppy disk, except that you save your work onto another disk before you shut down the computer.

To set up a RAM disk:

- 1. Choose Control Panels from the Apple () menu.**
- 2. Open the Memory control panel.**
- 3. Click On to turn on the RAM disk.**

Remember that the more RAM you allot as a RAM disk, the less you will have available for running application programs.

- 4. Drag the slider to indicate how much memory you want to use for a RAM disk.**

▲ **Warning:** If you use a RAM disk, be sure to save your work onto another disk before turning off your computer so that you won't lose your data. ▲

## Connecting to a network

If your computer has an optional Ethernet port, you can connect your Macintosh to any standard high-speed Ethernet network. You can connect your Macintosh to an existing Ethernet network that uses thin coax cables, 10BASE-T twisted pair cables, thick coax cables, or other standard cables.

To connect your Macintosh to a network, you may need to purchase an appropriate Apple Ethernet media adapter or other compatible media adapter. (Consult the service and support information that came with your computer for instructions on how to contact an Apple-authorized service provider or Apple for more information on Apple Ethernet media adapters.)

To use Ethernet, you need to change the network connection in the Network control panel. (For instructions on how to select a network connection and other information about using your Macintosh on a network, see “Using Your Macintosh on a Network” in your *Macintosh User’s Guide*.)

△ **Important:** Your Macintosh supports EtherTalk Phase 2 (AppleTalk Phase 2 Protocols for Ethernet networks) and TCP/IP (via MacTCP software). Non-Apple products that you can use to communicate over Ethernet using protocols are also available. Your Macintosh does not support EtherTalk Phase 1 (AppleTalk Phase 1 protocols for Ethernet networks). △

▲ **Caution:** The use of an Ethernet card will make your Macintosh a Class A computing device. ▲

## Using a modem

If your computer came with a modem in the optional communications port, your Macintosh can communicate with other computers over standard telephone lines. (For instructions on how to use your modem, see the manual that came with your modem.)

You can have an internal modem installed in the additional communications port by an Apple-authorized dealer (if the port isn't already in use). You can also purchase an external modem to connect to the modem port on the back of your computer.

## Starting up your computer from an external hard disk

To start up your Macintosh from an external hard disk, the hard disk must contain a System Folder, and the System Folder must contain a System Enabler for your specific model of Macintosh. (A System Enabler file contains software necessary to start up a specific Macintosh model.)

If you are unable to start up your Macintosh from an external disk, the appropriate System Enabler file may be missing from that disk. Use the Installer program on the *Install Me First* disk that came with your computer to install system software on the external disk. If your computer came with a CD-ROM disc titled *CD Install Me First*, the software you need is on the CD-ROM disc.

# Installing System Software

If your Macintosh came with a CD-ROM drive, then you also received a CD-ROM disc labeled *CD Install Me First*. This disc takes the place of multiple floppy disks, providing one permanent backup source for important software. In addition, the CD simplifies the process of reinstalling system software (should that ever become necessary).

This section describes the contents of the *CD Install Me First* disc and explains how you can

- Use the *CD Install Me First* disc as your startup device
- Reinstall system software
- Create a set of floppy disks containing a copy of the system software from your CD
- Create a copy of the *Macintosh Basics* tour

Your Macintosh came with all the necessary system software and CD-ROM setup software installed and ready to use. Unless a problem develops later, you don't need to use the *CD Install Me First* disc to reinstall the software.

If you need to reinstall Macintosh system software, use the instructions here rather than those contained in the *Macintosh User's Guide*.

If you need to reinstall CD-ROM software, see the manual that came with your CD-ROM drive.

△ **Important:** Do not use the *CD Install Me First* disc as an everyday startup device. Use it instead as the backup for your system software files. △

## Using the CD as your startup device

The procedure for starting from the *CD Install Me First* disc varies depending on the condition of the system software on your hard disk. To find out which procedure to use, you must turn on your Macintosh.

### If you see a blinking question mark on your screen

The blinking question mark means your Macintosh is unable to find usable system software on your hard disk.



△ **Important:** Your computer may be trying to restart from a CD-ROM disc other than *CD Install Me First*. Press the Open/Close button on the front of the computer to open the tray, and remove the CD-ROM disc. Push the tray in, or press the Open/Close button, to close the tray. Restart your computer. If you still see the blinking question mark, follow the instructions below. △

**1. Press the Open/Close button of the CD-ROM drive to open the CD-ROM tray.**

**2. Place the *CD Install Me First* disc into the tray, with the disc label facing up.**

Make sure the disc is lying flat in the tray.

**3. Push the tray in, or press the Open/Close button, to close the tray.**

Your Macintosh recognizes the CD as a startup disk, and in a few seconds the desktop below appears.

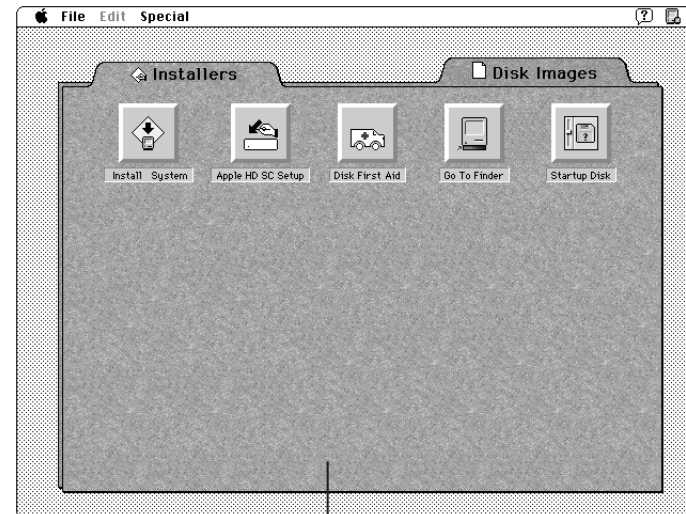

Although some parts of your screen may look different, the instructions in this section are correct.



## If you see the Macintosh desktop

1. Press the Open/Close button of the CD-ROM drive to open the CD-ROM tray.
2. Place the *CD Install Me First* disc into the tray, with the disc label facing up.

Make sure the disc is lying flat in the tray.

3. Push the tray in, or press the Open/Close button, to close the tray.
4. Choose Restart from the Special menu.
5. Press and hold down the  $\text{⌘}$ , Shift, Option, and Delete keys.

6. As soon as the smiling Macintosh appears on your screen, release the keys.

Your Macintosh recognizes the CD as a startup disk, and in a few seconds the desktop below appears.

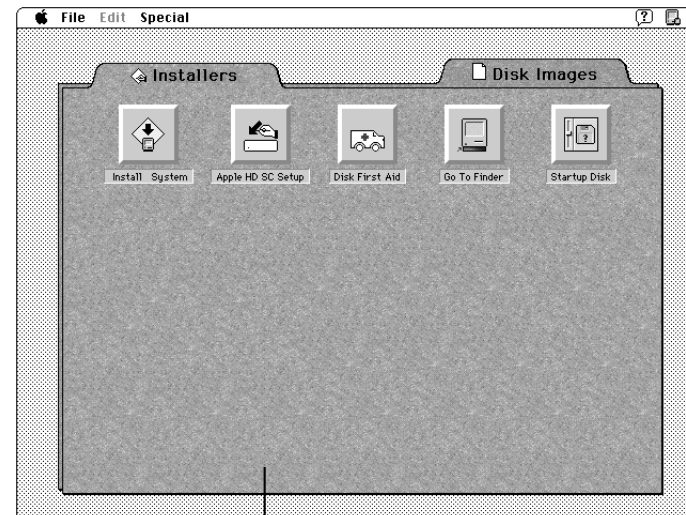

Although some parts of your screen may look different, the instructions in this section are correct.

## Reinstalling system software

Your Macintosh came with all the necessary system software installed and ready to use. Occasionally, however, system software can develop problems and need to be replaced.

Before you begin, you must start your Macintosh from the *CD Install Me First* disc. For instructions, see “Using the CD as Your Startup Device” earlier in this book.

### 1. On the desktop, click **Install System**.

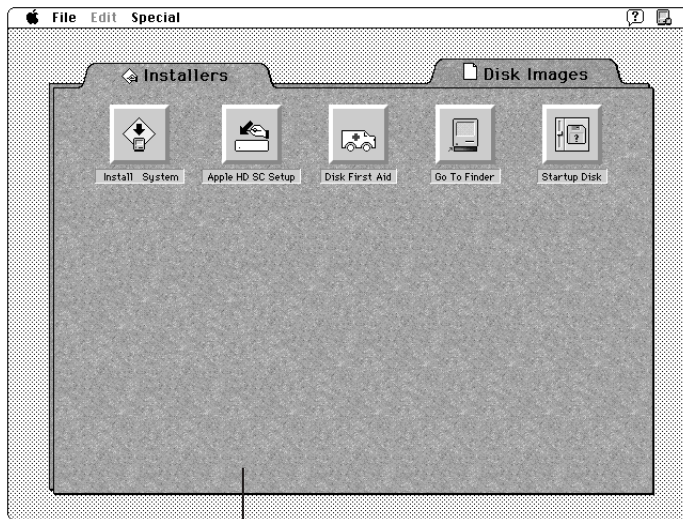

Although some parts of your screen may look different, the instructions in this section are correct.

### 2. In the Welcome dialog box that appears, click **OK**.



Click OK.

### 3. In the Installer dialog box, click Install.

The Installer identifies your Macintosh and lists the software recommended for it.

When you're ready to begin, click Install.

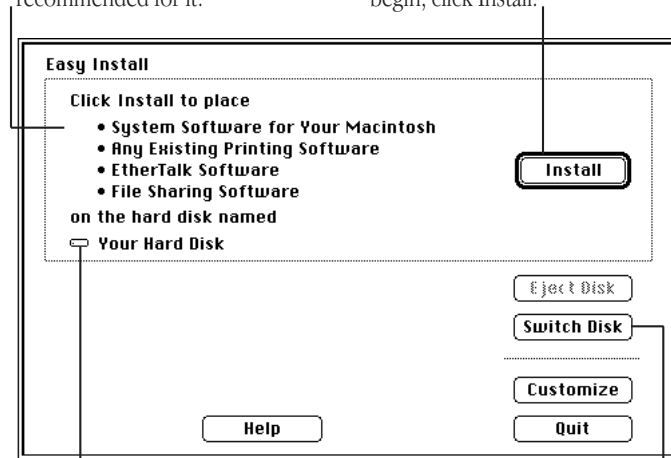

Make sure the disk named here is the one on which you want to install the system software.

To switch to a different disk, click Switch Disk.

The Easy Install status box appears and keeps you informed of progress during installation.

### 4. When you see a message reporting that the installation was successful, click Quit.

That's it! You've installed Macintosh system software on your startup disk.

## Custom installations

The Installer has a "custom" feature that allows you to choose specific items from a list and have them installed. If you click the Customize button in the Installer dialog box, you'll see the list. Hold down the Shift key and click the items you want. Then click Install.

If you use Easy Install, you don't need a custom installation.

## Creating a set of backup floppy disks

You can copy the Macintosh system software from the *CD Install Me First* disc to floppy disks. To copy all of the software, you may need as many as ten 1.4 MB floppy disks.

Before you begin, you must start your Macintosh from the *CD Install Me First* disc. For instructions, see “Using the CD as Your Startup Device” earlier in this book.

### 1. On the desktop, click the Disk Images tab.

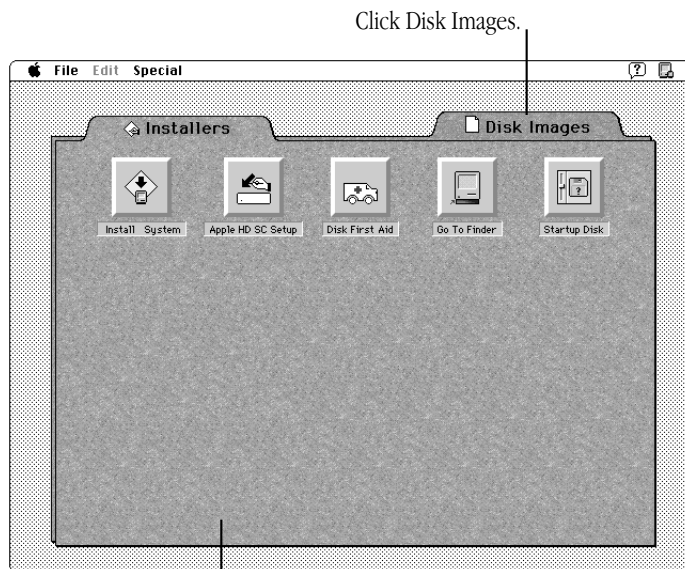

Although some parts of your screen may look different, the instructions in this book are correct.

### 2. Click a button to select the disk image you want to copy.

Each disk image contains all the software you need to create a backup floppy disk.

To copy these disk images, you need a 1.4 MB floppy disk for each one.

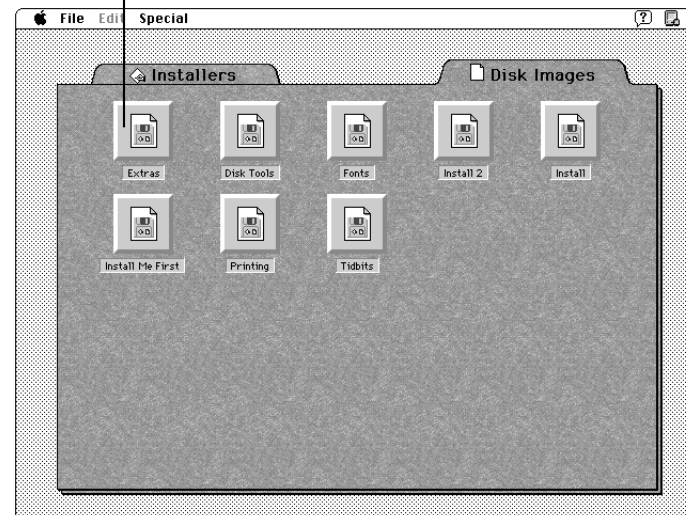

**3. In the dialog box that appears, click Make A Copy.**

You may have to wait a few seconds while the image file is loaded.

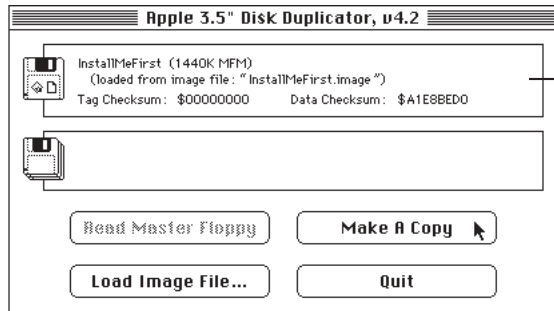

You can ignore the information in this box.

**4. When you see a message telling you to insert a disk, insert a floppy disk.**

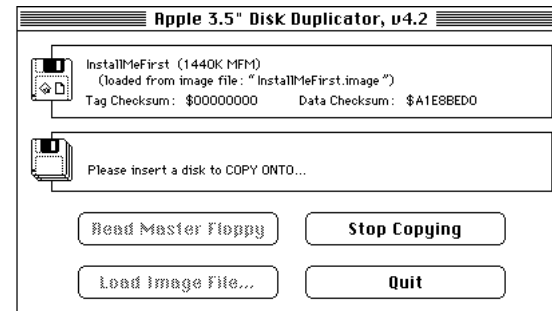

If an alert box appears asking whether you want to replace the contents of the disk, click Duplicate.

**5. When you see a message telling you that the disk was duplicated successfully, click Quit.**

**6. Repeat steps 2 through 5 for each disk image until you have copied all of the disk image files.**

If you don't need all of the files, pick just the ones you want.

That's all there is to it. Store the backup disks in a safe place.

## Copying the *Macintosh Basics* tour

*Macintosh Basics* is a hands-on tour of the Macintosh desktop that teaches important skills for using the computer. Your Macintosh came with the tour already installed on your hard disk, but if you need another copy, you can get one from the *CD Install Me First* disc.

△ **Important:** Do not put the *CD Install Me First* disc into the CD-ROM drive until after you start up your computer. △

1. **Press the Open/Close button of the CD-ROM drive to open the CD-ROM tray.**
2. **Place the *CD Install Me First* disc into the tray, with the disc label facing up.**

Make sure the disc is lying flat in the tray.

3. **Push the tray in, or press the Open/Close button, to close the tray.**

If necessary, open the *CD Install Me First* disc icon. A window appears, showing the contents of the disc.

4. **Open the Applications folder.**

A window appears, showing the contents of the folder.

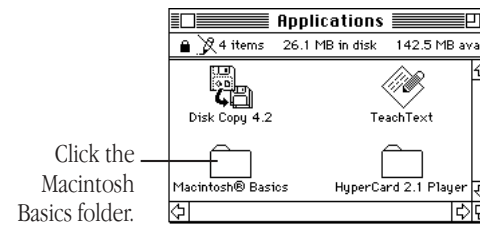

5. **Click the Macintosh Basics folder to select it and drag it to your hard disk.**

You now have a copy of the tour on your hard disk.

## The Apple Publishing System

This Apple manual was written, edited, and produced on a desktop publishing system using Apple Macintosh computers and QuarkXPress. Technical illustrations were drawn with Adobe Illustrator; screen shots were created and modified with system software, Exposure Pro, Aldus SuperPaint, and Adobe Photoshop. Proof pages were created on Apple LaserWriter printers and on QMS and Tektronix color printers. Final pages were output directly to separated film on a PostScript™-driven imagesetter.

Text type is Apple's corporate font, a condensed version of Garamond. Ornaments are custom symbols designed for Apple Computer.

PostScript, the LaserWriter page-description language, was developed by Adobe Systems Incorporated.

## Free Manuals Download Website

<http://myh66.com>

<http://usermanuals.us>

<http://www.somanuals.com>

<http://www.4manuals.cc>

<http://www.manual-lib.com>

<http://www.404manual.com>

<http://www.luxmanual.com>

<http://aubethermostatmanual.com>

Golf course search by state

<http://golfingnear.com>

Email search by domain

<http://emailbydomain.com>

Auto manuals search

<http://auto.somanuals.com>

TV manuals search

<http://tv.somanuals.com>