

PROXIMA®  
**PRO AV 9310**  
**PRO AV 9310L (Lens less)**

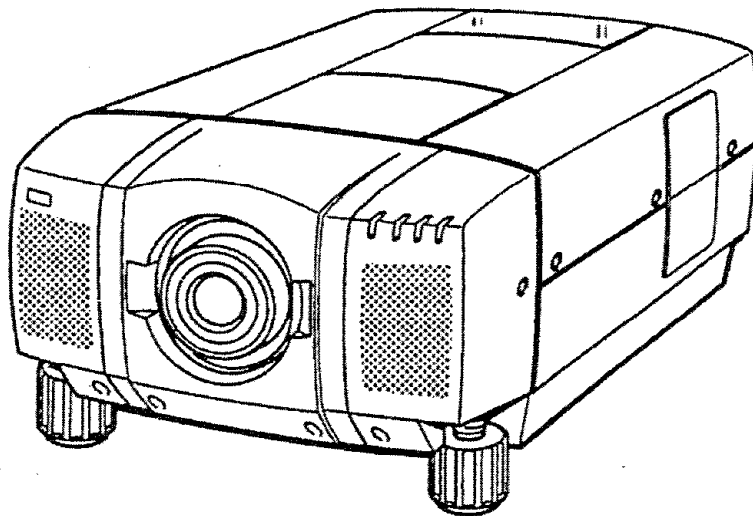

English **US**

English **G**

Deutsch **D**

Français **F**

Italiano **I**

Español **E**

- PRESENTATIONS
- WORKING SESSIONS
- TRAINING
- MULTIMEDIA
- ANIMATION
- VIDEO

## INFORMATION TO THE USER

NOTE: This equipment has been tested and found to comply with the limits for a Class A digital device, pursuant to Part 15 of the FCC Rules. These limits are designed to provide reasonable protection against harmful interference when the equipment is operated in a commercial environment. This equipment generates uses, and can radiate radio frequency energy and, if not installed and used in accordance with the user guide, may cause harmful interference to radio communications. Operation of this equipment in a residential area is likely to cause harmful interference in which case the user will be required to correct the interference at his own expense.

## TO THE OWNER

**USA** As the owner of a PRO AV 9310, you are probably eager to try out your new projector. Before you do, we suggest that you spend a little time reading this guide to familiarize yourself with the operating procedures, so that you will receive maximum satisfaction from the many features included in your new projector.

This user's guide will acquaint you with your projector's features. Reading it will help us too. Through the years, we have found that many service requests were not caused by problems with our projectors. They were caused by problems that could have been prevented, if the owner had followed the instructions in the guide.

You can often correct operating problems yourself. If your projector fails to work properly, see "TROUBLESHOOTING" section on pages 52 ~ 53 and try the solutions marked for each problem.

## SAFETY PRECAUTIONS

### WARNING:

**TO REDUCE THE RISK OF FIRE OR ELECTRIC SHOCK, DO NOT EXPOSE THIS APPLIANCE TO RAIN OR MOISTURE.**





This Projector has a grounding-type AC line plug. This is a safety feature to be sure that the plug will fit the power outlet. Do not try to defeat this safety feature.

Intense light source. Do not stare directly into the projection lens as possible eye damage could result. Be especially careful that children do not stare directly into the beam.

This Projector should be set in the way indicated. Never hang the projector, or fall down on its side. It may result in fire hazard.

If the Projector will not be used for an extended time, unplug the Projector from the power outlet.

**READ AND KEEP THIS USER'S GUIDE FOR LATER USE.**

	<b>CAUTION</b> <b>RISK OF ELECTRIC SHOCK</b> <b>DO NOT OPEN</b>	
<b>CAUTION: TO REDUCE THE RISK OF ELECTRIC SHOCK, DO NOT REMOVE COVER (OR BACK). NO USER-SERVICEABLE PARTS INSIDE. REFER SERVICING TO QUALIFIED SERVICE PERSONNEL.</b>		
 THIS SYMBOL INDICATES THAT DANGEROUS VOLTAGE CONSTITUTING A RISK OF ELECTRIC SHOCK IS PRESENT WITHIN THIS UNIT.	 THIS SYMBOL INDICATES THAT THERE ARE IMPORTANT OPERATING AND MAINTENANCE INSTRUCTIONS IN THE USER'S GUIDE WITH THIS UNIT.	

# IMPORTANT SAFETY INSTRUCTIONS

All the safety and operating instructions should be read before the product is operated.

Read all of the instructions given here and retain them for later use. Unplug this projector from AC power supply before cleaning. Do not use liquid or aerosol cleaners. Use a damp cloth for cleaning.

Do not use attachments not recommended by the manufacturer as they may cause hazards.

Do not place this projector on an unstable cart, stand, or table. The projector may fall, causing serious injury to a child or adult, and serious damage to the projector. Use only with a cart or stand recommended by the manufacturer, or sold with the projector. Wall or shelf mounting should follow the manufacturer's instructions, and should use a mounting kit approved by the manufacturer.

Do not expose this unit to rain or use near water... for example, in a wet basement, near a swimming pool, etc...

Slots and openings in the back and bottom of the cabinet are provided for ventilation, to insure reliable operation of the equipment and to protect it from overheating.

The openings should never be covered with cloth or other material, and the bottom opening should not be blocked by the projector on a bed, sofa, rug, or other similar surface. This projector should never be placed near or over a radiator or heat register.

This projector should not be placed in a built-in installation such as a bookcase unless proper ventilation is provided.

This projector should be operated only from the type of power source indicated on the marking label. If you are not sure of the type of power supplied, consult your authorized dealer or local power company.

Do not overload wall outlets and extension cords as this can result in fire or electric shock. Do not allow anything to rest on the power cord. Do not locate this projector where the cord may be damaged by persons walking on it.

Never push objects of any kind into this projector through cabinet slots as they may touch dangerous voltage points or short out parts that could result in a fire or electric shock. Never spill liquid of any kind on the projector.

Do not attempt to service this projector yourself as opening or removing covers may expose you to dangerous voltage or other hazards. Refer all servicing to qualified service personnel.

Unplug this projector from wall outlet and refer servicing to qualified service personnel under the following conditions:

- When the power cord or plug is damaged or frayed.
- If liquid has been spilled into the projector.
- If the projector has been exposed to rain or water.
- If the projector does not operate normally by following the operating instructions. Adjust only those controls that are covered by the operating instructions as improper adjustment of other controls may result in damage and will often require extensive work by a qualified technician to restore the projector to normal operation.
- If the projector has been dropped or the cabinet has been damaged.
- When the projector exhibits a distinct change in performance-this indicates a need for service.

When replacement parts are required, be sure the service technician has used replacement parts specified by the manufacturer that have the same characteristics as the original part. Unauthorized substitutions may result in fire, electric shock, or injury to persons.

Upon completion of any service or repairs to this projector, ask the service technician to perform routine safety checks to determine that the projector is in safe operating condition.

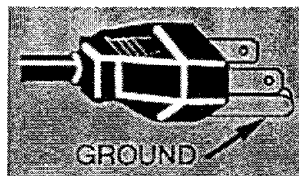

This projector is equipped with a grounding type AC line plug. Should you be unable to insert the plug into the outlet, contact your electrician. Do not defeat the safety purpose of this grounding type plug.

Follow all warnings and instructions marked on the projectors.

For added protection to the projector during a lightning storm, or when it is left unattended and unused for long periods of time, unplug it from the wall outlet. This will prevent damage due to lightning and powerline surges.

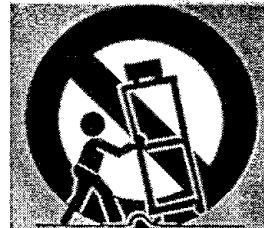

An appliance and cart combination should be moved with care. Quick stops, excessive force, and uneven surfaces may cause the appliance and cart combination to overturn.

If the projector is to be built into a compartment or similarly enclosed, the minimum distances must be maintained. Do not cover the ventilation slot on the projector. Heat build-up can reduce the service life of your projector, and can also be dangerous.

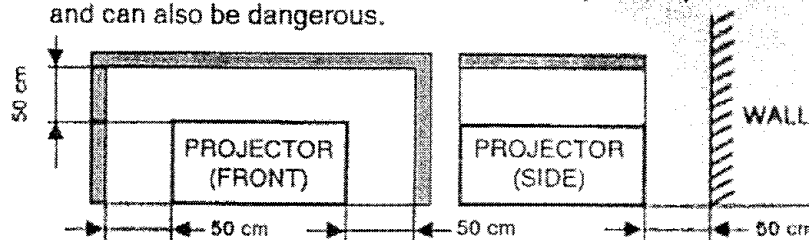

# TABLE OF CONTENTS

	PAGE		PAGE
<b>INTRODUCTION</b>	5	FOCUS ADJUSTMENT	30
COMPATIBILITY	5	LENS SHIFT FUNCTION	30
IMAGE RESOLUTION	5	NORMAL PICTURE FUNCTION	30
UNPACKING THE PROJECTOR	5	NO SHOW FUNCTION	30
TRADEMARKS	5	P-TIMER FUNCTION	30
<b>POWER REQUIREMENT</b>	5	FREEZE PICTURE FUNCTION	30
<b>DESCRIPTION</b>	6	AUTO IMAGE FUNCTION	30
<b>SETTING-UP THE PROJECTOR</b>	7-8	MENU OPERATION	31-47
POSITIONING	7	MODE SELECT	31
ROOM LIGHT	7	SOUND ADJUSTMENT	32
LEVELING AND ELEVATING ADJUSTMENTS	7	LANGUAGE ADJUSTMENT	32
VENTILATION	8	MENU EXIT	33
<b>MOVING THE PROJECTOR</b>	8	COLOR SYSTEM SELECT	33
<b>CONNECTING THE PROJECTOR</b>	9-16	VIDEO SOURCE ADJUSTMENT	34
CONNECTING THE COMPUTER	9-14	PICTURE IMAGE ADJUSTMENT	35
Connecting an IBM-compatible desktop computer	11	PICTURE SCREEN ADJUSTMENT	36
Connecting a Macintosh desktop computer	12	COMPUTER SYSTEM SELECT	37
Connecting an IBM-compatible laptop computer	13	COMPATIBLE COMPUTER SPECIFICATION	38
Connecting a Macintosh PowerBook computer	14	AUTO IMAGE FUNCTION	39
CONNECTING THE VIDEO EQUIPMENT	15-16	PICTURE IMAGE ADJUSTMENT	40
<b>OPERATION OF CONTROLS</b>	17-20	PICTURE POSITION ADJUSTMENT	41
TOP OF THE PROJECTOR	17-18	PC ADJUSTMENT	42-45
SIDE OF THE PROJECTOR	19-20	PICTURE SCREEN ADJUSTMENT	46
<b>OPERATION OF REMOTE CONTROL</b>	21-25	OTHER FUNCTION SETTING	47-49
WIRELESS REMOTE CONTROL UNIT	21-23	BLUE BACK	47-48
WIRELESS/WIRED REMOTE CONTROL UNIT	24-25	DISPLAY	47-48
<b>CONTROL THE PROJECTOR</b>	26-28	REVERSE T/B	47-48
DIRECT OPERATION	26	REVERSE L/R	47-48
MENU OPERATION	27-28	SPLIT WIPE	47-48
<b>USING THE PROJECTOR</b>	29-49	LAMP AGE	49
TO TURN ON THE PROJECTOR	29	<b>AIR FILTER CARE AND CLEANING</b>	50
TO TURN OFF THE PROJECTOR	29	<b>TEMPERATURE WARNING INDICATORS</b>	50
DIRECT OPERATION	29	<b>LAMP REPLACEMENT</b>	51
MODE SELECT	29	<b>CLEANING THE LENS</b>	52
SOUND VOLUME ADJUSTMENT	30	<b>TROUBLESHOOTING</b>	52-53
SOUND MUTE FUNCTION	30	<b>TECHNICAL SPECIFICATIONS</b>	54
ZOOM ADJUSTMENT	30		

# INTRODUCTION

The PRO AV 9310 is a multimedia projector that combines powerful and sophisticated features with easy-to-use, intuitive controls. Built-in multimedia features include audio, a palette of 16.77 million colors and active matrix liquid crystal display technology. The projector is ideal for high-performance business, training and imaging applications that demand exceptional color quality.

## COMPATIBILITY

The projector is compatible with many different types of personal computers and video devices, including:

- IBM-compatible computers, including laptops, up to 1280 × 1024 resolution.
- Apple Macintosh and PowerBook computers up to 1280 × 1024 resolution.
- Various VCRs, video disc players, video cameras, DVD players, satellite TV tuners or other AV equipment using any of the worldwide video standards, including NTSC, NTSC4.43, PAL, PAL-M, PAL-N and SECAM.

## IMAGE RESOLUTION

The resolution of the projector's projected image is 1024 × 768. The projector displays computer images just as they appear on your computer's monitor. Screen resolutions between 1024 × 768 and 1280 × 1024 are compressed to 1024 × 768. The projector cannot display screen resolutions above 1280 × 1024. If your computer's screen resolution is higher than 1280 × 1024, reset it to a lower resolution before you connect the projector.

## UNPACKING THE PROJECTOR

The projector comes with the parts shown listed below. Check to find all the parts are included. If any parts are missing, contact an authorized dealer or service station.

- User's Guide.
- AC Power Cord.
- Remote Control Transmitter Unit (Two Types) and batteries.
- Lens Cover.
- Protective Dust Cover.
- I/A Cable.
- VGA/MAC Adapter.
- Mouse Cable for PS/2 port.
- Mouse Cable for serial port.
- Mouse Cable for ADB port.

## TRADEMARKS

- Apple, Macintosh, and PowerBook are trademarks or registered trademarks of Apple Computer, Inc.
- IBM and PS/2 are trademarks or registered trademarks of International Business Machines, Inc.
- Proxima is a registered trademark of Proxima Corporation.
- PRO AV is a trademark of Proxima Corporation.
- Other trademarks are the property of their respective owners.

# POWER REQUIREMENTS

Your projector uses nominal input voltages of 100-120 VAC or 200-240 VAC. The projector automatically selects the correct input voltage. The projector is designed to work with single-phase power systems having a grounded neutral conductor. To reduce the risk of electrical shock, do not plug into any other type of power system.

Consult your authorized dealer or service station if you are not sure what type of power is supplied to your building.

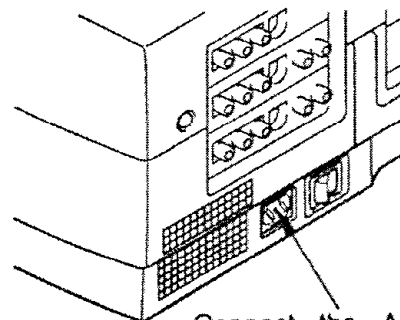

Connect the AC power supply cord (supplied) to the projector.

# DESCRIPTION

## FRONT

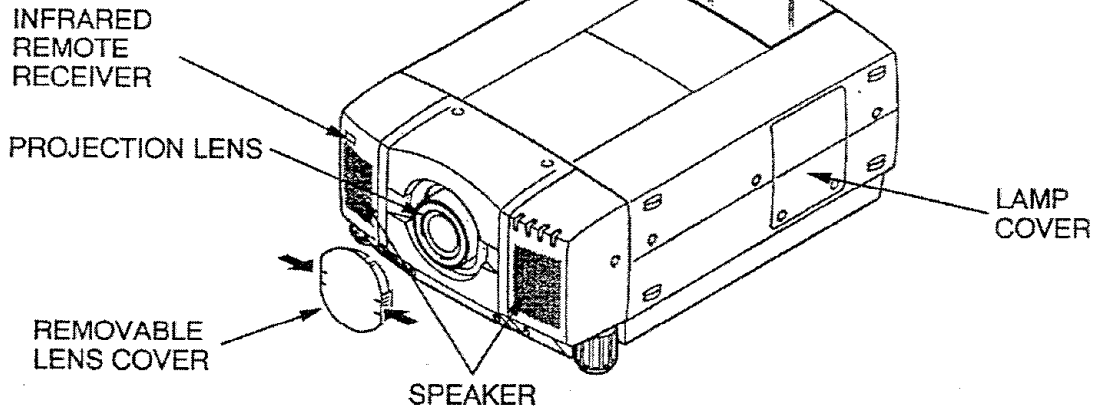

USA

## REAR

### EXHAUST VENT



#### CAUTION HOT AIR!

Air blown from the exhaust vent is hot. Observe the following when handling your projector or choosing a location to install it.

- Keep heat-sensitive objects away from the exhaust port.
- If you set the projector on top of a metallic surface, the surface will become hot because of the hot air exhaust. Be careful when handling.
- Do not touch the cabinet near to the exhaust vent area, and especially screws and metallic parts. These parts will become hot while the projector is used.

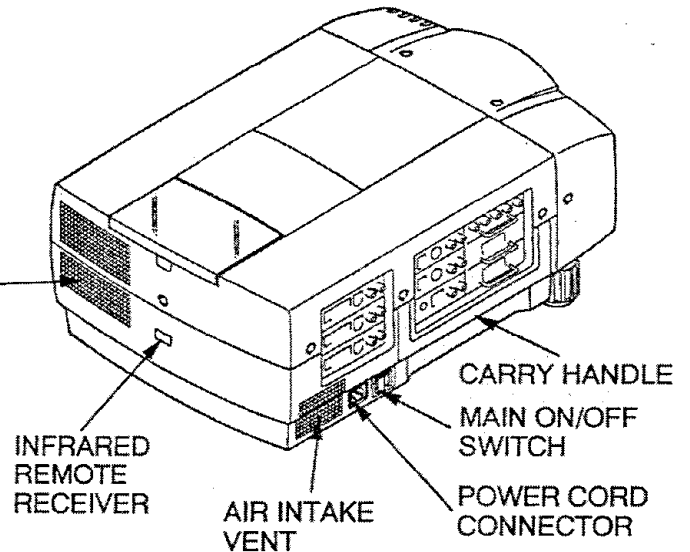

## BOTTOM

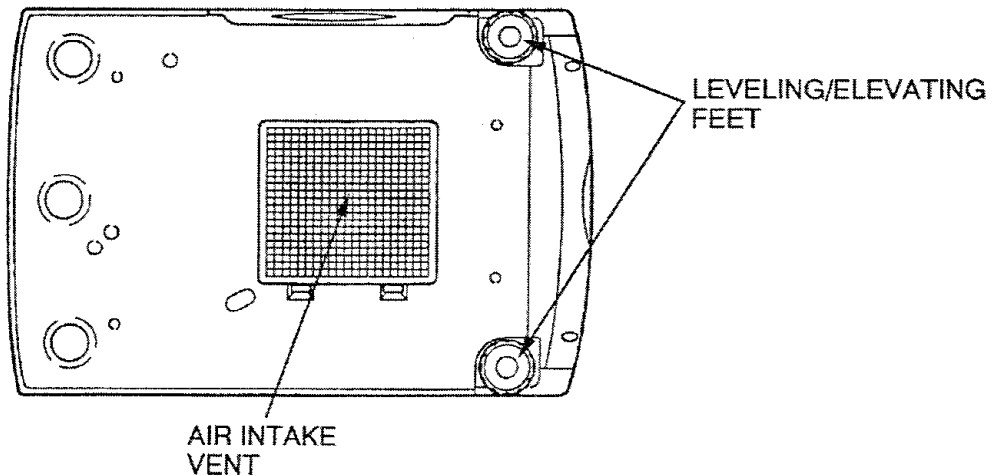

# SETTING-UP THE PROJECTOR

## POSITIONING:

- This projector is basically designed to project on a flat projection surface.
- This projector can be focused from 3.6' (1.1m) ~ 73.2' (22.3m).
- Refer to the figure below as an example when positioning the projector to the screen.



**THIS PROJECTOR SHOULD NEVER BE SET IN THE WAY INDICATED. NEVER HANG THE PROJECTOR UPSIDE DOWN. IT MAY RESULT IN FIRE HAZARD.**

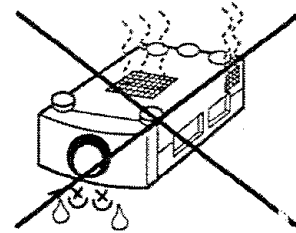

## ROOM LIGHT

The projector should be placed in a room with limited light. Picture quality will be directly affected by lighting conditions.

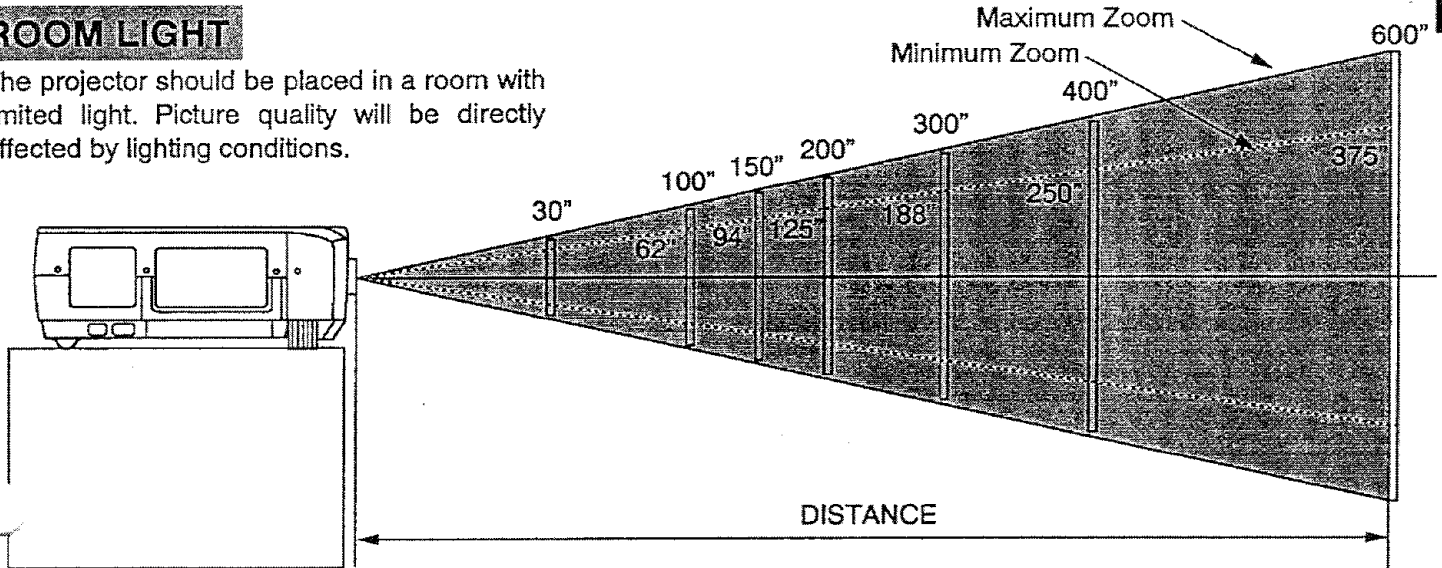

Screen Size	Max. Zoom	30"	100"	150"	200"	300"	400"	600"
	Min. Zoom	-----	62"	94"	125"	188"	250"	375"
Distance		3.6'(1.1 m)	11.8'(3.6 m)	17.7'(5.4 m)	24.3'(7.4 m)	36.4'(11.1 m)	48.6'(14.8 m)	73.2'(22.3 m)

## LEVELING AND ELEVATING ADJUSTMENTS

Two feet adjust the projection angle and leveling the projector. The projection angle can be adjusted up to 4° degrees by rotating the two (left and right) feet located on the bottom of the projector. Level the projector by rotating the two feet.

## MOVE THE PROJECTED IMAGE POSITIC

Adjust the projected image position (maximum 7 mm downward or upward on the 100" screen) using lens shift function. (See page 30)

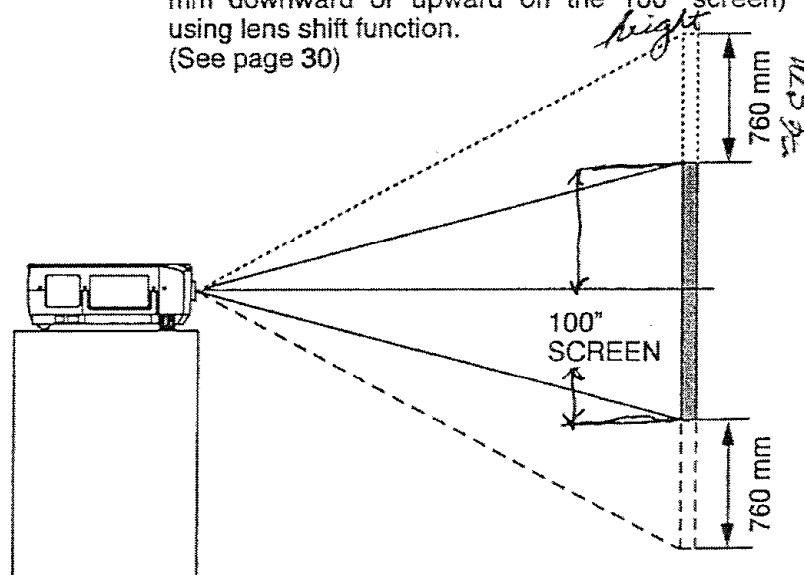
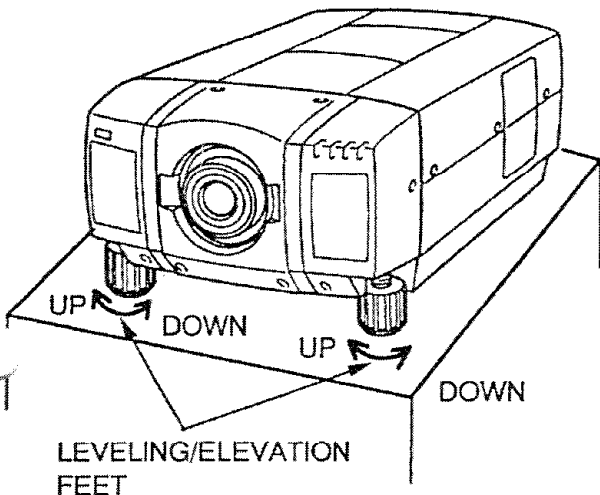

## VENTILATION

This projector is equipped with a cooling fan to protect it from overheating. Pay attention to the following to ensure the ventilation and avoid a possible risk of fire and malfunction.



- Do not cover the vents with papers or other materials.
- Keep the rear grill at least 3.3' (1m) away from any object.
- Make sure that there are no objects under the projector. An object under the projector may prevent the projector from taking the cooling air through the bottom vent.

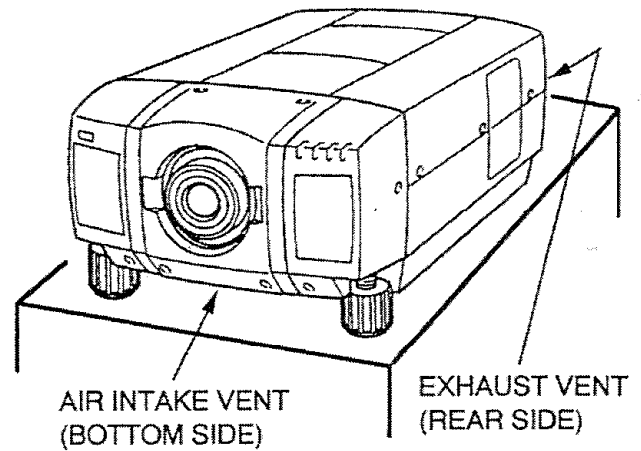

## MOVING THE PROJECTOR

Use the carry handle when moving the projector.



Replace the lens cover and rotate the leveling/elevation feet fully clockwise when moving the projector to prevent damage to the projector.

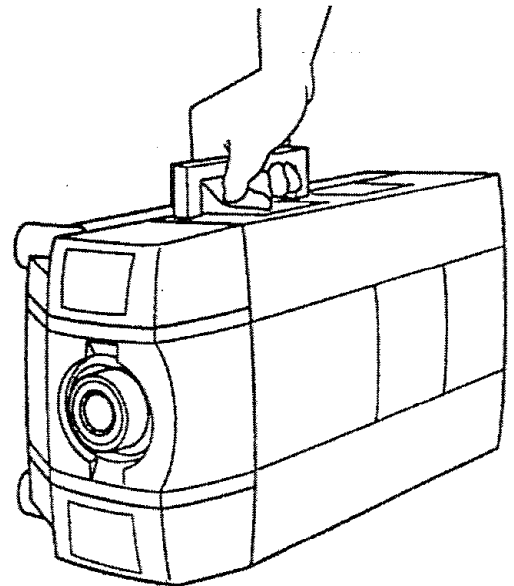

### CAUTION IN CARRYING OR TRANSPORTING THE PROJECTOR

- Do not drop or give a shock to the projector, otherwise damage or malfunction may result.
- When carrying the projector, use a Proxima recommended Carrying Case.
- Do not transport the projector by using a courier or transport service in an unsuitable transport case. This may cause damage to the projector. To transport the projector through a courier or transport service, use a Proxima recommended Case.
- For a carrying or transportation cases, contact a Proxima authorized dealer.



# CONNECTING THE PROJECTOR

## CONNECTING THE COMPUTER

### CONNECTING TO THE COMPUTER INPUT 1 JACKS (BNC TYPE × 5)

Personal computers can be connected to the computer input (Red, Green, Blue, Horiz. Sync. and Vert. Sync.) on the projector.

- Connect the computer to these jacks using the BNC cables (not provided).

### CONNECTING TO THE COMPUTER INPUT 2 TERMINAL {HDB15-PIN (VGA)}

Personal computers can be connected to the HDB15-pin (VGA) terminal on the projector.

- Connect the computer to these terminals using the VGA cable and VGA/MAC adapter (provided).

**WARNING:** For projectors, the VGA cable provided is designed to reduce RFI (Radio Frequency Interference) emissions. For regulatory compliance reasons, this cable must be used and must not be replaced by any other cable.

### CONNECTING TO THE COMPUTER AUDIO INPUT JACKS (1 and 2)

- Connect audio outputs from your computer to these jacks using the RCA cable (not provided).
- If the audio input of the audio equipment is stereo, be sure to connect the right and left channels to the respective right and left jacks.
- If the audio input of the audio equipment is monaural, connect it to the left jack.

### CONNECTING TO THE MULTI-POLE 12-PIN (CONTROL PORT) CONNECTORS (1 and 2)

- If you wish to control the computer with projector's remote control unit, you must connect control port (PS/2, Serial or ADB port) on your computer to projector's control port with cable. (three type of cables provided)

CONTROL PORT

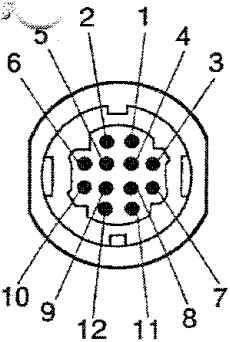

	PS/2 Port	Serial Port	ADB Port
1	_____	TxD	_____
2	CLK	_____	ADB
3	DATA	_____	_____
4	_____	_____	_____
5	_____	_____	_____
6	_____	_____	_____
7	_____	READY	_____
8	_____	_____	_____
9	GND	GND	GND
10	_____	_____	_____
11	_____	_____	_____
12	_____	_____	_____

### CONTROL PORT CABLE REMOVAL HINT

Disconnect control port cable with following steps.

1. Hold the portion (A) of the connector with one hand.
2. Pull the portion (B) arrow direction and remove connector.

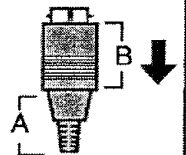

### CONNECTING TO THE MONITOR OUTPUT TERMINAL {HDB15-PIN (VGA)}

This terminal contains the information that is viewed on the screen.

An external monitor can be connected to the HDB15-pin (VGA) terminal on the projector.

- Connect the monitor to this terminal using the VGA cable (not provided).

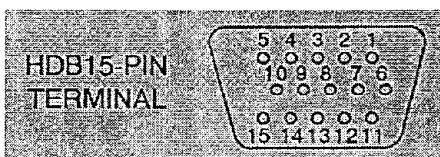

#### Pin No./Signal

- 1 Red input
- 2 Green input
- 3 Blue input
- 4 Sense 2
- 5 Ground (Horiz. sync.)
- 6 Ground (Red)
- 7 Ground (Green)
- 8 Ground (Blue)

#### Pin No./Signal

- 9 Non Connect
- 10 Ground (Vert. sync.)
- 11 Sense 0
- 12 Sense 1
- 13 Horiz. sync.
- 14 Vert. sync.
- 15 Reserved

## CONNECTING TO THE COMPUTER AUDIO MONITOR OUTPUT (VARIABLE) JACKS

These jacks will contain the audio information of the selected program source being viewed on the screen (Computer 1 or Computer 2). If you have selected program source Computer 2 the audio signal connected to the Computer 2 audio input jack will be available at the computer audio monitor output jacks. If you select program source "Video 1" or "Video 2, the audio signal connected to the Computer 1 audio input jack will be available at the computer audio monitor output jacks. Connect audio input from audio equipment to these jacks using the RCA cables.

- If the audio input of the audio equipment is stereo, be sure to connect the right and left channels to the respective right and left jacks.
- If the audio input of the audio equipment is monaural, connect it to the left jack.

## CONNECTING TO THE SERIAL PORT (DB9-PIN) TERMINAL

- If you control the projector by computer, you must connect a cable (not provided) from your computer to this terminal.

A

### ■ SERIAL PORT

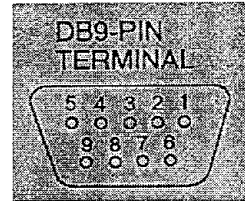

1	_____
2	RxD
3	TxD
4	_____
5	Ground
6	_____
7	_____
8	_____
9	_____

## CONNECTING TO THE USB PORT CONNECTORS (1 and 2)

This Projector is designed for connecting with USB Port of the computer or peripheral equipment that is to be standard.

### ■ USB PORT

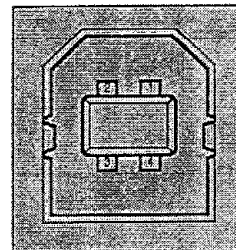

1	Vcc
2	-Data
3	+Data
4	Ground



# Connecting a Macintosh desktop computer

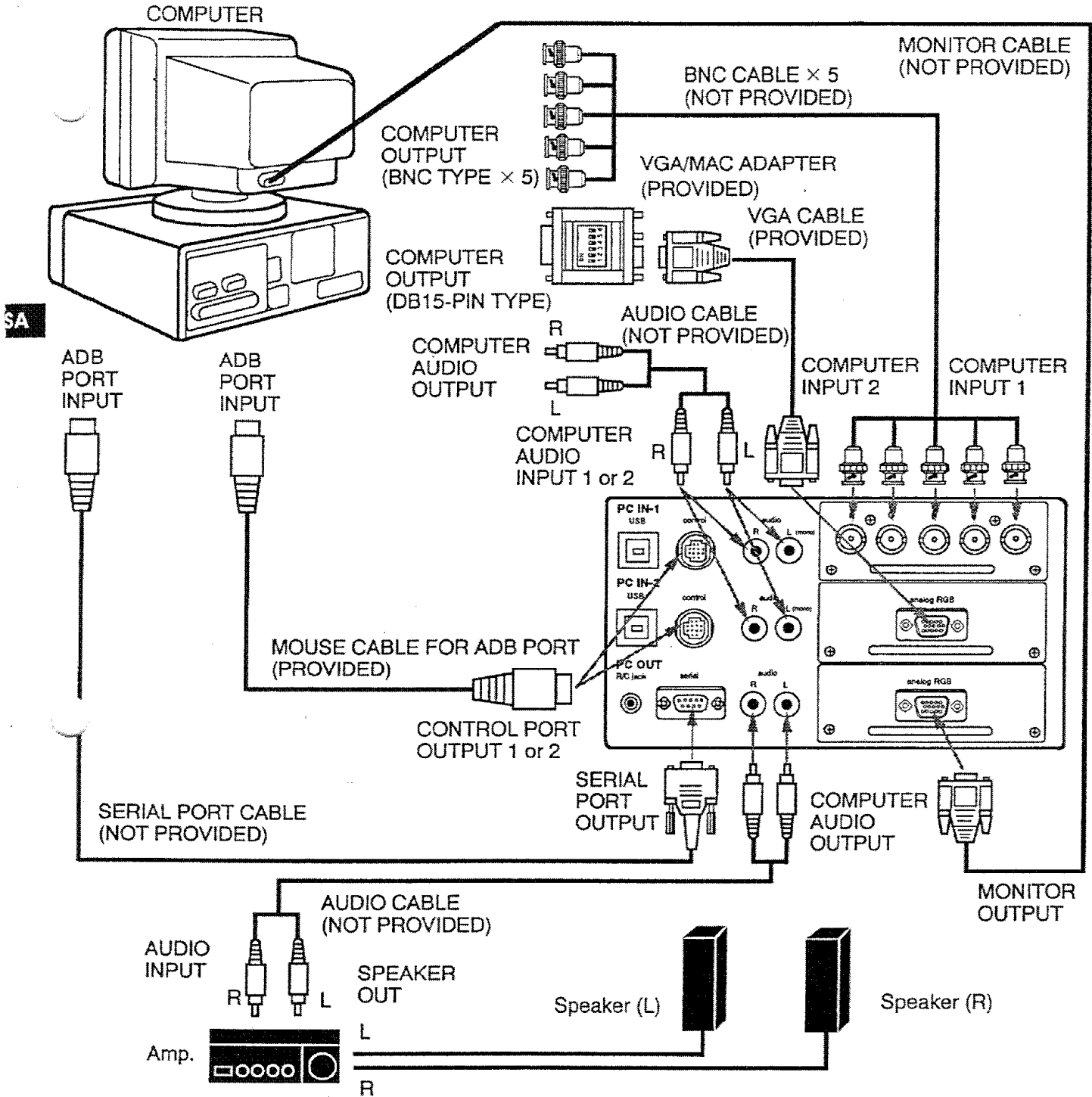

Set the dip switches as shown in the table below depending on the RESOLUTION MODE that you want to use before you turn on the projector and computer.

RESOLUTION MODE	SW1	SW2	SW3	SW4	SW5	SW6
13" MODE (640 × 480)	ON	OFF	OFF	OFF	OFF	OFF
16" MODE (832 × 624)	OFF	OFF	OFF	OFF	OFF	ON
10" MODE (1024 × 768)	OFF	OFF	OFF	ON	OFF	OFF
11" MODE (1152 × 870)	ON	ON	ON	OFF	OFF	OFF

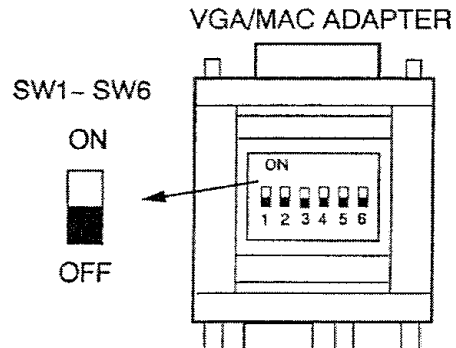

**NOTE:** The hook up should be done as per the above illustration. After hook up, turn on the projector, monitor, computer, in that order.

# Connecting an IBM-compatible laptop computer

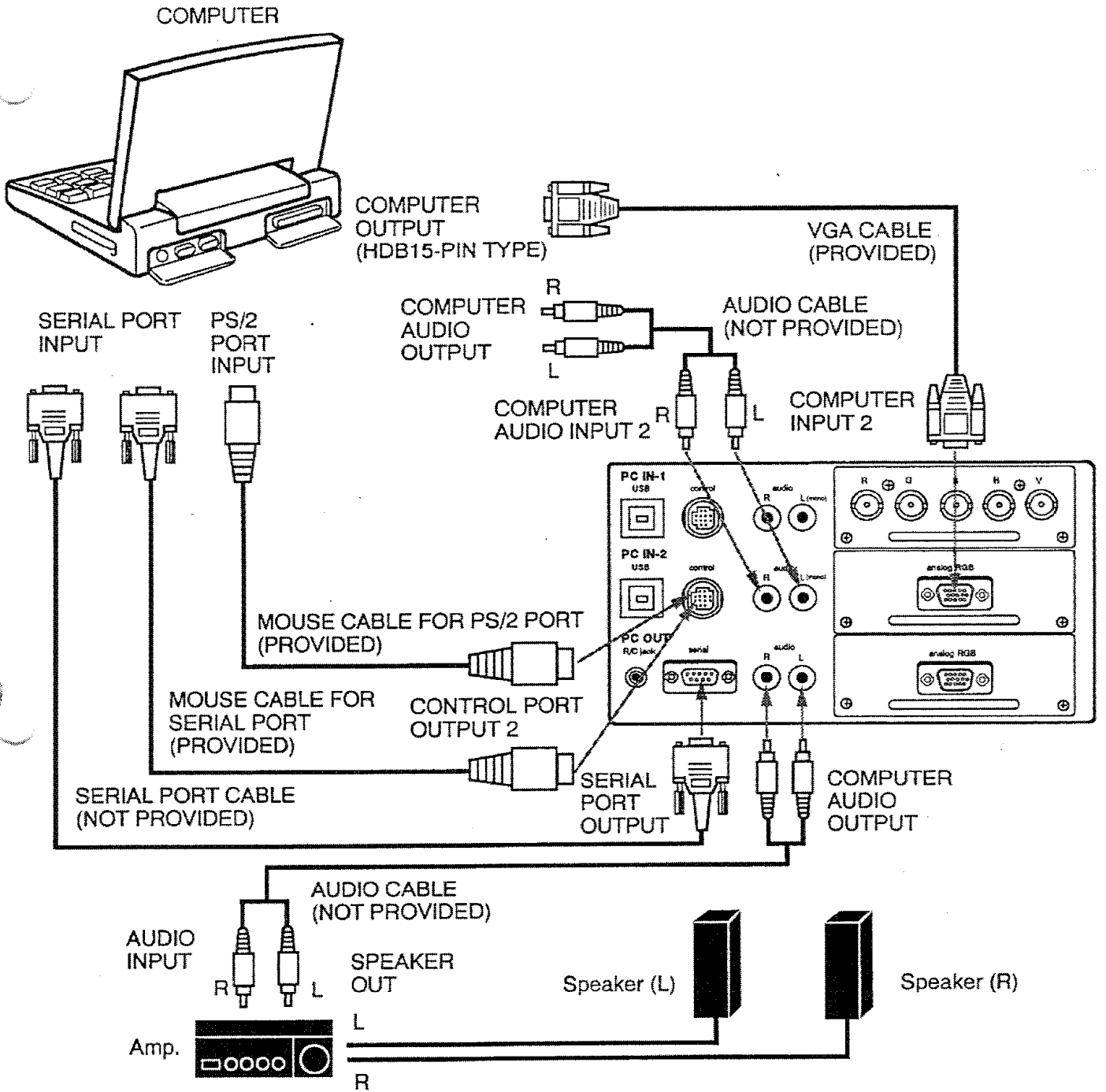

**NOTE:** The hook up should be done as per the above illustration. After hook up, turn on the projector, computer, in that order.

# Connecting a Macintosh PowerBook computer

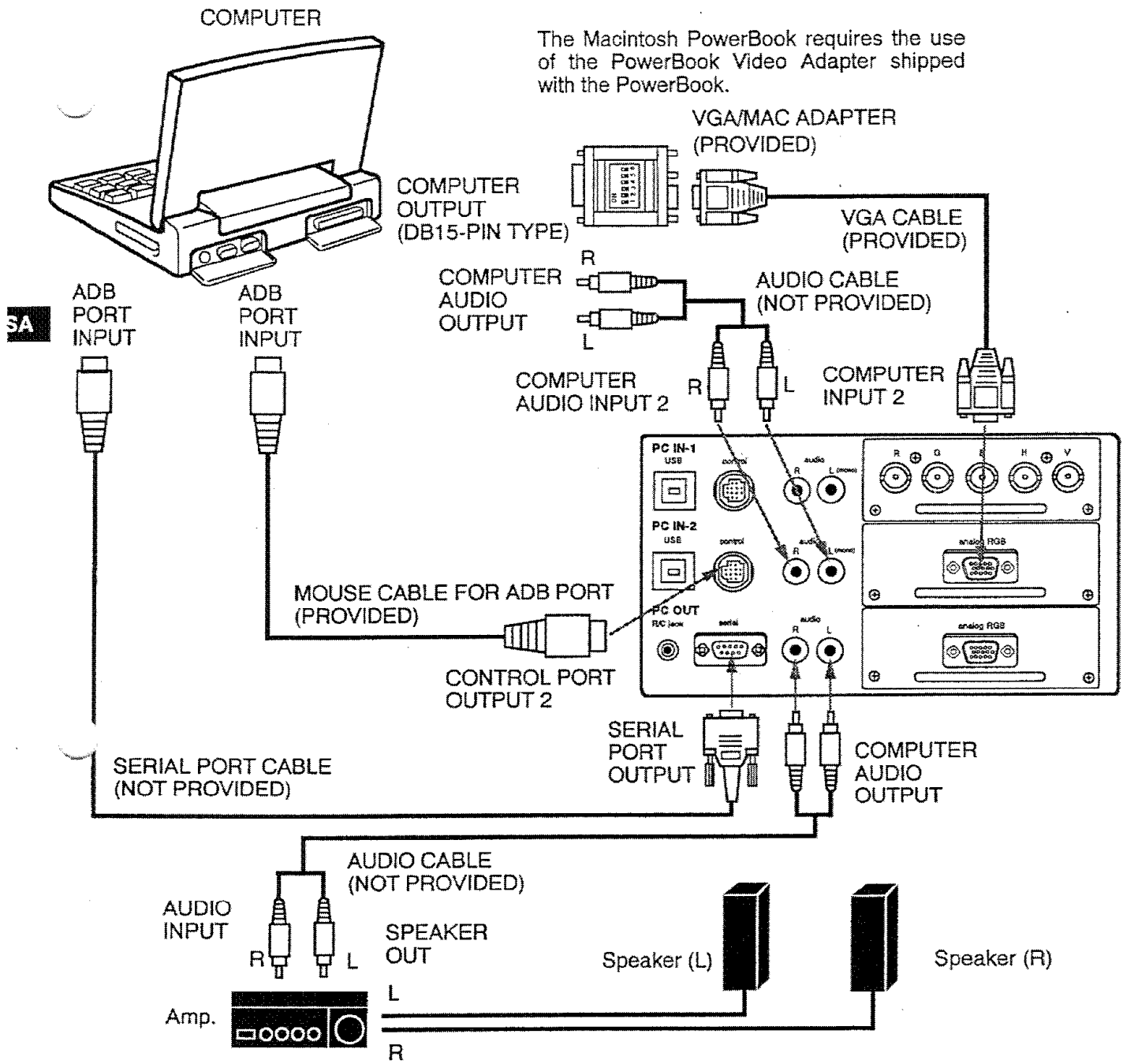

The Macintosh PowerBook requires the use of the PowerBook Video Adapter shipped with the PowerBook.

Set the dip switches as shown in the table below depending on the RESOLUTION MODE that you want to use before you turn on the projector and computer.

RESOLUTION MODE	SW1	SW2	SW3	SW4	SW5	SW6
13" MODE (640 × 480)	ON	OFF	OFF	OFF	OFF	OFF
16" MODE (832 × 624)	OFF	OFF	OFF	OFF	OFF	ON
19" MODE (1024 × 768)	OFF	OFF	OFF	ON	OFF	OFF
21" MODE (1152 × 870)	ON	ON	ON	OFF	OFF	OFF

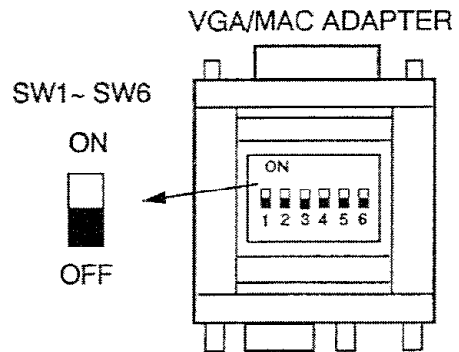

Note: The hook up should be done as per the above illustration. After hook up, turn on the projector, computer, in that order.

## **CONNECTING THE VIDEO EQUIPMENT (Video-Equipped Models Only)**

### **CONNECTING TO THE VIDEO INPUT JACKS (1 and 2) BNC TYPE × 3**

Connect to the video outputs of a VCR, video disc player, DVD player, video camera, satellite TV tuner or other AV equipment. Connect video output from AV equipment to these jacks using the BNC cables.

The video input can be selected 3 type of the input. "COMPOSITE VIDEO", "Y/C SEPARATE VIDEO" and COMPONENT VIDEO {Y, Cb (B-Y), Cr (R-Y)}.

When the video equipment with COMPOSITE VIDEO type output jack is used, to select the "Video" position by video source select. When the video equipment with Y/C SEPARATE VIDEO type output jack is used, to select the "Y, C" position. When the video equipment with COMPONENT VIDEO {Y, Cb (B-Y), Cr (R-Y)} type output jack is used, to select the "Y, Cb, Cr" position. (See "VIDEO SOURCE SELECT" section on page 34).

### **CONNECTING S-VHS VIDEO INPUT JACKS (1 and 2)**

The Video input includes an extra video input jack marked S-VIDEO to allow connection to an S-VHS format VCR that has separate Y/C video signals. The S-VIDEO jack has priority over the VIDEO jack.

### **CONNECTING TO THE AUDIO INPUT JACKS (1 and 2)**

Connect to the audio outputs of a VCR, video disc player, DVD player, video camera, satellite TV tuner or other AV equipment. Connect audio output from AV equipment to these jacks using the RCA cables.

- If the audio signal from the AV equipment is stereo, be sure to connect the right and left channels to the respective right and left audio input jacks.
- If the external audio signal is monaural, connect it to the left jack.

### **CONNECTING TO THE VIDEO MONITOR OUTPUT JACKS (BNC TYPE × 3)**

These jacks will contain the video information of the selected program source being viewed on the screen (Video 1 or Video 2). If you have selected program source Video 2 the video signal connected to the Video 2 video input jack will be available at the video monitor output jacks. If you select program source "Computer 1" or "Computer 2, the video signal connected to the Video 1 video input jack will be available at the video monitor output jacks. Connect video input from AV equipment to these jacks using the BNC cables.

### **CONNECTING TO THE S-VHS VIDEO MONITOR OUTPUT JACK**

The Video monitor output includes an extra video input jack marked S-VIDEO to allow connection to an S-VHS format VCR that has separate Y/C video signals. The S-VIDEO jack has priority over the VIDEO jack.

### **CONNECTING TO THE AUDIO MONITOR OUTPUT (VARIABLE) JACKS**

These jacks will contain the audio information of the selected program source being viewed on the screen (Video 1 or Video 2). If you have selected program source Video 2 the audio signal connected to the Video 2 audio input jack will be available at the audio monitor output jacks. If you select program source "Computer 1" or "Computer 2, the audio signal connected to the Video 1 audio input jack will be available at the audio monitor output jacks. Connect audio input from AV equipment to these jacks using the RCA cables.

- If the audio input of the audio equipment is stereo, be sure to connect the right and left channels to the respective right and left jacks.
- If the audio input of the audio equipment is monaural, connect it to the left jack.

# Connecting the Video Equipment (Video-Equipped Models Only)

## VIDEO EQUIPMENT

Video Cassette Recorder



DVD Player  
Video Disc Player



Satellite  
TV Tuner



Video Camera



VIDEO  
OUTPUT  
(BNC)

Y  
OUTPUT  
(BNC)

C  
OUTPUT  
(BNC)

Cb (B-Y)  
OUTPUT  
(BNC)

Cr (R-Y)  
OUTPUT  
(BNC)

S-VIDEO  
OUTPUT  
AUDIO  
OUTPUT

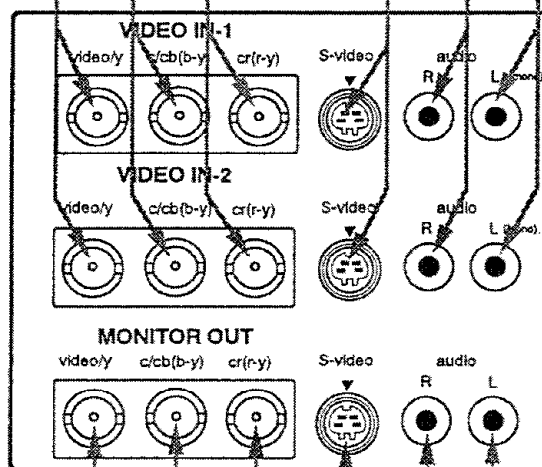
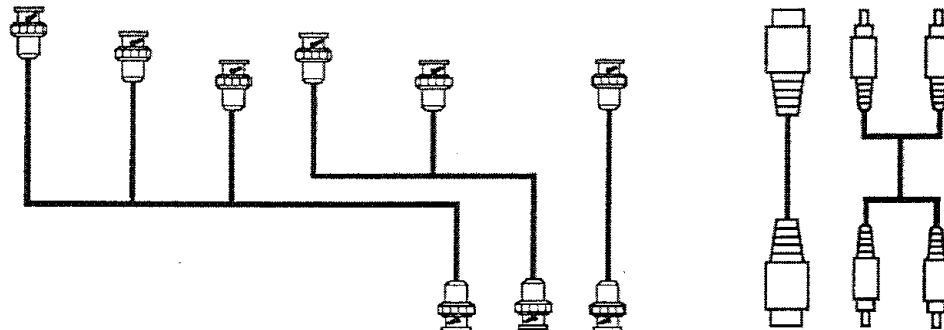

VIDEO  
INPUT  
(BNC)

Y  
INPUT  
(BNC)

C  
INPUT  
(BNC)

Cb (B-Y)  
INPUT  
(BNC)

Cr (R-Y)  
INPUT  
(BNC)

S-VIDEO  
INPUT

AUDIO  
INPUT

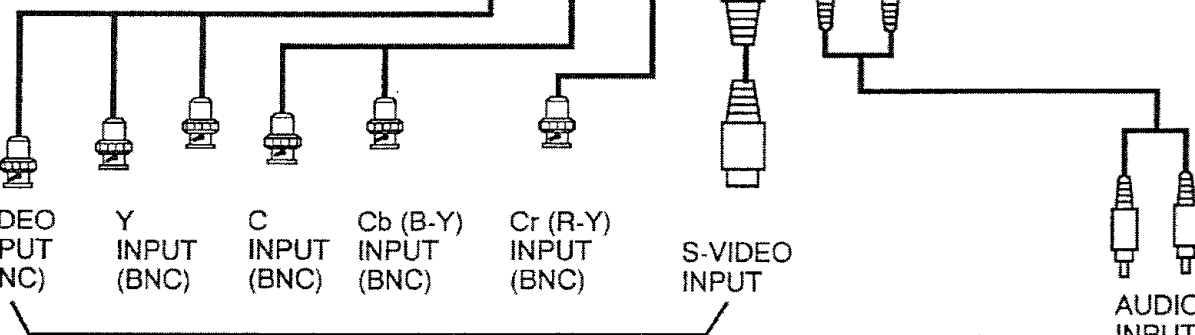

MONITOR

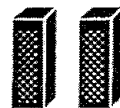

SPEAKERS



AUDIO AMP.

**NOTE:** The hook up should be done as per the above illustration. After hook up, turn on the projector, video equipment, in that order.



# OPERATION OF CONTROLS

## TOP OF THE PROJECTOR

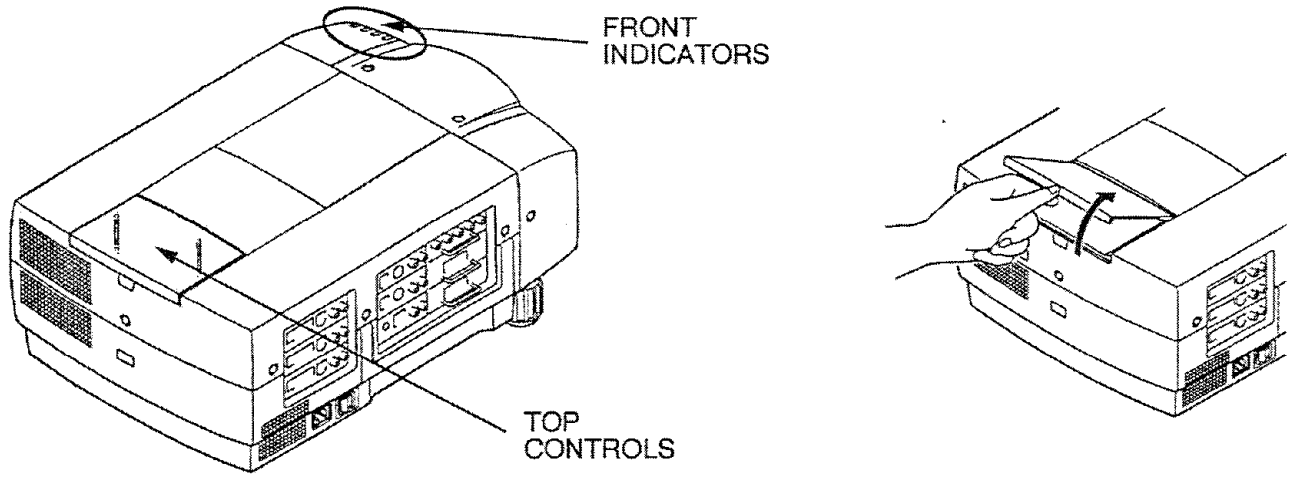

## FRONT INDICATORS

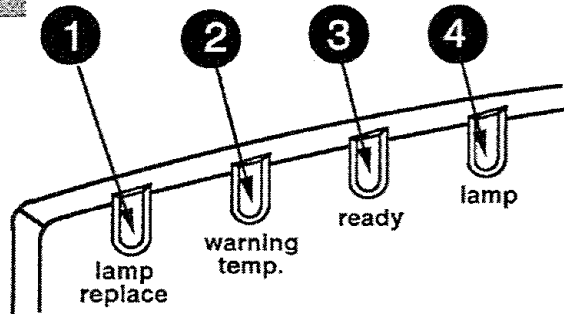

## TOP CONTROLS

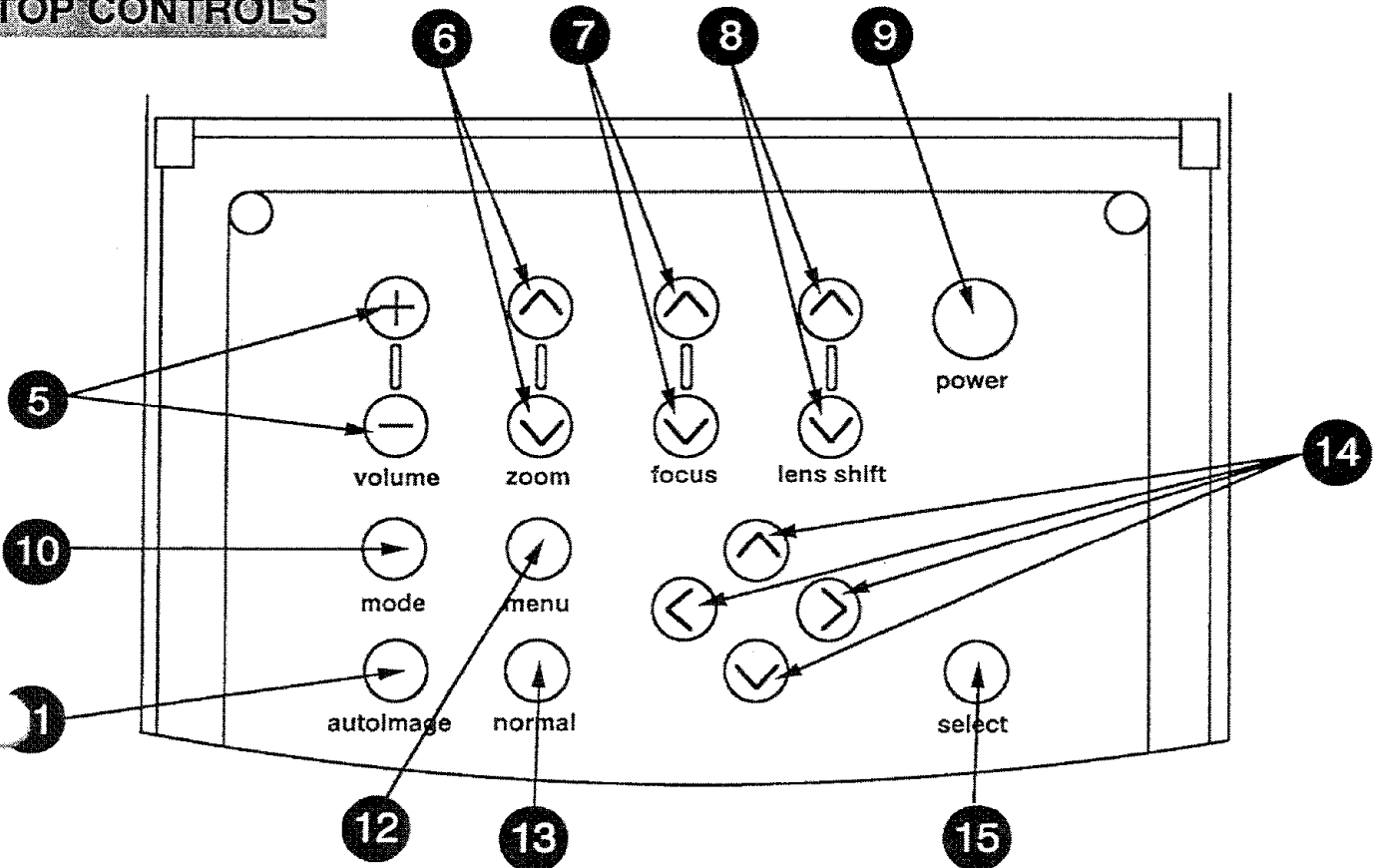

- 1 LAMP REPLACEMENT INDICATOR**  
Light is orange when projection lamp is nearing end of service life.
- 2 TEMPERATURE WARNING INDICATOR**  
Flashes red when internal projector temperature is too high.
- 3 READY INDICATOR**  
Light is green when projector lamp is ready to be turned on.
- 4 LAMP POWER INDICATOR**  
Light is dim when the projector is on.  
Light is brightened when the projector is in stand-by mode.
- 5 VOLUME BUTTONS**  
Used to adjust volume.
- 6 ZOOM BUTTONS**  
Used to operate power zoom lens.
- 7 FOCUS BUTTONS**  
Used to operate power focus system.
- 8 LENS SHIFT BUTTONS**  
Used to operate power lens shift.
- 9 LAMP POWER ON/OFF BUTTON**  
Used to turn projection lamp on or off.
- 10 MODE BUTTON**  
Used to select source.  
(Computer 1, Computer 2, Video 1 or Video 2 Input)
- 11 AUTO IMAGE BUTTON**  
Used to operate the AUTO IMAGE function.
- 12 MENU BUTTON**  
This button will activate the MENU operation.  
Use this button, the POINT UP/DOWN/LEFT/RIGHT buttons and the SELECT button to make adjustments to the projector's setting in MENU operation.
- 13 NORMAL BUTTON**  
Used to reset to normal picture adjustment preset by factory.
- 14 POINT UP/DOWN/LEFT/RIGHT BUTTONS**  
To select an item on the MENU that you want to adjust. To select an item, move the arrow by pressing these buttons (UP, DOWN, LEFT or RIGHT).
- 15 SELECT BUTTON**  
This button has different functions depending on when used. This button is used to execute the item selected, to increase or decrease the values in certain items such as CONTRAST or BRIGHTNESS.

## SIDE OF THE PROJECTOR (CONNECT THE COMPUTER)

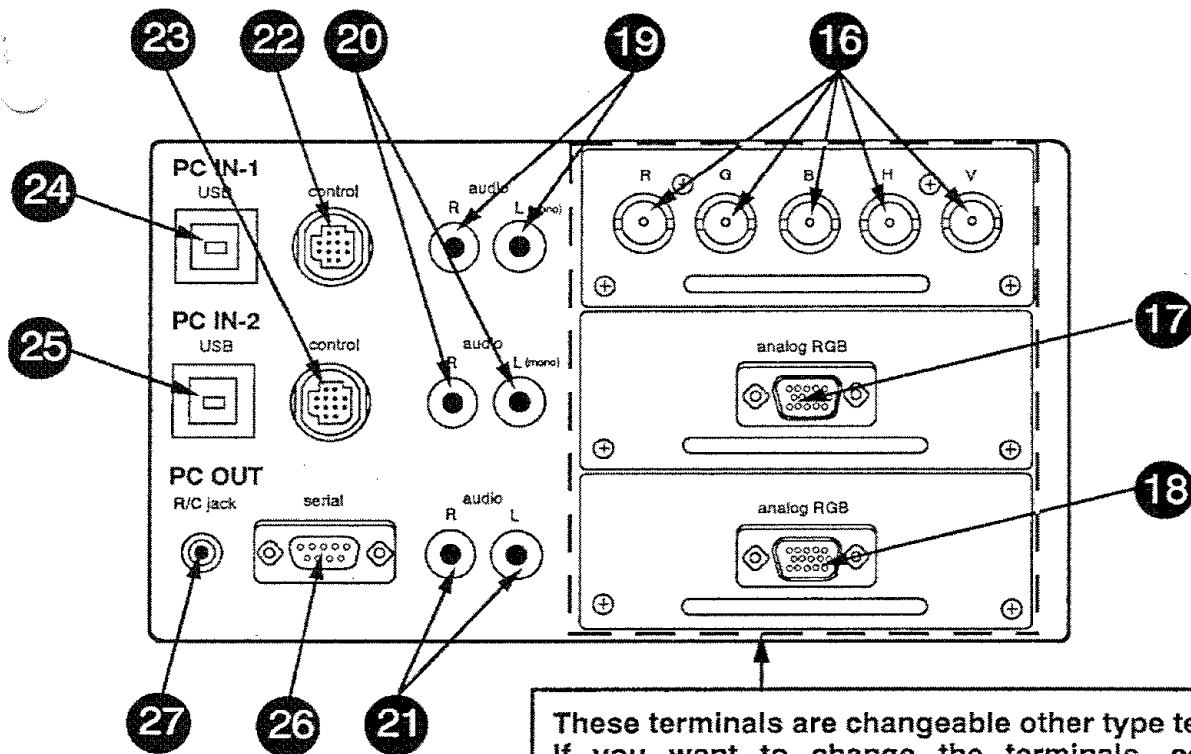

These terminals are changeable other type terminals. If you want to change the terminals, contact your authorized dealer or service station.

- 16** **COMPUTER INPUT-1 JACKS (BNC TYPE × 5)**  
Used to connect a computer to the projector.
- 17** **COMPUTER INPUT-2 TERMINAL (VGA HDB15)**  
Used to connect a computer to the projector.
- 18** **MONITOR OUTPUT TERMINAL (VGA HDB15)**  
Used to connect a monitor to the projector.
- 19** **COMPUTER AUDIO INPUT-1 JACKS (R and L)**  
Used to connect an audio output from the computer to the projector.
- 20** **COMPUTER AUDIO INPUT-2 JACKS (R and L)**  
Used to connect an audio output from the computer to the projector.
- 21** **COMPUTER AUDIO MONITOR OUTPUT JACKS (R and L)**  
Used to connect an audio input from audio equipment to the projector.
- 22** **CONTROL PORT-1 CONNECTOR**  
Used to connect a mouse cable to the projector.
- 23** **CONTROL PORT-2 CONNECTOR**  
Used to connect a mouse cable to the projector.
- 24** **USB PORT-1 CONNECTOR**  
Used to connect a computer to the projector.
- 25** **USB PORT-2 CONNECTOR**  
Used to connect a computer to the projector.
- 26** **SERIAL PORT TERMINAL (DB9)**  
Used to connect a computer to the projector.
- 27** **WIRED REMOTE JACK**  
When using the wired remote control, connect the remote cable to this jack.

# SIDE OF THE PROJECTOR (CONNECT THE VIDEO EQUIPMENT)

(Video-Equipped Models Only)

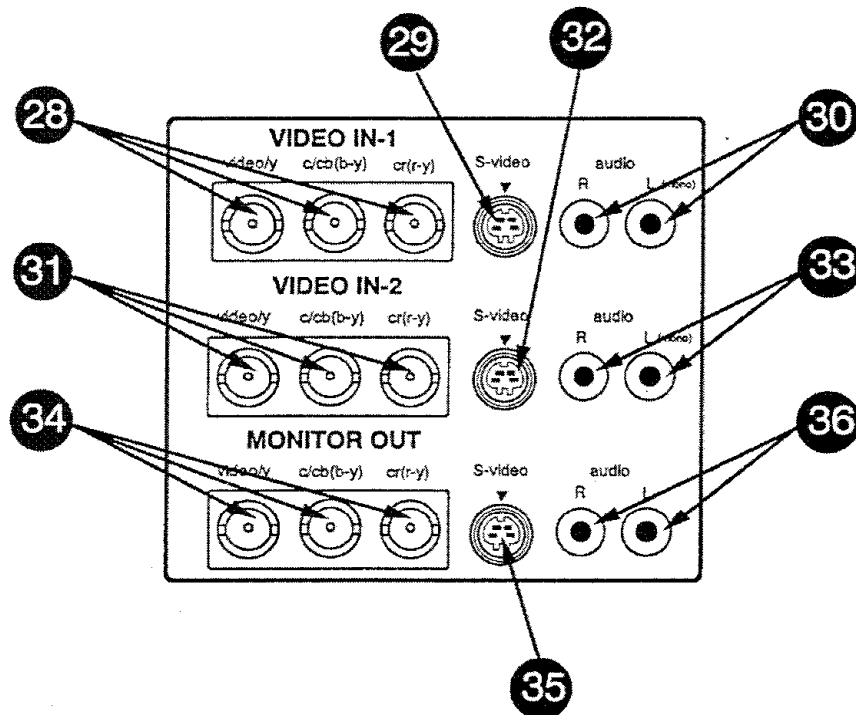

- 28 VIDEO INPUT JACKS-1 (BNC TYPE × 3)**  
Used to connect a video source to the projector.
- 29 S-VIDEO INPUT JACK-1**  
Used to connect a S-VHS video source to the projector.
- 30 AUDIO INPUT JACKS-1 (R and L)**  
Used to connect an audio source to the projector.
- 31 VIDEO INPUT JACKS-2 (BNC TYPE × 3)**  
Used to connect a video source to the projector.
- 32 S-VIDEO INPUT JACK-2**  
Used to connect a S-VHS video source to the projector.
- 33 AUDIO INPUT JACKS-2 (R and L)**  
Used to connect an audio source to the projector.
- 34 VIDEO MONITOR OUTPUT JACKS (BNC TYPE × 3)**  
Permits video connection to a monitor.
- 35 VIDEO MONITOR (S-VIDEO) OUTPUT JACK**  
Permits S-VHS video connection to a monitor.
- 36 AUDIO MONITOR OUTPUT JACKS (R and L)**  
Permits audio connection to a monitor.

# OPERATION OF REMOTE CONTROL (Wireless)

This remote control unit is not only able to operate the projector but usable as a wireless mouse for a PC. One pointing pad and click buttons are used for wireless mouse operation. Wireless mouse is usable when PC mouse pointer is displayed on the screen. When the menu or indicator of the projector is displayed on the screen instead of the PC mouse pointer, the wireless mouse cannot be used.

**NOTE:** To use the unit as a PC wireless mouse, connect the projector to the PC with the attached cable. Signals from the projector are transmitted to the PC, enabling the remote control unit of the projector to be used as a PC wireless mouse. (Refer to "CONNECTING THE PROJECTOR" in pages 9 to 14 for the connection.)

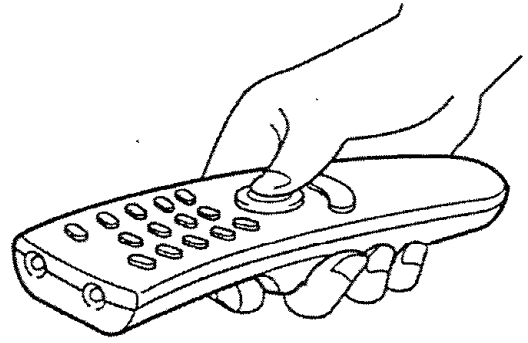

FRONT

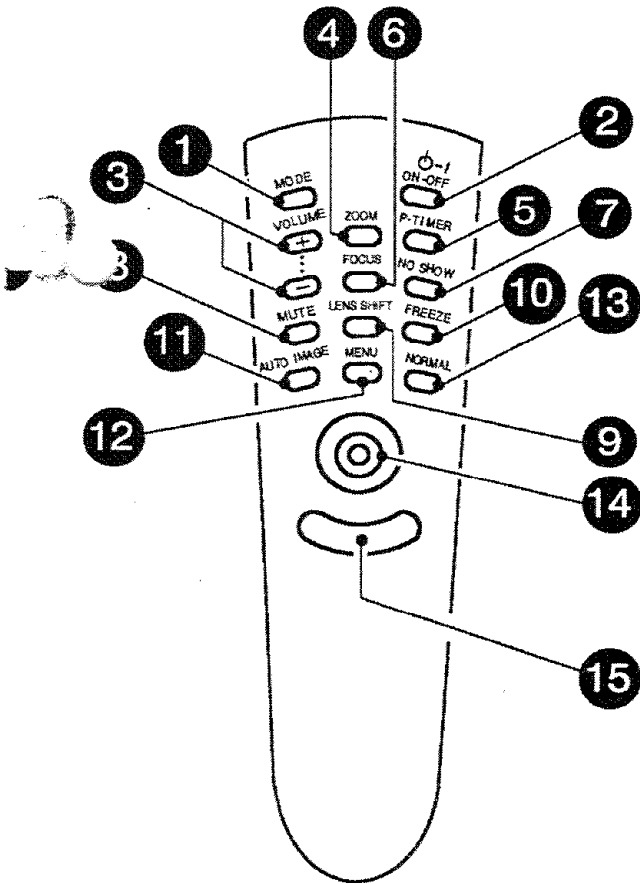

SIDE

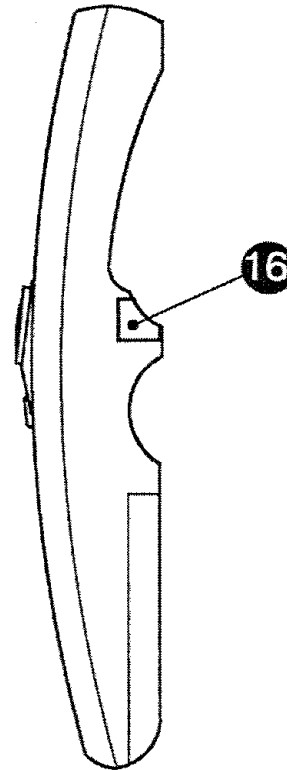

- 1 MODE BUTTON**  
Used to select source. (Computer 1, Computer 2, Video 1 or Video 2 Input)
- 2 LAMP POWER ON/OFF BUTTON**  
Used to turn the projection lamp on or off.
- VOLUME BUTTONS**  
Used to adjust volume.
- 4 ZOOM BUTTON**  
Used to select power zoom lens adjust.
- 5 P-TIMER BUTTON**  
Used to operate the P-TIMER function.
- 6 FOCUS BUTTON**  
Used to select focus adjust.
- 7 NO SHOW BUTTON**  
Used to change the screen into black image.
- 8 SOUND MUTE BUTTON**  
Used to mute sound.
- 9 LENS SHIFT BUTTON**  
Used to select power lens shift.
- 10 FREEZE BUTTON**  
Use this button to freeze on-screen image.
- 11 AUTO IMAGE BUTTON**  
Used to operate the AUTO IMAGE function.
- 12 MENU BUTTON**  
This button will activate the MENU operation. Use this button, the POINT UP/DOWN/LEFT/RIGHT button and the SELECT (REAR CLICK) button to make adjustments to the projector's setting in MENU operation.
- 13 NORMAL BUTTON**  
Use to reset to normal picture adjustment preset by factory.
- 14 POINTING PAD (POINT UP/DOWN/LEFT/RIGHT BUTTON)**  
**When in use as a remote for the projector.**  
To select an item on the MENU that you want to adjust. To select an item, move the arrow by pressing the pad upward, downward, leftward or rightward.  
Used to operate power zoom lens, power focus system or power lens shift by pressing the pad either upward or downward.  
  
**When in use as a wireless mouse**  
Used to move the pointer. The pointer is moved according to the direction you are pressing.
- 15 FRONT CLICK BUTTON**  
This button has the same function as the right button in a PC mouse. Pressing this button does not affect any operation when in MENU mode.
- 16 SELECT (REAR CLICK) BUTTON**  
**When in use as a remote for the projector.**  
This button has different functions depending on when used. This button is used to execute the item selected, to increase or decrease the values in certain items such as CONTRAST or BRIGHTNESS.  
  
**When in use as a wireless mouse**  
This button has the same function as the left button in a PC mouse.

## REMOTE CONTROL BATTERY INSTALLATION

**1** Remove the battery compartment lid.

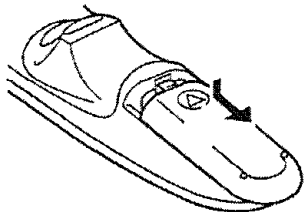

**2** Slide the batteries into the compartment.

Note: For correct polarity (+ and - terminal), be sure the battery terminals are in contact with the pins in the compartment.

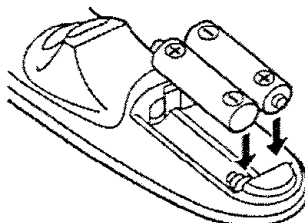

**3** Replace the compartment lid.

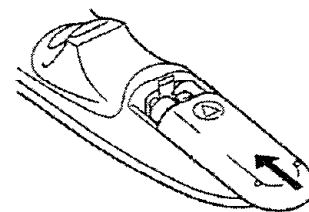

## USING THE REMOTE CONTROL UNIT

Point the remote control toward the projector (Receiver window) whenever pressing the buttons. Maximum operating range for the remote control is about 16.4' (5 m) and 60° front and rear of the projector.

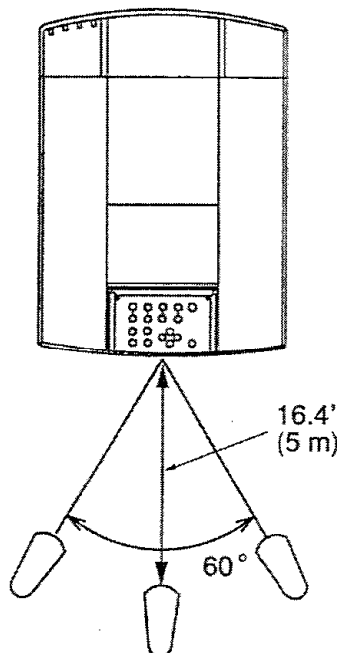
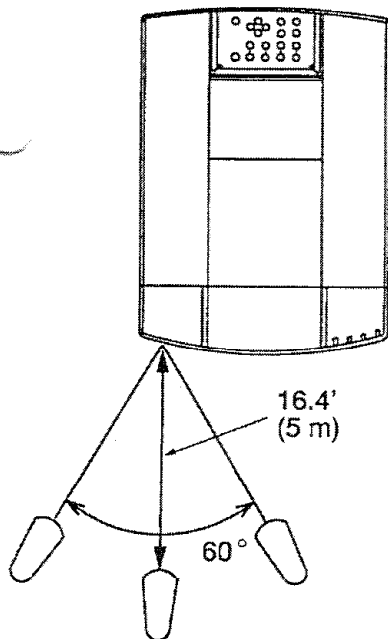

To insure safe operation, please observe the following precautions:

- Use (2) AA type alkaline batteries.
- Change two batteries at the same time.
- Do not use a new battery with a used battery.
- Avoid contact with water.
- Do not drop the remote control unit.
- If batteries have leaked on the remote control, carefully wipe the case clean and load new batteries.

# OPERATION OF REMOTE CONTROL (Wireless/Wired)

- 1 WIRED REMOTE JACK**  
When using the wired remote control, connect the remote cable to this jack.
- 2 MODE BUTTON**  
Used to select source.  
(Computer 1, Computer 2, Video 1 or Video 2 Input)
- 3 LAMP POWER ON/OFF BUTTON**  
Used to turn projection lamp on or off.
- 4 VOLUME BUTTONS**  
Used to adjust volume.
- 5 ZOOM BUTTONS**  
Used to operate power zoom lens.
- 6 FOCUS BUTTONS**  
Used to operate power focus system.
- 7 SOUND MUTE BUTTON**  
Used to mute sound.
- 8 LENS SHIFT BUTTONS**  
Used to operate power lens shift.
- 9 P-TIMER BUTTON**  
Used to operate the P-TIMER function.
- 10 AUTO IMAGE BUTTON**  
Used to operate the AUTO IMAGE function.
- 11 NO SHOW BUTTON**  
Used to change the screen into black image.
- 12 MENU BUTTON**  
This button will activate the MENU operation.  
Use this button, the POINT UP/DOWN/LEFT/RIGHT buttons and the SELECT button to make adjustments to the projector's setting in MENU operation.
- 13 POINT UP/DOWN/LEFT/RIGHT BUTTONS**  
To select an item on the MENU that you want to adjust. To select an item, move the arrow by pressing these buttons (UP, DOWN, LEFT or RIGHT).
- 14 FREEZE BUTTON**  
Use this button to freeze on-screen image.
- 15 SELECT BUTTON**  
This button has different functions depending on when used. This button is used to execute the item selected, to increase or decrease the values in certain items such as CONTRAST or BRIGHTNESS.
- 16 NORMAL BUTTON**  
Used to reset to normal picture adjustment preset by factory.

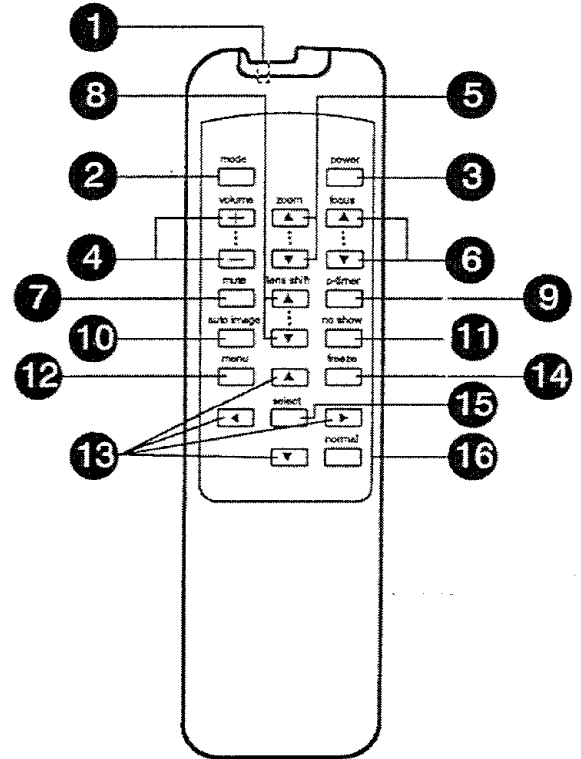



## REMOTE CONTROL BATTERY INSTALLATION

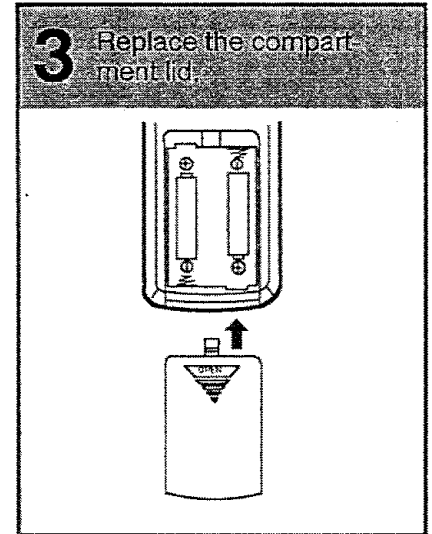
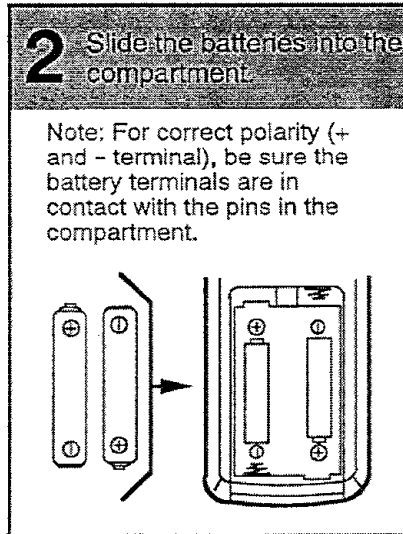
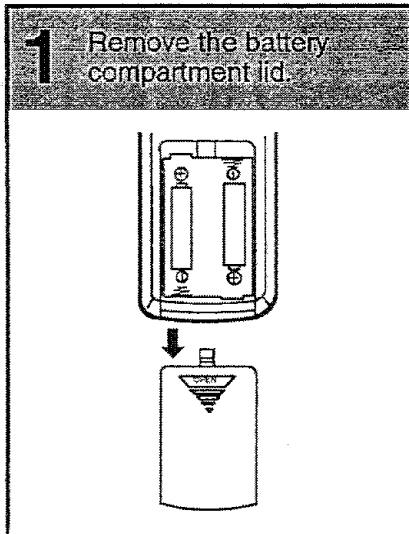

The remote control unit can be used as wireless or wired remote control.

### USING THE REMOTE CONTROL UNIT (wireless)

Point the remote control toward the projector (Receiver window) whenever pressing the buttons. Maximum operating range for the remote control is about 16.4' (5 m) and 60° front and rear of the projector.

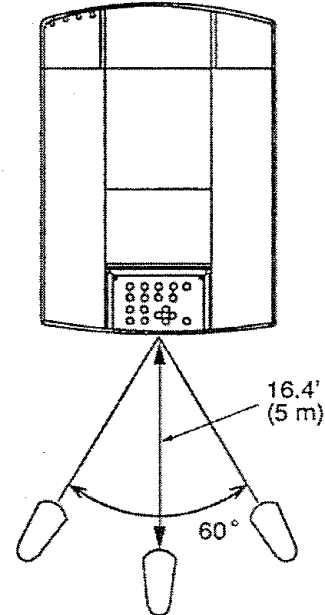
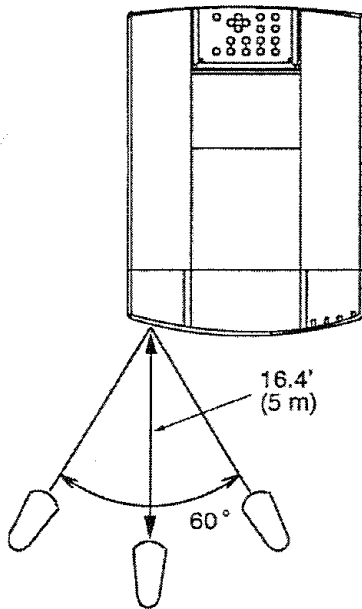

### USING THE REMOTE CONTROL UNIT (wired)

Connect a remote control cable to R/C jacks located on the wireless/wired remote control unit and the side of the projector.



To insure safe operation, please observe the following precautions:

- Use (2) AA type alkaline batteries.
- Change two batteries at the same time.
- Do not use a new battery with a used battery.
- Avoid contact with water.
- Do not drop the remote control unit.
- If batteries have leaked on the remote control, carefully wipe the case clean and load new batteries.

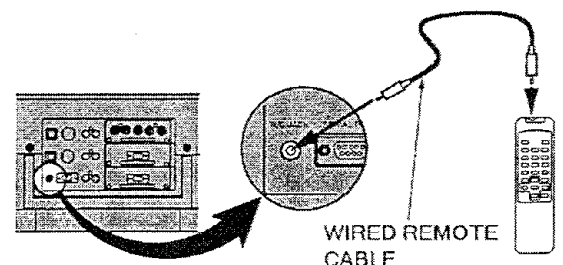

# CONTROL THE PROJECTOR

The projector has two types of operation: DIRECT OPERATION and MENU OPERATION. DIRECT OPERATION allows you to operate the projector by using one button without showing the MENU. In MENU OPERATION mode, you display menus where you can adjust the projector's settings. Follow the instruction for each control.

## DIRECT OPERATION

ADJUST ITEM	TOP CONTROL OF THE PROJECTOR	WIRELESS/WIRED REMOTE CONTROL	WIRELESS REMOTE CONTROL
LAMP POWER ON/OFF	LAMP POWER ON-OFF	LAMP POWER ON-OFF	LAMP POWER ON-OFF
MODE SELECT	MODE	MODE	MODE
SOUND VOLUME	VOLUME (+) and ( - )	VOLUME (+) and ( - )	VOLUME (+) and ( - )
SOUND MUTE	NOT AVAILABLE	MUTE	MUTE
ZOOM	ZOOM (Δ) and (▽)	ZOOM (Δ) and (▽)	ZOOM POINT (UP/DOWN)
FOCUS	FOCUS (Δ) and (▽)	FOCUS (Δ) and (▽)	FOCUS POINT (UP/DOWN)
LENS SHIFT	LENS SHIFT (Δ) and (▽)	LENS SHIFT (Δ) and (▽)	LENS SHIFT POINT (UP/DOWN)
NORMAL PICTURE	NORMAL	NORMAL	NORMAL
NO SHOW	NOT AVAILABLE	NO SHOW	NO SHOW
P-TIMER	NOT AVAILABLE	P-TIMER	P-TIMER
FREEZE PICTURE	NOT AVAILABLE	FREEZE	FREEZE
AUTO IMAGE	AUTO IMAGE	AUTO IMAGE	AUTO IMAGE

## MENU OPERATION

ADJUST ITEM	TOP CONTROL OF THE PROJECTOR	WIRELESS/WIRED REMOTE CONTROL	WIRELESS REMOTE CONTROL
MODE SELECT	MENU POINT LEFT/RIGHT SELECT POINT UP/DOWN SELECT	MENU POINT LEFT/RIGHT SELECT POINT UP/DOWN SELECT	MENU POINT (LEFT/RIGHT) SELECT (REAR CLICK) POINT (UP/DOWN) SELECT (REAR CLICK)

### 1. COMPUTER/VIDEO MODE

ADJUST ITEM	TOP CONTROL OF THE PROJECTOR	WIRELESS/WIRED REMOTE CONTROL	WIRELESS REMOTE CONTROL
SOUND SOUND VOLUME TREBLE BASS BUILT-IN SP. SOUND MUTE	MENU POINT LEFT/RIGHT SELECT POINT UP/DOWN SELECT	MENU POINT LEFT/RIGHT SELECT POINT UP/DOWN SELECT	MENU POINT (LEFT/RIGHT) SELECT (REAR CLICK) POINT (UP/DOWN) SELECT (REAR CLICK)
LANGUAGE			
SETTING BLUE BACK DISPLAY REVERSE T/B REVERSE R/L SPLIT WIPE LAMP AGE	MENU POINT LEFT/RIGHT SELECT POINT UP/DOWN SELECT	MENU POINT LEFT/RIGHT SELECT POINT UP/DOWN SELECT	MENU POINT (LEFT/RIGHT) SELECT (REAR CLICK) POINT (UP/DOWN) SELECT (REAR CLICK)
MENU EXIT	MENU POINT LEFT/RIGHT SELECT	MENU POINT LEFT/RIGHT SELECT	MENU POINT (LEFT/RIGHT) SELECT (REAR CLICK)

### 2. VIDEO MODE (Video Equipped Models Only)

ADJUST ITEM	TOP CONTROL OF THE PROJECTOR	WIRELESS/WIRED REMOTE CONTROL	WIRELESS REMOTE CONTROL
COLOR SYSTEM	MENU POINT LEFT/RIGHT SELECT	MENU POINT LEFT/RIGHT SELECT	MENU POINT (LEFT/RIGHT) SELECT (REAR CLICK)
VIDEO SOURCE VIDEO Y, C Y, Cb, Cr	POINT UP/DOWN SELECT	POINT UP/DOWN SELECT	POINT (UP/DOWN) SELECT (REAR CLICK)
PICTURE IMAGE COLOR TINT WHITE BALANCE CONTRAST BRIGHTNESS SHARPNESS	MENU POINT LEFT/RIGHT SELECT POINT UP/DOWN SELECT	MENU POINT LEFT/RIGHT SELECT POINT UP/DOWN SELECT	MENU POINT (LEFT/RIGHT) SELECT (REAR CLICK) POINT (UP/DOWN) SELECT (REAR CLICK)
PICTURE SCREEN WIDE REGULAR			

### 3. COMPUTER MODE

ADJUST ITEM	TOP CONTROL OF THE PROJECTOR	WIRELESS/WIRED REMOTE CONTROL	WIRELESS REMOTE CONTROL
COMPUTER SYSTEM	MENU POINT LEFT/RIGHT SELECT POINT UP/DOWN SELECT	MENU POINT LEFT/RIGHT SELECT POINT UP/DOWN SELECT	MENU POINT (LEFT/RIGHT) SELECT (REAR CLICK) POINT (UP/DOWN) SELECT (REAR CLICK)
AUTO IMAGE FINE SYNC TOTAL DOTS POSITION	MENU POINT LEFT/RIGHT SELECT POINT UP/DOWN SELECT	MENU POINT LEFT/RIGHT SELECT POINT UP/DOWN SELECT	MENU POINT (LEFT/RIGHT) SELECT (REAR CLICK) POINT (UP/DOWN) SELECT (REAR CLICK)
PICTURE IMAGE FINE SYNC TOTAL DOTS WHITE BALANCE CONTRAST BRIGHTNESS	MENU POINT LEFT/RIGHT SELECT POINT UP/DOWN SELECT	MENU POINT LEFT/RIGHT SELECT POINT UP/DOWN SELECT	MENU POINT (LEFT/RIGHT) SELECT (REAR CLICK) POINT (UP/DOWN) SELECT (REAR CLICK)
PICTURE POSITION	MENU POINT LEFT/RIGHT SELECT POINT LEFT/RIGHT/UP/DOWN SELECT	MENU POINT LEFT/RIGHT SELECT POINT LEFT/RIGHT/UP/DOWN SELECT	MENU POINT (LEFT/RIGHT) SELECT (REAR CLICK) POINT (LEFT/RIGHT/UP/DOWN) SELECT (REAR CLICK)
PC ADJUSTMENT	MENU POINT LEFT/RIGHT SELECT POINT UP/DOWN SELECT	MENU POINT LEFT/RIGHT SELECT POINT UP/DOWN SELECT	MENU POINT (LEFT/RIGHT) SELECT (REAR CLICK) POINT (UP/DOWN) SELECT (REAR CLICK)
PICTURE SCREEN TRUE EXPAND COMPRESSED PANNING	MENU POINT LEFT/RIGHT SELECT POINT UP/DOWN SELECT POINT LEFT/RIGHT/UP/DOWN	MENU POINT LEFT/RIGHT SELECT POINT UP/DOWN SELECT POINT LEFT/RIGHT/UP/DOWN	MENU POINT (LEFT/RIGHT) SELECT (REAR CLICK) POINT (UP/DOWN) SELECT (REAR CLICK) POINT (LEFT/RIGHT/UP/DOWN)

#### NOTES:

1. The MENU, once activated, will not disappear unless you choose MENU EXIT operation. If you switch to DIRECT operation by pressing a DIRECT operation button while in MENU mode, the menus will disappear and the MENU operation will end.
2. You can use the REMOTE CONTROL UNIT or the TOP CONTROL OF THE PROJECTOR to operate the MENU operation.

# USING THE PROJECTOR

## TO TURN ON THE PROJECTOR

Connect the projector to a source (Computer, VCR, Video Camera, Video Disc Player, etc.) using the appropriate terminals on the side of the projector (See "CONNECTING THE PROJECTOR" section on pages 9-16).

Connect the projector's AC power cord into a wall outlet and turn the MAIN ON/OFF switch (located on the side of the projector) to the ON position. The LAMP POWER indicator will light RED, the READY indicator will light GREEN.

Press the LAMP POWER ON/OFF button on the remote control unit or on the projector to ON. The LAMP POWER indicator light will dim and the cooling fans will operate. The wait display appears on the screen and the count-down starts (30-29-28-...1). The signal from the source appears after 30 seconds.

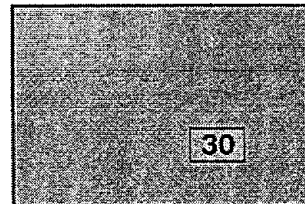

**CAUTION:** THIS PROJECTOR USES A METAL-HALIDE ARC LAMP. TO EXTEND THE LIFE OF THE LAMP, ONCE YOU HAVE TURNED IT ON, WAIT AT LEAST 5 MINUTES BEFORE TURNING IT OFF.

**NOTE:** TEMPERATURE WARNING INDICATOR flashes red, the projector will automatically turn off. Wait at least 5 minutes before turning the projector on.

If the TEMPERATURE WARNING INDICATOR continues to flash, follow the procedures below:

- (1). Press LAMP POWER ON/OFF button to OFF.
- (2). Check the air filter for dust accumulation.
- (3). Remove dust with vacuum cleaner (See "AIR FILTER CARE AND CLEANING" section on page 50.)
- (4). Press LAMP POWER ON/OFF button to ON.

If the TEMPERATURE WARNING INDICATOR still continues to flash, call your authorized dealer or service station.

## TO TURN OFF THE PROJECTOR

Press the LAMP POWER ON/OFF button on the remote control unit or on the projector. The "Power off ?" appears on the screen. Press again the LAMP POWER ON/OFF button to turn OFF the projector. The LAMP POWER indicator will light bright and READY indicator will turn off. The cooling fans will operate for 1 minute after the projector is turned off. (During this "cooling down" period, the projector cannot be turned on.) The READY indicator will light green again and the projector may be turned on by pressing the LAMP POWER ON/OFF button. To power down completely, turn the MAIN ON/OFF switch (located on the side of the projector) to the OFF position.

Power off ?

## DIRECT OPERATION

### MODE SELECT

Press the MODE button (located on remote control unit or on the projector) to select Computer 1, Computer 2, Video 1 or Video 2 Input. The "Computer 1", "Computer 2", "Video 1" or "Video 2" display will appear on the screen for a few seconds.

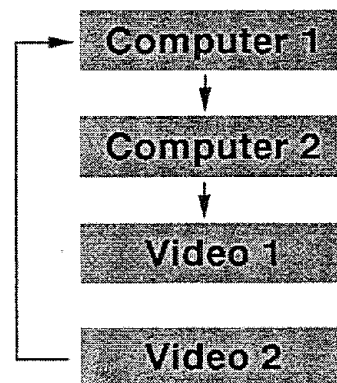



## SOUND VOLUME ADJUSTMENT

Press the VOLUME buttons (located on remote control unit or on the projector) to adjust the volume. The volume display will be displayed on the screen for a few seconds.

Pressing volume (+) will increase volume and increase the number on the screen. Pressing volume (-) will decrease volume and decrease the number on the screen.

## SOUND MUTE FUNCTION

Pressing the MUTE button on the remote control unit will mute audio. Press the MUTE button again to restore audio to its previous level. The mute display will be displayed on the screen for a few seconds.

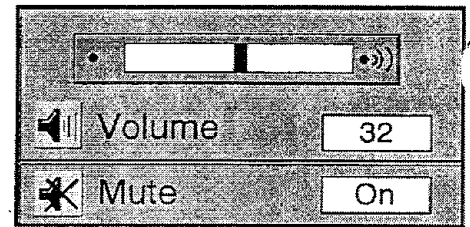

## ZOOM ADJUSTMENT (Top control and Wireless/Wired remote control unit)

Press the ZOOM (+) or (-) button to obtain your desired picture size. For a larger picture, press (+) and for a smaller picture, press (-).

## ZOOM ADJUSTMENT (Wireless remote control unit)

Press the ZOOM button and press POINT UP/DOWN button(s) to obtain your desired picture size. The Zoom display will be displayed on the screen for a few seconds. For a larger picture, press (UP) and for a smaller picture, press (DOWN).



## FOCUS ADJUSTMENT (Top control and Wireless/Wired remote control unit)

Press the FOCUS (+) or (-) button for a sharper, crisper picture.

## FOCUS ADJUSTMENT (Wireless remote control unit)

Press the FOCUS button and press POINT UP/DOWN button(s) to obtain a sharper, crisper picture. The Focus display will be displayed on the screen for a few seconds.



## LENS SHIFT FUNCTION (Top control and Wireless/Wired remote control unit)

Press the LENS SHIFT (+) or (-) button to obtain your desired screen position.

## LENS SHIFT FUNCTION (Wireless remote control unit)

Press the LENS SHIFT button and press POINT UP/DOWN button(s) to obtain your desired screen position. The Lens shift display will be displayed on the screen for a few seconds.



## NORMAL PICTURE FUNCTION

The normal picture level is factory preset on the projector and can be restored anytime by pressing the NORMAL button (located on remote control unit or on the projector). The "Normal" display will be displayed on the screen for a few seconds.



## NO SHOW FUNCTION

Press the NO SHOW button on the remote control unit. The screen will change into black image and the "NO SHOW" is displayed on the screen for a few seconds.

This function is cancelled when the NO SHOW button is pressed again or any other function button is pressed.



## P-TIMER FUNCTION

Press the P-TIMER button on the remote control unit. The timer display "00:00" appears on the screen and the timer starts to count the time (00:00-59:59).

Press again the P-TIMER button to stop the timer. Then press the P-TIMER button to cancel the P-TIMER function.

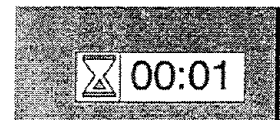

## FREEZE PICTURE FUNCTION

Press the FREEZE button on the remote control unit, and the picture will remain on-screen. This function is cancelled when the FREEZE button is pressed again or any other function button is pressed.

**NOTE:** Your computer or video equipment is not affected by this function, and will continue to run.

## AUTO IMAGE FUNCTION

Press the AUTO IMAGE button on the remote control unit or on the projector. The item(s) indicated "ON" in the AUTO IMAGE FUNCTION are adjusted automatically.

If any items in AUTO IMAGE FUNCTION are "OFF", AUTO IMAGE SETTING display appears. If you wish to operate the AUTO IMAGE FUNCTION, perform the steps 3 - 9 of "AUTO IMAGE FUNCTION" section on page 39.

## MENU OPERATION

In MENU OPERATION mode, you can adjust the projector. You can use the TOP CONTROL OF THE PROJECTOR or the REMOTE CONTROL UNIT.

### CONTROL OF THE PROJECTOR

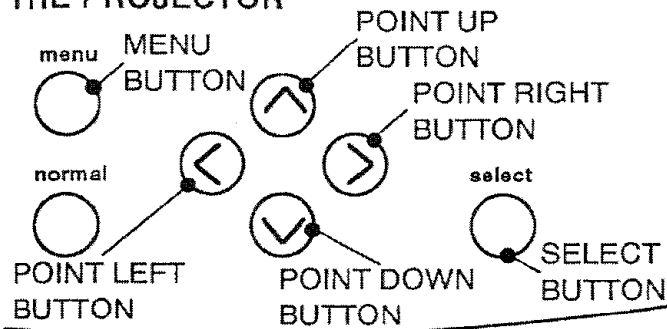

### WIRELESS/WIRED REMOTE CONTROL UNIT

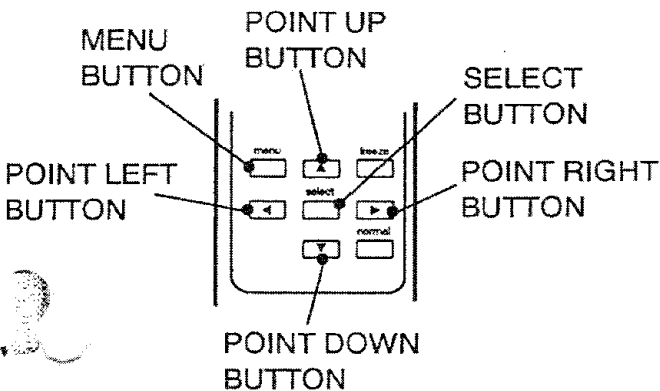

### WIRELESS REMOTE CONTROL UNIT

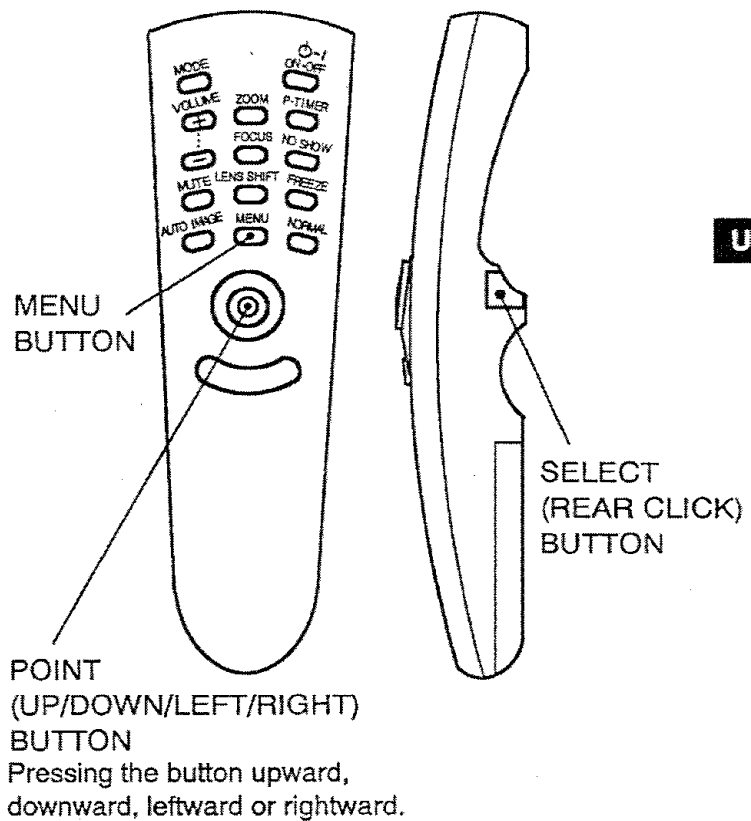

## MODE SELECT

You can select a mode from MAIN MENU display among computer 1, computer 2, video 1 and video 2.

1. Press the MENU BUTTON and the MAIN MENU DISPLAY dialog box will appear.
2. Press the POINT LEFT/RIGHT BUTTON(s) to select Computer or Video and press the SELECT (REAR CLICK) BUTTON. Another dialog box MODE DISPLAY will appear.
3. Press the POINT DOWN BUTTON and a red arrow will appear.
4. Move the arrow to the mode you want (computer 1, computer 2, video 1 or video 2) to use by pressing the POINT UP/DOWN BUTTON(s) and then press the SELECT (REAR CLICK) BUTTON.

### MAIN MENU DISPLAY

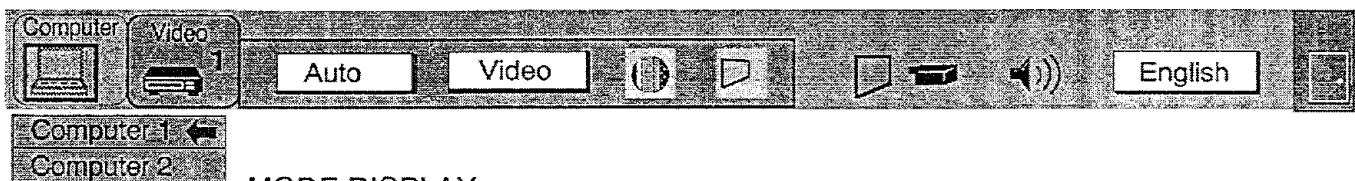

### MODE DISPLAY

### MAIN MENU DISPLAY

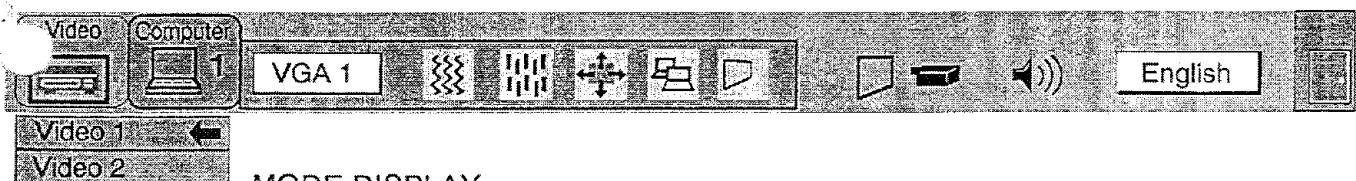

### MODE DISPLAY

## VIDEO SOURCE SELECT (VIDEO MODE) Video-Equipped Models Only

1. Connect the video equipment to the PROJECTOR, and turn them on projector first.
2. Set MODE SELECT to "VIDEO MODE".
3. Press the MENU BUTTON and the MAIN MENU DISPLAY dialog box will appear.  
Press the POINT LEFT/RIGHT BUTTON(s) to select VIDEO SOURCE and press the SELECT (REAR CLICK) BUTTON. Another dialog box VIDEO SOURCE DISPLAY will appear. The current VIDEO SOURCE is displayed in the window.
5. Press the POINT DOWN BUTTON and a red arrow will appear.
6. To change the current VIDEO SOURCE, press the POINT UP/DOWN BUTTON(s) to move the arrow to a desirable video source and then press the SELECT (REAR CLICK) BUTTON.
7. The setting changed remains effective until the MAIN ON/OFF switch is turned off.

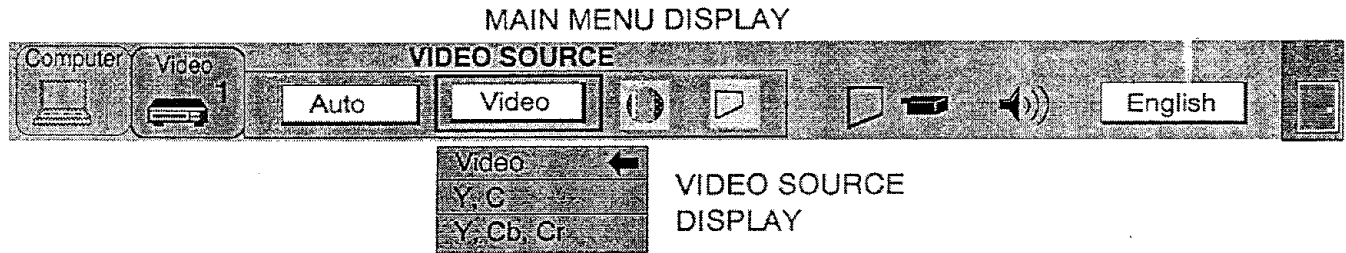



# PICTURE IMAGE ADJUSTMENT (VIDEO MODE) Video-Equipped Models Only

Picture adjustments have been preset at the factory. If you want to change the setting, operate the projector as follows.

1. Press the MENU BUTTON and the MAIN MENU DISPLAY dialog box will appear.
2. Press the POINT LEFT/RIGHT BUTTON(s) to select IMAGE and press the SELECT (REAR CLICK) BUTTON. Another dialog box IMAGE ADJUST DISPLAY will appear. This shows the current picture settings.
3. In this dialog box, you can adjust the settings by increasing or decreasing the levels shown as numbers. The items and the range of the levels that you can adjust are summarized in the table below.
4. Press the POINT DOWN BUTTON and a red arrow will appear.
5. Move the arrow to an item that you want to adjust by pressing the POINT UP/DOWN BUTTON(s).
6. To increase the level, point the arrow to  $\Delta$  and then press the SELECT (REAR CLICK) BUTTON. To decrease the level, point the arrow to  $\nabla$  and then press the SELECT (REAR CLICK) BUTTON.
7. You may want to store the settings in the memory so that you can recall them later. To store the settings, move the arrow to Stored and then press the SELECT (REAR CLICK) BUTTON. When you have stored the settings, "OK ?" is displayed for confirmation.
8. Move the arrow to Yes and then press the SELECT (REAR CLICK) BUTTON. The stored settings are permanently held even if the MAIN ON/OFF is switched off.
9. To quit the MENU, move the arrow to Quit and then press the SELECT (REAR CLICK) BUTTON.
10. If you do not want to store the settings, move the arrow to Quit and then press the SELECT (REAR CLICK) BUTTON. The settings changed remains effective until the MAIN ON/OFF switch is turned off.
11. To recall the settings from the memory that you have stored, move the arrow to Reset and then press the SELECT (REAR CLICK) BUTTON. When you have reset the settings, "OK ?" is displayed for confirmation. Move the arrow to Yes and then press the SELECT (REAR CLICK) BUTTON. You can adjust the settings again if needed.

NOTE: "TINT" will be skipped in the PAL, SECAM, PAL-M and PAL-N mode.

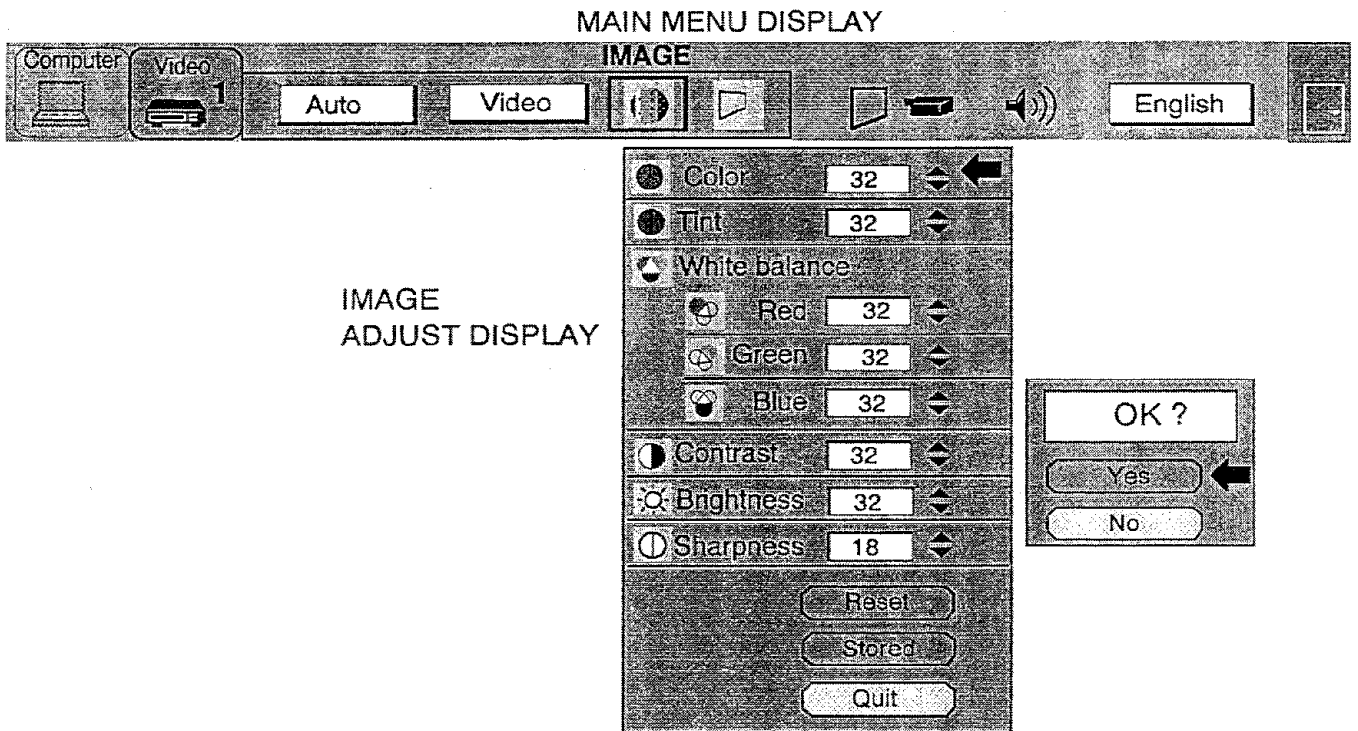

TABLE OF PICTURE IMAGE ADJUSTMENT

COLOR	DECREASES	0	←→	63	INCREASES
TINT	MORE PURPLE	0	←→	63	MORE GREEN
WHITE BALANCE (R/G/B)	DECREASES	0	←→	63	INCREASES
CONTRAST	LIGHTER	0	←→	63	DEEPER
BRIGHTNESS	DARKER	0	←→	63	BRIGHTER
SHARPNESS	SOFTER	0	←→	31	SHARPER

## PICTURE SCREEN ADJUSTMENT (VIDEO MODE) Video-Equipped Models Only

This projector has the Wide function, which enables you to view a wider video image.

### WIDE function

This projector is able to project not only a normal video image (with 4 x 3 aspect ratio), but also a wider video image compressing 4 x 3 image. This feature enables you to enjoy watching pictures like cinema images. You can switch either to WIDE or to REGULAR screen mode.

1. Press the MENU BUTTON and the MAIN MENU DISPLAY dialog box will appear.
2. Press the POINT LEFT/RIGHT BUTTON(s) to select SCREEN and press the SELECT (REAR CLICK) BUTTON. Another dialog box SCREEN ADJUST DISPLAY will appear.
3. Press the POINT DOWN BUTTON and a red arrow will appear.
4. To switch to "Wide" mode, move the arrow to Wide by pressing the POINT UP/DOWN BUTTON(s) and then press the SELECT (REAR CLICK) BUTTON.
5. To switch to "Regular" mode, move the arrow to Regular by pressing the POINT UP/DOWN BUTTON(s) and then press the SELECT (REAR CLICK) BUTTON.
6. The "Wide" settings remain effective until the MAIN ON/OFF switch is turned off.

### MAIN MENU DISPLAY

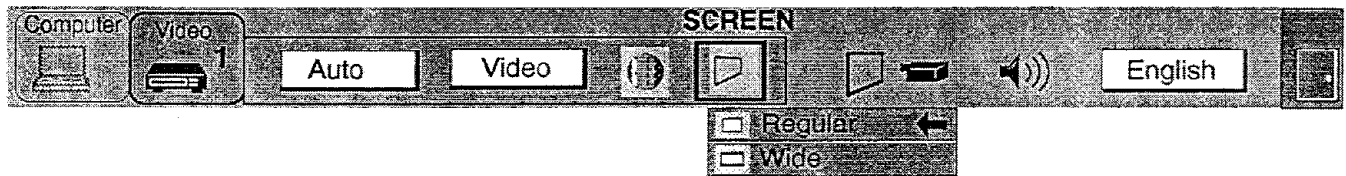

### SCREEN ADJUST DISPLAY

## COMPUTER SYSTEM SELECT (COMPUTER MODE)

This projector is adjustable to different types of computer display signals based on VGA, SVGA, XGA or SXGA (See "COMPATIBLE COMPUTER SPECIFICATIONS" on the next page). If you set MODE SELECT to "COMPUTER", the projector will automatically process the incoming signal and project the proper image without any special setting. Although this will work in most cases, you may be required to manually set the projector for some computer signals. If the computer image is not reproduced properly, try the following procedure and switch to the computer display mode that you want to use.

1. Connect the COMPUTER to the PROJECTOR, and turn them on projector first.
2. Set MODE SELECT to "COMPUTER MODE (1 or 2)". This shows the current display mode initially detected by the projector in the system window. And "Current mode" display appears.

NOTE: 1. If the projector cannot discriminate or detect the input signal from the computer, the "Go PC adj." display appears.

NOTE: 2. If no input signal from the computer, the "No signal" display appears on the screen.

3. Press the MENU BUTTON and the MAIN MENU DISPLAY dialog box will appear.
4. Press the POINT LEFT/RIGHT BUTTON(s) to select SYSTEM and press the SELECT (REAR CLICK) BUTTON. Another dialog box COMPUTER SYSTEM DISPLAY will appear.
5. Press the POINT DOWN BUTTON and a red arrow will appear.
6. If you want to change the current display mode, move the arrow by pressing the POINT UP/DOWN BUTTON(s) to select one of the modes.
7. Press the SELECT (REAR CLICK) BUTTON to change the display mode.
8. To quit the MENU, move the arrow to Quit and then press the SELECT (REAR CLICK) BUTTON.

### MAIN MENU DISPLAY



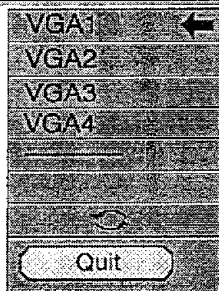

COMPUTER SYSTEM DISPLAY

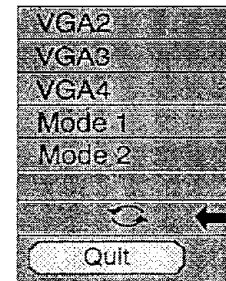
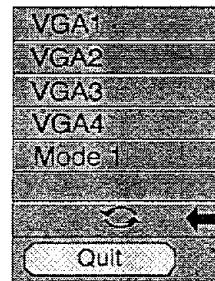
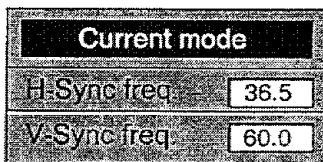

CURRENT MODE DISPLAY



When the mark (  ) is displayed as BLACK, computer system mode will be available on the next page. Move an arrow to the mark (  ) and press the SELECT (REAR CLICK) BUTTON to show computer system mode described on the next page.

## PC ADJUSTMENT

This is a special function that may be used when a computer image is not reproduced properly. (See the pages 42 ~ 45 for more detail.)

# COMPATIBLE COMPUTER SPECIFICATIONS

ON-SCREEN DISPLAY	RESOLUTION	H-Freq. (kHz)	V-Freq. (Hz)	ON-SCREEN DISPLAY	RESOLUTION	H-Freq. (kHz)	V-Freq. (Hz)
VGA1	640 × 480	31.47	59.88	XGA9	1024 × 768	36.00	87.17 (Interlace)
VGA2	720 × 400	31.47	70.09	XGA10	1024 × 768	62.04	77.07
VGA3	640 × 400	31.47	70.09	XGA11	1024 × 768	61.00	75.70
VGA4	640 × 480	37.86	74.38	XGA12	1024 × 768	35.522	86.96 (Interlace)
VGA5	640 × 480	37.86	72.81	XGA13	1024 × 768	46.90	58.20
VGA6	640 × 480	37.50	75.00	XGA14	1024 × 768	47.00	58.30
MAC LC13	640 × 480	34.97	66.60	MAC19	1024 × 768	60.24	75.08
MAC 13	640 × 480	35.00	66.67	SXGA1	1152 × 864	64.20	70.40
PC98	640 × 400	24.83	56.42	SXGA2	1280 × 1024	62.50	58.60
FM TOWNS	640 × 400	24.38	55.40	SXGA3	1280 × 1024	63.90	60.00
SVGA1	800 × 600	35.156	56.25	SXGA4	1280 × 1024	63.34	59.98
SVGA2	800 × 600	37.88	60.32	SXGA5	1280 × 1024	63.74	60.01
SVGA3	800 × 600	46.875	75.00	SXGA6	1280 × 1024	71.69	67.19
SVGA4	800 × 600	53.674	85.06	SXGA7	1280 × 1024	81.13	76.107
SVGA5	800 × 600	48.08	72.19	SXGA8	1280 × 1024	63.98	60.02
SVGA6	800 × 600	37.90	61.03	SXGA9	1280 × 1024	79.976	75.025
SVGA7	800 × 600	34.50	55.38	SXGA10	1280 × 960	60.00	60.00
SVGA8	800 × 600	38.00	60.51	SXGA11	1152 × 900	61.20	65.20
SVGA9	800 × 600	38.60	60.31	SXGA12	1152 × 900	71.40	75.60
SVGA10	800 × 600	47.90	71.92	SXGA13	1280 × 1024	50.00	86.00 (Interlace)
SVGA11	800 × 600	32.70	51.09	SXGA14	1280 × 1024	50.00	94.00 (Interlace)
SVGA12	800 × 600	38.00	60.51	SXGA15	1280 × 1024	63.37	60.01
MAC 16	832 × 624	49.72	74.55	SXGA16	1280 × 1024	76.97	72.00
XGA1	1024 × 768	48.36	60.00	SXGA17	1152 × 900	61.85	66.00
XGA2	1024 × 768	68.677	84.997	SXGA18	1280 × 1024	46.43	86.70 (Interlace)
XGA3	1024 × 768	60.023	75.03	SXGA19	1280 × 1024	63.79	60.18
XGA4	1024 × 768	56.47	70.07	MAC21	1152 × 870	68.68	75.06
XGA5	1024 × 768	60.31	74.92	MAC	1280 × 960	75.00	75.08
XGA6	1024 × 768	48.50	60.02	MAC	1280 × 1024	80.00	75.08
XGA7	1024 × 768	44.00	54.58				
XGA8	1024 × 768	63.48	79.35				

Specifications are subject to change without notice.

**NOTE:** This projector can accept the signal from all computers with the above mentioned V, H-Frequency and less than 135 MHz Dot Clock.

## AUTO IMAGE FUNCTION (COMPUTER MODE)

The Auto image function is provided to automatically adjust Fine sync., Total dots and Screen position for most computers.

- Press the MENU BUTTON and the MAIN MENU DISPLAY dialog box will appear.
- Press the POINT LEFT/RIGHT BUTTON(s) to select AUTO IMAGE and press the SELECT (REAR CLICK) BUTTON. Another dialog box AUTO IMAGE SETTING DISPLAY will appear.
- Press the POINT DOWN BUTTON and a red arrow will appear.
- Move the arrow to an item(s) you want to adjust by pressing the POINT UP/DOWN BUTTON(s).
- Change the setting "On", press the SELECT (REAR CLICK) BUTTON.
- Move the arrow by pressing the POINT UP/DOWN BUTTON(s) to select "Go!" and then press the SELECT (REAR CLICK) BUTTON. The auto image function is started now. It will take about 10 seconds.
- To store the settings, move the arrow to Stored and then press the SELECT (REAR CLICK) BUTTON. When you have stored the settings, "OK?" is displayed for confirmation.
- Move the arrow to Yes and then press the SELECT (REAR CLICK) BUTTON. The stored settings are permanently held even if the MAIN ON/OFF is switched off.
- To quit the MENU, point to Quit and then press the SELECT (REAR CLICK) BUTTON.
- This setting is temporarily effective until you turn off the projector or change the input signal.

NOTE: The fine sync., total dots and screen position of some computers may not be fully adjusted with the "Auto Image Function". In that case, use the "Picture Image" and/or "Picture Position" adjustments (see pages 40 ~ 41) to make fine-adjust them after the "Auto Image Function" is executed.

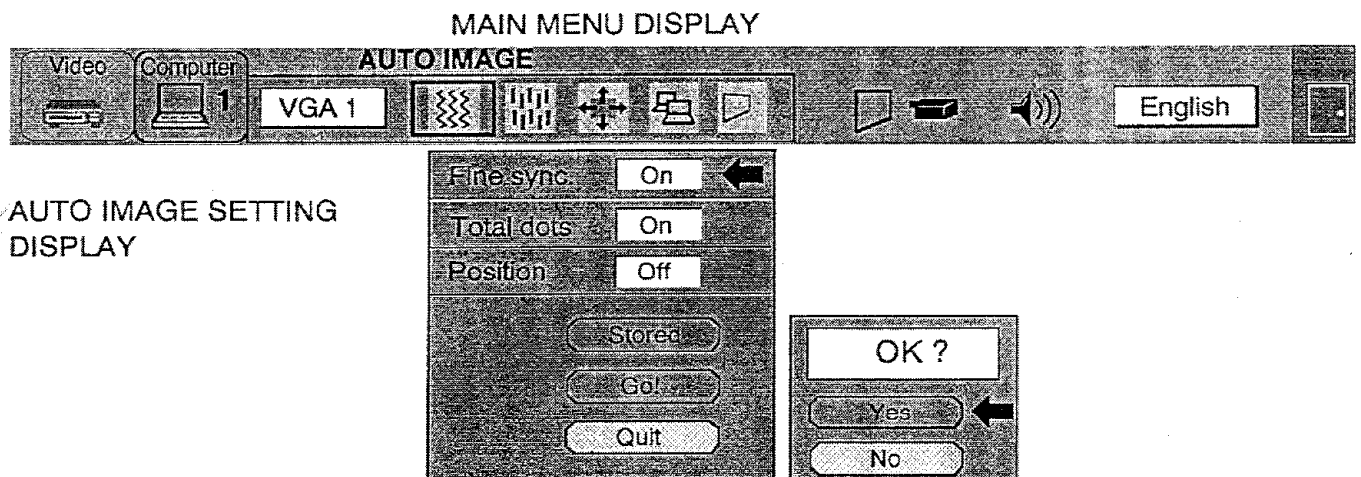



# PICTURE IMAGE ADJUSTMENT (COMPUTER MODE)

Picture adjustments have been preset at the factory. If you want to change the setting, operate the projector as follows.

1. Press the MENU BUTTON and the MAIN MENU DISPLAY dialog box will appear.
2. Press the POINT LEFT/RIGHT BUTTON(s) to select IMAGE and press the SELECT (REAR CLICK) BUTTON. Another dialog box IMAGE ADJUST DISPLAY will appear. This shows the current picture settings.
3. In this dialog box, you can adjust the settings by increasing or decreasing the levels shown as numbers. The items and the range of the levels that you can adjust are summarized in the table below.
4. Press the POINT DOWN BUTTON and a red arrow will appear.
5. Move the arrow to an item that you want to adjust by pressing the POINT UP/DOWN BUTTON(s).
6. To increase the level, point the arrow to  $\Delta$  and then press the SELECT (REAR CLICK) BUTTON. To decrease the level, point the arrow to  $\nabla$  and then press the SELECT (REAR CLICK) BUTTON.
7. You may want to store the settings in the memory so that you can recall them later. To store the settings, move the arrow to Stored and then press the SELECT (REAR CLICK) BUTTON. When you have stored the settings, "OK ?" is displayed for confirmation.
8. Move the arrow to Yes and then press the SELECT (REAR CLICK) BUTTON. The stored settings are permanently held even if the MAIN ON/OFF is switched off.
9. To quit the MENU, move the arrow to Quit and then press the SELECT (REAR CLICK) BUTTON.
10. If you do not want to store the settings, move the arrow to Quit and then press the SELECT (REAR CLICK) BUTTON. The settings changed remains effective until the MAIN ON/OFF switch is turned off.
11. To recall the settings from the memory that you have stored, move the arrow to Reset and then press the SELECT (REAR CLICK) BUTTON. When you have reset the settings, "OK ?" is displayed for confirmation. Move the arrow to Yes and then press the SELECT (REAR CLICK) BUTTON. You can adjust the settings again if needed.

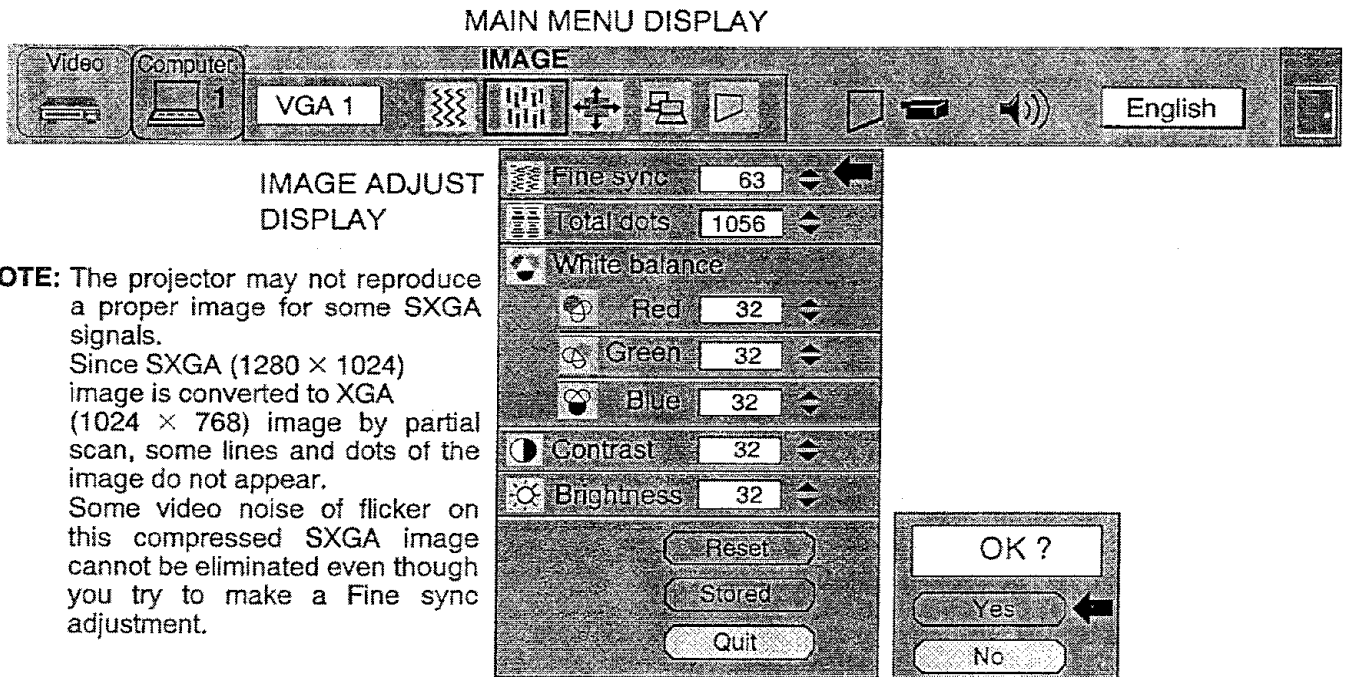

**NOTE:** The projector may not reproduce a proper image for some SXGA signals. Since SXGA (1280 × 1024) image is converted to XGA (1024 × 768) image by partial scan, some lines and dots of the image do not appear. Some video noise of flicker on this compressed SXGA image cannot be eliminated even though you try to make a Fine sync adjustment.

TABLE OF PICTURE IMAGE ADJUSTMENT

<b>FINE SYNC</b>	Adjust the picture as necessary to eliminate flicker from the display. 0 $\longleftrightarrow$ 127
<b>TOTAL DOTS</b>	The number of the total dots in one horizontal period. Adjust the number to match your PC image.
<b>WHITE BALANCE (R/G/B)</b>	DECREASE 0 $\longleftrightarrow$ 63 INCREASE
<b>CONTRAST</b>	LIGHTER 0 $\longleftrightarrow$ 63 DEEPER
<b>BRIGHTNESS</b>	DARKER 0 $\longleftrightarrow$ 63 BRIGHTER

## PICTURE POSITION ADJUSTMENT (COMPUTER MODE)

1. Press the MENU BUTTON and the MAIN MENU DISPLAY dialog box will appear.
2. Press the POINT LEFT/RIGHT BUTTON(s) to select POSITION and press the SELECT (REAR CLICK) BUTTON. Another dialog box POSITION SETTING DISPLAY will appear.
3. Press the POINT DOWN BUTTON and a red arrow will appear.
4. Move the arrow to a desirable direction ( ← , → , ↑ or ↓ ) by pressing the POINT LEFT/RIGHT/UP/DOWN BUTTON(s) and press the SELECT (REAR CLICK) BUTTON to a desirable picture position.
5. You may want to store the settings to the memory so that you can recall them later. To store the settings, move the arrow to Stored and then press the SELECT (REAR CLICK) BUTTON. When you have stored the settings, "OK ?" is displayed for confirmation.
6. Move the arrow to Yes and then press the SELECT (REAR CLICK) BUTTON. The stored settings are permanently held even if the MAIN ON/OFF is switched off.
7. To quit the MENU, move the arrow to Quit and then press the SELECT (REAR CLICK) BUTTON.
8. If you do not want to store the settings, move the arrow to Quit and then press the SELECT (REAR CLICK) BUTTON. The settings changed remains effective until the MAIN ON/OFF switch is turned off.
9. To recall the settings from the memory that you have stored, move the arrow to Reset and then press the SELECT (REAR CLICK) BUTTON. When you have reset the settings, "OK ?" is displayed for confirmation. Move the arrow to Yes and then press the SELECT (REAR CLICK) BUTTON. You can adjust the settings again if needed.

### MAIN MENU DISPLAY



### POSITION SETTING DISPLAY

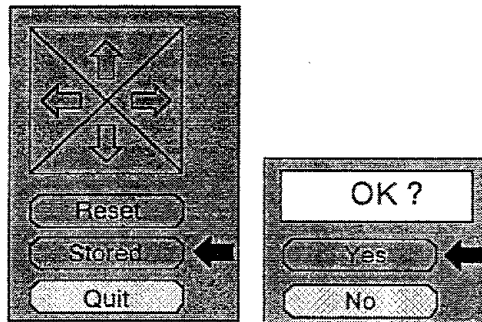

## PC ADJUSTMENT

This projector can automatically detect most display signals from most personal computers currently distributed. However, some computers adopt a special signal format which is different from the standard one and the projector cannot detect it. If this happens, the projector cannot reproduce a proper image. And a flickering picture, a non-synchronized picture, a non-centered picture or a skewed picture may be projected instead.

For those non-standard formats, this projector is provided with PC ADJUST, enabling you to precisely adjust several parameters to match with the input signal format. The projector has eight independent memory areas where you can store the parameter you have set. This enables you to recall the setting for a specific computer when you need it.

1. Press the MENU BUTTON and the MAIN MENU DISPLAY dialog box will appear.
2. Press the POINT LEFT/RIGHT BUTTON(s) to select PC ADJUST and press the SELECT (REAR CLICK) BUTTON. Another dialog box "Where to reserve" will appear.
3. In this dialog box, you will select one of the memory areas from among "Mode 1" to "Mode 8". If parameters have been previously set and stored in the memory, the status "Stored" will appear on the corresponding row. If not, "Free" will appear.
4. Press the POINT DOWN BUTTON and a red arrow will appear.
5. Move the arrow to one of the "Modes" (Free position) where you want to store the parameters by pressing the POINT UP/DOWN BUTTON(s). Press the SELECT (REAR CLICK) BUTTON to select it.

NOTE; If "Stored" appears in all Modes, no new PC parameter data can be stored. In this case, clear the PC parameter data using the Mode free Function.

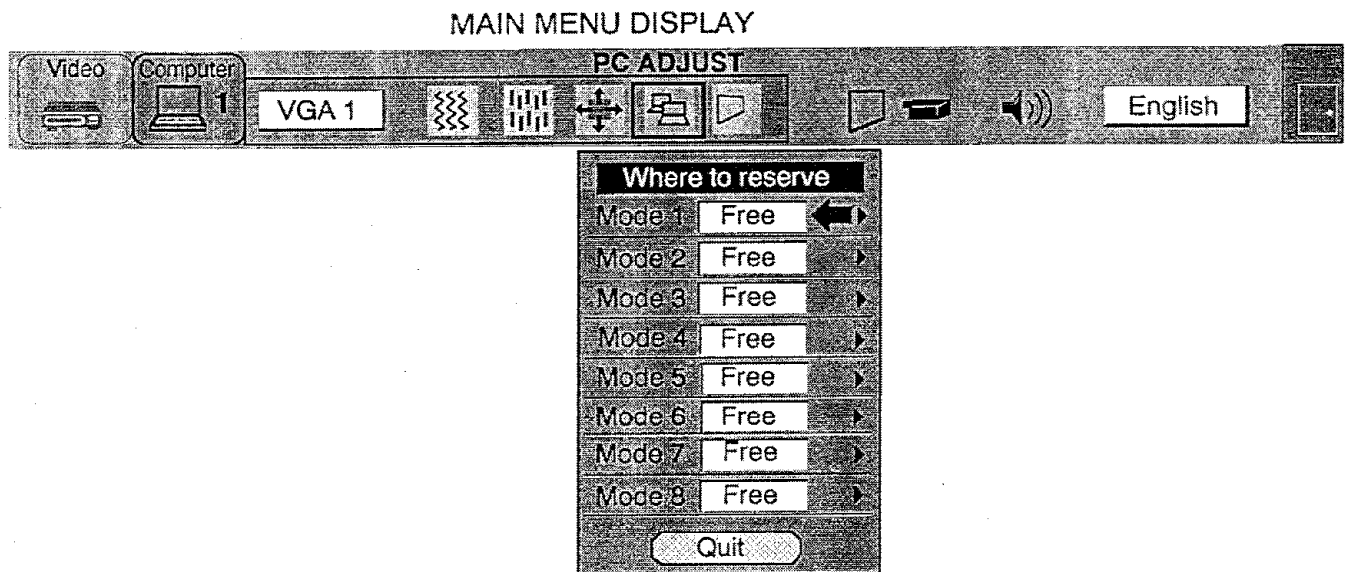



6. Another dialog box "PC ADJUSTMENT DISPLAY 1" will appear and the parameter data for the Mode you have selected is shown in this dialog box.
7. The parameters will be filled with the data determined by the projector according to the present signal input.
8. The function of the parameters and their values are summarized in the table below.
9. Move the arrow to an item that you want to adjust by pressing the POINT UP/DOWN BUTTON(s).
10. To increase the level, point the arrow to  $\Delta$  and then press the SELECT (REAR CLICK) BUTTON. To decrease the level, point the arrow to  $\nabla$  and then press the SELECT (REAR CLICK) BUTTON.
11. If you want to store the settings in the memory, move the arrow to Stored and press the SELECT (REAR CLICK) BUTTON. When you have stored the settings, "OK ?" is displayed for confirmation. Move the arrow to Yes and then press the SELECT (REAR CLICK) BUTTON.
12. To recall the parameter data before setting, move the arrow to Reset and then press the SELECT (REAR CLICK) BUTTON. When you have reset the settings, "OK ?" is displayed for confirmation. Move the arrow to Yes and then press the SELECT (REAR CLICK) BUTTON. You can adjust the settings again if needed.
13. To quit the MENU, move the arrow to Quit and then press the SELECT (REAR CLICK) BUTTON.
14. If you quit the MENU without storing the settings in the memory, the parameter data you changed will not be kept.
15. The stored settings are permanently held even if the MAIN ON/OFF is switched off.
16. Adjust the data such as a "Clamp", "Height" and "Width" if needed, move the arrow by pressing the POINT UP/DOWN BUTTON(s) to select ( $\nabla$ ). Press the SELECT (REAR CLICK) BUTTON.

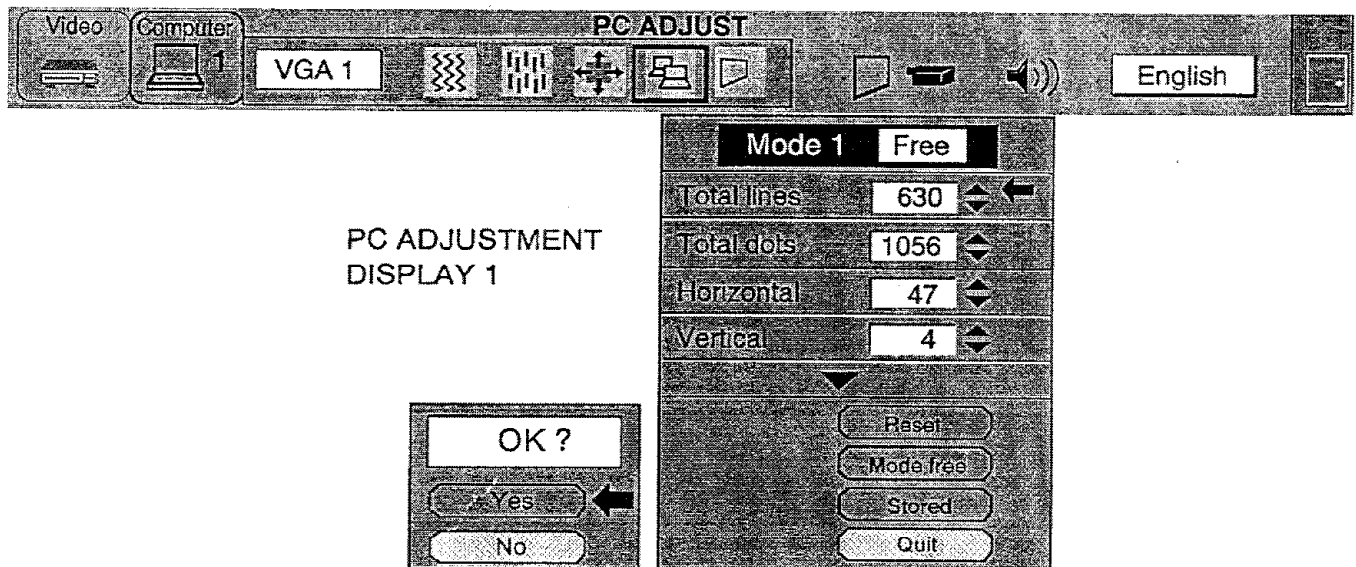

ITEM	FUNCTION
TOTAL LINES	The number of the total vertical lines. Adjust the number to match your PC image.
TOTAL DOTS	The number of the total dots in one horizontal period. Adjust the number to match your PC image.
HORIZONTAL	Adjustment of the horizontal picture position. When the image is not centered on the screen, adjust this.
VERTICAL	Adjustment of the vertical picture position. When the image is not centered on the screen, adjust this.

17. Another dialog box "PC ADJUSTMENT DISPLAY 2" will appear and the parameter data for the Mode you have selected is shown in this dialog box.
18. Move the arrow to an item that you want to adjust by pressing the POINT UP/DOWN BUTTON(s).
19. To increase the level, point the arrow to  $\Delta$  and then press the SELECT (REAR CLICK) BUTTON. To decrease the level, point the arrow to  $\nabla$  and then press the SELECT (REAR CLICK) BUTTON.
20. If you want to store the settings in the memory, move the arrow to Stored and press the SELECT (REAR CLICK) BUTTON. When you have stored the settings, "OK ?" is displayed for confirmation. Move the arrow to Yes and then press the SELECT (REAR CLICK) BUTTON .
21. To recall the parameter data before setting, move the arrow to Reset and then press the SELECT (REAR CLICK) BUTTON. When you have reset the settings, "OK ?" is displayed for confirmation. Move the arrow to Yes and then press the SELECT (REAR CLICK) BUTTON . You can adjust the settings again if needed.
22. To quit the MENU, move the arrow to Quit and then press the SELECT (REAR CLICK) BUTTON.
23. If you quit the MENU without storing the settings in the memory, the parameter data you changed will not be kept.
24. The stored settings are permanently held even if the MAIN ON/OFF is switched off.

**A**

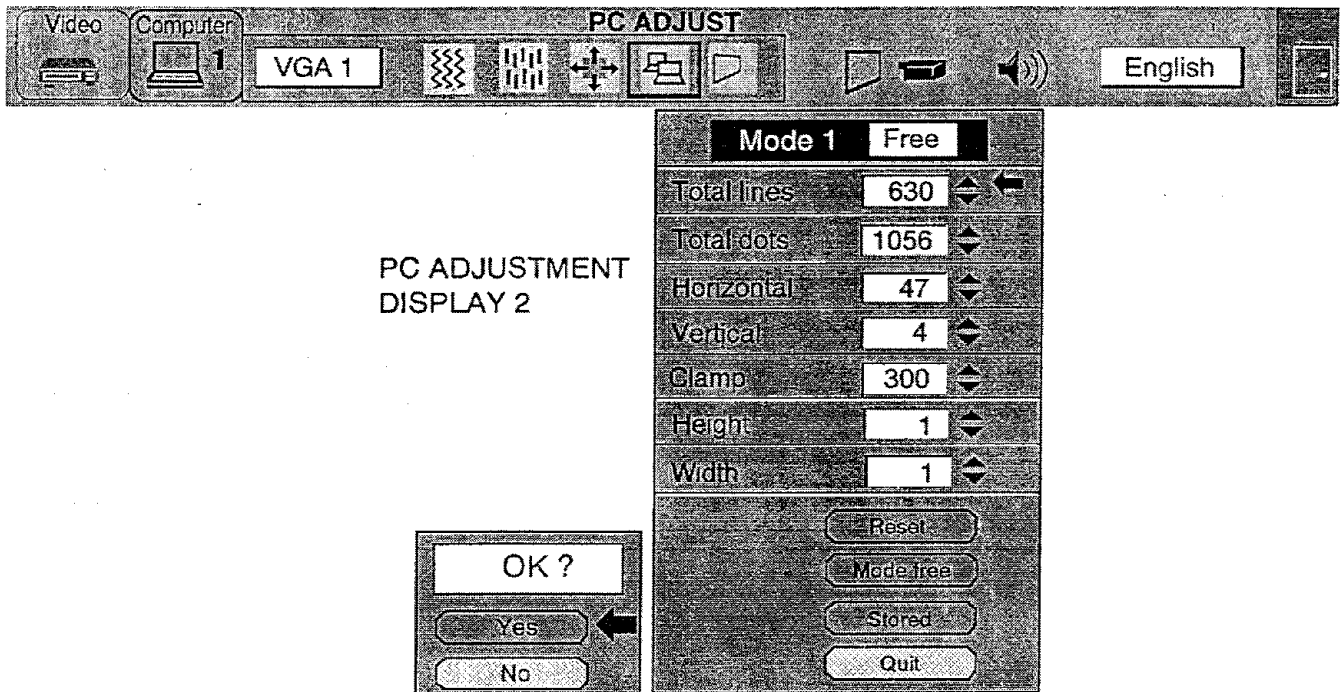

ITEM	FUNCTION
CLAMP	Adjustment of the clamp level. When the image has a dark bar, try this adjustment.
HEIGHT	Expanding or compressing level for the vertical direction.
WIDTH	Expanding or compressing level for the horizontal direction.

## MODE FREE

The Mode free function is provided to confirm or clear the parameter data produced by PC ADJUST.

1. Press the MENU BUTTON and the MAIN MENU DISPLAY dialog box will appear.
2. Press the POINT LEFT/RIGHT BUTTON(s) to select PC ADJUST and press the SELECT (REAR CLICK) BUTTON. Another dialog box "Where to reserve" will appear.
3. Press the POINT DOWN BUTTON and a red arrow will appear.
4. Move the arrow to one of the "Modes" (Stored position) that you want to confirm by pressing the POINT UP/DOWN BUTTON(s). Press the SELECT (REAR CLICK) BUTTON. Another dialog box "PC ADJUSTMENT DISPLAY" will appear.
5. To quit the MENU, point to Quit and then press the SELECT (REAR CLICK) BUTTON.
6. To modify the parameter data, perform the steps 9 - 24 of PC ADJUSTMENT SECTION.
7. To clear the parameter data, move the arrow by pressing the POINT UP/DOWN BUTTON(s) to select Mode free. Press the SELECT (REAR CLICK) BUTTON. "OK?" is displayed for confirmation.
8. Move the arrow to Yes and then press the SELECT (REAR CLICK) BUTTON to clear the parameter data.
9. To quit the MENU, move the arrow to Quit and then press the SELECT (REAR CLICK) BUTTON.

### MAIN MENU DISPLAY



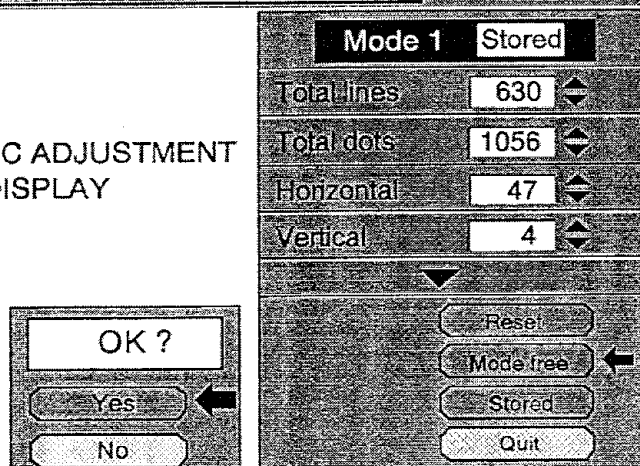

### PC ADJUSTMENT DISPLAY

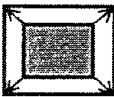

## PICTURE SCREEN ADJUSTMENT (COMPUTER MODE)

This projector has a picture screen resize function, which enables you to project the image size.

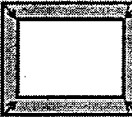
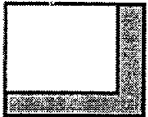
Input image resolution	True Mode	Expand Mode	Compressed Mode	Panning Mode
Less than XGA (1024 × 768) image			None	None
XGA (1024 × 768) image		None	None	None
More than XGA (1024 × 768) image	None	None		

1. Press the MENU BUTTON and the MAIN MENU DISPLAY dialog box will appear.
2. Press the POINT LEFT/RIGHT BUTTON(s) to select SCREEN and press the SELECT (REAR CLICK) BUTTON. Another dialog box SCREEN ADJUST DISPLAY will appear.
3. Press the POINT DOWN BUTTON and a red arrow will appear.
4. To switch to "Expand mode", move the arrow to Expand by pressing the POINT UP/DOWN BUTTON(s) and then press the SELECT (REAR CLICK) BUTTON. The mode is changed "Expand".
5. To switch to "True mode", move the arrow to True by pressing the POINT UP/DOWN BUTTON(s) and then press the SELECT (REAR CLICK) BUTTON. The mode is changed "True".
6. To switch to "Compressed mode", move the arrow to Compressed by pressing the POINT UP/DOWN BUTTON(s) and then press the SELECT (REAR CLICK) BUTTON. The mode is changed "Compressed".  
To switch to "Panning mode", move the arrow to Panning by pressing the POINT UP/DOWN BUTTON(s) and then press the SELECT (REAR CLICK) BUTTON. The mode is changed "Panning".

Press the POINT UP/DOWN/LEFT/RIGHT BUTTON(s) to move the panning image position. The display of "Quit" is appearing on the screen during panning mode. If this display is disappeared, the panning mode is cancelled.

8. Press the SELECT (REAR CLICK) BUTTON to disappear the "Quit" display and panning mode is cancelled.
9. This setting is temporarily effective until you turn off the MAIN ON/OFF switch.

NOTE: The normal "Panning Operation" may not function properly if the computer system prepared with the "PC Adjust" is used.

### MAIN MENU DISPLAY



SCREEN ADJUST  
DISPLAY



When input is VGA (640 × 480) or SVGA (800 × 600) image.



When input is XGA (1024 × 768) image.



When input is SXGA (1280 × 1024) image.

## OTHER FUNCTION SETTING

This projector has other function settings; Blue back, Display, Reverse T/B, Reverse R/L, Split wipe and Lamp age.

### BLUE BACK

When this function is in the "On" position, the projector will project a blue image without video noise on the screen when the video source is unplugged or turned off.

### DISPLAY

When this function is in the "On" position, on-screen displays always appear when adjustments are made. Although these on-screen displays are very helpful, these may spoil the view if adjustments are made during presentations. To avoid this, you can keep back certain displays by switching this function "Off". The followings are the displays that you can hide.

- Wait Display
- Mode Display
- Volume Display
- Mute Display
- Zoom/Focus/Lens shift Display
- Normal Display
- No show Display

### REVERSE T/B

When this function is in the "On" position, the top/bottom picture reverse.

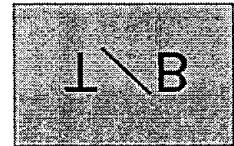
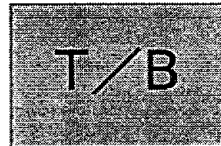

### REVERSE L/R

When this function is in the "On" position, the left/right picture reverse capability lets you project onto a rear projection screen.

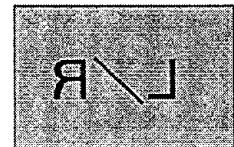
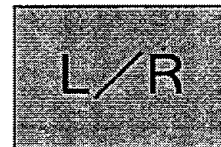

### SPLIT WIPE

Turn SPLIT WIPE function On in the SETTING menu. The picture will change into next one by sliding black image side ways when the input source is changed.

Change the input source by MODE button. The picture is replaced by black image from side ways to the center, and the next one appears from the center to side ways like drawing the black curtains.

### LAMP AGE

The Lamp age function is designed to reset the lamp replacement monitor timer. When replacing the lamp, reset the lamp replacement monitor timer by using this function.

## BLUE BACK, DISPLAY, REVERSE T/B, REVERSE L/R AND SPLIT WIPE

1. Press the MENU BUTTON and the MAIN MENU DISPLAY dialog box will appear.
2. Press the POINT LEFT/RIGHT BUTTON(s) to select SETTING and press the SELECT (REAR CLICK) BUTTON. Another dialog box SETTING DISPLAY will appear.
- Press the POINT DOWN BUTTON and a red arrow will appear.
4. Move the arrow to an item you want to set by pressing the POINT UP/DOWN BUTTON(s).
5. If you want to change the setting (On or Off), press the SELECT (REAR CLICK) BUTTON.
6. To quit the MENU, point to Quit and then press the SELECT (REAR CLICK) BUTTON.
7. The settings are permanently kept even if the MAIN ON/OFF is switched off.

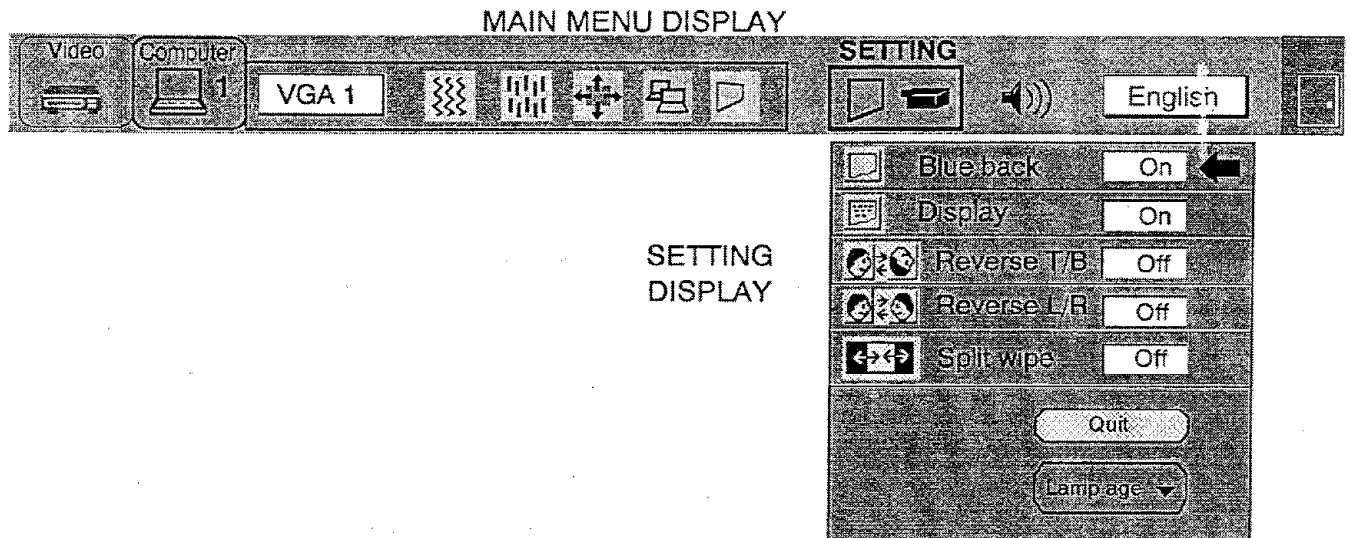

## LAMP AGE

NOTE: Do not reset the LAMP REPLACEMENT MONITOR TIMER, except after the lamp is replaced.

1. Press the MENU BUTTON and the MAIN MENU DISPLAY dialog box will appear.
2. Press the POINT LEFT/RIGHT BUTTON(s) to select SETTING and press the SELECT (REAR CLICK) BUTTON. Another dialog box SETTING DISPLAY will appear.
3. Press the POINT DOWN BUTTON and a red arrow will appear.
4. Move the arrow by pressing the POINT UP/DOWN BUTTON(s) to select Lamp age and then press the SELECT (REAR CLICK) BUTTON. When you reset the lamp replace monitor, "lamp replace monitor reset?" is displayed for confirmation.
5. Move the arrow to Yes and then press the SELECT (REAR CLICK) BUTTON, "OK?" is displayed for confirmation. Move the arrow to Yes and then press the SELECT (REAR CLICK) BUTTON, the lamp replace monitor is reset.
6. Move the arrow to No and then press the SELECT (REAR CLICK) BUTTON. The lamp replace monitor is not reset.
7. To quit the MENU, move the arrow to Quit and then press the SELECT (REAR CLICK) BUTTON.

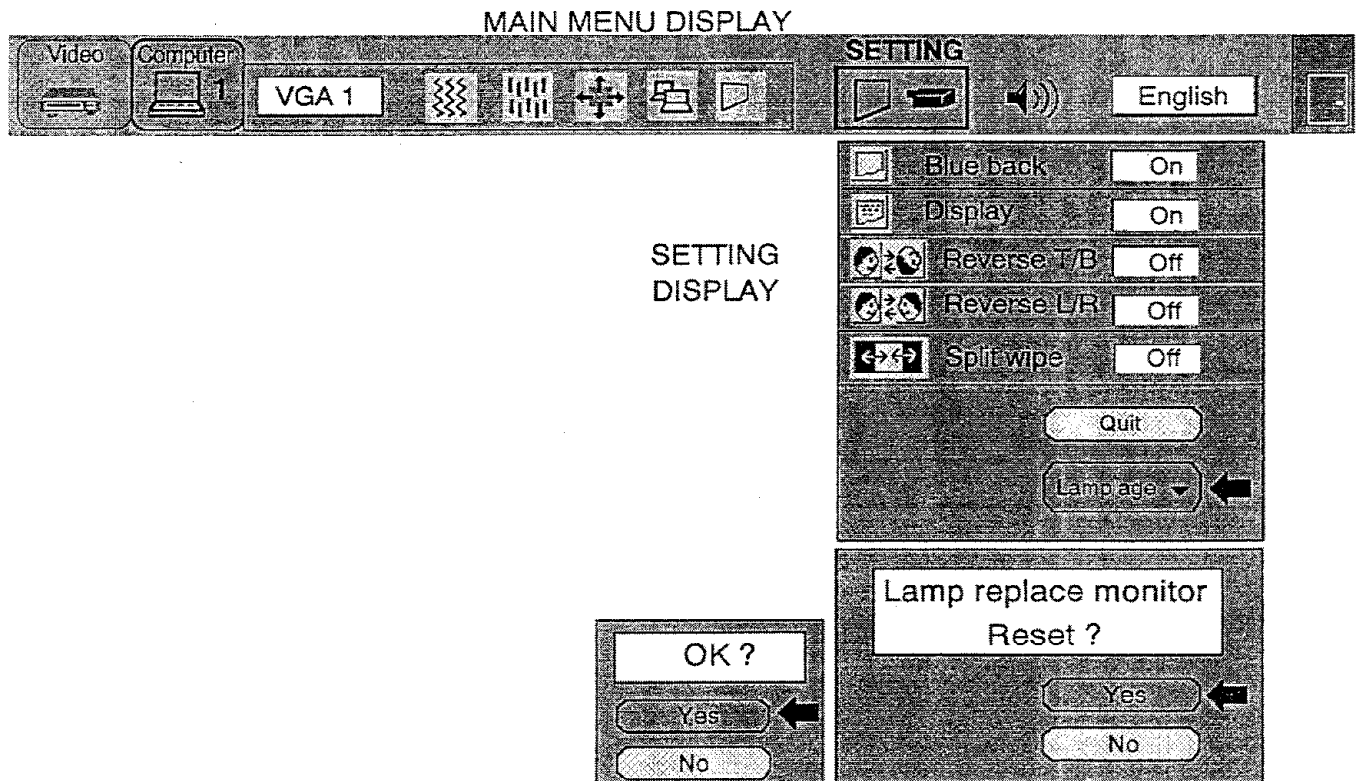



## AIR FILTER CARE AND CLEANING

The removable air filter prevents dust from accumulating on the surface of the projection lens and projection mirror. Should the air filter become clogged with dust particles, it will reduce the cooling fan's effectiveness and may result in internal heat build up and reduce the life of the projector.

To clean the air filter, follow the cleaning procedures below:

1. Turn the LAMP POWER ON/OFF button OFF.
2. Remove the air filter cover.
3. Remove the air filter and sponge from the filter cover.
4. Clean the air filter with a vacuum cleaner.
5. Replace the air filter and sponge. Make sure that air filter cover is fully inserted.



Do not clean with water. It may damage the air filter.  
Do not operate the projector without air filter.

### RECOMMENDATION

**TO ENJOY PICTURE IMAGE, USE THE PROJECTOR IN THE CLEAN ENVIRONMENT.**

When using under the dusty or smoky conditions, dust may accumulate on the liquid crystal panel and lens inside it, and the picture projected may be stained or blurred with dust.

When these problems occur, contact your authorized dealer or service station for the cleaning.

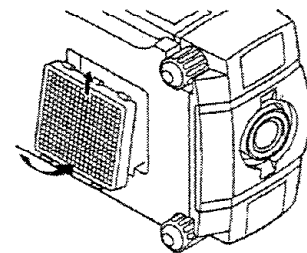
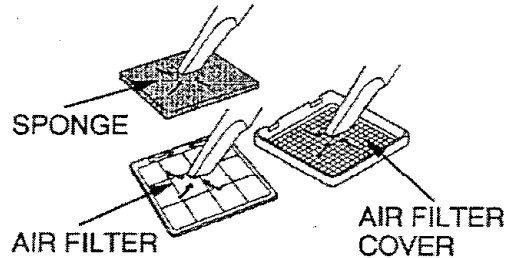
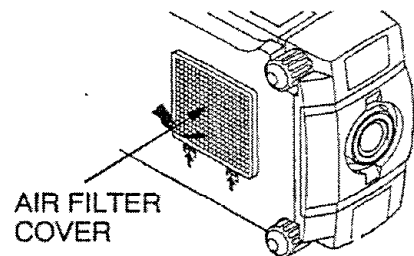

## TEMPERATURE WARNING INDICATOR

The TEMPERATURE WARNING INDICATOR flashes red when the internal temperature of the projector exceeds the normal temperature.

Possible causes for the temperature warning may be:

1. Ventilation slots of the projector are blocked. In such an event, reposition the projector so that ventilation slots are not obstructed.
2. Air filter is clogged with dust particles. Remove dust from the air filter by following instructions in the Air Filter Care and Cleaning section above.
3. If temperature warning indicator remains on after performing the checks listed above, cooling fan/internal circuits may be malfunctioning. Request service from an authorized dealer or service station.

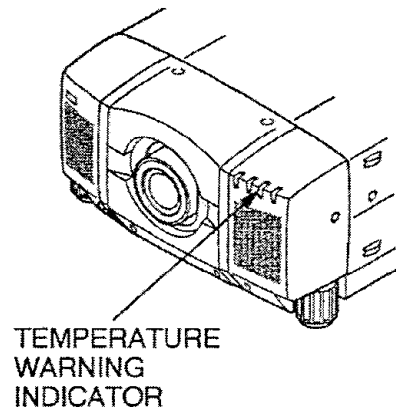



## Warranty

Proxima Corporation warrants that the Proxima® PRO AV™ product manufactured by Proxima is free from defects in materials and workmanship under normal use during the Warranty Period. The Warranty Period commences on the day of purchase by the end-user. The Warranty Period is one year. The projector lamp is not covered by this Warranty.

Each Proxima product is manufactured from new parts, or new and some used parts. In some cases, the product may have been delivered to another end-user and then returned. In all cases, the product has undergone testing and quality inspection, and Proxima's full warranty terms apply.

The end-user's sales receipt or invoice showing the date of purchase of the product and the name of the Reseller is proof of date of purchase. The Warranty extends only to the original purchaser and is not transferable.

During the Warranty Period, Proxima will, at no additional charge, repair or replace defective parts or at the option of Proxima, replace the entire unit.

This Limited Warranty does not extend to any Proxima product that has been damaged or been rendered defective (a) as a result of accident, misuse, or other abuse; (b) by the use of parts not manufactured or sold by Proxima; or (c) by modification of the product; or (d) as a result servicing by non-authorized personnel.

### Limitation of Warranties

The foregoing warranty is expressly in lieu of any other express or implied warranties, including, without limitation, warranties of merchantability or fitness for a particular purpose. To the extent not prohibited by law, all statutory warranties are waived and excluded from this warranty. Proxima expressly disclaims all warranties not stated in this Limited Warranty.

## Free Manuals Download Website

<http://myh66.com>

<http://usermanuals.us>

<http://www.somanuals.com>

<http://www.4manuals.cc>

<http://www.manual-lib.com>

<http://www.404manual.com>

<http://www.luxmanual.com>

<http://aubethermostatmanual.com>

Golf course search by state

<http://golfingnear.com>

Email search by domain

<http://emailbydomain.com>

Auto manuals search

<http://auto.somanuals.com>

TV manuals search

<http://tv.somanuals.com>