

# PlugLink™ by Asoka®

---

PL9950UG-060106

**Asoka® User's Guide**  
**PlugLink 9950 Cable/ DSL Router PL9950-BBR**

© 2006 Asoka USA Corporation. All rights reserved.

**Trademarks**

Asoka, PlugLink and the Asoka logo are registered trademarks or trademarks of Asoka USA Corporation.

Other brand and product names are registered trademarks or trademarks of their respective holders.

**Statement of Conditions**

In the interest of improving internal design, operational function, and/ or reliability, Asoka reserves the right to make changes to the products described in this document without notice.

Asoka does not assume any liability that may occur due to the use or application of the product(s) or circuit layout(s) described herein.

## Table of Contents

| <b>Chapter</b> | <b>Title</b>                         | <b>Page</b> |
|----------------|--------------------------------------|-------------|
| 1              | Introduction                         | <u>4</u>    |
| 2              | Important Safety Information         | <u>5</u>    |
| 3              | Learning About your Powerline Router | <u>6</u>    |
| 4              | Preparing to Install                 | <u>10</u>   |
| 5              | Installing the Powerline Router      | <u>11</u>   |
| 6              | Logging on                           | <u>12</u>   |
| 7              | Web-based User Interface             | <u>13</u>   |
| 8              | Connecting to your ISP               | <u>15</u>   |
| 9              | Changing LAN Settings                | <u>18</u>   |
| 10             | Configuring the Firewall             | <u>21</u>   |
| 11             | Router Administration                | <u>31</u>   |
|                | Appendixes                           | <u>37</u>   |

## **Chapter 1**

### **Introduction**

Thank you for purchasing a PlugLink 9950 Cable/ DSL Router (PL9950-BBR) from Asoka. This router lets you network your home or office by simply plugging directly into your wall outlet. Now, networking is as easy as plugging in a night light. With your PlugLink 9950 Cable/ DSL Router, you can easily share your high-speed Internet broadband, mp3s, video and gaming throughout the home or office without pulling any new cabling.

This unit will not interfere with other household appliances such as hair dryers, vacuum cleaners or microwave ovens. Consuming only 5 watts of power, it is environmentally friendly and will not noticeably increase your electrical bill. It is a simple, secure and reliable choice for web surfing, playing games, for complimenting your existing wireless network, mp3 streaming, and even high-definition (HD) video sharing.

This User's Guide shows you how to connect your PlugLink 9950 Cable/ DSL Router to your PC. Setup is easy. Just follow the instructions in this guide and your network will be up and running in a matter of minutes.

## **Chapter 2**

### **Important Safety Instruction for the PlugLink 9950 Cable/ DSL Router**

The following precautions should be taken when using this product:

- Read all instructions before installing and operating this product.
- Do not open the cover on this product and/or alter this product in any way.
- Follow common household electrical safety practices.

If you have any questions or concerns regarding these safety measures, please contact Technical Support at 650-286-0300 or email [support@asokausa.com](mailto:support@asokausa.com) Monday through Friday from 9:00 am to 5:00 pm PST (excluding holidays.)

## Chapter 3

### Learning about your PlugLink 9950 Cable/ DSL Router

#### Package Contents

- PlugLink 9950 Cable/ DSL Router (PL9950-BBR)
- 6 ft. Ethernet cable
- Quick Installation Guide
- Installation Resource CD
- Warranty and Support Information Card

If any of the parts are incorrect, missing or damaged contact the retailer where you made your purchase. Keep the carton, including the original packing materials, in case you need to return the unit for repair.

#### System Requirements

- Cabling and Computer Hardware

To use the PL9950-BBR router on your network, each computer must have an installed Ethernet Network Interface Card (NIC) and an Ethernet Cable. If the computer is connected to your network using an Ethernet NIC at 100 Mbps, you must use a Category 5 (Cat 5) cable such as the one provided with your router. The cable or DSL broadband modem must provide a standard 10 Mbps (10BASE-T) or 100 Mbps (100BASE-Tx) Ethernet interface. The computer must be running either Windows (98SE or higher) or Mac OS (X.1 or higher) and have at least 200 Mhz or faster processing speed and a 64Mbs of RAM.

- Computer Network Configuration Requirements

The PL9950-BBR router includes a built-in Web Configuration Manager. To access the configuration menus on the PL9950-BBR router, you must use a web browser (such as Microsoft internet Explorer or Mozilla Firefox) that has Macromedia Flash and a Java-enabled program that supports HTTP uploads. It is recommended that you use Internet Explorer 6.0 or Mozilla Firefox 1.5 or above.

For the initial setup of your router, you will need to connect a computer to the router. This computer has to be set to automatically get its TCP/IP configuration from the router via DHCP. For information on how to configure your computer, please see Appendix A.

- Broadband Access and Configuration Requirements

Depending on how your Internet service set up your account, you may need one or more of these configuration parameters to connect your router to the Internet:

- Host and Domain Names
- ISP Login Name and Password

**Asoka® User's Guide**  
**PlugLink 9950 Cable/ DSL Router PL9950-BBR**

- ISP Domain Name Server (DNS) Address
- Fixed IP Address which is also known as Static IP Address

For your convenience, see **Appendix A** for an easy-to-use form as a guide to ask the appropriate information from your Internet service provider.

**The Front Panel**

The front panel of the PL9950-BBR Router contains the status lights described below.

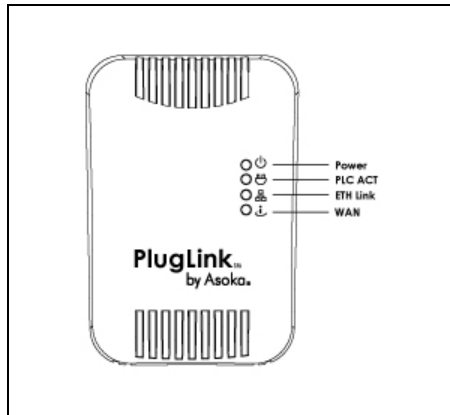

Figure 3-1: PL9950-BBR Front Panel

You can use the status lights to verify connections. Viewed from top to bottom, left to right, the table describes the lights on the front panel of the unit.

Table 3-1: Status Light Descriptions

|          |                       |  |
|----------|-----------------------|--|
| POWER    | On<br>Off             | Indicates Device Powered On<br>Indicates No Power  |
| PLC ACT  | Blinking<br>Off       | Indicates Activity on Powerline<br>Indicates No Activity on Powerline<br>(Should blink Intermittently) |
| ETH Link | On<br>Blinking<br>Off | Indicates Ethernet Connectivity<br>Indicates Ethernet Traffic<br>Indicates No Ethernet Activity        |
| WAN      | On<br>Off             | Indicates Activity on the WAN<br>Indicates No Activity on the WAN                                      |

**Left Panel**

The left panel of the PL9950-BBR Router contains a reset button as shown in figure 3-2.

**Asoka® User's Guide**  
**PlugLink 9950 Cable/ DSL Router PL9950-BBR**

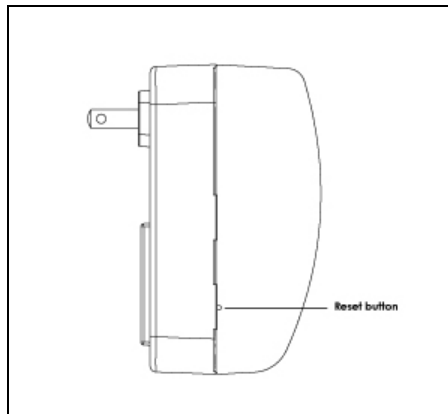

Figure 3-2: PL9950-BBR Left Panel

**The Bottom Panel**

The bottom panel of the PL9950-BBR Router contains a WAN port and a LAN port as shown in figure 3-3.

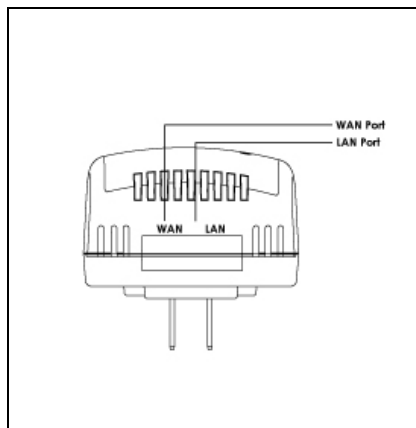

Figure 3-3: PL9950-BBR Bottom Panel

**The Rear Panel**

The label on the rear panel of the PL9950-BBR Router contains the items listed below.

- Model Number
- Unique device password
- PLC MAC address
- Ethernet MAC address
- Serial number

Note: For future convenience, please write this information down in your Warranty Support Information card.



**Asoka® User's Guide**  
**PlugLink 9950 Cable/ DSL Router PL9950-BBR**



Figure 3-4: Rear Label

## Chapter 4

### Preparing to Install the PlugLink 9950 Cable/ DSL Router

The PlugLink 9950 Cable/ DSL Router lets you set up a home or an office network using your existing electrical outlets. It can also easily compliment your existing network by connecting to any 10BaseT/ 100BaseT Ethernet-capable device.

In order to share a Broadband connection between computers, all you will need is:

- One (1) PL9650-ETH device attached to each computer or one (1) PL9550-WAP device for any wireless-enabled computers
- Standard Cable/DSL Modem
- One (1) PL9950-BBR device

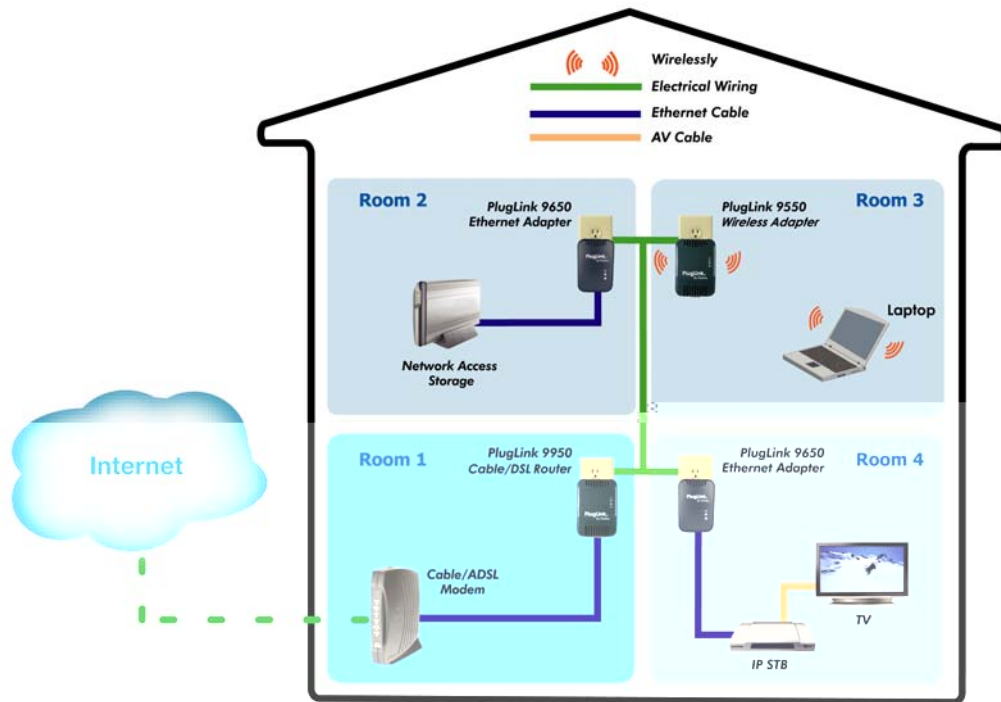

Typical network diagram.

Figure 4-1: Shared broadband connection network diagram.

## Chapter 5

### Installing the PlugLink 9950 Cable/ DSL Router

Note: Do not connect the PlugLink 9950 Cable/ DSL Router to a power strip, extension cord, uninterruptible power supply (UPS), or surge protector. This may prevent the unit from working properly or degrade the network performance.

Note: Shut down any programs that are running on your computer prior to installing the PL9950-BBR Router.

1. Connect the modem via an Ethernet cable supplied by your modem manufacturer into the port labeled WAN on the bottom of the 9950 Cable/ DSL Router.
2. Connect your computer into the LAN port on the bottom of the 9950 Cable/ DSL Router using the supplied Ethernet cable.
3. Plug the PL9950-BBR directly into an available power outlet.
4. Plug in your modem and restart your computer.

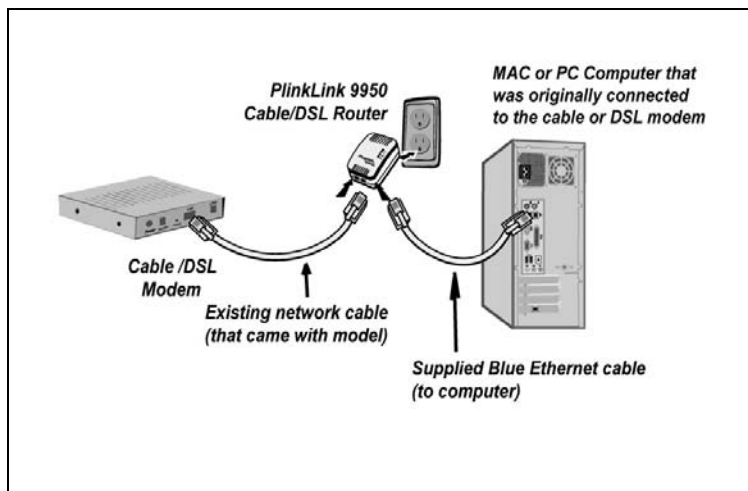

Figure 5-1: Diagram of the hardware setup.

5. Check the LEDs on the front panel of the PL9950-BBR Router. All four LEDs should be either lit or blinking intermittently.

## Chapter 6

### Logging On

1. Open a web browsing application (Internet Explorer or Mozilla Firefox).
2. In the address or navigation field, type **192.168.1.1** and press *Enter*.

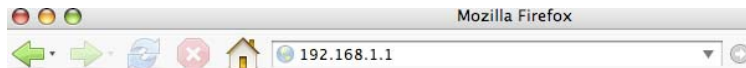

Figure 6-1: Login Address

3. For security, the PL9950-BBR Router has its own user ID and password. When prompted, enter \_\_\_\_\_ for the router user ID, \_\_\_\_\_ for the router password, both in lower case letters, and press *Login*. To change the user ID and password, see "Changing the Administrator Login Information" on page 31.

Note: The router user name and password cannot be the same as any user name or password you use to log in to your Internet connection.

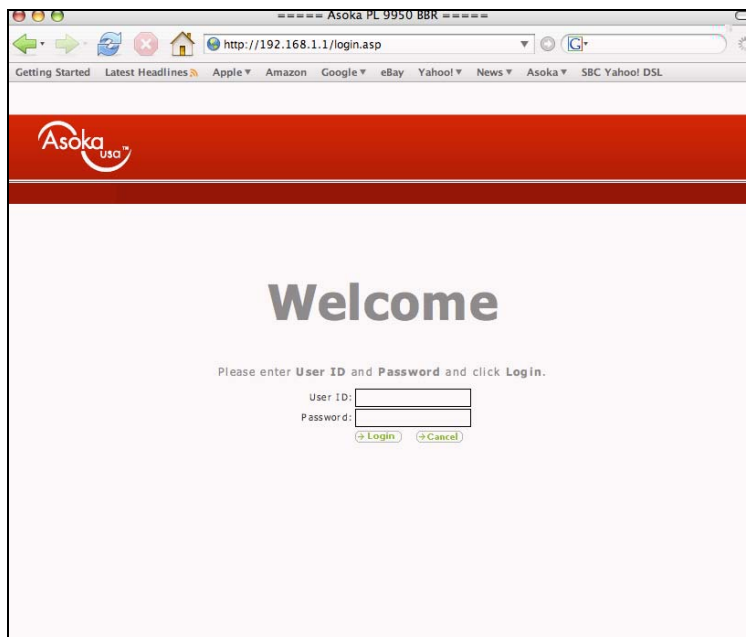

Figure 6-2: Login Screen

## Chapter 7

### Understanding the Web-Based User Interface

When you access the web-based user interface, the System Details page is the first page you will see. The System Details page shows you a quick view of the PL9950-BBR Router's status and settings. All setup pages can be accessed from this page.

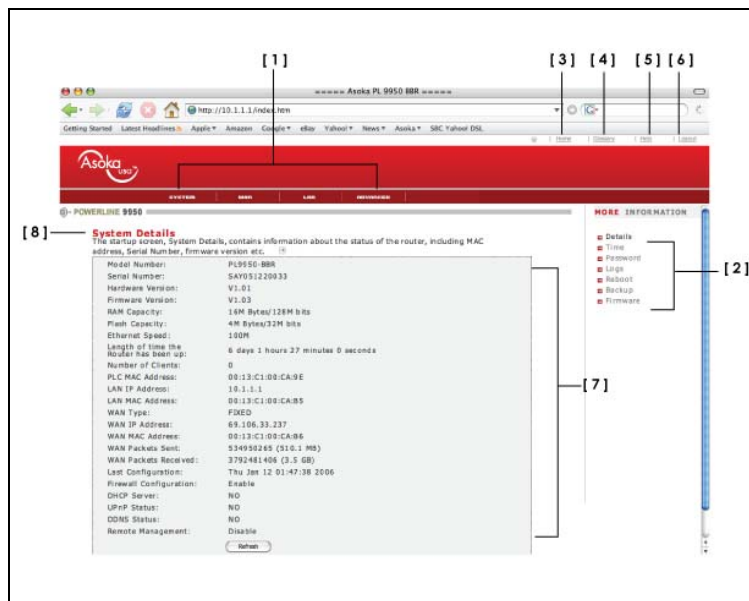

Figure 7-1: System Details page (a.k.a. Home page)

#### 1. Quick Main Navigation Links

The User Interface (UI) is divided into four main logical sections, and you can go directly to any of the four sections by clicking directly on each of these links.

#### 2. Quick Sub Navigations links

When you enter into each of the four main logical sections, a sub navigation link that corresponds to the main logical section will appear.

#### 3. Home Button

The *Home* button is available on every page of the UI. Pressing this button will take you back to the home page, which is the system details page.

#### 4. Glossary Button

The *Glossary* button is available on every page of the UI. Pressing this button will take you to a glossary page that defines many of the technical terms used in this UI.

#### 5. Help Button

The *Help* button is available on every page of the UI. Pressing this button will take you to a help page that provides detailed explanations and steps for configuring your PL9950-BBR Router.

#### 6. Logout Button

The *Logout* button is available on every page of the UI. Pressing this button will enable you to log out of the PL9950-BBR Router with the click of a button.

**Asoka® User's Guide**  
**PlugLink 9950 Cable/ DSL Router PL9950-BBR**

**7. Detailed Information**

Shows you detailed information about the PL9950-BBR Router that includes: model number, firmware version number, hardware version, serial number, Internet Wide Area Network (WAN) settings, Local Area Network (LAN) settings and firewall settings.

**8. Page Name**

The page you are on is identified by this name.

## Chapter 8

### Connecting to your Internet Service Provider (ISP)

The WAN tab is where you will set up your PL9950-BBR Router to connect to your Internet Service Provider (ISP). The PL9950-BBR Router is capable of connecting to virtually any ISP's system, provided you have correctly configured the PL9950-BBR Router's settings for your ISP's connection type. Your ISP connection settings are provided to you by your ISP. To configure the PL9950-BBR with the settings that your ISP gave you, follow these steps:

1. Under *Connection Type*, click on the connection type you use.
2. Click *Apply*.

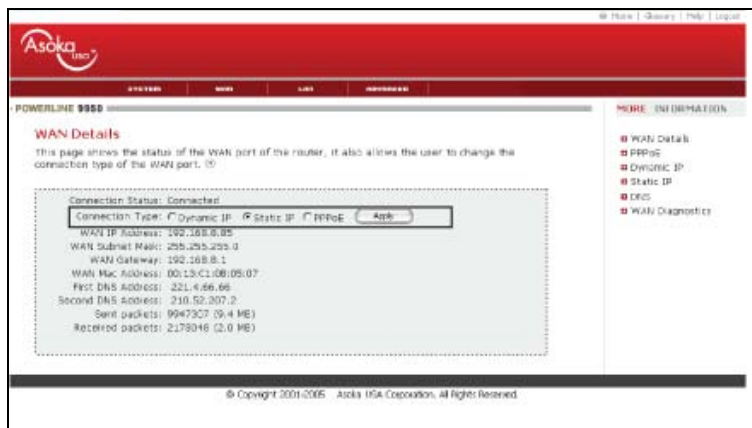

Figure 8-1: Selecting your connection type.

### Choosing Internet Connection Type

1. Selecting your Internet Service Provider (ISP) Connection Type to Dynamic IP: A dynamic connection type is the most common connection type found with cable modems. Setting the connection type to *Dynamic* in many cases is enough to complete the connection to your ISP.

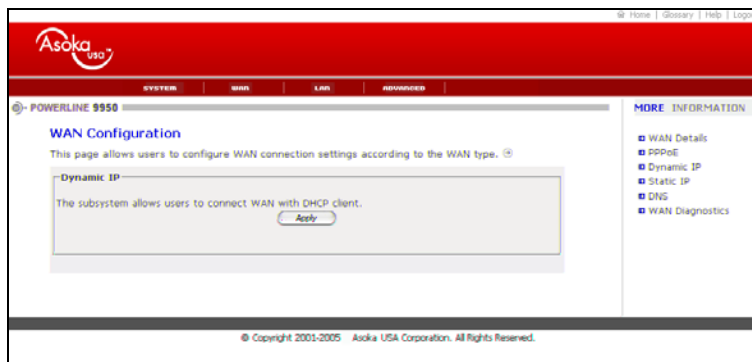

Figure 8-2: Dynamic IP Screen

## Asoka® User's Guide PlugLink 9950 Cable/ DSL Router PL9950-BBR

2. Selecting your Internet Service Provider (ISP) Connection Type to Static IP: A static IP address connection type is less common than other connection types. If your ISP uses static IP addressing, you will need your IP address, subnet mask, and ISP gateway address. This information is available from your ISP or on the paperwork that your ISP left with you. Type in your information. Click *Apply*.

The screenshot shows the 'WAN Configuration' page for the Asoka POWERLINE 9950 router. The page is titled 'Static IP' and includes instructions: 'If your Service Provider has assigned a fixed IP address, enter the assigned IP Address, Subnet Mask and Gateway IP Address.' Below this, there are three rows of input fields: 'IP Address' with values 192, 168, 0, 85; 'Subnet Mask' with values 255, 255, 255, 0; and 'Gateway IP' with values 192, 168, 0, 1. An 'Apply' button is located at the bottom of the form. A 'MORE INFORMATION' sidebar on the right lists options: WAN Details, PPPoE, Dynamic IP, Static IP, DNS, and WAN Diagnostics. The footer contains the copyright notice: '© Copyright 2001-2005 Asoka USA Corporation. All Rights Reserved.'

Figure 8-3: Static IP Screen

3. Selecting your Internet Service Provider (ISP) Connection Type to PPPoE: Most DSL providers use PPPoE as the connection type. If you use a DSL modem to connect to the Internet, your ISP may use PPPoE to log you into the service. If you have an Internet connection that doesn't require a modem, you may also use PPPoE. Type in your information and click *Apply*.

The screenshot shows the 'WAN Configuration' page for the Asoka POWERLINE 9950 router, specifically the 'PPPoE Configuration' section. It includes instructions: 'Enter the PPPoE user name and password assigned by you normally optional, by may be required by some service providers to define a maximum period of time for which the inactivity. If the connection is inactive for longer than the dropped. You can enable the Auto-reconnect option to as soon as you attempt to access the Internet again. If your Internet Service Provider requires the use of PPPoE, enter the information below.' The form contains fields for 'User Name', 'Password', 'Confirm password', 'Service Name', 'MTU (1400-1492)' (set to 1492), and 'Maximum Idle Time' (in minutes). An 'Auto-reconnect' checkbox is also present. An 'Apply' button is at the bottom. The 'MORE INFORMATION' sidebar on the right lists: WAN Details, PPPoE, Dynamic IP, and Static IP. The footer contains the copyright notice: '© Copyright 2001-2005 Asoka USA Corporation. All Rights Reserved.'

Figure 8-4: PPPoE IP Screen

### Setting Domain Name Server (DNS) Information

After you have selected and configured your connection type, you will need to set the DNS Server information.

1. Under the WAN sub menu, click on *DNS*.
2. Enter the DNS information provided to you by your ISP and click *Apply*.



## Asoka® User's Guide PlugLink 9950 Cable/ DSL Router PL9950-BBR

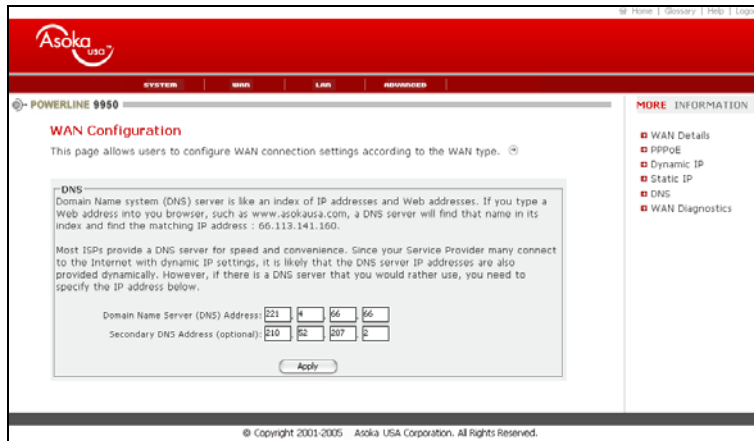

Figure 8-5: DNS Screen

Congratulations! Happy surfing!

## Chapter 9

### Changing LAN Settings

All settings for the internal LAN setup of the PL9950-BBR Router can be viewed and changed here. Changing LAN Settings is recommended for advanced users only.

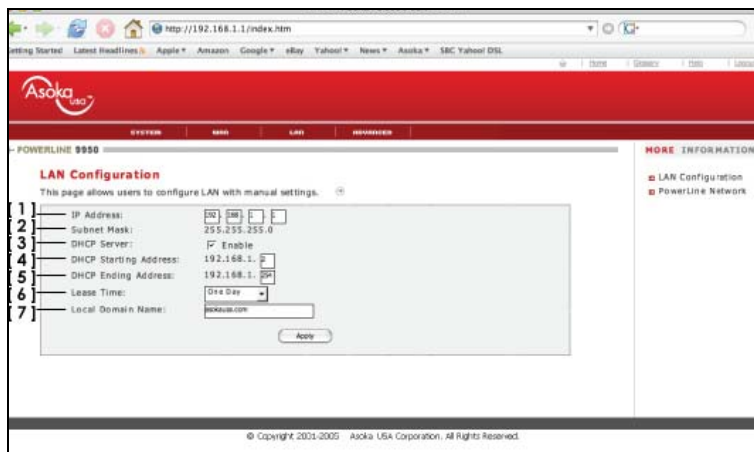

Figure 9-1: LAN Setting Page

#### 1. IP Address

The IP address is the internal IP address of the PL9950-BBR Router. The default IP address is . To change the settings of the PL9950-BBR, type this IP address into the address bar of your browser. This address can be changed if needed and is optional and is recommended only for advanced users. To change the IP address, type in the new IP address and click *Apply*.

#### 2. Subnet Mask

There is no need to change the subnet mask. This is a unique advanced feature of your PL9950-BBR Router. It is possible to change the subnet mask if necessary; however, do not make changes to the subnet mask unless you have a specific reason to do so. The default setting is 255.255.255.0.

#### 3. DHCP Server

The DHCP server function simplifies setting up a network by assigning IP addresses to each computer on the network automatically. The default setting is *ON*. The DHCP server can be turned *OFF* if necessary; however, in order to do so you must manually set a static IP address for each computer on your network. To turn the DHCP server *OFF*, uncheck the box next to the word *Enable*.

#### 4. DHCP Scope

DHCP Scope is the range of IP addresses set aside for dynamic assignment to the computers on your network, defined by a Starting Address and an Ending Address. The default range is between the numbers 2 and 254 (253 computers). If you want to change this number, you can do so by entering a new starting and/or ending IP address here.

#### 5. Lease Time

The duration of time that the DHCP server will reserve an IP address for each computer.

## Asoka® User's Guide PlugLink 9950 Cable/ DSL Router PL9950-BBR

### 6. Local Domain Name

The default setting for Local Domain Name is *Asoka*. You can set a local domain name (network name) for your network. There is no need to change this setting unless you have a specific advanced need to do so. You can name the network anything you want.

### Configuring the Powerline Network Settings

The *Powerline* link in the LAN Sub menu lets you make changes to the Powerline network settings. From this tab you can make changes to the Powerline network name and encryption security settings.

To view and configure the Powerline network settings, you must first log in. The default Powerline network settings password is *PlugLink*. To change the default Powerline network settings password, see Chapter 11 of this User's Manual.



Figure 9-2: Powerline Network Network Settings Login Screen

After logging in to the Powerline network settings page, you will be able to view all the Powerline devices connected to your network and to set the local Powerline device password for the 9950 Cable/ DSL Router.



Figure 9-3: Powerline network settings page

### 1. Local Powerline Device Password

The Local Powerline Device Password is the password for the PL9950-BBR. This password allows other Powerline devices to communicate with each other. By default, the local Powerline device password is *PlugLink*. To change the default local Powerline device password, simply type in a new password in the field and click *Apply*.

**Asoka® User's Guide**  
**PlugLink 9950 Cable/ DSL Router PL9950-BBR**

**2. Powerline Device List**

The Powerline device list provides a list of Powerline devices connected to your Powerline network. The Powerline device list only displays the other Powerline devices on the network that have the same local Powerline device password.

## Chapter 10

### Configuring the Firewall

Your 9950 Cable/ DSL Router is equipped with a firewall that will protect your network from a wide array of common hacker attacks including:

- IP Spoofing
- Land Attack Ping of Death (PoD)
- Denial of Service (DoS)
- IP with zero length
- Smurf Attack
- TCP Null Scan
- UDP Flooding
- Tear Drop Attack
- RIP Defect
- Fragment Flooding

The firewall also masks common ports that are frequently used to attack networks. These ports are made invisible to a would-be hacker. You can turn the firewall function off if needed; however, it is recommended that you have the firewall enabled. Disabling the firewall protection will not leave your network completely vulnerable to hacker attacks, but it is recommended that you leave the firewall enabled.

To view and configure Firewall settings, click on the *Advanced* tab in the Main menu and click *Firewall* in the Sub menu.



Figure 10-1: Firewall Configuration Main Page

Under the Submenu, click on *Firewall Options* to enable other critical Firewall options such as:

- SYN Flood
- ICMP Defect

## Asoka® User's Guide PlugLink 9950 Cable/ DSL Router PL9950-BBR

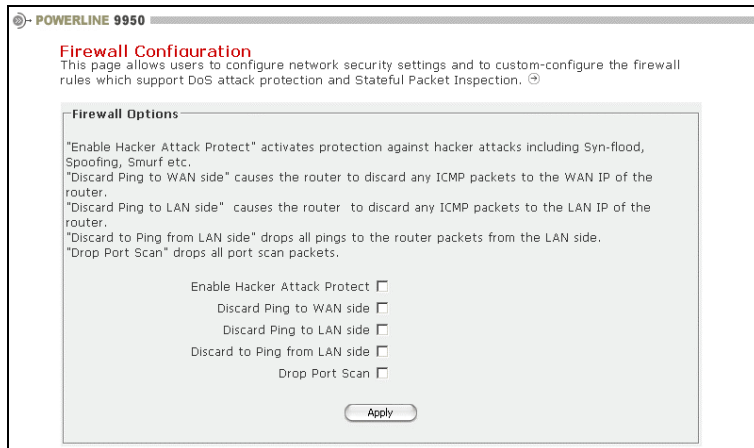

Figure 10-2: Firewall Options page

### Setting Client IP Filters

The PL9950-BBR can be configured to restrict access to the Internet, email or other network services. Restrictions can be set for a single computer, a range of computers, or multiple computers. To set client IP filters, click *Client Filter* under *Firewall* in the Sub menu,

To restrict Internet access to a single computer, for example:

1. Enter the IP address of the computer you wish to restrict access to in the IP fields
2. Enter in both the port fields
3. Select *TCP*
4. Check the *Enable* box
5. Click *Apply*

The computer at the IP address you specified will now be blocked from Internet access.

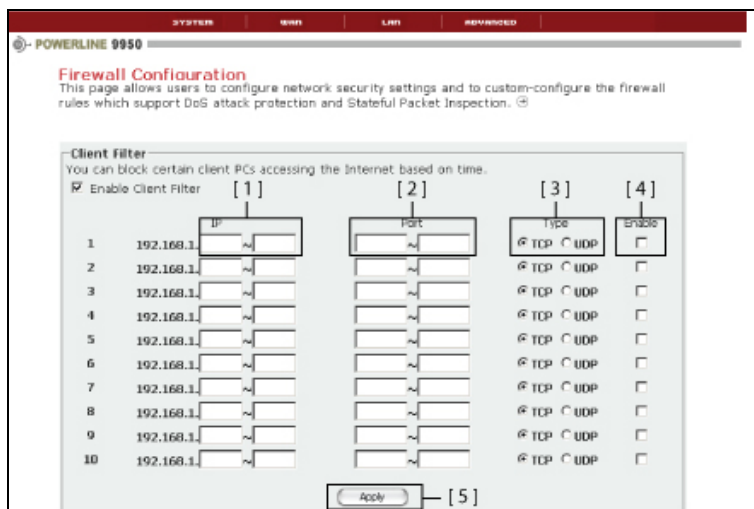

Figure 10-3: Client IP Filter Settings page

## Asoka® User's Guide PlugLink 9950 Cable/ DSL Router PL9950-BBR

### Setting MAC Filter

The MAC filter is a powerful security feature that allows you to specify which computers are allowed on the network. This list can be configured so any computer attempting to access the network that is not specified in the filter list will be denied access. When you enable this feature, you must enter the MAC address of each client (computer) to which you want to allow network access. The *Block* feature lets you turn access to the network on and off easily for any computer without having to add or remove the computer's MAC address from the list.

To set MAC filters, click on *MAC Filter* under *Firewall* in the Sub menu.

1. Select the checkbox next to *MAC Address Control*
2. Enter the MAC address of the computer you want to configure Internet access for
3. Check *Block Connect to Internet* to restrict Internet access to the specified computer
4. Click *Add*
5. Click *Apply*
6. To delete a computer from the MAC Filter table, simply click *Delete* next to the appropriate MAC address.

To unblock Internet access to a MAC address of a client, simply uncheck the *Block Connect to Internet* box next to the appropriate MAC address.

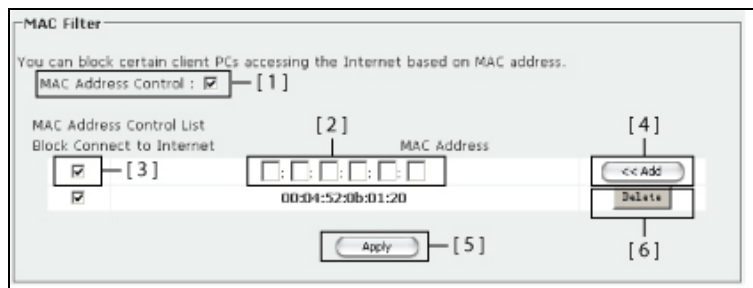

Figure 10-4: MAC Filter Settings Page

### Setting URL Filter

The URL filter is a powerful security feature that allows you to restrict access to certain web sites. This list can be configured so any computer attempting to access the prohibited web sites will be denied access. When you enable this feature, you must specify the exact web site to which you want to prohibit access. The *Block* feature lets you to turn access to the web sites on and off easily for any computer without having to add or remove the web site address from the list.

To set URL filters, click on *URL Filter* under *Firewall* in the Sub Menu.

1. Select the checkbox next to *URL Control*
2. Enter the URL of the web site you want to restrict access
3. Check *Block to Internet* to restrict Internet access to the specified web site
4. Click *Add*
5. Click *Apply*
6. To delete a web site off the URL Filter table, simply uncheck the *Block Connect to Internet* box next to the appropriate URL.

## Asoka® User's Guide PlugLink 9950 Cable/ DSL Router PL9950-BBR

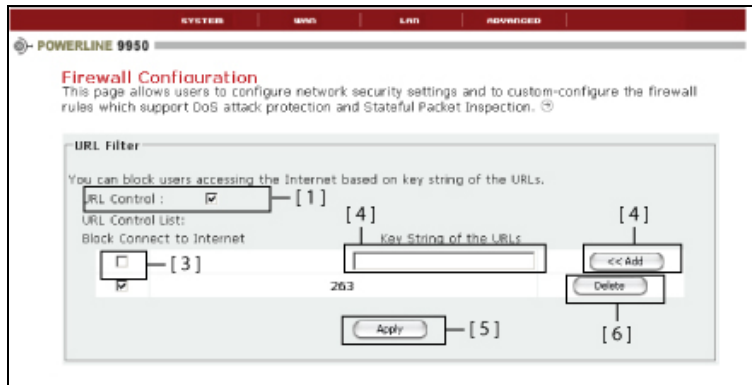

Figure 10-5: URL Filter Settings Page

### Configuring Internal Forwarding Settings

The Virtual Servers function will allow you to route external (Internet) calls for services such as a web server (port 80), FTP server (port 21), or other applications through your PL9950-BBR to your internal network. Since your internal computers are protected by a firewall, computers outside your network (over the Internet) cannot get to them because they cannot be 'seen'. A list of common applications has been provided in case you need to configure the Virtual Server function for a specific application. If your application is not listed, you will need to contact the application vendor to find out which port settings you need.

To configure Virtual Servers, click on *Virtual Server* under *NAT* in the Sub Menu.

1. Enter the IP address
2. Enter a private port number
3. Click *Enable*
4. To manually configure the Virtual Server, select *Connection Type*
5. Enter in a public port
6. Click *Enable*
7. Click *Apply*



**Asoka® User's Guide**  
**PlugLink 9950 Cable/ DSL Router PL9950-BBR**

**Virtual Server**

You can configure the router as a virtual server so that remote users accessing services such as the Web or FTP at your local site via public IP addresses can be automatically redirected to local servers configured with private IP addresses. In other words, depending on the requested service (TCP/UDP port numbers), the Router redirects the external service request to the appropriate server (located at another internal IP address).

|    | [1]<br>Private IP | [2]<br>Private Port | Type   | Public Port | Enabled                                 |
|----|-------------------|---------------------|--|-------------|---|
| 1  | 192.168.1. [ ]    | [ ]                 | TCP(FTP)   | 21          | <input checked="" type="checkbox"/> [3] |
| 2  | 192.168.1. [ ]    | [ ]                 | TCP(Telnet)  | 23          | <input type="checkbox"/>                |
| 3  | 192.168.1. [ ]    | [ ]                 | TCP(SMTP)  | 25          | <input type="checkbox"/>                |
| 4  | 192.168.1. [ ]    | [ ]                 | TCP(DNS)   | 53          | <input type="checkbox"/>                |
| 5  | 192.168.1. [ ]    | [ ]                 | UDP(DNS)   | 53          | <input type="checkbox"/>                |
| 6  | 192.168.1. [ ]    | [ ]                 | TCP(HTTP)  | 80          | <input type="checkbox"/>                |
| 7  | 192.168.1. [ ]    | [ ]                 | TCP(POP3)  | 110         | <input type="checkbox"/>                |
| 8  | 192.168.1. [187]  | [88]                | UDP(FTP) [4]   | 69 [5]      | <input checked="" type="checkbox"/>     |
| 9  | 192.168.1. [ ]    | [ ]                 | <input checked="" type="radio"/> TCP <input type="radio"/> UDP | [ ]         | <input checked="" type="checkbox"/> [6] |
| 10 | 192.168.1. [ ]    | [ ]                 | <input checked="" type="radio"/> TCP <input type="radio"/> UDP | [ ]         | <input type="checkbox"/>                |
| 11 | 192.168.1. [ ]    | [ ]                 | <input checked="" type="radio"/> TCP <input type="radio"/> UDP | [ ]         | <input type="checkbox"/>                |
| 12 | 192.168.1. [ ]    | [ ]                 | <input checked="" type="radio"/> TCP <input type="radio"/> UDP | [ ]         | <input type="checkbox"/>                |

Figure 10-6: Virtual Server Settings Page

**Setting Port Mapping**

The Port Mapping feature allows you to specify a range of ports for a specific local machine to route the packets. The 9950 Cable/ DSL Router allows the user to configure the needed port mappings to suit such applications for special users. A list of common applications has been provided in case you need to configure the port mapping for a specific application. If your application is not listed, you will need to contact the application vendor to find out which port settings you need.

To configure port mapping, click on *Port Mapping* under NAT in the Sub Menu.

1. Enter the last digit in the IP field of the local machine
2. Enter a range of port or specify a port number to route the packets
3. Click the box next to *Enable*
4. Click *Apply*

## Asoka® User's Guide PlugLink 9950 Cable/ DSL Router PL9950-BBR

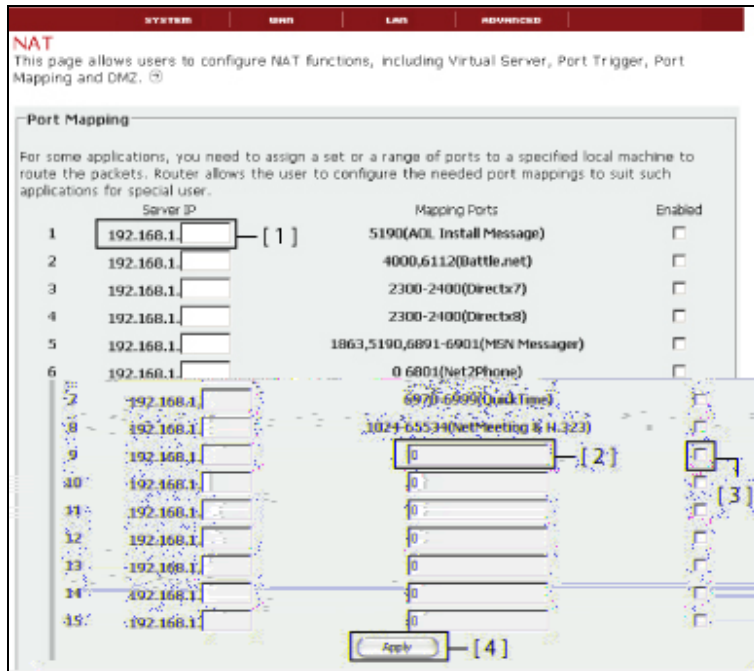

Figure 10-7: Port Mapping Settings Page

### Setting Port Triggering

The Port Triggering feature allows you to specify a range of ports for a specific local machine to route the packets. The 9950 Cable/ DSL Router allows the user to configure the needed port trigger to suit such applications.

To configure port mapping, click on *Port Mapping* under NAT in the Sub Menu.

1. Enter the trigger port
2. Select connection type: *TCP* or *UDP*
3. Enter incoming port
4. Check the box next to *Enabled*
5. Click *Apply*

## Asoka® User's Guide PlugLink 9950 Cable/ DSL Router PL9950-BBR

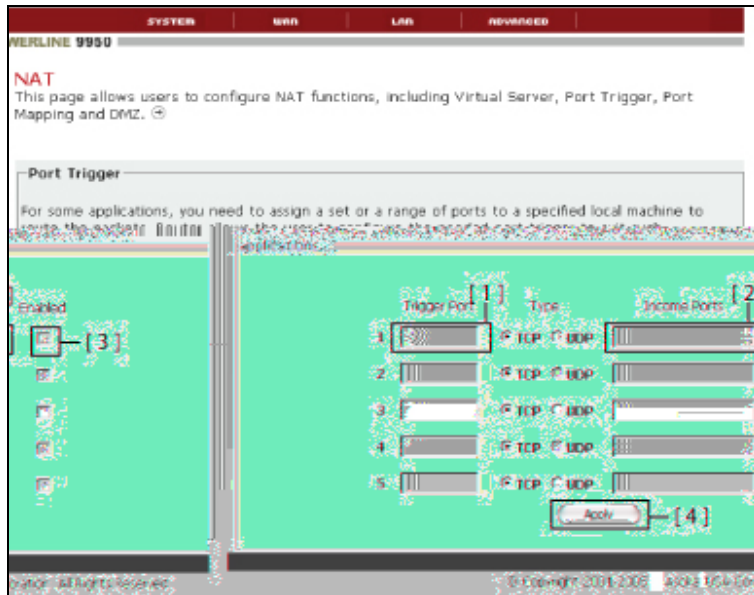

Figure 10-8: Port Triggering Settings Page

### Enabling the Demilitarized Zone (DMZ)

The DMZ feature allows you to specify one computer on your network to be placed outside the firewall. This may be necessary if the firewall is causing problems with an application such as a game or video conferencing application. Use this feature on a temporary basis. The computer in the DMZ is NOT protected from hacker attacks.

To put a computer in the DMZ, click on DMZ under NAT in the Sub Menu.

1. Enter the IP address in the IP field
2. Check the box next to *Enable*
3. Click *Apply*

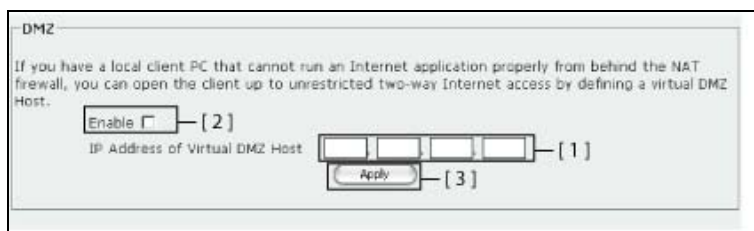

Figure 10-9: DMZ Settings Page

### Configuring Static/ Dynamic Routing

The PL9950-BBR allows you to set the static routing function and dynamic routing feature.

Static routing function determines the path that data follows over the network before and after it passes through the router. You can use static routing to allow different IP domain users to access the Internet through this device.

## Asoka® User's Guide PlugLink 9950 Cable/ DSL Router PL9950-BBR

**Static Route**  
The static routing function determines the path that data follows over your network before and after it passes through your router. You can use static routing to allow different IP domain users to access the Internet through this device. ☺

Destination LAN IP:

Subnet Mask:

Gateway:

<< Add

Figure 10-10: Static Routing Settings Page

Dynamic routing function allows the router to automatically adjust to physical changes in the network's layout. The PL9950-BBR uses dynamic RIP protocol. It determines the route that the network packets take based on the fewest number of hops between the source and the destination. The RIP protocol regularly broadcasts routing information to other routers on the network.

**Dynamic Route**  
The dynamic routing feature of the router can be used to allow the router to automatically adjust to physical changes in the network's layout. The router uses the dynamic RIP protocol. It determines the route that the network packets take based on the fewest number of hops between the source and the destination. The RIP protocol regularly broadcasts routing information to other routers on the network. ☺

Dynamic Routing:  Enable  Disable

Listen Mode:

Supply Mode:

Apply

Figure 10-11: Static Routing Settings Page

### Enabling/ Disabling UPnP

UPnP (Universal Plug-and-Play) is yet another advanced feature offered by your PlugLink router. It is a technology that offers seamless operation of voice messaging, video messaging, games and other applications that are UPnP-compliant. Some applications require the router's firewall to be configured in a specific way to operate properly. This usually requires opening TCP and UDP ports, and in some instances, setting trigger ports. An application that is UPnP-compliant has the ability to communicate with the router, basically 'telling' the router which way it needs the firewall configured. The router ships with the UPnP feature disabled. If you are using any applications that are UPnP-compliant, and wish to take advantage of the UPnP features, you can enable the UPnP feature. Under the *UPnP* link in the Sub menu under *Advanced*, simply select *Enable*. Click *Apply* to save the change.

**UPnP**  
This page allows the user to either "Enable" or "Disable" the UPnP function by simply checking or un-checking the appropriate check box. ☺

Enable UPnP:  [ 1 ]

Apply [ 2 ]

Figure 10-12: UPnP Settings Page

### Using Dynamic DNS

The Dynamic DNS service allows you to alias a dynamic IP address to a static host name in any of the many domains DynDNS.org offers, allowing your network computers to be more easily

## Asoka® User's Guide PlugLink 9950 Cable/ DSL Router PL9950-BBR

accessed from the Internet. DynDNS.org provides this service, for up to five host names, free to the Internet community.

The Dynamic DNSSM service is ideal for a home website, file server, or to make it easy to access your home PC and stored files while you're at work. Using the service can ensure that your host name always points to your IP address, no matter how often your ISP changes it. When your IP address changes, your friends and associates can always locate you by visiting instead.

To register free for your Dynamic DNS host name, please visit <http://www.dyndns.org>.

Setting up the PL9950-BBR's Dynamic NDS Update Client

You must register with DynDNS.org's free update service before using this feature. Once you have registered, follow the directions below.

1. Select DDNS on the Sub menu under Advanced
2. Check the box next to *Enable DDNS Support*
3. Enter the Host name
4. Enter the User Name
5. Enter the Password
6. Click *Apply*

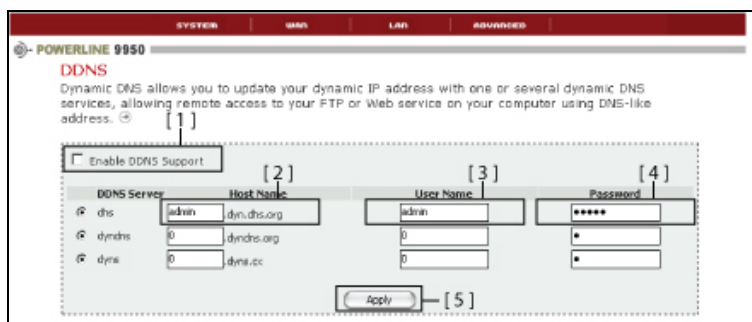

Figure 10-13: DDNS Settings Page

### Enabling Remote Management

Before you enable this advanced feature of your PL9950-BBR, make sure you have already set the administrator password. Remote management allows you to make changes to your router's settings from anywhere on the Internet. You will need to specify an IP address only to remotely manage the router.

To enable remote management, follow the directions described below.

1. Select *Remote Management* in the Sub menu under *Advanced*
2. Check the *Enable* box next to *Remote Management*
3. Enter the IP address you know you will be accessing the router from
4. Enter the port number you know you will be accessing the router from
5. Click *Apply*

## Asoka® User's Guide PlugLink 9950 Cable/ DSL Router PL9950-BBR

**Remote Management**  
This page allows the user to remotely manage the gateway. ⓘ

**Remote Management**

Enable  Remote Management [ 1 ]

IP Address  .  .  .  [ 2 ]

Port  [ 3 ]

[ 4 ]

Figure 10-14: Remote Management Settings Page

## Chapter 11

### PL9950-BBR Administration

#### System Details

The System Details section is where you can set the time zone, enter a new administrative password, enable remote management and turn the NAT function of the router on and off.

#### Setting or Changing the Administrative Login Information

The PL9950-BBR Router ships with a default user ID and password. If you wish to change the password for greater security, you can set a password here. Write down your password and keep it in a safe place, as you will need it to log into the PL9950-BBR Router in the future.

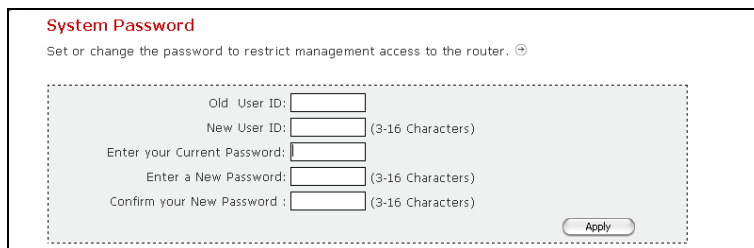

The screenshot shows a web interface titled "System Password" in red. Below the title is a subtitle: "Set or change the password to restrict management access to the router." followed by a help icon. The main content area is enclosed in a dashed border and contains the following fields: "Old User ID:" with an input box; "New User ID:" with an input box and "(3-16 Characters)" to its right; "Enter your Current Password:" with an input box; "Enter a New Password:" with an input box and "(3-16 Characters)" to its right; and "Confirm your New Password:" with an input box and "(3-16 Characters)" to its right. An "Apply" button is located at the bottom right of the dashed box.

Figure 11-1: System Password Screen

#### Setting or Changing the Powerline Network Access Login Information

The PL9950-BBR Router ships with a default Powerline Network Access password. This password is needed to configure the Powerline settings of the PL9950-BBR in the LAN section. By default, the Powerline Network Access password is PlugLink. If you wish to change the Powerline Network Access password for greater security, you can set a password here. Write down your password and keep it in a safe place, as you will need it to log into the PL9950-BBR Router in the future.

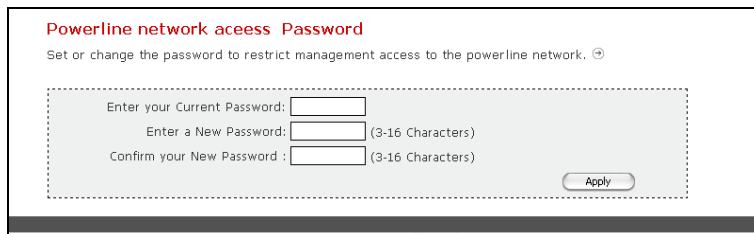

The screenshot shows a web interface titled "Powerline network access Password" in red. Below the title is a subtitle: "Set or change the password to restrict management access to the powerline network." followed by a help icon. The main content area is enclosed in a dashed border and contains the following fields: "Enter your Current Password:" with an input box; "Enter a New Password:" with an input box and "(3-16 Characters)" to its right; and "Confirm your New Password:" with an input box and "(3-16 Characters)" to its right. An "Apply" button is located at the bottom right of the dashed box.

Figure 11-2: Powerline Network Access Password Screen

## Asoka® User's Guide PlugLink 9950 Cable/ DSL Router PL9950-BBR

### Setting the Time and Time Zone

The PL9950-BBR Router keeps time by connecting to a Simple Network Time Protocol (SNTP) server. This allows the PL9950-BBR Router to synchronize the system clock to the global internet. The synchronized clock in the PL9950-BBR Router is used to record the security log and control client filtering. Select the time zone you reside in. If you reside in an area that observes daylight saving, then place a check mark in the box next to *Enable Daylight Saving*. The system clock may not update immediately. Allow at least 15 minutes for the PL9950-BBR Router to contact the time servers on the Internet and receive a response. You cannot set the clock yourself.

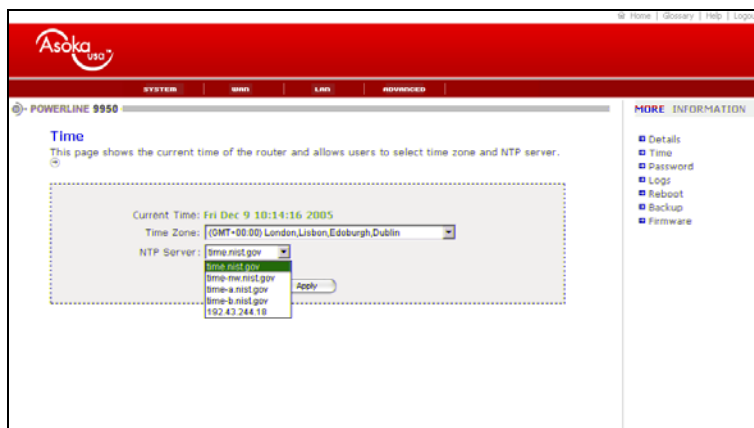

Figure 11-3: Setting Time Screen

### System Logs

The PL9950-BBR Router maintains a System Log which displays potential security threats and system information. This log can be viewed with a browser using the gateway's web management interface, or it can be automatically sent to an email address for convenience and archiving. Each log entry contains the date and time of the event and a brief message describing the event. It is possible to copy the log entries from the web management interface and paste into a report.

The System Log displays the following message types:

- System Maintenance  
Logs general system activity, such as administrator logins and system activations.
- System Errors  
Logs problems with DNS and email.
- Blocked Web Sites  
Logs web sites or newsgroups blocked by content filter list or by customized filtering.
- Blocked Java, ActiveX and cookies  
Logs Java, ActiveX and cookies blocked by the gateway.
- User Activity  
Logs successful and unsuccessful log in attempts.
- Attacks  
Logs messages showing Denial of Service attacks, such as SYN Flood, Ping of Death, and IP Spoofing.
- Dropped TCP  
Logs blocked incoming TCP connections.
- Dropped UDP



## Asoka® User's Guide PlugLink 9950 Cable/ DSL Router PL9950-BBR

- Logs blocked incoming UDP packets.
- Dropped ICMP  
Logs blocked incoming ICMP packets.
- Network Debug  
Logs NetBIOS broadcasts, ARP resolution problems, and NAT resolution problems.

To view system log:

1. Click on *Systems* in the Main menu.
2. In the Sub menu, select *Logs*.



Note

Some network conditions can produce network traffic that appears to be an attack, even when no one is deliberately attacking the LAN. To follow up on a possible attack, contact your ISP to determine the source of the attack. Regardless of the nature of the attack, your LAN is protected and no further steps must be taken.

---

To configure log settings, fill in the form below the log table.

1. Weekly/Daily/No – Enter how often you would like the system logs to be emailed to you.
2. Day – Enter the day of the week (ie. Monday) you would like the system logs to be emailed.
3. Time – Enter the time you would like the system logs to be emailed.
4. Email Address – Enter the your full email address ([username@mydomain.com](mailto:username@mydomain.com)) in the Email Address field to receive the event log via email. Once sent, the log is cleared from the gateway memory. If this field is left blank, the log is not emailed.
5. SMTP Address – To email logs, enter the name or IP address of your SMTP server. If this field is left blank, logs are not emailed.
6. SMTP Account – Enter the email account ID.
7. SMTP Password – Enter the password to your email account.

### Rebooting the PL9950-BBR Router

Sometimes it may be necessary to reboot the PL9950-BBR if it begins working improperly. Rebooting the PL9950-BBR Router will NOT delete any of your configurations. To reboot, follow these instructions:

1. Click on *System* in the top menu.
2. Click on *Reboot* in the right menu.
3. Click on the *System Reboot* button.

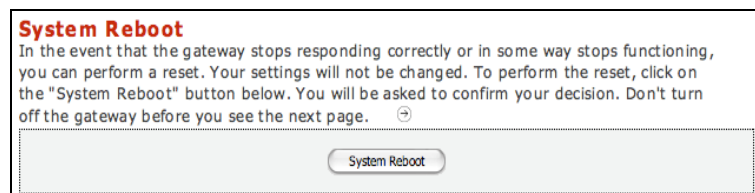

Figure 11-4: System Reboot Screen

4. A popup window will appear asking you to confirm the system reboot. Click OK.

**Asoka® User's Guide**  
**PlugLink 9950 Cable/ DSL Router PL9950-BBR**

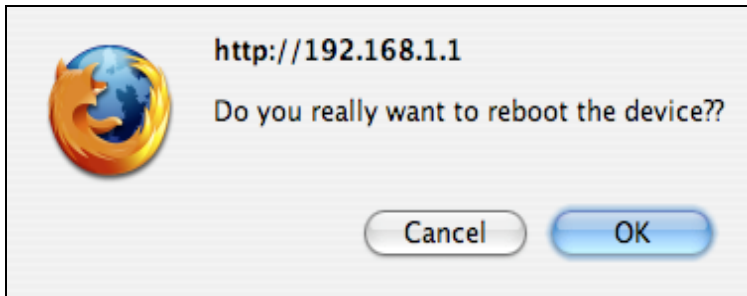

Figure 11-5: System Reboot Confirmation Popup

5. The *Reset Device Successfully* screen will appear as shown in figure 11-6. Rebooting the PL9950-BBR Router can take up to 60 seconds. It is important not to turn off the power or unplug the PL9950-BBR Router during the reboot.

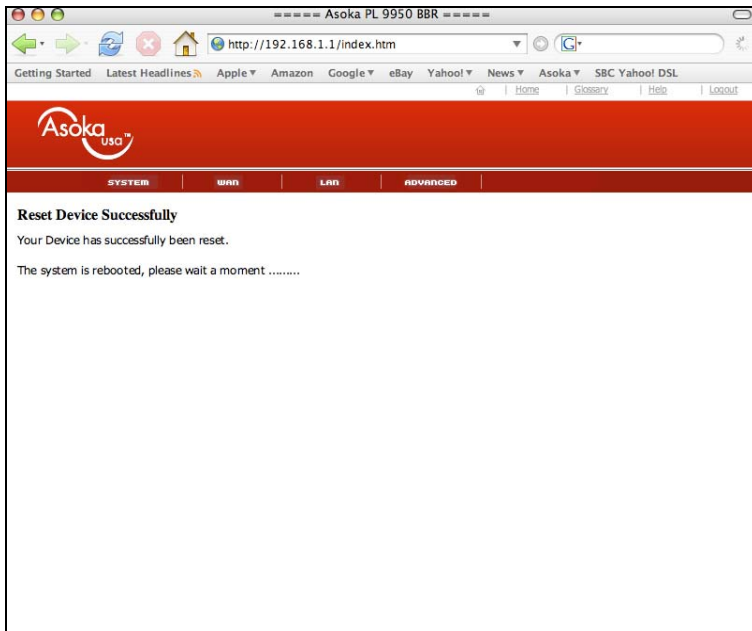

Figure 11-6: System Reboot Status Screen

6. When the PL9950-BBR reboots, the home page should appear automatically. If not, type in the PL9950-BBR Router's address (default = **192.168.1.1**) into the address or navigation bar of your web browser.

### Restoring Factory Default Settings

Using this option will restore all of the settings in the PL9950-BBR Router to the factory default settings. It is recommended that you back up your settings prior to restoring to factory default settings. To restore factory default settings, follow these instructions:

1. Click on *System* in the top menu.
2. Click on *Restore Defaults* in the right menu.
3. Click the *Factory Default* button.

## Asoka® User's Guide PlugLink 9950 Cable/ DSL Router PL9950-BBR

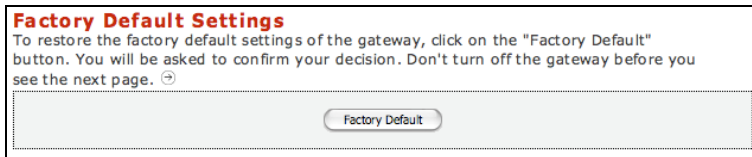

Figure 11-7: Factory Default Settings Screen

4. A popup window will appear asking you to confirm the factory default restore. Click OK.

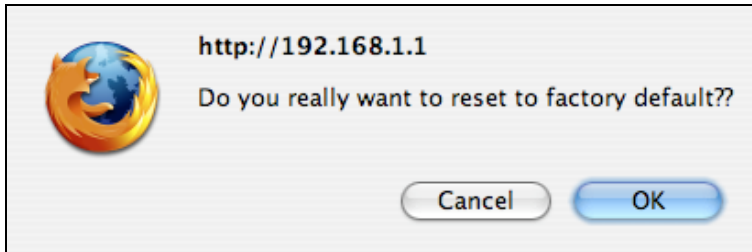

Figure 11-8: Factory Default Restore Confirmation Popup

### Backup Settings

The configuration settings of the PL9950-BBR are stored within the router in a configuration file. This file can be saved (backed up) to a user's PC or retrieved (restored) from the User's PC. To backup settings, follow these instructions:

1. Click on *Systems* in the top menu.
2. Click on *Backup Settings*.
3. Click on the *Backup Settings* button.

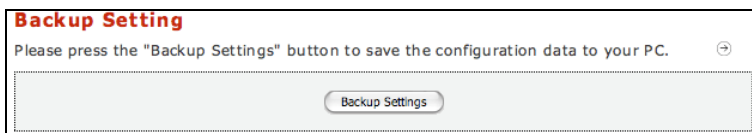

Figure 11-9: Backup Settings Screen

To retrieve (restore) an old router configuration file from a previous backup, follow these instructions:

1. Click on *Systems* in the top menu.
2. Click on *Browse*.
3. Locate and double-click on the old router configuration file.
4. Click *Restore Settings*.

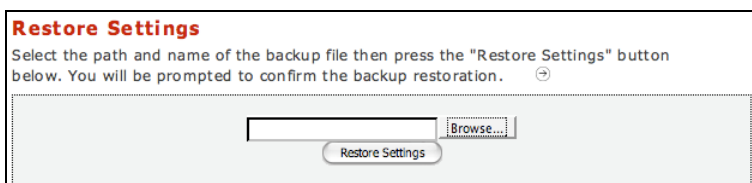

Figure 11-10: Retrieve Backup Settings Screen

## Asoka® User's Guide PlugLink 9950 Cable/ DSL Router PL9950-BBR

### Upgrading Firmware

New firmware upgrades from Asoka are made available periodically. Firmware upgrades contain feature improvements and fixes to problems or bugs that may exist. When Asoka releases new firmware, you can download the firmware from Asoka's web site at <http://www.asokausa.com> and update your Router's firmware to the latest version.

To upload a new firmware upgrade onto the Router, follow these steps.

1. Click on *Systems* in the *Main* menu.
2. In the Sub menu, select *Firmware*.
3. Select the appropriate time zone, date and time.
4. Click *Browse* to locate the new firmware upgrade file downloaded from Asoka's web site.
5. The box next to the *Browse* button will now display the location and name of the firmware file you just selected.
6. Click *Update*.
7. You will be asked if you are sure you want to continue. Click *OK*.
8. You will see one more message. This message tells you that the router may not respond for as long as one minute as the firmware is loaded into the router and the router is rebooted. Click *OK*.
9. When the firmware upgrade is complete, the router home page should appear automatically. If not, type in the router's address (default – **192.168.1.1**) into the address or navigation bar of your web browser.

---

Note: It is sometimes desirable to restore original default settings for the router. This can be done by using the *Clear Old Configuration* function, which will restore all factory settings. After an erase, the router's username will be \_\_\_\_\_, the password will be \_\_\_\_\_, the LAN IP address will be \_\_\_\_\_ and the router's DHCP server will be set to *Enabled*.

---

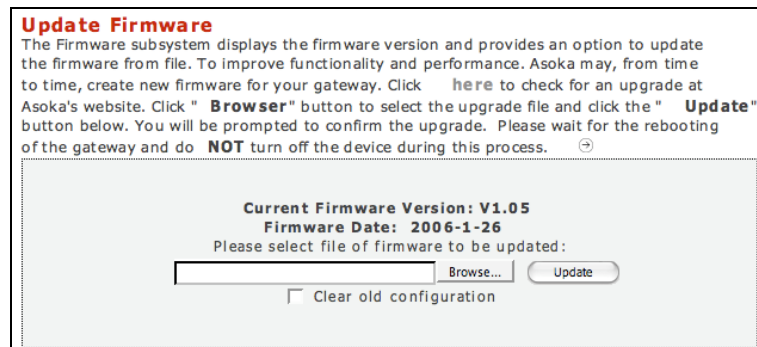

Figure 11-11: Update Firmware Screen

## Appendix A

### Internet Connection Information Form

Print this page. Fill in the configuration parameters from your Internet Service Provider (ISP).

ISP Login Name: The login name and password are case sensitive and must be entered exactly as given by your ISP. Some ISPs use your full email address as the login name. The Service Name is not required by all ISPs. If you connect using a login name and password, enter the following:

|   |     |                                    |
|---|-----|------------------------------------|
| Login Name:   |     |                                    |
| Password:   |     |                                    |
| Service Name:   |     |                                    |
| Do you have a Fixed IP or Static IP?  | Yes | No, Skip to DNS Server Information |
| <b>Fixed or Static IP</b>   |     |                                    |
| IP Address:   |     |                                    |
| Subnet Mask:  |     |                                    |
| Fixed or Static:  |     |                                    |
| <b>DNS Server Information</b>   |     |                                    |
| Primary DNS Server IP Address:  |     |                                    |
| Secondary DNS Server IP Address:  |     |                                    |
| <b>Host and Domain Names</b>  |     |                                    |
| Some ISPs use a specific host or domain name. If you haven't been given a host or domain name, you can use the following examples as a guide:   |     |                                    |
| <ul style="list-style-type: none"> <li>▪ If your main email account with your ISP is name@abc.com, then use <b>name</b> as your host name. Your ISP might call this your account, user, host, computer, or system name.</li> <li>▪ If your ISP's mail server is <b>mail.isp.abc.com</b>, then use <b>isp.abc.com</b> as the domain name.</li> </ul> |     |                                    |
| ISP Host Name:  |     |                                    |
| ISP Domain Name:  |     |                                    |

## **Appendix B**

### **Technical Support**

PLEASE REFER TO THE WARRANTY AND SUPPORT INFORMATION CARD THAT WAS SHIPPED WITH YOUR PRODUCT.

By registering your product at [www.asokausa.com/register](http://www.asokausa.com/register), we can provide you with faster expert technical support and timely notices of product and software upgrades.

### **Support Information**

Phone: 1-650-286-0300

Email: [support@asokausa.com](mailto:support@asokausa.com)

URL: [www.asokausa.com](http://www.asokausa.com)

## Appendix C

### Technical Specifications

#### Standards Compliance

- HomePlug® I
- IEEE 802.3 10BASE-T Ethernet
- IEEE 802.3 10BASE-T Ethernet
- IEEE 802.3x Flow Control
- IEEE 802.1D Spanning Tree Protocol
- IEEE 802.1p Class of Service (CoS)
- IETF RFC 2401 IPsec pass through
- IETF RFC 1631 NAT (many-to-one)
- IETF RFC1332 IP Control Protocol
- IETF RFC 2684 Bridged Ethernet
- IETF RFC 2516 PPPoE
- IETF RFC 2637 PPTP
- IETF RFC 1157 SNMP v2 & v3
- IETF RFC 2030 SNMP
- IETF RFC 1213 MIB II
- IETF RFC 826 ARP
- IETF RFC 826 Telnet
- IETF RFC 783 TFTP
- IETF RFC 2131 DHCP

#### System Requirements

- Windows® 98 SE, 2000, ME and XP OS
- Mac OS X

#### Network Protocol

- TCP/IP

#### Network Interface

- Ethernet (RJ-45)

#### Bandwidth

- 85 Mbps

#### Operating Frequency

- 4 to 21 MHz

#### Modulation Schemes

- Orthogonal Frequency Division Multiplexing (OFDM)
- Symbol Modulation DQPSK
- DBPSK
- ROBO Carrier Modulation

#### Security

- 56-bit DES Encryption

#### Additional Protocols

- Forward Error Correction (FEC)
- Automatic Channel Adaptation

#### Power Supply

- 100-240V

#### LEDs

- Power
- PLC Activity
- Ethernet Activity
- WAN Activity

#### Dimensions

- Size: 3.75" x 2.6" x 1.6" (L x W x H)
- Weight: 0.394 lbs
- Cable length: 6'

#### Environmental Specifications

- Operating temperature: 32°F to 113°F (0°C to 45°C)
- Operating humidity: 10% to 85% Non-condensing
- Storage temperature: -4°F to 158°F (-20°C to 70°C)
- Storage humidity: 5% to 90% Non-condensing

#### Electromagnetic Emissions

- FCC Part 15 Class B
- UL (US and Canada)
- CE

## **Appendix D**

### **FCC Statement**

This equipment has been tested and found to comply with the limits for a Class B digital device, pursuant to part 15 of FCC Rules. These limits are designed to provide reasonable protection against harmful interference in a residential installation. This equipment generates and can radiate radio frequency energy and, if not installed and used in accordance with the instructions, may cause harmful interference to radio communications. However, there is no guarantee that interference will not occur in a particular installation. If this equipment does cause harmful interference to radio or television reception, which can be determined by turning the equipment off and on, the user is encouraged to try to correct the interference by one or more of the following measures:

- Reorient or relocate the receiving antenna.
- Increase the separation between the equipment and receiver.
- Connect the equipment into an outlet on a circuit different from that to which the receiver is connected.
- Consult the dealer or an experienced radio/TV technician for help.

This device complies with Part 15 of FCC Rules.

Operation is subject to the following two conditions:

- (1) This device may not cause harmful interference, and
- (2) This device must accept any interference received, including interference that may cause undesired operation.

This equipment complies with FCC RF radiation exposure limits set forth for an uncontrolled environment. This equipment should be installed and operated with a minimum distance of 20 centimeters between the radiator and your body.

### **Voluntary Control Council for Interference (VCCI) Statement**

This equipment is in the second category (information equipment to be used in residential areas) and conforms to the standards set by the Voluntary Control Council for Interference by Data Processing Equipment and Electronic Office machines that are aimed at preventing radio interference in residential areas.

### **EN 55 022 Declaration of Conformance**

This is to certify that the PlugLink 9950 Cable/DSL Router (PL9950-BBR) is shielded against the generation of radio interference in accordance with the application of Council Directive 89/336/EEC, Article 4a. Conformity is declared by the application of EN 55 022 Class B (CISPR 22).

### **Canadian Department of Communications Radio Interference Regulations**



**Asoka® User's Guide**  
**PlugLink 9950 Cable/ DSL Router PL9950-BBR**

This digital apparatus (PlugLink 9950 Cable/DSL Router PL9950-BBR) does not exceed the Class B limits for radio noise emissions from digital apparatus as set out in the Radio Interference Regulations of the Canadian Department of Communications.

**Règlement sur le brouillage radioélectrique du ministère des Communications**

Cet appareil numérique (PlugLink 9950 Cable/DSL Router PL9950-BBR) respecte les limites de bruits radioélectriques visant les appareils numériques de classe B prescrites dans le Règlement sur le brouillage radioélectrique du ministère des Communications du Canada.

**Statement of Conditions**

In the interest of improving internal design, operational function, and/ or reliability, Asoka reserves the right to make changes to the products described in this document without notice.

Asoka does not assume any liability that may occur due to the use or application of the product(s) or circuit layout(s) described herein.

## **Appendix E**

### **Warranty**

Asoka warrants that (a) the hardware components of the product will be free from defects in materials and workmanship under normal use for one (1) year from the date of purchase when used within the limits set forth in the Specifications section of the User Guide, and (b) the software components will perform substantially in accordance with Asoka's published specifications for ninety (90) days from the date of purchase, but does not warrant that the software will be error-free or free of all defects.

Should a product fail to perform as described in the User Guide within the warranted period, it will be repaired or replaced with the same or functionally equivalent product by Asoka, at its discretion, free of charge provided that you: (a) return the failed product to an Asoka designated repair facility with shipping charge prepaid, and (b) provide Asoka with proof of the original date of purchase. Repaired or replacement products will be returned to you with shipping charges prepaid. Asoka warrants any replaced or repaired product or component for the remainder of the initial warranty period. Replacement products may be refurbished or contain refurbished materials or components. If Asoka, by its sole determination, is unable to restore the product to proper operating condition, it will refund the depreciated purchase price of the product.

This warranty extends only to you, the original purchaser and is not transferable to any subsequent

Asoka USA Corporation  
558 Pilgrim Drive Ste H  
Foster City CA 94404  
Sales: (650) 286-1700; [sales@asokausa.com](mailto:sales@asokausa.com)  
Support: (650) 286-0300; [support@asokausa.com](mailto:support@asokausa.com)  
URL: [www.asokausa.com](http://www.asokausa.com)

## Free Manuals Download Website

<http://myh66.com>

<http://usermanuals.us>

<http://www.somanuals.com>

<http://www.4manuals.cc>

<http://www.manual-lib.com>

<http://www.404manual.com>

<http://www.luxmanual.com>

<http://aubethermostatmanual.com>

Golf course search by state

<http://golfingnear.com>

Email search by domain

<http://emailbydomain.com>

Auto manuals search

<http://auto.somanuals.com>

TV manuals search

<http://tv.somanuals.com>