



MERLIN[®]

**Communications System
Models 1030 and 3070
With Feature Module 4
Administration Manual**

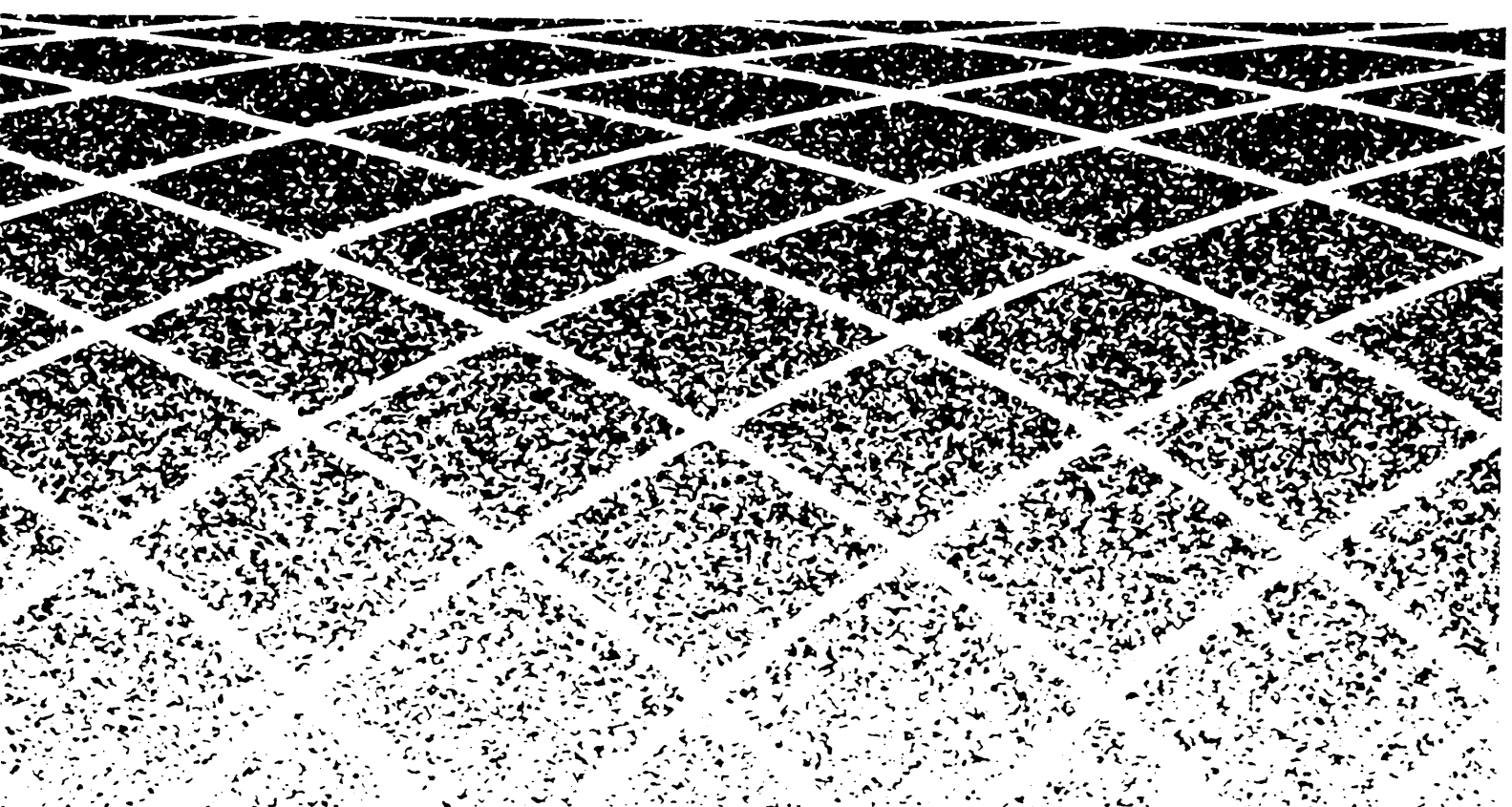

Table of Contents

	Page		Page
How to Use This Manual	2	Assigning Voice Terminals to Groups for Group Page	55
Administration Overview	3	Establishing Night Service	56
Administering Your System for the First Time	3	Activating Night Service	56
Making Changes to Your System Later	4	Programming System Speed Dial Codes	57
MERLIN System Components	6	Administering SMDR (Station Message Detail Recording) Options	59
The Model 1030 Control Unit and Expansion Unit	6	Setting Your Printer to Scroll to the Top of the Page	60
The Administrator/Attendant Console	9	Setting the Return Interval for Transferred Calls	61
Using the Console	12	Programming Voice Terminals for Office Priorities	62
Optional Equipment	12	Using Centralized Voice Terminal Programming	66
Preparing to Administer Your System	13	Assigning an Automatic Line Selection Sequence	67
The Square vs. Pooled Decision	14	Assigning Programmable Line Ringing for Incoming Calls	68
About Square Systems	14	Assigning Cover Buttons	69
About Pooled Systems	17	Assigning Line Pickup Buttons	71
The Forms and Labels You Need	20	Programming Voice Terminals for Personal Priorities	72
Choosing a Time to Administer Your System	20	Assigning Features to Programmable Buttons	73
Basic Administration	21	Feature Programming Chart	74
Setting Your Control Unit	22	Assigning Personal Speed Dial Codes to 5- and 10-Button Voice Terminals and Basic Telephones	77
Changing Your System Later	24	Using Special Characters in Programmed Dialing Sequences	78
Notes on Resetting Control Unit Switches	24	Selecting a Personalized Ring	80
Entering and Leaving Administration Mode	25	Programming Voice Announcement Disable	81
Specifying Touch-Tone or Rotary Dialing	26	Programming Simultaneous Voice and Data Calls	82
Setting Up Square Systems	27	Special Information about Attendant Consoles	83
Preparing to Assign Lines to Voice Terminals	27	Special information about 5-Button Voice Terminals	87
Assigning Lines to Buttons	29	Special Information about Basic Telephones	88
Setting Up Pooled Systems	31	MERLIN System Features	91
Preparing to Set Up Line Pools	31	Appendix: System and Voice Terminal Configuration Forms	98
Assigning Lines to Line Pools	32	Index	116
Preparing to Assign Lines to Buttons and set up Access to Line Pools	33	Quick Reference Guide to Administration Procedures	117
Assigning Individual Lines to Buttons	36		
Assigning Line Pools to Buttons (Button Access to Line Pools)	37		
Assigning Dial Access to Line Pools	38		
Customizing with Additional System Options	40		
Assigning Call Restrictions to Voice Terminals	41		
Assigning Outward and Toll Call Restrictions	42		
Setting Up Allowed Lists	44		
Assigning Allowed-List Call Restrictions	45		
Administering Automatic Route Selection (A D S)	46		
Preparing to Administer ARS Tables	46		
Administering Area Code/Exchange Sections of ARS Tables	52		
Administering Pool Number and Other Digits Sections of ARS Tables	53		
Activating and Deactivating ADS	54		

How to Use This Manual

The advanced technology of the MERLIN™ communications system offers a flexibility that allows you to customize the system to your business communication needs. As system administrator, you may be responsible for customizing your MERLIN system immediately after installation, and you will undoubtedly be the person to make any necessary changes as your business needs change.

This administration manual takes you step by step through the procedures involved in customizing your system. Here is how to use the manual:

If you are setting up a new system for the first time:

1. Read the "Administration Overview," page 3, to learn about the tasks you'll be performing as system administrator.
2. Review the "MERLIN System Components," page 6, to familiarize yourself with the equipment you'll be working with.
3. If you haven't already decided which features you want your MERLIN system to have, look through the "MERLIN System Features" described on pages 91 through 97.
4. Get ready to administer your system by filling out the System and Voice Terminal Configuration Forms on pages 98 through 115 and by reviewing the information in "Preparing to Administer Your System," page 13.
5. Read through "Basic Administration," page 21, and perform those tasks that apply to your particular system.
6. Similarly, work your way through "Customizing with Additional System Options," page 40, adding features that fit your needs.
7. Review the features described in "Programming Voice Terminals for Office Priorities," page 62. Because these features have systemwide effects, you should program the features on selected voice terminals yourself or oversee any programming done by voice terminal users.
8. If you choose, further customize features on individual voice terminals by performing the procedures described in "Programming Voice Terminals for Personal Priorities," page 72.
9. To learn how to program your attendant console(s), review "Special Information about Attendant Consoles," page 83.
10. If you have many 5-button voice terminals or basic telephones connected to your system, read "Special Information about 5-Button Voice Terminals," page 87, and "Special Information about Basic Telephones," page 88.

If you are changing some options or features that are already in place:

1. Review the information in "Preparing to Administer Your System," page 13.
2. Using the Table of Contents, Index, or page references in "MERLIN System Features," page 91, locate the procedure for the option or feature you want to change and perform the necessary steps in the procedure.
3. If you are making a basic modification to the system—that is, a modification that requires changing any of the switch settings on your control unit—read the information in "Changing Your System Later," page 24.

Administration Overview

Because the effects of system administration are wide-ranging, only you or someone you delegate should perform administration procedures. The term *administrator* as used in this manual refers to the act of establishing certain options and features that have systemwide impact, such as assigning the outside lines that each voice terminal can access or defining System Speed Dial codes for everyone in the system to use. You use a particular voice terminal, the administrator/attendant console, and the switches on your control unit to administer your system. However, before you can perform administration, you have to put the system in a special state of operation, called administration mode. (See "Entering and Leaving Administration Mode," page 25, for more information about this operating state.) In contrast, the term *program* refers to assigning programmable features to an individual voice terminal. Anyone can put a voice terminal in programming mode and assign it features while the system is in the regular call-handling mode.

ADMINISTERING YOUR SYSTEM FOR THE FIRST TIME

System administration involves a series of simple procedures that you perform at the control unit and at the administrator/attendant console (the voice terminal connected to the intercom 10 jack on the control unit). The MERLIN system is designed to be up and running with a minimum amount of administration. However, depending on the conditions of your communications environment or the options you choose, certain administration procedures may be *required* to set up a newly installed system. Before attempting any other procedures, you must review the information in "Basic Administration," page 21, and complete the procedures that apply to your system and business needs. Most administration procedures are optional, however, depending on which features you want to use in your business; these features are described in "Customizing with Additional System options," page 40. There are some features

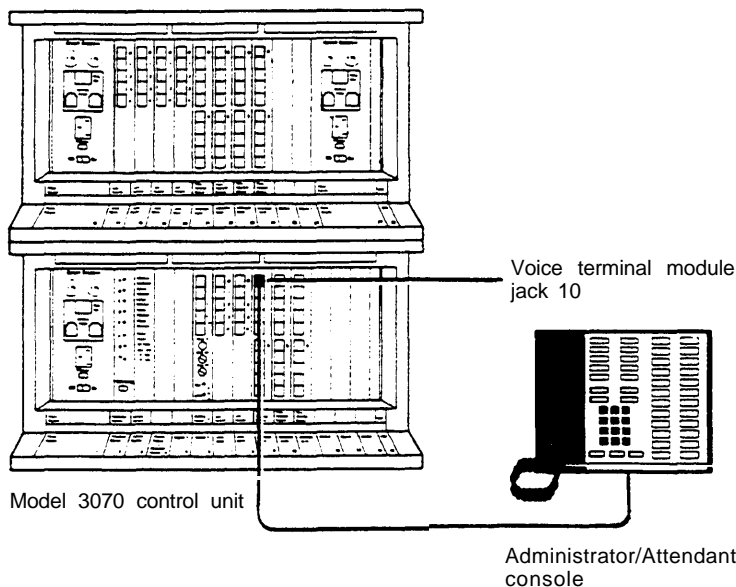
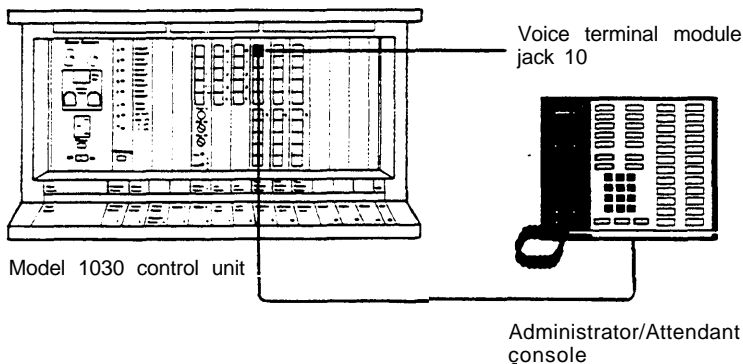

There are some features that you may want to assign to certain voice terminals yourself because they influence call-handling efficiency throughout your entire business. Assigning these features does not involve administrative procedures, but rather, simple programming procedures at individual voice terminals. These procedures are described in "Programming Voice Terminals for Office Priorities," page 62. Finally, if you want to help people program their voice terminals to meet their individual needs, follow the procedures outlined in "Programming Voice Terminals for Personal Priorities," page 72. Later, if your needs change, you can always alter any system administration or programming that has been done.

The chart which follows shows the five types of procedures described in this manual. If you are about to perform system administration for the first time, be sure to read "Preparing to Administer Your System," page 13, before you attempt any procedures.

MAKING CHANGES TO YOUR SYSTEM LATER

Changes to system features that are administered from the administrator/attendant console or programmed at individual voice terminals are easiest to implement. To make these changes after your system has been set up, go to the section of this manual that gives the procedure for assigning the feature or option you want, and carry out just that procedure.

Basic changes to the way your system operates—that is, changes to the switch settings on the control unit—may erase important system administration that is now in place. Before you change any switch settings, review the information in "Changing Your System Later," page 24.

Prepare for System Administration

These procedures help you get ready to administer your system.

- Decide how people will access outside lines.
- Complete and keep handy your System and Voice Terminal Configuration Forms.
- Schedule a time to perform administration procedures.

Perform Basic Administration

Depending on your system requirements, some of these procedures may be necessary immediately after your system is installed; you can also perform these procedures whenever you need to change your system later. Perform these procedures at the control unit and the administrator/attendant console.

- Set your control unit.
- Learn how to enter and leave administration mode.
- Specify Touch-Tone or rotary dialing.
- Set up a square system, with lines assigned to buttons.
- Set up a pooled system, with line pools, line-to-button assignments, and either Button Access or Dial Access to Line Pools.

Customize with Additional System Options

These procedures are optional. Perform them at the administrator/attendant console whenever you want to add these features to your system.

- Assign tail restrictions.
- Administer Automatic Route Selection.
- Assign voice terminals to groups for Group Page.
- Establish Night Service.
- Program System Speed Dial codes.
- Administer Station Message Detail Recording options.
- Set return interval for transferred calls.

Program Voice Terminals for Office Priorities

These procedures are optional. Use Centralized Voice Terminal Programming or perform them at individual voice terminals whenever you want to give someone access to these features.

- Assign an Automatic Line Selection sequence.
- Assign Programmable Line Ringing for incoming calls.
- Assign Cover buttons.
- Assign Line Pickup buttons.

Program Voice Terminals for Personal Priorities

These procedures are optional. Use Centralized Voice Terminal Programming or perform them at individual voice terminals whenever you want to give someone access to these features.

- Assign features to programmable buttons.
- Assign Personal Speed Dial codes to 5- and 10-button voice terminals and basic telephones.
- Use special characters in programmed dialing sequences.
- Select a Personalized Ring.
- Program Voice Announcement Disable.
- Program Simultaneous Voice and Data Calls.

MERLIN System Components

When performing your administration tasks, you work with three components of the MERLIN system: the control unit, the administrator/attendant console, and individual voice terminals. You may also have some optional equipment that adds features and capabilities to your system but does not affect system administration. The following descriptions will help you become familiar with the components that make up your system.

For information about system installation, refer to the *Installation Guide: Models 1030 and 3070*.

THE MODEL 1030 CONTROL UNIT AND EXPANSION UNIT

The Model 1030 control unit provides connections for up to 10 outside lines and 30 voice terminals, or for up to 15 outside lines and 20 voice terminals, depending on the combination of Line and Voice Terminal Modules you choose. For a 1030 configuration, you have Line Modules in slots 7 and 8 (10 lines) and Voice Terminal Modules in slots 9, 10, and 11 (30 voice terminals). For a 1520 configuration, you replace the Voice Terminal Module in slot 11 with a Line Module. This increases the number of lines to 15 and decreases the number of voice terminals to 20. The addition of an Expansion Unit makes the Model 1030 control unit a Model 3070 control unit and increases system capacity to up to 30 outside lines and 70 voice terminals, again depending on the combination of Line and Voice Terminal Modules you choose.

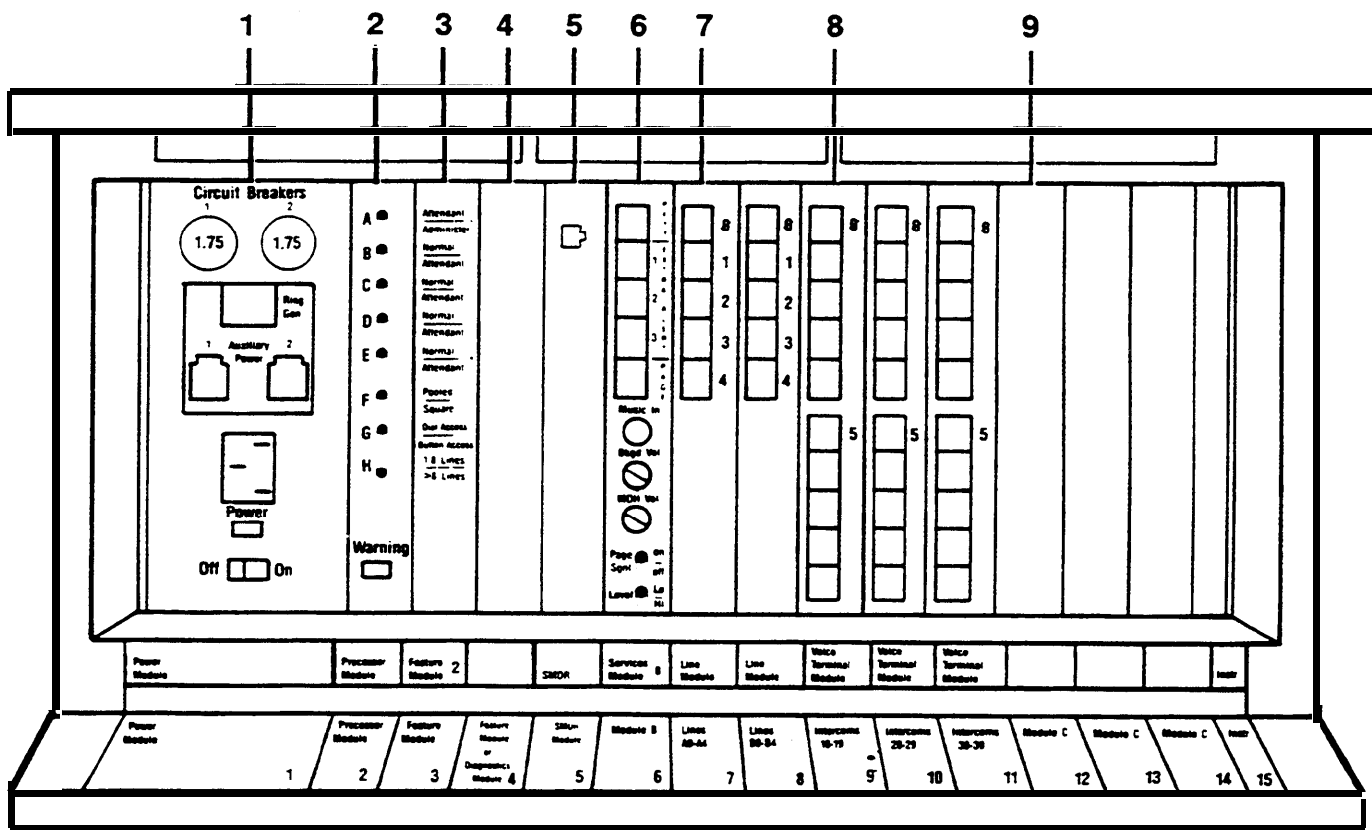

THE MODEL 1030 CONTROL UNIT

1. Power Module: Reduces ac power to a level the system can handle.

- Circuit Breakers. Automatically cut the power to the control unit if an overload occurs.
- Ring Generator jack. Optional Ring Generator Unit plugs in here if you have basic Touch-Tone or rotary telephones.

- Auxiliary Power connector. Auxiliary Power Unit plugs in hereto provide the additional power for systems with many optional accessories.
- Power light. Green light indicates power is on.
- On/Off switch. Turns the power to the control unit on and off.

2. Processor Module: **Works in conjunction with Feature Module 4 to control system operating conditions.**
 - Switches A, B, C, D, E, F, G, and H. **Selects system options provided by Feature Module 4.**
 - Warning light. **Red light warns of problem in control unit. It also comes on for approximately one minute when you first turn on the system.**
3. Feature Module 4: **Contains the software that controls your MERLIN system. You set eight switches on the Processor Module, according to the labels on the Feature Module, to select the following options from the programs stored in Feature Module 4:**
 - Attendant/Administer (10) option. **Selects attendant or administration mode of operation for the administrator/attendant console.**
 - Normal/Attendant (11, 12, 13, 14) options. **Select normal or attendant mode of operation for these four voice terminals.**
 - Pooled/Square option. **Selects mode of operation for the system so that line buttons on voice terminals represent either groups of lines (pooled) or separate lines (square). For detailed information on this option, see "The Square vs. Pooled Decision," page 14.**
 - Dial Access/Button Access option. **Sets the system so that line pools can be accessed at a voice terminal by touching a button to which the pool is assigned or by touching a Pool Access button and then dialing the access code for that line pool.**
 - 1-8 LineS/>8 Lines option. **Sets the system size to eight or fewer outside lines (small system) or to more than eight lines (large system).**
4. Diagnostics Module (optional): **Aids in identifying faulty components if the system malfunctions.**
5. SMDR (Station Message Detail Recording) Module: **Allows connection of a printer so you can print out call traffic reports automatically as calls are made. You can also issue configuration reports whenever you want them during administration procedures.**
6. Services Module (optional): **Contains the following jacks, switches, and adjusters to connect and control optional equipment:**
 - PFTT (Power Failure Transfer Telephone) jack. **With an adapter, connects up to four standard modular telephones for use as backup during commercial power outage. The system automatically switches service to them if power fails.**
 - Extra Alert jacks. **Three jacks connect strobe lights, loud bells, or horns for three noisy or remote zones where the regular voice terminal ring cannot be heard.**
 - Page jack. **Connects a loudspeaker paging system. With an adapter, you can have up to three paging zones.**
 - Music-In jack. **Connects a music source for Music-on-Hold or background music through a paging system.**
 - Bkgd Vol (Background Volume) control. **Allows volume adjustment for background music.**
 - MOH Vol (Music-on-Hold Volume) control. **Allows volume adjustment for Music-on-Hold.**
 - Page Sgnl switch. **On (up) provides a short tone before loudspeaker paging announcements. Off (down) eliminates the signal.**
 - Level switch. **Sets amplification for music source. Hi (down) is for sources with their own amplifiers; Lo (up) is for those without.**
7. Line Module: **Provides jacks for up to five outside lines. Normally, there are two Line Modules in the Model 1030 control unit. You may have a third, however, if you decide to replace the Voice Terminal Module normally found in slot 11 with a Line Module in order to have 15 lines instead of 10 (1520 configuration). If you add an Expansion Unit, you will not need this extra line capacity, and you can return your control unit to the 1030 configuration.**

The Expansion Unit contains up to four Line Modules. These modules, combined with two Line Modules in the 1030 control unit, provide the *system maximum* of six Line Modules (30 lines).

 - Jacks 0, 1, 2, 3, 4. **Connect outside lines to the MERLIN system. Line Modules have letters as well as numbers. For example, the first Line Module in the control unit is lettered A, so the jacks in that Line Module are called A0, A1, A2, A3, and A4.**
8. Voice Terminal Module: **Provides jacks for ten voice terminals. You may have up to three Voice Terminal Modules for the Model 1030 control unit and up to four additional Voice Terminal Modules in the Expansion Unit. A Basic Telephone Module with jacks for basic Touch-Tone or rotary telephones is also available.**
 - "0" begins the numbering for the first five voice terminal jacks on the module. These jacks (and the location of the module) determine the intercom numbers of the voice terminals plugged into them. For example, if a Voice Terminal Module is plugged into the slot labeled "intercoms 20-29," the jack labeled "0" is for intercom 20. The jack below it is for intercom 21, and so on.
 - "5" begins the numbers for the second five voice terminals.
9. Module C (optional): **An Off-Premises Telephone Interface to support off-premises telephones.**

Addition of the Expansion Unit changes the Model 1030 control unit to a Model 3070 control unit and increases overall system capacity to 30 lines and 70 voice terminals. The unit can accommodate:

- Up to two Power Modules
- Up to four Line Modules
- Up to four Voice Terminal Modules

The second Power Module is required for systems with more than 20 lines or more than 60 voice terminals. The Expansion Unit also has two additional module slots for future use.

NOTE: If you add an Expansion Unit to a system configured for 15 outside lines and 20 voice terminals, you must remove the Line Module from slot 11 and replace it with a Voice Terminal Module. This returns your system to the standard configuration of 10 outside lines and 30 voice terminals. You can then insert modules into the appropriate slots in the Expansion Unit.

If Expansion Unit slots 17, 18, 21, 22, and 23 are empty, the power switch on the first Power Module (slot 16) must be set to *Off* (left). If modules are inserted in any of these slots, the power switch must be set to *On* (right).

If Expansion Unit slots 19, 20, and 24 are empty, the power switch on the second Power Module (slot 27) must be set to *Off* (left). If modules are inserted in any of these slots, the power switch must be set to *On* (right).

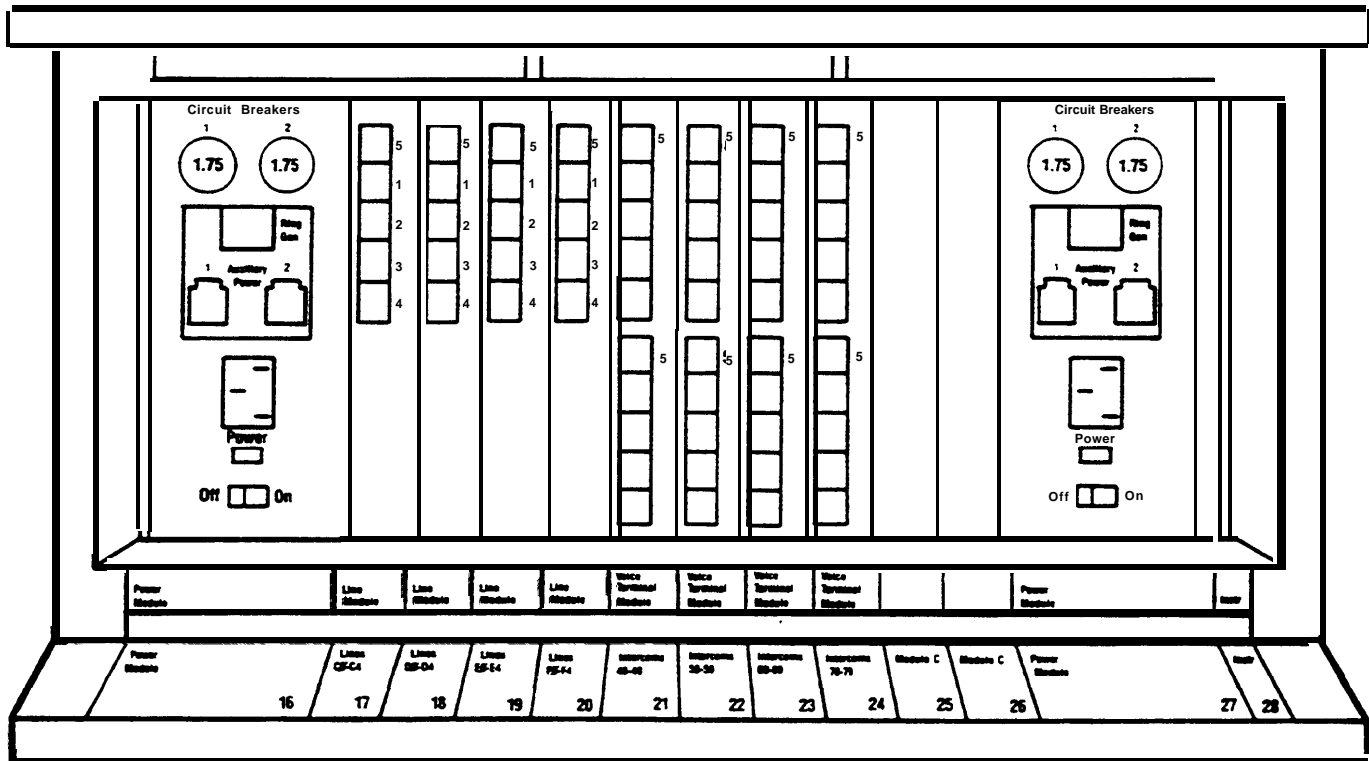

EXPANSION UNIT FOR MODEL 1030

THE ADMINISTRATOR/ATTENDANT CONSOLE

The administrator/attendant console is the voice terminal connected to the intercom 10 Voice Terminal Module jack in the control unit. The console operates in either of two ways:

- It functions as your *primary attendant console* under ordinary day-to-day conditions.
- It functions as the *administrator console* when it is used to perform many of the procedures explained later in this manual.

To change the administrator/attendant console from one mode of operation to the other, you simply set a switch on the control unit and then set another switch on the console itself. When the console is in administration mode, some of its buttons take on different functions than they do when the console is in the regular call-handling mode. Therefore, when you administer the system, you insert a special set of administration mode button labels in the console so that you know which buttons to touch. You will find two sets of button labels, one for a small console and another for a large console, in the back of this manual. (See page 25 for procedures for changing modes.)

The type of administrator/attendant console you have depends on the size of your system. In systems with 20 or fewer voice terminals and eight or fewer lines (small systems—switch H on the control unit set to *1-8 Lines*), the administrator/attendant console is a *34-button deluxe voice terminal*. Only a 34-button deluxe model is suitable for administering small systems because it has lights next to each programmable button. You use the lights to keep track of what is happening on the lines and voice terminals you are working with.

In systems with more than eight lines or more than 20 voice terminals (large systems—switch H on the control unit set to *> 8 Lines*), the administrator/attendant console consists of a *34-button deluxe voice terminal with an attached Attendant Intercom Selector*. Only this type of console is suitable for administering a large system because some aspects of administration require the use of the Attendant Intercom Selector. Lights on the Attendant Intercom Selector also help you keep track of the system's status. For example, whenever you are administering your system, the light beside *Message Status* must be *off*.

Small and large consoles with administration mode button labels are illustrated on pages 10 and 11.

Small Administrator/Attendant Console* in Administration Mode

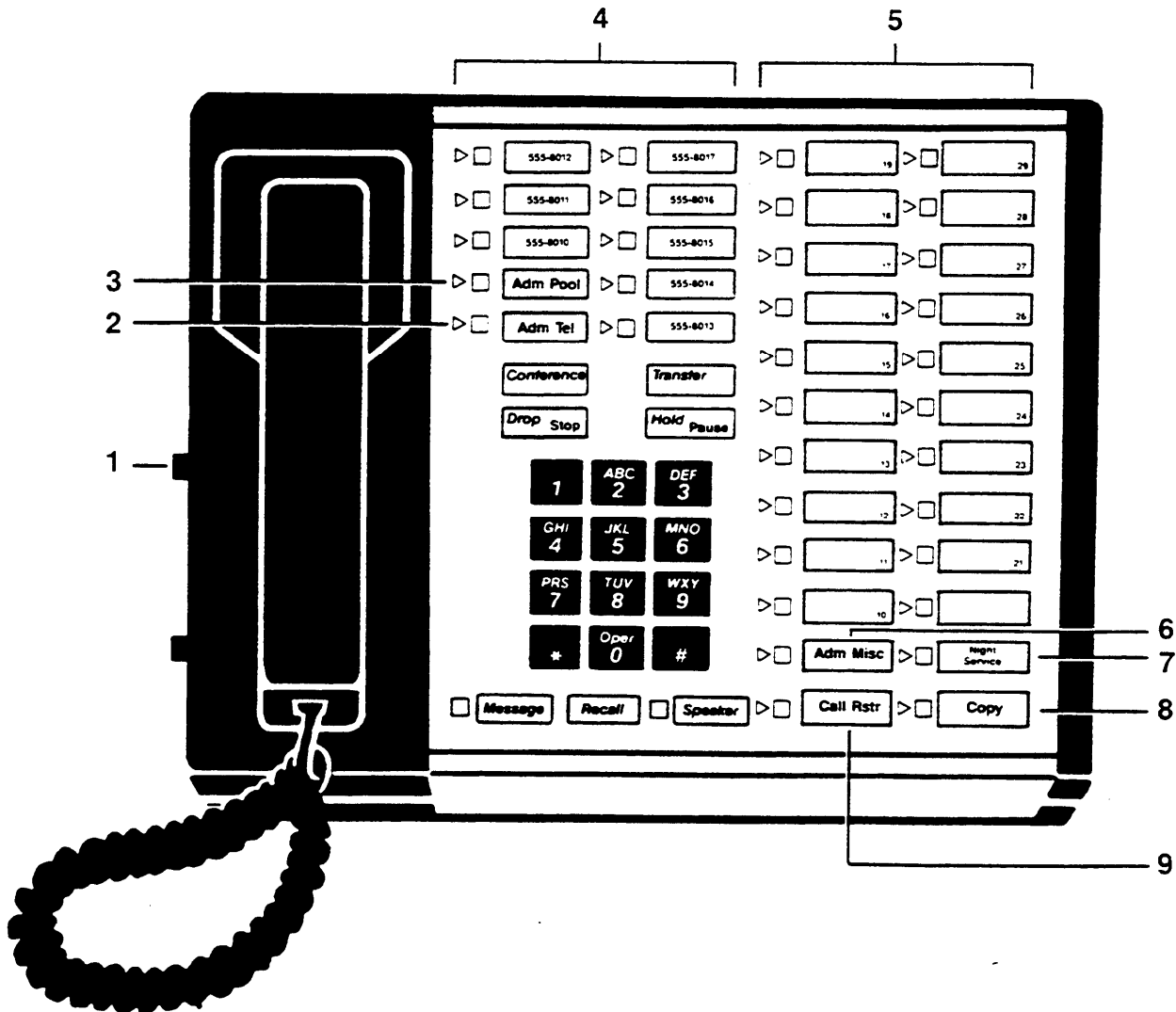

1. You set the *T/P* switch to *P* to perform system administration.
2. You use *Adm Tel* when assigning lines to voice terminals and assigning voice terminals Dial Access to Line Pools.
3. You use *Adm Pool* when setting up line pools.
4. Line buttons.
5. Auto Intercom buttons (10 through 29).
6. You use *Adm Misc* when specifying Touch-Tone or

- rotary dialing, assigning allowed-list call restrictions, and administering other system options.
7. You use *Night Service* when assigning lines to activate extra-alerting devices when the attendant is off duty.
8. You use *Copy* to give a voice terminal the same assignments as one that has already been set up.
9. You use *Call Rstr* when setting lines to detect a toll prefix or area code only and when assigning outward and toll call restrictions to voice terminals.

* For systems with 8 or fewer lines and with 20 or fewer voice terminals—switch H on control unit is up.

Large Administrator/Attendant Console* in Administration Mode

The large console provides the same features as the small console, but it has more line and Auto Intercom buttons.

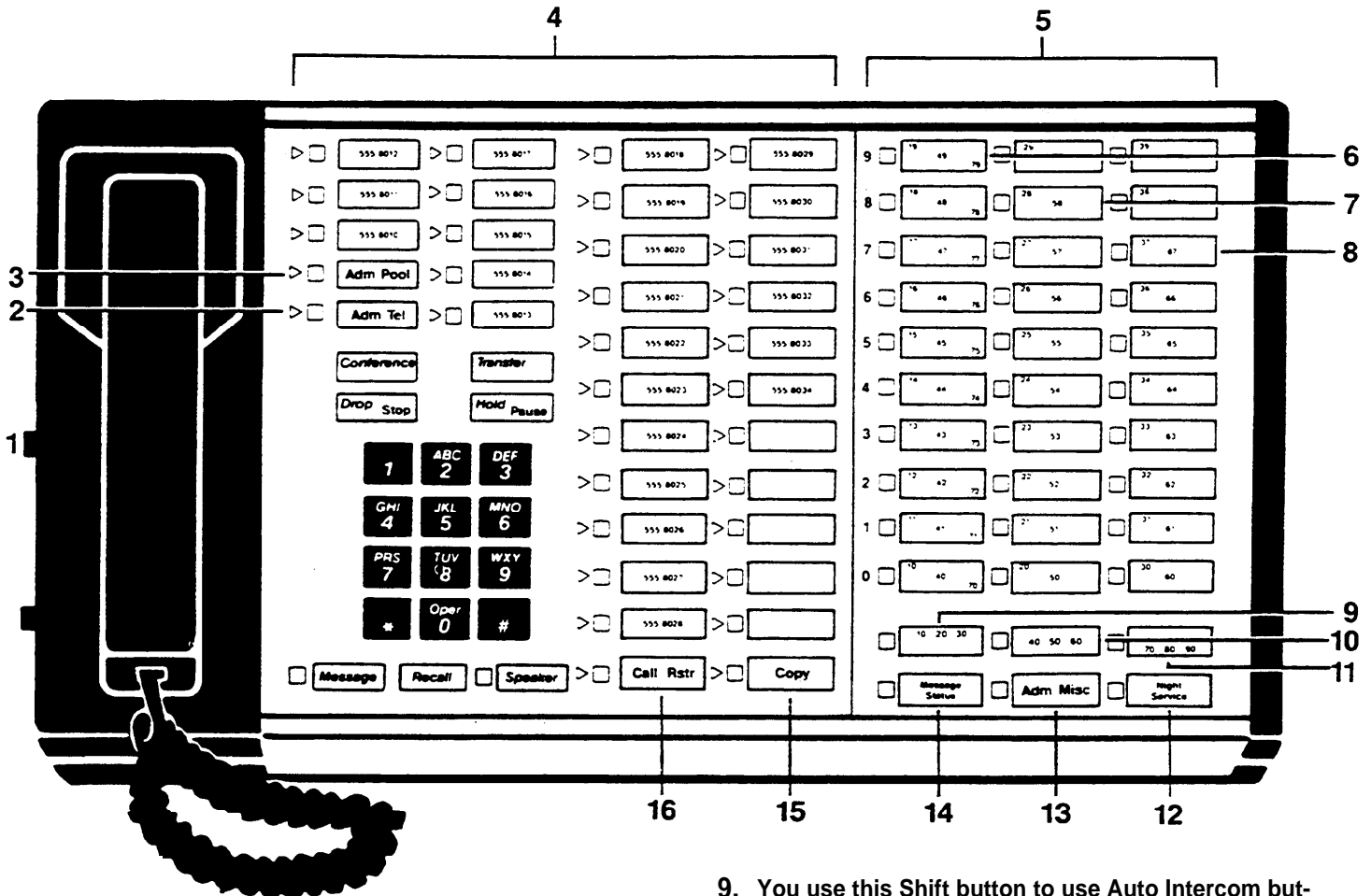

1. You set the T/P switch to *P* to perform system administration.
2. You use Adm Tel when assigning lines to voice terminals and assigning voice terminals Dial Access to Line Pools.
3. You use Adm Pool when setting up line pools.
4. Line buttons.
5. Auto Intercom buttons (10 through 79).
6. Buttons in this column represent intercom numbers 10-19,40-49, or 70-79, depending on which Shift button you touch.
7. Buttons in this column represent intercom numbers 20-29 or 50-59, depending on which Shift button you touch.
8. Buttons in this column represent intercom numbers 30-39 or 60-69, depending on which Shift button you touch.

9. You use this Shift button to use Auto Intercom buttons for intercom numbers 10-39.
10. You use this Shift button to use Auto Intercom buttons for intercom numbers 40-69.
11. You use this Shift button to use Auto Intercom buttons for intercom numbers 70-79.
12. You use Night Service when assigning lines to activate extra-alerting devices when the attendant is off duty.
13. You use Adm Misc when specifying Touch-Tone or rotary dialing, assigning allowed-list call restrictions, and administering other system options.
14. You don't use Message Status during system administration. The light beside Message Status must be off during administration.
15. You use Copy to give a voice terminal the same assignments as one that has already been set up.
16. You use Call Rstr when setting lines to detect atoll prefix or area code only and when assigning outward and toll call restrictions to voice terminals.

* For systems with more than 8 lines or more than 20 voice terminals—switch H on control unit is down.

Using the Console

When you administer your system, you frequently use the Auto Intercom buttons and Shift buttons (large systems only) on the administrator/attendant console. The paragraphs below describe how to use these buttons.

Auto Intercom Buttons

Each person's voice terminal has a unique 2-digit intercom number similar to an extension number. These intercom numbers (10 through 39 for a Model 1030 system, 10 through 79 for a Model 3070 system) are automatically assigned to Auto Intercom buttons on the console. During system administration, you use the lights next to each Auto Intercom button to determine the status of voice terminals in your system.

Shift Buttons (large systems only)

The large console has three Shift buttons that enable you to administer as many as 70 voice terminals by using only the 30 Auto Intercom buttons on the Attendant Intercom Selector. When you touch one of the Shift buttons, you change the intercom numbers assigned to the Auto Intercom buttons. Use the left Shift button labeled 10-20-30 to select intercom numbers 10 through 39 in the blue band, the center Shift button labeled 40-50-60 to select intercom numbers 40 through 69 in the white band, and the right Shift button labeled 70-80-90 to select intercom numbers 70 through 79 in the gray band. If you want to dial a particular intercom number, you must first touch the Shift button that provides access to the group of intercom numbers that includes the one you want. For example, if you want to assign lines to the voice terminal represented by intercom 31, touch the left Shift button. The light next to the Shift button comes on, and the Auto Intercom buttons now represent intercom numbers 10 through 39.

Message Status Button (large systems only)

The Message Status button is used only when your console is in the attendant mode. You use this button to find out which voice terminals have messages waiting for them.

OPTIONAL EQUIPMENT

You may also have optional equipment that adds features and capabilities to your system.

- **Attendant Intercom Selector. Provides an attendant with 70 Auto intercom buttons.**
- **Basic Telephone and Modern Interface. Connects telephones and data communication devices such as autodialers, answering machines, cordless telephones, facsimile machines, and auto-answer or originating modems to your MERLIN system. You can also use a transformer to connect a timer to a Basic Telephone and Modem interface.**
- **Basic Telephone Module. Lets you connect basic Touch-Tone and rotary telephones to the MERLIN system.**
- **Hands-Free Unit. Provides you with full speakerphone capability including hands-free telephone conversation, On-Hook Dialing, Monitor-on-Hold, and teleconferencing.**
- **Headset and Headset Adapter. Enables an attendant to answer and listen to calls without lifting the handset.**
- **General Purpose Adapter (only for use with 10-button and 34-button voice terminals). Enables you to connect accessories, such as data terminals, cordless telephones, and autodialers, to a MERLIN system voice terminal.**
- **Off-Premises Telephone Interface. Connects off-premises telephones to your MERLIN system.**

Preparing to Administer Your System

Before you start to administer your system, review this section to make sure you have the information and completed forms that you need.

Preparation Procedures

- Decide how people will access outside lines.
- Complete your System and Voice Terminal Configuration Forms.
- Schedule a time to perform administration procedures.

THE SQUARE VS. POOLED DECISION

For systems that have just been installed, you have to make a decision about a basic system characteristic-how people access outside lines with their voice terminals. You have the option of setting your system to be either square or pooled. In a square system, each outside line can appear on a separate button at each voice terminal. In a pooled system, outside lines are grouped together so that one button provides access to several outside lines. *On attendant consoles, however each outside line appears on a separate button, whether your system is pooled or square, and you cannot change this arrangement.*

Whether your system should be square or pooled depends on your specific business needs. *If you want to use the Automatic Route Selection feature, your lines must be pooled and your system must be set for Dial Access to Line Pools (Dial Access is discussed on page 79).* The characteristics of both configurations are discussed in greater detail in the paragraphs that follow.

About Square Systems

In the MERLIN communications system, Models 1030 and 3070 with Feature Module 4, a square configuration is one in which outside lines are represented by separate buttons on every voice terminal in the system. A square configuration simplifies call-handling because people can join in on calls or pickup calls on hold just by touching the appropriate line button at almost any voice terminal.

You can choose between two kinds of square configurations: standard or customized. In the standard configuration, you give all voice terminals in the system access to the same lines. In the customized arrangement, on the other hand, you assign specific lines or sets of lines to selected groups of voice terminals. You can also assign personal lines to individual voice terminals in a customized square configuration.

Standard Square Configurations

The standard square configuration is ideal for offices in which all staff members use the same lines to make and receive calls. In this arrangement, every line in the system appears at each voice terminal that has enough buttons to accommodate that number of lines. Depending upon the size of your system, you can assign up to 30 lines to as many as 70 voice terminals.

You will assign each of your lines to the same buttons at each voice terminal. To get the most from a standard square configuration, all your voice terminals should have enough buttons to handle all the lines in your system. If you have smaller capacity voice terminals, see "Special Information about 5-Button Voice Terminals," page 87.

An example of a standard square configuration appears on the following page. All six lines in the system are available for general use and appear on the same buttons at each voice terminal, as shown.

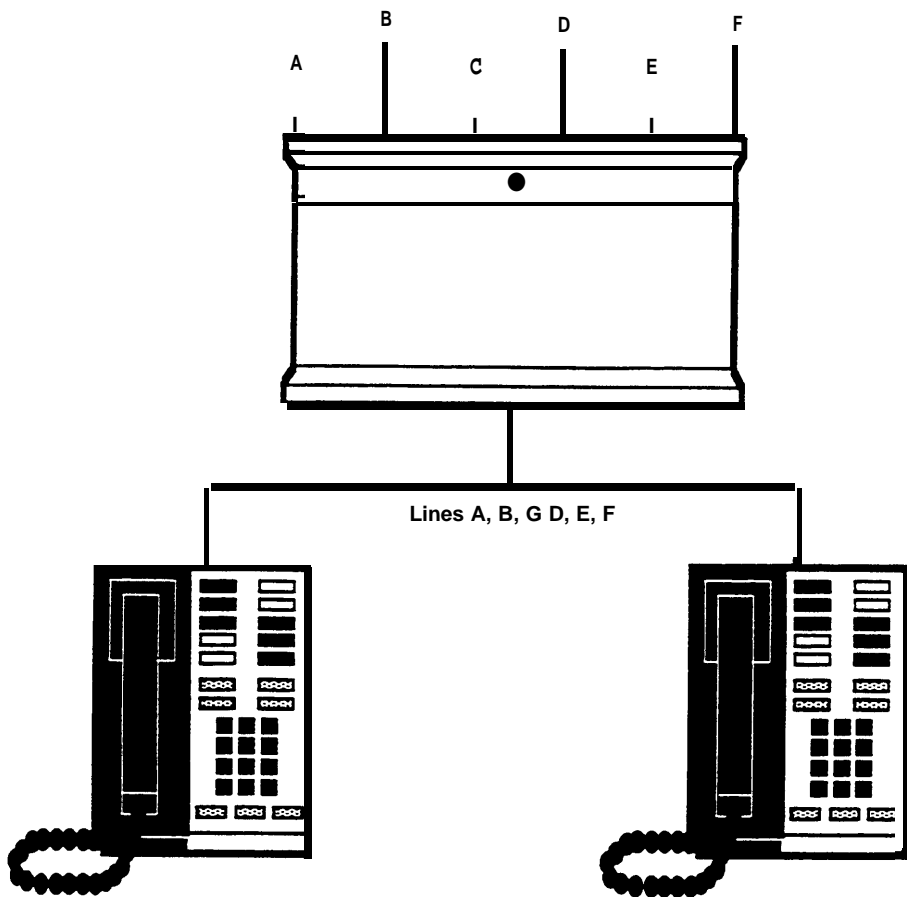

Lines are assigned to the same buttons at each voice terminal.

EXAMPLE OF STANDARD SQUARE CONFIGURATION

Pages 27 through 30 explain how to assign lines to buttons on voice terminals in a standard square configuration.

Customized Square Configurations

In a customized square configuration, you assign individual lines or groups of lines to selected voice terminals with similar requirements for placing and receiving calls. This arrangement lets you tailor your communications system to meet the needs of different departments. It also simplifies recordkeeping on calling patterns within your business.

The departments at a car dealership, for example, may have different calling needs. Say that Ultimate Motors has eight local lines, three WATS lines, and one Foreign Exchange (FX) line. The sales and office staff use the out-of-state WATS line frequently to speak with manufacturers' representatives, haulers, and other dealerships. This group uses one of the in-state WATS lines to contact customers, vendors, and the Division of Motor Vehicle Registration in the state capital. The third WATS line is an incoming in-state WATS line used by customers who live outside the immediate area. The service staff doesn't usually have to make long distance calls. However, one major equipment supplier is located 25 miles away, and calls to this supplier would normally be toll calls. To reduce this expense, Ultimate has a Foreign Exchange line for the supplier's exchange code, 560. When the service staff uses this line, calls to the supplier are treated as the equivalent of local calls. Because the manager handles many confidential negotiations over the telephone, he requires a personal line.

A customized square configuration is the most appropriate system arrangement for Ultimate Motors' varied communication requirements. The administrator assigns the three WATS lines and three of the eight local lines to the sales and clerical staff. The service department voice terminals get three different local lines and the Foreign Exchange line. The seventh local line is assigned to the voice terminal at the parts desk, and the eighth is assigned as a personal line at the manager's voice terminal. The figure below illustrates this type of configuration.

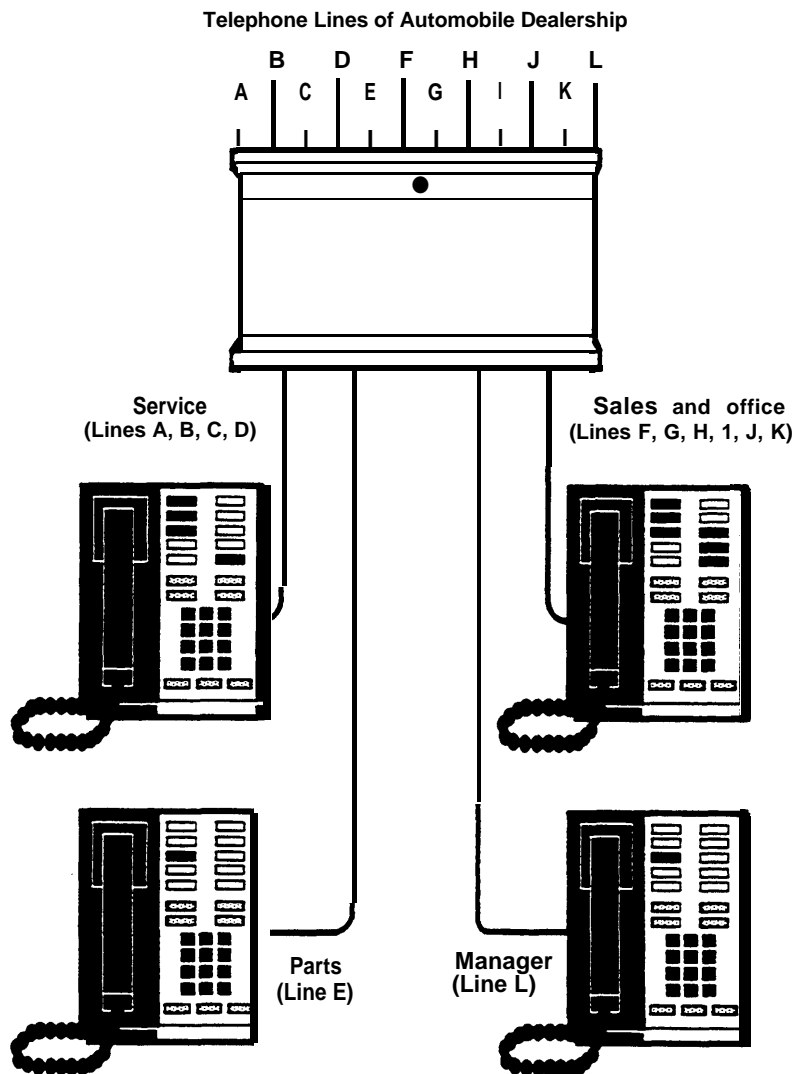

EXAMPLE OF CUSTOMIZED SQUARE CONFIGURATION

As the figure shows, this type of system provides complete flexibility in line assignment. You can assign lines to any available buttons on a voice terminal, in any order you wish. A person in a customized square system does not have to have a line assigned to his or her voice terminal in order to answer a ringing, parked, or held call on that line. Say that a customer calls on the in-state WATS line to ask if Ultimate has a particular gasket in stock. The salesperson who receives the call notifies the parts desk of the call. The parts clerk can use the Line Pickup feature described on page 71 to answer the call. If a voice terminal in the service area is ringing and nobody is free at the moment to answer it, someone in the adjacent office area can use the Call Pickup feature described on page 76 to answer the call.

Pages 27 through 30 explain how to assign lines to buttons on voice terminals in a customized square configuration.

About Pooled Systems

In a pooled configuration, you group several outside lines together into a pool that people can access with a single button on their voice terminals. When they place a call, they either touch the button assigned to a particular line pool (Button Access to Line Pools) or touch a Pool Access button and dial the code of the pool best suited for this type of call (Dial Access to Line Pools). The system then selects a free line from that pool, and the user dials the number he or she is trying to reach. If your system has Automatic Route Selection, users simply touch a Pool Access button and dial the number. The system routes the call automatically to the most appropriate pool available for that type of call, following the order of preference setup by you, the administrator.

Your system can have as many as 11 different line pools. Each type of special-purpose line that your business has, such as WATS or Foreign Exchange (FX) lines, should be assigned to a separate pool. You should not mix types of lines in a pool, because you cannot control which line people get when they access the pool. If your business has local lines, in-state WATS lines, and Band 1 out-of-state WATS lines, for example, you must set up at least three line pools.

When assigning lines in a pooled system, you can assign all, some, or none of your lines to a single pool (see diagram below), but you cannot assign any line to more than one pool. By the same token, you do not need to assign all your lines to pools; you can also assign individual lines that are not included in any pool to any voice terminal in your system. A diagram of a pooled system with eight lines appears on the following page.

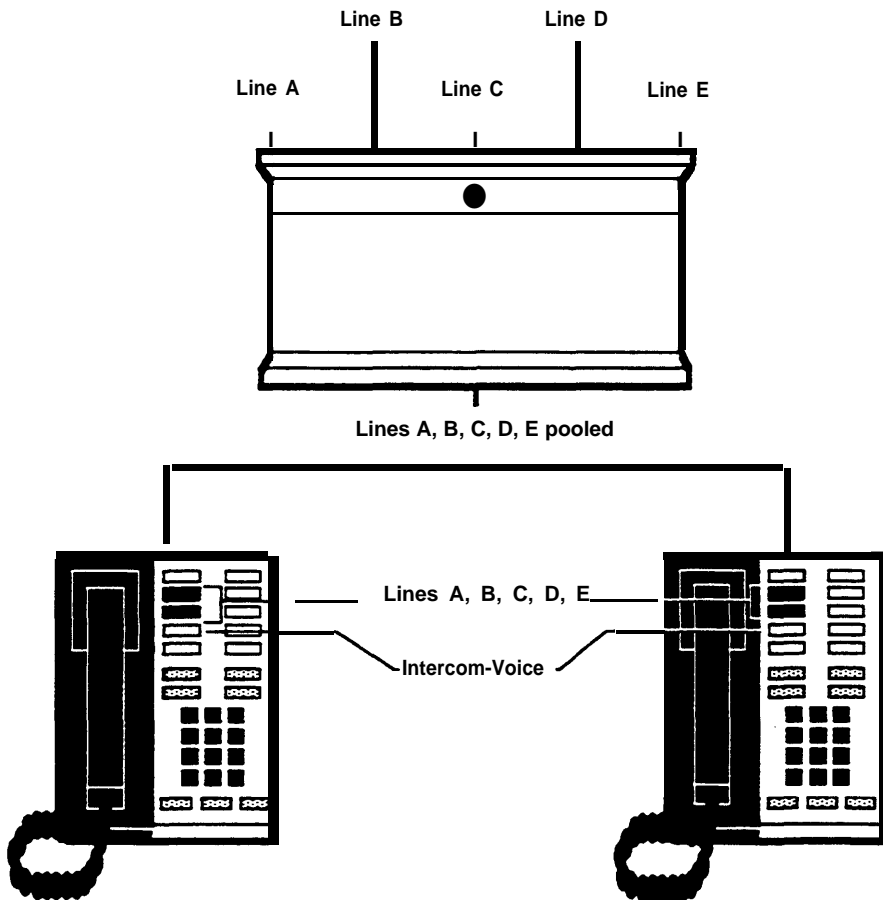

SIMPLE POOLED SYSTEM

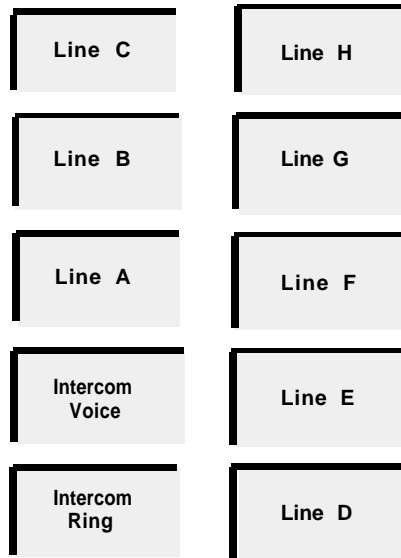
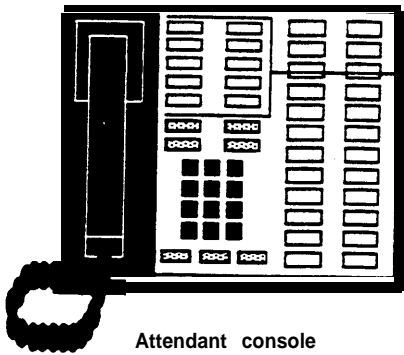

Main pool = Lines A, B, C
 Line pool 2 = Lines E, F
 Line pool 3 = Lines G, H
 Line not assigned to pool = Line D

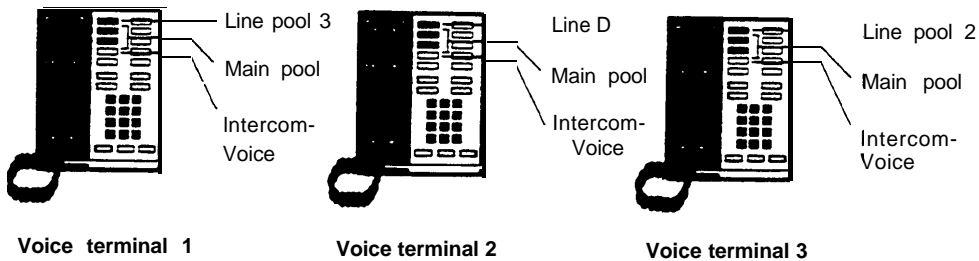

POOLED SYSTEM WITH 8 LINES

Line use is very efficient in a pooled system, so you may need fewer outside lines than you would with a square system. Furthermore, more programmable buttons on voice terminals are available for assignment as special-purpose line buttons or feature buttons.

Button Access vs. Dial Access to Line Pools

You can choose one of two access options for line pools: **Button Access to Line Pools** or **Dial Access to Line Pools**. Because you set a switch for this option on your control unit, the method you select will be used at all the voice terminals in your system.

If you have only one or two line pools, **Button Access** is the best option for your system. If your system has several line pools, however, **Dial Access** is preferable because it provides access to all pools using only two buttons on each voice terminal. If you want to use **Automatic Route Selection**, you *must* select **Dial Access**. **Dial Access** is also necessary if you want basic telephones to have access to line pools or special lines or if you want 5-button voice terminals to have access to more than one special pool.

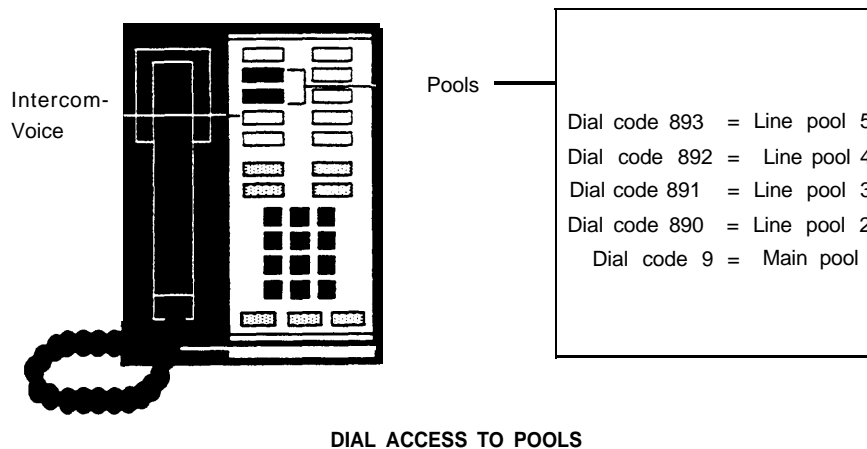

Assume that you have five line pools. With the **Dial Access** option (see the diagram above), you arrange the system so that people can access any line pool by lifting the handset, touching one of the two buttons above **Intercom-Voice**, and dialing the access code assigned to the pool (9 for the main pool or 890 through 899 for the others). Even if you set your system for **Dial Access**, you can still assign some pools to particular buttons, if you like.

With the **Button Access** option (see the diagram below), people access all line pools directly through pool buttons on each voice terminal. In such an arrangement, the first two buttons above **Intercom-Voice** provide access to the main pool. You may assign additional buttons for access to other pools that may include **WATS** lines, **FX** lines, or lines used for special purposes.

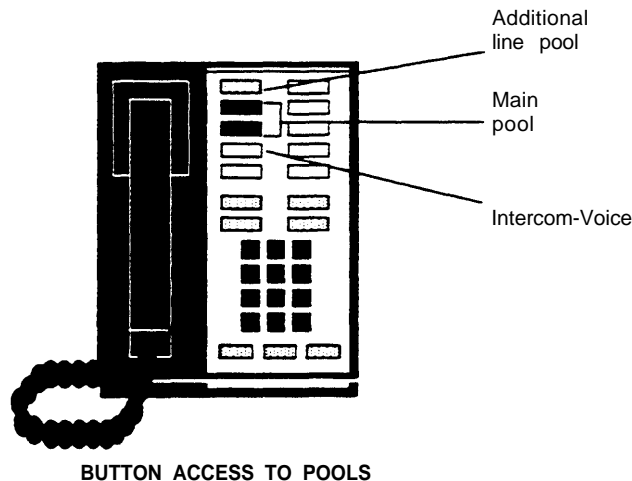

THE FORMS AND LABELS YOU NEED

Before you begin performing administration procedures, be sure to complete all the necessary forms:

- A System Configuration Form to keep a record of how the lines in your system are arranged.
- Voice Terminal Configuration Forms to record the lines and features assigned to all voice terminals. Fill out one of these for each voice terminal.

When you ordered your system, you should have filled out these forms when you completed the *MERLIN Communications System Planning Guide: Models 7030 and 3070*. If you did not, turn to the Appendix, copy the forms included there, and fill them out before you proceed further. These forms serve as important references throughout later system administration procedures.

During system administration the buttons on the administrator/attendant console perform completely different functions than they do when the console is being used to handle calls. Therefore, you need a different set of button labels whenever you use the console for system administration. There are two sets of administration mode button labels in the back of this manual: one set for a small administrator/attendant console (systems with switch H on the control unit set to *1-8 Lines*) and another set for a large administrator/attendant console (systems with switch H set to *8 Lines*). Fill in the appropriate set for your system, and keep the labels and completed forms to use whenever you administer your system.

CHOOSING A TIME TO ADMINISTER YOUR SYSTEM

Before you begin administration procedures, choose a time when you do not expect many people to be using their voice terminals. When you perform some administration procedures, the system blocks all calls on the lines or voice terminals with which you are working. Blocked voice terminals generate soft, periodic beeps to alert people that they cannot be used. If you accidentally try to administer a voice terminal that has an active call, you do not cut off the caller. Rather, you are unable to continue administering that voice terminal until it is idle.

Basic Administration

Once your system planning and paperwork are complete, you can perform basic administration procedures. The chart below lists the procedures described in this section. Remember that if you are administering a new system that has just been installed, some of these basic procedures maybe *required* to set the proper operating conditions for your particular environment, and you must perform them first before you go on to do any other system administration. Carry out the procedures in the order listed in the chart, but keep in mind that you may not need to perform all of them to customize your system to your particular environment. Read each procedure first to see if it applies to you.

IMPORTANT: Administer your system at a time when you do not expect many people to be using their voice terminals.

Basic Administration Procedures

- **Set your control unit.**
- **Learn how to enter and leave administration mode.**
- **Specify Touch-Tone or rotary dialing.**
- **If you have a square system, assign lines to buttons on voice terminals.**
- **If you have a pooled system, set up line pools, assign individual lines and line pools to voice terminals, and establish Button Access to Line Pools or Dial Access to Line Pools.**

SETTING YOUR CONTROL UNIT

The first step in customizing the MERLIN system is to set the control unit to the operating conditions you select.

IMPORTANT If your control unit has been set previously and you just want to change the setting of a particular switch, be sure to read "Changing Your System Later," page 24, before resetting the switch.

Follow these steps to set your control unit:

1. Turn off the control unit by setting the On/Off switch on the Power Module to *Off*.
2. Set switch A which is located in slot 2 (color-coded purple) on the Processor Module, to *Administer* (down).

Switch A controls intercom number 10, which is always the main attendant position. Set switch A to the *Administer* position whenever you need to administer your system from the administrator/attendant console. When you finish administering, set switch A to *Attendant* (up).

NOTE: Switch A, which sets the mode of the administrator/attendant console, is the only switch on the control unit that you can reset with the power on. If you reset any other switch with the power on, *the control unit does not record any of the changes you make until you turn the power off, then on again.*

3. Set switches B through E.

Switches B through E control intercom numbers 11 through 14, respectively. These consoles normally function as voice terminals, but you can designate any of them as backup attendant consoles. If you designate a voice terminal to function as an attendant console, each outside line appears on a separate button, regardless of whether you select the pooled or square option.

The four voice terminals selected by switches B through E plus the administrator/attendant console (intercom number 10) provide a maximum of five attendant consoles if you need them.

- For those voice terminals that function as attendant consoles, set the switch to *Attendant* (down).
- For those voice terminals that function as regular telephones, set the switch to *Normal* (up).

4. Set switch F.

- If you have chosen to pool your lines, set switch F to *Pooled* (up) and go to step 5.

IMPORTANT If you are resetting this switch from *Square* to *Pooled*, be aware that *you erase all system line administration and voice terminal programming that is now in place.*

- If you want every outside line to appear on a separate button, set switch F to *Square* (down). The eight lines plugged into jacks A0 through B2 appear automatically on all non-attendant voice terminals. Go to step 6.

5. Set switch G.

NOTE: The instructions that follow apply if switch F is set to *Pooled*. If switch F is set to *Square*, switch G may be set to either position without having any effect on the system.

- If you have decided to arrange your pooled system so that people can access line pools directly by simply touching the associated button on a voice terminal, set switch G to *Button Access* (down).
- If you have decided to arrange your pooled system so that people can access any line pool by dialing the pool's access code, set switch G to *Dial Access* (up). You *must* set switch G for *Dial Access* if you want to use *Automatic Route Selection*. Even if you set your system for *Dial Access to Pools*, you can still program buttons at individual voice terminals to provide one-touch access to particular line pools.

6. Set switch H.

- If you have eight or fewer outside lines *and* 20 or fewer voice terminals, set switch H to *1-8 Lines* (up).

NOTE: The switch setting you select does not always have to correspond to the number of outside lines you actually have. For example, if you have eight or fewer lines but plan to grow beyond eight lines within a year or two, you might prefer to set switch H to *>8 Lines* (down) in order to simplify administering the system later. If you change the setting of this switch later, you *cancel any special line administration of programmed features on your attendant consoles*.

- If you have more than eight outside lines or more than 20 voice terminals, or if you expect your system to grow to this size in the next year or so, set switch H to *>8 Lines* (down).

7. If your system has an SMDR (Station Message Detail Recording) Module and a printer with an RS-232 connector, connect the printer to the SMDR Module (refer to the instructions that come with the module).

8. Turn on the control unit by setting the On/Off switch on the Power Module to *On* (right). This causes the system to record the changes you just made. The warning light on the module will go on. Wait for the light to go off before continuing. If you have a printer hooked up, a page header will be printed.

9. If your system has a Services Module, make the following adjustments. Otherwise, go to step 10.

- If you have background music through a loudspeaker paging system, you can adjust its volume by turning the Bkgd Vol control clockwise to raise the volume, or counterclockwise to lower it. If you do not have background music through a loudspeaker paging system, turn the control counterclockwise as far as it goes.
- If you have Music-on-Hold, you can adjust its volume by turning the MOH Vol control clockwise to raise the volume, or counterclockwise to lower it. If you do not have Music-on-Hold, turn the control counterclockwise as far as it goes.
- If you have a music source with its own amplifier, set the Level switch to *Hi* (down); otherwise, set the switch to *Lo* (up).
- If you have a loudspeaker paging system and want a short tone to precede loudspeaker announcements, set the Page Sgnl switch to *On* (up). Otherwise, set the switch to *Off* (down).

10. If you are setting up a new system for the first time, enter administration mode, as described on page 25, and continue following the procedures in this section.

CHANGING YOUR SYSTEM LATER

Basic changes to the way your system operates—that is, changes to the switch settings on the control unit—may erase important system administration that is now in place. To change switch settings, turn to "Setting Your Control Unit," page 22, and follow the instructions for the switch you want to reset. Since you won't be performing the entire procedure, be especially careful not to skip any steps that are required. Follow the general instructions below to prevent this from happening.

General instructions for resetting control unit switches:

1. Set the On/Off switch on the Power Module to *Off*.
2. Set switch A to *Administer* (down).
3. Follow the instructions for the switch you intend to reset.
4. Turn the On/Off switch on the Power Module to *On*.
5. Perform any required readministration or reprogramming discussed below in "Notes on Resetting Control Unit Switches."
6. Set switch A back to *Attendant* (up).

Notes on Resetting Control Unit Switches

Whenever you change the setting of a switch on the control unit, you will probably have to make other changes in your system. Keep the following in mind:

- If you add or remove attendant consoles (switches B through E), you have to reassign special lines and features to the voice terminals whose function you have just changed.
- If you change the setting of the Pooled/Square switch (switch F), you erase all system line administration and voice terminal programming that was formerly in place. You have to completely readminister all your lines; set up pools and Dial Access to Line Pools, if these apply; and reprogram all your voice terminals.
- If you change the setting of the Dial Access/Button Access switch (switch G), you must reprogram individual voice terminals accordingly. The system will automatically assign a different function to the two buttons above Intercom-Voice. You must assign line pools to particular buttons (Button Access) or give the voice terminal access to specified line pools (Dial Access). You must also assign individual lines to buttons.
- If you change the setting of the 1-8 lines/>8 lines switch (switch H), you cancel any special line administration or programmed features on your attendant consoles. The setting of this switch determines how the system automatically assigns lines and intercom numbers to the buttons on attendant consoles. It also determines the function of certain buttons on the attendant/administrator console when the console is in administration mode. (See "Initial Feature Assignments for Attendant Consoles," pages 85 and 86.) Note that the switch setting you select does not always have to correspond to the number of outside lines you actually have. For example, if you have eight or fewer lines but plan to grow beyond eight lines within a year or two, you might be wise to set switch H to *>8 Lines* in order to simplify administering the system later.

ENTERING AND LEAVING ADMINISTRATION MODE

Administration mode is an operating state of your control unit and of your administrator/attendant console that is very different from their everyday state of operation. With the system in administration mode, you are able to set up or change systemwide options or features. When you finish using the administrator/attendant console to administer your system, you must leave administration mode to resume normal attendant operations.

You must enter administration mode to set up a new system and again each time you use the attendant console to administer your system. The boxed instructions below tell you how to enter administration mode.

Entering Administration Mode

1. **Switch A is located on the Processor Module (slot 2, color-coded purple) of the control unit. Set Switch A to *Administer* (down).**
2. **Insert the administration mode button labels provided at the back of this manual in the administrator/attendant console. Different sets are provided for large and small systems.**
3. **If the light next to Message Status is on, touch it once to turn it off before beginning to administer your system (large systems only).**
4. **Slide the T/P switch on the left side of the console to *P*.**

On small consoles, red and green lights start flashing next to the administration mode buttons labeled Adm Pool, Adm Tel, Adm Mist, Call Rstr, and Night Service. On large consoles, red and green lights start flashing next to the buttons labeled Adm Pool, Adm Tel, and Call Rstr. Green lights flash next to the buttons labeled Adm Mist and Night Service.

When you finish administration procedures at the console, you must leave administration mode to resume normal operation. Do this when you complete your initial system administration and whenever you complete any system changes in the future. The boxed instructions below tell you how to leave administration mode.

Leaving Administration Mode

1. **Slide the T/P switch to the center position.**
2. **Set switch A on the Processor Module of the control unit to *Attendant* (up).**
3. **Remove the administration mode button labels from the console and insert the regular call-handling labels used by the attendant.**

SPECIFYING TOUCH-TONE OR ROTARY DIALING

When your system is installed, it is set to generate Touch-Tone signals. If some of your lines are rotary, you need to reset your system accordingly. If you have rotary lines or if you are not sure what type of lines you have, follow the procedure below. If all your lines are Touch-Tone, turn to the next page to continue administering your system.

To determine if your lines are Touch-Tone or rotary, go to the administrator/attendant console and make sure that the T/P switch is in the center position. Then touch each line button and dial out. If a line is Touch-Tone, you hear tones and the dial tone stops. If a line is rotary, you hear tones but the dial tone is not interrupted. Follow the procedure below to specify Touch-Tone or rotary dialing.

1. If you have not already done so, enter administration mode by following the boxed instructions on page 25.

2. Touch Adm Misc.

The lights next to the administration mode buttons stop flashing, and the green light next to Adm Misc remains on.

3. Dial the 4-character code #302.

4. One by one, touch the line button for each line in your system until the green light beside it shows the appropriate code. Each successive touch of a button gives you one of the following codes:

*Steady green on = Touch-Tone dialing
Green off = rotary signaling*

5. Touch Adm Misc again.

The lights next to the administration mode buttons flash.

6. Continue to administer your system or leave administration mode by following the boxed instructions on page 25.

SETTING UP SQUARE SYSTEMS

In square systems, individual lines appear on separate buttons at voice terminals. If you want a standard square system, you will give all your voice terminals access to the same outside lines and assign the lines to the same buttons at every voice terminal. If you prefer a customized square system, you can assign different lines or groups of lines to selected voice terminals, in whatever order you want. If someone routinely carries on private telephone conversations, you may want to assign a personal line to his or her voice terminal as part of your customized square setup. A personal line will not ring at the attendant's console and cannot be picked up at any other voice terminal in your system.

The information that follows describes how to assign lines to buttons in square systems. (See page 14, "The Square vs. Pooled Decision," for more information on square systems.)

Before you assign lines to buttons, please read the following information:

- Even though you may not be using the full capacity of a Line Module in the control unit, all five of the lines that would be represented by that module are automatically assigned to buttons on the administrator/attendant console. A port with no line cord plugged into it is called a nonequipped line appearance or "ghost line." Remove any ghost lines from your administrator/attendant console so that these buttons can be used for custom features. If you have a small console and are not using the full capacity of a Line Module in the control unit, you should also remove ghost lines from your voice terminals.
- The Initial Feature Assignments diagrams on pages 85 and 86 illustrate the order in which lines are assigned to buttons on the administrator/attendant console when your system is first set up. The system automatically assigns lines to the buttons in the order in which the lines are plugged into the control unit. This is the "default" arrangement, what your system does unless you specify something different. You can follow the procedure below to assign lines to buttons in a different order.
- When you assign a line to a voice terminal, the system automatically assigns the line to the first button that doesn't already have a line assigned to it, in the order shown in the diagram on the next page. You can assign lines to voice terminals in a different pattern by touching the line buttons in the order in which you want them to appear.
- Note that none of the voice terminals in your system come with preprinted button labels. Be sure to label the voice terminal buttons with the telephone numbers of the lines you assign.
- Always assign lines to one voice terminal at a time.
Make sure you have a completed Voice Terminal Configuration Form for each voice terminal.
- Remember that voice terminals cannot be administered and used at the same time. You cannot assign lines to a voice terminal unless it is idle, and the user cannot place or receive calls while you are assigning lines. While you are administering a voice terminal, it beeps softly as a reminder that it cannot be used.

Preparing to Assign Lines to Voice Terminals

If you want to have a standard square system and have eight or fewer lines, your system has already been set up for you. The system automatically assigns the lines plugged into control unit jacks AO through B2 to the eight line buttons above the dial pad on each voice terminal. If you have more than eight lines, however, you must follow the procedure below to assign the rest of your lines to each voice terminal in your system. The lines will be assigned to buttons in the order in which you touch them.

If you are setting up a customized square system for the first time, you should begin by removing all existing lines from each voice terminal in your system. If the primary attendant needs to have access to all general-use lines, remove only those lines that you are reserving for personal use from the administrator/attendant console. Follow the procedure below to assign lines to buttons on the voice terminals in your system. Remember that the lines will be assigned to buttons in the order in which you touch them.

Assigning Lines to Buttons

To assign individual lines to buttons in a standard or customized square system, follow the procedure below.

1. If you have not already done so, enter administration mode by following the boxed instructions on page 25.

2. Touch Adm Tel.

The lights next to the administration mode buttons stop flashing, and the green light next to Adm Tel remains on.

3. Dial the intercom number (14, for example) or touch the Auto Intercom button for the voice terminal to which you want to assign lines.

If the voice terminals idle, a steady green light comes on next to its Auto Intercom button, and the system gives a 2-beep signal for you to begin.

If the voice terminal is being used, the green lights next to the Auto Intercom button and Adm Tel flash rapidly. You must wait until the green lights become steady or try again later. If you try to assign a line to a busy voice terminal, you will hear a beep and will not be able to proceed.

4. Refer to the Voice Terminal Configuration Form to see which lines to assign to this voice terminal. (If you plan a standard square configuration, you will be assigning all your lines to every voice terminal.) Steady green lights come on next to any lines already assigned to the voice terminal.

5. Touch the appropriate line buttons to add or remove lines from this voice terminal. The green light next to each line button tells you the current status of the line. Each successive touch of a line button gives you one of the following codes:

Green light on = line is assigned to this voice terminal

Green light off = line is not assigned to this voice terminal

The order in which you touch the line buttons determines the order in which lines appear on the voice terminal. For example, assume that eight lines (lines AO through B2) are already assigned to the voice terminal you are administering, and you want to add eight more. If you touch the line buttons in the order in which they appear on the administrator/attendant console (B3, B4, CO, etc.), they will appear in the same order on the voice terminal. However, if you touch the button for line C4 first, that line will appear on the first available button on the voice terminal. If you touch the button for line CO next, line CO will appear on the button below the line C4 button, and so on. Be sure that the correct telephone number for each line appears on the associated button on the voice terminal.

6. Repeat steps 3 through 5 for each voice terminal to which you want to assign lines.

NOTE: If you are setting up a customized square system, try to administer groups of voice terminals that share the same line assignments at the same time. If you plan to assign a personal line to a voice terminal, be sure not to assign the line to any voice terminals that should not have access to that line.

You can use the shortcut below to give another voice terminal the same line assignments as one you have already set up. This procedure is especially timesaving if you have a standard square system, since all your voice terminals will have the same line assignments.

NOTE When you copy line assignments, you also copy restrictions and allowed-list permissions.

- Dial the intercom number or touch the Auto intercom button of the new voice terminal.
- Touch Copy.
- Dial the intercom number or touch the Auto intercom button of the original voice terminal.

7. Touch Adm Tel.

The lights next to the administration mode buttons flash again.

8. Continue to administer your system or leave administration mode by following the boxed instructions on page 25.

SETTING UP POOLED SYSTEMS

In pooled systems, you group similar types of outside lines into a pool that people can access with a single button on their voice terminals. For example, you might group five local lines into one pool, three in-state WATS lines into a second pool, and two cross-country WATS lines into a third pool. This would free up several buttons on voice terminals that would otherwise be required for individual lines. If you decide to set up a pooled system, you will probably want to pool all your lines except single, special-purpose lines and those that are needed as personal lines.

To setup a pooled system, you begin by assigning lines to pools. Next, you assign individual lines to buttons on voice terminals. If your system has Button Access to Line Pools, you also assign selected pools to particular buttons. If your system has Dial Access to Line Pools, you give each voice terminal access to the pools the user needs.

The following sections describe how to setup a pooled system. (See "The Square vs. Pooled Decision," page 14, for more information about pooled systems.)

Preparing to Set Up Line Pools

If you plan to pool the lines in your system, you must first assign individual lines to the appropriate pools. Before you set up your line pools, please read the information below.

- Even though you may not be using the full capacity of a Line Module in the control unit, the lines that would be represented by that module are automatically assigned to buttons on the administrator/attendant console. A port with no line cord plugged into it is called a nonequipped line appearance or "ghost line." Remove any ghost lines from the buttons to which the system assigned them so that these buttons can be used for custom features. If you have eight or fewer lines, you may also have to remove ghost lines from your voice terminals.
- You cannot set up line pools unless all the voice terminals in your system are idle. Once you touch **Adm Pool** and see the steady green light that indicates you are free to administer your system, the system cannot receive incoming calls. Any callers will get a busy signal.
- Whenever you set switch F on the control unit to Pooled, the system automatically assigns all your lines to the main pool. Local lines should remain in the main pool, but all other lines can be removed. You can assign lines that you do not want in the main pool to other pools or use them as individual lines.
- Do not mix different types of lines. For example, do not put regular telephone lines and WATS lines in the same pool. Even within a WATS line pool, you cannot mix different bands of WATS lines or include both inbound and outbound lines. All lines in a pool must be interchangeable, since you cannot control which lines people will get when they use the pool.
- The number of lines available for pooling is affected by the number of lines you must reserve for personal or special-purpose use. For example, if you have ten outside lines and two people need personal lines, there are eight lines left for pooling. If a line is assigned to a pool, it cannot be assigned to a second pool or as an individual line.
- You can have up to 11 pools, with as many lines as you like in each pool. If you have Dial Access to Line Pools, people can access a particular pool by dialing the code assigned to the pool (9 for the main pool, 890 through 899 for additional pools).

Assigning Lines to Line Pools

Follow the procedure below to set up line pools.

1. If you have not already done so, enter administration mode by following the boxed instructions on page 25.

2. Touch Adm Pool.

If your lines aren't in use, the lights next to the administration mode buttons stop flashing, the green light next to Adm Pool remains on, and the console gives a 2-beep signal for you to begin.

If this happens, go to step 4. If not, go to step 3.

3. If the green light next to Adm Pool flashes instead of remaining on and you don't hear a 2-beep signal, your lines are in use. *You cannot set up line pools unless all the voice terminals in your system are idle* To find out which voice terminals are busy, set the T/P switch to the center position.

Steady green lights show next to the Auto Intercom buttons for terminals that are in use.

If you want to proceed with setting up line pools, return the T/P switch to P touch Adm Pool again, and wait. As soon as the system is idle, the console gives the 2-beep signal for you to begin. Go on to step 4.

NOTE: If someone is on a data call, his or her voice terminal will not show a busy signal. However, you will not be able to proceed with setting up line pools until that voice terminal is idle.

4. When you enter administration mode and touch Adm Pool, the system puts you in the main pool, the one that must contain your local lines. The main pool is Pool 9. Refer to your System Configuration Form to review the numbers that you assigned to the rest of your line pools. You must dial these access codes (890 through 899) in order to administer each of your line pools.

NOTE: If a line appears as an individual line at a voice terminal in your system, it will disappear from that terminal if you add it to a line pool. Before adding lines to pools, make sure they are not needed as individual lines.

If you want to administer the main pool, go on to step 5. If you want to administer one of your other pools, dial the access code for that pool, then go on to step 5.

5. Steady red lights appear beside each line that is assigned to this pool. Refer to your completed System Configuration Form to see which lines you want to have in the pool.

6. Touch the button of any line whose pool assignment you want to change. Each touch of the button gives you one of the following codes:

Steady red light on = line is assigned to pool

Red light off = line is not assigned to pool

NOTE: If you hear a beep, the line is already in another pool. You must remove the line from its current pool, by dialing that pool's access code and touching the line button, before you can assign the line to this pool.

7. To administer another pool, dial the appropriate access code (9 or 890 through 899) and repeat steps 5 and 6.

8. To make sure that your line pools are setup as you want them, dial the access code of each line pool in turn and verify that the steady red lights are on next to the correct line buttons.

9. Touch Adm Pool.

The lights next to the administration mode buttons flash again.

10. Continue to administer your system or leave administration mode by following the boxed instructions on page 25.

Preparing to Assign Lines to Buttons and Set Up Access to Line Pools

You can assign individual lines and line pools to particular buttons on voice terminals and remove them from buttons whenever necessary. You can also assign individual voice terminals Dial Access to selected line pools. Before you begin assigning lines and line pools to buttons on voice terminals or assigning voice terminals Dial Access to Line Pools, please read the following information.

NOTE: If you plan to use Automatic Route Selection, you must set your system for Dial Access to Line Pools. The procedures for setting up Dial Access to Line Pools are presented on page 38.

- **Always assign lines and line pools to one voice terminal at a time.**
Make sure you have a completed Voice Terminal Configuration Form for each voice terminal.
- **The Initial Feature Assignments diagrams on pages 85 and 86 illustrate the order in which lines are assigned to buttons on attendant consoles when your system is first set up. The system automatically assigns lines to the attendant console in the order in which the lines are plugged into the control unit. This is the “default” arrangement, what your system does unless you specify something different. You can change the order in which lines appear on the console by following the procedure given below.**
- **Each line in your system must appear on a separate button at attendant consoles. If you assign a line pool to an attendant console, your system automatically assigns all the lines to buttons in the order in which they appear in the line pool. Be aware that you may change the positions of your lines on the attendant console when you assign line pools.**
- **For example, say that you setup two pools. Pool 9 contains lines 1,3, and 4 and Pool 890 contains lines 2, 5, and 6. Lines 1 through 6 initially appear on your attendant console in numerical order. If you assign Pool 9, then Pool 890 to the attendant console, however, the lines will appear in this order: 1, 3, 4, 2, 5, 6. If you change your line order by assigning pooled lines to attendant consoles, be sure to relabel your buttons to show the correct line numbers. If you remove a pool from the attendant console, remember that you remove all the lines in that pool.**
- **Remember that voice terminals cannot be administered and used at the same time. You cannot assign lines and line pools to a voice terminal unless it is idle, and the user cannot place or receive calls while you are assigning lines. The voice terminal beeps softly while you are administering it as a reminder that it cannot be used.**
- **When you assign a line to a voice terminal, the system automatically assigns the line to the first button that doesn't already have a line assigned to it, in the order illustrated in the diagram on the following page. You can assign lines to voice terminals in a different pattern by changing the order in which you touch the line buttons. The procedures that follow show how to assign lines to buttons on voice terminals in whatever order you prefer.**

Order in Which the System Assigns Lines
in a Pooled System

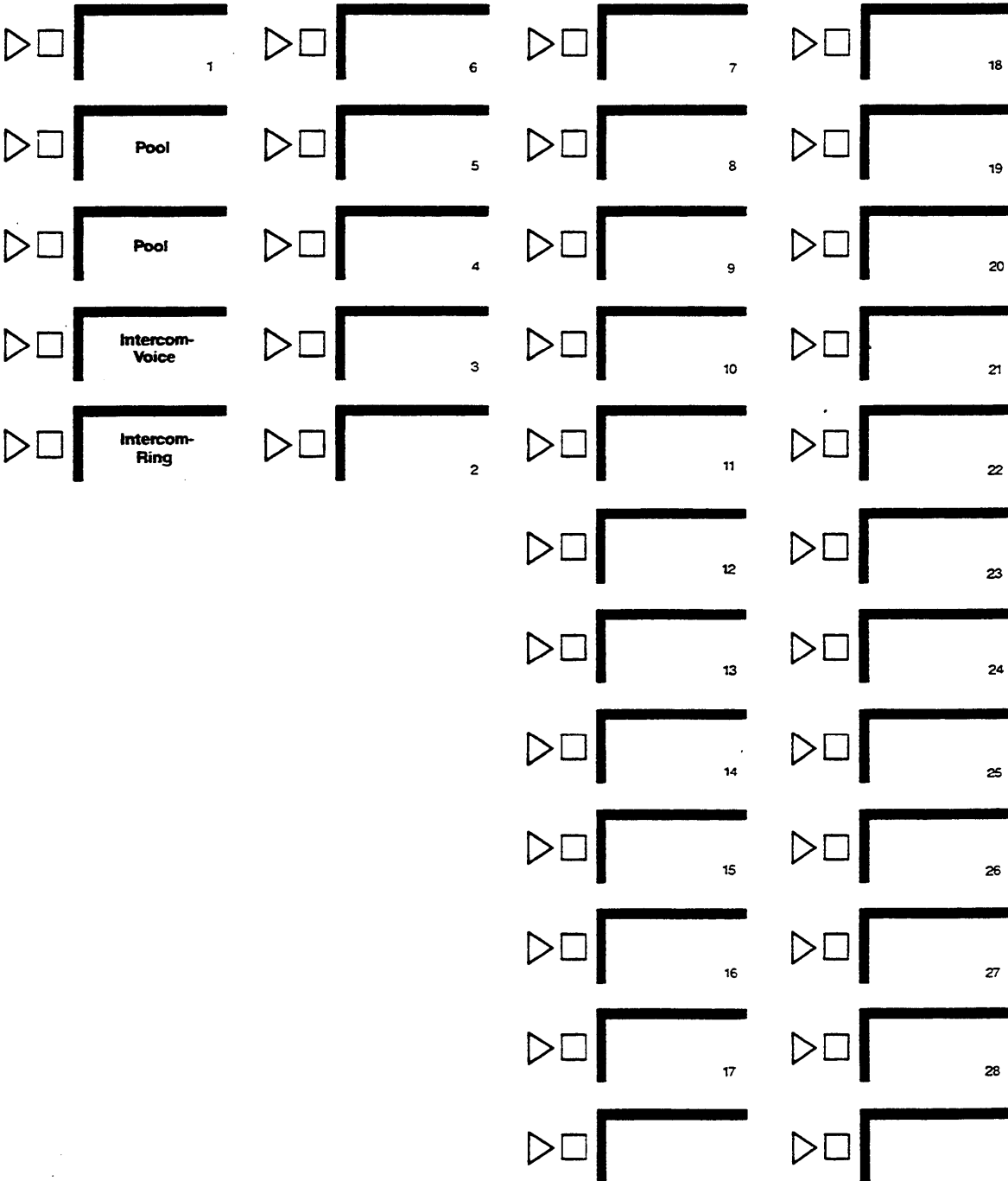

- Note that none of the voice terminals in your system come with preprinted button labels. Be sure to label the buttons with the correct numbers for the individual lines and line pools that you assign to the voice terminal.
- If you set switch *G* on your control unit for Button Access to Line Pools, the system automatically assigns Pool 9, the main pool, to the two buttons above Intercom-Voice on voice terminals. If you set your system for Dial Access to Line Pools, the system automatically assigns these two buttons as dial access buttons. People will touch one of these buttons before dialing the number of the pool they want to use.
- When you assign a line in a pool to a particular button on a voice terminal, you assign all the lines in that pool to that button. Therefore, if you want to assign a certain pool, such as a WATS line pool, to a separate button, you can do so by assigning any line in the pool to the button. You can do this whether switch *G* is set to *Button Access* or *Dial Access*.
- If someone regularly covers calls that come in on another person's line (for example, a secretary who answers someone's personal line), try to assign that line to both people. If you can't, use a Cover button (see page 69). Keep in mind, however, that a Cover button covers all calls that come in on the covered voice terminal, not just calls on a specific line.

The procedures that follow show how to assign individual lines to buttons and how to administer either Button Access or Dial Access to Line Pools. At this point, you should have decided which individual lines to assign to each of your voice terminals. If you selected Button Access to line pools, you also need to know which pools you want to assign to each voice terminal. Be sure you have a completed Voice Terminal Configuration Form for each voice terminal you will be administering.

Assigning Individual Lines to Buttons

To assign individual lines to buttons:

1. If you have not already done so, enter administration mode by following the boxed instructions on page 25.

2. Touch Adm Tel.

The lights next to the administration mode buttons stop flashing, and the green light next to Adm Tel remains on.

3. Dial; the intercom number (15, for example) or touch the Auto Intercom button for the voice terminal to which you want to assign lines.

If the voice terminal is idle, a steady green light comes on next to its Auto Intercom button, and the system gives you a 2-beep signal to begin.

*If the voice terminal is being used, the green lights next to the Auto Intercom button and Adm Tel flash rapidly. You **must** wait until the green lights become steady or else try again later. If you try to assign lines to buttons at a busy voice terminal, the system will beep and you will not be able to proceed.*

4. Refer to the Voice Terminal Configuration Form to see which individual lines should be assigned to this voice terminal. Steady green lights show next to any lines currently assigned to the voice terminal. Steady red lights show next to all lines contained in any system pool.

5. To add a line to or remove a line from this voice terminal, touch the button for that line. The green light next to the line button tells you its current status. Each touch of the line button gives you one of the following codes:

Green light on = line is assigned to the voice terminal

Green light off = line is not assigned to the voice terminal

The order in which you touch the buttons during administration determines the order in which lines appear on the voice terminal. For example, suppose that you have three individual lines to assign to a voice terminal that has Dial Access to Line Pools. These lines appear in alphabetical and numerical order on your administrator/attendant console, as shown on pages 85 and 86. If you touch the button for line B2 first, it will be assigned to the first available position on the voice terminal, in this case the top button in the first column above the dial pad. If you touch the button for line A1 next, it will be assigned to the next available position, the bottom button in the second column. Touching the button for line A0 will assign that line to the next available button, the button above the line A1 button.

NOTE: If you plan to assign a personal line to a voice terminal, be sure not to assign the line to any voice terminals that should not have access to that line.

6. Repeat steps 3 through 5 for each voice terminal in your system.

If you want to give a voice terminal the same line assignments as one that is already set up, use this shortcut:

NOTE: When you copy line assignments, you also copy call restrictions, Dial Access to Line Pools, and allowed-list permissions.

- Dial the intercom number or touch the Auto Intercom Button of the new voice terminal.
- Touch Copy.
- Dial the intercom number or touch the Auto Intercom button of the original voice terminal.

7. Touch Adm Tel.

The lights next to the administration mode buttons flash again.

8. Continue to administer your system, or leave administration mode by following the boxed instructions on page 25.

Assigning Line Pools to Buttons (Button Access to Line Pools)

If you have few line pools and do not use Automatic Route Selection, you will probably prefer to set your control unit and administer your voice terminals for Button Access to Line Pools. Remember that if you select Button Access, it will apply to all voice terminals in your system. Your system will automatically assign the main pool to the two buttons above Intercom-Voice on each voice terminal.

To assign a line pool to a button:

1. If you have not already done so, enter administration mode by following the boxed instructions on page 25.
2. Touch Adm Tel.
The lights next to the administration mode buttons stop flashing, and the green lights next to Adm Tel remain on.
3. Dial the intercom number or touch the Auto Intercom button for the voice terminal to which you want to assign line pools to buttons.
If the voice terminal is idle, a steady green light comes on next to its Auto Intercom button, and the system gives you a 2-beep signal to begin.
If the voice terminal is being used, the green lights next to its Auto Intercom button and Adm Tel flash rapidly. You must wait until the green lights become steady or try again later.
4. Refer to the Voice Terminal Configuration Form to see which line pools should be assigned to this voice terminal. Green lights show next to the buttons of any lines already assigned to this voice terminal. Red lights show next to the line buttons for each line in any system pool.
5. Touch the button of any line in the line pool you want to add to or remove from this voice terminal. Each successive touch of the line button gives you one of the following codes:

Green light on = line pool is assigned to a button
Green light off = line pool is not assigned to a button

NOTE: The system automatically assigns the main pool to the two buttons above the Intercom buttons, and you cannot change this assignment. The system automatically assigns the other line pools to buttons in the order illustrated on page 34. To change the order in which pools other than the main pool appear on the voice terminal, remove all lines and line pools assigned to the voice terminal, following the procedure given above. Then touch the line buttons in the order you want the individual lines and line pools to appear on the voice terminal.

If you're readministering a system, and you don't know the order in which lines and pools appear on the voice terminal, remove all the individual lines and line pools and reassign them.

6. Repeat steps 3 through 5 for each voice terminal in your system.

If you want to give a voice terminal the same line pool assignments as one that has already been set up, use this shortcut:

NOTE: When you copy pool assignments, you also copy call restrictions, Dial Access to Line Pools, and line assignments.

- Dial the intercom number or touch the Auto Intercom button of the new voice terminal.
- Touch Copy.
- Dial the intercom number or touch the Auto Intercom button of the original voice terminal.

7. Touch Adm Tel.

The lights next to the administration mode buttons flash again,

8. Continue to administer your system, or leave administration mode by following the boxed instructions on page 25.

Assigning Dial Access to Line Pools

If you have a pooled system and switch G on the control unit is set to *Dial Access* (up), you can assign individual voice terminals Dial Access to selected line pools. With this arrangement, a person can access any line pool by touching the Pool Access button and dialing the access code for the pool (9 for the main pool or 890 through 899 for additional pools).

If you plan to use Automatic Route Selection, you *must* use Dial Access to Line Pools.

Even if your system is set up for Dial Access to Line Pools, you can still provide Button Access to Line Pools at selected voice terminals. For example, say that you have seven line pools and you have chosen Dial Access to Line Pools to avoid tying up buttons on voice terminals unnecessarily. This arrangement works well for most staff members, who use different line pools for different types of calls. But Pat, an accounts receivable clerk, makes many calls a day, using local lines only. You may choose to assign the main pool to a button on Pat's voice terminal.

NOTE: If you have Automatic Route Selection, you do not have to provide Button Access to save people time in accessing the line pools that they use frequently. The system will select the appropriate pools for all calls automatically.

NOTE: Some voice terminals in your system maybe equipped with an Automatic Tip/Ring Interface (ATRI), a Manual Tip/Ring interface (MTRI), or a General Purpose Adapter (GPA). If you have Dial Access to Line Pools, you must assign a personal line or assign one of your line pools to a particular button on these voice terminals so that users can originate calls from these devices.

For more information about DialAccess to Line Pools, see "Button Access vs. Dial Access to Line Pools," page 19.

When your system is first set up, all your voice terminals have access to all the line pools in the system. Follow the procedure below to assign voice terminals Dial Access to particular line pools.

1. If you have not already done so, enter administration mode by following the boxed instructions on page 25.

2. Touch Adm Tel.

The lights next to the administration mode buttons stop flashing, and the green light next to Adm Tel remains on.

3. Dial the intercom number (16, for example) or touch the Auto Intercom button for the voice terminal to which you want to assign Dial Access to selected line pools.

If the voice terminal is idle, a steady green light comes on next to its Auto Intercom button, and the system gives you the 2-beep signal to begin.

If the voice terminal is being used, the green lights next to the Auto Intercom button and Adm Tel flash rapidly. You must wait until the green lights become steady or try again later.

4. Refer to your Voice Terminal Configuration Form to see to which pools this voice terminal should have Dial Access. Steady green lights come on next to the buttons of the lines assigned to this voice terminal. Steady red lights come on next to the buttons of each line assigned to one of the system pools.

5. Touch the same Auto Intercom button or dial the same intercom number again.

A steady red light comes on next to the green light beside Adm Tel.

If you are trying to assign Dial Access to a line pool to an attendant's console or if the voice terminal is busy, the red light will not come on and the system will beep. You won't be able to perform this procedure.

6. Touch the button next to one of the lines in each of the pools whose status you want to change. The green light beside the button for the line tells you whether the voice terminal has Dial Access to the pool that contains this line. Each successive touch of a line button gives you one of the following codes:

Green light on = voice terminal has Dial Access to this pool

Green light off = voice terminal does not have Dial Access to this pool

Keep in mind that the lines in a pool always change as a group. Touching any button representing a line in a pool affects all the lines in that pool.

7. Repeat steps 3 through 6 for each voice terminal whose Dial Access to Line Pools you want to change.

if you want to give a different voice terminal the same Dial Access to Line Pools as a voice terminal that has already been set up, use the shortcut described below.

NOTE: When you copy the Dial Access assignments, you also copy all call restrictions, allowed-list permissions, and line and pool assignments from the original voice terminal.

- Dial the intercom number or touch the Auto intercom button of the new voice terminal.
- Touch Copy.
- Dial the intercom number or touch the Auto intercom button of the original voice terminal.

8. Touch Adm Tel.

Lights next to the administration mode buttons flash again.

9. Continue to administer your system or leave administration mode by following the boxed instructions on page 25.

Customizing with Additional System Options

Once basic administration is completed, you can assign additional options to your system. The chart below summarizes the procedures described in this section. You may not need to perform all of them to meet your immediate business needs. Read the-description of each procedure first to see if it applies to you.

Customize with Additional System Options

- Assign call restrictions to voice terminals:
 - Set area code detection (if required) and assign outward and toll call restrictions.
 - Set up allowed lists.
 - Assign allowed-list call restrictions.
- Administer Automatic Route Selection.
- Assign voice terminals to paging groups for Group Page.
- Establish Night Service.
- Program System Speed Dial codes.
- Administer SMDR (Station Message Detail Recording) options.
- Set return interval for transferred calls.

ASSIGNING CALL RESTRICTIONS TO VOICE TERMINALS

When your system is first installed, all voice terminals can be used to place intercom, local, and toll calls. If you want, you can restrict selected voice terminals to intercom or local calls only. If those restrictions are too extreme, you can setup allowed lists, which contain groups of numbers that can be dialed regardless of a voice terminal's call restrictions. You can assign these allowed lists to people who need to call numbers that are outside the general restrictions placed on their voice terminals.

You can assign one of the following basic calling ranges to each of your voice terminals:

- **Outward Call Restricted.** Intercom calls only, with allowed list(s) if required.
- **Toll Call Restricted.** Intercom and local calls only, with allowed list(s) if required.
- **Unrestricted.** All calls allowed.

The sections that follow describe the three steps involved in assigning call restrictions to voice terminals. You begin by assigning one of the three basic calling ranges shown above to each voice terminal. Next, if you want to let people at restricted voice terminals make certain types of outside and toll calls, you setup lists of numbers that can be dialed. Then you assign the appropriate allowed list(s) to each restricted voice terminal.

Assigning Outward and Toll Call Restrictions

You may want to restrict some voice terminals to intercom or local calls only if, for example, these employees do not need to make outside or long distance business calls. You probably also want to restrict any voice terminal located in a public area such as a lobby. The procedure for assigning different types of call restrictions is presented below. If you want these restricted voice terminals to have limited additional calling capacity, follow the procedures for setting up and assigning allowed lists that are described in the following pages.

In order to restrict voice terminals to local calls only, your system must be able to identify toll calls as they are dialed. Your lines are automatically set to detect the toll prefix (0 or 1) used in most parts of the country when people dial a long distance call. If you use atoll prefix, you should skip steps 2 through 4 of the procedure below. These extra steps are needed to allow systems installed in areas where toll prefixes aren't used to detect long distance calls using area codes alone.

1. If you have not already done so, enter administration mode by following the boxed instructions on page 25.

If you must dial 0 or 1 before dialing a long distance call, go to step 5.

If you do not dial 0 or 1 before dialing a long distance call, go to step 2.

2. Touch Call Rstr.

The lights next to the administration mode buttons stop flashing, and the green light next to Call Rstr remains on.

3. Green lights next to each line button show whether a toll prefix is required to detect a long distance call placed on this line. Touch each line button until the light beside it shows the appropriate code. Each successive touch gives you one of the following codes:

Steady green on = toll prefix is needed to detect a long distance call

Green off = system detects long distance call by area code on/y

4. Touch Call Rstr.

The lights next to the administration mode buttons flash again.

5. Touch Adm Tel.

The lights next to the administration mode buttons stop flashing, and the green light next to Adm Tel remains on.

6. Dial the intercom number or touch the Auto Intercom button for the voice terminal you want to restrict.

If the voice terminals idle, a steady green light comes on next to the Auto intercom button, and the system gives a 2-beep signal for you to begin.

If the voice terminal is being used, green lights next to the Auto Intercom button and Adm Tel flash rapidly. Wait until the green lights become steady, or try again later.

7. Refer to the Voice Terminal Configuration Form for this user to see what restrictions you plan to assign to this voice terminal. Then touch **Call Rstr** until the green light beside it shows the code for the call restrictions you want this voice terminal to have. Each successive touch gives you one of the following codes:

Steady green on = *unrestricted (all calls allowed)*

Flashing green = *toll restricted (intercom and local calls only plus allowed lists, if you assign any)*

Green off = *outward restricted (intercom calls only plus allowed lists, if you assign any)*

(See page 44 for more information about allowed lists.)

8. Repeat steps 6 and 7 of this procedure until you have assigned call restrictions to all your voice terminals.

If you want to give a voice terminal the same call restrictions as one that has already been set up, use the shortcut below.

NOTE: When you copy the call restrictions, you also copy allowed-list permissions, Dial Access to Line Pools, and line and pool assignments from the original voice terminal.

- Dial the intercom number or touch the Auto Intercom button of the new voice terminal.
- **Touch Copy.**
- Dial the intercom number or touch the Auto Intercom button of the voice terminal whose restrictions you want to copy.

9. Touch **Adm Tel.**

The lights next to the administration mode buttons flash again.

10. Continue to administer your system or leave administration mode by following the boxed instructions on page 25.

Setting Up Allowed Lists

Call restriction by allowed lists adds a group of permitted numbers to the calling range of an outward- or toll-restricted voice terminal. Permitted numbers consist of an area code, an exchange code (the first three digits of a 7-digit telephone number), both codes, or an emergency number such as 911.

For example, a customer service representative in New York City with a toll-restricted voice terminal might need to speak with customers in northern New Jersey (area code 201). This person should have area code 201 in his or her allowed list. A clerk in Houston with an outward-restricted voice terminal might need to call several local vendors and the company's headquarters in Chicago. The clerk's allowed list would include the first three digits of the local vendors' telephone numbers and the area code and first three digits of the firm's Chicago telephone number.

"Assigning Allowed-List Call Restrictions," the section that follows, explains how to assign allowed lists to restricted voice terminals.

You can establish up to eight allowed lists (which you number 0 through 7), each with a maximum of ten entries (which you number 0 through 9). Before you begin setting up allowed lists, fill out an Allowed-List Directory for each allowed list, using the form provided on page 112. Then, follow the procedure below.

1. If you have not already done so, enter administration mode by following the boxed instructions on page 25.
2. Touch Adm Misc.
The lights next to the administration mode buttons stop flashing, and the green light next to Adm Misc remains on.
3. Dial the 2-character code #5.
4. Dial the list number (0 through 7).
5. Dial the number (0 through 9) of the entry you want to record.
6. Dial the new entry, which may consist of an area code, an exchange code, or both. The entry may also be a special-purpose number such as 911.
7. Repeat steps 3 through 6 to add more entries to the same list or to add entries to a different list.
8. If you want to remove an entry from a list, perform steps 3 through 5 and touch Drop.
9. You may have a printer connected to your system for SMDR (Station Message Detail Recording). To order a printout of one of your allowed lists, repeat steps 3 and 4, then dial the 4-character code #900.
When the printout is completed, you hear a beep.
Don't go on to step 10 until you hear the beep, or you will get an incomplete printout. Don't remove the printout until you have completed step 10, or your page alignments will be affected.
10. Touch Adm Misc.
The lights next to the administration mode buttons flash again.
Remove the printout from the printer.
11. Continue to administer your system or leave administration mode by following the boxed instructions on page 25.

A printout of a typical allowed list is shown below.

```
A    ALLOWED LIST 0
A    Entry # 0: 212558
A    Entry # 1: 212688
A    Entry # 2: 212795
A    Entry # 3: 224
A    Entry # 4: 355
A    Entry # 5: 878
```

Assigning Allowed-List Call Restrictions

Once you have created an allowed list, you can assign it to any voice terminal. Follow the procedure below to assign allowed-list call restrictions.

1. If you have not already done so, enter administration mode by following the boxed instructions on page 25.
2. Touch Adm Misc.
The lights next to the administration mode buttons stop flashing, and the green light next to Adm Misc remains on.
3. Dial the 2-character code #4.
4. Dial the number of the list (0 through 7) that you want to assign or reassign to voice terminals.
Green lights come on next to the Auto Intercom buttons for all voice terminals that can access the allowed list.
When you first set up your system, no terminals are able to access any list.
5. Touch the Auto intercom button for each voice terminal whose status you want to change until the correct code is showing.
Green light on = terminal can access the numbers in the list
Green light off = terminal cannot access the numbers in the list
6. Repeat steps 3 through 5 for each allowed list that you want to assign to voice terminals in your system.
7. Touch Adm Misc.
The lights next to the administration mode buttons flash again.
8. Continue to administer your system, or leave administration mode by following the boxed instructions on page 25.

ADMINISTERING AUTOMATIC ROUTE SELECTION (ARS)

To setup Automatic Route Selection, you, the system administrator, must determine which of your line pools provide the lowest cost, most efficient dialing methods for particular types of calls. For example, you may have several WATS line pools that provide the most economical means of making calls to different areas of the country. You may also use an alternate long distance company, whose lines are accessible through your main pool, for certain types of calls.

When you have decided which routing patterns you prefer to use, you take the following steps to administer your ARS system:

- Rank your line pools in order of preference for calls to specific area codes and exchanges. (Exchanges are the first three digits of 7-digit telephone numbers.)
- Record your choices in the forms for Automatic Route Selection Tables provided in the Appendix on page 114.
- Input this information into the system.
- Activate ARS.

Once you have administered ARS, your MERLIN system will automatically select the most appropriate line pool currently available whenever someone in your business places an outside call.

Preparing to Administer ARS Tables

REMEMBER: When you set up your control unit, you set switches F and G to the correct positions for ARS. Before you begin to administer ARS, make sure that switch F on the control unit is set to *Pooled* (up) and switch G on the control unit is set to *Dial Access* (up). (See "Button Access vs. Dial Access to Line Pools," page 19.)

When ARS is activated, the caller does not have to dial the number of a pool to make an outside call. He or she just has to:

- Touch a Pool Access button.
- Lift the handset.
- Dial the outside number.

The system automatically selects the line pool that contains the preferred lines for a call to that area code or exchange. The caller hears "beeps" instead of Touch-Tone signals while the system puts the call through on the line it has selected.

If all lines in the first-choice pool are busy, the system selects the next best pool. If all the lines in the second-choice pool are busy, the system routes the call to the third-choice pool. If all lines in every pool listed on the table for the area code or exchange being dialed are busy, the caller hears a busy signal.

If a trunk line is busy, the caller hears a recorded "all circuits are busy" message. When this happens, the caller touches the same Pool Access button again to route the call to the next entry in the list of line pools.

People dial calls as usual, with one exception. Even if callers don't normally have to dial toll prefix (0 or 1) before dialing a long distance call, they must *dial a toll prefix when using ARS. All callers must dial 1 before the area code and telephone number when placing a direct call and 0 before the area code and telephone number when placing an operator-assisted call.*

You administer ARS by developing a group of ten tables like the sample table below.

TABLE 1

AREA CODE/EXCHANGE

0) —	1) —	2) —	3) —	4) —	5) —	6) —	7 —	8) —	9) —
POOL	OTHER DIGITS								
0) —	_____								
1) —	_____								
2) —	_____								
3) —	_____								
4) —	_____								
5) —	_____								

Tables 0 through 7 consist of three sections. The Area Code/Exchange section at the top of each table contains up to ten 3-digit area codes or exchanges. You need to use two tables if you have more than ten entries that should follow the same pool routing pattern, for example if you have a WATS band that covers more than ten area codes.

The *Pool Number* section of each of these tables contains the numbers of line pools (9, 890-899), listed in the order you want them selected for calls made to the area codes and exchanges entered in the corresponding Area Code/Exchange section. The *Other Digits* section of each of the tables contains any additional digits required for the call, such as access codes and account codes needed to place calls using alternate long distance companies. When someone places a call that is routed through this table entry, the system automatically dials the necessary digits and pauses before the telephone number.

Tables 8 and 9, the default tables, have Pool Number and Other Digits sections only. Table 8, the Default Toll Table, is used for long distance calls to all area codes that aren't listed in Tables 0 through 7. Table 9, the Default Local Table, is used for local calls to all exchanges that aren't listed in Tables 0 through 7. If someone dials digits that do not match any of the entries in Tables 0 through 7, the system automatically routes toll calls to the pools listed in Table 8 and local calls to the pools listed in Table 9.

People in your business may need to call the following *special numbers* for information or for help or to place toll-free calls: 0, 411, 611, 911, 800, and 900. When your system was first set up, these six numbers were automatically assigned as the only entries in the Area Code/Exchange section of the Special Numbers Table. Pool 9, the main pool, was automatically assigned as the only entry in the Pool Number section of the Special Numbers Table. You cannot change these table entries.

If you must dial an access number such as 9 before dialing 0 to reach the operator, you can enter this access code in the Other Digits section of the Special Numbers Table. If you want to use a different pool to reach one of these special numbers, you can place the special number in the Area Code/Exchange section of a table that routes calls to the pool you prefer instead of to the main pool.

To get the maximum benefit from ARS, it is important to consider the calling patterns of people in your business and the relative costs of calls placed on different lines in your system. For example, Primo Foods is a northern New Jersey (area code 201) firm that distributes its specialty meat products in the United States and Canada. Primo has six local lines, two in-state (Band 0) WATS lines, two Northeastern (Band 1) WATS lines, and three cross-country (Band 5) WATS lines. It also uses the alternate long distance company WHIZ for some types of calls. Users must dial 9501099 and wait for a dial tone, then dial 123789 and wait for a dial tone to access the lines used by WHIZ.

Prime's system administrator has set up the following line pools:

- Pool 9 contains the company's six local lines. Pool 9 is the least expensive way to call the 20 exchanges in Prime's immediate calling area.
- Pool 890 contains the two in-state (Band 0) WATS lines. This pool can only be used for calls to area codes 609 and 201. It is the least expensive method for calling anywhere in New Jersey except the immediate calling area, the county in which the Primo plant is located.
- Pool 891 contains the two Northeastern (Band 1) WATS lines. This pool can only be used for calls to Massachusetts, Rhode Island, Connecticut, eastern New York, eastern Pennsylvania, Delaware, Maryland, and Washington, D.C. It is the least expensive way to make calls to area codes 401, 718, 202, 301, 914, 203, 516, 212, 717, 215, 302, 413, and 617.
- Pool 892 contains the three cross-country (Band 5) WATS lines. This pool can be used for calls anywhere in the United States except New Jersey and Alaska. It is the second least expensive way to make calls to area codes covered by the Northeastern WATS lines and the least expensive way to make calls to other area codes.

WHIZ, the alternate long distance company, is more expensive than the WATS lines for all calls. It is more expensive than local lines for calls within area code 201, but less expensive than the local lines for calls to all other area codes.

Frank, the system administrator, begins to set up Automatic Route Selection by preparing tables for specific area codes covered by Prime's WATS lines. His first step is to enter the area codes covered by the Northeastern (Band 1) WATS line pool in the Area Code/Exchange section of Table 0. Since there are 13 area codes and only ten can be included in a table, Frank places the last three area codes in Table 1.

His next step is to specify the routing for calls to these area codes. Because the Northeastern WATS line pool is the least expensive method, Frank makes Pool 891 the first entry in the Pool Number sections of Tables 0 and 1. The cross-country WATS line pool provides the second least expensive way to call these area codes, so he lists Pool 895 below Pool 891 in Tables 0 and 1. The third least expensive calling method is WHIZ. Frank makes Pool 9, the only pool that provides access to WHIZ, the third entry in the Pool Number sections of the two tables. In the corresponding Other Digits section, he lists the WHIZ access number, followed by four pauses, then the account code, followed by a pause.

Frank doesn't include Pool 9 as the fourth routing method, although it could be used to call these area codes, because Prime's financial director prefers that employees wait for a free line rather than use local lines for long distance calls.

Tables 0 and 1 look like this:

TABLE 0

AREA CODE/EXCHANGE

0) 401 1) 718 2) 202 3) 301 4) 914 5) 203 6) 516 7) 212 8) 717 9) 215

POOL

0) 891 _____
 1) 895 _____
 2) 9 9501099pppp123789p
 3) _____
 4) _____
 5) _____

TABLE 1

AREA CODE/EXCHANGE

0) 302 1) 413 2) 617 3) _____ 4) _____ 5) _____ 6) _____ 7) _____ 8) _____ 9) _____

POOL OTHER DIGITS

0) 891 _____
 1) 895 _____
 2) 9 9501099pppp123789p
 3) _____
 4) _____
 5) _____

Next, Frank sets up routing patterns for in-state calls (area codes 609 and 201). Since employees don't dial 201 when calling within their own area code, separate tables are required for calls to these two area codes.

Frank begins by entering 609 in the Area Code/Exchange section of Table 2. Since the in-state WATS line pool is the best method for making calls to area code 609, he makes Pool 890 the first entry in the Pool Number section of Table 2. WHIZ is the second best method for placing these calls, so Frank enters Pool 9 below Pool 890 in the Pool Number section and enters the WHIZ access and account codes and the required pauses in the Other Digits section.

Table 2 looks like this:

TABLE 2

AREA CODE/EXCHANGE

0) 609 1) _____ 2) _____ 3) _____ 4) _____ 5) _____ 6) _____ 7) _____ 8) _____ 9) _____

POOL OTHER DIGITS

0) 890 _____
 1) 9 9501099pppp123789p
 2) _____
 3) _____
 4) _____
 5) _____

Next, Frank considers how best to route calls to numbers in area code 201. Local lines are the least expensive method for making calls to the 20 exchanges in the immediate area, and all other calls should be made on the in-state WATS lines. Frank sets up Tables 3 and 4 to establish a routing method for calls to Prime's local exchanges. He lists the 20 exchanges in the Area Code/Exchange sections of the two tables, putting the maximum often entries in each. His first entry in the Pool Number section of the tables is Pool 9, the local line pool. His second entry is Pool 890, the in-state WATS line pool, which is the next lowest cost way to make these calls.

Tables 3 and 4 look like this:

TABLE 3

AREA CODE/EXCHANGE

0) 834 1) 949 2) 946 3) 975 4) 264 5) 431 6) 462 7) 530 8) 576 9) 577

POOL	OTHER DIGITS
0) <u>9</u>	_____
1) <u>890</u>	_____
2) _____	_____
3) _____	_____
4) _____	_____
5) _____	_____

TABLE 4

AREA CODE/EXCHANGE

0) 566 1) 583 2) 591 3) 671 4) 957 5) 739 6) 741 7) 747 8) 780 9) 842

POOL	OTHER DIGITS
0) <u>9</u>	_____
1) <u>890</u>	_____
2) _____	_____
3) _____	_____
4) _____	_____
5) _____	_____

Frank can now complete his tables for calls within area code 201 by setting up a routing pattern for all 7-or 8-digit calls to exchanges not listed in Tables 3 and 4. For this, he uses Table 9, the Default Local Table. The system follows the sequence of line pools specified in Table 9 to route *all* calls that don't match any of the entries in the Area Code/Exchange sections of the rest of the tables. Table 9 has no Area Code/Exchange section to fill in, since the table covers all numbers not listed in other tables.

The least expensive method for making these calls is the in-state WATS line pool, so Pool 890 is the first entry in the Pool Number section of the Default Local Table. The only other way to make these calls is to use local lines, so Pool 9 is Frank's second entry.

The Default Local Table looks like this:

TABLE 9: DEFAULT LOCAL

POOL	OTHER DIGITS
0) <u>890</u>	_____
1) <u>9</u>	_____
2) _____	_____
3) _____	_____
4) _____	_____
5) _____	_____

Next, Frank considers the areas outside the Northeastern United States to which Primo employees make calls. The salespeople frequently tail the firm's Canadian distributors. WHIZ is the only company-approved method for these calls. Frank lists the nine Canadian area codes that the salespeople call in the Area Code/Exchange section of Table 5. He enters a 9 for the main pool in the Pool Number section and the WHIZ access and account codes, with the required pauses, in the Other Digits section.

Table 5 looks like this:

TABLE 5

AREA CODE/EXCHANGE

0) 604 1) 403 2) 514 3) 819 4) 418 5) 416 6) 613 7) 902 8) 506 9) ___

POOL	OTHER DIGITS
0) <u>9</u>	_____
1) ___	_____
2) ___	_____
3) ___	_____
4) ___	_____
5) ___	_____

Frank has now set up tables to route long distance calls within New Jersey, to other Northeastern states, and to Canada. The company's cross-country WATS line pool is the least expensive method for all other long distance calls his co-workers have to make. So he wants the system to route 10- or 11-digit calls *to all* area codes that aren't included in other tables to the pools listed in Table 8, the Default Toll Table.

Frank's first entry in the Pool Number section of Table 8 is 895, the cross-country WATS line pool. The second least expensive method for these calls is WHIZ. Frank records this as his second choice by entering a 9 for the main pool in the Pool Number section and entering the required access code and account code digits and pauses in the corresponding Other Digits section.

The Default Toll Table looks like this:

TABLE 8: DEFAULT TOLL

POOL	OTHER DIGITS
0) <u>895</u>	_____
1) <u>9</u>	_____
2) ___	_____
3) ___	_____
4) ___	_____
5) ___	_____

The routing patterns set up in Tables 0 through 5 and in the default tables meet all Prime's current needs, so Frank leaves Tables 6 and 7 blank for now.

Use the form for Automatic Route Selection tables provided in the Appendix to complete a similar set of ARS tables for your system. It is important to prepare these tables carefully, so that your business gains the maximum benefit from Automatic Route Selection. If you have a printer connected to your system, you can printout the ARS tables as you prepare them, to serve as worksheets and for future reference.

After preparing your tables, follow the procedures below.

Administering Area Code/Exchange Sections of ARS Tables

To administer the Area Code/Exchange sections of Tables 0 through 7, follow the procedure below.

Tables 8 and 9 have no Area Code/Exchange sections for you to administer, since they are default tables, used in calling *all* area codes and exchanges not specified in the other tables. You cannot change the entries in the Area Code/Exchange section of the Special Numbers Table.

1. If you have not already done so, enter administration mode by following the boxed instructions on page 25.
2. Touch Adm Misc.
The lights next to the administration mode buttons stop flashing and the green light next to Adm Misc remains on.
3. Dial the 2-character code #6.
4. Dial the table number (0 through 7).
5. Dial the number (0 through 9) of the entry you want to record.
6. Dial the area code or exchange you want to record.
7. If you want to remove an entry, repeat steps 3 through 5 and then touch Drop.
8. Repeat steps 3 through 6, or perform step 7, for each table entry you want to administer.
9. If you have a printer connected to your system for SMDR, you can get a printout of the complete set of ARS tables. Sample printouts are shown on pages 49 through 51. To get a printout, dial the 4-character code #902.
The green light next to Adm Misc flashes.
When the printout is completed, you hear a beep and the green light next to Adm Misc becomes steady.
Don't go on to step 10 until you hear the beep, or you will get an incomplete printout. Don't remove the printout until you've completed step 10, or your page alignments will be affected.
10. Touch Adm Misc.
The lights next to the administration mode buttons flash again.
Remove your printout from the printer.
11. Continue to administer your system or leave administration mode by following the boxed instructions on page 25.

Administering Pool Number and Other Digits Sections of ARS Tables

To administer the Pool Number and Other Digits sections of each table, follow the procedure below. Tables 0 through 9 contain specific pool numbers, plus any access numbers required for an alternate long distance company.

Your system automatically places 9, the number for the main pool, in the Pool Number section of the Special Numbers Table. You cannot change this entry. If you want a particular special number to be routed to some other pool, place that special number in the Area Code/Exchange section of one of your other tables. You can make an entry in the Other Digits section of the Special Numbers Table, if you need to dial an access number such as 9 before dialing 0 (Operator).

1. If you have not already done so, enter administration mode by following the boxed instructions on page 25.
2. Touch Adm Misc.
The lights next to the administration mode buttons stop flashing, and the green light next to Adm Misc remains on.
3. Dial the 2-character code #7.
4. Dial the table number (0 through 9).
5. Dial the number (0 through 5) of the entry you want to record.
6. Dial the pool number (9, 890-899) you want to record.
7. Dial any additional numbers needed, such as an access code and an account code for an alternate long distance company, after the pool number.

NOTE: Each entry in the table may include up to 20 characters. Characters permitted: 0 through 9, pause (Hold button), a timed switch-hook flash (Recall button), and Touch-Tone enable (Transfer button). #is not permitted. Make sure to enter the required number of pauses between the access code and the account code for an alternate long distance company. The average number of pauses required is four, but you may find that your system works best with more or fewer pauses. Be sure to add one pause after the account code as well.

8. If you want to remove an entry from a table perform steps 3 through 5 and then touch Drop.
9. Repeat steps 3 through 7, or perform step 8, for each table entry you want to administer.
10. To add other digits to the Special Numbers Table, dial the 4-character code #800 and perform step 7.
11. To remove other digits from Special NumbersTable, dial the character code #800 and touch Drop.
12. If you have a printer connected to your system for SMDR, you can get a printout of the complete set of ARS tables. To get a printout, dial the 4-character code #902.
The green light next to Adm Misc flashes.
When the printout is complete, you hear a beep and the green light next to Adm Misc remains on.
Don't go on to step 13 until you hear the beep, or you will get an incomplete printout. Don't remove your printout from the printer until you complete step 13, or your page alignments will be affected.
13. Touch Adm Misc.
The lights next to the administration mode buttons flash again.
Remove your printout from the printer.
14. Continue to administer your system or leave administration mode by following the boxed instructions on page 25.

Activating and Deactivating ARS

To activate ARS, dial the 5-character code #3041. If you hear a beep, ARS cannot be activated. Go to the control unit and make sure that switch F is set to *Pooled* (up) and switch G is set to *Dial Access* (up), then try again.

To deactivate ARS, dial the 5-character code #3040. When ARS is deactivated, voice terminal users touch one of the Pool Access buttons and dial the code (9 or 890 through 899) for the pool they want to use.

ASSIGNING VOICE TERMINALS TO GROUPS FOR GROUP PAGE

It maybe convenient to page a particular group of employees such as department heads, committee members, or a project team without disturbing the entire staff. You can use the Group Page feature to page up to ten people through their voice terminal speakers. You do not need an external paging system to use this feature.

You may create up to seven paging groups. Initially, no voice terminals are assigned to paging groups. You may assign a voice terminal to more than one paging group if necessary, but you cannot assign more than ten voice terminals to one group.

Follow the procedure below to assign and reassign voice terminals to paging groups.

1. If you have not already done so, enter administration mode by following the boxed instructions on page 25.
2. Touch Adm Misc.
The lights next to the administration mode buttons stop flashing, and the green light next to Adm Misc remains on.
3. Dial the 3-character code #84.
4. Dial the number of the paging group (1 through 7) to which you want to assign or reassign voice terminals.
5. Refer to your completed Group Page Directory in the Appendix to see which voice terminals should be assigned to the paging group. The green light next to the Auto Intercom button for each voice terminal shows the voice terminal's Group Page assignments. Touch the Auto Intercom button to include or remove a voice terminal. Each successive touch gives you one of these codes:
Steady green light on = terminal in paging group
Green light off = terminal not in paging group
If you hear a beep, the group already has the maximum of ten voice terminals assigned.
6. Repeat steps 3 through 5 for each paging group to which you want to assign or reassign voice terminals.
7. Touch Adm Misc.
The lights next to the administration mode buttons flash again.
8. Continue to administer your system, or leave administration mode by following the boxed instructions on page 25.

ESTABLISHING NIGHT SERVICE

If your system has extra-alerting devices such as bells or flashing lights, you can use them to provide Night Service for your business when the person who usually answers calls is not on duty. Three extra-alerting devices can be connected to the optional Services Module in the control unit to alert people to incoming calls. Following the procedure below, you can assign individual lines to activate each of the extra-alerting devices for Night Service. You can assign each line to only one extra-alerting device.

1. If you have not already done so, enter administration mode by following the boxed instructions on page 25.

2. Touch Night Service.

The lights next to the administration mode buttons stop flashing, and the green light next to Night Service remains on.

3. One by one, touch each line button to be covered by Night Service until the green light beside the line button shows the appropriate code. Each successive touch gives you one of the following codes:

Steady green on = line activates alerting device 1

Flashing green = line activates alerting device 2

Rapidly flashing green = line activates alerting device 3

Green off = line does not ring at an alerting device

4. Touch Night Service.

The lights next to the administration mode buttons flash again.

5. Continue to administer your system, or leave administration mode by following the boxed instructions on page 25.

Activating Night Service

To activate Night Service, the administrator/attendant console must be in the attendant mode.

- To turn on extra-alerting devices to announce incoming calls, press Night Service on the attendant's console.

The green light next to the button goes on.

- To turn off the extra-alerting devices, press Night Service.

The green light next to the button goes off.

PROGRAMMING SYSTEM SPEED DIAL CODES

You can assign System Speed Dial codes to selected telephone numbers and store them in your system so that people can reach the numbers by dialing the abbreviated codes. Before programming System Speed Dial codes, please read the following information and fill out the System Speed Dial Directory in the Appendix.

System Speed Dial codes may be unmarked or marked. Marked codes are very useful for alternate long distance company numbers, access codes, and other numbers you may not want everyone in your business to know.

- When a person uses an *unmarked* System Speed Dial code to make a call on a restricted voice terminal, the telephone number the code represents is subject to the same outward and toll restrictions as a normally dialed number. Also, if your system has Station Message Detail Recording, the phone number represented by the System Speed Dial code, not the code itself, is listed in the "Number Dialed" field of the SMDR report [see "Administering SMDR (Station Message Detail Recording) Options," page 59].
- If a person makes a call using a *marked* System Speed Dial code, however, the restrictions applied to the voice terminal do not apply, unless the voice terminal is outward-restricted without *any* allowed lists. An outward-restricted voice terminal with an empty allowed list assigned to it *can* be used to dial a marked System Speed Dial code. If the caller uses a marked System Speed Dial Code, the phone number dialed is not recorded by SMDR. Instead, the System Speed Dial code (for example, #63) is printed. This preserves the confidentiality of access codes and account numbers.

Follow the procedure below to assign System Speed Dial codes.

1. If you have not already done so, enter administration mode by following the boxed instructions on page 25.
2. Touch Conference.
The red light next to Adm Tel goes on.
3. Dial 0.
4. Dial the 3-character code (#60 through #99) that you want to assign to the telephone number.
5. If you are storing a marked Speed Dial code, dial * after dialing the Speed Dial code.
6. Dial the telephone number. A number for a marked Speed Dial code can have a maximum of 39 characters; a number for an unmarked Speed Dial code can have up to 40 characters. These characters can include Hold (Pause) for a pause, Drop (Stop) for a stop, Transfer for Touch-Tone enable, and Recall for a switchhook flash.
7. Repeat steps 4 through 6 for each System Speed Dial code you want to assign.
8. Touch Conference **twice**.

9. If you have a printer connected to your system for SMDR, you can follow the procedure below to get a printout of your System Speed Dial code numbers. An example of a portion of this type of printout appears below.

a. Touch Adm Misc.

The lights next to the administration mode buttons stop flashing, and the green light next to Adm Misc remains on.

b. Dial the 4-character code #901.

The green light next to Adm Misc flashes.

All 40 codes (#60 through #99) are printed out, even if some are not yet assigned to telephone numbers. If a number includes special characters, they will appear as t for Touch-Tone enable, s for stop, p for pause, or r for recall.

When the printout is completed, you hear a beep and the green light next to Adm Misc becomes steady.

Don't go on to step (c) until you hear the beep, or you will get an incomplete printout. Don't remove your printout until you complete step (c), or your page alignments will be affected.

c. Touch Adm Misc.

The lights next to the administration mode buttons flash again.

Remove your printout from the printer.

10. Continue to administer your system, or leave administration mode by following the boxed instructions on page 25.

```
A      SYSTEM SPEED DIAL NUMBERS
A      Dial Code # 60: 9plp2135586758
A      Dial Code # 61: 9plp2135586759
A      Dial Code # 62:
A      Dial Code # 63:
A      Dial Code # 64:
A      Dial Code # 65: *9p1p5152236596
A      Dial Code # 66: *9p1p5152236597
A      Dial Code # 67: *9plp5152236598
A      Dial Code # 68:
A      Dial Code # 69:
A      Dial Code # 70:
A      Dial Code # 71:
A      Dial Code # 72:
A      Dial Code # 73:
A      Dial Code # 74:
A      Dial Code # 75: 56548 p88888t4444r6666p8888p999995555666
A      Dial Code # 76:
A      Dial Code # 77:
A      Dial Code # 78:
A      Dial Code # 79:
A      Dial Code # 80:
```

ADMINISTERING SMDR (STATION MESSAGE DETAIL RECORDING) OPTIONS

Station Message Detail Recording (SMDR) enables your business to keep records of incoming and outgoing calls. To use this feature, you need an SMDR Module in the control unit and a 1200-baud printer with an RS-232-C interface connector. Before administering SMDR, please read the following information.

- SMDR gives you information in a *call report*. This is a report of outgoing and incoming calls which is printed automatically as the calls occur. The report includes the date and time of each call, its duration, the line and voice terminal on which the call is made, and, if the call is outgoing, the number dialed. The header illustrated below is printed automatically when you turn the system on.

DATE	TIME	CALLED NUMBER	OUR.	LINE	STN.	ACCOUNT
------	------	---------------	------	------	------	---------

The information in call reports helps you to develop records of your telephone traffic patterns and identify abuses in phone privileges so that you can use your system efficiently. If an account code is entered when the call is made, the call report prints it out for you. Account codes are helpful in billing customers and different departments of your company for telephone calls that should be charged to them.

- The system is set to record only outgoing calls that last 1 minute or more; however, you can set the system for a longer or shorter minimum duration. Although the system is also set to record incoming calls, you can set the system not to record them.

Follow the procedure below to administer SMDR.

1. If you have not already done so, enter administration mode by following the boxed instructions on page 25.
2. Touch Adm Misc.
The lights next to the administration mode buttons stop flashing, and the green light next to Adm Misc remains on.
3. To set the time, dial the 4-character code #300 plus two digits for hours and two digits for minutes in the 24-hour format.
For example, if the time is 4:23 a.m., dial the 6-character #3000423. If the time is 4:23 p.m., dial the 6-character code #3001623.
4. To set the date, dial the 4-character code #301 and then dial two digits for the month, two digits for the day, and two digits for the year.
For example, if the date is March 15,1985, dial the 10-character code #301031585.
5. To specify a minimum length of more than 1 minute for SMDR calls, dial the 4-character code #390 and then dial two digits for minutes.
For example, if you want to specify a minimum length of 2 minutes, dial the 6-character code #39002. To specify a minimum of 0 minutes, the only minimum length shorter than 1 minute that the system can set, dial the 6-character code #39000.
6. To specify SMDR for incoming calls, dial one of the following codes:
If you want calls printed, dial the 5-character code #3910.
If you do not want calls printed, dial the 5-character code #3911.

- To get a printout of call records like the sample printout shown below, dial the 8-character code #390#900.

The green light next to Adm Misc flashes.

When the printout is completed, a beep sounds and the green light next to Adm Misc becomes steady

Don't go on to step 8 until you hear the beep, or you will get an incomplete printout. Don't remove your printout until you have completed step 8 or your page alignments will be affected.

- Touch Adm Misc.

The lights next to the administration mode buttons flash again.

Remove your printout from the printer.

- Continue to administer your system, or leave administration mode by following the boxed instructions on page 25.

DATE	TIME	CALLED NUMBER	OUR.	LINE	STN.	ACCOUNT
C 07/02/85	10:42	913129761212	00:01:10	01	10	
C 07/02/85	10:44	983421662	00:00:16	03	50	85613324
C 07/02/85	10:45	98342162	00:00:07	03	50	2162
C 07/02/85	10:45	IN	00:00:10	02	50	
C 07/02/85	10:45	3263	00:00:13	03	10	
C 07/02/85	10:46	912135586452	00:00:20	03	50	
C 07/02/85	10:50	9180022557781	00:00:19	03	50	1236547893214567

Setting Your Printer to Scroll to the Top of the Page

Normally, your printer scrolls to the top of the next page and prints a header when it completes a report. If the heading is being printed in the middle of the page, reset the printer by following the procedure below.

- Turn off the printer and scroll the paper to the top of the next page.
- Enter administration mode by following the boxed instructions on page 25.
- Touch Adm Misc.
- Dial the 4-character code #399.
- Leave administration mode by following the boxed instructions on page 25.
- Turn your printer on.

SETTING THE RETURN INTERVAL FOR TRANSFERRED CALLS

When your system is installed, it is setup so that a call that is transferred from one voice terminal to another rings four times at the second voice terminal. Then, if nobody answers, the call continues to ring at this voice terminal and also begins to ring again at the voice terminal from which it was transferred. If you wish, you can vary the number of times that transferred calls ring to suit the needs of your particular business.

For example, if your voice terminals serve large areas or if employees cannot stop their work immediately to answer calls, you may want to provide as many as nine rings before a transferred call is returned. On the other hand, if you prefer to minimize ringing at voice terminals that are unattended or in public places, you can set the return interval for one or two rings. You can also set your system not to return transferred calls at all.

Follow the procedure below to set the Transfer Return interval.

1. If you have not already done so, enter administration mode by following the boxed instructions on page 25.
2. Touch Adm Misc.
The lights next to the administration mode buttons stop flashing, and the green light next to Adm Misc remains on.
3. Dial the 4-character code #306.
4. Dial a number from 1 through 9 to indicate how many rings should occur before the transferred call returns. If you do not want transferred calls to return, dial 0.
5. Touch Adm Misc again.
The lights next to the administration mode buttons flash.
6. Continue to administer your system, or leave administration mode by following the boxed instructions on page 25.

Programming Voice Terminals for Office Priorities

Your system comes ready to use with certain custom features assigned to the voice terminals. The illustrations on pages 63 through 65 show these initial feature assignments for all voice terminals (except attendant consoles) in both square and pooled systems. (Initial feature assignments for attendant consoles appear on pages 85 and 86.) Initially, all button labels on voice terminals are blank, so make sure all the buttons on the voice terminals are properly labeled with any initial features retained and any additional features assigned. You may wish to give voice terminal users a copy of the Voice Terminal Configuration Form.

The people in your business can customize their voice terminals by changing initial custom feature assignments to suit their needs. Alternatively, *you* can program individual voice terminals from the administrator/attendant console, using Centralized Voice Terminal Programming.

Most of the custom features are designed primarily for the convenience of the person using them, but some have a broader application because they affect the calling patterns of your business. These features include Automatic Line Selection, Programmable Line Ringing, Call Coverage, and Line Pickup. Because these features have a businesswide influence, you may want to assign them yourself or oversee their assignment.

This section begins with a discussion of how to use Centralized Voice Terminal Programming, followed by descriptions of the procedures listed in the chart below.

Program Voice Terminals for Office Priorities

- **Assign an Automatic Line Selection sequence.**
- **Assign Programmable Line Ringing for incoming calls.**
- **Assign Cover buttons.**
- **Assign Line Pickup buttons.**

Initial Feature Assignments for Non-attendant Voice Terminals with 1030 or 3070 Configuration in Standard Square Systems

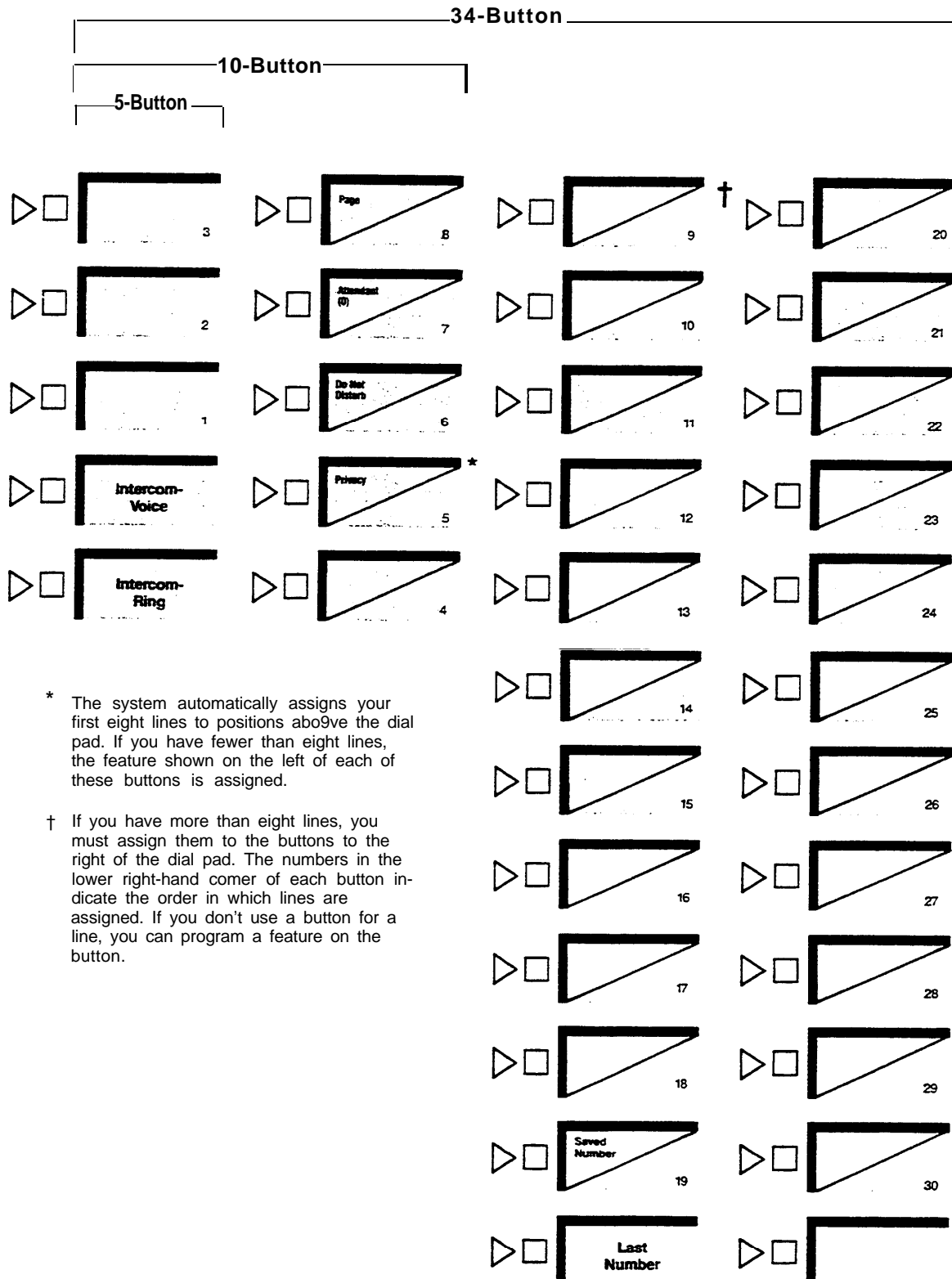

Initial Feature Assignments for Non-attendant Voice Terminals with 1520 Configuration in Standard Square Systems

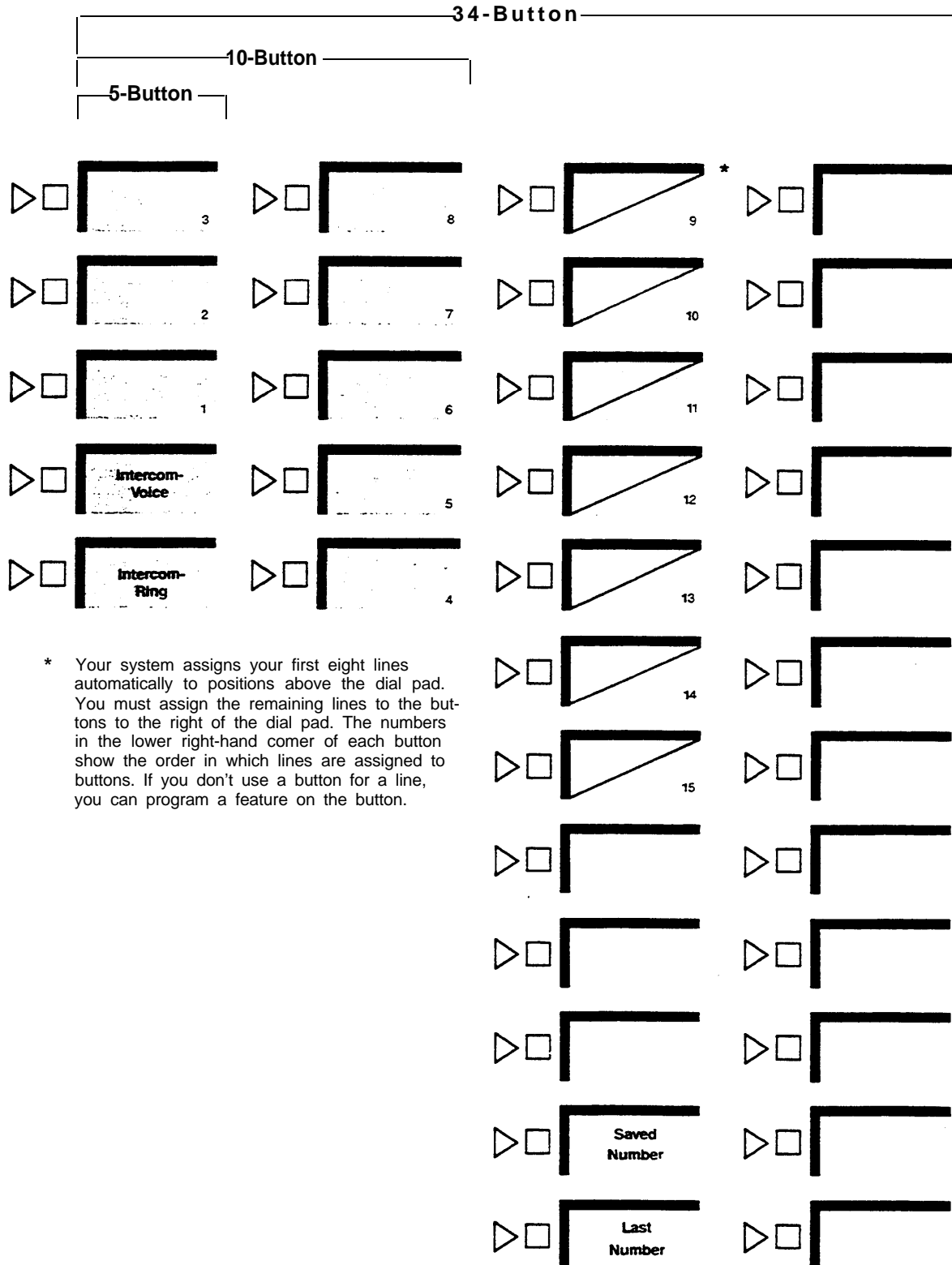

Initial Feature Assignments for Non-attendant Voice Terminals in Pooled Systems

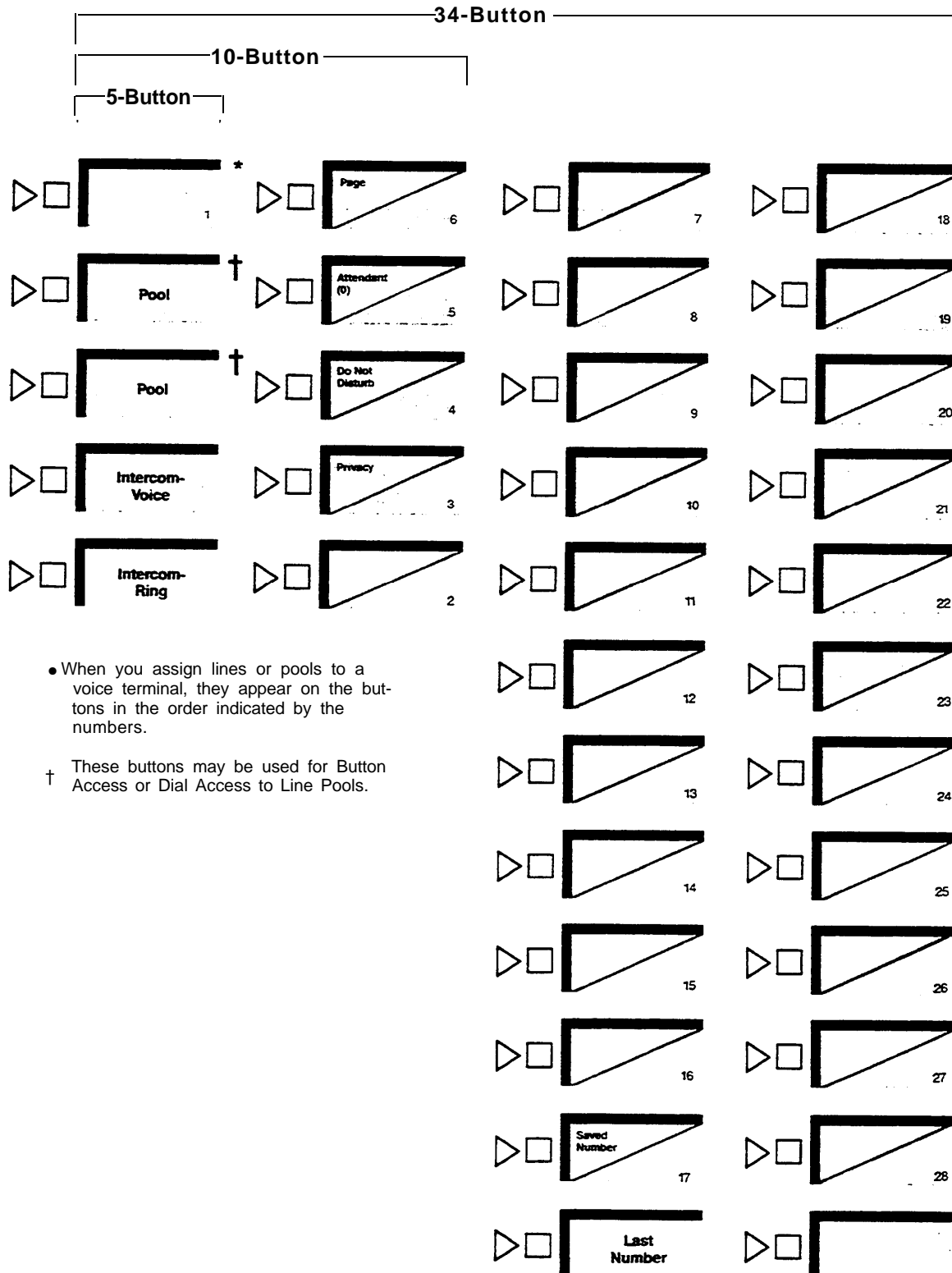

USING CENTRALIZED VOICE TERMINAL PROGRAMMING

Using Centralized Voice Terminal Programming, you can assign features conveniently to all voice terminals from the administrator/attendant console. You can use Centralized Voice Terminal Programming to assign any of the features described in this section of the manual to individual voice terminals throughout your system.

1. If you have not already done so, enter administration mode by following the boxed instructions on page 25.

2. Touch Conference.

The red light next to Adm Tel goes on.

3. Dial the intercom number or touch the Auto Intercom button of the voice terminal you want to program.

The red light next to Adm Tel goes out and a single tone sounds every 5 seconds as a reminder that you are programming. This is similar to what you would hear if you were programming the voice terminal itself. The voice terminal you are programming cannot be used to make or receive calls, and callers get a busy signal.

If the voice terminal you want to program is busy, the red light next to Adm Tel and the green light next to the Auto Intercom button of the voice terminal flash alternately. You must wait for the voice terminal to become idle before continuing to step 4. If you prefer not to wait, you can touch Conference again and select another voice terminal to program, or touch Conference twice to terminate the programming procedure.

4. Program any features you wish to assign to the voice terminal.
5. To program another voice terminal, repeat steps 2 through 4.
6. Touch Conference twice.
7. Continue to administer your system, or leave administration mode by following the boxed instructions on page 25.

ASSIGNING AN AUTOMATIC LINE SELECTION SEQUENCE

Automatic Line Selection is a MERLIN system feature that gives you a free line whenever you pick up the handset. When a voice terminal is first installed, it automatically selects lines in the order in which they appear on the voice terminal. However, you can rearrange the Automatic Line Selection sequence, if necessary. For each voice terminal, you can specify which line the system gives you first and, if that line is busy, which line the system gives you second, and soon. A maximum of eight lines may be included in an Automatic Line Selection sequence. Before assigning an Automatic Line Selection sequence, please read the following information.

- When you program several features at once, Automatic Line Selection must be the first feature you program. If the voice terminal is already in programming mode, slide the T/P switch to the center position, and then back to *P*.
- If your system has Dial Access to Line Pools, any voice terminal with an Automatic Tip/Ring Interface (ATRI), a Manual Tip/Ring Interface (MTRI), or a General Purpose Adapter (GPA), *must* have a personal line or a button assigned to a particular pool in order to originate a call from the device. This button should be the first entry in the Automatic Line Selection sequence described below.
- Do not place both intercom and outside lines in the Automatic Line Selection sequence for any voice terminal.
- If all the outside lines on a voice terminal are assigned to pool buttons, or if they are assigned to separate buttons but are interchangeable with one another (for example, all regular telephone company lines), you will probably prefer to program this feature. But if a voice terminal has two or more different types of lines, such as a line pool plus a private line or a WATS line, it may not be wise to program the order for Automatic Line Selection. Users will probably prefer to select the most appropriate line or line pool for the type of call, either themselves or with Automatic Route Selection.

Use Centralized Voice Terminal Programming or follow the procedure below to assign an Automatic Line Selection sequence.

1. Go to the voice terminal you want to program.
2. Slide the T/P switch on the left side of the voice terminal to *P*.
The voice terminal rings every 5 seconds to remind you it is in program mode.
3. Dial **.
4. Touch the individual line and line pool buttons in the order you want them to be selected.
5. If you have more options to program on this voice terminal, you can do so. Otherwise, slide the T/P switch to the center position to return to normal operation.

ASSIGNING PROGRAMMABLE LINE RINGING FOR INCOMING CALLS

You can customize the line buttons, pool buttons, and Cover buttons on your voice terminals so that calls coming in on those lines ring in one of three different ways: immediate ring, delayed ring, and no ring.

All lines at attendant consoles are set to ring immediately. When your system is first installed, all lines above the dial pad on non-attendant consoles are set to "immediate ring" except for lines assigned to the pool buttons in a pooled system. These lines are initially set to "no ring." Lines to the right of the dial pad are also set to "no ring" initially. The ringing assignment for outside calls in no way affects internal calls, such as intercom and transferred calls. If you are assigning line ringing for the first time, please read the following information.

- **Immediate ring.** Assign immediate ringing of a line to anyone responsible for answering that line first (for example, the attendant, a secretary, or a receptionist). This option is also useful for private lines that should not be screened or for people who answer their own calls.
- **Delayed ring.** Delayed ring provides backup coverage on shared lines. The voice terminal assigned delayed ringing for a certain line does not ring unless someone else fails to answer after two rings. Assign delayed ringing of a line to anyone responsible for answering a shared line only if someone else doesn't pick it up. A delayed ring backup is useful for a secretary on someone's private line. Delayed ring may also be used on an attendant console as a backup for a different attendant. (if you want to provide coverage for inside or transferred calls, or for lines that are not shared, use the Cover feature described on page 69.)
- **No ring.** Assign no ring to lines on a voice terminal that are always screened first at another voice terminal, such as pooled lines or someone's lines that ring first at a secretary's voice terminal. This option is also appropriate for voice terminals with no regular users or voice terminals in public places such as lobbies or conference rooms. When you assign no ring to an individual line, the green light next to the line button still flashes when a call comes in on the line. However, if you assign no ring to a pool button, the green light next to the button does not flash.

Use Centralized Voice Terminal Programming to assign line ringing from the administrator/attendant console, or follow the procedure below.

1. Go to the voice terminal you want to program.
2. Slide the T/P switch on the left side of the voice terminal to *P*.
The voice terminal rings every 5 seconds to remind you it is in program mode.
3. Touch the outside line button that you want to program until the red light beside it shows the appropriate code. Each successive touch gives you one of these codes:
Steady red on = immediate ring
Flashing red = delayed ring
Red off = no ring
4. Repeat step 3 for each line that you want to program.
5. If you have more options to program on this voice terminal, you can do so. Otherwise, slide the T/P switch to the center position to return to normal operation.

ASSIGNING COVER BUTTONS

The Call Coverage feature is useful for people who cover calls for others with whom they do not share lines. A Cover button permits coverage of all lines on a voice terminal regardless of whether the covering voice terminal shares lines with the covered voice terminal. The lights next to a Cover button work like those next to any line button, but you cannot use a Cover button to make a call. If you are assigning Cover buttons for the first time, please read the following information.

- A Cover button may be programmed for primary or secondary coverage. Suppose that you assign Jim primary coverage for Susan's voice terminal (see diagram below). Then each time a call rings at Susan's voice terminal it also rings at Jim's voice terminal. To make certain that Susan's calls are answered when both Susan and Jim are away from their desks, you assign secondary coverage with delayed ring for Susan's voice terminal to Bill. This means that when a call comes in for Susan, it rings at Susan's voice terminal and at Jim's voice terminal, then starts ringing at Bill's voice terminal on the fifth ring. Jim's calls do not ring at Bill's voice terminal, however, unless you assign Call Coverage for Jim's calls to Bill. With this system, up to six people can have Cover buttons for a single voice terminal.

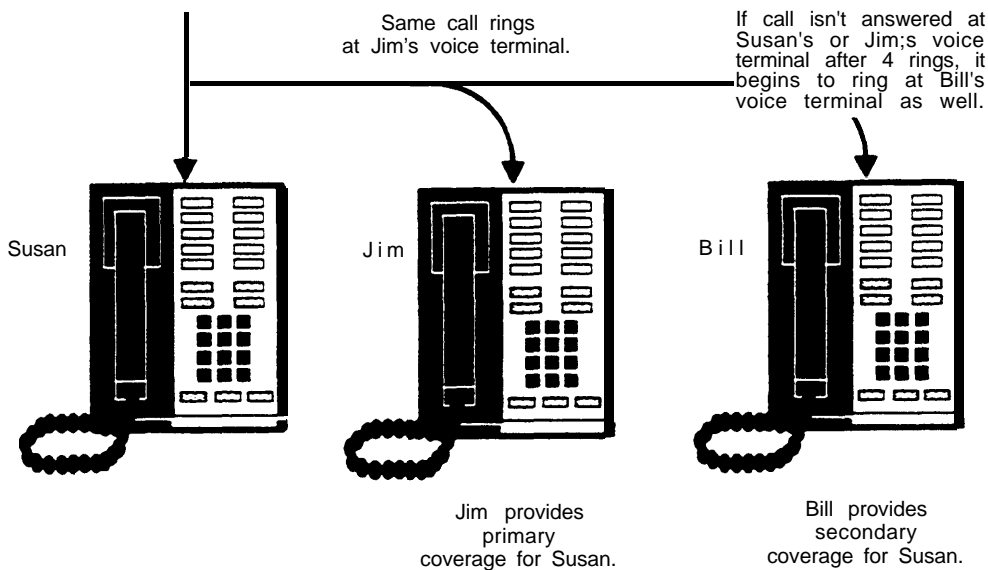

PRIMARY AND SECONDARY COVERAGE

- You will probably always want to program a delayed ring for the voice terminal providing secondary coverage. You can program the voice terminal providing primary coverage with an immediate or a delayed ring, depending on the users' preferences. Immediate and delayed ring are described on page 68.
- *Assign primary coverage* to someone who must screen a co-worker's calls but does not share all lines with that person. You can also assign primary coverage to someone who must cover a co-worker's intercom calls. A secretary who answers someone's calls, for example, would be assigned primary coverage of that person's voice terminal. You may program a primary Cover button for either immediate ring or delayed ring, depending upon the situation and personal preferences.
- Assign secondary coverage to anyone who is a second backup for the covered voice terminal, such as a personal secretary who covers calls for a group secretary when the group secretary doesn't answer calls for which he or she has a primary Cover button. In most cases, a secondary Cover button would be programmed for delayed ring.
- If all calls in your business come in through the attendant console, a Cover button for the console set to no ring is useful for people who sometimes work during times when the attendant is not on duty. In this way, they can tell by the flashing green light that someone is calling, and they can answer the call if they want to, but do not have to be bothered by ringing during regular business hours.

Use Centralized Voice Terminal Programming or follow the procedure below.

1. Go to the voice terminal you want to program.
2. Label the Cover button with the name of the person whose calls will be covered (for example, "Cover Susan").
3. Slide the T/P switch on the left side of the voice terminal to *P*.
The voice terminal rings every 5 seconds to remind you it is in program mode.
4. Touch the button you want to be the Cover button. You must use a programmable button with lights, and you may program no more than six Cover buttons on anyone voice terminal.
5. Dial *4 to program primary coverage, or dial *5 to program secondary coverage.
6. Dial the 2-digit intercom number of the voice terminal you want the button to cover.
7. Cover buttons are set initially for no ring. To select the preferred line ringing option, touch the Cover button until the red light beside it shows the appropriate code. Each successive touch gives you one of the following codes:

Steady red on = immediate ring

Flashing red = delayed ring

Red off = no ring

If the green light beside the Cover button flashes and you hear a beep, you have not performed the procedure correctly. Repeat steps 4 through 7.

8. If you have more options to program on this voice terminal, you can do so. Otherwise, slide the T/P switch to the center position to return to normal operation.

ASSIGNING LINE PICKUP BUTTONS

The Line Pickup feature allows a person to pickup a ringing, parked, or held call on a specific line at any voice terminal. This feature is especially convenient with parked or held calls. The attendant or another voice terminal user simply announces the call by intercom or by page, specifying the line number to be picked up. The person being called does not need to know where the call was received in order to pick it up. It is a good idea to number the lines on the attendant console if you're going to use Line Pickup.

This feature offers voice terminal users three options:

- Program individual buttons to pick up specific lines.
- Program one Line Pickup button and use it with 2-digit line codes to pick up lines.
- Dial *8 and a 2-digit line code to pick up a line.

You must program voice terminals for the first and second options, in which buttons are used. No programming is required for the third option. When you have determined which option to assign to a particular voice terminal, use Centralized Voice Terminal Programming to program the voice terminal from the administrator/ attendant console or follow the procedure below.

1. Go to the voice terminal that you want to program.
2. Slide the T/P switch on the left side of the voice terminal to *P*.
The voice terminal rings every 5 seconds to remind you it is in program mode.
3. Touch the button that you want to program.
4. Dial *84.
5. If you plan to have only one Line Pickup button that will be used with various line codes as required to pick up calls, go to step 6. If you want to program the Line Pickup button for a specific line, dial the line code shown in the list below for that line.
6. If you have more options to program on this voice terminal, you can do so. Otherwise, slide the T/P switch to the center position to return to normal operation.

Control Unit Jack Number	Line Code Number	Control Unit Jack Number	Line Code Number
A0	01	D0	16
A1	02	D1	17
A2	03	D2	18
A3	04	D3	19
A4	05	D4	20
B0	06	E0	21
B1	07	E1	22
B2	08	E2	23
B3	09	E3	24
B4	10	E4	25
C0	11	F0	26
C1	12	F1	27
C2	13	F2	28
C3	14	F3	29
C4	15	F4	30

Programming Voice Terminals for Personal Priorities

By programming their own voice terminals, people can change the features on all but the fixed feature buttons and the line, pool, and intercom buttons. This allows almost everyone to have features that provide personal convenience, such as an Outside Auto Dial button for calling home. Whether you assign the features or someone else does, be sure the buttons are labeled with the proper feature names. The chart below lists the procedures presented in this section.

Program Voice Terminals for Personal Priorities

- **Assign features to programmable buttons.**
- **Assign Personal Speed Dial codes to 5- and 10-button voice terminals.**
- **Use special characters in programmed dialing sequences.**
- **Select a Personalized Ring.**
- **Program Voice Announcement Disable.**
- **Program Simultaneous Voice and Data Calls.**

ASSIGNING FEATURES TO PROGRAMMABLE BUTTONS

As system administrator, you may have to decide which custom features certain voice terminals should have, taking into consideration the individual's needs and the capabilities of the voice terminal. The Feature Programming Chart on pages 74 through 76 lists the programming codes needed to assign the features, and the initial feature assignments diagrams, pages 63 through 65, show what features are automatically assigned to the voice terminals. Before assigning features, please read the following information.



- Certain features require buttons with lights to indicate if the feature is on or off. These features are Do Not Disturb, Call Coverage, Privacy, Message, Coverage Inhibit, Auto Answer-Intercom, Auto Answer-All, and Account Number Entry.
- A button with lights is recommended, but not required, for Auto Intercom, Loudspeaker Page, and Manual Signaling.
- Features that require optional equipment are Loudspeaker Page, which may require a button, and Auto Answer-Intercom and Auto Answer-All, which always require a button.

Follow the procedure below to assign features at a voice terminal. If you prefer to program the voice terminal from the attendant's console, follow the procedure for Centralized Voice Terminal Programming on page 66.





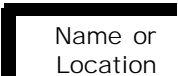
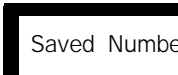
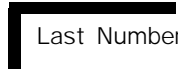

1. Go to the voice terminal you want to program.
2. Label the button with the feature name.
3. Slide the T/P switch on the left side of the voice terminal to *P*.
The voice terminal rings every 5 seconds to remind you it is in program mode.
4. Touch the button that you want to represent the feature.
5. Dial the appropriate feature programming code and additional numbers or characters, if required, from the Feature Programming Chart, pages 74 through 76. If you make a mistake, touch the button again and redial the information.
6. If you have more features to program on the voice terminal, you can do so by repeating steps 4 and 5. Otherwise, slide the T/P switch to the center position to return to normal operation.

Feature Programming Chart







Use the chart below as a quick reference when you want to program features onto your voice terminal.

Feature Name [Suggested Button Label]	Description	Programming Code	Notes
QUICK DIALING FEATURES			
Outside Auto Dial  Name or Location	Dial outside telephone numbers or PBX/Centrex feature codes with one touch.	<ul style="list-style-type: none"> • Dial *90. • Dial an outside number, an account number, or a PBX, Centrex, or Custom Calling feature code. 	
Auto Intercom  Name or Location	Place ringing intercom calls with one touch.	<ul style="list-style-type: none"> • Dial *91. • Dial a MERLIN system intercom number. 	A button with lights is recommended but not required. The green light goes on when the other person is using his or her voice terminal or is using the Do Not Disturb feature. You can use an Auto Intercom button whenever instructions call for dialing an intercom number. You cannot program both Auto Intercom and Manual Signaling for the same voice terminal.
Manual Signaling  Signal Name	Generate a beep at another person's voice terminal.	<ul style="list-style-type: none"> • Dial *6. • Dial the intercom number for the person you want to signal. 	Use Manual Signaling to contact someone with a prearranged signal. If you program this feature on a button with lights, the green light goes on when the other person is using his or her voice terminal or is using the Do Not Disturb feature. You cannot program Manual Signaling and Auto Intercom for the same voice terminal.
Personal Speed Dial (uses a dial code instead of a button)	Assign a 3-character code (#01 through #22) to each telephone number you call frequently.	<ul style="list-style-type: none"> • Dial a Personal Speed Dial code (#01 through #22). • Dial *90. • Dial an outside telephone number, a PBX, Centrex, or Custom Calling feature code, or an account number. 	For 5- and 10-button voice terminals only.
System Speed Dial  Name or Location	If you programmed System Speed Dial codes for frequently dialed numbers, you can assign any of them to buttons for one-touch dialing.	<ul style="list-style-type: none"> • Dial *95. • Dial a System Speed Dial code (60 through 99). 	You assign System Speed Dial codes to frequently called numbers; then everyone connected to your MERLIN system can use those codes for abbreviated dialing. It is not necessary to assign these codes to buttons.
Saved Number Redial  Saved Number	Save a number indefinitely for later redialing.	<ul style="list-style-type: none"> • Dial *74. 	If you have a 5- or 10-button voice terminal, you can dial a code to use this feature instead of using a button
Last Number Redial  Last Number	Redial the number you dialed most recently.	<ul style="list-style-type: none"> • Dial *73. 	If you have a 5- or 10-button voice terminal, you can dial a code to use this feature instead of using a button.

Feature Programming Chart (continued)

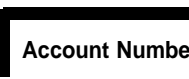
Feature Name (Suggested Button Label)	Description	Programming Code	Notes
PAGING FEATURES			
Loudspeaker Page  Ldsp. Page All	Use your business' loudspeaker paging system to make announcements to all or some of the people in your organization.	<ul style="list-style-type: none"> • Dial * 91. • Dial 80 for all zones <ul style="list-style-type: none"> 81 zone 1 82 zone 2 83 zone 3 	Used only with loudspeaker paging equipment
Group Page  Group Page 1	Make a voice announcement through a group of voice terminal speakers in your MERLIN system.	<ul style="list-style-type: none"> • Dial *91. • Dial 841 for group 1 <ul style="list-style-type: none"> 842 group 2 844 group 4 845 group 5 846 group 6 847 group 7 	You designate the groups. Get a list of the people assigned to individual groups.
AUTO ANSWER FEATURES			
Auto Answer-All  Auto Answer-All	Have a modem or answering machine go on automatically whenever a call rings at your voice terminal.	<ul style="list-style-type: none"> • Dial *75. 	Used only with a modem or answering machine. Requires a button with lights and a General Purpose Adapter.
Auto Answer-Intercom  Auto Answer-Intercom	Have a Hands-Free Unit go on automatically when you receive intercom calls.	<ul style="list-style-type: none"> • Dial *70. 	Used only with a Hands-Free Unit. Requires a button with lights.
CALL COVERAGE FEATURES			
Primary Coverage  Cover John	Receive calls for someone who is unable to answer his or her voice terminal.	<ul style="list-style-type: none"> • Dial *4. • Dial the intercom number of the person you want to cover. 	Requires a button with lights. You can program up to six different Cover buttons.
Secondary Coverage  Cover John	Receive calls, after a delay, as a backup for a co-worker who covers someone else's calls.	<ul style="list-style-type: none"> • Dial *5. • Dial the intercom number of the person you want to cover. 	Requires a button with lights. You can program up to six different Cover buttons.
Coverage Inhibit  Coverage Inhibit	Temporarily deactivate the Cover feature to make sure your calls don't ring at someone else's voice terminal.	<ul style="list-style-type: none"> • Dial *77. 	Requires a button with lights.

Feature Programming Chart (continued)

Feature Name (Suggested Button Label)	Description	Progmming Code	Notes
OTHER FEATURES			
Privacy 	Prevent people from joining your calls.	• Dial * 72.	Needed only if you share lines with other people. Requires a button with lights.
Do Not Disturb 	Temporarily prevent calls from ringing at your voice terminal.	• Dial *71.	Requires a button with lights. Does not affect calls transferred from a covered voice terminal.
Touch-Tone Enable 	If your system has lines that carry rotary pulse signals, you can switch to Touch-Tone signal to use services such as alternate long distance or credit card authorization.	• Dial *76.	
Account Number Entry 	Associate an account number with incoming or outgoing calls.	• Dial *82.	Requires a button with lights.
Call Park 	"Park" a call at your voice terminal for someone to pick up from any voice terminal in your MERLIN system.	• Dial *86.	Use this feature when you aren't sure where to transfer a tail. You can also use a dial sequence to activate this feature if you don't want to use a button. See page 92.
Call Pickup 	Pick up a tail that is ringing, parked, or held at another MERLIN system voice terminal.	• Dial *85.	You can also dial a code to use this feature.
Line Pickup 	Pick up a line that is ringing, held, or parked anywhere in the system.	• Dial *84 or *84 and a 2-digit line code.	The 2-digit line codes are listed on page 71.
Message 	Have your MERLIN system attendant notify you when you have a message waiting.	• Dial *98.	For 5-button voice terminals only.
Simultaneous Voice and Data Calls	Place a telephone call and a data call at the same time.	• Touch Message.	Light next to button shows whether simultaneous voice and data tails are permitted. <i>Green on = simultaneous voice and data calls permitted</i> <i>Green off = simultaneous voice and data calls are not permitted</i>

ASSIGNING PERSONAL SPEED DIAL CODES TO 5- AND 10-BUTTON VOICE TERMINALS AND BASIC TELEPHONES

On 5- and 10-button voice terminals, you can program Personal Speed Dial codes instead of Outside Auto Dial buttons for frequently used numbers. You can also give basic telephones this capability, but only if you use Centralized Voice Terminal Programming. Use Centralized Voice Terminal Programming or follow the procedure below to program Personal Speed Dial codes.

1. Go to the voice terminal you want to program.
2. Slide the T/P switch on the left side of the voice terminal to *P*.
The voice terminal rings every 5 seconds to remind you it is in program mode.
3. Dial the 3-character code you want to assign to the telephone number (available codes are #01 through #22).
4. Dial *90.
5. Dial the telephone number (16-digit maximum). You can include the following special characters: Hold (Pause) for a pause, Drop (Stop) for a stop, Transfer for Touch-Tone Enable, and Recall for a switchhook flash.
6. Make a list of all Personal Speed Dial code numbers and the telephone numbers they represent.
7. If you have more Personal Speed Dial numbers to assign to this voice terminal, you can do so. Otherwise, slide the T/P switch to the center position to return to normal operation.

USING SPECIAL CHARACTERS IN PROGRAMMED DIALING SEQUENCES

An Outside Auto Dial or Personal Speed Dial code can store up to 16 digits, including special characters. You use special characters when you need to program an automatic pause, stop, or switchhook flash (which means briefly depressing the switchhook) with the number. Before you program a special character into a sequence, please read the following information.

- **If your MERLIN system works in combination with a PBX or Centrex system where you have to dial 9 to get an outside line, or if your system has Dial Access to Line Pools, you should program a pause after the 9 or access code in a programmed dialing sequence.**
- **When you use an alternate long distance service, you program one Outside Auto Dial button for the special service number and a separate Outside Auto Dial button for each person you use the service to call.**
- **When using an Outside Auto Dial button or a Personal Speed Dial code with a stop, resume the dialing sequence by touching the Outside Auto Dial button or dialing the Personal Speed Dial code again.**

Now, use the *sample* procedures below as guidelines to program special characters into a dialing sequence.

1. Go to the voice terminal you want to program.
2. Label the button with the person's or service's name.
3. Slide the T/P switch on the left side of the voice terminal to *P*.
The voice terminal rings every 5 seconds to remind you it is in program mode.
4. Touch the button you have labeled for Outside Auto Dial.
5. Dial *90.
6. To program a pause (a 1.5-second delay) into a dialing sequence (for example, with a PBX or Centrex system where you must dial 9 before dialing an outside number):
 - a. Dial 9.
 - b. Touch Hold (Pause).
 - c. Dial the outside number you want the button to represent.
7. To program a stop into a dialing sequence (for example, between a local telephone number and an alternate long distance authorization code):
 - a. Dial the local telephone number (seven digits)
 - b. Touch Drop (Stop).
 - c. Dial the authorization code (five or six digits)
8. To program Touch-Tone Enable into a dialing sequence (for example, between a telephone number and a credit card authorization code):
 - a. Dial the telephone number.
 - b. Touch Transfer.
 - c. Dial the credit card authorization code.
9. To program a switchhook flash into a dialing sequence (for example, for a Custom Calling or PBX or Centrex code that calls for a switchhook flash):
 - a. Touch Recall.
 - b. Touch Hold (Pause).
 - c. Dial the PBX or Centrex dial code sequence that accesses the feature you want to program.
10. To program a # onto a MERLIN system Outside Auto Dial button to access certain PBX or Centrex features:
 - a. Touch the Outside Auto Dial button you want to program with a #.
 - b. Dial *90 and ##.
 - c. Dial the PBX or Centrex dial code sequence that accesses the feature you want to program.
11. If you have more options to program on this voice terminal, you can do so. Otherwise, slide the T/P switch to the center position to return to normal operation.

SELECTING A PERSONALIZED RING

The MERLIN system offers a choice of eight different ringing patterns for any voice terminal. This feature is particularly useful in offices where many people sit in the same room, because it enables people to distinguish the ringing of their voice terminals from the ringing of others. The personalized part of the ring occurs at the end of the ringing pattern, so it does not interfere with the distinctive ringing patterns that signal whether a call is transferred, intercom, or from the outside. Follow the procedure below to program a Personalized Ring.

1. Go to the voice terminal you want to program.
2. Slide the T/P switch on the left side of the voice terminal to *P*.
The voice terminal rings every 5 seconds to remind you it is in program mode.
3. Touch Speaker repeatedly until you hear the ring you want.
4. If you have more features to assign to this voice terminal, you can do so. Otherwise, slide the T/P switch to the center position to return to normal operation.

PROGRAMMING VOICE ANNOUNCEMENT DISABLE

When your system is installed, all voice terminals can receive either announced or ringing intercom calls. However, some people may not want their intercom calls signaled by a voice announcement- For some voice terminals, such as those in public locations, voice announcements may be impractical. Using Voice Announcement Disable, you can program voice terminals to block intercom voice announcements. As a result, all intercom calls to those voice terminals ring, even if the callers try to place an announced intercom call. Use Centralized Voice Terminal Programming or follow the procedure below to program this feature.

1. Go to the voice terminal you want to program.
2. Slide the T/P switch on the left side of the voice terminal to *P*.
The voice terminal rings every 5 seconds to remind you it is in program mode.
3. Touch the Intercom-Voice button successively until the green light next to it shows the appropriate code. Each successive touch gives you one of these codes:
Steady green on = voice announcements permitted
Green off = voice announcements blocked
4. If you have more features to program on this voice terminal, you can do so. Otherwise, slide the T/P switch to the center position to return to normal operation.

PROGRAMMING SIMULTANEOUS VOICE AND DATA CALLS

When a voice terminal in your system is connected to a General Purpose Adapter and a modem, it can link the user's computer terminal to a local or remote host computer. With the Simultaneous Voice and Data Call feature, the user can place or receive calls on his or her voice terminal without interrupting the exchange of data between the computer terminal and the host computer. Use Centralized Voice Terminal Programming or follow the procedure below to program this feature.

1. Go to the voice terminal you want to program.
2. Slide the T/P switch on the left side of the voice terminal to *P*.
The voice terminal rings every 5 seconds to remind you it is in program mode.
3. Touch Message until the green light next to it shows the appropriate code. Each successive touch gives you one of these codes:
Steady green on = simultaneous voice and data calls permitted
Green off = simultaneous voice and data calls not permitted
4. If you have more features to program on this voice terminal, you can do so. Otherwise, slide the T/P switch to the center position to return to normal operation.

Special Information about Attendant Consoles

When the MERLIN system is installed, your attendant consoles come with features that are convenient for most businesses (see initial feature assignments for small and large attendant consoles, pages 85 and 86). The *Attendant's Guide: Models 1030 and 3070 with Feature Module 4* describes all the attendant console features and how to use them.

Attendant consoles serve you best when they are customized to handle the calling patterns of your business. Procedures for assigning system options and individual features are the same for attendant consoles as for the other voice terminals in your system. Keep in mind, however, that attendant consoles always have a square line arrangement, even in pooled systems.

Programming Tips for Attendant Consoles

- The attendant console for a small system should be a 34-button deluxe voice terminal, which has lights next to every button. The lights next to Auto Intercom buttons indicate which voice terminals are busy and which message lights are on.
- Attendants in systems with more than eight outside lines or more than 20 voice terminals should have a large console (34-button deluxe voice terminal that includes an Attendant Intercom Selector). The system will automatically assign one of the Auto Intercom buttons on the Auto Intercom Selector to every voice terminal in the system. These buttons allow the attendant to transfer calls easily, and the lights beside the buttons tell the attendant which voice terminals are busy and which message lights are on.
- If your system is set for more than eight lines, you cannot program any Auto Intercom or Manual Signal buttons on a small console.
- You probably want attendant lines to ring immediately when a tail comes in, but there may be exceptions. For example, some people may not want their personal lines answered by someone else. If you do not want the attendant to answer calls on certain lines, set these lines not to ring on the console, or remove those lines from the attendant console.
- If you have more than one attendant, you can assign delayed ring to lines on one attendant console as a backup for the other, and vice versa.
- Someone in your business may have a personal line that doesn't normally ring at the attendant's console. However, that person may want the attendant to answer calls on the personal line when he or she is out of the office. In that case, the attendant needs a Cover button for the voice terminal to which the personal line is assigned. (For more information about Cover buttons, see "Assigning Cover Buttons," page 69.) A Cover button is also necessary if the attendant is expected to cover intercom or transferred calls for anyone.

-
- A loudspeaker paging system or the Group Page feature makes it easy for an attendant to announce calls to people who are not always at the same location. You can set up the system so the attendant can page separate zones independently. For example, a paging system in a medical group shared by several doctors could be set up with one zone covering only those locations specific to a particular doctor, such as a consulting office, lab, and examining room. Similarly, the voice terminals in those same areas could make up a “group” for Group Page. Then, when a call comes in, the attendant can park the call and page the person the call is for without bothering anyone else.
 - You may want to change an attendant console to a non-attendant console if you need an additional voice terminal. Switches B through E on the Processor Module of the control unit represent attendant consoles with intercom numbers 11 through 14. To change the console’s function, set the appropriate switch to Normal (up). Turn the power off and then on again, and administer the console as you would any non-attendant voice terminal.

IMPORTANT: Be aware that *when you change the setting of one of these switches, you erase all system line administration and voice terminal programming that is now in place for that voice terminal.*

Initial Feature Assignments for Small Administrator/Attendant Console*

34-Button Deluxe Voice Terminal

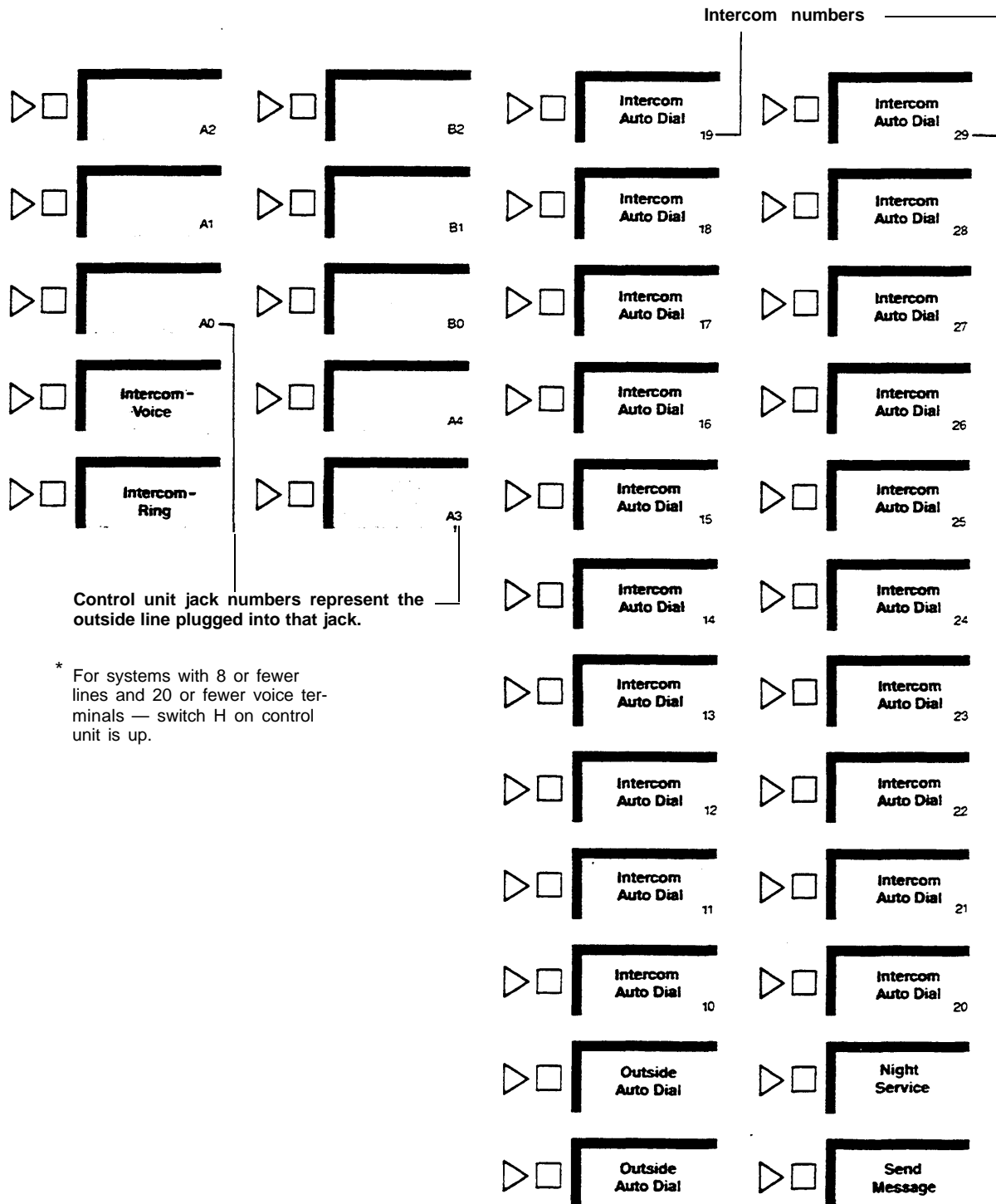

* For systems with 8 or fewer lines and 20 or fewer voice terminals — switch H on control unit is up.

Initial Feature Assignments for Large Administrator/Attendant Console*

34-Button Deluxe Voice Terminal with an Attendant Intercom Selector

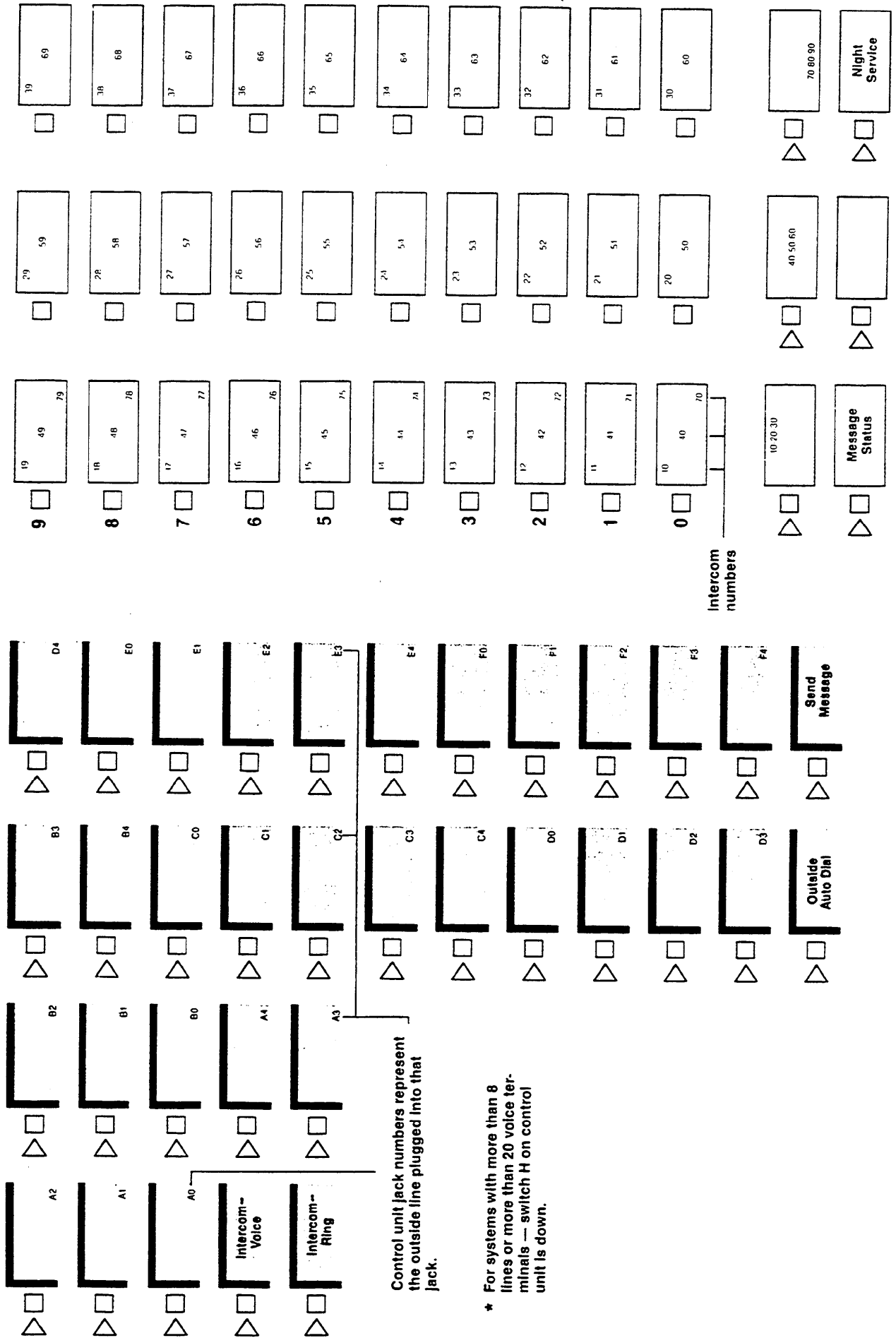

Control unit jack numbers represent the outside line plugged into that jack.

* For systems with more than 8 lines or more than 20 voice terminals — switch H on control unit is down.

Special Information about 5-Button Voice Terminals

Calls can be transferred to a 5-button voice terminal from a line that the voice terminal does not have. You can use either Call Pickup or Line Pickup, depending on whether you know what line the call you want to transfer to the 5-button voice terminal is on.

If you know the line, place the call on hold, page the person or use his or her Auto Intercom button, and announce the call, for example, "Harvey, you have a call from headquarters on line 2." Harvey then uses Line Pickup to take the call.

If you don't know what line the call is on, use Call Park to hold the call, and use Loudspeaker Page or Group Page to announce the call, for example, "Marie, you have a call from headquarters at intercom 17." Marie then uses Call Pickup to take the call.

Special Information about Basic Telephones

If you have basic telephones connected to an Off-Premises Telephone interface, a Basic Telephone and Modem Interface, or a Basic Telephone Module, review the following information before you administer the telephones.

BASIC TELEPHONES CONNECTED TO AN OFF-PREMISES TELEPHONE INTERFACE (OPTI) OR A BASIC TELEPHONE AND MODEM INTERFACE (BTMI)

Follow the procedure below to administer a basic telephone.

1. Enter administration mode by following the boxed instructions on page 25.
2. Assign lines and pools to the intercom number assigned to the OPTI or BTMI by following the instructions in "Setting Up Square Systems," page 27, or "Setting Up Pooled Systems," page 31.
3. If you want to assign call restrictions to an OPTI or BTMI, follow the instructions in "Assigning Call Restrictions to Voice Terminals," page 41.
4. Leave administration mode by following the boxed instructions on page 25.
5. Use Centralized Voice Terminal Programming or connect a MERLIN voice terminal directly to the control unit voice terminal jack to which you plan to connect the OPTI or BTMI to program the terminal.
6. Since basic telephones may not answer voice-announced intercom calls immediately, you must follow the instructions on page 81 to program Voice Announcement Disable. As a result, voice-announced intercom calls to basic telephones become ringing intercom calls.
7. If you want to change the order in which the system selects available lines, follow the instructions on page 67 to assign an Automatic Line Selection sequence to the telephone. *Do not include intercom lines in the sequence.*
8. Set programmable line ringing on lines and line pools as preferred. Remove custom features assigned to buttons above the dial pad.
9. Disconnect the voice terminal or leave Centralized Voice Terminal Programming and connect the OPTI or BTMI to the same voice terminal jack.
10. Connect the basic telephone to the OPTI or to the BTMI.
11. If you later add or change the features assigned to a basic telephone, inform the person using the OPTI or BTMI.

Users dial the following codes to place calls on a basic telephone connected to an OPTI or BTMI:

- To get Automatic Line Selection, dial 9.
- To place a ringing intercom call, dial the 2-digit intercom number.
- To place a voice-announced intercom call, dial 881 and the 2-digit intercom number.
- To access the lines or line pools assigned to particular buttons above the dial pad on the voice terminal associated with the user's OPTI or BTM intercom number, dial the codes shown in the illustrations on the following page.

Dial Codes to Access Lines, Pools, and Intercom Features Assigned to Voice Terminal Buttons

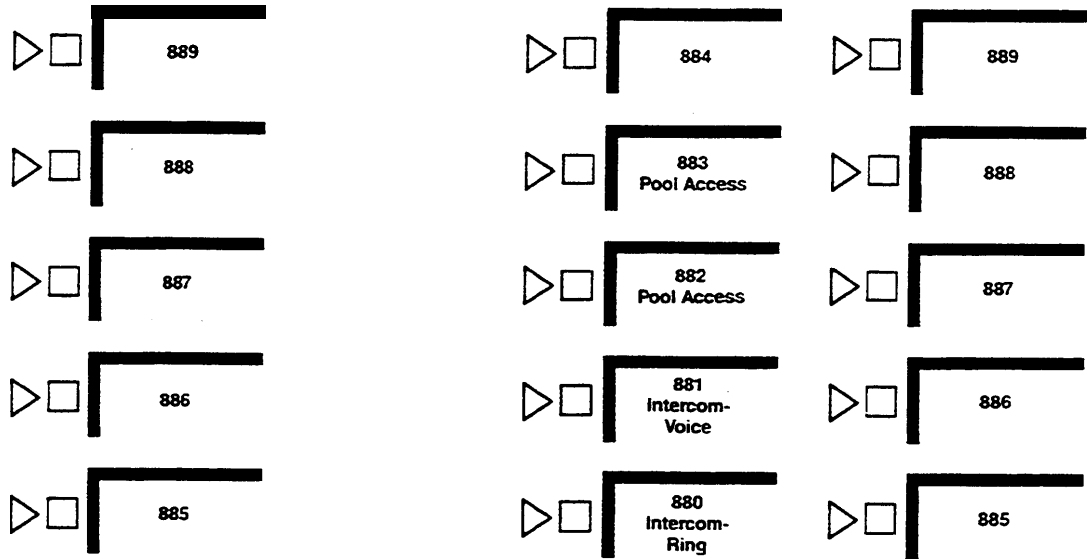

SQUARE SYSTEMS

POOLED SYSTEMS WITH DIAL ACCESS TO LINE POOLS

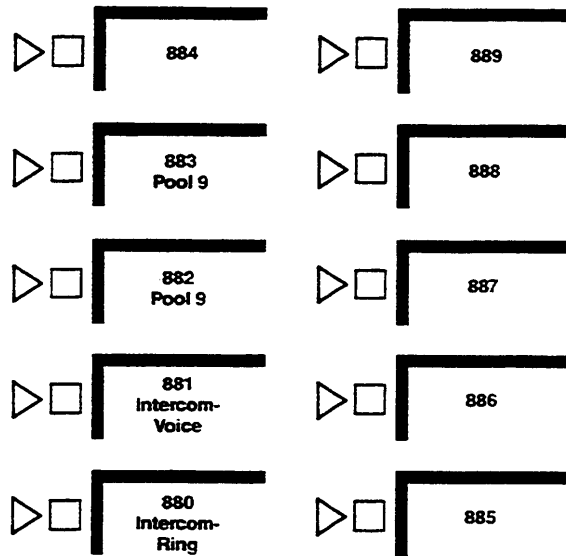

POOLED SYSTEMS WITH BUTTON ACCESS TO LINE POOLS

BASIC TELEPHONES CONNECTED TO A BASIC TELEPHONE MODULE

- **If you have a square system, People with basic telephones get an outside line by dialing 88. The system automatically selects an available line from among those you've assigned to that telephone. Be sure to assign interchangeable lines.**
- **If you have a pooled system, you can follow the procedures on pages 37 and 38 to assign basic telephones button Access to Line Pools or Dial Access to Line Pools.**
- **If your system has Button Access to Line Pools, people with basic telephones dial 9 to access the main pool. If you assign additional lines to their telephones, these people dial 88 to access an available line assigned to that telephone. Be sure to assign interchangeable lines.**
- **If your system has Dial Access to Line Pools, people with basic telephones access pools by dialing 9 and then a pool access code. For example, to access the main pool (access code 9), people dial 9 and then dial 9 again. If they want to access a different pool (for instance, the one with access code 891), they dial 9 and then dial 891. If your system uses Automatic Route Selection, however, people with basic telephones simply dial 9 and then dial the telephone number desired.**
- **If you assign additional lines to basic telephones, users dial 88 to access an available line assigned to that telephone. Be sure to assign interchangeable lines.**
- **Once you have assigned lines and line pools to a basic telephone, be sure to provide the person using the telephone with a list of codes for the lines and line pools to which he or she has access.**
- **The attendant can use Centralized Voice Terminal Programming to program Personal Speed Dial for basic telephone. The user accesses this feature using the Speed Dial codes listed on page 77.**

If you want to assign call restrictions to a basic telephone, follow the instructions in "Assigning Call Restrictions to Voice Terminals," page 41.

MERLIN System Features

Your MERLIN system offers features that provide exceptional telephone service on both a businesswide and a personal basis. As system administrator, you make decisions about how the system operates as a whole and about which features should appear at each voice terminal. The chart on the next few pages describes all the features available to your system and suggests ways to use some of these features. It should help you decide which features are best for your business. The features are grouped alphabetically in three categories:

- **Fixed Features** are built into the system and require no programming. Fixed features associated with factory-labeled buttons appear in bold type in the chart.
- **Custom Features** can be changed according to company priorities and personal needs. Those that you, the system administrator, must assign are coded with the symbol [A] in the chart. Those that individuals may assign to their own voice terminals are coded with the symbol [I] . Features coded with [AI] may be assigned by individuals, but you may want to approve such assignments to ensure that they meet the overall needs of your business.
A page number under the name of each feature marked with an [A] tells you where you will find instructions on assigning the feature.
- **Optional Features** require the purchase of additional equipment.

The system comes ready to use with certain custom features in place on all voice terminals (see the initial feature assignments, pages 63 through 65). Since no two businesses are alike, however, you may want to change some or all feature assignments. You can change any custom feature by following the appropriate set of steps in this manual.

Fixed Features

Feature	Description
Call Park (See also Loudspeaker Page.)	Put a call on a special kind of hold so the call can be picked up at any voice terminal. <ul style="list-style-type: none"> • Using Call Park, an attendant trying to locate someone can park a call and page the person. The person can take the call at any voice terminal using the Line Pickup or Call Pickup feature.
Call Pickup (See also Call Park, Loudspeaker Page, Night Service.)	Answer a call for one voice terminal from another voice terminal. This feature can be programmed onto a button at any voice terminal. <ul style="list-style-type: none"> • Answer another person's voice terminal without leaving your desk. • Use this feature to retrieve parked and held calls and to pick up Night Service calls.
Call Waiting	When you are busy with a call, listen for a brief ring or voice announcement from your speaker and watch for a flashing greenlight that tells you a call is ringing on another line at your voice terminal.
Conference	Make conference tails that include as many as five people-the originator of the call, two people on intercom lines, and two people on outside lines. <ul style="list-style-type: none"> • Conference the calling person to someone outside the system, put the call on hold, and be free to do other business. • Make long distance calls from outside by calling your office and being conference to a WATS line.
Distinctive Ringing	Hear different ringing patterns for outside, transferred, and intercom calls. <ul style="list-style-type: none"> • identify the type of call and answer it accordingly.
Drop	Disconnect one person at a time from a conference call, or drop a busy or unanswered line when you are trying to set up a conference call.
Group Listening Speaker (See also Hands-Free Unit.)	Let others in the room hear a caller through your voice terminal's speaker.
Hold (See also Music-on-Hold.) Automatic Hold Release Automatic Hold Reminder	Keep someone on the line so you can answer a second tail or attend to another matter. The green light next to the line button holding your call flashes rapidly. The green lights next to line buttons on which others are holding tails flash at a slower rate. Know immediately when a person on hold hangs up because the greenlight next to the line button goes off. Hear a brief ring once every minute when you have a call on hold.
Intercom Intercom-Ring Intercom-Voice (See also Voice Announcement Disable.)	Call people in your business using 2-digit numbers. <ul style="list-style-type: none"> • Signal others by ringing or voice announcement without cutting off your active tails or theirs. Intercom tail comes in with a distinctive ring. Make or receive short announcements using a MERLIN system voice terminal. <ul style="list-style-type: none"> • Announce calls before transferring them.
Line Pickup	Answer a tail on a specific line that is ringing, parked, or on hold at one voice terminal by picking up the line at another voice terminal or the attendant console. This feature can be programmed onto a button at any voice terminal.
Line Request	Request a busy line, and receive a signal when the line becomes available.
Message Waiting (See also Send Message.)	See a green light beside Message when your system attendant has a message for you.

Fixed Features (continued)

Feature	Description
Monitor-on-Hold Speaker	Use your voice terminal's speaker to listen for a caller to return when you've been put on hold. <ul style="list-style-type: none"> • Frees you to do other work when you've been put on hold.
On-Hook Dialing Speaker (See also Hands-Free Unit.)	Turn on the speaker and dial an outside or intercom call without lifting the handset.
Recall	Touch Recall instead of pressing the switchhook to access PBX, Centrex, or Custom Calling features. If your MERLIN system isn't connected to a PBX or Centrex system, and if you aren't using a Custom Calling feature, use Recall to disconnect a call without hanging up your handset.
Ringing Line Selection	Answer a call without touching any buttons because your MERLIN system automatically selects the ringing line when a call comes in.
Send Message	If you're an attendant, notify a person that a message is waiting by touching Send Message.
Transfer Transfer Return	Pass outside calls to any voice terminal in your MERLIN system. Transfer calls with or without an intercom announcement. <ul style="list-style-type: none"> • Attendants can screen calls on intercom as part of transfer. <p>Hear unanswered transferred calls ring again at the voice terminal from which they were transferred.</p> <ul style="list-style-type: none"> • Transferred calls are not lost.
Voice Terminal Programming	Program voice terminals with custom features according to business and individual needs.
Voice Terminal Testing	Determine whether all lights and ringing mechanisms are working by sliding the T/P switch on the left side of the voice terminal to the T position.
Volume Control	Adjust the sound level of a voice terminal's ring and speaker.

Custom Features

Feature	Description
Account Number Entry (used with SMDR only) [I]	Use this feature to associate an account code with outside calls made or received. <ul style="list-style-type: none"> • Increase accuracy of call records. • Assure that charges for outside calls are billed to the appropriate account, job, or department.
Auto Intercom [I] One-Touch Transfer	Program buttons on voice terminals for one-touch dialing of frequently called intercom numbers. <ul style="list-style-type: none"> • Look at the lights next to the buttons to see if someone is using his or her voice terminal; the green light goes on when the person is on a call or is using the Do Not Disturb feature. Transfer a call by touching the appropriate Auto Intercom button. <ul style="list-style-type: none"> • Transfer calls with one touch.
Automatic Line Selection [A]	Get an available line when you lift your handset to make a call. Anyone can program a voice terminal to select lines in a specific order. <ul style="list-style-type: none"> • Program voice terminals to select long distance lines in the most economical order—for example, WATS line first, then regular service.
Automatic Route Selection [A]	Set up your system so that each time a person makes an outside call, the system selects a line pool that includes the most appropriate lines for that call. For this feature to operate, switch F on the control unit must be set to <i>Pooled</i> (up) and switch G must be set to <i>Dial Access</i> (up). <ul style="list-style-type: none"> • Increase voice terminal efficiency and reduce costs for your business. • Eliminate dialing of pool numbers.
Button Access to Line Pools [A]	Assign line pools to individual buttons. <ul style="list-style-type: none"> • Access a pool simply by touching a button.
Call Coverage (See also Programmable Line Ringing.) [A] Primary Coverage Secondary Coverage Coverage inhibit Call Forwarding Using Coverage inhibit	Program buttons on voice terminals to cover calls for people with whom you do not share lines. Program buttons for either primary or secondary coverage and for immediate, delayed, or no ring. <ul style="list-style-type: none"> • Have as many as six Cover buttons. Assign to someone who screens or answers another person's calls. <ul style="list-style-type: none"> • A secretary can answer all calls to a manager's voice terminal. Assign to someone who provides a second backup for a covered voice terminal. <ul style="list-style-type: none"> • A second secretary can answer the manager's calls when the first secretary is away from the desk. Program buttons on voice terminals to turn off Call Coverage temporarily. <ul style="list-style-type: none"> • Limits use of Call Coverage to times when it is needed. Program a Cover button on another voice terminal and then program a Coverage Inhibit button on your own voice terminal to stop coverage whenever appropriate. <ul style="list-style-type: none"> • Have calls ring at a voice terminal in a different location when necessary.

* [A] means that the administrator assigns the feature.

[I] means that the individual can assign the feature.

[A] means that an individual can assign the feature with the administrator's approval.

Custom Features (continued)

Feature*	Description
<p>Call Restriction (See page 41.)</p> <p>[A]</p> <p>Outward Call Restriction</p> <p>Toll Call Restriction</p> <p>Allowed-List Call Restriction</p>	<p>Assign call restrictions to any voice terminal as necessary.</p> <ul style="list-style-type: none"> • Restrict voice terminals according to your business needs. <p>Restrict some voice terminals to intercom calls only.</p> <ul style="list-style-type: none"> • Restrict voice terminals in public places such as lobbies. <p>Restrict voice terminals to intercom and local calls only.</p> <ul style="list-style-type: none"> • Prevent abuse of telephone privileges. <p>Allow toll-restricted voice terminals to make toll calls to a specific list of area codes and/or exchanges. Allow outward-restricted voice terminals to make local and toll calls.</p> <ul style="list-style-type: none"> • Control telephone costs.
<p>Centralized Voice Terminal Programming</p> <p>[A]</p>	<p>Program any voice terminal from the administrator/attendant console.</p> <ul style="list-style-type: none"> • Conveniently program voice terminals for people who do not do their own programming. • Program voice terminals for business priorities without leaving the administrator/attendant console.
<p>Dial Access to Line Pools (See page 38.)</p> <p>[A]</p>	<p>Assign all line pools to two buttons on each voice terminal, then access the pools using dial codes.</p> <ul style="list-style-type: none"> • Have access to as many as 11 line pools using only two buttons on a voice terminal. • Save buttons on voice terminals for other features.
<p>Dial Access to Line Pools Restriction</p>	<p>Restrict some voice terminals from dial access to certain line pools. People using these voice terminals, however may receive transferred calls on lines in these pools.</p> <ul style="list-style-type: none"> • Restrict voice terminals used by people who have no need to make WATS line or Foreign Exchange calls.
<p>Do Not Disturb</p> <p>[I]</p>	<p>Prevent a voice terminal from ringing for a temporary period. While Do Not Disturb is in effect, outside tails ring at the attendant console, intercom callers get a busy signal, and the green light goes on next to the Auto Intercom button representing the voice terminal on the attendant console.</p> <ul style="list-style-type: none"> • Avoid being interrupted by ringing calls.
<p>Group Page (See page 55.)</p> <p>[A]</p>	<p>Assign voice terminals to paging groups so that people can page each other through voice terminal speakers.</p> <ul style="list-style-type: none"> • You do not need a loudspeaker paging system to use this feature.
<p>Last Number Redial</p> <p>[I]</p>	<p>Program a button for one-touch dialing of the last number you called. People having 5- or 10-button voice terminals can use this feature by dialing #24.</p>
<p>Line and Pool Assignment to Voice Terminals (See pages 27 through 36.)</p> <p>[A]</p>	<p>Assign any combination of pooled, personal, and special-purpose lines to any voice terminal.</p> <ul style="list-style-type: none"> • Customize line assignments to control costs. • Reassign lines easily.
<p>Manual Signaling</p> <p>[I]</p>	<p>Program a button so that touching it causes a beep at another voice terminal.</p> <ul style="list-style-type: none"> • Use the button to signal another person.

* [A] means that the administrator assigns the feature.

[I] means that the individual can assign the feature.

[AI] means that an individual can assign the feature with the administrator's approval.

Custom Features (continued)

Feature*	Description
Multiple Line Pools (See pages 31 and 32.) [A]	Assign outside lines to different line pools so that lines that provide the same service are pooled together. Your business may have up to 11 line pools. <ul style="list-style-type: none"> • Assign regular lines to one pool, WATS lines to another pool, and so on.
Outside Auto Dial [I]	Program buttons for one-touch dialing of frequently dialed account codes or outside telephone numbers.
Personal Speed Dial [A]	For 5- and 10-button voice terminals only. Assign a 3-character Personal Speed Dial code to each account number or telephone number you frequently dial. Then use a Personal Speed Dial code whenever you want to dial any of those numbers. Each person assigns Personal Speed Dial codes for use at his or her voice terminal only. <ul style="list-style-type: none"> • Use Personal Speed Dial codes when your voice terminal doesn't have room for many Outside Auto Dial buttons.
Personalized Ring (See page 80.) [I]	Select one of eight ringing signals for your voice terminal. <ul style="list-style-type: none"> • Distinguish the ringing of your voice terminal from that of others.
Privacy [I]	Prevent others from joining calls on a personal line or a shared line in a square system.
Programmable Line Ringing (See also Call Coverage.) [A]	Program outside line buttons, pool buttons, and cover buttons to ring immediately, after a delay, or not at all for incoming calls. This does not apply to transferred or intercom calls. <ul style="list-style-type: none"> • Program voice terminals in lobbies and conference rooms not to ring.
Saved Number Redial [I]	Store a dialed number for later one-touch dialing. The stored number remains the same until replaced with another number. A person can make other calls and then redial the saved number by touching the Saved Number button. People having 5- or 10-button voice terminals can use this feature by dialing the 3-character code #23. Any voice terminal may have more than one Saved Number button.
System Speed Dial (See page 57.) [A]	Assign System Speed Dial codes to a maximum of 40 telephone numbers. Codes are stored so that people throughout your business can dial them at any voice terminal. <ul style="list-style-type: none"> • Assign codes to frequently dialed numbers, such as the numbers of your branch offices. • Assign codes to numbers that you may not want everyone in your business to know.
Touch-Tone Enable [I]	Adjust the system to temporarily generate Touch-Tone signals when connected to lines that carry rotary signals. <ul style="list-style-type: none"> • If your business is hooked up to rotary lines, use alternate long distance service, banking-by-phone, credit card authorization, and other electronic services that require Touch-Tone dialing.
Touch-Tone/Rotary Option (See page 26.) [A]	Adjust the system to work with either Touch-Tone or rotary lines or both. <ul style="list-style-type: none"> • Keep your system flexible-connect some voice terminals to Touch-Tone lines, others to rotary lines, if necessary.
Voice Announcement Disable [A]	Program voice terminals to block intercom voice announcements and to ring instead to signal intercom calls. <ul style="list-style-type: none"> • Program this feature on voice terminals in public places such as lobbies and conference rooms.

* [A] means that the administrator assigns the feature.

[I] means that the individual can assign the feature.

[A] means that an individual can assign the feature with the administrator's approval.

Optional Features

Feature	Description
<p>Extra Alert (See also Night Service.)</p> <p>Required equipment:</p> <ul style="list-style-type: none"> • Services Module in control unit • Extra-alerting devices 	<p>Provide audible or visual signal by means of alerting devices such as bells, horns, or strobe lights. The system can accommodate alerting devices in up to three different areas of the building. Your business must supply alerting devices.</p> <ul style="list-style-type: none"> • People in noisy areas can better tell when a call is ringing. • Use with Night Service to alert people who are working late to pick up incoming calls by means of Call Pickup.
<p>Loudspeaker Page</p> <p>Required equipment:</p> <ul style="list-style-type: none"> • Services Module in control unit • Loudspeaker paging system 	<p>People can page each other using a loudspeaker paging system. The MERLIN system can accommodate up to three zones that can be paged individually or together. Your business must provide the paging system.</p> <ul style="list-style-type: none"> • People can quickly locate others who are away from their desk or work areas. • Provide background music throughout your office or plant.
<p>Music-on-Hold</p> <p>Required equipment:</p> <ul style="list-style-type: none"> • Services Module in control unit • Music source 	<p>Provide callers with music when they are put on hold. Your business provides the music source (for example, a tape player or FM radio).</p> <ul style="list-style-type: none"> • Reassure callers that they have not been disconnected when they are on hold.
<p>Night Service (See page 56.)</p> <p>(See also Extra Alert.)</p>	<p>Provide extra alert in up to three different areas of your office or plant after hours when no attendant is on duty. Use a button on the attendant console to turn this feature on and off.</p> <ul style="list-style-type: none"> • Alert people who are working late to incoming calls that ring in only one place, such as the attendant console. They can use the Call Pickup feature to answer incoming calls from any location.
<p>Simultaneous Voice and Data Calls</p> <p>Required equipment:</p> <ul style="list-style-type: none"> • General Purpose Adapter 	<p>Make voice and data calls at the same time.</p> <ul style="list-style-type: none"> • Obtain data from a computer while you are on the telephone. • Make a voice call while you are sending data to someone outside your business.

Appendix: System and Voice Terminal Configuration Forms

This brief guide helps you decide how to set up your MERLIN™ communications system (Models 1030 and 3070, with Feature Module 4) to satisfy the needs of your business. Read through this guide and answer the questions as you come to them. Boxed instructions help you fill out a System Configuration Form (page 106) and a Voice Terminal Configuration Form (pages 107 through 109) for each voice terminal in your system. You need these forms and the administration manual to customize your MERLIN system.

SYSTEM OPTIONS

The following questions help you fill out the System Configuration Form. Complete this form before filling out any Voice Terminal Configuration Forms.

- 1a. How many voice terminals are connected to your MERLIN system? _____
- 1b. How many additional voice terminals do you plan to add during the next year? _____
- 1c. Total number of voice terminals (#1a + #1b): _____
- 2a. How many outside lines does your system control? _____
- 2b. How many outside lines do you plan to add during the next year? _____
- 2c. Total number of outside lines (#2a + #2b): _____
3. Now add the total number of voice terminals (#1c) to the total number of lines (#2c): _____

A.

System Size

If the answer to #2c is greater than 8, or if the answer to #3 is greater than 30, check "Large" on the System Configuration Form. Otherwise, check "Small."

4. What sort of telephone system are the people in your system accustomed to using?
- Key System (a system, such as COM-KEY® or 1A2 Key, where each line appears on a separate button at each telephone) _____
- Non-Key System (a system, such as Horizon®, with many lines available through a few System Access or Trunk Access buttons or with basic telephones that each have their own line) _____
5. Do you want Automatic Route Selection (ARS)? ARS allows you to program your system to automatically select the least expensive and best available route for each outside call. You provide the system with the information it needs to make economical routing decisions. Otherwise, you can have individuals select the appropriate type of line.
- Yes _____
- No _____

B-1

Line Representation

If the answer to #5 is yes, then check "Pooled" and "Dial Access + ARS" on the System Configuration Form and skip to #9.

6. Did you order any 5-button voice terminals that need to handle calls on more than three outside lines, or any 10-button or 34-button voice terminals that need to handle calls on more than eight outside lines?

Yes _____

No _____

B-2

Line Representation

If the answer to #6 is no and the answer to #4 is Key, check "Square" for the type of line representation on the System Configuration Form and skip to #9.

7. Did you order any 5-button voice terminals that need to handle calls on more than two types of lines (for example, local lines and personal lines), or any 10-button or 34-button voice terminals that need to handle calls on more than seven types of lines?

Yes _____

No _____

B-3

Line Representation

If the answer to #7 is yes, check "Pooled" and "Dial Access" on the System Configuration Form and skip to #9.

8. Circle A or B. Would you rather:

- A. Dial an access code (for example, 9) to get a line, leaving more buttons available for features.
- B. Dedicate one button to each line or group of lines, making it unnecessary to dial an access code.

C.

Access to Pooled Line Representation

If the answer to #8 is A, check "Dial Access" as the type of pool access on the System Configuration Form. If the answer to #8 is B, check "Button Access" as the type of pool access.

9. How many attendant consoles did you order (to be used for answering and transferring calls coming into your business, or for monitoring call traffic)? _____

D.

Attendant Configuration

On the System Configuration Form, if the answer to #9 is 1 or 0, don't check any of the attendant configuration boxes. If the answer to #9 is 2, check the box next to "11" for attendant configuration. If the answer to #9 is 3, check the boxes beside "11" and "12." If the answer to #9 is 4, check the boxes beside "11," "12," and "13." If the answer to #9 is 5, check the boxes beside "11," "12," "13," and "14." The system supports a maximum of five attendant positions.

E.

Listing Telephone Numbers

In the column labeled "Telephone Number" on the System Configuration Form, list the telephone numbers for your outside lines. Start at the top of the column and work down without skipping any spaces. The order in which you list lines determines the order in which lines appear initially on attendant consoles and on all voice terminals in systems with square line representation. Group lines of the same type together (for example, group WATS lines together, FX lines together, etc.).

F.

Special Lines

Indicate which lines are special-purpose lines (for example, WATS, Foreign Exchange, personal lines, outward calls only, incoming calls only).

NOTE: If you checked "Square" for line representation, skip to question #10.

G.

Assigning Lines to Pools

Now consider any groups of lines that can be used interchangeably for placing calls (for example, all regular local lines or all in-state WATS lines). Assign the access code 9 to the pool that contains your group of local lines—write "9" for "Pool Number" on the System Configuration Form. Assign a pool number (890 through 899) to each of the other groups of lines. Note that each pool can have as many or as few lines as you like but that each line can be in only one pool. (For a more detailed explanation, see page 31.)

10. Is it necessary to dial 0 or 1 to place long distance calls on any of your lines?

Yes _____

No _____

H.

Toll Environment

For each line that does not require dialing 0 or 1 before placing long distance calls, check "Area Code Only" on the System Configuration Form.

I. Rotary Lines
If you have any rotary outside lines, circle the “r” next to each line on the System Configuration Form. If you aren’t sure if you have rotary or Touch-Tone lines, call your local telephone company.

J. Night Service
If your system will have an extra-alerting device, check “Night Ring” on the System Configuration Form to indicate which lines will activate this device when the person who usually answers calls is not available. If you have more than one extra-alerting device, indicate on the form which device will be activated by which lines. (For a more detailed explanation, see page 56.)

K. SMDR Options
If your system will use SMDR (Station Message Detail Recording) to keep a record of calls, fill in the minimum length of calls to be recorded. (If you don’t specify a minimum call length, the system doesn’t record calls that last less than 1 minute.) If you want to record all calls, enter “O.” Also indicate whether or not the system should record incoming calls. (For a more detailed explanation, see page 60.)

L. System Speed Dial Numbers
If you want to store numbers that anyone in your business can dial using a 3-character code, fill in these numbers on the System Speed Dial Directory, page 110. You can associate up to 40 digits and special characters, including pause (p), recall (r), and Touch-Tone Enable (t), with each System Speed Dial code. (For a more detailed explanation, see page 57.)

M. Group Page Groups
If you plan to use the Group Page feature, which allows people to receive paging messages through their voice terminal speakers, you need to assign intercom numbers to Group Page groups. On the Group Page Directory, page 111, fill in the intercom numbers and names of people designated for each group. You may establish up to seven groups, each covering a maximum of ten people. (For a more detailed explanation, see page 55.)

N.

Allowed Lists

if you need to restrict the numbers that certain people can call, but you want them to be able to call some specific area codes or exchanges for business reasons, list the allowed area codes and exchanges on the Allowed-List Directory, page 112. Each entry can have up to six digits (for example, an area code followed by an exchange). You may create up to eight lists, each containing a maximum of ten allowed numbers. (For a more detailed explanation, see page 44.)

NOTE: If you decided not to use Automatic Route Selection, skip to the next section, entitled "Voice Terminal Options."

O.

Automatic Route Selection

For a detailed explanation of this feature, see page 46. If you plan to use Automatic Route Selection, you need to fill out the "Automatic Route Selection Table" on pages 113 through 115. (You can fill out up to eight tables, numbered 0-7.)

1. Fill in a group of area codes or exchanges to which calls could be routed through the same set of pools. (For example, if you decide that Northeastern WATS lines are the least expensive way of calling people in the northeastern states, then you might list the most frequently used area codes in the northeastern United States that could be accessed using the WATS lines.) You can list up to ten area codes or exchanges on a table. If you need to list more than ten, use a second table.

NOTE: it does not matter in which order you list these area codes or exchanges.
2. Beginning with entry 0 in the portion of the table labeled "Pool," list the 3-digit (890-899) pool number for the pool you have chosen for making these calls. (For example, you might fill in the pool number for the pool containing the Northeastern WATS lines.)
3. If any extra digits need to be automatically inserted when using this pool, list these after the pool number under the heading "Other Digits." (For example, alternate long distance companies may require special dialing codes or account numbers.)
4. In case the pool that you have listed as your first choice is busy, list possible backup routes as Pool entries 1,2,3,4, and 5. (For example, after you have listed the pool number for the pool containing the Northeastern WATS lines, you would then list the next least expensive way of calling that area, for instance, the pool number for the pool containing local lines by which you could call people in the northeastern United States.)
5. Fill in one table for each group of area codes or exchanges.
6. Use the "Default Toll Table," Table 8, to record route selections for all toll calls to area codes not already included in a table (those with "1" dialed as a prefix) that people in your business might make.
7. Use the "Default Local Table," Table 9, to record route selections for local calls to exchanges not included in a table that people in your business might make.
8. The "Special Numbers Table" is used for routing the following numbers: 0, 411, 611, 911, 800, and 900. If you must dial an access code to make operator-assisted calls, use this table to list the access code.

VOICE TERMINAL OPTIONS

Now that you've completed the System Configuration Form, begin filling out Voice Terminal Configuration Forms, one for each voice terminal in your system. You may want to begin by creating a system directory and planning which intercom number and which type of voice terminal each person will use. (The form for the system directory should have been provided with your equipment.)

On pages 107 through 109, there are forms for voice terminals in square systems and pooled systems, and for attendant consoles. Make copies of these forms so you can fill out an appropriate form for each of your voice terminals (since some of the forms are for pooled systems and some are for square systems, be sure you copy the ones that are appropriate for your system).

P.

Basic Information

Fill in an intercom number (10 through 39 for Model 1030, 10 through 79 for Model 3070) and the user's name. Fill out a form for intercom 10 first (this should be your primary attendant's console; refer to your System Configuration Form for the intercom numbers for additional attendant consoles), then fill out forms for remaining intercoms in numerical order without skipping numbers. On each Voice Terminal Configuration form, check the appropriate boxes to indicate voice terminal size, the type of voice terminal stand, and the type of accessories used with the voice terminal. Group basic telephones together (for example, reserve intercom numbers 60 through 69 for basic telephones) and use remaining intercom numbers for MERLIN system voice terminals.

Q.

Assigning Lines (Pooled Systems)

If you have a square system or if the voice terminal serves as an attendant console, skip to box S. For voice terminals in pooled systems, the first two buttons above the intercom buttons will be used for Dial Access to Line Pools or for Button Access to the main pool (access code 9). Assign any additional lines or pools to separate buttons. Remember not to assign lines or pools to buttons in the columns to the right of the dial pad on 34-button voice terminals, since these buttons do not have lights. Write the line or pool numbers or names in the numbered buttons on the Voice Terminal Configuration Form. Fill in the button labeled "1" first, then "2," "3," and so on.

R.

Dial Access to Line Pools

If you selected the Dial Access to Line Pools option, and the person using a particular voice terminal will use dial codes to select lines, list the dial codes in the lower left of the Voice Terminal Configuration Form. Refer to the System Configuration Form to check which lines are assigned to line pools.

S. Assigning Lines (Attendant Consoles and Square Systems)

Although you can assign lines to whichever buttons you choose, there are several ways in which you can assign lines to make your system more easily administered and used. Assign identical line arrangements to all voice terminals in a standard square system (or to all attendant consoles, in any system). Also, if it is convenient, have lines appear on voice terminals in the same order as they are connected to the control unit. Once you have decided on line assignments, write telephone numbers on available line buttons.

T. Call Coverage

If a voice terminal needs to cover calls to another voice terminal, write "Cover" and the name or intercom number of the person whose calls are to be covered on an available button (one that is not already a line or intercom button). Use only a button with lights next to it. Also assign an Auto Intercom button for each person to be covered and label the button with the person's name. These buttons should have lights. Check the initial feature assignments (pages 63 through 65) to see if there is a feature there that you can replace with Call Coverage.

U. Automatic Answering

If a voice terminal has a Hands-Free Unit, write "Auto Answer-Intercom" on an available button with lights on the Voice Terminal Configuration Form. If a voice terminal has a General Purpose Adapter, write "Auto Answer-Outside" on an available button with lights on the form.

V. Assign Other Features to Buttons

Review the initial features assignment diagram (pages 63 through 65). Unless you have replaced the initial features with other features, copy the feature names onto the appropriate button label on the Voice Terminal Configuration Form.

W. Line Ringing

Of the lines assigned to the voice terminal, determine which ones should ring immediately at the voice terminal, which should ring after a delay (so that calls ring only if the person who usually answers is unavailable), and which should not ring at all. Indicate the type of line ringing on the Voice Terminal Configuration Form by writing next to each line button "R" for immediate ringing, or "D" for delayed ringing after two rings. Similarly, indicate whether cover buttons should ring immediately ("R"), after a 2-ring delay ("D"), or after a 4-ring delay ("DD"). If a line shouldn't ring at the voice terminal, leave the space next to its button blank. Calls transferred on this line will still ring.

X.

Calling Restrictions

If the voice terminal should be restricted from making toll (long distance) calls, check “Toll Call Restriction” on the Voice Terminal Configuration Form. If the voice terminal should be restricted from making any outside calls, check “Outside Call Restriction.” (For a more detailed explanation, see page 41.)

Y.

Allowed-List Assignment

If you are assigning one or more allowed lists (lists of area codes and/or exchanges that people with restricted voice terminals can call) to the voice terminal, record the numbers of the lists on the Voice Terminal Configuration Form. (For a more detailed explanation, see page 44.)

Z.

Automatic Line Selection

If lines don't appear on the voice terminal in the order in which they are most likely to be used, list them in the appropriate order under “Automatic Line Selection” on the Voice Terminal Configuration Form. (For a more detailed explanation, see page 67.)

Return to box P and repeat this process for each voice terminal in your system.

System Configuration Form for Model 1030 and 3070

System Size:

- Small (1-8 Lines)
 Large (> 8 Lines)

Line Representation:

- Square Pooled
 Dial Access
 Button Access
 Dial Access + ARS

Attendant Configuration:

- 11 12 13 14

SMDR Options:

- Minimum length of calls recorded (minutes): _____
 Incoming calls recorded? (Y/N) _____

Telephone Number	Control Unit Jack Number	Line code Number	Special Line Type?	Pool Number (9, 890-899)	Check if Area Code Only	Circle if Rotary	Check if Night Ring
	A0	01				r	
	A1	02				r	
	A2	03				r	
	A3	04				r	
	A4	05				r	
	B0	06				r	
	61	07				r	
	B2	08				r	
	B3	09				r	
	B4	10				r	
	C0	11				r	
	C1	12				r	
	C2	13				r	
	C3	14				r	
	C4	15				r	
	D0	16				r	
	D1	17				r	
	D2	18				r	
	D3	19				r	
	D4	20				r	
	E0	21				r	
	E1	22				r	
	E2	23				r	
	E3	24				r	
	E4	25				r	
	F0	26				r	
	F1	27				r	
	F2	28				r	
	F3	29				r	
	F4	30				r	

Voice Terminal Configuration Form for Models 1030 and 3070 Attendant Consoles

Intercom # _____

Identification _____

Stand Type:

- Wall
- Plastic
- Fixed
- Desk
- Metal
- Adjustable

Accessories:

- General Purpose Adapter
- Headset
- Headset Adapter
- Hands-Free Unit
- Extra Long Cord

- Acoustic Coupler Adapter
- Hearing-Impaired Handset
- Push-to-Listen Handset
- Voice Terminal Power Supply
- Attendant Intercom Selector

34-Button

<input type="checkbox"/> A2	<input type="checkbox"/> B2	<input type="checkbox"/> B3	<input type="checkbox"/> D4
<input type="checkbox"/> A1	<input type="checkbox"/> B1	<input type="checkbox"/> B4	<input type="checkbox"/> E0
<input type="checkbox"/> A0	<input type="checkbox"/> B0	<input type="checkbox"/> C0	<input type="checkbox"/> E1
<input type="checkbox"/> Intercom - Voice	<input type="checkbox"/> A4	<input type="checkbox"/> C1	<input type="checkbox"/> E2
<input type="checkbox"/> Intercom - Ring	<input type="checkbox"/> A3	<input type="checkbox"/> C2	<input type="checkbox"/> E3
		<input type="checkbox"/> C3	<input type="checkbox"/> E4
		<input type="checkbox"/> C4	<input type="checkbox"/> F0
		<input type="checkbox"/> D0	<input type="checkbox"/> F1
		<input type="checkbox"/> D1	<input type="checkbox"/> F2
		<input type="checkbox"/> D2	<input type="checkbox"/> F3
		<input type="checkbox"/> D3	<input type="checkbox"/> F4
		<input type="checkbox"/>	<input type="checkbox"/>

Calling Restriction:

- Toll Call Restriction
- Outside Call Restriction

Allowed-List Numbers (0-7):

Automatic Line Selection:

Voice Terminal Configuration Form for Models 1030 and 3070 Non-attendant Voice Terminals (Square Systems)

Intercom # _____ Identification _____

Voice Terminal Size:

- 5-Button
- 10-Button
- 34-Button
- 34-Button Deluxe
- Basic Touch-Tone or
- Rotary Telephone

Stand Type:

- Wall
- Plastic
- Fixed
- Desk
- Metal
- Adjustable

Accessories:

- General Purpose Adapter
- Headset
- Headset Adapter
- Hands-Free Unit
- Extra Long Cord
- Acoustic Coupler Adapter
- Hearing-Impaired Handset
- Push-to-Listen Handset
- Voice Terminal Power Supply
- Attendant Intercom Selector

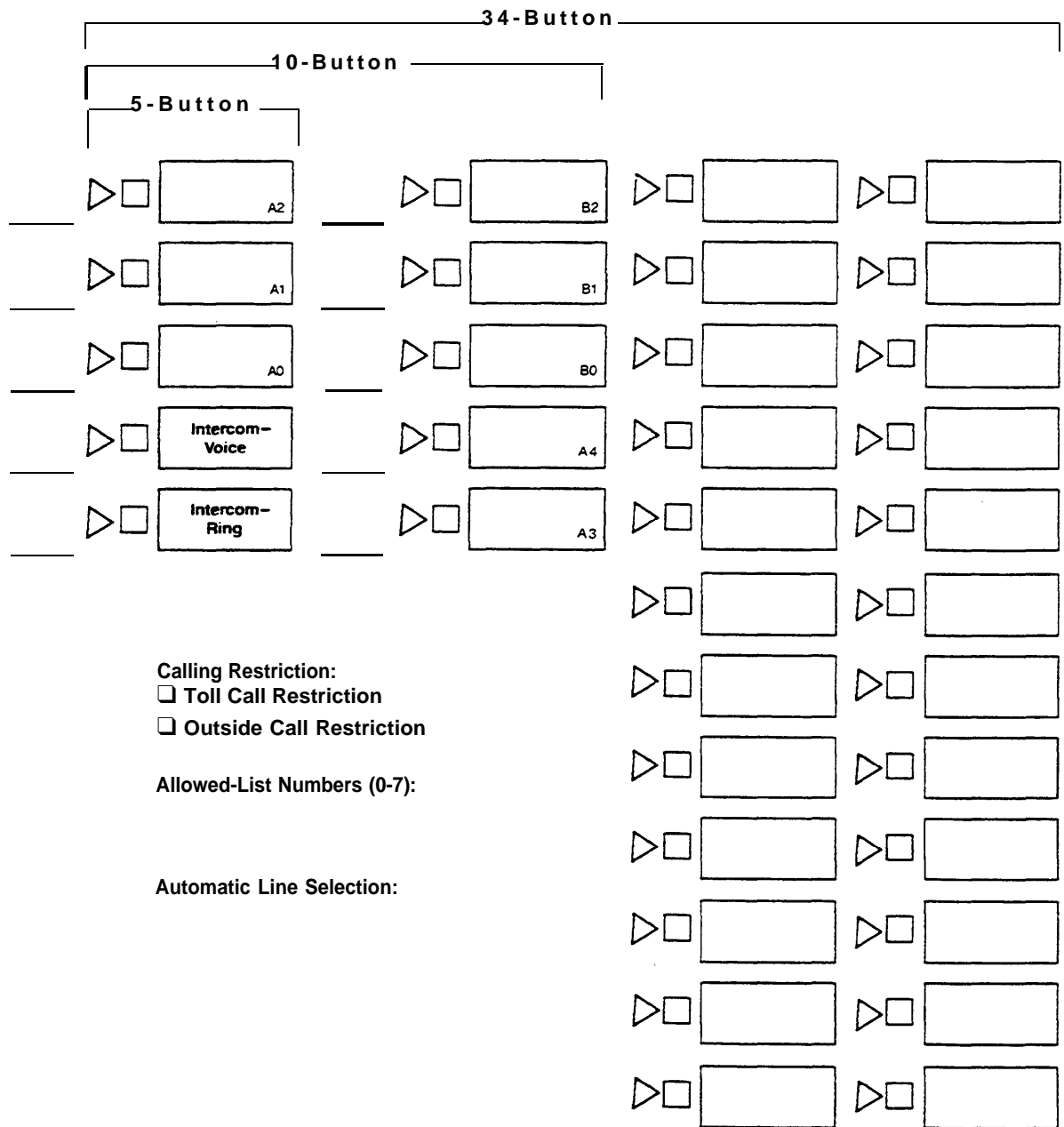

Voice Terminal Configuration Form for Models 1030 and 3070 Non-attendant Voice Terminals (Pooled Systems)

Intercom #

Identification

Voice Terminal Size:

- 5-Button
- 10-Button
- 34-Button
- 34-Button Deluxe
- Basic Touch-Tone or Rotary Telephone

Stand Type:

- Wall
- Plastic
- Fixed
- Desk
- Metal
- Adjustable

Accessories:

- General Purpose Adapter
- Headset
- Headset Adapter
- Hands-Free Unit
- Extra Long Cord

- Acoustic Coupler Adapter
- Hearing-Impaired Handset
- Push-to-Listen Handset
- Voice Terminal Power Supply
- Attendant Intercom Selector

34-Button			
10-Button			
5-Button			
▶ <input type="checkbox"/> 1	▶ <input type="checkbox"/> 6	▶ <input type="checkbox"/> 	▶ <input type="checkbox"/>
▶ <input type="checkbox"/> Line Pool or Pool Access	▶ <input type="checkbox"/> 5	▶ <input type="checkbox"/> 	▶ <input type="checkbox"/>
▶ <input type="checkbox"/> Line Pool or Pool Access	▶ <input type="checkbox"/> 4	▶ <input type="checkbox"/> 	▶ <input type="checkbox"/>
▶ <input type="checkbox"/> Intercom - Voice	▶ <input type="checkbox"/> 3	▶ <input type="checkbox"/> 	▶ <input type="checkbox"/>
▶ <input type="checkbox"/> Intercom - Ring	▶ <input type="checkbox"/> 2	▶ <input type="checkbox"/> 	▶ <input type="checkbox"/>
		▶ <input type="checkbox"/> 	▶ <input type="checkbox"/>
		▶ <input type="checkbox"/> 	▶ <input type="checkbox"/>
Dial Access to Pools (9, 890-899):		▶ <input type="checkbox"/> 	▶ <input type="checkbox"/>
Calling Restriction: <input type="checkbox"/> Toll Call Restriction <input type="checkbox"/> Outside Call Restriction		▶ <input type="checkbox"/> 	▶ <input type="checkbox"/>
Allowed-List Numbers (0-7):		▶ <input type="checkbox"/> 	▶ <input type="checkbox"/>
Automatic Line Selection:		▶ <input type="checkbox"/> 	▶ <input type="checkbox"/>
		▶ <input type="checkbox"/> 	▶ <input type="checkbox"/>

System Speed Dial Directory

Dial Code	Stored Number	Dial Code	Stored Number
#60		#80	
#61		#81	
#62		#82	
#63		#83	
#64		#84	
#65		#85	
#66		#86	
#67		#87	
#68		#88	
#69		#89	
#70		#90	
#71		#91	
#72		#92	
#73		#93	
#74		#94	
#75		#95	
#76		#96	
#77		#97	
#78		#98	
#79		#99	

Group Page Directory

Group 1		Group 2		Group 3	
Intercom #	Identification	Intercom #	Identification	Intercom #	Identification
1	_____	1	_____	1	_____
2	_____	2	_____	2	_____
3	_____	3	_____	3	_____
4	_____	4	_____	4	_____
5	_____	5	_____	5	_____
6	_____	6	_____	6	_____
7	_____	7	_____	7	_____
8	_____	8	_____	8	_____
9	_____	9	_____	9	_____
10	_____	10	_____	10	_____

Group 4		Group 5		Group 6		Group 7	
Intercom #	Identification	Intercom #	Identification	Intercom #	Identification	Intercom #	Identification
1	_____	1	_____	1	_____	1	_____
2	_____	2	_____	2	_____	2	_____
3	_____	3	_____	3	_____	3	_____
4	_____	4	_____	4	_____	4	_____
5	_____	5	_____	5	_____	5	_____
6	_____	6	_____	6	_____	6	_____
7	_____	7	_____	7	_____	7	_____
8	_____	8	_____	8	_____	8	_____
9	_____	9	_____	9	_____	9	_____
10	_____	10	_____	10	_____	10	_____

Allowed-List Directory

List 0	List 1	List 2	List 3
Entry 0	Entry 0	Entry 0	Entry 0
1	1	1	1
2	2	2	2
3	3	3	3
4	4	4	4
5	5	5	5
6	6	6	6
7	7	7	7
8	8	8	8
9	9	9	9
List 4	List 5	List 6	List 7
Entry 0	Entry 0	Entry 0	Entry 0
1	1	1	1
2	2	2	2
3	3	3	3
4	4	4	4
5	5	5	5
6	6	6	6
7	7	7	7
8	8	8	8
9	9	9	9

Form for Automatic Route Selection Tables

TABLE 0

AREA CODE/EXCHANGE

0) —	1) —	2) —	3) —	4) —	5) —	6) —	7) —	8) —	9) —
POOL	OTHER DIGITS								
0) —	_____								
1) —	_____								
2) —	_____								
3) —	_____								
4) —	_____								
5) —	_____								

TABLE 1

AREA CODE/EXCHANGE

0) —	1) —	2) —	3) —	4) —	5) —	6) —	7) —	8) —	9) —
POOL	OTHER DIGITS								
0) —	_____								
1) —	_____								
2) —	_____								
3) —	_____								
4) —	_____								
5) —	_____								

TABLE 2

AREA CODE/EXCHANGE

0) —	1) —	2) —	3) —	4) —	5) —	6) —	7) —	8) —	9) —
POOL	OTHER DIGITS								
0) —	_____								
1) —	_____								
2) —	_____								
3) —	_____								
4) —	_____								
5) —	_____								

TABLE 3

AREA CODE/EXCHANGE

0) —	1) —	2) —	3) —	4) —	5) —	6) —	7) —	8) —	9) —
POOL	OTHER DIGITS								
0) —	_____								
1) —	_____								
2) —	_____								
3) —	_____								
4) —	_____								
5) —	_____								

**Form for Automatic Route
Selection Tables (continued)**

TABLE 4

AREA CODE/EXCHANGE

0) — 1) — 2) — 3) — 4) — 5) — 6) — 7) — 8) — 9) —

POOL OTHER DIGITS

0) — _____

1) — _____

2) — _____

3) — _____

4) — _____

5) — _____

TABLE 5

AREA CODE/EXCHANGE

0) — 1) — 2) — 3) — 4) — 5) — 6) — 7) — 8) — 9) —

POOL OTHER DIGITS

0) — _____

1) — _____

2) — _____

3) — _____

4) — _____

5) — _____

TABLE 6

AREA CODE/EXCHANGE

0) — 1) — 2) — 3) — 4) — 5) — 6) — 7) — 8) — 9) —

POOL OTHER DIGITS

0) — _____

1) — _____

2) — _____

3) — _____

4) — _____

5) — _____

Form for Automatic Route Selection Tables (continued)

TABLE 7

AREA CODE/EXCHANGE

0) — 1) — 2) — 3) — 4) — 5) — 6) — 7) — 8) — 9) —

POOL OTHER DIGITS

0) — _____
 1) — _____
 2) — _____
 3) — _____
 4) — _____
 5) — _____

TABLE 8: DEFAULT TOLL

POOL OTHER DIGITS

0) — _____
 1) — _____
 2) — _____
 3) — _____
 4) — _____
 5) — _____

TABLE 9: DEFAULT LOCAL

POOL OTHER DIGITS

0) — _____
 1) — _____
 2) — _____
 3) — _____
 4) — _____
 5) — _____

SPECIAL NUMBERS TABLE

AREA CODE/EXCHANGE

0) 911 1) 411 2) 611 3) 800 4) 900 5) 0

POOL OTHER DIGITS

0) 9 _____

Index

- Account Number Entry, 76, 94
- Adm Misc, 10, 11, 25
- Adm Pool, 10, 11, 25
- Adm Tel, 10, 11, 25
- Administrator/Attendant Console, 4, 6, 7, 9 - 12, 20, 22, 24, 25, 83 - 86
 - Using the Console, 12
 - Initial Feature Assignments, 85, 86
- Administration Mode, 4, 9 - 11, 25
 - Button Labels, 9, 25
 - Entering, 25
 - Leaving, 25
- Allowed Lists, 41, 44, 45, 118
 - Setting Up, 44, 117
- Allowed-List Call Restrictions, 45, 118
- Attendant Consoles, 9 - 12, 24, 83 - 86
 - Initial Feature Assignments, 85, 86
 - Special Information about, 83, 84
- Attendant Intercom Selector, 9, 12, 83
- Auto Answer, 75
- Auto Intercom, 11, 12, 74, 94
- Automatic Line Selection, 67, 94
 - Assigning, 67
- Automatic Route Selection, 46 - 54, 94, 119
- Automatic Tip/Ring Interface, 38, 67

- Basic Telephones, 7, 12, 77, 88 - 90
- Button Access to Line Pools, 7, 19, 33, 37, 94, 117

- Call Coverage. See Cover
- Call Park, 76, 92
- Call Pickup, 76, 92
- Call Restr, 10, 11, 25
- Call Restrictions, 41 - 45, 95, 118
 - Allowed-list Call Restriction, 41, 44, 45, 95, 118
 - Outward Call Restriction, 41 - 43, 95, 118
 - Toll Call Restriction, 41 - 43, 95, 118
- Call Waiting, 92
- Conference, 92
- Centralized Voice Terminal Programming, 62, 66, 95, 120
- Control Unit, 4, 6 - 9, 22 - 24
 - Diagram, 3, 6
 - Setting, 22 - 24
- Copy, 10, 11, 30, 118
- Cover, 69, 70, 75, 94
 - Assigning, 69, 70, 75
 - Primary Coverage, 69, 70, 75, 94
 - Secondary Coverage, 69, 70, 75, 94
- Coverage Inhibit, 75, 94
- Custom Features, 94 - 96
- Customized Square Systems, 14, 15, 27, 29, 30

- Dial Access to Line Pools, 7, 19, 38, 39, 95, 117
- Distinctive Ringing, 80, 92
- Do Not Disturb, 76, 95
- Drop, 92
- Diagnostics Module, 7

- Expansion Unit, 4, 6 - 8

- Extra Alert, 7, 56, 97, 119

- Feature Module 4, 7
 - Attendant/Administer Option, 7, 22, 25
 - Normal/Attendant Option, 7, 22
 - Pooled/Square Option, 7, 14, 23
 - 1-8 Lines/ >8 Lines Option, 7, 83 - 84
- Forms, 20, 98 - 115
 - System Configuration, 20, 98 - 106
 - Voice Terminal Configuration, 20, 98 - 105, 107 - 109

- General Purpose Adapter, 12, 38, 67
- Group Page, 55, 75, 84, 95, 111, 119

- Hands-Free Unit, 12
- Headset and Headset Adapter, 12
- Hold, 92
 - Automatic Hold Release, 92

- Individual Lines, 14, 15, 27 - 30, 36
 - Assigning, 27, 30, 36
- Initial Feature Assignments, 63 - 65, 85, 86
- Intercom, 92
 - Intercom-Ring, 92
 - Intercom-Voice, 92

- Labels, Administration Mode Button, 9, 20
- Last Number Redial, 74, 95
- Line Code, 71
- Line Module, 7, 8, 32, 35
- Line Pickup, 71, 76, 92
- Line Pools, 14, 17, 31 - 39, 94 - 96, 117
 - Adding Lines, 32, 117
 - Removing Lines, 32, 117
 - Setting Up, 31 - 32, 117
- Line Request, 92
- Line Ringing, 68, 69, 96
 - Delayed Ring, 68, 69
 - Immediate Ring, 68
 - No Ring, 68
- Lines, Assigning to Buttons, 33 - 36
- Loudspeaker Page, 75, 97
- Loudspeaker Paging System, 7, 23, 84

- Manual Signaling, 74, 95
- Manual Tip/Ring Interface, 38, 67
- Message, 76
- Message Status Button, 10 - 12, 25
- Message Waiting, 92
- Module C, 7
- Monitor-on-Hold, 93
- Multiple Line Pools, 17, 18, 31, 32, 96
- Music-on-Hold, 7, 23, 97

- Night Service, 25, 56, 97, 119
 - Establishing, 56, 119

- Off-Premises Telephone Interface, 7, 12, 88, 89
- Office Priorities,
 - Programming Voice Terminals for, 62
- On-Hook Dialing, 93
- Outside Auto Dial, 74, 78, 96

- Outward Call Restrictions, 41 - 45

- Personal Priorities,
 - Programming Voice Terminals for, 72
- Personal Speed Dial Codes, 74, 77, 78, 96
 - Assigning to 5- and 10-Button Voice Terminals, 77
- Personalized Ring, 80, 96
 - Selecting, 80
- Pooled Systems, 14, 17 - 19, 22, 23, 31 - 39, 117
 - About, 14, 17 - 19
 - Assigning Lines in, 33 - 36, 117
- Power Module, 6, 8, 23
- Printer, 23, 52, 59, 60, 119, 120
- privacy, 76, 96
- Processor Module, 6
- Programmable Line Ringing, 68, 96

- Recall, 93
- Return Interval for Transferred Calls, 61, 120
- Ring Line Selection, 93
- Rotary Dialing, 26, 117

- Saved Number Redial, 74, 96
- Send Message, 93
- Services Module, 7, 23
- Shift Button, 11, 12
- Simultaneous Voice and Data Calls, 76, 82, 97, 120
- SMDR (Station Message Detail Recording), 7, 59 - 60, 120
 - Administering, 59 - 60
 - Module, 7
- Speaker, 92, 93
- Special Characters, 53, 78
- Special Numbers, 47, 53
- Square Systems, 14 - 16, 22, 23, 117
 - About, 14-16, 27-28
 - Assigning Lines in, 29, 30, 117
- Square vs. Pooled Decision. 14
- Standard Square Systems, 14, 15, 27 - 30
- Switches, 4, 6, 8, 9, 22 - 24, 84
- System Options,
 - Customizing with Additional, 40
- System Speed Dial, 57, 58, 74, 96, 110, 120

- Toll Call Restrictions, 41 - 45
- Toll Prefix, 118
- Touch-Tone Dialing, 26, 96, 117
- Touch-Tone Enable. 76, 96
- Touch-Tone/Rotary Option, 26, 96, 117
- Transfer, 93, 94, 120
 - One-Touch Transfer, 94
 - Transfer Return, 61, 93, 120
- T/P Switch, 25

- Voice Announcement Disable, 81, 96
- Voice Terminal Module, 7, 8
- Voice Terminal Programming, 62 - 82, 93
- Voice Terminal Testing, 93
- Voice Terminals, 5-Button, 77, 87
- Volume Control, 93

Quick Reference Guide to Administration Procedures

This chart summarizes the administrative procedures described on pages 26 through 82. For more information about a procedure, refer to the page listed.

Before you perform any of these procedures, enter administration mode by following the steps below.

- Set switch A on the Processor Module in the control unit to *Administer* (down).
- Insert the administration mode button labels (see the back of this manual) in the administrator/attendant console.
- Slide the T/P switch on the left side of the console to *P*.

When you finish administering your system, leave administration mode by following the steps below.

- Slide the T/P switch to the center position.
- Set switch A on the Processor Module to *Attendant* (up).
- Remove the administration mode button labels from the console and insert the regular call-handling labels used by the attendant.

Procedure	Touch	Then
PERFORM BASIC ADMINISTRATION		
Specify Touch-Tone or rotary dialing. (See page 26.)	Adm Misc	<ul style="list-style-type: none"> • Dial #302. • Touch line buttons. <i>Steady green on = Touch-Tone</i> <i>Green off = rotary</i> • Touch Adm Misc.
Assign lines to voice terminals in square systems. (See page 27.)	Adm Tel	<ul style="list-style-type: none"> • Touch Auto Intercom button representing voice terminal. • Touch line buttons. <i>Steady green on = line is assigned</i> <i>Green off = line is not assigned</i> • Touch Adm Tel.
Set up line pools in pooled systems. (See page 31.)	Adm Pool	<ul style="list-style-type: none"> • Dial pool code (9 for main pool or 890 through 899 for additional pools) if administering more than one line pool. • Touch line buttons. <i>Steady red on = line is in pool</i> <i>Red off = line is not in pool</i> • Touch Adm Pool.
Assign lines and line pools to voice terminals in pooled systems. (See page 33.)	Adm Tel	<ul style="list-style-type: none"> • Touch Auto intercom button representing voice terminal. • Touch line buttons. <i>Steady green on = line or pool assigned</i> <i>Green off = line or pool not assigned</i> • Touch Adm Tel.
Assign Dial Access to Line Pools. (See page 38.)	Adm Tel	<ul style="list-style-type: none"> • Touch Auto Intercom button representing voice terminal. • Touch same Auto Intercom button again. • Touch line buttons. <i>Steady green on = dial access to pool containing line</i> <i>Green off = no dial access to pool containing line</i> • Touch Adm Tel.

Quick Reference Guide to Administration Procedures (continued)

Procedure	Touch	Then
<p>CUSTOMIZE WITH OTHER SYSTEM OPTIONS</p> <p>Assign outward and toll call restrictions to voice terminals.</p> <p>NOTE: If you <i>do not</i> need to dial a toll prefix (0 or 1) to place a long distance call, follow steps 1 and 2 below. If you use a toll prefix, just follow step 2 below.</p>		
<p>1. Set lines to identify long distance calls by area code only.</p>	Call Rstr	<ul style="list-style-type: none"> •Touch line buttons. <li style="padding-left: 20px;"><i>Steady green on</i> = toll prefix <li style="padding-left: 20px;"><i>Green off</i> = area code only •Touch Call Rstr.
<p>2. Assign restrictions to voice terminals.</p> <p>(See page 42.)</p>	Adm Tel	<ul style="list-style-type: none"> •Touch Auto Intercom button representing voice terminal. •Touch Call Rstr. <li style="padding-left: 20px;"><i>Steady green on</i> = all calls permitted <li style="padding-left: 20px;"><i>Flashing green</i> = local and intercom calls and any assigned lists <li style="padding-left: 20px;"><i>Green off</i> = intercom calls and any assigned lists •Touch Adm Tel.
<p>Give a voice terminal the same line and call restriction assignments as another voice terminal.</p>	Adm Tel	<ul style="list-style-type: none"> •Touch Auto Intercom button representing new voice terminal. •Touch Copy. •Touch Auto intercom button representing voice terminal whose assignments you want to copy.
<p>Set up alloweci lists.</p> <p>(See page 44.)</p>	Adm Misc	<ul style="list-style-type: none"> •Dial #5. •Dial list number (0 through 7), then dial entry number (0 through 9). •Dial entry (area code and/or exchange). •Dial #900 to get a printout of an allowed list. •Touch Adm Misc.
<p>Assign allowed-list call restrictions to voice terminals.</p> <p>(See page 45.)</p>	Adm Misc	<ul style="list-style-type: none"> •Dial #4, then dial list number (0 through 7). •Touch Auto intercom button representing voice terminal. <li style="padding-left: 20px;"><i>Steady green on</i> = access to numbers in list <li style="padding-left: 20px;"><i>Green off</i> = no access to numbers in list •Touch Adm Misc.

Quick Reference Guide to Administration Procedures (continued)

Procedure	Touch	Then
Administer Automatic Route Selection (ARS). (See page 46.)		
To add an area code or exchange:	Adm Misc	<ul style="list-style-type: none"> •Dial #6. •Dial table number (0 through 7). •Dial entry number (0 through 9). •Dial entry (area code or exchange). •Touch Adm Misc.
To delete an area code or exchange:	Adm Misc	<ul style="list-style-type: none"> •Dial #6. •Dial table number (0 through 7). •Dial entry number(0 through 9). •Touch Drop. •Touch Adm Misc.
To add a pool number and other digits:	Adm Misc	<ul style="list-style-type: none"> •Dial #7. •Dial table number (0 through 9). •Dial entry number (0 through 5). •Dial entry (pool number and access or account code, if required). •Touch Adm Misc.
To delete a pool number and other digits:	Adm Misc	<ul style="list-style-type: none"> •Dial #7. •Dial table number (0 through 9). •Dial entry number (0 through 5). •Touch Drop. •Touch Adm Misc.
To add other digits to Pool 9 in the Special Numbers Table:	Adm Misc	<ul style="list-style-type: none"> •Dial #800. •Dial entry (access and account code). •Touch Adm Misc.
To delete other digits in the Special Numbers Table:	Adm Misc	<ul style="list-style-type: none"> •Dial #800. •Touch Drop. •Touch Adm Misc.
Get a printout of ARS tables. (See page 53.)	Adm Misc	<ul style="list-style-type: none"> •Dial #902 and wait for beep. •Touch Adm Misc.
Assign voice terminals to groups for Group Page. (See page 55.)	Adm Misc	<ul style="list-style-type: none"> •Dial #84, then dial Group Page group number. •Touch Auto intercom button representing voice terminal. <li style="padding-left: 20px;"><i>Steady green on = assigned to paging group</i> <li style="padding-left: 20px;"><i>Green off = not assigned to paging group</i> •Touch Adm Misc.
Establish Night Service. (See page 56.)	Night Service	<ul style="list-style-type: none"> •Touch line buttons. <li style="padding-left: 20px;"><i>Steady green on = line activates alerting device 7</i> <li style="padding-left: 20px;"><i>Flashing green = line activates alerting device 2</i> <li style="padding-left: 20px;"><i>Rapidly flashing green = line activates alerting device 3</i> <li style="padding-left: 20px;"><i>Green off = line does not activate alerting device</i> •Touch Night Service.
Assign System Speed Dial codes. (See page 57.)	Conference	<ul style="list-style-type: none"> •Dial 0. •Dial System Speed Dial Codes and * if marked code. •Dial telephone number. •Touch Conference two times.

Quick Reference Guide to Administration Procedures (continued)

Procedure	Touch	Then
Get a printout of System Speed Dial codes. (See page 58.)	Adm Misc	<ul style="list-style-type: none"> •Dial #901 and wait for beep. •Touch Adm Misc.
Administer Station Message Detail Recording (SMDR) options. (See page 59.)	Adm Misc	<ul style="list-style-type: none"> •Dial #300 and set time, then dial #301 and set date. •Dial #390 and set minimum call duration to be recorded. •Dial #391 followed by 0 or 1 to specify whether incoming calls are recorded. •Dial #390 and then #900 to get a printed report on minimum call length and on incoming. calls. •Touch Adm Misc.
Set printer to scroll to top of page automatically (with printer off and scrolled to top of next page). (See page 60.)	Adm Misc	<ul style="list-style-type: none"> •Dial #399.
Set Transfer Return Interval. (See page 61.)	Adm Misc	<ul style="list-style-type: none"> •Dial #306. •Dial number of rings (1 through 9) preferred before calls return to original voice terminal. Dial 0 if transferred calls should not return. •Touch Adm Misc.
Prepare for Centralized Voice Terminal Programming. (See page 66.)	Conference	<ul style="list-style-type: none"> •Touch Auto Intercom button for terminal to be programmed.

SLOT 1

SLOT 2

SLOT 3

SLOT 4

A2	B2	19	29
A1	B1	18	28
A0	B0	17	27
Adm Pool	A4	16	26
Adm Tel	A3	15	25
		14	24
		13	23
		12	22
		11	21
		10	20
		Adm Misc	Night Service
		Call Rstr	Copy

How to Use Label Strips

1. Type or print the appropriate outside line number* or name† on each label.

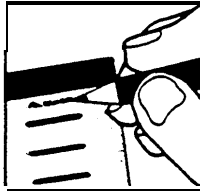

2. Crease the perforated edges, then tear out each label strip.

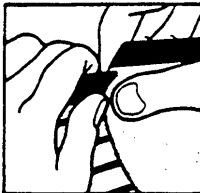

3. Insert the label strips into the console. Slot numbers on the black tabs indicate the correct slot for the strip. Slot 1 is on the far left; slot 4 on the far right.

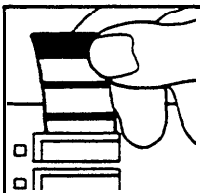

* Note the control unit jack numbers (A0-B2) printed on the line button labels. Label each button with the telephone number of the outside line that is plugged into the control unit jack whose number is printed on the button label.

† The numbers (10-20) printed on the button labels indicate the intercom number of the voice terminal each button represents. Label each intercom button with the appropriate person's name.

Small Console Administration Button Labels

SLOT 1	SLOT 2	SLOT 3	SLOT 4	SLOT 5	SLOT 6	SLOT 7
--------	--------	--------	--------	--------	--------	--------

A2	B2	B3	D4	19 49 79	29 59	39 69 †
A1	B1	B4	E0	18 48 78	28 58	33 68
A0	B0	C0	E1	17 47 77	27 57	37 67
Adm Pool	A4	C1	E2	16 46 76	26 56	36 66
Adm Tel	A3	C2	E3	15 45 75	25 55	35 65
		C3	E4	14 44 74	24 54	34 64
		C4	F0	13 43 73	23 53	33 63
		D0	F1	12 42 72	22 52	32 62
		D1	F2	11 41 71	21 51	31 61
		D2	F3	10 40 70	20 50	30 60
		D3	F4			

How to Use Label Strips

1. Type or print the appropriate outside line number* or name† on each label.

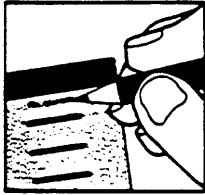

2. Crease the perforated edges, then tear out each label strip.



3. Insert the label strips into the slots on the console. Slot numbers on the black tabs indicate the correct slot for the strip. Slot 1 is on the far left* slot 7 is on the far right.

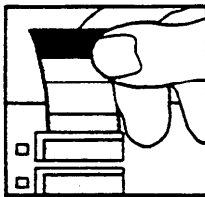

Call Rstr

Copy

Message Status

Adm Misc

Night Service

* Note the control unit jack numbers (A0-F4) printed on the line button labels for slots 1-4. Label each button with the telephone number of the outside line that is plugged into the control unit jack whose number is printed on the button label.

† The numbers (10-79) printed on the button labels for slots 57 are voice terminal intercom numbers for each shift level the button represents. Label each intercom button with the appropriate person's name.

Large Console Administration Button Labels

Free Manuals Download Website

<http://myh66.com>

<http://usermanuals.us>

<http://www.somanuals.com>

<http://www.4manuals.cc>

<http://www.manual-lib.com>

<http://www.404manual.com>

<http://www.luxmanual.com>

<http://aubethermostatmanual.com>

Golf course search by state

<http://golfingnear.com>

Email search by domain

<http://emailbydomain.com>

Auto manuals search

<http://auto.somanuals.com>

TV manuals search

<http://tv.somanuals.com>