

**USB KVM Extender**  
**CE800B**  
**User Manual**



[www.aten.com](http://www.aten.com)

## FCC Information

This is an FCC Class A product. In a domestic environment this product may cause radio interference in which case the user may be required to take adequate measures.

This equipment has been tested and found to comply with the limits for a Class A digital device, pursuant to Part 15 of the FCC Rules. These limits are designed to provide reasonable protection against harmful interference when the equipment is operated in a commercial environment. This equipment generates, uses and can radiate radio frequency energy and, if not installed and used in accordance with the instruction manual, may cause harmful interference to radio communications. Operation of this equipment in a residential area is likely to cause harmful interference in which case the user will be required to correct the interference at his own expense.

## RoHS

This product is RoHS compliant.

## SJ/T 11364-2006

The following contains information that relates to China.

部件名称	有毒有害物质或元素					
	铅	汞	镉	六价铬	多溴联苯	多溴二苯醚
电器部件	●	○	○	○	○	○
机构部件	○	○	○	○	○	○

- : 表示该有毒有害物质在该部件所有均质材料中的含量均在SJ/T 11363-2006规定的限量要求之下。
- : 表示符合欧盟的豁免条款, 但该有毒有害物质至少在该部件的某一均质材料中的含量超出SJ/T 11363-2006的限量要求。
- ×: 表示该有毒有害物质至少在该部件的某一均质材料中的含量超出SJ/T 11363-2006的限量要求。



## User Information

---

### Online Registration

Be sure to register your product at our online support center:

International	<a href="http://support.aten.com">http://support.aten.com</a>
North America	<a href="http://www.aten-usa.com/product_registration">http://www.aten-usa.com/product_registration</a>

### Telephone Support

For telephone support, call this number:

International	886-2-8692-6959
China	86-10-5255-0110
Japan	81-3-5615-5811
Korea	82-2-467-6789
North America	1-888-999-ATEN ext 4988
United Kingdom	44-8-4481-58923

### User Notice

- ◆ All information, documentation, and specifications contained in this manual are subject to change without prior notification by the manufacturer. The manufacturer makes no representations or warranties, either expressed or implied, with respect to the contents hereof and specifically disclaims any warranties as to merchantability or fitness for any particular purpose. Any of the manufacturer's software described in this manual is sold or licensed *as is*. Should the programs prove defective following their purchase, the buyer (and not the manufacturer, its distributor, or its dealer), assumes the entire cost of all necessary servicing, repair and any incidental or consequential damages resulting from any defect in the software.

The manufacturer of this system is not responsible for any radio and/or TV interference caused by unauthorized modifications to this device. It is the responsibility of the user to correct such interference.

The manufacturer is not responsible for any damage incurred in the operation of this system if the correct operational voltage setting was not selected prior to operation. PLEASE VERIFY THAT THE VOLTAGE SETTING IS CORRECT BEFORE USE.

- ◆ This ATEN product is specifically designed and manufactured for the operation and management of computer mainframe and communications equipment used in network management centers. As such, it may not be completely appropriate for those environments and sites where special standards for performance and high reliability are required – such as military equipment, traffic management, nuclear facilities, security systems, communications equipment, medical facilities, etc.

## Package Contents

---

The CE800B USB KVM Extender package contains:

- ◆ 1 CE800BL USB KVM Extender (Local Unit)
- ◆ 1 CE800BR USB KVM Extender (Remote Unit)
- ◆ 1 Custom KVM Cable (1.8 m)
- ◆ 2 Power Adapters
- ◆ 1 Firmware Upgrade Cable
- ◆ 1 USB Cable (1.8 m)
- ◆ 1 Mounting Kit
- ◆ 1 User Instructions\*
- ◆ 1 Grounding Information Card

Check to make sure that all the components are present and that nothing got damaged in shipping. If you encounter a problem, contact your dealer.

Read this manual thoroughly and follow the installation and operation procedures carefully to prevent any damage to the unit, and/or any of the devices connected to it.

---

\* Features may have been added to the CE800B since this manual was printed.  
Please visit our website to download the most up-to-date version of the manual.

---

© Copyright 2008–2012 ATEN® International Co., Ltd.  
Manual Part No. PAPE-0300-AT2G  
Manual Date: 2012-02-23

ATEN and the ATEN logo are registered trademarks of ATEN International Co., Ltd. All rights reserved.  
All other brand names and trademarks are the registered property of their respective owners.

# Contents

---

FCC Information . . . . .	ii
RoHS . . . . .	ii
SJ/T 11364-2006 . . . . .	ii
User Information . . . . .	iii
Online Registration . . . . .	iii
Telephone Support . . . . .	iii
User Notice . . . . .	iii
Package Contents . . . . .	iv
Contents . . . . .	v
About this Manual . . . . .	vii
Conventions . . . . .	viii
Product Information . . . . .	viii
<b>1. Introduction</b>	
Overview . . . . .	1
Features . . . . .	2
System Requirements . . . . .	3
Consoles . . . . .	3
Computers . . . . .	3
Cables . . . . .	3
Operating Systems . . . . .	4
CE800BL (Local Unit) Front View . . . . .	5
CE800BR (Remote Unit) Front View . . . . .	6
CE800BL / CE800BR Rear View . . . . .	7
Side View . . . . .	7
<b>2. Hardware Setup</b>	
Before You Begin . . . . .	9
Rack Mounting . . . . .	9
Installation . . . . .	11
Grounding . . . . .	11
Setting Up . . . . .	13
Standard Installation – CE800B to PC . . . . .	15
Advanced Installation – CE800B to KVM Switch . . . . .	16
<b>3. Operation</b>	
Basic Operation . . . . .	17
Operating Modes . . . . .	17
Mode Selection . . . . .	17
Picture Compensation . . . . .	18
LED Display . . . . .	18
USB Mass Storage . . . . .	19
OSD Operation . . . . .	20

Overview . . . . .	20
Administrator Main Screen . . . . .	21
OSD Navigation . . . . .	21
Administrator Configuration . . . . .	22
User Configuration . . . . .	24
Hotkey Setting Mode . . . . .	25
Invoking HSM . . . . .	25
Alternate HSM Invocation Keys . . . . .	26
Alternate OSD Activation Keys . . . . .	26
Enable / Disable Hotkeys . . . . .	27
Keyboard Operating Platform . . . . .	27
USB Reset . . . . .	28
Hotkey Summary Table . . . . .	28

#### **4. Keyboard Emulation**

Mac Keyboard. . . . .	29
Sun Keyboard. . . . .	30

#### **5. The Firmware Upgrade Utility**

Before You Begin . . . . .	31
Starting the Upgrade. . . . .	33
Upgrade Succeeded. . . . .	35
Upgrade Failed . . . . .	35

#### **Appendix**

Safety Instructions . . . . .	37
General . . . . .	37
Rack Mounting . . . . .	39
Technical Support. . . . .	40
International . . . . .	40
North America . . . . .	40
Specifications . . . . .	41
Troubleshooting . . . . .	42
TP Wiring Diagram / TP Pin Assignments . . . . .	42
Clear Login Information . . . . .	43
About SPHD Connectors . . . . .	44
Limited Warranty. . . . .	44

## About this Manual

---

This User Manual is provided to help you get the most from your CE800B system. It covers all aspects of installation, configuration and operation. An overview of the information found in the manual is provided below.

**Chapter 1, Introduction,** introduces you to the CE800B USB KVM Extender system. Its purpose, features and benefits are presented, and its front and back panel components are described.

**Chapter 2, Hardware Setup,** describes how to set up your installation.

**Chapter 3, Operation,** explains the fundamental concepts involved in operating the CE800B; provides a complete description of the CE800B's OSD (On Screen Display), and how to work with it; and details all of the concepts and procedures involved in the Hotkey operation of your CE800B installation.

**Chapter 4, Keyboard Emulation,** provides tables that list the PC to Mac and PC to Sun keyboard emulation mappings.

**Chapter 5, The Firmware Upgrade Utility,** explains how to use this utility to upgrade the CE800B's firmware with the latest available versions.

**An Appendix,** provides specifications and other technical information regarding the CE800B.

## Conventions

---

This manual uses the following conventions:

- Monospaced      Indicates text that you should key in.
- [ ]                Indicates keys you should press. For example, [Enter] means to press the **Enter** key. If keys need to be chorded, they appear together in the same bracket with a plus sign between them: [Ctrl+Alt].
1.                Numbered lists represent procedures with sequential steps.
- ◆                Bullet lists provide information, but do not involve sequential steps.
- Indicates selecting the option (on a menu or dialog box, for example), that comes next. For example, Start → Run means to open the *Start* menu, and then select *Run*.
-                 Indicates critical information.

## Product Information

---

For information about all ATEN products and how they can help you connect without limits, visit ATEN on the Web or contact an ATEN Authorized Reseller. Visit ATEN on the Web for a list of locations and telephone numbers:

International	<a href="http://www.aten.com">http://www.aten.com</a>
North America	<a href="http://www.aten-usa.com">http://www.aten-usa.com</a>



# Chapter 1

## Introduction

### Overview

---

The CE800<sub>B</sub> USB KVM Extender with on-board audio allows access to a computer system from a remote console (USB keyboard and mouse, monitor, stereo speakers, and microphone). It is perfect for factory and construction sites, or any type of installation where the console needs to be in a conveniently accessible location, but you want the system equipment to reside in a safe place – away from dust, dirt, and harsh environmental influences.

The CE800<sub>B</sub> also is useful for control and security purposes. Store the system unit in a secure area while at the same time you put the console in a location that offers convenient access.

Recognizing the increased importance of sound in the computing environment, the on-board audio feature of the latest CE800<sub>B</sub> allows audio (stereo microphone and stereo speakers) transmissions to be extended to the remote system along with the KVM data.

The CE800<sub>B</sub> USB KVM Extender further improves on previous designs by using compact Cat 5e cable – the kind commonly used in Ethernet networks – instead of bulkier, more expensive, standard cables. Cat 5e cabling makes for a much neater, more convenient, more reliable data transfer connection.

Furthermore, the CE800<sub>B</sub> has built-in USB ports that support USB Mass Storage compliant flash drives. The addition of a Type B USB port on the local unit means that the flash drive facility is fully supported in both PC-only and KVM switch installations.

Setup is as easy as can be – simply connect the computer system box and local console to the Local CE800<sub>B</sub> Unit, run the Cat 5e cable to the Remote CE800<sub>B</sub> Unit (up to 250 meters away); and plug the remote console into the Remote Unit.

- 
- Note:**
1. You can control numerous remote systems from a single console by combining the CE800<sub>B</sub> with a KVM switch. See *Setting Up*, page 13 for details on combining a KVM switch in your CE800<sub>B</sub> installation.
  2. If you want to include a touchscreen in your CE800<sub>B</sub> installation, you must purchase an additional USB extender.
-

## Features

---

- ◆ Cat 5e (or higher) cable connects the Local and Remote Units – up to 250 m (825 ft) apart
- ◆ Dual console operation – control your system(s) from both the local and remote consoles
- ◆ Pushbutton selection of the active console
- ◆ Built-in USB port on both units supports external USB Mass Storage compliant flash drives for easy file sharing
- ◆ Special security feature requires login when connecting an external USB flash drive on the remote unit
- ◆ Supports VGA, SVGA, and multisync monitors – local monitor supports DDC; DDC2; DDC2B
- ◆ High Resolution Video – up to 1920 x 1200@60Hz (30 m); 1600 x 1200@60Hz (150 m); 1024 x 768@60Hz (250 m)
- ◆ Built-in 8KV/15KV ESD protection and 2KV surge protection
- ◆ Adjustable gain control – automatically and manually adjusts signal strength to compensate for distance.
- ◆ Supports stereo speakers and stereo microphone
- ◆ Supports Microsoft Intellimouse and the scrolling wheel on most mice
- ◆ Upgradable firmware
- ◆ Built-in ASIC for greater reliability and compatibility

# System Requirements

---

## Consoles

- ◆ Two VGA, SVGA, or multisync monitors capable of the highest resolution that you will be using on any computer in the installation
- ◆ Two USB keyboards
- ◆ Two USB mice
- ◆ Stereo microphone and stereo speakers (Optional)

---

**Note:** If you connect a DDC type monitor to the Local Unit, the monitor that connects to the Remote Unit must be able to support the highest video resolution that the DDC monitor can provide.

---

## Computers

The following equipment must be installed on each computer that is to be connected to the system:

- ◆ A VGA, SVGA or multisync card
- ◆ USB Host Controller and Type A USB Port

## Cables

- ◆ For optimum signal integrity and to simplify the layout, we strongly recommend that you use the high-quality Custom USB KVM Cable that is provided with this package.
- ◆ Cat 5e cable is the minimum required to connect the local and remote CE800B units. Cable of a lesser standard will result in degraded video signals. For best performance, we strongly recommend Cat 5e cable.

## **Operating Systems**

Supported operating systems are shown in the table, below:

<b>OS</b>		<b>Version</b>
Windows		2000 and higher
Linux	RedHat	7.1 and higher
	Mandrake	9.0 and higher
	SUSE	10 and higher
UNIX	FreeBSD	4.2 and higher
	IBM	AIX 4.3 and higher
Novell	Netware	6.0 and higher
Mac OS		9.0 and higher

## CE800BL (Local Unit) Front View

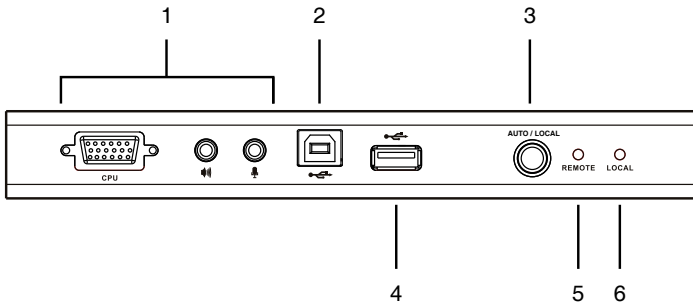

No.	Component	Description
1	KVM Port Section	This section is made up of a microphone jack, speaker jack, and KVM (keyboard, video, mouse) data connectors. The custom cable set that links the CE800BL to your local KVM console plugs in here. Only KVM cables designed to work with this switch can be used.
2	USB Type B Port	This port provides a CE800B installation with flash drive support. Connect one end of the USB cable supplied with the CE800B package to this port and the other end to a USB Type A port on the local computer.  If you are using a KVM switch in your CE800B installation, connect the other end of the cable to a USB Type A port on the KVM switch.  For further details, see <i>Setting Up</i> , page 13.
3	Operating Mode Selection Pushbutton	Pressing this switch toggles the operating mode between Auto and Local. See <i>Mode Selection</i> , page 17 for details.
4	USB Peripheral Port	External USB Mass Storage compliant flash drives plug into this port.
5	Remote LED	The Local Unit has two LEDs to indicate the operating status of the Local and Remote units (see <i>LED Display</i> , page 18 for details).
6	Local LED	

## CE800BR (Remote Unit) Front View

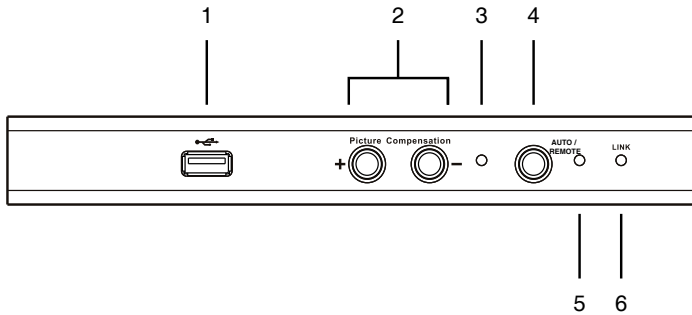

No.	Component	Description
1	USB Peripheral Port	External USB Mass Storage compliant flash drives plug into this port.
2	Picture Compensation Switches	These switches adjust the picture quality of the remote console. See <i>Picture Compensation</i> , page 18 for details.
3	Picture Compensation LED	Flashes to indicate that picture quality has been adjusted. See <i>Picture Compensation</i> , page 18 for details.
4	Operating Mode Selection Pushbutton	Pressing this pushbutton toggles the operating mode between Auto and Remote. See <i>Mode Selection</i> , page 17 for details.
5	Remote LED	The Remote LED indicates the operating status of the Remote unit ( See <i>CE800BR (Remote Unit)</i> , page 19, for details).
6	Link LED	Lights to indicate that the CE800BR is connected to the CE800BL

## CE800BL / CE800BR Rear View

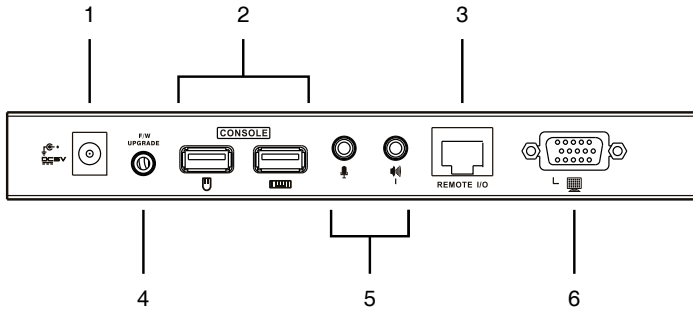

### Side View

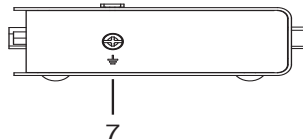

No.	Component	Description
1	Power Jack	The cable from the DC Power Adapter plugs into this jack.
2	Keyboard and Mouse Ports	The console USB keyboards and mice plug into these ports. The ports are color coded and marked with an icon to identify themselves.
3	Link Port	The Cat 5e cable that connects the Remote and Local units plugs into this connector.
4	Firmware Upgrade Port (Local Unit only)	The Firmware Upgrade Cable that transfers the firmware upgrade data from the administrator's computer to the CE800BL plugs in here.
5	Console Audio Jacks	The stereo microphone and stereo speakers plug into these connectors. The ports are color coded and marked with an icon to identify themselves.
6	Video Port	The console monitors plug into these ports.
7	Grounding Terminal	The grounding wire (used to ground the unit) attaches here.

This Page Intentionally Left Blank



# Chapter 2

## Hardware Setup

### Before You Begin

---



1. Important safety information regarding the placement of this device is provided on page 37. Please review it before proceeding.
2. Make sure that power to all the devices you will be connecting up have been turned off. You must unplug the power cords of any computers that have the Keyboard Power On function.

### Rack Mounting

---

For convenience and flexibility, the CE800B can be mounted on a system rack. To rack mount the unit do the following:

1. Using the screws provided with the Mounting Kit, screw the mounting bracket into the bottom of the unit as shown in the diagram below.

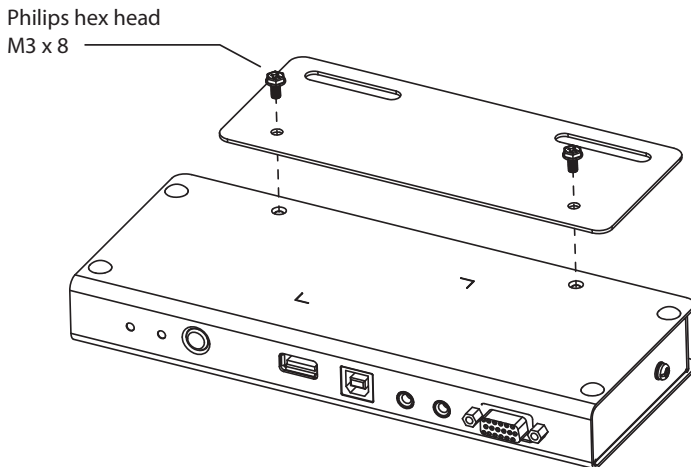

2. Screw the bracket into any convenient location on the rack.

---

**Note:** The rack screws are not provided. We recommend that you use M5 x 12 Phillips Type I cross, recessed type screws.

---

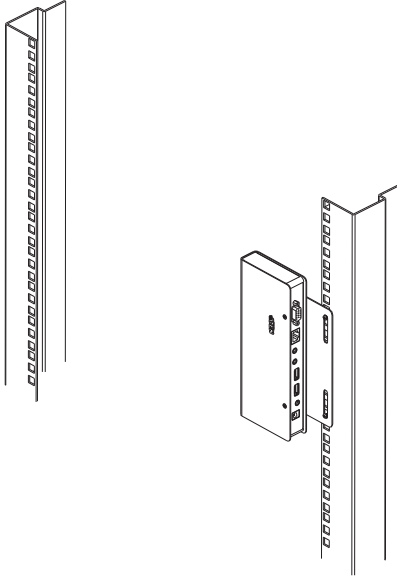

# Installation

## Grounding

To prevent damage to your installation it is important that all devices are properly grounded.

1. Use two grounding wires to ground both units by connecting one end of the wire to the grounding terminal, and the other end of the wire to a suitable grounded object.

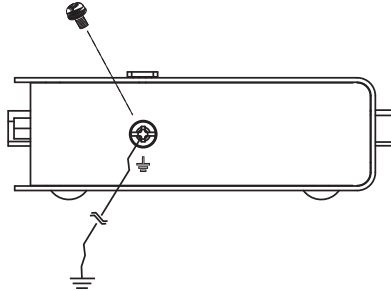

2. Make sure that the computer that the CE800BL connects to and the monitor that the CE800BR connects to are properly grounded.

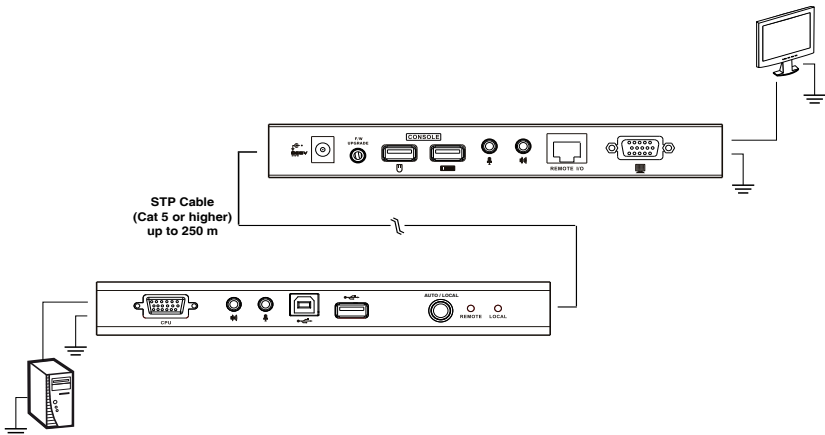

3. See the Grounding Information card that came with this package for proper grounding details.

4. For increased grounding protection, use STP (shielded twisted pair) cable to connect the local and remote units. There are two methods that can be used:

a) In addition to the eight paired wires, STP cable also contains a grounding wire. Solder this wire to the RJ-45 connector as shown in the diagram below:

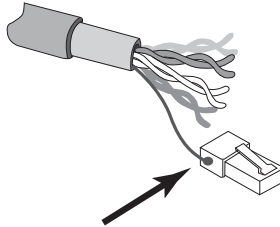

b) The second method is to use the STP cable shielding for grounding. In this case, make sure that the shielding makes tight contact with the top inside of the RJ-45 connector as shown in the diagram below:

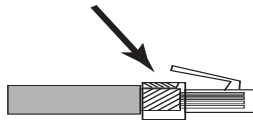

In either case, make sure that the sides of the RJ-45 connector make tight contact with the grounding contacts on the sides of the RJ-45 port as shown in the diagram below:

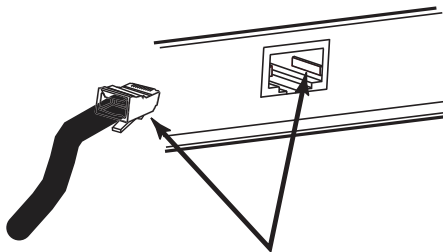

---

## Setting Up

Setting up the USB KVM Extender System is simply a matter of plugging in the cables. Refer to the diagrams on the following pages as you perform the following steps (the diagram numbers correspond to the numbers of the steps):

1. Plug the cables from the local console devices (mouse, keyboard, monitor, microphone and speakers) into their ports on the rear panel of the Local Unit (CE800BL). The connectors are color coded and marked with an icon to identify themselves.
2. Plug the KVM connectors on the custom KVM cable provided with this package into the KVM ports on the CE800BL's front panel.
  - ◆ For a standard CE800B-to-PC installation, progress to 3.
  - ◆ If you are combining a KVM switch with your CE800B installation, progress to 4 and refer to the diagram on page 16.
3. For a standard CE800B-to-PC installation:
  - a) Plug the connectors on the other end of the KVM cable into the appropriate ports on the computer system. The connectors are color coded and marked with an icon to identify themselves.
  - b) Next, use the USB cable provided with the CE800B package to connect the USB Type B port on the front of the CE800BL to a USB Type A port on the computer.
4. For a CE800B-to-KVM switch installation:
  - a) Plug the connectors on the other end of the KVM cable into the appropriate ports on the Console section of the KVM switch. The connectors are color coded and marked with an icon to identify themselves.
  - b) Next, use the USB cable provided with the CE800B package to connect the USB Type B port on the front of the CE800BL to the USB Type A keyboard port on the KVM switch.

---

**Note:** To ensure that the CE800B's keyboard hotkey function is supported, make sure that the USB cable is connected to the keyboard USB port on the KVM switch and not the mouse USB port.

---

*(Continues on next page.)*

5. Connect one end of a Cat 5e twisted pair cable to the Link port on the CE800BL; connect the other end of the Cat 5e twisted pair cable into the Link port on the CE800BR.

---

**Note:** Cat 5e cable is not supplied with this package. It requires a separate purchase. The cable length can be up to 250 m (820 ft).

---

6. Plug the cables from the remote console devices (mouse, keyboard, monitor, microphone and speakers) into their ports on the rear panel of the Remote Unit (CE800BR).
7. Connect one of the power adapters provided with this package into an AC source; connect the adapter's power cable to the Power Jack on the CE800BL.
8. Connect the other power adapter provided with this package into an AC source; connect the adapter's power cable to the Power Jack on the CE800BR.
9. If you are using USB Mass Storage compliant flash drives, plug them into the USB ports on the Local and Remote Unit's front panels. See *USB Mass Storage*, page 19

## Standard Installation – CE800B to PC

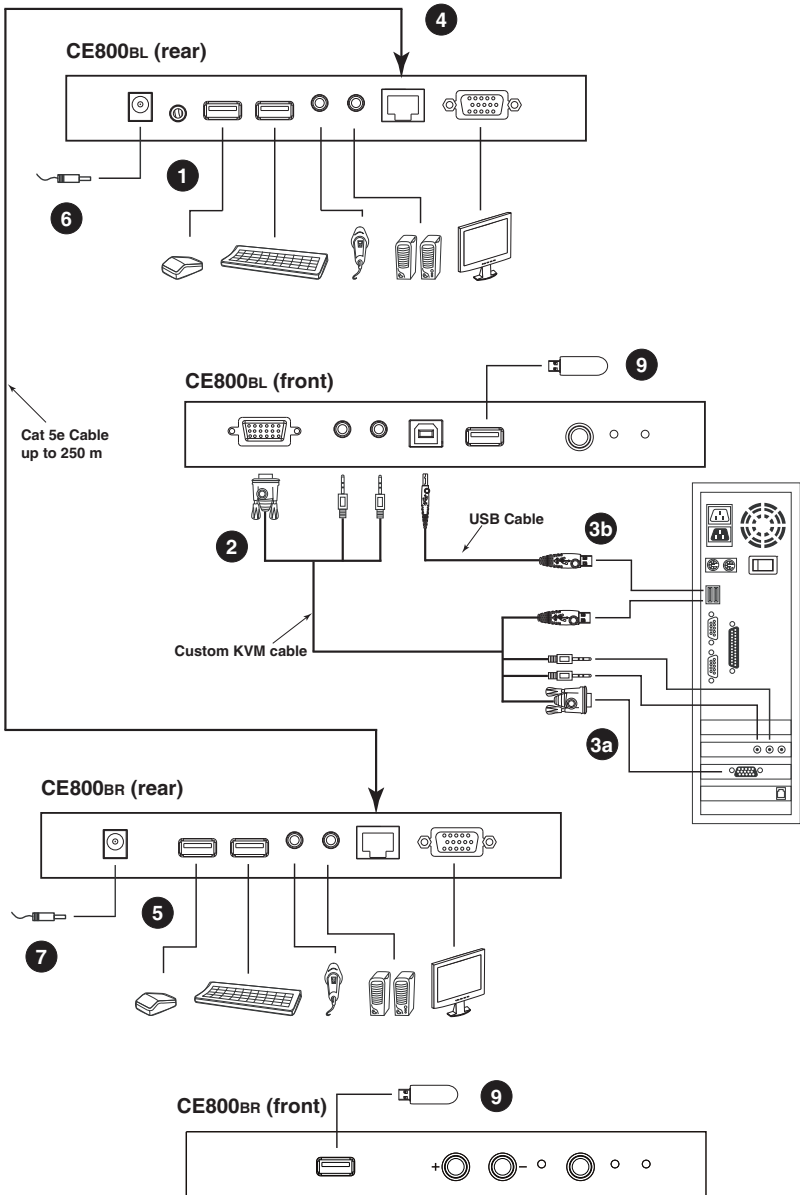

## Advanced Installation – CE800B to KVM Switch

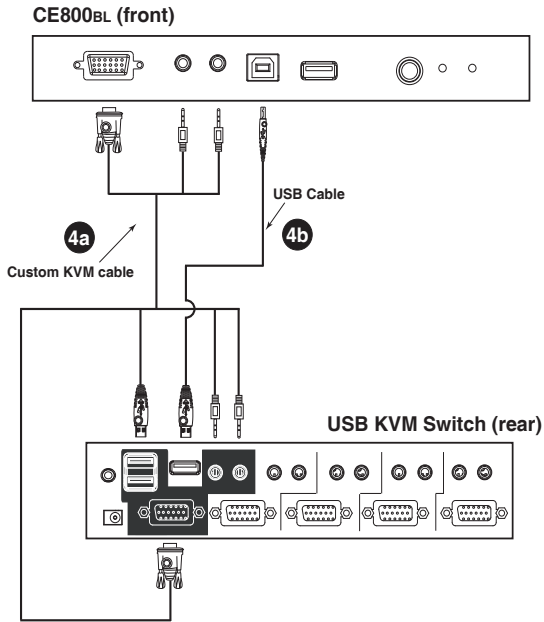



# Chapter 3

## Operation

### Basic Operation

---

#### Operating Modes

The CE800B USB KVM Extender utilizes three operating modes: Auto, Local, and Remote, as described in the table below:

Mode	Description
Local	Only the local console has complete access. Although operators at both consoles can see the display, only the local console operator has keyboard and mouse access and control.
Remote	Only the remote console has complete access. Although operators at both consoles can see the display, only the remote console operator has keyboard and mouse access and control.
Auto	Both consoles have access but neither has complete input control. The first console to create keyboard or mouse input takes control. Following this, if there is no input for five seconds, the CE800B goes back to Auto Mode.

#### Mode Selection

The *Operating Mode Selection Switch*, located on each unit's front panel, controls the operating mode of the CE800B USB KVM Extender system. Pressing the switch toggles the operating mode as follows:

Switch	Action
Local (CE800BL) Selection Switch	Toggles between Auto and Local. In Local Mode, only the local console has keyboard and mouse access and control of the computer (or computers via KVM switch).
Remote (CE800BR) Selection Switch	Toggles between Auto and Remote. In Remote Mode, only the remote console has keyboard and mouse access and control of the computer (or computers via KVM switch).

When the system is in Local Mode, the Remote unit's selection switch is inactive. Pressing it has no effect – the Remote operator cannot take over control. The Remote selection switch only becomes active after the Local selection switch is pressed to put the system back into Auto Mode.

Likewise, if the system is in Remote Mode, the Local unit's selection switch is inactive – the Local operator cannot take over control. The Local selection switch only becomes active after the Remote selection switch is pressed to put the system back into Auto Mode.

## **Picture Compensation**

The quality of the video display can deteriorate with distance. The Picture Compensation switches adjust the picture quality of the remote console.

Depending on the distance from the console, if it becomes necessary to adjust the video signal, press the plus button (+) to increase the video signal gain; press the minus button (-) to decrease the video signal gain.

## **LED Display**

The CE800B Local and Remote Units have front panel LEDs to indicate their operating status, as shown in the following tables:

### **CE800BL (Local Unit)**

<b>LED</b>	<b>Status</b>	<b>Indication</b>
Local	On	Local Mode is in effect. The Local console has keyboard and mouse input control.
	Off	Remote Mode is in effect. The Remote console has keyboard and mouse input control.
	Flashing	Auto Mode is in effect. The first console to establish keyboard or mouse input takes control.
Remote	On	Remote Mode is in effect. The Remote console has keyboard and mouse input control.
	Off	Local Mode is in effect. The Local console has keyboard and mouse input control.
	Flashing	Auto Mode is in effect. The first console to establish keyboard or mouse input takes control.

## CE800BR (Remote Unit)

LED	Status	Indication
Remote	On	Remote Mode is in effect. The Remote console has keyboard and mouse input control.
	Off	Local Mode is in effect. The Local console has keyboard and mouse input control.
	Flashing	Auto Mode is in effect. Neither console has keyboard and mouse input control. The first console to establish keyboard or mouse input takes control. Following this, if there is no input for five seconds, the CE800B goes back to Auto Mode.
Link	On	The CE800BR is connected to the CE800BL.
	Off	The CE800BR is not connected to the CE800BL.
Compensation	Flashing	A picture compensation button has been pushed (+ or -) and the CE800B is adjusting the gain.
	Steady	Gain adjustment has been completed and saved.

## **USB Mass Storage**

Both the CE800BL and the CE800BR have a built-in USB port that complies with the USB Mass Storage specification and supports USB Mass Storage compliant flash drives, allowing easy and convenient file transfer.

When you plug a USB Mass Storage compliant flash drive into either unit's USB port, it shows up as a removable drive on the computer.

As a security measure, to help prevent unauthorized file transfers, if a flash drive is plugged into the USB port of the Remote unit, the OSD login screen comes up (see page 20). The operator must log in with a valid username and password before being able to continue.

## OSD Operation

---

### Overview

The CE800B USB KVM Extender provides a convenient menu driven On Screen Display (OSD) to handle its configuration parameters. All procedures start from the OSD Main Screen. To pop up the Main Screen:

1. Tap the **OSD Hotkey** (Scroll Lock) twice.

---

**Note:** [Scroll Lock] is the default OSD hotkey. You can optionally change the hotkey to the Ctrl key (see *OSD HOTKEY*, page 22, and see *Alternate OSD Activation Keys*, page 26).

---

The login dialog box appears:

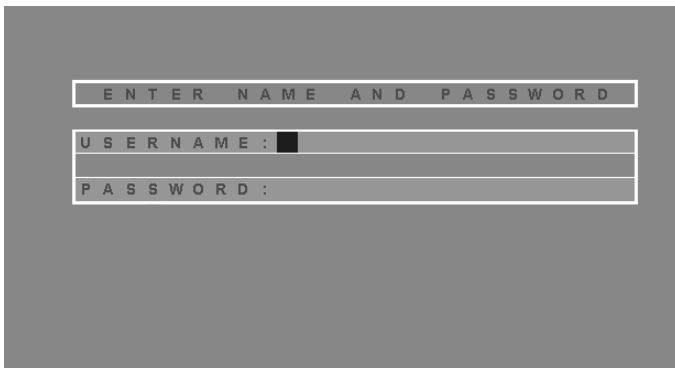

2. Key in a valid username and password, then press **[Enter]**.

---

**Note:** If this is the first time that the OSD is being run, or if the password function has not been set, simply press **[Enter]**. The OSD Main Screen comes up in Administrator Mode. In this mode, you have Administrator privileges, with access to all Administrator and User functions, and can set up operations (including password authorization for the future), as you would like.

---

## Administrator Main Screen

After you log in to the OSD, if you are the administrator, a screen similar to the one below appears:

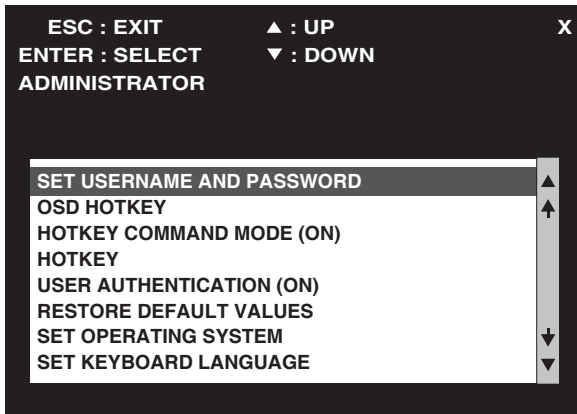

---

**Note:** If you are an ordinary user, see *User Configuration*, page 24

---

## OSD Navigation

The following principles govern the way you navigate through the OSD:

- ◆ To dismiss the menu, and deactivate the OSD, Click the **X** at the upper right corner of the OSD Window; or press **[Esc]**.
- ◆ To move up or down through the list one line at a time, Click the Up and Down Triangle symbols (▲▼) or use the Up and Down Arrow Keys.
- ◆ To select a menu item click it or move the highlight bar to it with the arrow keys, then press **[Enter]**.
- ◆ If a submenu appears, make your choice either by double clicking it, or moving the highlight bar to it, then pressing **[Enter]**. An icon of a pointing finger indicates the currently selected choice.

## **Administrator Configuration**

The configuration settings that the administrator is allowed to make are explained in the following table:

<b>Setting</b>	<b>Function</b>
SET USERNAME AND PASSWORD	<p>This function is used to set Usernames and Passwords for the Administrator and Users:</p> <ol style="list-style-type: none"> <li>1. One Administrator and four User passwords can be set.</li> <li>2. After you select the Administrator field or one of the User fields, a screen that allows you to key in your username and password appears. The username and password may be up to 12 characters long, and can consist of any combination of letters and numbers.</li> <li>3. For each individual, key in the Username and Password, then press <b>[Enter]</b>.</li> </ol> <p>To modify or delete a previous Username and/or Password, use the backspace key to erase individual letters or numbers.</p>
OSD HOTKEY	<p>Selects which Hotkey activates the OSD function: <b>[Scroll Lock] [Scroll Lock] or [Ctrl] [Ctrl]</b>.</p> <p>Since the Ctrl key combination may conflict with programs running on the computers.</p> <p>The default is the Scroll Lock combination.</p>
HOTKEY COMMAND MODE	<p>Enables / Disables the Hotkey Command function. If the hotkey combinations conflict with programs running on the computers, you may want to disable hotkey operation by turning Hotkey Command Mode Off.</p> <p>The default is On, which allows hotkey operation of the switch.</p>
HOTKEY	<p>Selects which combination activates <i>Hotkey Setting Mode</i> (HSM): <b>[Num Lock] + [-] or [Ctrl] + [F12]</b></p> <p>The default is [Num Lock] + [-]</p> <p>See <i>Hotkey Setting Mode</i>, page 25 for further details.</p>
USER AUTHENTICATION	<p>If this setting is On, users have to provide a Username and Password when they plug a flash drive into the USB port of the Remote unit.</p> <p>The default is On.</p>

---

Setting	Function
RESTORE DEFAULT VALUES	Selecting <b>Y</b> (Yes) undoes all changes and returns the CE800B's setup to the original factory default settings.
SET OPERATING SYSTEM	This function specifies the operating platform of the computer attached to the CE800B. Choices are Win, Mac, Sun, and SPC*. The default is Win
SET KEYBOARD LANGUAGE	Selects the keyboard layout used by the computer connected to the CE800B. Choices are Auto, English, French, German, and Japanese. <i>Auto</i> automatically detects the keyboard layout set for the computer and sets the CE800B accordingly. The default is Auto.

---

\* SPC stands for Special Case. For certain operating systems (such as FSBD), you may need to choose this option if you run into startup problems. If this occurs, please contact technical support for further information.

---

## User Configuration

The CE800B USB KVM Extender supports up to four user accounts in addition to the administrator. When users invoke the OSD, they get an OSD Main screen allows them to modify some of the configuration settings made by the administrator.

The User OSD Main Screen looks similar to the one, below:

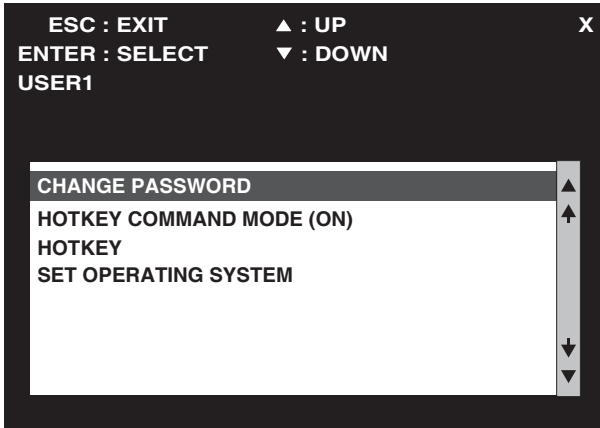

The configuration settings that users are allowed to make are explained in the table below:

Setting	Function
CHANGE PASSWORD	Users can use this function to change the password that was assigned to them by the administrator.
HOTKEY COMMAND MODE	These settings are the same as the ones described under <i>Administrator Configuration</i> , page 22.
HOTKEY	
SET OPERATING SYSTEM	



---

## Hotkey Setting Mode

---

In addition to the OSD, the administrator and users can also use hotkey combinations to configure a number of the CE800B USB KVM Extender's working environment parameters. All Hotkey operations begin by invoking Hotkey Setting Mode (HSM).

### Invoking HSM

To invoke HSM, do the following:

1. Hold down [**Num Lock**].
2. Press and release [**minus**].
3. Release [**Num Lock**].

---

**Note:** There is an alternative key combination to invoke HSM (see *Alternate HSM Invocation Keys*, page 26).

---

### **When Hotkey Mode is active:**

- ◆ The Caps Lock, and Scroll Lock LEDs flash in succession to indicate that HSM is in effect. They stop flashing and revert to normal status when you exit HSM.
- ◆ A Command Line appears on the monitor screen. The command line prompt is the word *Hotkey:* in yellow text on a blue background. Hotkey information that you key in displays on the command line.
- ◆ Ordinary keyboard and mouse functions are suspended – only Hotkey compliant keystrokes and mouse clicks (described in the sections that follow), can be input.
- ◆ At the conclusion of some hotkey operations, you automatically exit hotkey mode. With some operations, you must exit manually. To exit HSM manually, press [**Esc**] or [**Spacebar**].

## **Alternate HSM Invocation Keys**

An alternate set of HSM invocation keys is provided in case the default set conflicts with programs running on the computers.

To switch to the alternate HSM invocation set, do the following:

1. Invoke HSM (see page 25).
2. Press and release [**H**].

The HSM invocation keys become the Ctrl key (instead of Num Lock) and the F12 key (instead of minus).

---

**Note:** This procedure is a toggle between the two methods. To revert back to the original [Num Lock] [Minus] method, invoke HSM, then press and release the **H** key again.

---

## **Alternate OSD Activation Keys**

The OSD activation method can be changed from tapping the Scroll Lock key twice to tapping the Ctrl key twice ([Ctrl] [Ctrl]). To change the OSD activation method, do the following:

1. Invoke HSM (see page 25).
2. Press and release [**T**].

---

**Note:** 1. This procedure is a toggle between the two methods. To revert back to the original [Scroll Lock] [Scroll Lock] method, invoke HSM, then press and release the **T** key again.

2. For Mac systems we recommend using [Ctrl] [Ctrl] as the OSD activation keys since Scroll Lock is used to emulate F14 in PC to Mac keyboard emulation (see *Keyboard Emulation*, page 29).
-

## **Enable / Disable Hotkeys**

In case a conflict occurs with programs running on the computer, you may wish to disable the hotkey function. To disable the hotkey function do the following:

1. Invoke HSM (see page 25).
2. Press and release **[X] [Enter]**.

---

**Note:** This procedure is a toggle between enabling / disabling the hotkey function. To revert back to the original enabled status, invoke HSM, then press and release the **X** and **Enter** keys again.

---

## **Keyboard Operating Platform**

The CE800b's default configuration is for a PC Compatible keyboard operating platform. If you have a Mac or a Sun on your installation, you can change the keyboard operating platform as follows:

3. Invoke HSM (see page 25).
4. Press and release the appropriate Function key (see table).

<b>Key</b>	<b>Operation</b>
[F1]	Sets the PC compatible keyboard operating platform for the port that currently has the KVM focus.
[F2]	Sets the Mac keyboard operating platform for the port that currently has the KVM focus.
[F3]	Sets the Sun keyboard operating platform for the port that currently has the KVM focus.

- 
- Note:**
1. The brackets indicate the keys you should press. Simply press the indicated keys – do not type the brackets.
  2. After completing a setting, you automatically exit HSM.
-

## **USB Reset**

Sometimes the USB keyboard and mouse connection to the CE800B needs to be reset. Instead of unplugging and replugging them, a hotkey combination can perform the reset, as follows:

1. Invoke HSM (see page 25).
2. Press and release **[F5]**.

## **Hotkey Summary Table**

After invoking HSM (see page 25), key in one of the following keys to perform the corresponding function:

<b>Key</b>	<b>Function</b>
[H]	Toggles between the default ([Num Lock] [-]) and alternate ([Ctrl] [F12]) Hotkey invocation keys.
[T]	Toggles between the default ([Scroll Lock] [Scroll Lock]) and alternate ([Ctrl] [Ctrl]) OSD invocation keys.
[X] [Enter]	Toggles between Enabling / Disabling the hotkey function.
[F1]	Sets the PC compatible keyboard operating platform for the port that currently has the KVM focus.
[F2]	Sets the Mac compatible keyboard operating platform for the port that currently has the KVM focus.
[F3]	Sets the Sun keyboard operating platform for the port that currently has the KVM focus.
[F5]	Resets the USB keyboard and mouse.

---

**Note:** The brackets indicate the keys you should press. Simply press the indicated keys – do not type the brackets.

---









# Chapter 4

## Keyboard Emulation

### Mac Keyboard

---

The PC compatible (101/104 key) keyboard can emulate the functions of the Mac keyboard. The emulation mappings are listed in the table below.

PC Keyboard	Mac Keyboard
[Shift]	Shift
[Ctrl]	Ctrl
	
[Ctrl] [1]	
[Ctrl] [2]	
[Ctrl] [3]	
[Ctrl] [4]	
[Alt]	Alt
[Print Screen]	F13
[Scroll Lock]	F14
	=
[Enter]	Return
[Backspace]	Delete
[Insert]	Help
[Ctrl] 	F15







---

**Note:** When using key combinations, press and release the first key (Ctrl), then press and release the activation key.

---

## Sun Keyboard

The PC compatible (101/104 key) keyboard can emulate the functions of the Sun keyboard when the Control key [Ctrl] is used in conjunction with other keys. The corresponding functions are shown in the table below.

PC Keyboard	Sun Keyboard
[Ctrl] [T]	Stop
[Ctrl] [F2]	Again
[Ctrl] [F3]	Props
[Ctrl] [F4]	Undo
[Ctrl] [F5]	Front
[Ctrl] [F6]	Copy
[Ctrl] [F7]	Open
[Ctrl] [F8]	Paste
[Ctrl] [F9]	Find
[Ctrl] [F10]	Cut
[Ctrl] [1]	
[Ctrl] [2]	
[Ctrl] [3]	
[Ctrl] [4]	
[Ctrl] [H]	Help
	Compose
	

**Note:** When using key combinations, press and release the first key (Ctrl), then press and release the activation key.

# Chapter 5

## The Firmware Upgrade Utility

The Windows-based Firmware Upgrade Utility (FWUpgrade.exe) provides a smooth, automated process for upgrading the KVM switch's firmware.

The Utility comes as part of a Firmware Upgrade Package that is specific for each device. New firmware upgrade packages are posted on our web site as new firmware revisions become available. Check the web site regularly to find the latest packages and information relating to them:

<http://www.aten.com>

### Before You Begin

---

To prepare for the firmware upgrade, do the following:

1. Unplug the power adapters from both units, and disconnect the KVM cable (to the local computer) from the CE800BL's front panel.
2. Go to our Internet support site and choose the model name of your device (CE800B) to get a list of available Firmware Upgrade Packages.
3. Choose the Firmware Upgrade Package you want to install (usually the most recent), and download it to your computer.
4. Use the *Firmware Upgrade Cable* provided with this unit to connect a COM port on your computer to the CE800BL's *Firmware Upgrade Port*.

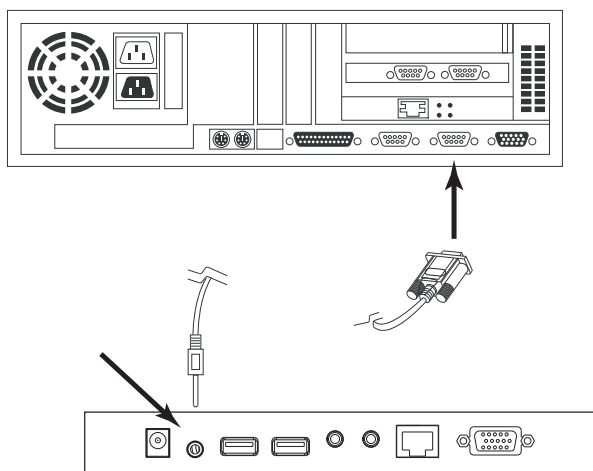

5. Make sure both units are connected by the Cat 5e cable, then plug in the Remote unit's power adapter.
6. Press and hold the Local unit's *Selection* button, then plug in the Local unit's power adapter.
7. Wait until both green front panel LEDs on the Local unit are flashing on and off, then release the *Selection* button.
8. Make sure the orange LED on the front panel of the Remote unit is on (indicating that *Firmware Upgrade Mode* is in effect).

---

**Note:** If the LED is not on, or it is blinking, the unit is not ready to be upgraded. You must repeat steps 6 and 7.

---



## Starting the Upgrade

To upgrade your firmware:

1. Run the downloaded Firmware Upgrade Package file – either by double clicking the file icon, or by opening a command line and entering the full path to it.

The Firmware Upgrade Utility *Welcome* screen appears:

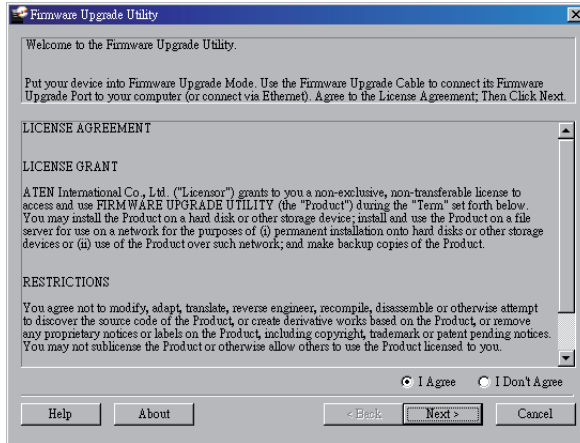

**Note:** The screens shown in this section are for reference only. The wording and layout of the actual screens put up by the Firmware Upgrade Utility may vary slightly from these examples.

2. Read and *Agree* to the License Agreement (enable the I Agree radio button).

*(Continues on next page.)*

3. Click **Next** to continue. The Firmware Upgrade Utility main screen appears:

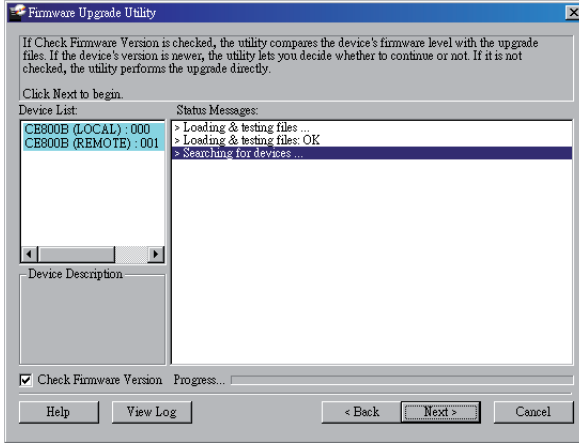

The Utility inspects your installation. All the devices capable of being upgraded by the package are listed in the *Device List* panel.

4. As you select a device in the list, its description appears in the *Device Description* panel.
5. After you have made your device selection(s), Click **Next** to perform the upgrade.

If you enabled *Check Firmware Version*, the Utility compares the device's firmware level with that of the upgrade files. If it finds that the device's version is higher than the upgrade version, it brings up a dialog box informing you of the situation and gives you the option to Continue or Cancel.

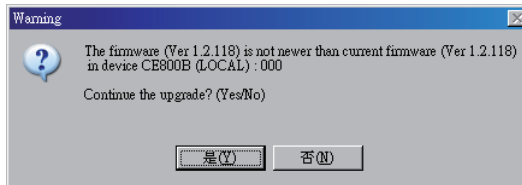

If you did not enable *Check Firmware Version*, the Utility installs the upgrade files without checking whether or not they are a higher level.

As the Upgrade proceeds, status messages appear in the Status Messages panel, and the progress toward completion is shown on the *Progress* bar.

## Upgrade Succeeded

After the upgrade has completed, a screen appears to inform you that the procedure was successful:

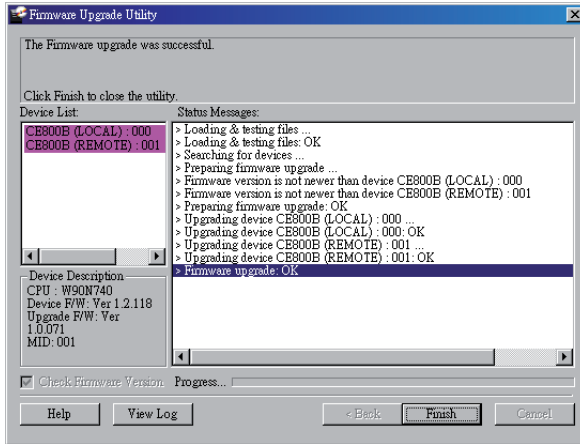

Click **Finish** to close the Firmware Upgrade Utility.

After successfully upgrading the firmware, the switches automatically exit Firmware Upgrade Mode. Please power the unit off and on after you have exited Firmware Upgrade Mode.

## Upgrade Failed

If the *Upgrade Succeeded* screen does not appear, then the upgrade failed to complete successfully. You should repeat the upgrade procedure from the beginning.

This Page Intentionally Left Blank

## Safety Instructions

---

### General

- ◆ Read all of these instructions. Save them for future reference.
- ◆ Follow all warnings and instructions marked on the device.
- ◆ To prevent damage to your installation it is important that all devices are properly grounded.
- ◆ Do not place the device on any unstable surface (cart, stand, table, etc.). If the device falls, serious damage will result.
- ◆ Do not use the device near water.
- ◆ Do not place the device near, or over, radiators or heat registers.
- ◆ The device cabinet is provided with slots and openings to allow for adequate ventilation. To ensure reliable operation, and to protect against overheating, these openings must never be blocked or covered.
- ◆ The device should never be placed on a soft surface (bed, sofa, rug, etc.) as this will block its ventilation openings. Likewise, the device should not be placed in a built in enclosure unless adequate ventilation has been provided.
- ◆ Never spill liquid of any kind on the device.
- ◆ Unplug the device from the wall outlet before cleaning. Do not use liquid or aerosol cleaners. Use a damp cloth for cleaning.
- ◆ The device should be operated from the type of power source indicated on the marking label. If you are not sure of the type of power available, consult your dealer or local power company.
- ◆ Do not allow anything to rest on the power cord or cables. Route the power cord and cables so that they cannot be stepped on or tripped over.
- ◆ If an extension cord is used with this device make sure that the total of the ampere ratings of all products used on this cord does not exceed the extension cord ampere rating. Make sure that the total of all products plugged into the wall outlet does not exceed 15 amperes.
- ◆ To help protect your system from sudden, transient increases and decreases in electrical power, use a surge suppressor, line conditioner, or un-interruptible power supply (UPS).

- ◆ Position system cables and power cables carefully; Be sure that nothing rests on any cables.
- ◆ When connecting or disconnecting power to hot-pluggable power supplies, observe the following guidelines:
  - ◆ Install the power supply before connecting the power cable to the power supply.
  - ◆ Unplug the power cable before removing the power supply.
  - ◆ If the system has multiple sources of power, disconnect power from the system by unplugging all power cables from the power supplies.
- ◆ Never push objects of any kind into or through cabinet slots. They may touch dangerous voltage points or short out parts resulting in a risk of fire or electrical shock.
- ◆ Do not attempt to service the device yourself. Refer all servicing to qualified service personnel.
- ◆ If the following conditions occur, unplug the device from the wall outlet and bring it to qualified service personnel for repair.
  - ◆ The power cord or plug has become damaged or frayed.
  - ◆ Liquid has been spilled into the device.
  - ◆ The device has been exposed to rain or water.
  - ◆ The device has been dropped, or the cabinet has been damaged.
  - ◆ The device exhibits a distinct change in performance, indicating a need for service.
  - ◆ The device does not operate normally when the operating instructions are followed.
- ◆ Only adjust those controls that are covered in the operating instructions. Improper adjustment of other controls may result in damage that will require extensive work by a qualified technician to repair.

---

## **Rack Mounting**

- ◆ Before working on the rack, make sure that the stabilizers are secured to the rack, extended to the floor, and that the full weight of the rack rests on the floor. Install front and side stabilizers on a single rack or front stabilizers for joined multiple racks before working on the rack.
- ◆ Always load the rack from the bottom up, and load the heaviest item in the rack first.
- ◆ Make sure that the rack is level and stable before extending a device from the rack.
- ◆ Use caution when pressing the device rail release latches and sliding a device into or out of a rack; the slide rails can pinch your fingers.
- ◆ After a device is inserted into the rack, carefully extend the rail into a locking position, and then slide the device into the rack.
- ◆ Do not overload the AC supply branch circuit that provides power to the rack. The total rack load should not exceed 80 percent of the branch circuit rating.
- ◆ Ensure that proper airflow is provided to devices in the rack.
- ◆ Do not step on or stand on any device when servicing other devices in a rack.

## Technical Support

---

### International

- ◆ For online technical support – including troubleshooting, documentation, and software updates: <http://support.aten.com>
- ◆ For telephone support, see *Telephone Support*, page iii

### North America

Email Support		<a href="mailto:support@aten-usa.com">support@aten-usa.com</a>
Online Technical Support	Troubleshooting Documentation Software Updates	<a href="http://www.aten-usa.com/support">http://www.aten-usa.com/support</a>
Telephone Support		1-888-999-ATEN ext 4988

When you contact us, please have the following information ready beforehand:

- ◆ Product model number, serial number, and date of purchase.
- ◆ Your computer configuration, including operating system, revision level, expansion cards, and software.
- ◆ Any error messages displayed at the time the error occurred.
- ◆ The sequence of operations that led up to the error.
- ◆ Any other information you feel may be of help.



# Specifications

Function			CE800BL	CE800BR	
Computer Connections			1	N/A	
Connectors	Console	Keyboard	1 x USB Type A Female (White)		
		Video	1 x HDB-15 Female (Blue)		
		Mouse	1 x USB Type A Female (White)		
		Speaker	1 x Mini Stereo Jack (Green)		
		Microphone	1 x Mini Stereo Jack (Pink)		
	KVM Ports	Keyboard / Video / Mouse	1 x SPHD-15 Female (Yellow)	N/A	
		USB Port	1 x USB Type B (Female) 1 x USB Type A (Female)	1 x USB Type A (Female)	
		Speaker	1 x Mini Stereo Jack (Green)	N/A	
		Microphone	1 x Mini Stereo Jack (Pink)	N/A	
	F/W Upgrade		1 x 4-conductor 3.5 mm jack	N/A	
	Power		1 x DC Jack (Black)		
	Unit to Unit (Link)		1 x RJ-45		
	Pushbuttons	Operating Mode Selection		1 x Pushbutton	
Picture Compensation		N/A	2 x Pushbutton		
LEDs	Local		1 (Green)	N/A	
	Remote		1 (Green)	1 (Green)	
	Link		N/A	1 (Green)	
	Compensation		N/A	1 (Orange)	
Power Consumption			DC 5.0 V; 6.0 W		
Video			1920 x 1200 @ 60 Hz, 30 m 1600 x 1200 @ 60 Hz, 150 m 1024 x 768 @ 60 Hz, 250 m		
Environment	Operating Temp.		0–50°C		
	Storage Temp.		-20–60°C		
	Humidity		0–80% RH		
Physical Properties	Housing		Metal		
	Weight		0.50 kg	0.49 kg	
	Dimensions (L x W x H)		20.00 x 8.00 x 2.50 cm		

## Troubleshooting

Operation problems can be due to a variety of causes. The first step in solving them is to make sure that all cables are securely attached and seated completely in their ports.

In addition, updating the product's firmware may solve problems that have been discovered and resolved since the prior version was released. If your product is not running the latest firmware version, we strongly recommend that you upgrade. See *The Firmware Upgrade Utility*, page 31, for upgrade details.

Problem	Action
No video	Make sure that all cables are securely plugged into their ports.
Poor video quality.	The video quality can be improved by reducing the refresh rate.
Touchscreen does not work.	To include a touchscreen in your CE800B installation, you must purchase an additional USB extender.
Keyboard hotkeys do not work when combining a KVM switch in the installation.	Check that the USB cable that connects to the KVM switch is connected to the Type A keyboard port and not the mouse port.

## TP Wiring Diagram / TP Pin Assignments

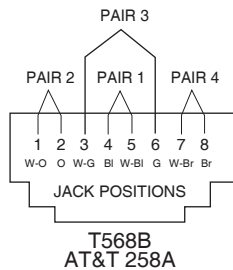

Pin	Assignment	Pin	Assignment
1	/V OUT B	5	V OUT R
2	V OUT B	6	V OUT G
3	/V OUT G	7	/DO
4	/V OUT R	8	DO

---

## Clear Login Information

---

If you are unable to perform an Administrator login (because the Username and Password information has become corrupted or you have forgotten it, for example) you can clear the login information with the following procedure:

1. Power off the CE800B and remove its housing.
2. Short the jumper labeled **J7**.

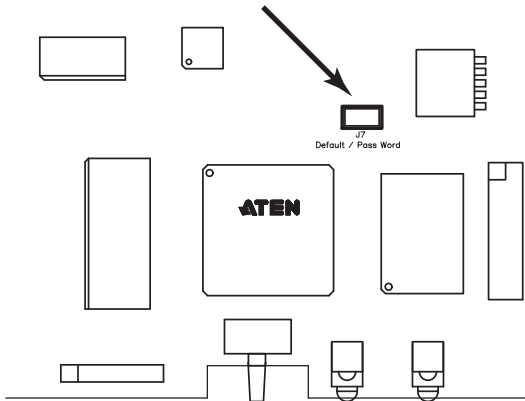

3. Power on the switch.  
The on screen display will show a message informing you that the password information has been cleared.
4. Power off the switch.
5. Remove the jumper cap from **J7**.
6. Close the housing and start the CE800B back up.

After you start back up, you can use the default Username and Password (see *Overview*, page 20) to log in.

## About SPHD Connectors

---



This product uses SPHD connectors for its KVM and/or Console ports. We have specifically modified the shape of these connectors so that only KVM cables that we have designed to work with this product can be connected.

## Limited Warranty

---

IN NO EVENT SHALL THE DIRECT VENDOR'S LIABILITY EXCEED THE PRICE PAID FOR THE PRODUCT FROM DIRECT, INDIRECT, SPECIAL, INCIDENTAL, OR CONSEQUENTIAL DAMAGES RESULTING FROM THE USE OF THE PRODUCT, DISK, OR ITS DOCUMENTATION.

The direct vendor makes no warranty or representation, expressed, implied, or statutory with respect to the contents or use of this documentation, and especially disclaims its quality, performance, merchantability, or fitness for any particular purpose.

The direct vendor also reserves the right to revise or update the device or documentation without obligation to notify any individual or entity of such revisions, or update. For further inquiries, please contact your direct vendor.

---

## A

- Administrator Configuration 22
- Alternate OSD keys 26

## B

- Basic Operation 17

## C

- Change Password 24
- Clear login information 43
- Configuration
  - Administrator 22
  - User 24

## D

- default password 43
- Display 18

## E

- Enable/Disable hotkeys 27

## G

- Grounding 11

## H

- Hotkey 22
  - Command Mode 22
  - Keyboard Operating Platform 27
  - Operation 25
  - OSD 22
  - Summary Table 28
- Hotkey Mode 25
- Hotkeys
  - Enable/Disable 27

## I

- Installation
  - Grounding 11

## K

- Keyboard Emulation
  - Mac 29
  - Sun 30
- Keyboard Language 23
- Keyboard Operating Platform 27

## M

- Mode Selection 17

## O

- Online
  - Registration iii
- Operating Modes 17
- Operating System 23
- OSD
  - Administrator Main Screen 21
  - Alternate activation keys 26
  - Hotkey 20, 22
  - Main Screen 20
  - Overview 20
  - Password 20

## P

- Password 20, 22
  - changing 24
- Picture Compensation 18

## R

- Rack mounting 9
  - Safety information 39
- Reset administrator password 43
- Reset USB 28
- Restore Default Values 23
- RoHS ii

## S

- Safety Instructions
  - General 37

Rack mounting 39

**SET**

Password 22

SJ/T 11364-2006 ii

**T**

Technical Support 40

Telephone support iii

**U**

**USB**

Reset 28

USB Mass Storage 19

User Authentication 22

User Configuration 24

User Notice iii

Username 22

## Free Manuals Download Website

<http://myh66.com>

<http://usermanuals.us>

<http://www.somanuals.com>

<http://www.4manuals.cc>

<http://www.manual-lib.com>

<http://www.404manual.com>

<http://www.luxmanual.com>

<http://aubethermostatmanual.com>

Golf course search by state

<http://golfingnear.com>

Email search by domain

<http://emailbydomain.com>

Auto manuals search

<http://auto.somanuals.com>

TV manuals search

<http://tv.somanuals.com>