

USB to Bluetooth KM Switch
CS533 Tap
User Manual



www.aten.com

FCC Information

This is an FCC Class A product. In a domestic environment this product may cause radio interference in which case the user may be required to take adequate measures.

This equipment has been tested and found to comply with the limits for a Class A digital device, pursuant to Part 15 of the FCC Rules. These limits are designed to provide reasonable protection against harmful interference when the equipment is operated in a commercial environment. This equipment generates, uses and can radiate radio frequency energy and, if not installed and used in accordance with the instruction manual, may cause harmful interference to radio communications. Operation of this equipment in a residential area is likely to cause harmful interference in which case the user will be required to correct the interference at his own expense.

RoHS

This product is RoHS compliant.

SJ/T 11364-2006

The following contains information that relates to China.

部件名称	有毒有害物质或元素					
	铅	汞	镉	六价铬	多溴联苯	多溴二苯醚
电器部件	●	○	○	○	○	○
机构部件	○	○	○	○	○	○

- : 表示该有毒有害物质在该部件所有均质材料中的含量均在SJ/T 11363-2006规定的限量要求之下。
- : 表示符合欧盟的豁免条款, 但该有毒有害物质至少在该部件的某一均质材料中的含量超出SJ/T 11363-2006的限量要求。
- ×: 表示该有毒有害物质至少在该部件的某一均质材料中的含量超出SJ/T 11363-2006的限量要求。



User Information

Online Registration

Be sure to register your product at our online support center:

International	http://eservice.aten.com
---------------	---

Telephone Support

For telephone support, call this number:

International	886-2-8692-6959
China	86-10-5255-0110
Japan	81-3-5615-5811
Korea	82-2-467-6789
North America	1-888-999-ATEN ext 4988
United Kingdom	44-8-4481-58923

User Notice

All information, documentation, and specifications contained in this manual are subject to change without prior notification by the manufacturer. The manufacturer makes no representations or warranties, either expressed or implied, with respect to the contents hereof and specifically disclaims any warranties as to merchantability or fitness for any particular purpose. Any of the manufacturer's software described in this manual is sold or licensed *as is*. Should the programs prove defective following their purchase, the buyer (and not the manufacturer, its distributor, or its dealer), assumes the entire cost of all necessary servicing, repair and any incidental or consequential damages resulting from any defect in the software.

The manufacturer of this system is not responsible for any radio and/or TV interference caused by unauthorized modifications to this device. It is the responsibility of the user to correct such interference.

The manufacturer is not responsible for any damage incurred in the operation of this system if the correct operational voltage setting was not selected prior to operation. PLEASE VERIFY THAT THE VOLTAGE SETTING IS CORRECT BEFORE USE.

Package Contents

Package

The CS533 Tap package consists of:

- ◆ 1 CS533 Tap USB to Bluetooth KM Switch
- ◆ 1 Plastic backing
- ◆ 2 Hotkey Stickers
- ◆ 1 User Instructions*



Check to make sure that all the components are present and that nothing got damaged in shipping. If you encounter a problem, contact your dealer.

Read this manual thoroughly and follow the installation and operation procedures carefully to prevent any damage to the unit, and/or any of the devices connected to it.

* Features may have been added to the CS533 Tap since this manual was published. Please visit our website to download the most up-to-date version.

© Copyright 2013 ATEN® International Co., Ltd.

FW Version: V1.1.106
Manual Date: 2013-10-17

ATEN and the ATEN logo are registered trademarks of ATEN International Co., Ltd. All rights reserved.
All other brand names and trademarks are the registered property of their respective owners.

Contents

FCC Information	ii
RoHS	ii
SJ/T 11364-2006	ii
User Information	iii
Online Registration	iii
Telephone Support	iii
User Notice	iii
Package Contents	iv
Package	iv
About this Manual	vii
Conventions	viii
Product Information	viii
1. Introduction	
Overview	1
Requirements	2
Device	2
Computer	2
Keyboard and Mouse	2
USB Power Adapter (optional)	2
Operating Systems	2
Mobile Devices*	2
Components	3
Rear / Front View	3
Plastic Stand	4
2. Setup	
Getting Started	5
Connecting Hardware	5
Connecting Bluetooth	6
3. Input Method Editor (IME)	
Overview	10
4. Advanced Functions	
Overview	11
Hotkeys	11
Switching	14
Keyboard Mapping	16
Keyboard Layout	16
Setting the Keyboard Layout	16
Key Mapping Stickers	17
Standard Keyboard Commands	17
Clearing Bluetooth	18
Disconnecting Bluetooth	19

Reset Settings 20
Seamless Switching Mode 21
Firmware Upgrade 22

Appendix

Safety Instructions 27
 General 27
Technical Support 29
 International 29
 North America 29
Specifications 30
Compatible Mobile Devices 31
Standard Keyboard Commands 33
Keyboard Mapping Tables 35
Troubleshooting 44
 Overview 44
Limited Warranty 45

About this Manual

This User Manual is provided to help you get the most from your system. It covers all aspects of installation, configuration and operation. An overview of the information found in the manual is provided below.

Chapter 1, *Introduction*, introduces you to the CS533 Tap. Its purpose, features, benefits, and requirements are presented, and its front and back panel components are described.

Chapter 2, *Setup*, describes how to set up your CS533. The necessary steps for basic hardware and Bluetooth setup are provided.

Chapter 3, *Input Method Editor (IME)*, explains the IME feature for international users and how to use IME with your device.

Chapter 4, *Advanced Functions*, provides a complete description of the CS533's advanced functions, which include Hotkeys, Switching, Keyboard Mapping, Clearing Bluetooth, Settings, and Firmware Upgrades.

An Appendix, provides specifications, troubleshooting, and other technical information regarding the CS533 Tap.

Conventions

This manual uses the following conventions:

- Monospaced Indicates text that you should key in.
- [] Indicates keys you should press. For example, [Enter] means to press the **Enter** key. If keys need to be chorded, they appear together in the same bracket with a plus sign between them: [Ctrl+Alt].
1. Numbered lists represent procedures with sequential steps.
- Indicates selecting the option (on a menu or dialog box, for example), that comes next. For example, Start → Run means to open the *Start* menu, and then select *Run*.
-  Indicates critical information.

Product Information

For information about all ATEN products and how they can help you connect without limits, visit ATEN on the Web or contact an ATEN Authorized Reseller. Visit ATEN on the Web for a list of locations and telephone numbers:

International	http://www.aten.com
North America	http://www.aten-usa.com

Chapter 1

Introduction

Overview

The CS533 Tap is a Bluetooth link that allows you to use a desktop keyboard and mouse* on a mobile device. With the CS533 you can use a desktop keyboard on your mobile device to compose and send text messages, e-mails, and instant messages; plus work within smartphone applications.



The CS533 allows you to:

- ◆ Wirelessly connect mobile devices to a desktop keyboard and mouse
- ◆ Use a desktop USB keyboard and mouse* on your mobile device
- ◆ Share a USB keyboard and mouse with a computer and 2 mobile devices
- ◆ Tap to switch USB keyboard and mouse use between devices

*Mouse functionality only available on select mobile devices.

Requirements

Device

- ◆ 1 Mobile Device with Bluetooth

Computer

- ◆ 1 Computer with Type A USB Port

Keyboard and Mouse

- ◆ 1 USB Keyboard
- ◆ 1 USB Mouse

USB Power Adapter (optional)

The CS533 can connect a mobile device to a USB keyboard and mouse without a computer. If you use the CS533 without a computer, a USB Power Adapter must be purchased to power the CS533.

Operating Systems

Supported operating systems are shown in the table, below:

OS	Version
Windows	2000 and higher
Mac	OS 10.6 and higher

Mobile Devices*

Supported Apple devices are shown in the table below:

Apple	iPad 1, 2, The new iPad, and above	iOS 4.2.1 and higher
	iPhone 3GS, 4, 4S, and above	
	iPod touch 2nd, 3rd, 4th Generation, and above	

*For a complete list of supported mobile devices see *Compatible Mobile Devices*, page 31.

Components

Rear / Front View

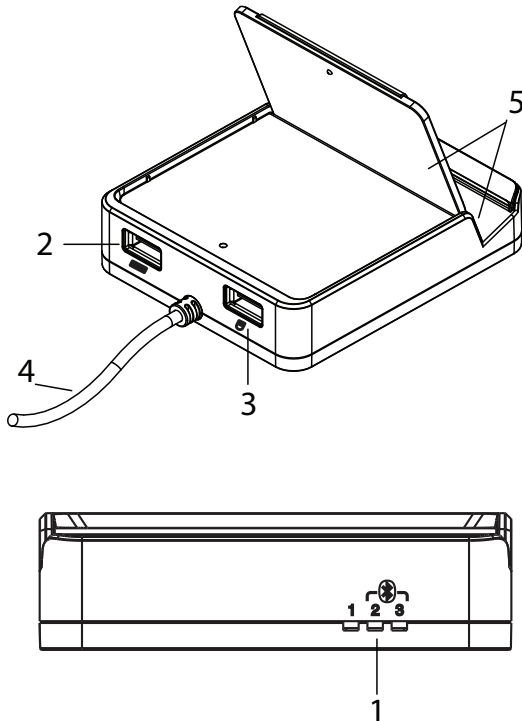

No.	Component	Description
1	Port LED's	Blue LED: light indicates which device is selected for keyboard and mouse use: 1. Computer 2. Bluetooth #1 3. Bluetooth #2
2	Keyboard Port	Plug the USB keyboard into this port.
3	Mouse Port	Plug the USB mouse into this port.
4	USB Cable	Plug this cable into the computer which will share keyboard and mouse use.
5	Cradle / Plastic Stand	Cradle with plastic stand to hold your mobile device upright and in place. (See <i>Plastic Stand</i> , page 4, for details)

Plastic Stand

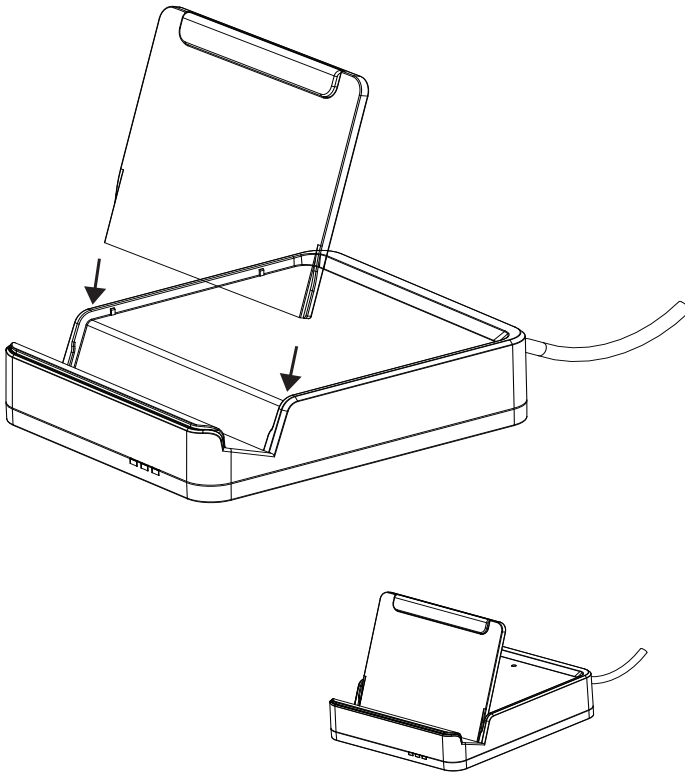

Insert the plastic stand as shown above and place the mobile device in the cradle upright to hold it in place.

Chapter 2 Setup

Getting Started

To begin using the CS533 with your mobile device requires two steps, explained in this chapter:

1. Connecting the Hardware
2. Connecting Bluetooth

Connecting Hardware

1. Plug the CS533's USB cable into the computer.
2. Unplug the USB keyboard from the computer, and plug it into the CS533.
3. Unplug the USB mouse from the computer, and plug it into the CS533.

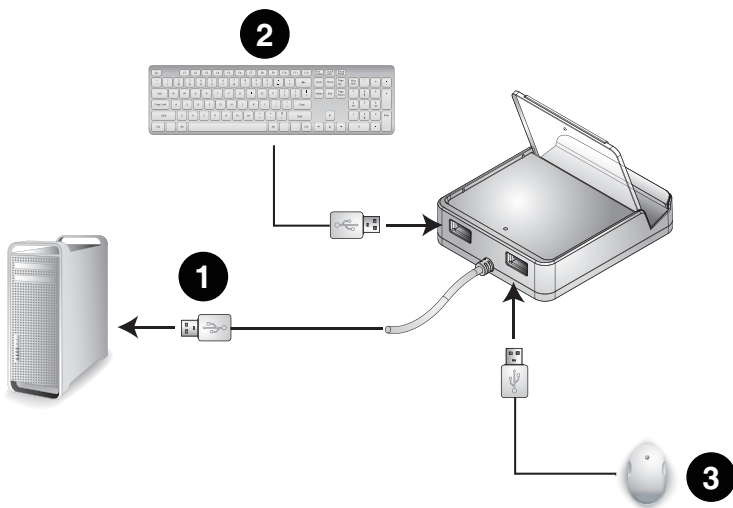

(Continues on next page.)

(Continued from previous page.)

- Note:** 1. If you are using a wireless keyboard and mouse, be sure to plug the wireless receiver into the CS533's keyboard port.
2. By default when the CS533 is plugged into a computer, it switches to port #2 to connect a Bluetooth device. If you would like to switch the keyboard and mouse back for use on the computer, use hotkey: **[Alt][Alt]** to switch to port #1 (see *Hotkeys*, page 11).
-

Connecting Bluetooth

To connect your iPad/iPhone via Bluetooth, do the following:

1. When you plug the CS533 into a computer, it switches to Bluetooth port #2, and the LED light flashes:



2. Place your iPad/iPhone on the CS533:



3. From the Home Screen on your iPad/iPhone, go to: **Settings**:



4. Select **General**, then **Bluetooth**:



5. Turn Bluetooth **On**.



6. With Bluetooth **On**, your iPad/iPhone will search for devices:



7. When the CS533 is discovered, it appears on the screen.



8. Select CS533 from the iPad/iPhone, as shown above.

9. A message will appear on the iPad/iPhone screen:



10. From the USB keyboard, type the PIN code that appears on your iPad/iPhone, and press **Enter**.



Note: If Bluetooth does not pair with your device, repeat starting at step 7.

11. The CS533 appears on the iPad/iPhone as **Connected**:



12. The keyboard is now connected and ready for use on the iPad/iPhone:



13. To switch the keyboard back to your computer, press:

Alt

Alt

Note: 1. If you have a problem with the Bluetooth connection, see *Clearing Bluetooth*, page 18, and repeat the steps above.

2. To connect a second Bluetooth device to the CS533, repeat the instructions above, using **[Alt]+[F3]** for step 1.

3. To change Keyboard Mappings for better use with mobile devices, See *Keyboard Mapping*, page 16, for details.

Chapter 3

Input Method Editor (IME)









Overview

IME is a system component that sets English keyboards to use characters of other languages. If your device is used exclusively in English, you can skip this chapter.

An Input Method Editor (IME) is an operating system component that allows users to enter characters and symbols not found on standard English keyboards. For example; this allows users on English keyboards to input Chinese, Korean, Japanese, or Indic characters.

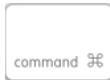
To change your keyboard language using the IME on your computer or mobile device, do the following:

1. From the USB keyboard switch to the CS533 port for your device.
2. Toggle IME on/off from the USB keyboard, using the hotkey:

Keyboard Type	iOS/Mac	Windows
PC	 + 	 + 
Apple	 + 	 + 

3. Once IME is enabled, the device will use characters of the language setup for your device.

Note: It is recommended that iPad/iPhone users upgrade to iOS 6, as this version provides the most effective IME component for typing in alternate languages.

Chapter 4

Advanced Functions

Overview















This chapter discusses the advanced functions of the CS533. Advanced functions include: Hotkeys, Switching, Keyboard Mapping, Clearing and Disconnecting Bluetooth, Resetting, and Firmware Upgrades.

Hotkeys

This chart lists the *Hotkeys*, *Function*, and *Page* for additional information.

“+” means: hold-down [Alt], then press the second hotkey.

Function	Hotkey	Page
Switch to Port 1 Switches keyboard and mouse to the Computer.	Alt + F1	14
Switch to Port 2 Switches keyboard and mouse to the Bluetooth Device.	Alt + F2	
Switch to Port 3 Switches keyboard and mouse to the Bluetooth Device.	Alt + F3	
Switch Back Switch to the previous port.	Alt Alt	

Function	Hotkey	Page
Clear Bluetooth Pairing Clears Bluetooth pair	 + 	18
Reset Settings Resets the CS533 settings.	 + 	20
Disconnect Bluetooth Disconnects Bluetooth Connection	 + 	19
Firmware Upgrade Invokes Firmware Upgrade Mode.	 +  then  then 	22
Enable Keyboard Mapping Sets the <i>QWERTY</i> keyboard mapping.	 +  then  then 	16

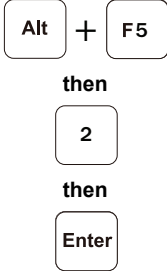
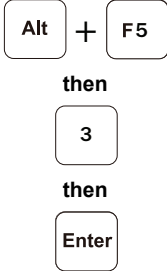
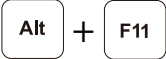
Function	Hotkey	Page
Enable Keyboard Mapping: Sets the <i>Mac</i> keyboard mapping.	 <p>Alt + F5 then 2 then Enter</p>	16
Enable Keyboard Mapping: Sets the <i>iPad/iPhone</i> keyboard mapping.	 <p>Alt + F5 then 3 then Enter</p>	16
Enable/Disable Seamless Switching Mode: Toggles Seamless Switching off and on.	 <p>Alt + F11</p>	21

Switching

Hotkeys are used from the USB keyboard to select a device:

Computer, Bluetooth Device 1, or Bluetooth Device 2.



The LED light indicates the **port** that is selected for keyboard and mouse use:

1. Computer
2. Bluetooth Device (1)
3. Bluetooth Device (2)



Switching Between Devices

1. To switch the keyboard and mouse to the **Computer**, from the USB keyboard press:

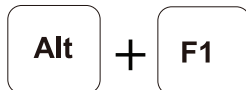

“+” means: hold-down [Alt], then press the second hotkey.

2. To switch the keyboard and mouse to **Bluetooth Device (1)**, from the USB keyboard press:

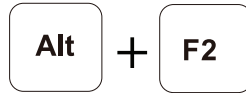

3. To switch the keyboard and mouse to **Bluetooth Device (2)**, from the USB keyboard press:

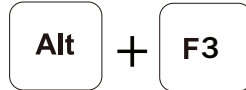

4. To switch the keyboard and mouse **Back** to the previous port, from the USB keyboard press:



Keyboard Mapping

Mapping a USB keyboard allows a standard Windows keyboard to work like a Mac or iPad/iPhone keyboard; or a Mac keyboard to work like a Windows keyboard. This allows your desktop keyboard to function as the keyboard of the device (iPhone/iPad, Android, Mac) it is connected to.

Keyboard Layout

Select the layout for your device, then set a CS533 port to use that layout. For example: if your iPhone uses port #2 on the CS533, set port #2 to use the **iPad/iPhone** layout.

Layout	Device
QWERTY	Windows PC, Android
Mac	Mac Computer
iPad/iPhone	iPad, iPhone, iPod touch

Setting the Keyboard Layout

Use the instructions below to set a keyboard layout on a CS533 port:

1. From the USB keyboard, select a port by pressing:

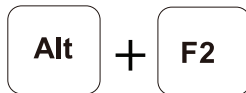

–or–

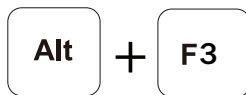

“+” means: hold-down [Alt], then press the second hotkey.

2. Enable *Keyboard Mapping*, by pressing:

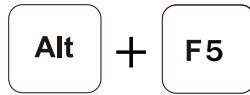

3. Change the port layout to *QWERTY*, by pressing:



–or–

change the port layout to *Mac*, by pressing:

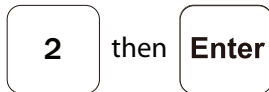

–or–

change the port layout to *iPad/iPhone*, by pressing:

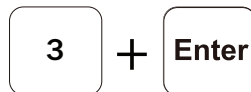

4. Refer to the *Keyboard Mapping Tables*, page 35, for a layout guide.

Key Mapping Stickers

Place mapping stickers on your keyboard for quick reference. The blue heading above each sticker indicates the key on which it belongs.

On each sticker:

Blue represents a keys function when pressed with the [Alt] key.

Gray represents a keys function under a specific keyboard layout: iPhone/iPad, Mac, or QWERTY.

Standard Keyboard Commands

For a list of common keyboard commands see *Standard Keyboard Commands*, page 33.

Clearing Bluetooth

Clearing Bluetooth allows you to remove a Bluetooth pairing and create a new one. To clear a Bluetooth pairing, do the following:

1. From the USB keyboard, select a Bluetooth port you want to clear, by pressing:

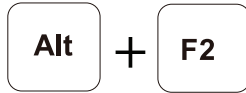

–or–

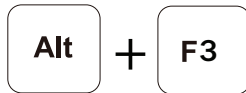

“+” means: hold-down [Alt], then press the second hotkey.

2. Disconnect the Bluetooth pairing, by pressing:

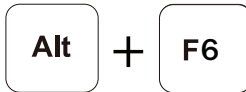

3. The LED light will flash, indicating the CS533 has cleared the pairing and is ready to connect a new device.

Disconnecting Bluetooth

Disconnecting Bluetooth without removing the pairing allows you to disconnect and automatically reconnect the same Bluetooth device, as you come and go.

To disconnect Bluetooth, do the following:

1. From the USB keyboard, select a Bluetooth port you want to disconnect, by pressing:

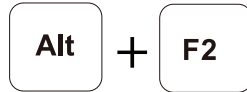

–or–

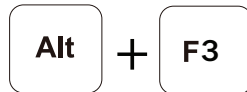

“+” means: hold-down [Alt], then press the second hotkey.

2. Disconnect the Bluetooth connection, by pressing:

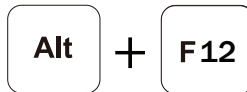

3. The LED light will flash, indicating Bluetooth has disconnected, and the CS533 is waiting to reconnect.

To reconnect Bluetooth:

1. Place the device on the CS533.
2. From the device turn Bluetooth On.
3. Press a key on the USB keyboard and Bluetooth automatically reconnects.

Reset Settings

Resetting sets the CS533 back to the default settings.

To reset the CS533 to the default settings, do the following:

1. From the USB keyboard press:

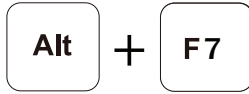

“+” means: hold-down [Alt], then press the second hotkey.

2. The CS533 is now reset to the default settings.

Seamless Switching Mode

Seamless Switching mode is enabled by default and allows a mobile device to stay connected via Bluetooth when you switch the CS533 to the USB port. If Seamless Switching mode is disabled, Bluetooth will disconnect every time you switch to the USB port, and there will be a delay when switching back to the Bluetooth port, while Bluetooth reconnects.

To enable/disable Seamless Switching mode, do the following:

1. From the USB keyboard press:

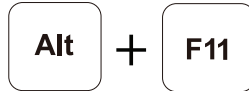

“+” means: hold-down [Alt], then press the second hotkey.

Firmware Upgrade

To upgrade the firmware, do the following:

1. From the computer connected to a CS533, go to: <http://eService.aten.com>
2. From the *Download Center* select CS533, then click *Firmware* for a list of downloads.
3. Download the appropriate *Firmware Upgrade* package to your computer.
4. Unplug the USB mouse from the CS533 and plug it into the computer.
5. Invoke the CS533's Firmware Upgrade Mode, by pressing:

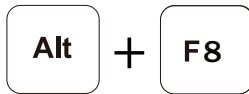

then

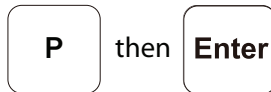

“+” means: hold-down [Alt], then press the second hotkey.

6. All LEDs flash to indicate the Firmware Upgrade Mode is in effect.
7. Double click the Firmware Upgrade package and follow the instructions.
8. The *Welcome to the InstallShield Wizard* screen appears. Click **Next**.

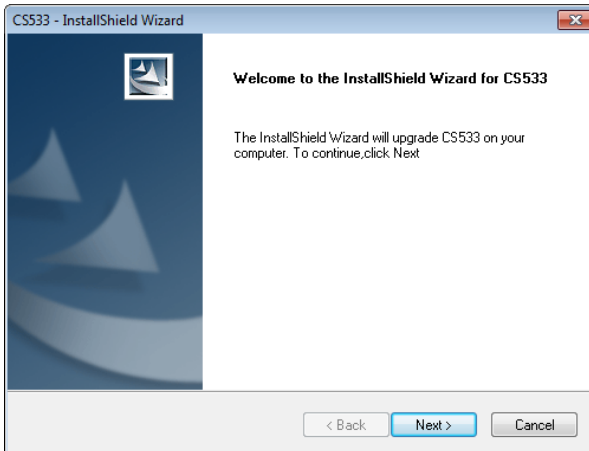

9. The *Select Keyboard Type* screen appears:

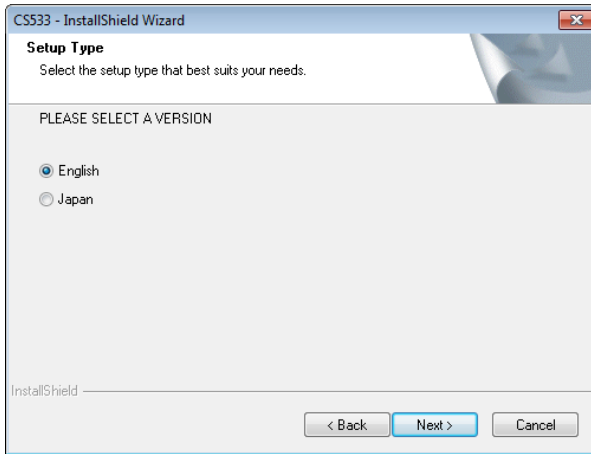

Select the type of keyboard you will use with the CS533: **English** (104-key), or **Japanese** (109-key). Click **Next**.

10. The *Select A Default Port* screen appears:

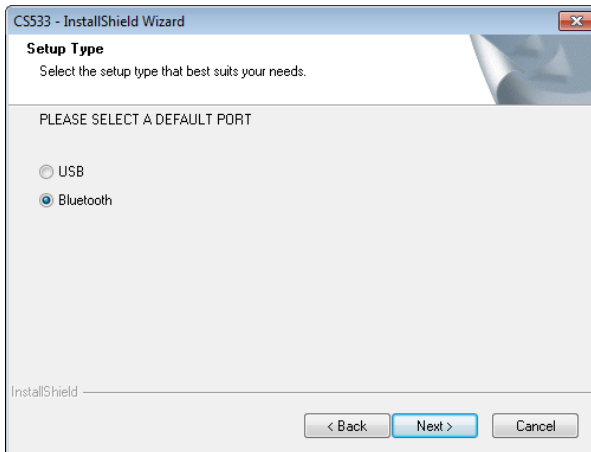

Choose the port that the CS533 selects for use when it is plugged into a computer: **USB** - computer port, or **Bluetooth** - mobile device Bluetooth port. Click **Next**.

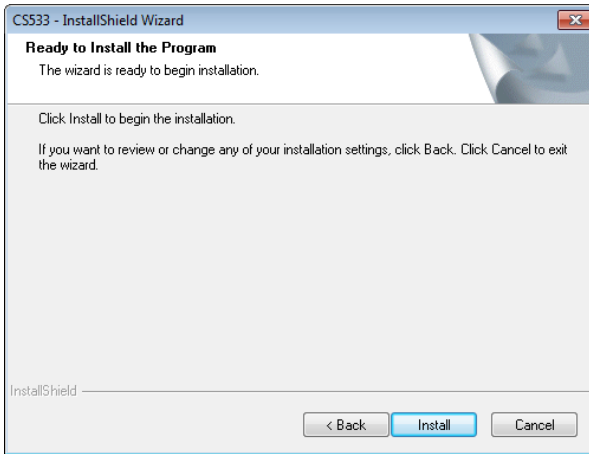
11. The *Ready to Install the Program* screen appears:

Click **Install**.

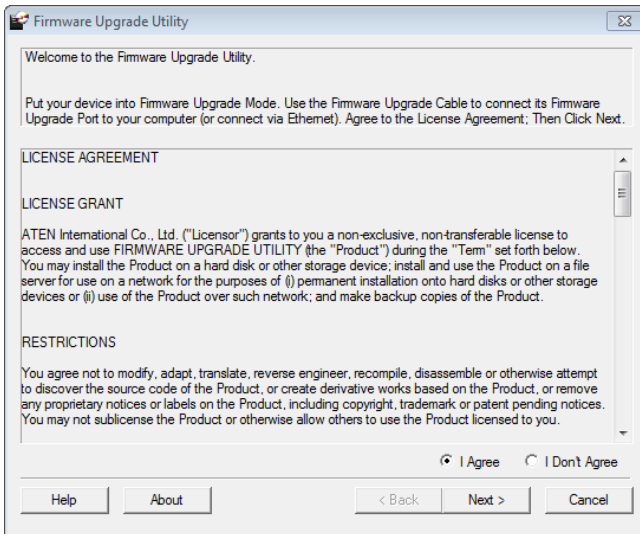
12. The *Firmware Upgrade Utility* welcome screen appears:

Read the *License Agreement*, if you agree to the terms, select **I Agree** and click **Next**.

13. The Firmware Utility Main screen appears:

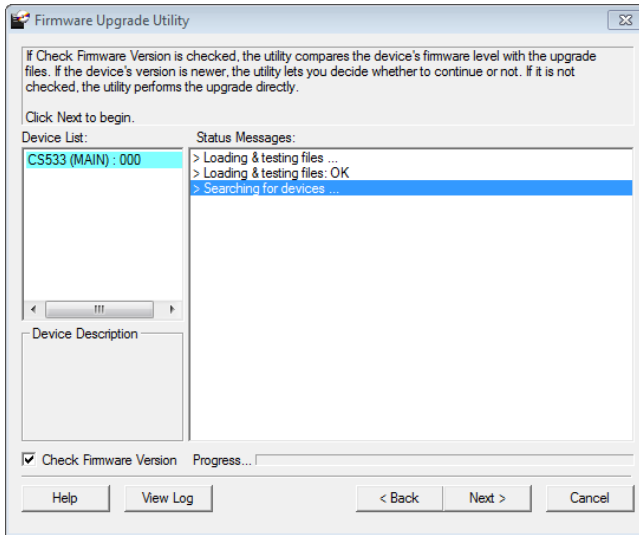

The Utility inspects your installation. All the devices capable of being upgraded by the package are listed in the Device List panel.

- ◆ If you enable *Check Firmware Version*, the Utility compares the device's firmware level with that of the upgrade files. If it finds that the device's version is higher than the upgrade version, it brings up a dialog box informing you of the situation and gives you the option to Continue or Cancel.
- ◆ If you don't enable *Check Firmware Version*, the Utility installs the upgrade files without checking whether they are a higher level, or not.

After you have made your selections, Click **Next** to perform the upgrade.

As the Upgrade proceeds, status messages appear in the Status Messages panel, and the progress toward completion is shown on the *Progress* bar.

14. After the upgrade has completed, a screen appears to inform you that the procedure was successful:

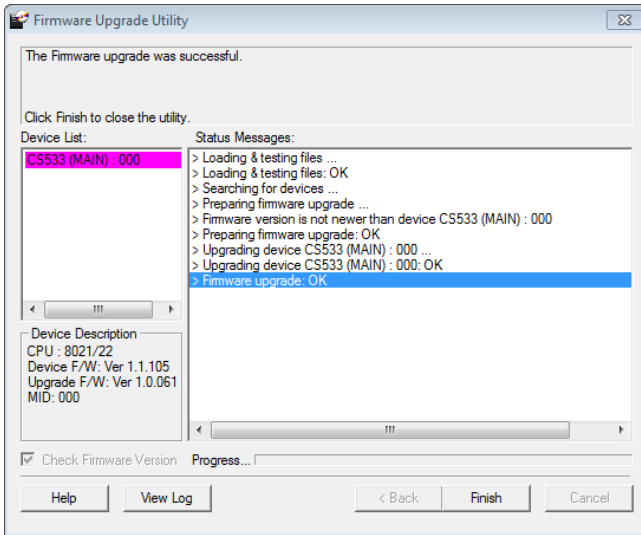

Click **Finish** to close the Firmware Upgrade Utility.

15. After the upgrade process is complete, unplug the CS533's USB cable from the computer and plug it back in.
16. Unplug the USB mouse from the computer and plug it into the CS533.
17. The firmware upgrade is complete.

Safety Instructions

General

- ◆ This product is for indoor use only.
- ◆ Read all of these instructions. Save them for future reference.
- ◆ Follow all warnings and instructions marked on the device.
- ◆ Do not place the device on any unstable surface (cart, stand, table, etc.). If the device falls, serious damage will result.
- ◆ Do not use the device near water.
- ◆ Do not place the device near, or over, radiators or heat registers.
- ◆ The device cabinet is provided with slots and openings to allow for adequate ventilation. To ensure reliable operation, and to protect against overheating, these openings must never be blocked or covered.
- ◆ The device should never be placed on a soft surface (bed, sofa, rug, etc.) as this will block its ventilation openings. Likewise, the device should not be placed in a built in enclosure unless adequate ventilation has been provided.
- ◆ Never spill liquid of any kind on the device.
- ◆ Unplug the device from the wall outlet before cleaning. Do not use liquid or aerosol cleaners. Use a damp cloth for cleaning.
- ◆ The device should be operated from the type of power source indicated on the marking label. If you are not sure of the type of power available, consult your dealer or local power company.
- ◆ To prevent damage to your installation it is important that all devices are properly grounded.
- ◆ Do not allow anything to rest on the power cord or cables. Route the power cord and cables so that they cannot be stepped on or tripped over.
- ◆ To help protect your system from sudden, transient increases and decreases in electrical power, use a surge suppressor, line conditioner, or un-interruptible power supply (UPS).
- ◆ Position system cables and power cables carefully; Be sure that nothing rests on any cables.

- ◆ Never push objects of any kind into or through cabinet slots. They may touch dangerous voltage points or short out parts resulting in a risk of fire or electrical shock.
- ◆ Do not attempt to service the device yourself. Refer all servicing to qualified service personnel.
- ◆ If the following conditions occur, unplug the device from the wall outlet and bring it to qualified service personnel for repair.
 - ◆ The power cord or plug has become damaged or frayed.
 - ◆ Liquid has been spilled into the device.
 - ◆ The device has been exposed to rain or water.
 - ◆ The device has been dropped, or the cabinet has been damaged.
 - ◆ The device exhibits a distinct change in performance, indicating a need for service.
 - ◆ The device does not operate normally when the operating instructions are followed.
- ◆ Only adjust those controls that are covered in the operating instructions. Improper adjustment of other controls may result in damage that will require extensive work by a qualified technician to repair.

Technical Support

International

- ◆ For online technical support – including troubleshooting, documentation, and software updates: **<http://support.aten.com>**
- ◆ For telephone support, See *Telephone Support*, page iii:

North America

Email Support		support@aten-usa.com
Online Technical Support	Troubleshooting Documentation Software Updates	http://www.aten-usa.com/support
Telephone Support		1-888-999-ATEN ext 4988

When you contact us, please have the following information ready beforehand:

- ◆ Product model number, serial number, and date of purchase.
- ◆ Your computer configuration, including operating system, revision level, expansion cards, and software.
- ◆ Any error messages displayed at the time the error occurred.
- ◆ The sequence of operations that led up to the error.
- ◆ Any other information you feel may be of help.

Specifications

Function		CS533
PC / Bluetooth Connections		1/2
Port Selection		Hotkey
Connectors	Keyboard	1 x USB Type A Female (White)
	Mouse	1 x USB Type A Female (White)
	Power Supply	1 x USB Type A Male (White)
Cable Length	Computer	1.8 m
LEDs	USB Selected/Power Supply	1 (Blue)
	Bluetooth Selected	2 (Blue)
Emulation	Keyboard	USB
		Bluetooth V2.1, Class 2
	Mouse	USB
		Bluetooth V2.1, Class 2
Power Consumption		5v, W
Environment	Operating Temp.	0–50°C
	Storage Temp.	-20–60°C
	Humidity	0–80% RH, Non-condensing
Physical Properties	Housing	Plastic
	Weight	112 g
	Dimensions (L x W x H)	92 x 78 x 24.55 mm

Bluetooth Compatibility

Below is a table of devices that support Bluetooth keyboard and mouse functionality. Devices that support HID* Profiles will work with the CS533.

Supported Devices		
Brand	Model	Version
Apple	iPad 1/2, iPad mini, iPad with Retina Display	iOS4.2.1 and higher
	iPhone 3GS/4/4S/5	
	iPod touch (2nd/3rd/4th Generation)	
	Apple TV (2nd/3rd Generation)	Apple TV software version 5.2 or later
	MacBook Air, MacBook Pro, Mac Pro, Mac Mini, iMac	OS 10.6 and higher
ACER	A500 / A501 / A100 / A200	Android 3.x / 4.x
ASUS	Eee Pad Transformer TF101, Eee Pad Transformer Prime TF201, Transformer Pad 300T, Padfone , ASUS Eee Pad, Memo M171, PadFone T004, PadFone Infinity	
Google	Nexus 7	
HTC	One V, One S, One X, One J Z321e, Butterfly, Butterfly S, New One, Desire L, Desire P	
HUAWEI	Media Pad, P6	
LG	Optimus Pad, Optimus 4x HD, Optimus L7, Optimus L7 II, Optimus L5II, Optimus Pro, Optimus GJ	
MOTOROLA	XOOM	
Samsung	Galaxy Tab 7.7, Galaxy Tab 8.9, Galaxy Tab 10.1 (WIFI/3G), Galaxy Tab II 7.0, Galaxy Tab II 10.1, Galaxy Tab III 8.0	
	Galaxy Nexus, Galaxy Nexus S, Galaxy S II, Galaxy Note, Galaxy S III, Galaxy S Advance, Galaxy Note2, Galaxy Core, Galaxy S IV, Galaxy Note3, Galaxy MEGA "5.8", Galaxy MEGA "6.3", Galaxy Win Duos	
SONY	Tablet S	
	Xperia Arc S, Xperia NEO V, Xperia Ray, Xperia acro S, Xperia XL, Xperia P, Xperia Z, Xperia Z Ultra, Xperia XS, Xperia TX, LT29i, Xperia Z1, Xperia V, Xperia M, Xperia SP	
Wiz	Aero T-518	
Xiaomi	mi2S	

Supported Devices		
Brand	Model	Version
HTC	Evo 3D, Sensation, Sensation XE/XL, Explorer, Flyer	Android 2.x
MOTOROLA	RAZR MAXX	
Samsung	Galaxy SII i9100 / R i9103	
	Galaxy Nexus / Galaxy Note	
	Galaxy Tab (3G)P1000	
	GALAXY S II LTE	
ACER	W500	
FIC	Tycoon TVBO0	XP / 2000 / Vista / 7
Gigabyte	S1080	
Microsoft	Windows compatible PC (with Bluetooth support)	
MIS	WindPad 100W	

***Bluetooth Note:** The term “HID” refers to a compatible Bluetooth device.









Although Google provides native support for Bluetooth HID (Human Interface Devices), for input devices (such as keyboards) - with all Android 4.0 and later O.S. versions - specific Bluetooth compatibility still depends on each smartphone manufacture's decision to include HID support with each device.

For specific information about Bluetooth HID (keyboard/mouse) support with your Android device; (especially Android O.S 3.x, Android O.S. 2.x and older versions), please contact your smartphone manufacture for detailed support information. Your phone/tablet/pc must support Bluetooth HID Profiles (which allows for the support of input devices such as keyboards and mice) with the CS533. Bluetooth HID (keyboard/mouse) compatibility with your device is beyond our control, but the new Andriod O.S.'s have the ability to support these functions and it is up to the manufacture to activate them on your device, therefore we will be not be able to guarantee, even if the smartphone device is upgraded with latest Android O.S, that a keyboard or mouse will work on it.

Standard Keyboard Commands







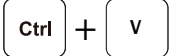

Below are standard key combinations to: *Copy, Paste, Cut, Restore, Select, Select All*, and invoke *IME Change* on **PC** and **Apple** keyboards.

PC Keyboard:

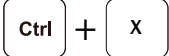
Function	Mac OS	Windows OS
Copy	 + C	Ctrl + C
Paste	 + V	Ctrl + V
Cut	 + X	Ctrl + X
Restore	 + Z	Ctrl + Z
Select All	 + A	Ctrl + A
Select	Shift + 	Shift + 
IME Change*	 + Spacebar	Ctrl + Spacebar

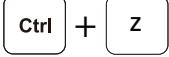
Apple Keyboard:

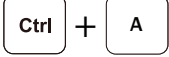
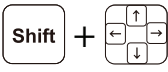
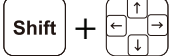
Function	Mac OS	Windows OS
Copy	command  + C	Ctrl + C

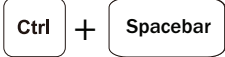





Function	Mac OS	Windows OS
Paste		
Cut		
Restore		
Select All		
Select		
IME Change*		







*An input method editor (IME) is an operating system component that receives keyboard input as data, allowing users to enter characters and symbols not found on the keyboard. For example; on a computer this allows users of English keyboards to input Chinese, Korean, or Japanese characters. For more information on using IME see *Input Method Editor (IME)*, page 10, for details.







Keyboard Mapping Tables







Keyboard mappings are listed on two tables. Refer to the table according to the USB keyboard you use: *PC or Mac*. Then use the **Layout** column to understand how each **Key** registers when pressed under the keyboard layouts: *QWERTY, Mac, iPad/iPhone*.



PC Keyboard Mapping

PC Keyboard		Layout		
Key		QWERTY	Mac	iPad / iPhone
	Right/Left Control	Right/Left Control	Right/Left Control	Right/Left Control
	Right/Left Alt	Right/Left Alt	Right/Left Option	Right/Left Option
	Right/Left Windows Key	Right/Left Windows Key	Right/Left Command	Right/Left Command
	Escape	Escape	Escape	Home / Siri (iPhone 4s, New iPad)
	F1	F1	F1 / Brightness Down	F1 / Brightness Down
	F2	F2	F2 / Brightness Up	F2 / Brightness Up

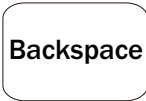







PC Keyboard		Layout		
Key		QWERTY	Mac	iPad / iPhone
	F3	F3	F3 / Expose	Spotlight Search
	F4	F4	F4 / DashBoard	Photo Frame (iPad) Screen Lock (iPhone)
	F5	F5	F5	On-Screen Keyboard
	F6	F6	F6	-
	F7	F7	F7 / Rewind	Rewind
	F8	F8	F8 / Play - Pause	Play - Pause
	F9	F9	F9 / Fast Forward	Fast Forward









PC Keyboard		Layout		
Key	QWERTY	Mac	iPad / iPhone	
	F10	F10	F10 / Mute	Mute
	F11	F11	F11 / Volume Down	Volume Down
	F12	F12	F12 / Volume Up	Volume Up
 + 	Windows Key + E	Windows Key + E	CD Eject	-
	Delete	Delete	Delete Forward	Delete Backward
	Print Screen	Print Screen	F13	-





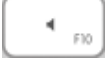
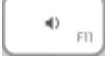



PC Keyboard		Layout		
Key		QWERTY	Mac	iPad / iPhone
	Scroll Lock	Scroll Lock	F14	-
	Home	Home	Home	-
	End	End	End	-
	Page Up	Page Up	Page Up	-
	Page Down	Page Down	Page Down	-
	Backspace	Backspace	Delete Backward	Delete Backward
	Enter	Enter	Return	Return





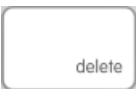

PC Keyboard		Layout		
Key		QWERTY	Mac	iPad / iPhone
	Insert	Insert	Fn	-
	Pause	Pause	F15	-
	Num Lock	Num Lock	Clear	-

Mac Keyboard Mapping

Mac Keyboard		Layout		
Key		QWERTY (PC)	Mac	iPad / iPhone
	Right/Left Control	Right/Left Control	Right/Left Control	Right/Left Control
	Right/Left Shift	Right/Left Shift	Right/Left Shift	Right/Left Shift
	Right/Left Option	Right/Left Alt	Right/Left Option	Right/Left Option
	Right/Left Command	Right/Left GUI	Right/Left Command	Right/Left Command
	Escape	Escape	Escape	Home / Siri (iPhone 4S, New iPad)
	F1 / Brightness Down	F1	F1 / Brightness Down	Brightness Down
	F2 / Brightness Up	F2	F2 / Brightness Up	Brightness Up
	F3 / Expose	F3	F3 / Expose	Spotlight Search
	F4 / Dash Board	F4	F4 / Dash Board	Photo Frame (iPad) Screen Lock (iPhone)

Mac Keyboard		Layout		
Key		QWERTY (PC)	Mac	iPad / iPhone
	F5	F5	F5	On-Screen Keyboard
	F6	F6	F6	-
	F7 / Rewind	F7	F7 / Rewind	F7 / Rewind
	F8 / Play-Pause	F8	F8 / Play-Pause	Play-Pause
	F9 / Fast Forward	F9	F9 / Fast Forward	Fast Forward
	F10 / Mute	F10	F10 / Mute	Mute
	F11 / Volume Down	F11	F11 / Volume Down	Volume Down
	F12 / Volume Up	F12	F12 / Volume Up	Volume Up
	Eject	-	-	-
	F13	Print Screen	F13	-

Mac Keyboard		Layout		
Key		QWERTY (PC)	Mac	iPad / iPhone
	F14	Scroll Lock	F14	-
	F15	Pause	F15	-
	F16	-	F16	-
	F17	-	F17	-
	F18	-	F18	-
	F19	-	F19	-
	Delete Forward	Delete	Delete Forward	Delete Backward
	Delete Backward	Backspace	Delete Backward	Delete Backward
	Return	Enter	Return	Return

Mac Keyboard		Layout		
Key		QWERTY (PC)	Mac	iPad / iPhone
	fn / Help	Insert	fn / Help	-
	Home	Home	End	-
	End	End	End	-
	Page Up	Page Up	Page Up	-
	Page Down	Page Down	Page Up	-
	Clear	Num Lock	Clear	-

Troubleshooting

Overview

Operation problems can be due to a variety of causes. The first step in solving them is to make sure that all cables are securely attached and seated completely in their sockets.

In addition, updating the product's firmware may solve problems that have been discovered and resolved since the prior version was released. If your product is not running the latest firmware version, we strongly recommend that you upgrade. See *Firmware Upgrade*, page 22, for upgrade details.

Symptom	Possible Cause	Action
Mouse and/or Keyboard not responding.	Improper mouse, keyboard, or CS533 connection.	Check that the keyboard and mouse are plugged into the correct USB (keyboard and mouse) ports on the rear of the CS533, and that the CS533 is properly plugged into the computer. Unplug the cables, and plug them back in. See <i>Connecting Hardware</i> , page 5.
	Wireless receiver plugged into the wrong port.	If you are using a wireless keyboard and mouse, be sure that the wireless receiver is plugged into the CS533's keyboard port.
	You are connected to a Bluetooth port that is not paired with a mobile device.	From the USB keyboard switch to the computers port, using the hotkey: [Alt] + [F1] See <i>Switching</i> , page 14. <i>-or-</i> Use Bluetooth to pair your mobile device with the CS533 port you are connected to. See <i>Connecting Bluetooth</i> , page 6.
	USB mouse is not supported for use on some mobile devices.	Some manufacturer's operating system platforms do not support use of a USB mouse on their mobile devices; particularly iOS products. Please check the device's user manual for information on supporting a USB mouse.
Pressing [Enter] doesn't send text or sms messages from my mobile device.	The mobile application must have an option allowing you to send messages using the [Enter] key.	Check the mobile applications options to enable the [Enter] key to send messages. Some mobile applications do not allow you to use the [Enter] key to send messages, and you will need to press Send from the devices screen. If you are using a mobile device that supports use with a USB mouse, you can use the mouse to click Send.

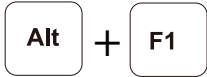
Symptom	Possible Cause	Action
Bluetooth won't connect or pair with my mobile device.	Bluetooth is not in sync with your mobile device.	The best way to resolve any Bluetooth connectivity issue is to clear the Bluetooth connection (see <i>Clear Bluetooth Pairing</i> , page 12), and re-connect Bluetooth (see <i>Connecting Bluetooth</i> , page 6). Another possibility is that the mobile device is placed too far from the CS533 to establish a connection, or Bluetooth is not turned on from your device.
The CS533 won't switch ports when using hotkeys.	You may not be pressing the hotkeys correctly.	The hotkeys must be pressed in the correct order. When a hotkey combo shows a "+", you should do the following:  Press and hold-down the [Alt] key, then press the second hotkey [F1] .
Can't switch ports after the firmware upgrade is complete.	Firmware upgrade process incomplete.	When you finish upgrading the firmware, be sure to unplug the CS533's USB cable from the computer, and plug it back in.
When the CS533 is plugged into a computer it switches to the Bluetooth port.	Firmware needs to be upgraded.	The latest firmware allows you to choose the default port (USB or Bluetooth) that the CS533 uses when plugged into a computer. To download and install the latest firmware see <i>Firmware Upgrade</i> , page 22, for details.

Limited Warranty

IN NO EVENT SHALL THE DIRECT VENDOR'S LIABILITY EXCEED THE PRICE PAID FOR THE PRODUCT FROM DIRECT, INDIRECT, SPECIAL, INCIDENTAL, OR CONSEQUENTIAL DAMAGES RESULTING FROM THE USE OF THE PRODUCT, DISK, OR ITS DOCUMENTATION.

The direct vendor makes no warranty or representation, expressed, implied, or statutory with respect to the contents or use of this documentation, and especially disclaims its quality, performance, merchantability, or fitness for any particular purpose.

The direct vendor also reserves the right to revise or update the device or documentation without obligation to notify any individual or entity of such revisions, or update. For further inquiries, please contact your direct vendor.

Free Manuals Download Website

<http://myh66.com>

<http://usermanuals.us>

<http://www.somanuals.com>

<http://www.4manuals.cc>

<http://www.manual-lib.com>

<http://www.404manual.com>

<http://www.luxmanual.com>

<http://aubethermostatmanual.com>

Golf course search by state

<http://golfingnear.com>

Email search by domain

<http://emailbydomain.com>

Auto manuals search

<http://auto.somanuals.com>

TV manuals search

<http://tv.somanuals.com>