



**16x16 Cat 5 A/V Matrix Switch  
VM1616T  
User Manual**



[www.aten.com](http://www.aten.com)

## FCC, CE Information

**FEDERAL COMMUNICATIONS COMMISSION INTERFERENCE STATEMENT:**  
 This equipment has been tested and found to comply with the limits for a Class A digital device, pursuant to Part 15 of the FCC Rules. These limits are designed to provide reasonable protection against harmful interference when the equipment is operated in a commercial environment. This equipment generates, uses, and can radiate radio frequency energy and, if not installed and used in accordance with the instruction manual, may cause harmful interference to radio communications. Operation of this equipment in a residential area is likely to cause harmful interference in which case the user will be required to correct the interference at his own expense.

**FCC Caution:** Any changes or modifications not expressly approved by the party responsible for compliance could void the user's authority to operate this equipment.

**CE Warning:** This is a class A product. In a domestic environment this product may cause radio interference in which case the user may be required to take adequate measures.

## RoHS

This product is RoHS compliant.

## Safety

This product has been classified as Information Technology Equipment.

## SJ/T 11364-2006

The following contains information that relates to China.

部件名称	有毒有害物质或元素					
	铅	汞	镉	六价铬	多溴联苯	多溴二苯醚
电器部件	●	○	○	○	○	○
机构部件	○	○	○	○	○	○

- : 表示该有毒有害物质在该部件所有均质材料中的含量均在SJ/T 11363-2006规定的限量要求之下。
- : 表示符合欧盟的豁免条款, 但该有毒有害物质至少在该部件的某一均质材料中的含量超出SJ/T 11363-2006的限量要求。
- ×: 表示该有毒有害物质至少在该部件的某一均质材料中的含量超出SJ/T 11363-2006的限量要求。



---

## User Information

---

### Online Registration

Be sure to register your product at our online support center:

International	<a href="http://eservice.aten.com">http://eservice.aten.com</a>
---------------	---

### Telephone Support

For telephone support, call this number:

International	886-2-8692-6959
China	86-10-5255-0110
Japan	81-3-5615-5811
Korea	82-2-467-6789
North America	1-888-999-ATEN ext 4988
United Kingdom	44-8-4481-58923

### User Notice

All information, documentation, and specifications contained in this manual are subject to change without prior notification by the manufacturer. The manufacturer makes no representations or warranties, either expressed or implied, with respect to the contents hereof and specifically disclaims any warranties as to merchantability or fitness for any particular purpose. Any of the manufacturer's software described in this manual is sold or licensed *as is*. Should the programs prove defective following their purchase, the buyer (and not the manufacturer, its distributor, or its dealer), assumes the entire cost of all necessary servicing, repair and any incidental or consequential damages resulting from any defect in the software.

The manufacturer of this system is not responsible for any radio and/or TV interference caused by unauthorized modifications to this device. It is the responsibility of the user to correct such interference.

The manufacturer is not responsible for any damage incurred in the operation of this system if the correct operational voltage setting was not selected prior to operation. PLEASE VERIFY THAT THE VOLTAGE SETTING IS CORRECT BEFORE USE.

## Package Contents

---

The VM1616T package consists of:

- ◆ 1 VM1616T 16x16 Cat 5 A/V Matrix Switch
- ◆ 1 Power Cord
- ◆ 1 Rack Mount Kit
- ◆ 3 Terminal Blocks
- ◆ 1 User Instructions\*

Check to make sure that all the components are present and that nothing got damaged in shipping. If you encounter a problem, contact your dealer.

Read this manual thoroughly and follow the installation and operation procedures carefully to prevent any damage to the unit, and/or any of the devices connected to it.

---

\* Features may have been added to the VM1616T since this manual was published. Please visit our website to download the most up-to-date version.

---

© Copyright 2010–2014 ATEN® International Co., Ltd.  
Manual Date: 2014-07-07

ATEN and the ATEN logo are registered trademarks of ATEN International Co., Ltd. All rights reserved.  
All other brand names and trademarks are the registered property of their respective owners.

# Contents

---

FCC, CE Information . . . . .	ii
RoHS . . . . .	ii
Safety . . . . .	ii
SJ/T 11364-2006 . . . . .	ii
User Information . . . . .	iii
Online Registration . . . . .	iii
Telephone Support . . . . .	iii
User Notice . . . . .	iii
Package Contents . . . . .	iv
Contents . . . . .	v
About this Manual . . . . .	viii
Conventions . . . . .	ix
Product Information . . . . .	ix
<b>1. Introduction</b>	
Overview . . . . .	1
Features . . . . .	2
Requirements . . . . .	3
Transmitters . . . . .	3
Receivers . . . . .	3
Local Output . . . . .	3
Cables . . . . .	3
Source Device Operating Systems . . . . .	4
Components . . . . .	5
Front View . . . . .	5
Rear View . . . . .	6
<b>2. Hardware Setup</b>	
Rack Mounting . . . . .	7
Grounding . . . . .	9
Cable Connection . . . . .	11
Installation Diagram A . . . . .	12
Installation Diagram B . . . . .	13
<b>3. Local Operation</b>	
Overview . . . . .	15
Front Panel Operation . . . . .	15
Basic Navigation . . . . .	15
Menu Organization . . . . .	16
Enter Password . . . . .	17
Main Screen . . . . .	18
Profiles . . . . .	18
Set IP Port . . . . .	20

IP Address . . . . .	20
Gateway . . . . .	21
Save and Reset / Exit . . . . .	22
Set Serial Port . . . . .	23
Serial Port Address . . . . .	23
Serial Port Mode . . . . .	24
Adjust Video Level . . . . .	25
Adjust Audio Level . . . . .	26
Save / Load Profile . . . . .	27
Security Mode . . . . .	28
Password Settings . . . . .	28
Switch Audio Only . . . . .	29

## 4. Remote Operation

Overview . . . . .	31
Logging In . . . . .	31
Connections Page . . . . .	32
Toolbar . . . . .	33
Configuring Connections . . . . .	34
Status Colors . . . . .	34
Save / Load Connection Profiles . . . . .	35
Operation Type . . . . .	35
Viewing Port Information . . . . .	35
Optimizing Video . . . . .	36
Adjust Audio . . . . .	36
Setup . . . . .	37
IP Setup . . . . .	37
Telnet Configuration . . . . .	37
Serial Setup . . . . .	38
Port Name . . . . .	38
Firmware . . . . .	39
Profile . . . . .	40
Selection . . . . .	40
Name . . . . .	41
User Management . . . . .	42
Privileges . . . . .	43
Telnet Operation . . . . .	44
Configuration Menu . . . . .	44
1. H – Call up the command list for help . . . . .	44
2. GT – Set gateway address . . . . .	45
3. IM – Set IP subnet mask . . . . .	45
4. IP – Set IP address . . . . .	45
5. LO – Load connections from profile . . . . .	45
6. PW – Change password . . . . .	45
7. RI – Read what input is connected to nn output . . . . .	45
8. RO – Read what output is connected to nn input . . . . .	45

---

9. SB – Set serial port baud rate . . . . .	46
10. SS – Switch input to specified output . . . . .	46
12. SV – Save the current connection to a profile . . . . .	46
13. TI – Set timeout . . . . .	46
14. VR – Software version information . . . . .	46

## 5. RS-232 Commands

RS-232 Serial Interface. . . . .	47
Configuring the Serial Port . . . . .	47
Switch Port Commands. . . . .	47
Possible Values . . . . .	48
Mute Commands . . . . .	49
Save/Load Profile Commands. . . . .	51
Adjust Video Quality Commands. . . . .	52
Adjust Audio Commands. . . . .	53
Verification. . . . .	54

## Appendix

Safety Instructions. . . . .	55
General . . . . .	55
Rack Mounting . . . . .	57
Technical Support. . . . .	58
International. . . . .	58
North America . . . . .	58
Specifications . . . . .	59
Troubleshooting . . . . .	60
Limited Warranty. . . . .	60

## About this Manual

---

This User Manual is provided to help you get the most from your VM1616T system. It covers all aspects of installation, configuration and operation. An overview of the information found in the manual is provided below.

**Chapter 1, Introduction**, introduces you to the VM1616T system. Its purpose, features and benefits are presented, and its front and back panel components are described.

**Chapter 2, Hardware Setup**, describes how to set up your VM1616T installation. The necessary steps – including how to connect up to the VE300/VE500 A/V Over Cat 5 Extender system – are provided.

**Chapter 3, Local Operation**, explains the fundamental concepts involved in operating the VM1616T at the local site via the front panel LCD display and pushbuttons.

**Chapter 4, Remote Operation**, provides a complete description of the VM1616T's Browser Graphical User Interface (GUI), and how to use it to remotely configure and operate the VM1616T.

**Chapter 5, RS-232 Protocol Commands**, provides a complete list of the serial control protocol commands used when utilizing the RS-232 Serial Port so that an extra source device can function further as transmitter and receiver.

**An Appendix**, provides specifications and other technical information regarding the VM1616T.



## Conventions

---

This manual uses the following conventions:

- Monospaced** Indicates text that you should key in.
- [ ] Indicates keys you should press. For example, [Enter] means to press the **Enter** key. If keys need to be chorded, they appear together in the same bracket with a plus sign between them: [Ctrl+Alt].
1. Numbered lists represent procedures with sequential steps.
- ◆ Bullet lists provide information, but do not involve sequential steps.
- Indicates selecting the option (on a menu or dialog box, for example), that comes next. For example, Start → Run means to open the *Start* menu, and then select *Run*.
-  Indicates critical information.

## Product Information

---

For information about all ATEN products and how they can help you connect without limits, visit ATEN on the Web or contact an ATEN Authorized Reseller. Visit ATEN on the Web for a list of locations and telephone numbers:

International	<a href="http://www.aten.com">http://www.aten.com</a>
North America	<a href="http://www.aten-usa.com">http://www.aten-usa.com</a>

This Page Intentionally Left Blank

# Chapter 1

## Introduction

### Overview

---

The ATEN VanCryst VM1616T 16x16 Cat5 A/V Matrix Switch is a versatile audio/video over Cat 5+ serial solution that offers an easy and affordable way to route any of 16 audio/video sources to any of 16 displays plus one local video output, in combination with an ATEN Video Extender system.

With sixteen Cat 5 A/V input ports, the VM1616T allows you to connect sixteen source devices (via sixteen Video Extender transmitters) to sixteen monitors, displays, or projectors (via sixteen Video Extender receivers) at the same time. In addition to the sixteen Cat 5 connections, the unit is also enabled with local audio/video outputs so that an extra monitor located in the same rack as the VM1616T can function as a further receiver.

As a Matrix Switch, each input can be independently connected to any or all outputs, and the audio and video inputs from each source device can also be switched independently, giving you the ultimate in flexibility and control in any multi-display audio/video installation.

While the A/V signal travels over Cat 5 cable, the VM1616T unit can be controlled over a standard TCP/IP connection, and so it will seamlessly integrate with your existing network infrastructure. It allows convenient configuration and operation via an intuitive Graphical User Interface (GUI), accessed via web browser, as well as locally via front panel pushbuttons and LCD display. The VM1616T can also be accessed via a remote terminal session using Telnet.

Furthermore, for complete system and install integration, serial control is standard through the VM1616T's built-in RS-232 and RS-485/422 ports that allow the switch to be controlled through a high-end controller or PC. The unit's bi-directional RS-232 serial port also allows serial devices, such as touchscreens and barcode scanners, to be included in the installation.

In combination with a compatible ATEN over Cat 5 Video Extender system, the VM1616T can support distances of up to 300 meters at 1280 x 1024 video resolution between the transmitter and receiver units. It supports higher resolutions of up to 1920 x 1200 at shorter distances. The VM1616T is an ideal solution for applications that require A/V + serial information from multiple sources to be conveniently delivered to any of multiple destinations.

## Features

---

- ◆ Connects any of 16 Cat 5 A/V inputs to any of 16 Cat 5 A/V outputs in combination with ATEN Video Extenders, such as the VE300/VE500 A/V Over Cat 5 Extender
- ◆ Long signal range – supports up to 300 meters between Video Extender transmitters and receivers
- ◆ Easily switch between multiple sources and multiple displays
- ◆ Identify and name input and output ports using a web-based GUI
- ◆ Local Operation:
  - ◆ Front panel LCD display and pushbuttons
  - ◆ Serial controller
- ◆ Remote Operation:
  - ◆ Browser Graphical User Interface (GUI)
  - ◆ Telnet
- ◆ Supports additional local display – provides an extra output source
- ◆ Superior video quality – up to 1920 x 1200@60Hz; DDC2B
- ◆ Supports stereo and balanced audio
- ◆ Automatic and adjustable video and audio quality
- ◆ Independent switching of audio and video sources – any audio source can be connected to any video source for output flexibility
- ◆ Built-in RS-232 and RS-485/422 ports allow the switch to be controlled through a high-end controller or PC; RS-232 for connecting serial devices, such as touchscreens and barcode scanners
- ◆ Supports transmitters and receivers on the same unit for high video and audio quality
- ◆ Upgradeable firmware
- ◆ Rack Mountable

---

**Note:** The VM1616T AP and GUI operation instructions can be downloaded from the ATEN website ([www.aten.com](http://www.aten.com)).

---

## **Requirements**

---

The following equipment is required for a complete VM1616T installation:

### **Transmitters**

- ◆ 16 x ATEN Video Extender Transmitters (i.e., VE300T, VE500T)

### **Receivers**

- ◆ 16 x ATEN Video Extender Receivers (i.e., VE300R / VE300RQ, VE500R / VE500RQ)

---

**Note:** For further information about the ATEN A/V Over Cat 5 Extender systems, please visit the ATEN website or contact your ATEN dealer.

---

### **Local Output**

- ◆ A VGA, SVGA, XGA, SXGA, UXGA, WUXGA, or multisync display device with an HDB-15 connector
- ◆ Computer or A/V source device with VGA and stereo/balanced audio output
- ◆ Stereo and/or balanced audio speakers

### **Cables**

- ◆ Use VGA/Audio/RS-232 cables to connect the local computer (or other audio/video source device) to the VM1616T
- ◆ Use cat 5e cables to connect the Video Extender Transmitters and Video Extender Receivers to the VM1616T

---

**Note:** Cables are not provided in the VM1616T package.

---

## **Source Device Operating Systems**

Supported operating systems are shown in the table, below:

<b>OS</b>		<b>Version</b>
Windows		2000 and higher
Linux	RedHat	6.0 and higher
	SuSE	8.2 and higher
	Mandriva (Mandrake)	9.0 and higher
UNIX	AIX	4.3 and higher
	FreeBSD	3.51 and higher
	Sun	Solaris 8 and higher
Novell	Netware	5.0 and higher
Mac		OS 9 and higher
DOS		6.2 and higher

---

**Note:** For Windows 7 64-bit systems, the following must be installed first:

- 1) Microsoft Office 64-bit Access Database software; and
  - 2) Microsoft 64-bit ODBC and OLEDB driver.
-

# Components

## Front View

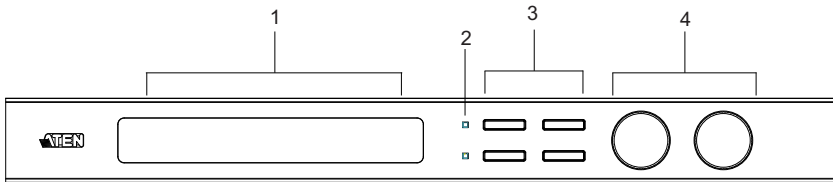

No.	Component	Description
1	LCD Display	The LCD display shows the various options for configuring and operating the VM1616T. For full details, see <i>Front Panel Operation</i> , page 15.
2	LED	The LEDs indicate the active selection for the MENU and PROFILE options.
3	Front Panel Pushbuttons	Use the pushbuttons to navigate the LCD display to configure and operate the VM1616T. <ul style="list-style-type: none"> <li>◆ MENU – Press to invoke the Main Screen/Menu</li> <li>◆ PROFILE – Press to cycle through the profiles</li> <li>◆ ESC – Press to cancel the current selection</li> <li>◆ ENTER – Press to confirm the current selection</li> </ul> For full details, see <i>Front Panel Operation</i> , page 15. <b>Note:</b> The MENU and PROFILE front panel pushbuttons have built-in LEDs that light to indicate they have been selected.
4	IN / OUT Dials/ Pushbuttons	The IN / OUT dials/pushbuttons are used to select options and navigate within the LCD display.

## Rear View

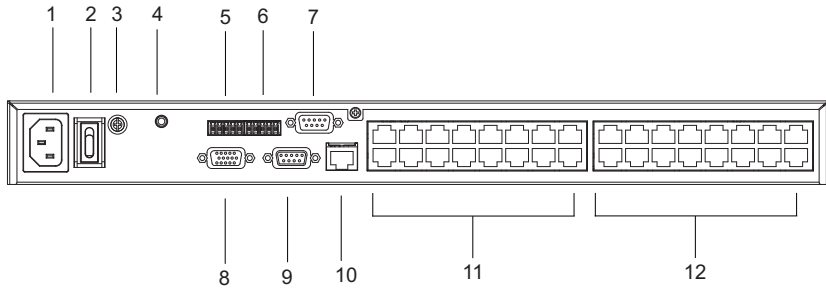

No.	Component	Description
1	Power Socket	This is a standard 3-pin AC power socket. The power cord from an AC source plugs in here.
2	Power Switch	This is a standard rocker switch that powers the unit on and off.
3	Grounding Terminal	The grounding wire attaches here. See <i>Grounding</i> , page 9, for further details.
4	Local Stereo Audio Out Port	This port is for the local stereo audio speakers.
5	Local Balanced Audio Out Ports	These ports are for the local balanced audio speakers.
6	RS-485 / RS-422 Serial Port	These serial ports, comprising of one 5-pole captive screw connector (RS-485 / RS-422) and one DB 9 (RS-232), are for serial control of the VM1616T.
7	RS-232 Serial Port (Female)	
8	Local Video Out Port	This VGA port is for connecting your local display.
9	RS-232 Serial Port (Male)	RS-232 serial devices – such as touchscreens and barcode scanners – plug into this port.
10	Ethernet Port	In order to access the VM1616T's Browser Graphical User Interface (GUI), the VM1616T must be connected to your network. The cable that connects the VM1616T to your LAN/WAN plugs in here. See <i>Cable Connection</i> , page 11, for further details
11	Cat 5 In Ports	Use Cat 5e/6 cable to connect these ports to up to 16 Video Extender transmitters (i.e., VE300T/VE500T). See <i>Cable Connection</i> , page 11, for further details.
12	Cat 5 Out Ports	Use Cat 5e/6 cable to connect these ports to up to 16 Video Extender receivers (ie., VE300R/VE300RQ / VE500R/VE500RQ). See <i>Cable Connection</i> , page 11, for further details.



# Chapter 2

## Hardware Setup



1. Important safety information regarding the placement of this device is provided on page 55. Please review it before proceeding.
2. Make sure that the power to all devices connected to the installation are turned off. You must unplug the power cords of any computers that have the Keyboard Power On function.

### Rack Mounting

---

The VM1616T can be mounted in a 19" (1U) system rack. For the most convenient front panel pushbutton configuration and operation at the local site, mount the unit at the front of the rack, as follows:

1. Use the M3 x 8 Phillips head hex screws supplied with the Rack Mount Kit to screw the rack mounting brackets onto the front of the unit.

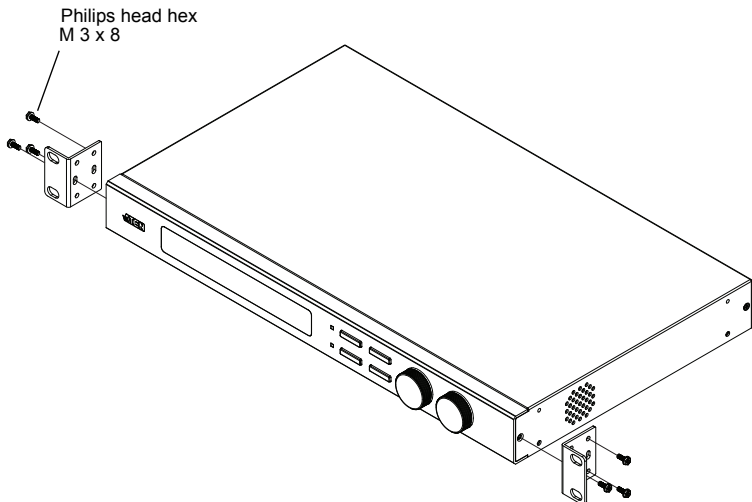

*(Continues on next page.)*

2. Position the unit in the front of the rack and align the holes in the mounting brackets with the holes in the rack.
3. Screw the mounting brackets to the rack.

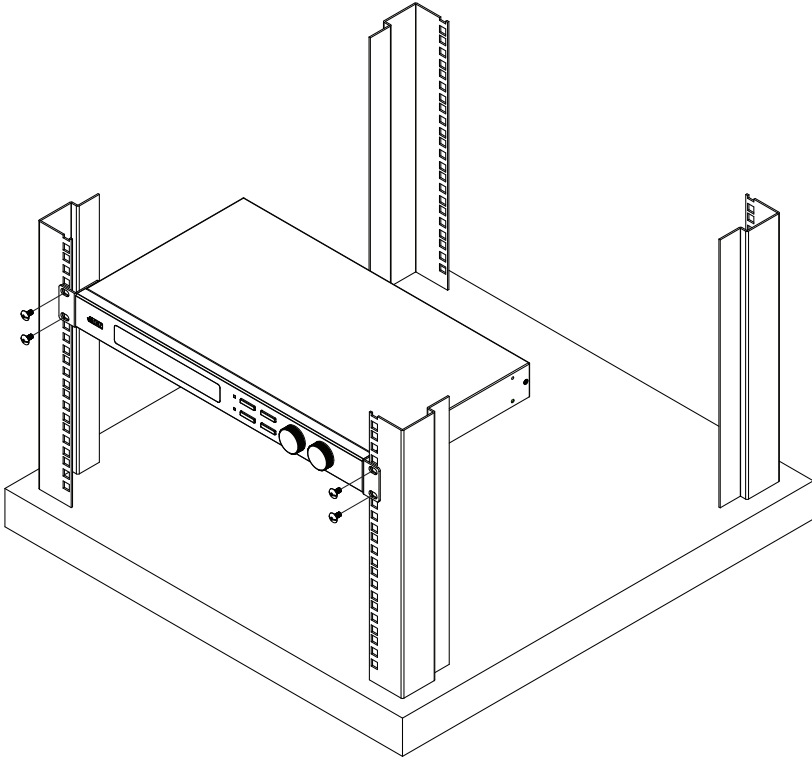

## Grounding

To prevent damage to your installation, it is important that all devices are properly grounded.

1. Use a grounding wire to ground the VM1616T by connecting one end of the wire to the grounding terminal, and the other end of the wire to a suitable grounded object.

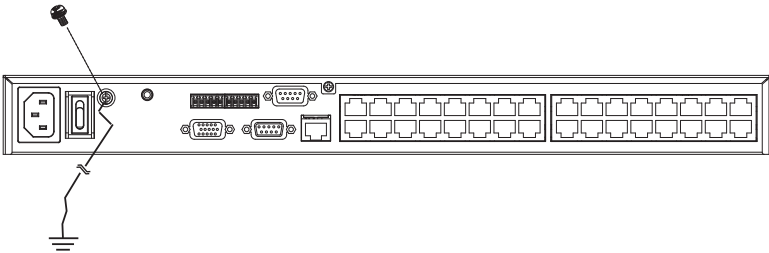

2. Make sure that all devices in your VM1616T installation, including transmitters and receivers, are properly grounded.

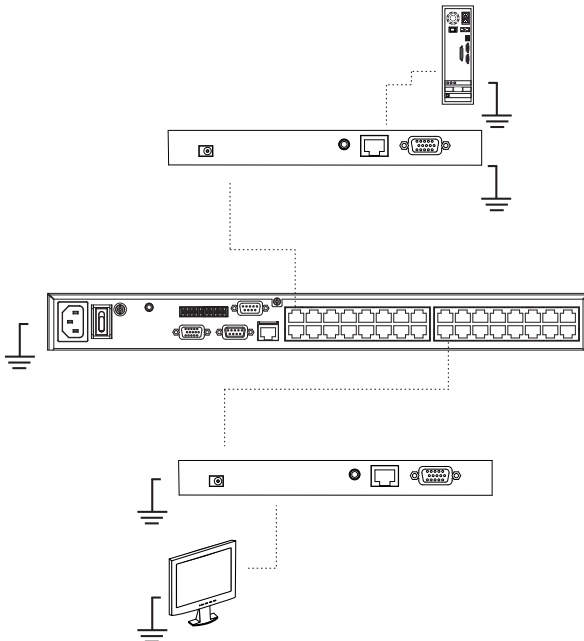

*(Continues on next page.)*

3. For increased grounding protection, use STP (shielded twisted pair) cable to connect the Local and Remote Units. There are two methods that can be used:

a) In addition to the eight paired wires, STP cable also contains a grounding wire. Solder this wire to the RJ-45 connector as shown in the diagram below:

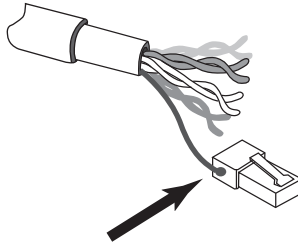

b) The second method is to use the STP cable shielding for grounding. In this case, make sure that the shielding makes tight contact with the top inside of the RJ-45 connector as shown in the diagram below:

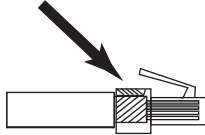

In either case, make sure that the sides of the RJ-45 connector make tight contact with the grounding contacts on the sides of the RJ-45 socket as shown in the diagram below:

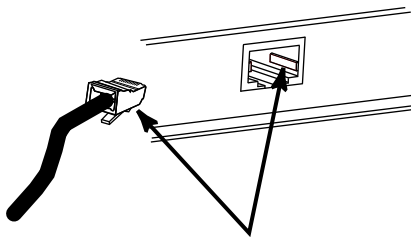

---

## Cable Connection

---

A complete VM1616T installation requires additional transmitter and receiver units that are not included in the VM1616T package. This section uses compatible models, VE500T Transmitter and the VE500R / VE500RQ Receiver, for illustrations. The VE300 system can also be used if RS-232 serial and balanced audio functions are not required. See *Requirements*, page 3, for details.

Installation of the VM1616T is simply a matter of connecting the appropriate cables. Refer to the installation diagrams on the following pages (the numbers in the diagrams correspond to the steps, below), and do the following:

1. Plug the local display's VGA cable into the VM1616T's Video Out port.
2. Plug the local stereo/balanced audio speakers into the appropriate Audio Out ports.
3. If you are using the serial control function, use an appropriate serial cable to connect the computer or serial controller to the VM1616T's female RS-232 port or the RS-485 / RS-422 captive screw connector.
4. If you are using a serial device at the local site, connect it to the VM1616T's male RS-232 port.
5. Plug a Cat 5e cable from the LAN into the VM1616T's Ethernet input port.
6. Use a grounding wire to ground the unit by connecting one end of the wire to the grounding terminal, and the other end of the wire to a suitable grounded object.

---

**Note:** Do not omit this step. Proper grounding helps to prevent damage to the unit from surges or static electricity.

---

7. Connect up to 16 audio/video sources to up to 16 Transmitter units.
8. Using Cat 5e cable, connect the Transmitter's Remote I/O ports to the RJ-45 Cat 5 Input ports on the VM1616T.
9. Connect up to 16 display devices and speakers to up to 16 Receiver units.
10. Using Cat 5e cable, connect the Receiver's Remote I/O ports to the RJ-45 Cat 5 Output ports on the VM1616T.

---

**Note:** See the User Guide of the Video Extender you are using for further installation details.

---

11. Plug the power cord supplied with the package into the VM1616T's 3-prong AC socket, and then into an AC power source.
12. Power on the VM1616T and all devices in the installation.

### **Installation Diagram A**

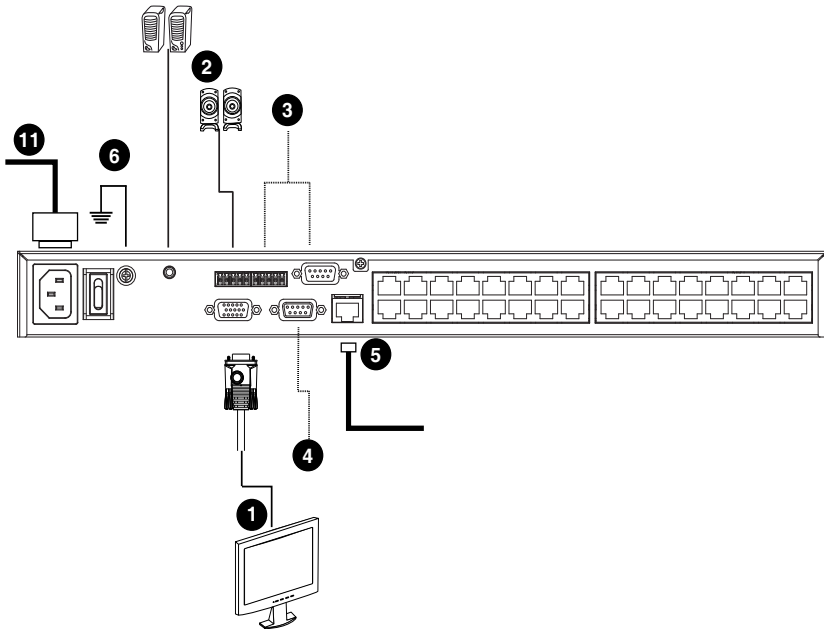

## Installation Diagram B

Audio/Video Source x 16



7

VE500T x 16



8

VM1616T

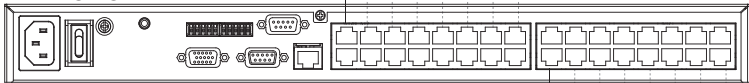

10

VE500R / VE500RQ x 16

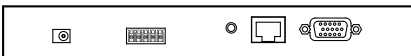

9



Display x 16

This Page Intentionally Left Blank



# Chapter 3

## Local Operation

### Overview

---

The VM1616T can be configured and operated locally via the front panel pushbuttons, or remotely over a standard TCP/IP connection via a Browser graphical user interface (GUI). Local front panel operation is discussed in this chapter. Over-IP (and Telnet) operation is discussed in Chapter 4, *Remote Operation*.

---

**Note:** 1. The VM1616T can also be controlled locally via a serial controller.  
2. See *RS-232 Serial Interface*, page 47, for RS-232 serial commands.

---

### Front Panel Operation

---

The VM1616T features front panel pushbuttons and an LCD display panel for convenient configuration and operation at the local site. This allows you to perform operations such as selecting which source displays on which display, configuring the IP port and serial port, adjusting audio and video levels, and setting security information.

### Basic Navigation

The VM1616T's front panel display operation is intuitive and convenient. Please note the following operation conventions:

- ◆ Use the MENU pushbutton to cycle through the Main Screen options.
- ◆ Use the PROFILE pushbutton to cycle through the profiles (input and output connection).
- ◆ Use the ESC pushbutton to go back a level, return to the Main screen, or exit.
- ◆ Use the ENTER pushbutton to select options and confirm operations.
- ◆ Use the In / Out dials to cycle forwards or backwards through numbered options.

## Menu Organization

Use the Menu pushbutton to cycle through the main menu options, starting from the Password page, in the order show in the table, below:

Menu Page	Sub-Menu Page(s)	
Password		
Main Screen	Profile	Cycle through profiles and change the connection between an input source and output port
	Select Video IN	Select which input source displays on each output port.
Set IP Port	IP Address	Save and Reset / Exit
	Subnet Mask	
	Gateway	
	Default IP Settings	Yes / No
Set Serial Port	Serial Port Address	Save / Exit
	Baud Rate	
	Serial Port Mode	RS-232, RS-422 / RS-485
	Default Serial Setting	Yes / No
Adjust Video Level	Optimize Video Output Port	All / Local / 1–16
		Local / Gain Local / Compensation
Adjust Audio Level	Output Audio Port	All / Local / 1–16
	Audio Level	Stored Values / 0–15
Save / Load Profile	Save to a Profile	0–31
	Call a Saved Profile	
Security Mode	Password Required	Yes / No
	Change Password	Old / New
Switch Audio Only		

## Enter Password

If the VM1616T has been configured to require a password for local operation (see *Security Mode*, page 28], when the password screen is accessed, the cursor flashes on the first digit. Enter a 4-digit password to continue to the Main Screen.

---

**Note:** If you are accessing the VM1616T for the first time, the default password is 1234.

---

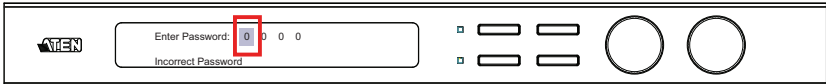

To enter a password, do the following:

1. Use the front panel Out dial and turn it clockwise (right) or counterclockwise (left) to move the cursor.
2. Use the front panel In dial to cycle through the numbers. Turn it clockwise (ascending from 0, 1, 2 .... 9) or counterclockwise (descending from 0, 9, 8 ....1).
3. Press and Release Out/In/Enter pushbuttons to confirm the password and continue to the Main Screen.

- 
- Note:**
1. If you enter an incorrect password, re-enter the correct password over the incorrect string.
  2. If Password Required (see *Security Mode*, page 28) is enabled, the timeout is 5 minutes.
-

## Main Screen

The Main Screen displays Output Ports 1–8 in sequential order across the top. Whichever source is displaying on each output port is shown directly beneath. From the Main Screen, you can set/create input-output connections that route all signals from a selected input port to a selected output port. You can also press the Menu pushbutton to continue cycling through the menu options; or press the ESC pushbutton to exit the display.

## Profiles

From the Main screen; pressing the PROFILE pushbutton switches between the connection profiles added to the Profile Selection list (see *Profile*, page 40). If a connection profile is in use, it is shown from the main page on the lower right corner of the LCD display.

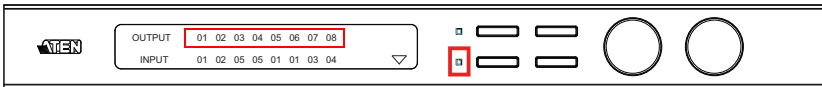

## Video In Selection

To select which input source displays on each output port, do the following:

1. Use the Out dial and turn it clockwise (right) or counterclockwise (left) to select an input port.

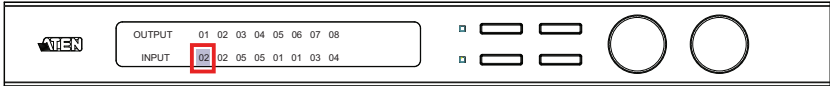

2. When the cursor is on your selected input port, use the In dial and turn it clockwise (ascending from 1, 2 .... 16, NA) or counterclockwise (descending from 1, NA, 16 .... 2) to cycle through the available input sources.  
Options are Ports 1–16 and NA (none).
3. Press In/Out/Enter to confirm your selection. The audio, video, and RS-232 signals from the selected input port are now tied to the selected output port.
4. Repeat steps 1–3 for all required ports.

---

**Note:** 1. This operation ties all three signals (audio, video, serial) from a selected input to a selected output.

2. If you did not make any changes, press ESC pushbutton to return to the Main Screen.

---

## Set IP Port

To configure the VM1616T's IP port settings, select *Set IP Port* from the menu options.

---

**Note:** When configuring the menu options, the Menu LED turns on. Press and release the Menu or ESC pushbutton to return to the Main Screen. The Menu LED turns off.

---



The sub-menu provides four options: *IP Address*; *Subnet Mask*; *Gateway*; and *Default IP Settings*; as follows:

### IP Address

To set the VM1616T's IP address, do the following:

1. Select *IP Address* from the *Set IP Port* submenu. The cursor flashes on the first number. Use the Out dial and turn it clockwise (right) or counterclockwise (left) to move the cursor:



2. Use the In dial and turn it clockwise (ascending from 0, 1, 2 .... 9) or counterclockwise (descending from 0, 9, 8 .... 1) to select each number.
3. Press In/Out/Enter to confirm your selection.

---

**Note:** The default IP address is 192.168.0.60.

---

## Subnet Mask

To set the VM1616T's Subnet Mask, do the following:

1. Select *Subnet Mask* from the *Set IP Port* submenu. The cursor flashes on the first number. Use the Out dial and turn it clockwise (right) or counterclockwise (left) to move the cursor:



2. Use the In dial and turn it clockwise (ascending from 0, 1, 2 .... 9) or counterclockwise (descending from 0, 9, 8 .... 1) to select each number.
3. Press In/Out/Enter to confirm your selection.

---

**Note:** The default Subnet Mask is 255.255.255.0.

---

## Gateway

To set the VM1616T's Gateway, do the following:

1. Select *Gateway* from the *Set IP Port* submenu. The cursor flashes on the first number. Use the Out dial and turn it clockwise (right) or counterclockwise (left) to move the cursor:

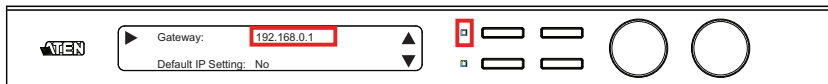

2. Use the In dial and turn it clockwise (ascending from 0, 1, 2 .... 9) or counterclockwise (descending from 0, 9, 8 .... 1) to select each number.
3. Press In/Out/Enter to confirm your selection.

---

**Note:** The default Gateway address is 192.168.0.1.

---

## Default IP Settings

To use / not use the VM1616T's Default IP Settings, do the following:

1. Select *Default IP Settings* from the *Set IP Port* submenu. The cursor flashes on the entry:



2. Use the In/Out dials and turn them clockwise/counterclockwise to select Yes or No, and press In/Out/Enter to confirm.

## Save and Reset / Exit

After each operation, you can either:

- ◆ *Save and Reset the Device* to save all changes and restart the VM1616T;
- ◆ *Exit without Save* to ignore changes and return to the Menu; or
- ◆ Press Menu or ESC to return to the Menu without changing previous values.

The same policy applies to the succeeding sections.



## Set Serial Port

To configure the VM1616T's serial settings, select *Set Serial Port* from the Menu.

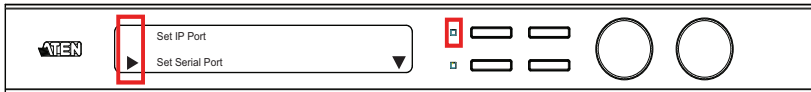

The submenu provides four options: *Serial Port Address*; *Baud Rate*; *Serial Port Mode*; and *Default Serial Settings*, as follows:

### Serial Port Address

To set the VM1616T's serial port address, do the following:

1. Select *Serial Port Address* from the *Set Serial Port* submenu. The cursor flashes on the entry:



2. Use the In dial and turn it clockwise (ascending from 0, 1, 2 .... 15) or counterclockwise (descending from 0, 15, 14.... 1) to select a number.
3. Press In/Out/Enter to confirm your selection.

---

**Note:** The default serial port address is 0.

---

## Baud Rate

To set the VM1616T's baud rate, do the following:

1. Select *Baud Rate* from the *Set Serial Port* submenu. The cursor flashes on the entry:



2. Use the In dial and turn it clockwise (ascending) or counterclockwise (descending) to select a number. Baud rate options are 9600, 19200, 38400, and 115200.
3. Press In/Out/Enter to confirm your selection.

---

**Note:** The default baud rate is 19200.

---

## Serial Port Mode

The VM1616T supports RS-232, and RS-422/RS-485. To set the VM1616T's serial port , do the following:

1. Select *Serial Port Mode* from the *Set Serial Port* submenu. The cursor flashes on the entry:



2. Use the In dial and turn it clockwise or counterclockwise to cycle through the options.  
Mode options are Bypass, RS-232 and RS-422/RS-485.
3. Press In/Out/Enter to confirm your selection.

---

**Note:** The default mode is RS-232.

---

## Default Serial Settings

To use / not use the VM1616T's Default Serial Settings, do the following:

1. Select *Default Serial Settings* from the *Set IP Port* submenu. The cursor flashes on the entry.
2. Use the In/Out dials and turn them clockwise/counterclockwise to select Yes or No, and press In/Out/Enter to confirm.

## Adjust Video Level

Video Gain and Video Compensation can be adjusted for all displays at once, or for each display individually. To adjust video, do the following:

1. Use the Menu button to access the *Adjust Video Level* page.

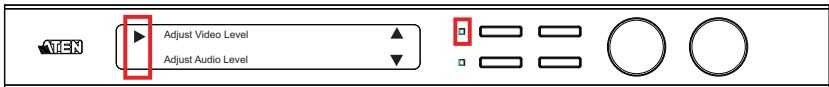

2. With the cursor flashing at *Adjust Video Level*, press In/Out/Enter to go to the *Optimize Video Output Port* page to select the display port(s).



3. Use the In dial and turn it clockwise (ascending from ALL, L, 1.... 16, ALL) or counterclockwise (descending from ALL, 16.... 1, L, ALL) to select the display port(s). This is set to ALL by default.

You are able to select all ports in the installation (ALL), just the local port (L), or any of the 16 ports individually (1–16). Press In/Out/Enter to confirm your selection. If you selected L, proceed to the next step.

4. Select *Local Video Output Gain* or *Local Video Output Compensation*, then cycle through the options to adjust values for the local port.



Options are Stored, Auto, or 0–31. This is set to Stored by default. See page 27 for storing values.

**Note:** If either Gain or Compensation is set to Auto, the other will also set to Auto automatically.

## **Adjust Audio Level**

The audio level (volume) can be adjusted for all sources at once, or for each source individually. To adjust audio, do the following:

1. Use the Menu button to access the *Adjust Audio Level* page.



2. With the cursor flashing at *Adjust Audio Level*, press In/Out/Enter to go to the *Output Audio Port* to select the source port(s).

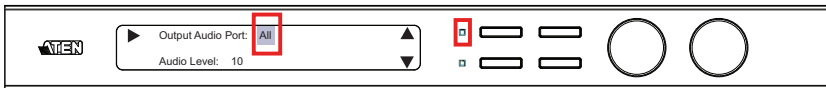

3. Use the In dial and turn it clockwise (ascending from ALL, L, 1... 16, ALL) or counterclockwise (descending from ALL, 16... 1, L, ALL) to select the source port(s). This is set to ALL by default.

You are able to select all ports in the installation (ALL), just the local port (L), or any of the 16 ports individually (1–16).

Press In/Out/Enter to confirm your selection.

4. Select *Audio Level* to set the volume of the audio output. Use the In dial and turn it clockwise (ascending from Stored, 0, 1... 15) or counterclockwise (descending from Stored, 15... 1, 0) to select a volume level.

Options are Stored or 0–15. See page 27 for storing values.

Press In/Out/Enter to confirm your selection.

---

**Note:** 1. The default audio level is 10 (0dB).

2. Audio level L/R: 00 (mute); 01 (-25dB); 15 (+6dB).
-

## Save / Load Profile

The VM1616T allows you to store up to 32 (numbered 0–31) connection profiles that can be configured and recalled later. The stored profiles can be viewed using the browser GUI. See *Profile*, page 40 for more information.

To use the unit's front panel pushbuttons to save/recall profiles, do the following:

1. Use the Menu button to access the *Save / Load Profile* page.



2. With the cursor flashing at *Save / Load Profiles* press In/Out/Enter to go to the Profiles page where you can save or load connection configurations. Use the Out dial and turn it clockwise/counterclockwise to select *Save to a Profile No.* or *Call a saved Profile No.* from the submenu.



3. To save the current connection configuration, bring the cursor to *Save to a Profile No.* submenu. Use the In dial and turn it clockwise (ascending from 0, 1, 2 .... 31) or counterclockwise (descending from 0, 31, 30.... 1) to select and assign a profile to this number. Press In/Out/Enter to save.
4. To load a Saved Profile, bring the cursor to *Call a saved Profile No.* submenu. Use the In dial and turn it clockwise (ascending from 0, 1, 2 .... 31) or counterclockwise (descending from 0, 31, 30.... 1) to select the profile you want to load. Press In/Out/Enter to save.

---

**Note:** The default profile number for the *Save / Load Profile* page is 0.

---

## Security Mode

The Security Mode page allows you to configure the VM1616T's password-related settings.

### Password Settings

To configure the VM1616T's password settings, do the following:

1. Use the Menu button to access the *Security Mode* page.



2. To set the VM1616T to require a password for local operation, select *Password Required*, and use the Out dial and turn it clockwise/ counterclockwise to select Yes or No.



3. To change the password, use the In dial and turn it clockwise (ascending from 0, 1, 2 .... 9) or counterclockwise (descending from 0, 9, 8.... 1) to select the numbers.



4. Enter the old password (see *Enter Password*, page 17). Then, press In/Out/Enter to move the cursor down to *New Password*, and enter the new password in the same way.
5. Press and release In/Out/Enter to confirm the password and continue to the Main menu.

---

**Note:** 1. If you enter an incorrect password, re-enter the correct password over the incorrect string.

2. If Password Required (see *Security Mode*, page 28) is enabled, the timeout is 5 minutes.

---

## Switch Audio Only

The Switch Audio Only page lets you switch HDMI signals to one input port.

1. Use the Out dial and turn it clockwise (right) or counterclockwise (left) to select an input port.

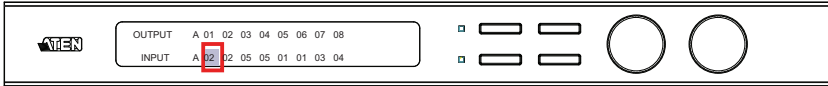

2. When the cursor is on your selected input port, use the In dial and turn it clockwise (ascending from 1, 2 .... 16, NA) or counterclockwise (descending from 1, NA, 16 .... 2) to cycle through the available input sources.

Options are Ports 1–16 and NA (none).

3. Press In/Out/Enter to confirm your selection. The HDMI signals from the selected input port are now tied to the selected output port.
4. Repeat steps 1–3 for all required ports.

---

**Note:** If you did not make any changes, press ESC pushbutton to return to the Main Screen.

---

This Page Intentionally Left Blank



# Chapter 4

## Remote Operation

### Overview

---

The VM1616T 16x16 Cat5 A/V Matrix Switch can be configured and controlled over a standard TCP/IP connection via its own browser Graphical User Interface (GUI). Because the VM1616T can be accessed from anywhere on the LAN, WAN, or Internet, remote operators can log in via any Web browser, from any location. Security is ensured by password protection and user configurable timeout. The VM1616T supports various operational privileges for remote users, and up to 32 users can log into the GUI at one time. For full details, see the sections that follow.

---

**Note:** The VM1616T can also be accessed via a remote terminal session using Telnet. See *Telnet Operation*, page 44, for details.

---

### Logging In

---

To access the browser GUI, type the VM1616T's IP address into the address bar of any browser. The welcome screen appears:



- ♦ The VM1616T's default IP address is <http://192.168.0.60>. See *IP Setup*, page 37, for further information.
- ♦ The default username is *administrator* and default password is *password*. See *Password*, page 43, for further information.

---

**Note:** The VM1616T login supports lower case letters only.





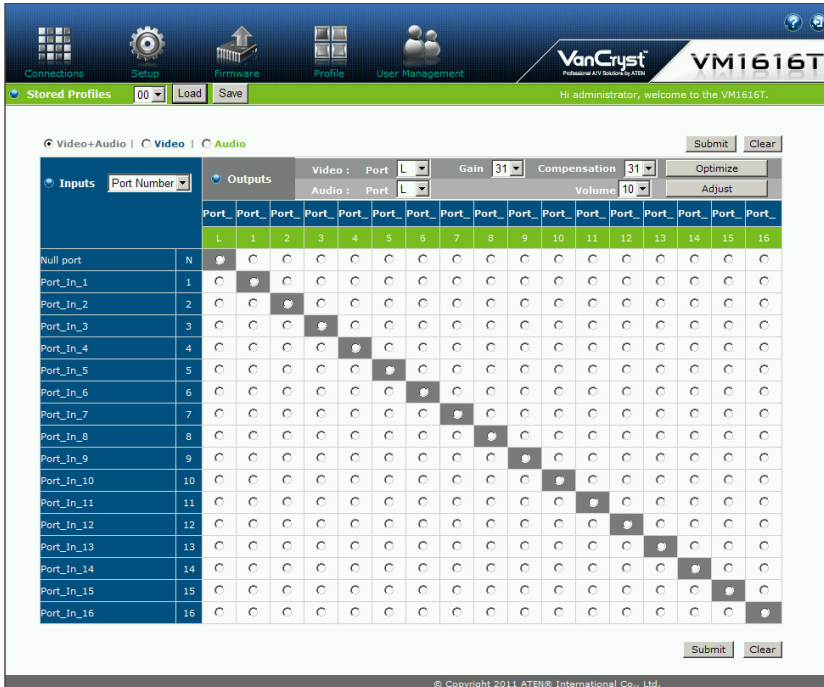

---

# Connections Page

The VM1616T's GUI main page is the *Connections* page. This displays all active connections for control and configuration:



## **Toolbar**

<b>Icon</b>		<b>Description</b>
	Connections	This page displays the VM1616T's active connections and enables you to control them.
	Setup	This page enables you to configure the VM1616T's IP settings, and name ports.
	Firmware	The page enables you to upgrade the VM1616T's firmware.
	Profile	The page enables you to edit the user profiles.
	User Management	This page enables you to configure user permissions, including passwords.
	Logout	This icon ends the session and closes the Web interface.

## **Configuring Connections**

To configure a connection, do the following:

1. Select the radio button at the corresponding input/output intersection of the port(s) you want to configure.

---

**Note:** Multiple connections can be changed simultaneously; simply select all the connections you want to configure.

---

2. Make changes according to the sections that follow.
3. Click the Submit button. The display reloads with the new status changes. Or, click the Clear button to revert to the stored configurations.

### **Status Colors**

Active connections display in one of three colors to indicate their status, as follows:

- ♦ Gray – Audio + Video
- ♦ Blue – Video only
- ♦ Green – Audio only

## Save / Load Connection Profiles

The VM1616T allows you to store up to 32 (numbered 00–31) differently configured connection profiles that can be saved and recalled later by either connection method (both locally via the unit's front panel pushbuttons and over IP via the GUI).

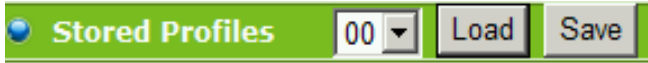

- ◆ Use the Save button to save the current connection profile.
- ◆ Use the drop-down list to select a saved connection profile and then click the Load button to switch to that profile.

---

**Note:** 1. Profile 00 is the default.

2. The latest connection status automatically loads when the VM1616T is reset.
- 

## Operation Type

Use these radio buttons to select your operation parameters. There are three options: You can switch audio + video at the same time (for all or any ports), or you can switch either separately (for all or any ports).

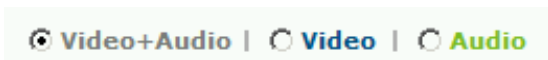

## Viewing Port Information

The input ports can be sorted by port name or port number. Use the drop-down menu to select.

Presets use the same set of port names. Different ports can have the same port name(s).

Output ports can select Null port to indicate there is no input source.

Move your cursor over the *Output Port* number to see the port name displayed (only the first 5 characters are displayed). See *Port Name*, page 38, for further information.

RS-232 mode will display on the output name when your cursor moves over it.

## **Optimizing Video**

For the display attached to the Local port, gain and compensation can be selected for optimization using these buttons. For all other ports, the VM1616T will adjust video levels to achieve the highest quality for all connected monitors.

Video :	Port	L	Gain	31	Compensation	31	Optimize
Audio :	Port	L	Volume	10	Adjust		

1. Use the drop-down menu to select a port for optimization.  
Options are Local (L), All, or Ports 1–16.
2. Select *Gain / Compensation* (Local port only)
3. Click Optimize.

## **Adjust Audio**

To adjust the audio, do the following:

1. Use the drop-down menu to select a port for audio adjustment.  
Options are Local (L), All, or Ports 1–16.  
Use the drop-down menu to select the volume level.
2. Click Adjust.

## Setup

---

Click the *Setup* icon to configure the VM1616T's IP and serial settings, and to name all the ports in your installation.

### IP Setup

The Web Setup settings enable you to configure the VM1616T's Web interface connection. Changes take a few seconds and automatically redirect you to the IP address specified.

Web	Serial	Port Name
IP Address	<input type="text" value="192.168.0.60"/>	
Subnet Mask	<input type="text" value="255.255.255.0"/>	
Default Gateway	<input type="text" value="192.168.0.1"/>	
Website Time out	<input type="text" value="N/A"/>	
Telnet Configuration	<input checked="" type="checkbox"/>	
MAC Address	00:10:74:9A:01:01	

Enter values and then click Save or Clear. Click *Default Setting* to use the following defaults:

- ◆ *IP Address* – 192.168.0.60
- ◆ *Subnet Mask* – 255.255.255.0
- ◆ *Default Gateway* – 192.168.0.1
- ◆ *Website Timeout* – 5 minutes

---

**Note:** This option controls how long an inactive Web connection stays logged in to the VM1616T. Any changes will take effect immediately.

---

### Telnet Configuration

Enable the checkbox if you want the VM1616T to receive commands on Port 23 for telnet use. See *Telnet Operation*, page 44, for further details.

---

**Note:** The VM1616T must be power cycled for a change in the Telnet configuration block to take effect.

---

## Serial Setup

The *Serial Setup* settings enable you to configure the VM1616T's serial connection. Use the drop-down menus to select values and then click Save or Clear. Click *Default Setting* to use the following defaults:

- ◆ *Serial Port Address* – 0
- ◆ *Baud Rate* – 19200
- ◆ *Serial Port Mode* – RS-232

---

**Note:** Mode options are RS-232 and RS-422/RS-485.

---

## Port Name

The *Port Name* page enables Administrators and Super Users to change the display name of the input and output ports.

Input Num.	Input Name			Output Num.	Output Name		
1	<input type="text" value="Port_In_1"/>	<input type="button" value="Save"/>	<input type="button" value="Clear"/>	Local	<input type="text" value="Port_Out_0"/>	<input type="button" value="Save"/>	<input type="button" value="Clear"/>
2	<input type="text" value="Port_In_2"/>	<input type="button" value="Save"/>	<input type="button" value="Clear"/>	1	<input type="text" value="Port_Out_1"/>	<input type="button" value="Save"/>	<input type="button" value="Clear"/>
3	<input type="text" value="Port_In_3"/>	<input type="button" value="Save"/>	<input type="button" value="Clear"/>	2	<input type="text" value="Port_Out_2"/>	<input type="button" value="Save"/>	<input type="button" value="Clear"/>
4	<input type="text" value="Port_In_4"/>	<input type="button" value="Save"/>	<input type="button" value="Clear"/>	3	<input type="text" value="Port_Out_3"/>	<input type="button" value="Save"/>	<input type="button" value="Clear"/>
5	<input type="text" value="Port_In_5"/>	<input type="button" value="Save"/>	<input type="button" value="Clear"/>	4	<input type="text" value="Port_Out_4"/>	<input type="button" value="Save"/>	<input type="button" value="Clear"/>
6	<input type="text" value="Port_In_6"/>	<input type="button" value="Save"/>	<input type="button" value="Clear"/>	5	<input type="text" value="Port_Out_5"/>	<input type="button" value="Save"/>	<input type="button" value="Clear"/>
7	<input type="text" value="Port_In_7"/>	<input type="button" value="Save"/>	<input type="button" value="Clear"/>	6	<input type="text" value="Port_Out_6"/>	<input type="button" value="Save"/>	<input type="button" value="Clear"/>
8	<input type="text" value="Port_In_8"/>	<input type="button" value="Save"/>	<input type="button" value="Clear"/>	7	<input type="text" value="Port_Out_7"/>	<input type="button" value="Save"/>	<input type="button" value="Clear"/>
9	<input type="text" value="Port_In_9"/>	<input type="button" value="Save"/>	<input type="button" value="Clear"/>	8	<input type="text" value="Port_Out_8"/>	<input type="button" value="Save"/>	<input type="button" value="Clear"/>
10	<input type="text" value="Port_In_10"/>	<input type="button" value="Save"/>	<input type="button" value="Clear"/>	9	<input type="text" value="Port_Out_9"/>	<input type="button" value="Save"/>	<input type="button" value="Clear"/>
11	<input type="text" value="Port_In_11"/>	<input type="button" value="Save"/>	<input type="button" value="Clear"/>	10	<input type="text" value="Port_Out_10"/>	<input type="button" value="Save"/>	<input type="button" value="Clear"/>
12	<input type="text" value="Port_In_12"/>	<input type="button" value="Save"/>	<input type="button" value="Clear"/>	11	<input type="text" value="Port_Out_11"/>	<input type="button" value="Save"/>	<input type="button" value="Clear"/>
13	<input type="text" value="Port_In_13"/>	<input type="button" value="Save"/>	<input type="button" value="Clear"/>	12	<input type="text" value="Port_Out_12"/>	<input type="button" value="Save"/>	<input type="button" value="Clear"/>
14	<input type="text" value="Port_In_14"/>	<input type="button" value="Save"/>	<input type="button" value="Clear"/>	13	<input type="text" value="Port_Out_13"/>	<input type="button" value="Save"/>	<input type="button" value="Clear"/>
15	<input type="text" value="Port_In_15"/>	<input type="button" value="Save"/>	<input type="button" value="Clear"/>	14	<input type="text" value="Port_Out_14"/>	<input type="button" value="Save"/>	<input type="button" value="Clear"/>
16	<input type="text" value="Port_In_16"/>	<input type="button" value="Save"/>	<input type="button" value="Clear"/>	15	<input type="text" value="Port_Out_15"/>	<input type="button" value="Save"/>	<input type="button" value="Clear"/>
				16	<input type="text" value="Port_Out_16"/>	<input type="button" value="Save"/>	<input type="button" value="Clear"/>

(Max 16 characters, only 0-9,a-z,A-Z,\_,-)

To change the display name, enter a value and click Save. Click Clear to revert to the previous stored named.



---

## Firmware

---

Click the *Firmware* icon to view information about the VM1616T's firmware version and to upgrade. This is an Administrator function only

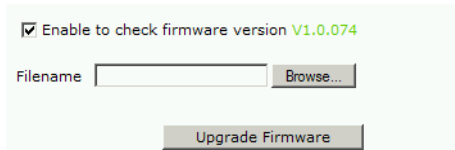

Enable to check firmware version V1.0.074

Filename

To upgrade the VM1616T's firmware, do the following:

1. Use the *Browse* button to locate the firmware upgrade file.
2. Click Upgrade Firmware to start the upgrade.

---

**Note:** Check the box to enable the utility to compare the VM1616T's current firmware version with that of the upgrade files. If it finds that the VM1616T's firmware version is the same or higher than the selected upgrade version, it brings up a dialog box informing you of the situation and gives you the option to Continue or Cancel.

---

## Profile

The VM1616T stores up to 32 connection profiles, numbered 00–31, that can be recalled through the *Profile* page or via the front panel pushbuttons.

Click the *Profile* icon to view the saved profiles, as well as add and delete profiles. You can also assign descriptive names to the profiles.

### Selection

The table shows the port number, profile number assigned to the port and the name assigned to the profile.

You can add a profile by selecting the numbered port (00–31) and clicking Add. The added profile appears in the *Profile List*.

To delete a profile, check the corresponding profile under the *Select* column (you can choose more than one) and click Delete.

Profile

**Profile List**

Select No.	Profile No.	Profile Name	
<input type="checkbox"/>	1	1	Profile_1
<input type="checkbox"/>	2	7	Profile_7
<input type="checkbox"/>	3	6	Profile_6
<input type="checkbox"/>	4	3	Profile_3

## Name

You can assign a descriptive name to a Profile, using sixteen characters (i.e., a-z, 0-9, -, \_). Simply type the name in the provided field and click Save. Click Clear to use the default profile name.

Profile Num.	Profile Name		
00	<input type="text" value="Profile_0"/>	<input type="button" value="Save"/>	<input type="button" value="Clear"/>
01	<input type="text" value="Profile_1"/>	<input type="button" value="Save"/>	<input type="button" value="Clear"/>
02	<input type="text" value="Profile_2"/>	<input type="button" value="Save"/>	<input type="button" value="Clear"/>
03	<input type="text" value="Profile_3"/>	<input type="button" value="Save"/>	<input type="button" value="Clear"/>
04	<input type="text" value="Profile_4"/>	<input type="button" value="Save"/>	<input type="button" value="Clear"/>
05	<input type="text" value="Profile_5"/>	<input type="button" value="Save"/>	<input type="button" value="Clear"/>
06	<input type="text" value="Profile_6"/>	<input type="button" value="Save"/>	<input type="button" value="Clear"/>
07	<input type="text" value="Profile_7"/>	<input type="button" value="Save"/>	<input type="button" value="Clear"/>
08	<input type="text" value="Profile_8"/>	<input type="button" value="Save"/>	<input type="button" value="Clear"/>
09	<input type="text" value="Profile_9"/>	<input type="button" value="Save"/>	<input type="button" value="Clear"/>
10	<input type="text" value="Profile_10"/>	<input type="button" value="Save"/>	<input type="button" value="Clear"/>
11	<input type="text" value="Profile_11"/>	<input type="button" value="Save"/>	<input type="button" value="Clear"/>
12	<input type="text" value="Profile_12"/>	<input type="button" value="Save"/>	<input type="button" value="Clear"/>
13	<input type="text" value="Profile_13"/>	<input type="button" value="Save"/>	<input type="button" value="Clear"/>
14	<input type="text" value="Profile_14"/>	<input type="button" value="Save"/>	<input type="button" value="Clear"/>
15	<input type="text" value="Profile_15"/>	<input type="button" value="Save"/>	<input type="button" value="Clear"/>

Profile Num.	Profile Name		
16	<input type="text" value="Profile_16"/>	<input type="button" value="Save"/>	<input type="button" value="Clear"/>
17	<input type="text" value="Profile_17"/>	<input type="button" value="Save"/>	<input type="button" value="Clear"/>
18	<input type="text" value="Profile_18"/>	<input type="button" value="Save"/>	<input type="button" value="Clear"/>
19	<input type="text" value="Profile_19"/>	<input type="button" value="Save"/>	<input type="button" value="Clear"/>
20	<input type="text" value="Profile_20"/>	<input type="button" value="Save"/>	<input type="button" value="Clear"/>
21	<input type="text" value="Profile_21"/>	<input type="button" value="Save"/>	<input type="button" value="Clear"/>
22	<input type="text" value="Profile_22"/>	<input type="button" value="Save"/>	<input type="button" value="Clear"/>
23	<input type="text" value="Profile_23"/>	<input type="button" value="Save"/>	<input type="button" value="Clear"/>
24	<input type="text" value="Profile_24"/>	<input type="button" value="Save"/>	<input type="button" value="Clear"/>
25	<input type="text" value="Profile_25"/>	<input type="button" value="Save"/>	<input type="button" value="Clear"/>
26	<input type="text" value="Profile_26"/>	<input type="button" value="Save"/>	<input type="button" value="Clear"/>
27	<input type="text" value="Profile_27"/>	<input type="button" value="Save"/>	<input type="button" value="Clear"/>
28	<input type="text" value="Profile_28"/>	<input type="button" value="Save"/>	<input type="button" value="Clear"/>
29	<input type="text" value="Profile_29"/>	<input type="button" value="Save"/>	<input type="button" value="Clear"/>
30	<input type="text" value="Profile_30"/>	<input type="button" value="Save"/>	<input type="button" value="Clear"/>
31	<input type="text" value="Profile_31"/>	<input type="button" value="Save"/>	<input type="button" value="Clear"/>

## User Management

---

Click the *User Management* icon to add, edit, or remove user information, and to change the password for accessing the VM1616T's GUI.

---

**Note:** This is an Administrator only function.

---

Username	Description	Status
 administrator	Default_user	Administrator
 user1	user1	User

Operations are as follows:

- ◆ Add User – Click Add to add another user to the list. The VM1616T supports up to 32 users at one time.
- ◆ Edit User – Select user and click Edit to change information. This option allows an Administrator to set/reset the selected user's password, add a description of the user, and to set the user's privileges. See below for full details.
- ◆ Delete User – Select user and click Delete to remove all user information.

## Password

Use the Edit User function to change the user's password for accessing the VM1616T's GUI.

Username	<input type="text"/>	(Please enter 5-16 characters, only 0-9, a-z, _ -)
Password	<input type="text"/>	(Please enter 5-16 characters, only 0-9, a-z, _ -)
Confirm Password	<input type="text"/>	(Please enter 5-16 characters, only 0-9, a-z, _ -)
Description	<input type="text"/>	(Max 16 characters, only 0-9, a-z, A-Z, _ -)

Status

**Administrator**  
Add/Edit/Delete all users, full rights

**Super User**  
Full rights

**User**  
Basic rights (make ties, save and recall presets, adjust audio level)



This password is also used for the Telnet interface (see *Telnet Configuration*, page 37). Passwords are case sensitive, and must be 5–16 alphanumeric characters.

## Privileges

Use the Edit User function to set a user's privileges. The three available levels are as follows:

- ◆ *Administrator* – this level provides full access and control of the VM1616T functions in addition to full User Management privileges
- ◆ *Super User* – this level provides full access and control with no User Management privileges
- ◆ *User* – this level provides basic functions only (create connections, save and recall presets, adjust audio)

## Telnet Operation

---

The VM1616T can be operated and configured via a remote terminal session using Telnet.

To log into the VM1616T by means of a Telnet session, do the following:

1. On your computer, open a terminal (command line) session.
2. At the prompt, key in the VM1616T's IP address in the following way:  

```
telnet [IP address]:23
```
3. Press Enter. The login screen appears. At the login prompt, provide your Username and Password.

### **Configuration Menu**

Once a Telnet connection to the VM1616T is established, the device's text-based Configuration Menu comes up, with the following items:

#### **1. H – Call up the command list for help**

Command list:

GT – Set gateway address

IM – Set IP subnet mask

IP – Set IP address

LO – Load connections from *nn* profile

PW – Change password

RI– Read what output is connected to *nn* input

RO – Read what output is connected to *nn* input

SB – Set the serial port baud rate

SS – Switch input to specified port

SV - Save the current connection to *nn* profile

TI – Set timeout

VR – Software version information

Ctrl-Q – Quit

## 2. GT – Set gateway address

GT

Old gateway address: 192.168.0.1

New gateway address:

## 3. IM – Set IP subnet mask

IM

Old IP subnet mask: 255.255.255.0

New IP subnet mask:

## 4. IP – Set IP address

IP

Old IP address: 192.168.0.60

New IP address:

## 5. LO – Load connections from profile

LO 01

Load profile 01 OK.

## 6. PW – Change password

PW

Old password: \*\*\*\*\*

New password:

## 7. RI – Read what input is connected to *nn* output

RI 01

Output port 02 04 08 is connected input port 01

## 8. RO – Read what output is connected to *nn* input

RO 01

Input port 02 is connected to output port 01

## 9. SB – Set serial port baud rate

SB 96

Serial port baud rate is set to 9600

---

**Note:** 96 (9600), 19 (19200), 38 (38400), 11 (115200)

---

## 10. SS – Switch input to specified output

SS 01, 03

Switch input 01 to output 03

## 12. SV – Save the current connection to a profile

SV 01

Save the current connection to profile 01

## 13. TI – Set timeout

TI 30

Set 30 minute timeout

## 14. VR – Software version information

VR

Software version 1.0.

---

**Note:** For further information about these functions, please reference the equivalent Browser GUI functions earlier in this chapter.

---



# Chapter 5

## RS-232 Commands

### **RS-232 Serial Interface**

---

This chapter provides a complete list of the serial control protocol commands used when utilizing the RS-232 Serial Port so that an extra source device can function further as transmitter and receiver.

The VM1616T's built-in bi-directional RS-232 serial interface allows system control through a high-end controller, PC, and/or home automation / home theater software package.

### **Configuring the Serial Port**

The controller's serial port should be configured as follows:

Baud Rate	19200
Data Bits	8
Parity	None
Stop Bits	1
Flow Control	None

### **RS-232 Control Tool**

RS-232 serial operations in a VM1616T installation can be managed via a Graphical User Interface (GUI) on systems that are running Windows. In order to use this Control Tool, two separate items of software must be installed on all of the PCs in your installation – .NET Framework 2.0 and the Control Tool AP. Please download the VM1616T RS-232 Control Tool AP and user instructions from the ATEN website ([www.aten.com](http://www.aten.com)).

---

**Note:** For Windows 7 64-bit systems, the following must be installed first:

- 1) Microsoft Office 64-bit Access Database software; and
  - 2) Microsoft 64-bit ODBC and OLEDB driver.
-

## Switch Port Commands

The formulas for Switch Port commands are as follows:

1. Switch Command + Input Command + Port number + Output Command + Port Number + Address + Device Number + Control + [Enter]

For example, to switch input port 02 (audio and video) to output port 05 on device 01, type the following:

```
sw i02 o05 a01 [Enter]
```

2. Switch Command + Output Command + Port Number + Address + Device Number + Control + [Enter]

For example, to turn off video output on port 03, type the following:

```
sw O03 a00 video off [Enter]
```

3. Switch Command + Output Command + Port Number + Address + Device Number + Control + [Enter]

For example, to switch the next output to the local port, type the following:

```
sw l1 + a00 [Enter]
```

## Possible Values

The following table shows the possible values for switch commands:

Command	Description
sw	Switch command

Input Command	Description
i	Input command

Input Port Number	Description
xx	01-16 port (default is 01)

Output Command	Description
o	Output command

Output Port Number	Description
yy	01-16 port (default is 01)
l1	Local output port
*	All output ports

Address	Description	
a	Device address	
Device Number	Description	
zz	00-15 (default is 00)	
*	All devices	
Control	Description	
on	Turn on	
off	Turn off	
+	Next port	
-	Previous port	
video	Switch video only	skip = video+audio
audio	Switch audio only	
Enter	Description	
[Enter]	Enter and send out the command	
Acknowledge	Description	
Command OK	Command is correct and the function is executed	
Command Incorrect	Unavailable command or parameters	

- Note:**
1. Each command string can be separated with a space.
  2. Some command strings can be skipped, and the default value will be used.
  3. The **Audio** or **Video** command string can be skipped, and both values will be used.
  4. If the command setting applies to all devices, the devices do not reply in order to prevent RX interference.
  5. When sending commands without an address parameter, the default address used is a00; in addition, the a00 device replies (ACK) while other devices (i.e., a01 a02...) do not reply.

## **Mute Commands**

The formulas for Mute commands are as follows:

1. Mute Command + Output Command + Port Number + Address + Device Number + Control + [Enter]

For example, to mute output port 05 on device 01, type the following:

mute o05 a01 on [Enter]

2. Mute Command + Output Command + Port Number + Address + Device Number + Control + [Enter]

For example, turn on audio at output port 05 on device 01, type the following:

mute o05 a01 off [Enter]

The following tables show the possible values for commands:

<b>Command</b>	<b>Description</b>
mute	Mute selected output port

<b>Output Command</b>	<b>Description</b>
o	Output command

<b>Output Port Number</b>	<b>Description</b>
yy	01-16 port
l1	Local output port
*	All output ports (default)

<b>Address</b>	<b>Description</b>
a	Device Serial Port address

<b>Device Number</b>	<b>Description</b>
zz	00-15 (default is 00)
*	All devices

<b>Control</b>	<b>Description</b>
on	Mute on; audio from selected output port is disabled
off	Mute off; audio output enabled (default)

---

**Note:** Each command string can be separated with a space.

---

## **Save/Load Profile Commands**

The formulas for Save/Load Profile commands are as follows:

1. Command + Profile + Number + Address + Number + Control + [Enter]

For example, to save the current connection configuration to profile 12 on device 01, type the following:

profile f 12 a01 save [Enter]

2. Command + Profile + Number + Address + Number + Control + [Enter]

For example, to load profile 12 on device 01, type the following:

profile f 12 a01 load [Enter]

The following tables show the possible values for commands:

<b>Profile</b>	<b>Description</b>
f	Profile

<b>Command</b>	<b>Description</b>
profile	Save / Load profile

<b>Profile Number</b>	<b>Description</b>
yy	00-31 (default is 00)

<b>Address</b>	<b>Description</b>
a	Device address

<b>Device Number</b>	<b>Description</b>
zz	00-15 (default is 00)
*	All devices

<b>Control</b>	<b>Description</b>
save	Save the current connection configuration
load	Load a saved profile

## **Adjust Video Quality Commands**

The formula for Adjust Video Quality commands is as follows:

1. Command + Output + Number + Address + Number + Control + [Enter]

For example, to optimize video quality for output port 02 on device 01, type the following:

```
video o02 a01 optimize [Enter]
```

The following tables show the possible values for commands:

<b>Command</b>	<b>Description</b>
video	Video quality adjustment

<b>Output Command</b>	<b>Description</b>
o	Output command

<b>Output Port Number</b>	<b>Description</b>
yy	01-16 port (default is 01)
l1	Local output port
*	All output ports

<b>Address</b>	<b>Description</b>
a	Device address

<b>Device Number</b>	<b>Description</b>
zz	00-15 (default is 00)
*	All devices

<b>Control</b>	<b>Description</b>
optimize	Adjust video gain and video compensation for selected displays

## Adjust Audio Commands

The formula for Adjust Audio commands is as follows:

1. Command + Output + Number + Control + [Enter]

For example, to adjust the audio volume for output port 02 to level 11, type the following:

volume o02 v11 [Enter]

The following tables show the possible values for commands:

Command	Description
volume	Adjust audio level (volume)

Output Command	Description
o	Output command

Output Port Number	Description
yy	01-16 port (default is 01)
l1	Local output port
*	All output ports

Address	Description
a	Device address

Device Number	Description
zz	00-15 (default is 00)
*	All devices

Control	Description
vxx	v = Volume xx = Audio level 00-15 (default is 00) Example: v10

## **Verification**

After entering a command, a verification message appears at the end of the command line as follows:

- ◆ **Command OK** - indicates that the command is correct and successfully performed by the switch
- ◆ **Command incorrect** - indicates that the command has the wrong format and/or values.



## Safety Instructions

---

### General

- ◆ Read all of these instructions. Save them for future reference.
- ◆ Follow all warnings and instructions marked on the device.
- ◆ This product is for indoor use only.
- ◆ Do not place the device on any unstable surface (cart, stand, table, etc.). If the device falls, serious damage will result.
- ◆ Do not use the device near water.
- ◆ Do not place the device near, or over, radiators or heat registers.
- ◆ The device cabinet is provided with slots and openings to allow for adequate ventilation. To ensure reliable operation, and to protect against overheating, these openings must never be blocked or covered.
- ◆ The device should never be placed on a soft surface (bed, sofa, rug, etc.) as this will block its ventilation openings. Likewise, the device should not be placed in a built in enclosure unless adequate ventilation has been provided.
- ◆ Never spill liquid of any kind on the device.
- ◆ Unplug the device from the wall outlet before cleaning. Do not use liquid or aerosol cleaners. Use a damp cloth for cleaning.
- ◆ The device should be operated from the type of power source indicated on the marking label. If you are not sure of the type of power available, consult your dealer or local power company.
- ◆ The device is designed for IT power distribution systems with 230V phase-to-phase voltage.
- ◆ To prevent damage to your installation it is important that all devices are properly grounded.
- ◆ The device is equipped with a 3-wire grounding type plug. This is a safety feature. If you are unable to insert the plug into the outlet, contact your electrician to replace your obsolete outlet. Do not attempt to defeat the purpose of the grounding-type plug. Always follow your local/national wiring codes.
- ◆ Do not allow anything to rest on the power cord or cables. Route the power cord and cables so that they cannot be stepped on or tripped over.

- ◆ If an extension cord is used with this device make sure that the total of the ampere ratings of all products used on this cord does not exceed the extension cord ampere rating. Make sure that the total of all products plugged into the wall outlet does not exceed 15 amperes.
- ◆ To help protect your system from sudden, transient increases and decreases in electrical power, use a surge suppressor, line conditioner, or un-interruptible power supply (UPS).
- ◆ Position system cables and power cables carefully; Be sure that nothing rests on any cables.
- ◆ Never push objects of any kind into or through cabinet slots. They may touch dangerous voltage points or short out parts resulting in a risk of fire or electrical shock.
- ◆ Do not attempt to service the device yourself. Refer all servicing to qualified service personnel.
- ◆ If the following conditions occur, unplug the device from the wall outlet and bring it to qualified service personnel for repair.
  - ◆ The power cord or plug has become damaged or frayed.
  - ◆ Liquid has been spilled into the device.
  - ◆ The device has been exposed to rain or water.
  - ◆ The device has been dropped, or the cabinet has been damaged.
  - ◆ The device exhibits a distinct change in performance, indicating a need for service.
  - ◆ The device does not operate normally when the operating instructions are followed.
- ◆ Only adjust those controls that are covered in the operating instructions. Improper adjustment of other controls may result in damage that will require extensive work by a qualified technician to repair.

---

## **Rack Mounting**

- ◆ Before working on the rack, make sure that the stabilizers are secured to the rack, extended to the floor, and that the full weight of the rack rests on the floor. Install front and side stabilizers on a single rack or front stabilizers for joined multiple racks before working on the rack.
- ◆ Always load the rack from the bottom up, and load the heaviest item in the rack first.
- ◆ Make sure that the rack is level and stable before extending a device from the rack.
- ◆ Use caution when pressing the device rail release latches and sliding a device into or out of a rack; the slide rails can pinch your fingers.
- ◆ After a device is inserted into the rack, carefully extend the rail into a locking position, and then slide the device into the rack.
- ◆ Do not overload the AC supply branch circuit that provides power to the rack. The total rack load should not exceed 80 percent of the branch circuit rating.
- ◆ Make sure that all equipment used on the rack – including power strips and other electrical connectors – is properly grounded.
- ◆ Ensure that proper airflow is provided to devices in the rack.
- ◆ Ensure that the operating ambient temperature of the rack environment does not exceed the maximum ambient temperature specified for the equipment by the manufacturer.
- ◆ Do not step on or stand on any device when servicing other devices in a rack.

## Technical Support

---

### International

- ◆ For online technical support – including troubleshooting, documentation, and software updates: **<http://eservice.aten.com>**
- ◆ For telephone support, see *Telephone Support*, page iii:

### North America

Email Support		<a href="mailto:support@aten-usa.com">support@aten-usa.com</a>
Online Technical Support	Troubleshooting Documentation Software Updates	<a href="http://www.aten-usa.com/support">http://www.aten-usa.com/support</a>
Telephone Support		1-888-999-ATEN ext 4988

When you contact us, please have the following information ready beforehand:

- ◆ Product model number, serial number, and date of purchase.
- ◆ Your computer configuration, including operating system, revision level, expansion cards, and software.
- ◆ Any error messages displayed at the time the error occurred.
- ◆ The sequence of operations that led up to the error.
- ◆ Any other information you feel may be of help.

## Specifications

Function			VM1616T
Input Connections	Direct		0
	Max		16 x Transmitter
Display Connections	Direct		1
	Max		17 (1 x Local; 16 x Receiver)
Connectors	Local	Audio Out	1 x Captive Screw Connector, 5 pole
		Balance d	
		Stereo	1 x Mini Stereo Jack Female (Green)
		Video Out	1 x HDB-15 Female (Blue)
	Unit to Unit	A/V In	16 x RJ-45 Female
		A/V Out	16 x RJ-45 Female
	Ethernet		1 x RJ-45 Female
	Serial	RS-232	1 x DB-9 Female (Black); 1 x DB-9 Male (Black)
		RS-485 / RS-422	1 x Captive Screw Connector, 5 pole
	LCD		1 x LCD module
Power		1 x 3-prong AC Socket	
Switches	In / Out		2 x Dial / Pushbutton
	Menu		1 x Pushbutton
	Profile		1 x Pushbutton
	Esc		1 x Pushbutton
	Enter		1 x Pushbutton
	Power		1 x Rocker
LEDs	Menu		1 (Green)
	Profile		1 (Green)
I/P Rating			100-240V~; 50-60Hz; 1.0A
Power Consumption			120V / 34W; 230V / 35W
Environment	Operating Temp.		0–50°C
	Storage Temp.		-20–60°C
	Humidity		0–80% RH, Non-condensing
Physical Properties	Housing		Metal
	Weight		3.63 kg
	Dimensions (L x W x H)		43.24 x 27.12 x 4.40 cm

## Troubleshooting

---

Problem	Possible Cause	Action
Audio cannot be controlled or adjusted	RS-232 and video signals are switched to different channels	Switch the video, audio, and RS-232 signals to the same channel, and then the volume can be adjusted. -OR- Manually adjust the audio on the connected audio devices (e.g. amplifier.)

## Limited Warranty

---

IN NO EVENT SHALL THE DIRECT VENDOR'S LIABILITY EXCEED THE PRICE PAID FOR THE PRODUCT FROM DIRECT, INDIRECT, SPECIAL, INCIDENTAL, OR CONSEQUENTIAL DAMAGES RESULTING FROM THE USE OF THE PRODUCT, DISK, OR ITS DOCUMENTATION.

The direct vendor makes no warranty or representation, expressed, implied, or statutory with respect to the contents or use of this documentation, and especially disclaims its quality, performance, merchantability, or fitness for any particular purpose.

The direct vendor also reserves the right to revise or update the device or documentation without obligation to notify any individual or entity of such revisions, or update. For further inquiries, please contact your direct vendor.

## Free Manuals Download Website

<http://myh66.com>

<http://usermanuals.us>

<http://www.somanuals.com>

<http://www.4manuals.cc>

<http://www.manual-lib.com>

<http://www.404manual.com>

<http://www.luxmanual.com>

<http://aubethermostatmanual.com>

Golf course search by state

<http://golfingnear.com>

Email search by domain

<http://emailbydomain.com>

Auto manuals search

<http://auto.somanuals.com>

TV manuals search

<http://tv.somanuals.com>