

Aspire 5680/5630/3690 TravelMate 4280/4230/2490 Series Service Guide

Service guide files and updates are available on the ACER/CSD web; for more information, please refer to <http://csd.acer.com.tw>

PRINTED IN TAIWAN

Revision History

Please refer to the table below for the updates made on Aspire 5680/5630/3690 and TravelMate 4280/4230/2490 service guide.

Date	Chapter	Updates

Copyright

Copyright © 2006 by Acer Incorporated. All rights reserved. No part of this publication may be reproduced, transmitted, transcribed, stored in a retrieval system, or translated into any language or computer language, in any form or by any means, electronic, mechanical, magnetic, optical, chemical, manual or otherwise, without the prior written permission of Acer Incorporated.

Disclaimer

The information in this guide is subject to change without notice.

Acer Incorporated makes no representations or warranties, either expressed or implied, with respect to the contents hereof and specifically disclaims any warranties of merchantability or fitness for any particular purpose. Any Acer Incorporated software described in this manual is sold or licensed "as is". Should the programs prove defective following their purchase, the buyer (and not Acer Incorporated, its distributor, or its dealer) assumes the entire cost of all necessary servicing, repair, and any incidental or consequential damages resulting from any defect in the software.

Acer is a registered trademark of Acer Corporation.

Intel is a registered trademark of Intel Corporation.

Pentium and Pentium II/III are trademarks of Intel Corporation.

Other brand and product names are trademarks and/or registered trademarks of their respective holders.

Conventions

The following conventions are used in this manual:

SCREEN MESSAGES	Denotes actual messages that appear on screen.
NOTE	Gives bits and pieces of additional information related to the current topic.
WARNING	Alerts you to any damage that might result from doing or not doing specific actions.
CAUTION	Gives precautionary measures to avoid possible hardware or software problems.
IMPORTANT	Reminds you to do specific actions relevant to the accomplishment of procedures.

Preface

Before using this information and the product it supports, please read the following general information.

1. This Service Guide provides you with all technical information relating to the BASIC CONFIGURATION decided for Acer's "global" product offering. To better fit local market requirements and enhance product competitiveness, your regional office MAY have decided to extend the functionality of a machine (e.g. add-on card, modem, or extra memory capability). These LOCALIZED FEATURES will NOT be covered in this generic service guide. In such cases, please contact your regional offices or the responsible personnel/channel to provide you with further technical details.
2. Please note WHEN ORDERING FRU PARTS, that you should check the most up-to-date information available on your regional web or channel. If, for whatever reason, a part number change is made, it will not be noted in the printed Service Guide. For ACER-AUTHORIZED SERVICE PROVIDERS, your Acer office may have a DIFFERENT part number code to those given in the FRU list of this printed Service Guide. You MUST use the list provided by your regional Acer office to order FRU parts for repair and service of customer machines.

System Specifications

Features

Below is a brief summary of the computer's many feature:

Platform and memroy

Aspire 5680/5630 Series and TravelMate 4280/4230 Series

- ❑ Intel® Centrino® Duo mobile technology, featuring:
 - Intel® Core™ 2 Duo processor T7200/7400/7600 (4 MB L2 cache, 2.0/2.16/2.33 GHz, 667 MHz FSB) and T5500/5600 (2MB L2 cache, 1.66/1.83 GHz, 667 MHz FSB), supporting Intel® EM64T
 - Intel® 945GM/945PM+ICH7M
- ❑ Intel® PRO/Wireless 3945ABG network connection (dual-band tri-mode 802.11a/b/g) Wi-Fi CERTIFIED™ solution, supporting Acer SignalUp™ wireless technology **(for TravelMate 4280/4230)**
- ❑ Up to 2 GB of DDR2 533/667 MHz memory, upgradeable to 4 GB using two soDIMM modules (dual-channel support) (for Aspire 5680/5630 and TravelMate 4280/4230)
- ❑ 256/512 MB of DDR2 533 MHz memory, upgradeable to 2 GB using two soDIMM modules (dual-channel support) (for Aspire 3690/TravelMate 2490)

Aspire 3690 Series and TravelMate 2490 Series

- ❑ Intel® Celeron® M processor 410/420/430 (1 MB L2 cache, 1.46/1.60/1.73 GHz, 533 MHz FSB) or higher
- ❑ Mobile Intel® 940GML Express chipset
- ❑ Acer InViLink™ 802.11b/g Wi-Fi CERTIFIED™ solution, supporting Acer SignalUp™ wireless technology
- ❑ 256/512 MB of DDR2 533 MHz memory, upgradeable to 2 GB using two so DIMM modules (dual-channel support)

Display and graphics

- ❑ 15.4" WXGA color TFT LCD, 1280 x 800 pixel resolution, 16:10 viewing ratio, supporting simultaneous multi-window viewing via Acer GridVista™
- ❑ 15" XGA color TFT LCD, 1024x 768 pixel resolution
- ❑ NVIDIA® GeForce® Go 7600/7600SE with 128/256MB of external GDDR2 VRAM, supporting Microsoft® DirectX® 9.0, Shader Model 3.0, OpenEXR High Dynamic Range (HDR) technology, NVIDIA® PowerMizer. 6.0 and PCI Express® **(for Aspire 5680)**
- ❑ NVIDIA® GeForce® Go 7300 up to 256 MB TurboCache™ (128 MB of dedicated GDDR2 VRAM, 128 MB of shared system memory), supporting Microsoft® DirectX® 9.0, Shader Model 3.0, OpenEXR High Dynamic Range (HDR) technology, NVIDIA® PowerMizer™ 6.0, PCI Express® **(for Aspire 5630 discrete)**
- ❑ Mobile Intel® 945GM Express chipset with integrated 3D graphics, featuring Intel® Graphics Media Accelerator (GMA) 950, up to 224 MB of shared system memory, supporting Microsoft® DirectX® 9.0 and PCI Express® **(for Aspire 5630 UMA)**

- Mobile Intel® 940GML Express chipset with integrated 3D graphics, featuring Intel® Graphics Media Accelerator (GMA) 950, up to 224 MB of shared system memory, supporting Microsoft® DirectX® 9.0 (for **Aspire 3690**)
- Dual independent display
- 16.7 million colors
- MPEG-2/DVD hardware-assisted capability
- S-video/TV-out (NTSC/PAL) support (for selected models)
- DVI-D (true digital video interface) support (for selected models)
- Acer CinemaVision™ technology (Acer Arcade)
- Acer ClearVision™ optimization (Acer Arcade)

Storage subsystem

- 60/80/100/120 GB or higher hard disk drive
- Optical drive options:
 - ▶ DVD-Super Multi double-layer
 - ▶ DVD/CD-RW combo
- 5-in1 card reader, supporting Memory Stick® (MS), Memory Stick PRO™ (MS PRO), MultiMediaCard (MMC), Secure Digital (SD), xD-Picture Card™ (xD) (for selected models)

Input devices

- 88/89-key keyboard with inverted “T” cursor layout; 2.5mm (minimum) key travel (for TravelMate series)
- Touchpad with 4-way scroll button
- 12 function keys, four cursor keys, two Windows® keys, hotkey controls, embedded numeric keypad, international language support
- Four easy-launch buttons: Empowering Key, email, Internet, user-programmable button
- Six/seven media keys: TV, volume up, volume down, play/pause, stop, next, previous (for selected models)
- Three communication LED-buttons: WLAN, 3G, Bluetooth® (for selected models)

Audio

- Audio system with two built-in speakers
- Intel® High-Definition audio support
- Sound Blaster Pro™ and MS Sound compatible
- S/PDIF (Sony/Philips Digital Interface) support for digital speakers (for selected models)
- Built-in microphone

Communication

- Acer Video Conference featuring Voice and Video over Internet Protocol (VVoIP) support via Acer OrbiCam™ and optional Acer Bluetooth® VoIP phone
- Acer OrbiCam™ integrated 1.3 megapixel or 310,000 pixel CMOS camera (for selected models), featuring :
 - ▶ 225 degree ergonomic rotation
 - ▶ Acer VisageON™ technology (for 1.3 megapixel camera models only)
 - ▶ Acer Primalite™ technology

-
- WWAN: UMTS WCDMA (3G) at 2100 MHz and GPRS/EDGE at three bands (900/1800/1900 MHz), upgradeable to HSDPA 1.8 Mbps (for selected models)
 - WLAN:
 - ▶ Intel® PRO/Wireless 3945ABG network connection (dual-band tri-mode 802.11a/b/g) Wi-Fi CERTIFIED™ solution, supporting Acer SignalUp™ wireless technology **(for Aspire 5680/5630 Series)**
 - ▶ Acer InviLink™ 802.11b/g Wi-Fi CERTIFIED™ solution, supporting Acer SignalUp™ wireless technology **(for Aspire 3690 Series)**
 - Modem: 56K ITU V.92 modem with PTT approval; wake-on ring ready
 - LAN: 10/100 Mbps Fast or 10/100/1000 Mbps gigabit Ethernet (for selected models); wake-on-LAN ready
 - WPAN: integrated Bluetooth® 2.0+EDR

Power subsystem

- ACPI 2.0 power management standard: supports Standby and Hibernation power-saving modes
- 71W 4800 mAh Li-ion battery pack (8-cell) or 44W 4000mAh Li-ion battery pack (6-cell)
- 2-hour rapid charge; 2.5-hour charge-in-use
- 3-pin 90 W AC adapter

I/O Ports

- ExpressCard™ /34 slot (for selected models)
- PC Card slot (one Type II)
- 5-in-1 card reader (SD/MMC/MS/MS PRO/xD)
- Four USB 2.0 ports
- DVI-D port (for selected models)
- IEEE 1394 port (for selected models)
- Consumer infrared (CIR) port (for selected models)
- Fast infrared (FIR) port (for selected models)
- External display (VGA) port
- AV-in port (for selected models)
- S-video/TV-out (NTSC/PAL) port (for selected models)
- S-video-in (NTSC/PAL) port (for selected models)
- Headphones/speaker/line-out jack with S/PDIF support (for selected models)
- Microphone jack
- Line-in jack
- Ethernet (RJ-45) port
- Modem (RJ-11) port
- DC-in jack for AC adaptor

Environment

- Temperature:
 - ▶operating: 5° C to 35° C
 - ▶Non-operating: -20° C to 65° C
- Humidity (non-condensing):
 - ▶operating: 20%~80%
 - ▶Non-operating: 20%~80%

System Block Diagram

This is for UMA models

This is for discrete models

Board Layout

Top View

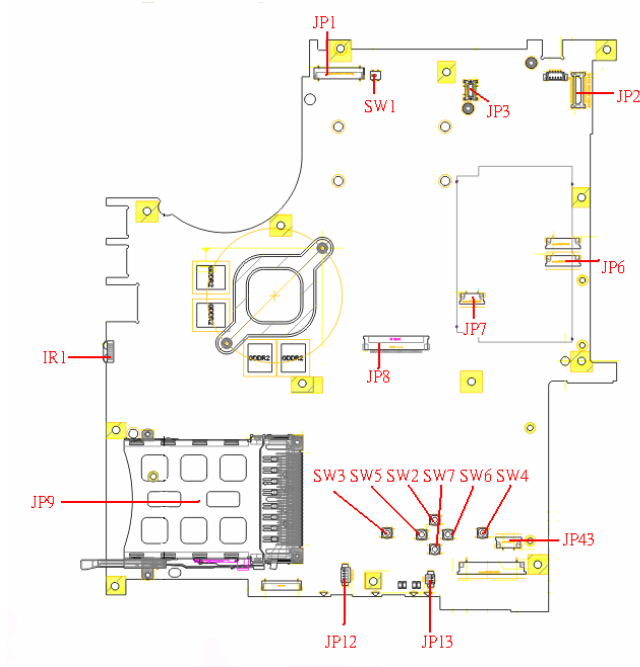

1	JP1	LCD Connector	10	SW7	Touchpad Down Button
2	SW1	Lid Switch	11	SW2	Touchpad Up Button
3	JP3	MDC Connector	12	SW5	Touchpad Left Button
4	JP2	Power Button Connector	13	SW3	Touchpad Left Button
5	JP6	Media Board Connector	14	JP13	Internal Microphone Connector
6	JP7	Touchpad Board Connector	15	JP12	Internal Speaker Connector
7	JP43	SIM Card Connector	16	JP9	PCMCIA Socket
8	SW4	Touchpad Right Button	17	IR1	FIR Module
9	SW6	Touchpad Left Button	18	JP8	Internal Keyboard Connector

Bottom View

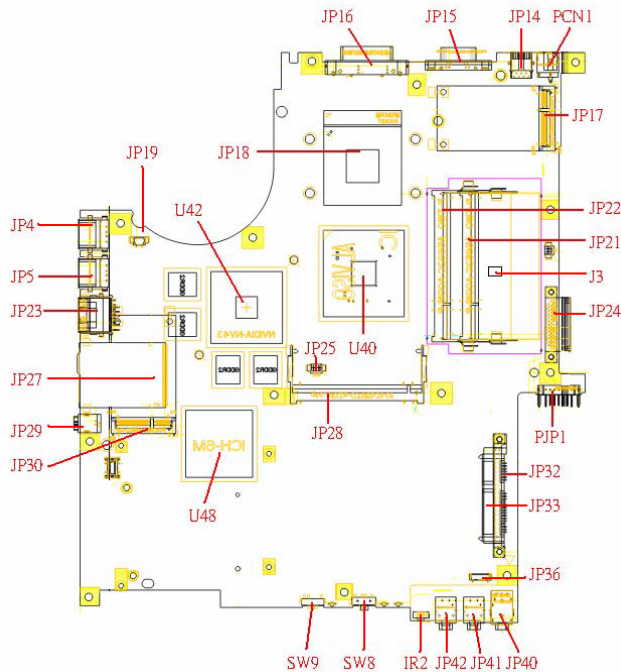

NOTE: This is engineering sample. The image above may not be exactly the same as the real main board you get.

1	JP19	FAN Connector	17	JP40	Headphone/SPDIF Jack
2	U42	VGA Chipset	18	JP41	Line-In Jack
3	JP18	CPU Socket	19	JP42	Microphone-in Jack
4	JP16	DVI Connector	20	IR2	CIR Module
5	JP15	CRT Connector	21	SW8	Wireless LAN Switch
6	JP14	TV-Out Connector	22	SW9	Bluetooth and 3G Switch
7	PCN1	DC-IN Jack	23	U48	South Bridge Chipset
8	JP17	Mini Card Connector	24	JP30	Mini Card Connector
9	JP22	DDRII so-DIMM Socket	25	JP29	IEEE 1394 Connector
10	JP21	DDRII so-DIMM Socket	26	JP27	5 IN1 Socket
11	J3	Clear CMOS Jumper	27	JP23	RJ45 Connector
12	JP24	ODD Connector	28	JP5	USB Connector
13	PJP1	Battery Connector	29	JP4	USB Connector
14	JP32	HDD Connector (SATA)	30	JP28	MINIPCI Connector (TV-Tuner)
15	JP33	HDD Connector (PATA)	31	JP25	FAN Connector
16	JP36	Bluetooth Connector	32	U40	North Bridge Chipset

Jumper Board Layout

Switch Board Top View

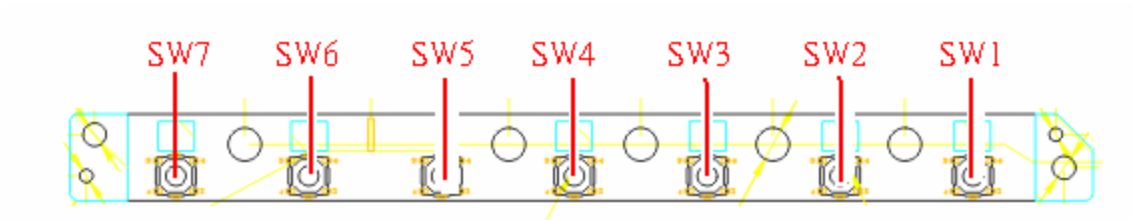

Label	Description
SW1	Arcade/TV tuner switch
SW2	Volume Up switch
SW3	Volume Down switch
SW4	Play/Pause switch
SW5	Stop switch
SW6	Forward/Next switch
SW7	Backward/Previous switch

Media Board Top View

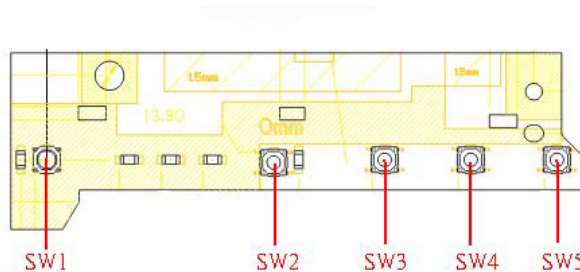

Label	Description
SW1	Power Button
SW2	E-mail Button
SW3	Internet Button
SW4	User Button
SW5	E-Power Button

Media Board Bottom View

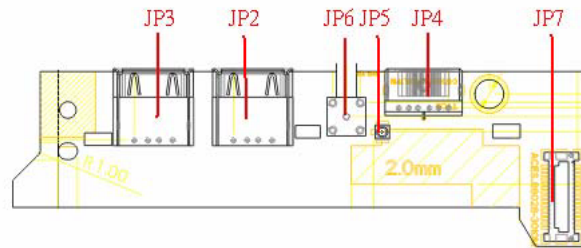

Label	Description
JP3	USB Connector
JP2	USB Connector
JP6	RF INe Connector
JP5	RF Cable Connector
JP4	AV IN Connector
JP7	Board to Main Board Connector

LS-2923P Power Board Top View

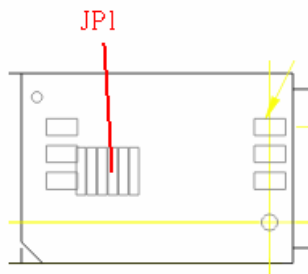

Label	Description
JP1	SIM Card Connector

Jumper Setting

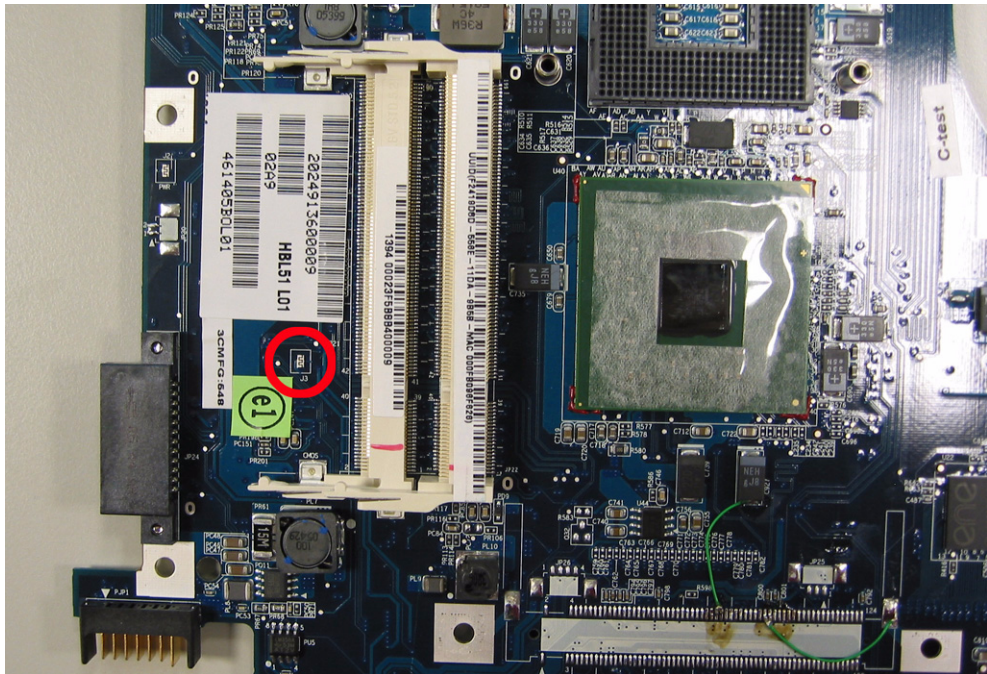

Label	Description
J3	Clear CMOS Jumper Note: J3 locates at bottom side of the main board as the red circle highlighted.

Your Acer Notebook tour

After knowing your computer features, let us show you around your new TravelMate computer.

Front view

Aspire series:

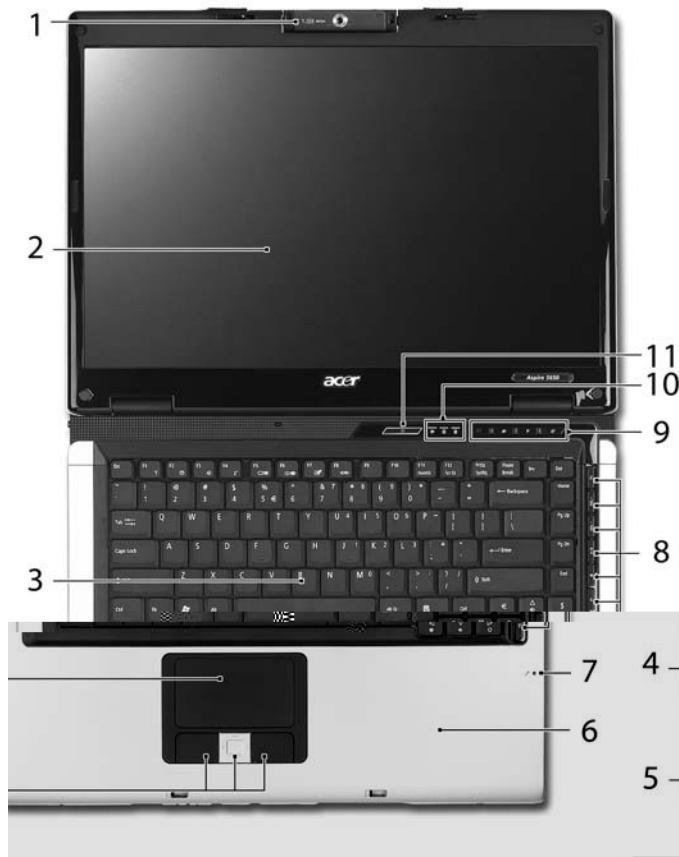

#	Item	Description
1	Built-in camera	1.3 megapixel or 310,000 pixel web camera for video communication (for selected models)
2	Display screen	Also called LCD (liquid-crystal display), displays computer output.
3	Keyboard	For entering data into your computer.
4	Touchpad	Touch-sensitive pointing device which functions like a computer mouse.
5	Click buttons (left, center and right)	The left and right buttons function like the left and right mouse buttons; the center button serves as a 4-way scroll button.
6	Palmrest	Comfortable support area for our hands when you use the computer.
7	Microphone	Internal microphone for sound recording.
8	TV/media/volume buttons	For use with Acer Arcade and other media playing programs.

9	Easy-launch buttons	Buttons for launching frequently used programs.
10	Status indicators	Light-Emitting Diodes (LEDs) that light up to show the status of the computer's functions and components.
11	Power button	Turns the computer on and off.

TravelMate series:

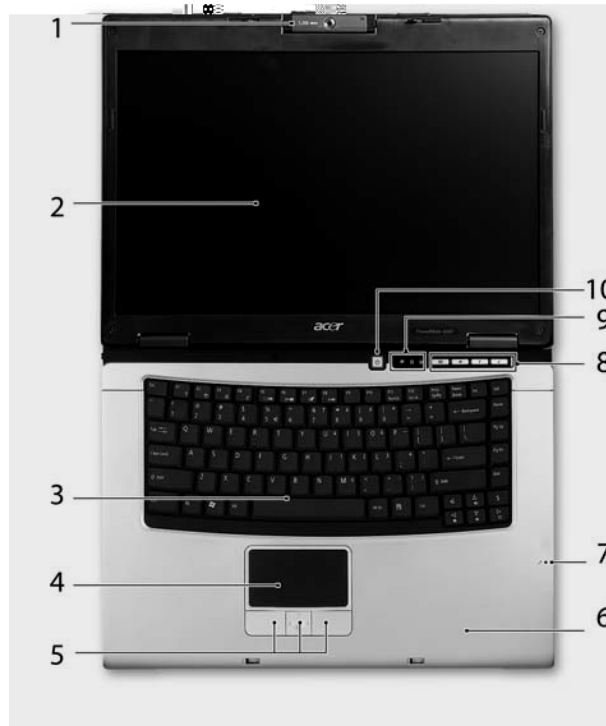







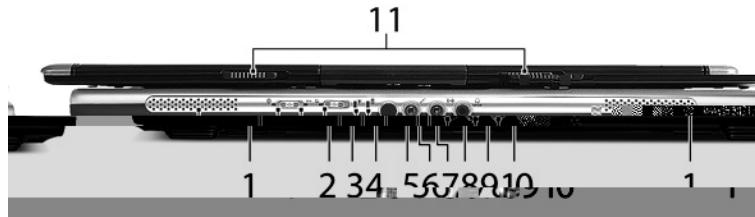

#	Item	Description
1	Built-in camera	1.3 megapixel or 310,000 pixel web camera for video communication (for selected models).
2	Display screen	Also called LCD (liquid-crystal display), displays computer output.
3	Keyboard	For entering data into your computer.
4	Touchpad	Touch-sensitive pointing device which functions like a computer mouse.
5	Click buttons (left, center and right)	The left and right buttons function like the left and right mouse buttons; the center button serves as a 4-way scroll button.
6	Palmrest	Comfortable support area for our hands when you use the computer.
7	Microphone	Internal microphone for sound recording.
8	Easy-launch Buttons	Buttons for launching frequently used programs.
9	Status indicators	Light-Emitting Diodes (LEDs) that light up to show the status of the computer's functions and components.
10	Power button	Turns the computer on and off.

Closed Front View







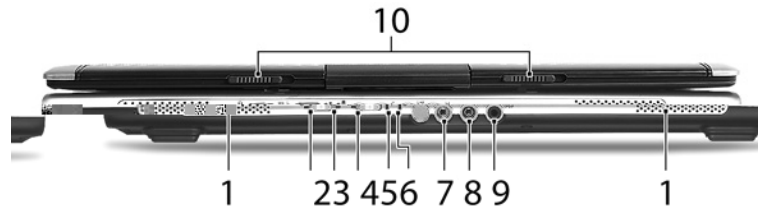

Aspire series:



#	Icon	Item	Description
1		Speaker	Left and right speakers deliver stereo audio output.
2		Bluetooth® communication button/indicator	Enable/disable Bluetooth function. Indicates the status of Bluetooth-communications.
3		3G switch/indicator	Enables/disables the Bluetooth function. Indicates the status of Bluetooth communication.
4		Wireless communication button/indicator	Enable/disable Wireless function. Indicates the status of wireless LAN communications.
5		Power indicator	Indicates the computer's power status.
6		Battery indicator	Indicates the computer's battery status.
7		CIR receiver	Receives signals from a remote control.
8		Microphone-in jack	Accepts input from external microphones.
9		Line-in jack	Accepts audio line-in devices (e.g., audio CD player, stereo walkman).
10		Headphones/speakers/line-out jack with S/PDIF support	Connects to audio line-out devices (e.g., speakers, headphones).
11		Latch	Locks and release the lid.

TravelMate series:









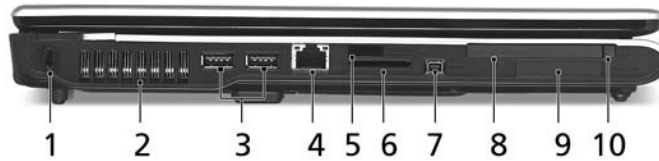

#	Icon	Item	Description
1		Speaker	Left and right speakers deliver stereo audio output.
2		Bluetooth [®] communication button/indicator	Enable/disable Bluetooth function. Indicates the status of Bluetooth-communications.
3		3G switch/indicator	Enables/disables the Bluetooth function. Indicates the status of Bluetooth communication.
4		Wireless communication button/indicator	Enable/disable Wireless function. Indicates the status of wireless LAN communications.
5		Power indicator	Indicates the computer's power status.
6		Battery indicator	Indicates the computer's battery status.
7		Microphone-in jack	Accepts input from external microphones.
8		Line-in jack	Accepts audio line-in devices (e.g., audio CD player, stereo walkman).
9		Headphones/speakers/line-out jack with S/PDIF support	Connects to audio line-out devices (e.g., speakers, headphones).
10		Latch	Locks and release the lid.

Left View

Aspire Series/TravelMate Series:



#	Icon	Item	Description
1		Kensington lock slot	Connects to a Kensington-compatible computer security lock.
2		Ventilation slots	Enables the computer to stay cool, even after prolonged use.
3		Two USB 2.0 ports	Connects to USB 2.0 devices (e.g., USB mouse, USB camera).
4		Ethernet (RJ-45) port	Connects to an Ethernet 10/100- or 10/100/1000 based network (for selected models).
5		Infrared port	Interfaces with infrared devices (e.g., infrared printer and IR-aware computer) (for selected models).
6		5-in-1 card reader	Accepts Memory Stick (MS), Memory Stick PRO (MS PRO), MultiMediaCard (MMC), Secure Digital (SD), xD-Picture Card (xD) (for selected models).
7		4-pin IEEE 1394 port	Connects to IEEE 1394 devices (for selected models).
8		PC Card slot	Accepts one Type II PC Card.
9		ExpressCard/34 slot	Accepts one ExpressCard/34 module (for selected models).
10		PC Card slot eject button	Ejects the PC Card from the slot.

R

Aspire





#	Icon	Item	Description
---	------	------	-------------

TravelMate

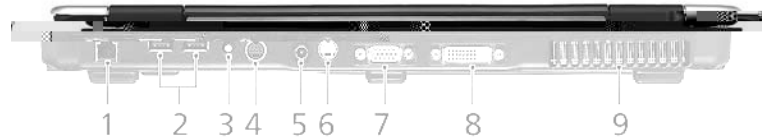
Rear Panel





Aspire Series:

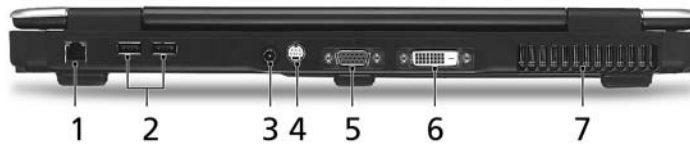

#	Icon	Item	Description
1		Modem (RJ-11) port	Connects to a phone line.
2		Two USB 2.0 ports	Connect to USB 2.0 devices (e.g., USB mouse, USB camera).
3	RF	S-video-in (NTSC/PAL) port	Connects to an S-video device like a DVD player or camcorder (for selected models).
4	AV-IN	AV-in port	Accepts input signals from audio/video (AV) devices (for selected models).
5		DC-in jack	Connect to an AC adapter.
6		S-video/TV-out (NTSC/PAL) port	Connects to a television or display device with S-video input (for selected models).
7		External display (VGA) port	Connects to a display device (e.g., external monitor, LCD projector).
8		DVI-D port	Supports digital video connections (for selected models).
9		Ventilation slots	Enable the computer to stay cool, even after prolonged use.

TravelMate Series:



#	Icon	Item	Description
1		Modem (RJ-11) port	Connects to a phone line.
2		Two USB 2.0 ports	Connect to USB 2.0 devices (e.g., USB mouse, USB camera).
3		DC-in jack	Connect to an AC adapter.
4		S-video/TV-out (NTSC/PAL) port	Connects to a television or display device with S-video input (for selected models).
5		External display (VGA) port	Connects to a display device (e.g., external monitor, LCD projector).
6	DVI-D	DVI-D port	Supports digital video connections (for selected models).
7		Ventilation slots	Enable the computer to stay cool, even after prolonged use.

Base view

Aspire Series/TravelMate Series:

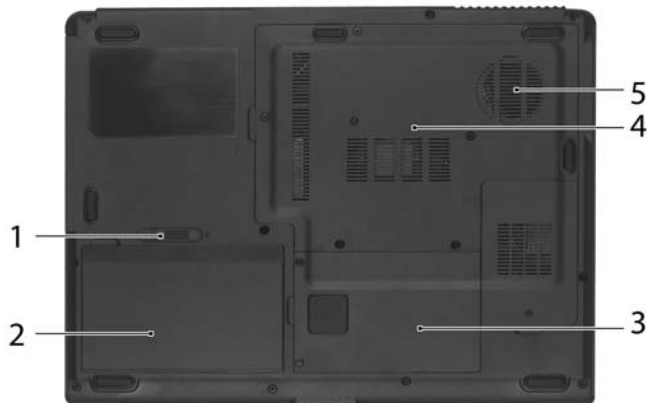

#	Item	Description
1	Battery lock	Locks the battery in position.
2	Battery bay	Helps keep the computer cool. Note: Do not cover or obstruct the opening of the fan.
3	Hard disk bay	Houses the computer's hard disk (secured with screws)
4	Acer DASP (Disk Anti-Shock Protection)	Protects the hard disk drive from shocks and bumps. (for TravelMate 4200)
5	Memory compartment	Houses the computer's main memory.
6	Ventilation slots and cooling fan	Release the battery for removal.

Indicators

The computer has four easy-to-read status indicators on the upper-right above the keyboard, and four on the front panel.







Aspire Series:



TravelMate Series:



The power, battery and wireless communication status indicators are visible even when the LCD display is closed.

Icon	Function	Description
	Cap lock	Lights when Cap Lock is activated
	Num lock	Lights when Num Lock is activated.
	HDD	Indicates when the hard disc or optical drive is active.
	Bluetooth	Indicates the status of Bluetooth communication.
	Wireless LAN	Indicates the status of wireless LAN communication.
	Battery	Lights up when the battery is being charged.
	Power	Lights up when the computer is on.

NOTE: 1. **Charging:** The light shows amber when the battery is charging. 2. **Fully charged:** The light shows green when in AC mode.

Easy-Launch Buttons

Located above the keyboard are four buttons. These buttons are called easy-launch buttons. They are: mail Web browser, Empowering Key “e” and one user-programmable button.

Press “e” to run the Acer Empowering Technology. The mail and Web browser buttons are pre-set to email and Internet programs, but can be reset by users. To set the Web browser, mail and programmable buttons, run the Acer Launch Manager.

Aspire Series



TravelMate Series



Launch key	Default application
P	User-programmable
P	User-programmable
e	Acer Empowering Technology (user-programmable)
Web browser	Internet browser (user-programmable)
Mail	Email application (user-programmable)

Using the Keyboard

The keyboard has full-sized keys and an embedded keypad, separate cursor keys, two Windows keys and twelve function keys.

Lock Keys and embedded numeric keypad

The keyboard has three lock keys which you can toggle on and off.

Aspire Series:



TravelMate Series:



Lock Key	Description
Caps Lock	When Caps Lock is on, all alphabetic characters typed are in uppercase.
Num lock <Fn>+<F11>	When Num Lock is on, the embedded keypad is in numeric mode. The keys function as a calculator (complete with the arithmetic operators +, -, *, and /). Use this mode when you need to do a lot of numeric data entry. A better solution would be to connect an external keypad.
Scroll lock <Fn>+<F12>	When Scroll Lock is on, the screen moves one line up or down when you press the up or down arrow keys respectively. Scroll Lock does not work with some applications.









The embedded numeric keypad functions like a desktop numeric keypad. It is indicated by small characters located on the upper right corner of the keycaps. To simplify the keyboard legend, cursor-control key symbols are not printed on the keys.

Desired Access	Num Lock On	Num Lock Off
Number keys on embedded keypad	Type numbers in a normal manner.	
Cursor-control keys on embedded keypad	Hold <Shift> while using cursor-control keys.	Hold <Fn> while using cursor-control keys.

Desired Access	Num Lock On	Num Lock Off
Main keyboard keys	Hold <Fn> while typing letters on embedded keypad.	Type the letters in a normal manner.

Windows Keys

The keyboard has two keys that perform Windows-specific functions.

Key	Icon	Description
Windows key		<p>Pressed alone, this key has the same effect as clicking on the Windows Start button; it launches the Start menu. It can also be used with other keys to provide a variety of function:</p> <ul style="list-style-type: none">  + <Tab> Activates next taskbar button.  + <E> Opens the My Computer window  + <F1> Opens Help and Support.  + <F> Opens the Find: All Files dialog box.  + <R> Opens the Run dialog box.  + M Minimizes all windows. <p><Shift>+  + <M> Undoes the minimize all windows action.</p>
 Application key		This key has the same effect as clicking the right mouse button; it opens the application's context menu.

Hot Keys

The computer employs hotkeys or key combinations to access most of the computer's controls like screen brightness, volume output and the BIOS utility.

To activate hot keys, press and hold the <Fn> key before pressing the other key in the hotkey combination.



Aspire Series:



TravelMate Series:



Hot Key	Icon	Function	Description
Fn-F1	?	Hot key help	Displays help on hot keys.
Fn-F2		Acer eSetting	Launches the Acer eSettings in Acer eManager.
Fn-F3		Acer ePowerManagement	Launches the Acer ePowerManagement in Acer eManager.
Fn-F4	Z ^Z	Sleep	Puts the computer in Sleep mode.
Fn-F5		Display toggle	Switches display output between the display screen, external monitor (if connected) and both.
Fn-F6		Screen blank	Turns the display screen backlight off to save power. Press any key to return.
Fn-F7		Touchpad toggle	Turns the internal touchpad on and off.
Fn-F8		Speaker toggle	Turns the speakers on and off.
Fn-↑		Volume up	Increases the speaker volume.
Fn-↓		Volume down	Decreases the speaker volume.

Hot Key	Icon	Function	Description
Fn-☀		Brightness up	Increases the screen brightness.
Fn-☀		Brightness down	Decreases the screen brightness

Special Key

You can locate the Euro symbol and US dollar sign at the upper-center and/or bottom-right of your keyboard. To type:

Aspire Series:



TravelMate Series:



The Euro symbol

1. Open a text editor or word processor.
2. Either directly press the **<Euro>** symbol at the bottom-right of the keyboard, or hold **<Alt Gr>** and then press the **<5>** symbol at the upper-center of the keyboard.

The US dollar sign

1. Open a text editor or word processor.
2. Either directly press the **<Dollar>** key at the bottom-right of the keyboard, or hold **<Shift>** and then press the **<4>** key at the upper-center of the keyboard.

NOTE: This function varies by the operating system version.

NOTE: Some fonts and software do not support the Euro symbol. Please refer to www.microsoft.com/typography/faq/faq12.htm for more information.

Acer Empowering Technology

Acer's innovative Empowering Technology makes it easy for you to access frequently used functions and manage your new Acer notebook. It features the following handy utilities:

- Acer eDataSecurity Management** protects data with passwords and advanced encryption algorithms.
- Acer eLock Management** limits access to external storage media.
- Acer ePerformance Management** improves system performance by optimizing disk space, memory and registry settings.
- Acer eRecovery Management** backs up/recovers data flexibly, reliably and completely.
- Acer eSettings Management** accesses system information and adjusts settings easily.
- Acer eNet Management** hooks up to location-based networks intelligently.
- Acer ePower Management** extends battery power via versatile usage profiles.
- Acer ePresentation Management** connects to a projector and adjusts display settings conveniently.



For more information, press the < *e* > key to launch the Empowering Technology menu, then click on the appropriate utility and select the Help function.

Acer eDataSecurity Management

Acer eDataSecurity Management is handy file encryption utility that protects your files from being accessed by unauthorized persons. It is conveniently integrated with Windows explorer as a shell extension for quick and easy data encryption/decryption and also supports on-the-fly file encryption for MSN Messenger and Microsoft Outlook.

There are two passwords that can be used to encrypt/decrypt a file; the supervisor password and the file-specific password. The supervisor password is a "master" password that can decrypt any file on your system; the file-specific password will be used to encrypt files by default, or you can choose to enter your own file-specific password when encrypting a file.

NOTE: The password used to encrypt a file is the unique key that the system needs to decrypt it. If you lose the password, the supervisor password is the only other key capable of decrypting the file. If you lose both passwords, there will be no way to decrypt your encrypted file! **Be sure to safeguard all related passwords!**



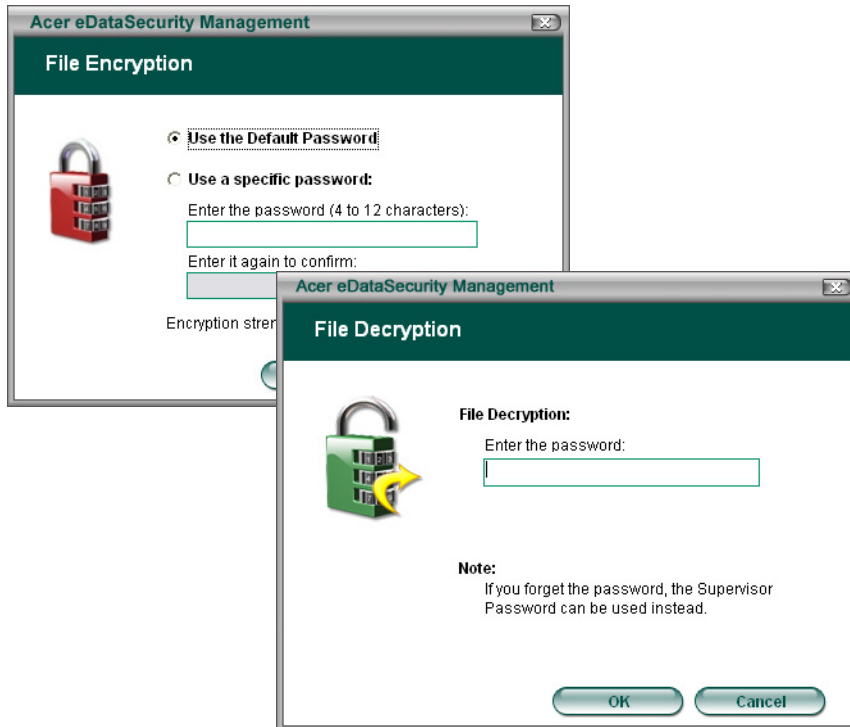

Acer eLock Management

Acer eLock Management is a security utility that allows you to lock up your removable data, optical and floppy drives to ensure that data can't be stolen while your notebook is unattended.

- Removable data devices - includes USB disk drives, USB pen drives, USB flash drives, USB MP3 drives, USB memory card readers, IEEE 1394 disk drives and any other removable disk drives that can be mounted as a file system when plugged into the system.
- Optical drive devices - includes any kind of CD-ROM or DVD-ROM drives.
- Floppy disk drives - 3.5-inch disks only.

To activate Acer eLock Management, a password must be set first. Once set, you may apply lock to any of the three kinds of devices. Lock(s) will immediately be set without any reboot necessary, and will remain locked after rebooting, until unlocked.

If you do not set a password, Acer eLock Management will reset back to the initial status with all locks removed.

NOTE: If you lose your password, there is no method to reset it except by reformatting your notebook or taking your notebook to an Acer Customer Service Center. Be sure to remember or write down your password.

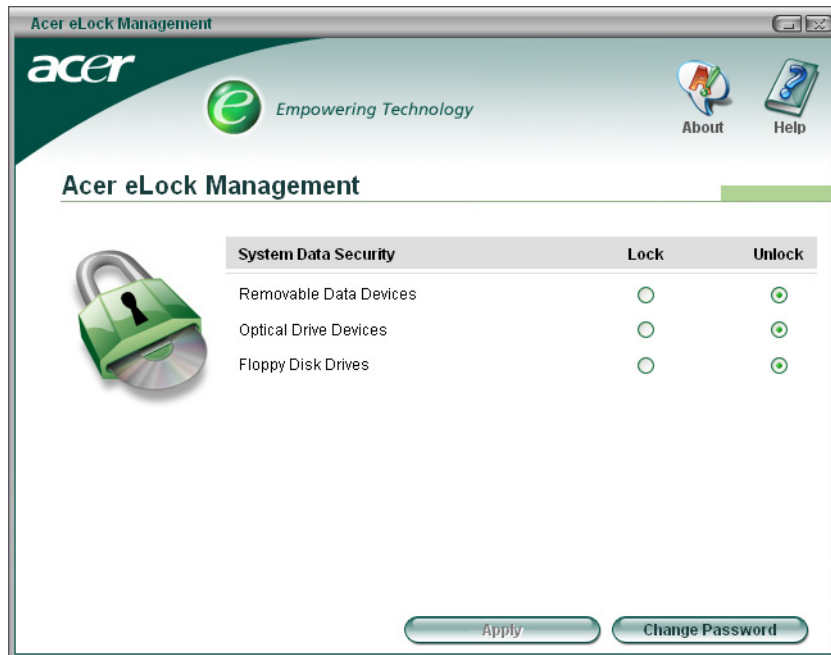

Acer ePerformance Management

Acer ePerformance Management is a system optimization tool that boosts the performance of your Acer notebook. It provides you with the following options to enhance overall system performance:

- Memory optimization - releases unused memory and check usage.
- Disk optimization - removes unneeded items and files.
- Speed optimization - improves the usability and performance of your Windows XP system.



Acer eRecovery Management

Acer eRecovery Management is a powerful utility that does away with the need for recovery disks provided by the manufacturer. The Acer eRecovery Management utility occupies space in a hidden partition on your system's HDD. User-created backups are stored on D:\ drive. Acer eRecovery Management provides you with:

- Password protection.
- Recovery of applications and drivers.
- Image/data backup:
 - Back up to HDD (set recovery point).
 - Back up to CD/DVD.
- Image/data recovery tools:
 - Recover from a hidden partition (factory defaults).
 - Recover from the HDD (most recent user-defined recovery point).
 - Recover from CD/DVD.

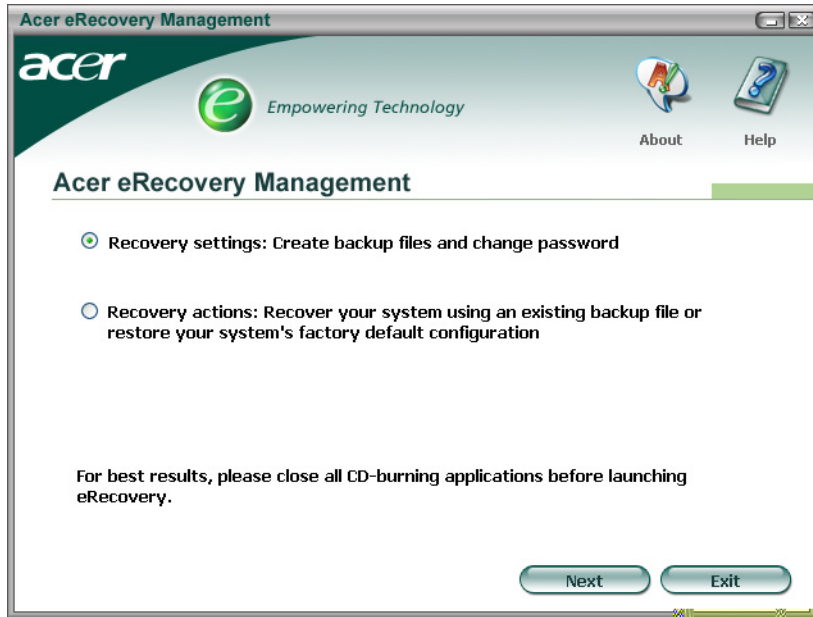

NOTE: If your computer did not come with a Recovery CD or System CD, please use Acer eRecovery Management's "System backup to optical disk" feature to burn a backup image to CD or DVD. To ensure the best results when recovering your system using a CD or Acer eRecovery Management, detach all peripherals (except the external Acer ODD, if your computer has one), including your Acer ezDock.

Acer eSettings Management

Acer eSettings Management allows you to inspect hardware specifications and to monitor the system health status. Furthermore, Acer eSettings Management enables you to optimize your Windows operating system, so your computer runs faster, smoother and better.

Acer eSettings Management also:

- Provides a simple graphical user interface for navigating through the program effortlessly.
- Displays general system status and advanced monitoring for power users.
- Logs when a hardware component has been removed or replaced.
- Permits you to migrate personal settings.
- Keeps a history log of all alerts that were previously issued.



Acer eNet Management

Acer eNet Management helps you to quickly and easily connect to both wired and wireless networks in a variety of locations. To access this utility, either click on the “Acer eNet Management” icon on your notebook, or start the program from the Start menu. You also have the option to set Acer eNet Management to start automatically when you boot up your PC.

Acer eNet Management automatically detects the best settings for a new location, while offering you the freedom to manually adjust the settings to match your needs, simply by right-clicking on the icon in the taskbar.



Acer eNet Management can save network settings for a location to a profile, and automatically apply the appropriate profile when you move from one location to another. Settings stored include network connection settings(IP and DNS settings, wireless AP details, etc.), as well as default printer settings. Security and safety concerns mean that Acer eNet Management does not store username and password information.

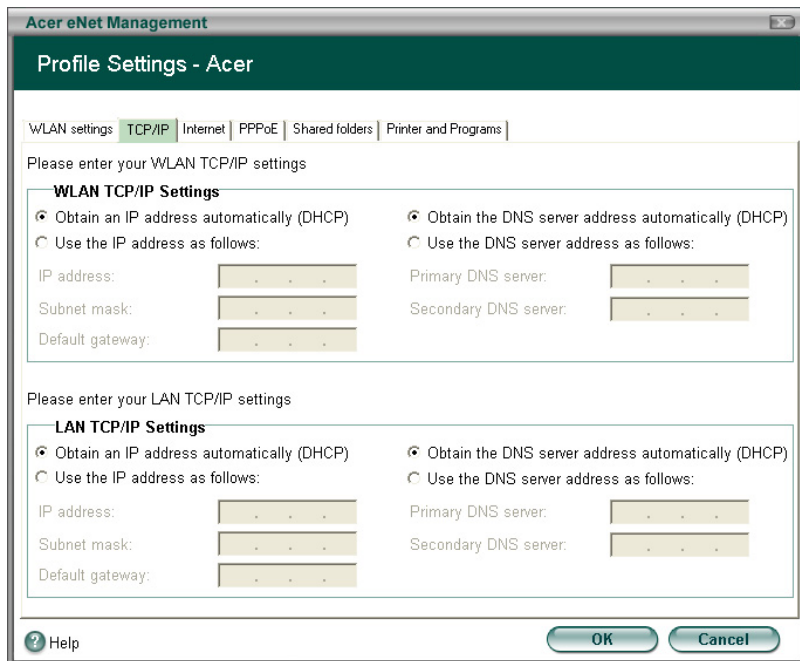

Acer ePower Management

Acer ePower Management features a straightforward user interface. To launch it, select Acer ePower Management from the Empowering Technology interface, or double-click the Acer ePower Management icon in the task tray.

Acer Mode

The default setting is “Maximum Performance.” You can adjust CPU speed, LCD brightness and other settings, or click on buttons to turn the following functions on/off: Wireless LAN, Bluetooth, CardBus, Memory Card, Audio, and Wired LAN.

DC Mode

To suit your usage, there are four pre-defined profiles - Entertainment, Presentation, Word Processing, and Maximum Battery. Or, you can define up to three of your own profiles.

Create new power scheme

1. Assign a name for the new scheme.
2. Choose existing scheme to use as a template.
3. Select whether used for mains (AC) or battery mode.
4. Choose which power options best fit your needs, then click OK.
5. The new profile will appear on the main screen.

Battery status

For real-time battery life estimates based on current usage, refer to the panel on the lower left-hand side of the window.

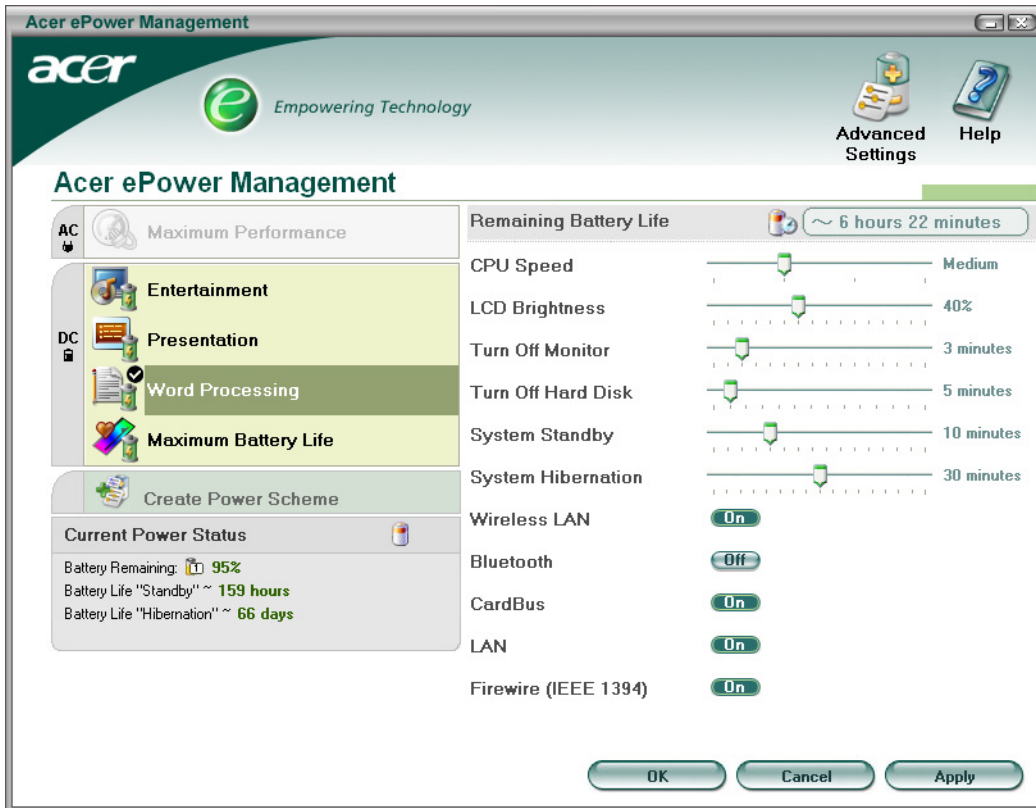

You can also click "Advanced Settings" to:

- Set alarms.
- Re-load factory defaults.
- Select what actions will be taken when the cover is closed, and set passwords for accessing the system after Hibernation or Standby.
- View information about Acer ePower Management.

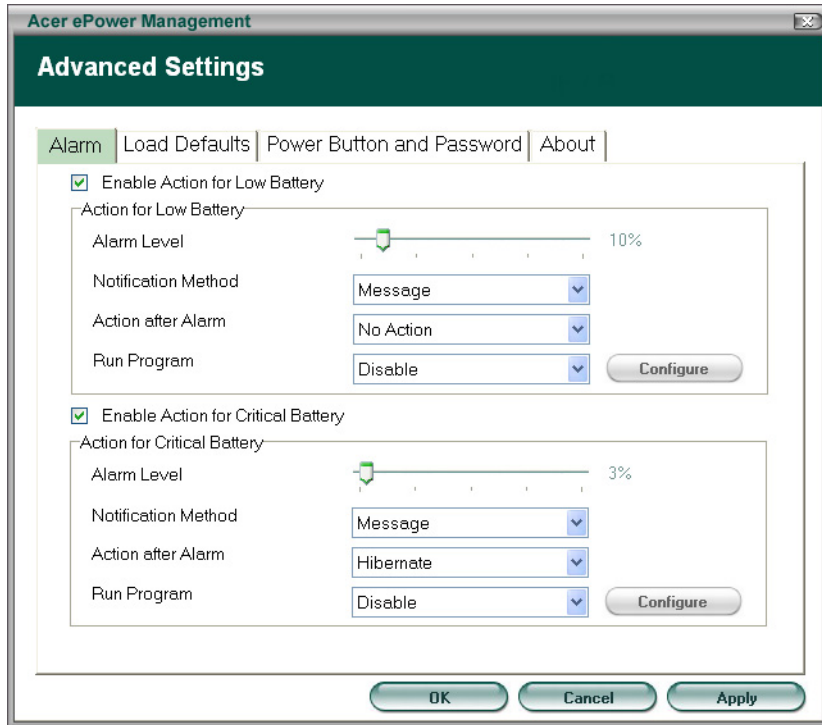

Acer ePresentation Management

Acer ePresentation Management lets you select from two of the most common projector resolutions: XGA and SVGA.

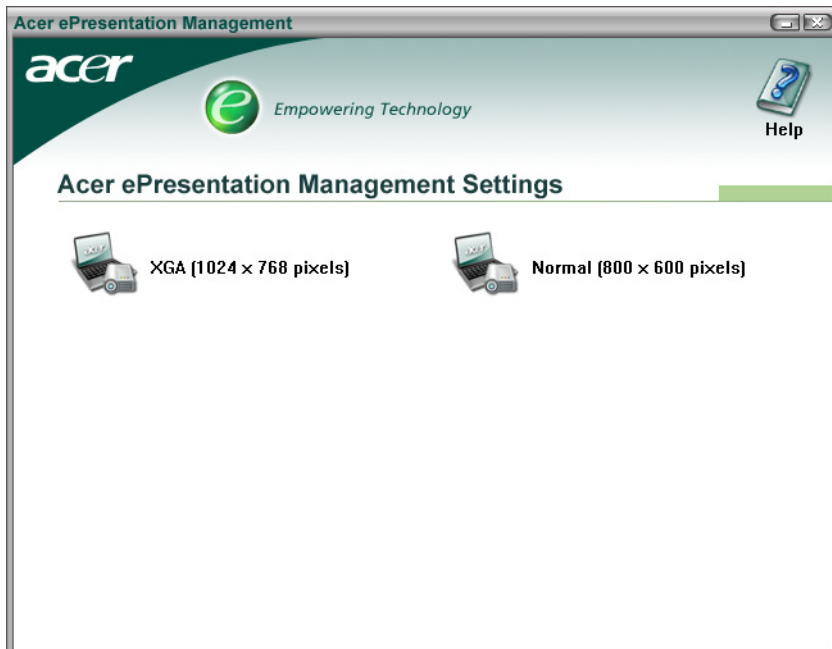

Hardware Specifications and Configurations

Processor

Item	Specification
CPU type	<p>For Aspire 5680/5630 TravelMate 4280/4230</p> <p>Intel® Core™ 2 Duo processor T7200/7400/7600 (4 MB L2 cache, 2.0/2.16/2.33 GHz, 667 MHz FSB) and T5500/5600 (2MB L2 cache, 1.66/1.83 GHz, 667 MHz FSB), supporting Intel® EM64T</p> <p>For Aspire 3690/TravelMate 2490</p> <p>Intel® Celeron® M processor 410/420/430 (1 MB L2 cache, 1.46/1.60/1.73 GHz, 533 MHz FSB) or higher</p>
Core logic	<p>For Aspire 5680/5630 TravelMate 4280/4230</p> <p>Intel® 945GM/945PM+ICH7-M</p> <p>For Aspire 3690/TravelMate 2490</p> <p>Mobile Intel® 940GML Express chipset</p>
CPU package	<p>4MB L2 cache 478-pin micro-FCPGA</p> <p>2MB L2 cache 479-ball micro-FCBGA</p>
CPU core voltage	N/A

BIOS

Item	Specification
BIOS vendor	Phneiox
BIOS Version	
BIOS ROM type	512K Flash ROM
BIOS ROM size	1MB Flash BIOS
BIOS package	32-pin PLCC
Supported protocols	ACPI 1.0b/2.0/3.0, PCI2.2, System/HDD Password Security Control, INT 13h Extensions, PnP 1.0a, SMBIOS 2.4, BIOS Boot Specification (Compaq, Phoenix, Intel), Simple Boot Flag 1.0, Boot Block, PCI Bus Power Management Interface Specification, USB 1.1/2.0, PC Card 95, IrDA 1.0, Intel AC97 CNR Specification, WfM 2.0, PXE 2.1, Boot Integrity Service Application Program Interface (BIS) 1.0, PC99a and Mobile PC2001 Compliant, Intel (R) SpeedStep Technology, Legacy 1394 Device support, DMI 2.0, PS/2 keyboard and mouse
BIOS password control	Set by setup manual

Second Level Cache

Item	Specification
Cache controller	Built-in CPU
Cache size	<p>4MB for Intel® Core™ 2 Duo processor T7200/7400/7600 Processor</p> <p>2MB for Intel® Core™ 2 Duo processor T5500/5600 Processor</p> <p>2MB for Intel® Celeron® M processor 410/420/430</p>
1st level cache control	Always enabled
2st level cache control	Always enabled
Cache scheme control	Fixed in write-back

System Memory

Item	Specification
Memory controller	Built-in Intel® 945GM/945PM (for Aspire 5680/5630; TravelMate 4280/4230) Built-in Intel® 940GML (for Aspire 3690/TravelMate 2490)
Memory size	0MB (no on-board memory)
DIMM socket number	2 sockets
Supports memory size per socket	2048MB (Aspire 5680/5630; TravelMate 4280/4230) 1024MB (Aspire 3690/TravelMate 2490)
Supports maximum memory size	4G (by two 2048MB SO-DIMM modules) 2G (by two 1024MB SO-DIMM modules)
Supports DIMM type	DDR 2 Synchronous DRAM
Supports DIMM Speed	400 MHz
Supports DIMM voltage	1.8V
Supports DIMM package	200-pin soDIMM
Memory module combinations	You can install memory modules in any combinations as long as they match the above specifications.

Memory Combinations

Slot 1	Slot 2	Total Memory
0MB	128MB	128MB
0MB	256MB	256MB
0MB	512MB	512MB
0MB	1024MB	1024MB
128MB	128MB	256MB
128MB	256MB	384MB
128MB	512MB	640MB
128MB	1024MB	1152MB
256MB	128MB	384MB
256MB	256MB	512MB
256MB	512MB	768MB
256MB	1024MB	1280MB
512MB	128MB	640MB
512MB	256MB	768MB
512MB	512MB	1024MB
512MB	1024MB	1536MB
1024MB	0MB	1024MB
1024MB	128MB	1152MB
1024MB	256MB	1280MB
1024MB	512MB	1536MB
1024MB	1024MB	2048MB

NOTE: Above table lists some system memory configurations. You may combine DIMMs with various capacities to form other combinations. On above table, the configuration of slot 1 and slot 2 can be reversed.

LAN Interface

Item	Specification
Chipset	BroadCom BCM4401E

LAN Interface

Item	Specification
Supports LAN protocol	10/100Mbps
LAN connector type	RJ45
LAN connector location	Right side
Features	Integrated 10/100 BASE-T transceiver Wake on LAN support compliant with ACPI 2.0 PCI v2.2

Modem Interface

Item	Specification
Data modem data baud rate (bps)	56K
Supports modem protocol	V.90/V.92
Modem connector type	RJ11
Modem connector location	Right side

Bluetooth Interface

Item	Specification
Chipset	Built-in Intel® ICH7-M
Data throughput	723 bps (full speed data rate)
Protocol	Bluetooth 2.0
Interface	USB 1.1
Connector type	Mini-USB

Wireless Module 802.11b/g (optional device)

Item	Specification
Chipset	Built-in ICH7-M
Data throughput	11~54 Mbps
Protocol	802.11b+g
Interface	Mini-PCI type II (What does PCI Bus means on the system block diagram?)

Hard Disk Drive Interface

Item			
Vendor & Model Name	Seagate 40G ST9402112A Toshiba MK4025GAS Hitachi HTS421240H9AT00 WD WD400UE-22HCT0 Samsung M40MP0402H	Seagate ST96812A Seagate ST960821A Toshiba MK6025GAS HGST HTS541260H9AT00 WD WD600UE-22HCT0	TOSHIBA MK8025GAS HITACHI HTS421280H9AT00 SEAGATE ST9808210A SEAGATE ST98823A TOSHIBA MK8026GAX HGST HTS541280H9AT00 WD WD800UE-22HCT0
Capacity (MB)	40000	60000	80000
Bytes per sector	512	512	512
Data heads	2	3 (for Hitachi and Seagate) 4 (for Toshiba)	4 (for Hitachi) 3 (for Seagate)
Drive Format			
Disks	1	2	2

Hard Disk Drive Interface

Item			
Spindle speed (RPM)	4200 RPM	4200 RPM	4200 RPM
Performance Specifications			
Buffer size	2048KB	8192KB	8192KB
Interface	ATA/ATAPI-6; ATA-6	ATA/ATAPI-6; ATA-6	ATA/ATA-6; ATA-6
Max. media transfer rate (disk-buffer, Mbytes/s)	372	350	350
Data transfer rate (host-buffer, Mbytes/s)	100 MB/Sec. Ultra DMA mode-5	100 MB/Sec. Ultra DMA mode-5	100 MB/Sec. Ultra DMA mode-5
DC Power Requirements			
Voltage tolerance	5V(DC) +/- 5%	5V(DC) +/- 5%	5V(DC) +/- 5%

Combo Drive Interface

Item	Specification	
Vendor & model name	DVD/CDRW HLDS GCC-4244N	
Performance Specification	With CD Diskette	With DVD Diskette
Transfer rate (KB/sec)	Sustained: Max 3.6Mbytes/sec	Sustained: Max 10.8Mbytes/sec
Buffer Memory	2MB	
Interface	Enhanced IDE(ATAPI) compatible	
Applicable disc format	DVD: DVD-ROM, (DVD-5, DVD-9, DVD-10, DVD-18),DVD-R (read, single border), DVD-RW, DVD-RAM (2.6GB, 4.7GB) CD: CD-DA, CD-ROM, CD-ROM XA, CD-R, CD-RW Photo (Multisession) Video CD, CD-Extra, (CD+), CD-test	
Loading mechanism	Load: Manual Release: (a) Electrical Release (Release Button) (b) Release by ATAPI command (c) Emergency Release	
Power Requirement		
Input Voltage	5 V +/- 5 % (Operating)	

DVD-Dual Interface

Item	Specification	
Vendor & model name	LITEON SOSW-833S PIONEER DVR-K16RA	
Performance Specification	With CD Diskette	With DVD Diskette
Transfer rate (KB/sec)	Sustained: Max 3.6Mbytes/sec	Sustained: Max 10.8Mbytes/sec
Buffer Memory	2MB	
Interface	Enhanced IDE(ATAPI) compatible	

DVD-Dual Interface

Item	Specification
Applicable disc format	Support disc formats 1. Reads data in each CD-ROM, CD-ROM XA, CD-1, Video CD, CD-Extra and CD-Text 2. Reads data in Photo CD (single and Multi-session) 3. Reads standard CD-DA 4. Reads and writes CD-R discs 5. Reads and writes CD-RW discs 6. Reads and writes in each dVD+R/RW (Ver. 1.1) 7. Reads data in each DVD-ROM and DVD-R (Ver. 2.0 for Authoring) 8. Reads and writes in each DVD-R (Ver. 2.0 for general), DVD-RW and DVD+R/RW (Ver1.1)
Loading mechanism	Load: Manual Release: (a) Electrical Release (Release Button) (b) Release by ATAPI command (c) Emergency Release
Power Requirement	
Input Voltage	5 V +/- 5 % (Operating)

HD Audio Interface

Item	Specification
Audio Controller	ALC883
Audio onboard or optional	Built-in
Mono or Stereo	Stereo
Resolution	Wide range (~V80dB ~ +42dB) volume control with 1.5dB resolution of analog to analog mixer gain 16 bit stereo digital to analog converter 16 bit stereo analog to digital converter
Compatibility	HD Audio
Mixed sound source	Line-in, CD
Voice channel	8/16-bit, mono/stereo
Sampling rate	All DACs support 44.1k/48k/96k/192kHz sample rate All ADCs support 44.1k/48k/96kHz sample rate 16/20/24-bit S/PDIF-OUT supports 44.1k/48k/96k/192kHz sample rate 16/20/24-bit S/PDIF-IN supports 44.1k/48k/96kHz sample rate
Internal microphone	Yes
Internal speaker / Quantity	Yes/2

Video Interface

Item	Specification
Chipset	Built-in Intel® 945GM for UMA models NVIDIA® GeForce™ Go 7300 (72MV) for discrete models
Package	35.5 mm x 40 mm 1257 pin mBGA
Interface	internal PCIE
Supports ZV (Zoomed Video) port	Yes
Memory Interface	64-bit
Memory Bandwidth(GB/sec)	5.6
Fill Rate (Gpixels/sec)	1.4
Vertices/Second (Millions)	260
Memory Data Rate (MHz)	700
RAMDACs (MHz)	400

NOTE: RAMDAC refers to **R**andom **A**ccess **M**emory **D**igital to **A**nalog **C**onverter: the VGA controller chip that maintains the range of colors and converts data from memory into analog signals for the monitor.

Video Memory

Item	Specification
Chipset	Built-in Intel® 945GM for UMA models NVIDIA® GeForce™ Go 7300 (72MV) for discrete models
Memory size	64MB/128MB
Interface	DDR2

USB Port

Item	Specification
Chipset	Built-in ICH7-M
USB Compliancy Level	2.0
OHCI	USB 1.1 and USB 2.0 Host controller
Number of USB port	3
Location	Three on the right side
Serial port function control	Enable/Disable by BIOS Setup

PCMCIA Port

Item	Specification
PCMCIA controller	ENE CB714
Supports card type	Type-II
Number of slots	One type-II
Access location	Left panel
Supports ZV (Zoomed Video) port	No ZV support
Supports 32 bit CardBus	Yes

System Board Major Chips

Item	Controller
Core logic	Intel® 945GM?945PM+ICH7-M

System Board Major Chips

Item	Controller
VGA	Built in Intel®945GM for UMA models NVIDIA® GeForce™ Go 7300 (72MV) for discrete models
LAN	ENE BCM4401E
USB 2.0	Built in ICH7-M
Super I/O controller	SMSc LPC47N207
MODEM	Built-in ICH7-M
Bluetooth	Built-in ICH7-M
Wireless 802.11 b+g	Built-in ICH7-M
PCMCIA	ENE CB714
HD Audio	Realtek ALC883

Keyboard

Item	Specification
Keyboard controller	ENE KB 910Q
Total number of keypads	88-/89-key
Windows logo key	Yes
Internal & external keyboard work simultaneously	Plug USB keyboard to the USB port directly: Yes

Battery

Item	Specification
Vendor & model name	Sanyo (6cell) 2.0 Sony (6cell) 2.0 Panasonic (6cell) 2.0 Snayo (6cell) 2.4 Sony (6cell) 2.4 Panasonic (6cell)2.4 Sanyo (9cell) 2.4
Battery Type	Li-ion
Pack capacity	4000 mAH forSanyo (6cell) 2.0 3920 mAH Sony (6cell) 2.0 3900 mAH Panasonic (6cell) 2.0 4800 mAH Snayo (6cell) 2.4 4800 mAH Sony (6cell) 2.4 4800 mAH Panasonic (6cell)2.4 Sanyo (9cell) 2.4
Number of battery cell	6/9
Package configuration	3 cells in series, 2 series in parallel 3 cells in series, 3 series in parallel
Normal voltage	14.8V
Charge voltage	16.8+-0.2v

LCD 15.4" inch

Item		Specification			
Vendor & model name	AUO B154EW01 V8 AUO B154EW01V9	CMO N15411- L0B CMO N15411- L0C	LG LPL LP154W01-TLE LG LP154W01- TLA2 LG LPL LP154W01- TLD1	QDI QD15TL07-01	SAMSUNG LTN154X3-L01- V1A4
Screen Diagonal (mm)	15.4 inches	15.4 inches	15.4 inches	15.4 inches	15.4 inches
Active Area (mm)	331.2x207.0	331.2x207.0	331.2x207.0	331.2x207.0	331.2x207.0
Display resolution (pixels)	1280x800WXG A	1280x800WXG A	1280x800WXG A	1280x800WXG A	1280x800WXG A
Pixel Pitch	0.2588x0.2588	0.2588x0.2588	0.2588x0.2588	0.2588x0.2588	0.2588x0.2588
Pixel Arrangement	R.G.B. Vertical Stripe	R.G.B. Vertical Stripe	R.G.B. Vertical Stripe	R.G.B. Vertical Stripe	R.G.B. Vertical Stripe
Display Mode	Normally White	Normally White	Normally White	Normally White	Normal White
Typical White Luminance (cd/m ²) also called Brightness	180	190	185	185	200
Luminance Uniformity	N/A	N/A	N/A	N/A	N/A
Contrast Ratio	400	500	300	400	300
Response Time (Optical Rise Time/Fall Time)msec	16	10/20	25	6/10	25
Nominal Input Voltage VDD	N/A	+3.3V	+3.3V	3.3V	3.3V
Typical Power Consumption (watt)	N/A	4.22	N/A	N/A	4.2
Weight	585	625	585	585	530
Physical Size(mm)	344x222x6.2	344x222x6.2	344x222x6.35 (max)	344x222x6.2	344x222x6.2
Electrical Interface	1 channel LVDS	1 channel LVDS	1 channel LVDS	1 channel LVDS	1 channel LVDS
Support Color	262,144	262,144	262,144	262,144	262,144
Viewing Angle (degree) Horizontal: Right/ Left Vertical: Upper/ Lower	40/40/ 10/30	45/45 15/35	60/60 40/50	45/45 15/35	45/45 15/35
Temperature Range(° C) Operating Storage (shipping)	0 to +50 -20 to +60	0 to +50 -20 to +60	0 to +50 -25 to +60	0 to +50 -20 to +60	0 to +50 -20 to +60

LCD Inverter

Item	Specification
Vendor & model name	Darfon/V189-301GP
Brightness conditions	N/A
Input voltage (V)	9~21
Input current (mA)	2.56 (max)
Output voltage (V, rms)	780V (2000V for kick off)
Output current (mA, rms)	6.5 (max)
Output voltage frequency (k Hz)	65K Hz (max)

AC Adaptor

Item	Specification
Input rating	90V AC to 264V AC, 47Hz to 63Hz
Maximum input AC current	1.7A
Inrush current	220A@115VAC 220A@230VAC
Efficiency	82% min. @115VAC input full load

System Power Management

ACPI mode	Power Management
Mech. Off (G3)	All devices in the system are turned off completely.
Soft Off (G2/S5)	OS initiated shutdown. All devices in the system are turned off completely.
Working (G0/S0)	Individual devices such as the CPU and hard disc may be power managed in this state.
Suspend to RAM (S3)	CPU set power down VGA Suspend PCMCIA Suspend Audio Power Down Hard Disk Power Down CD-ROM Power Down Super I/O Low Power mode
Save to Disk (S4)	Also called Hibernation Mode. System saves all system states and data onto the disc prior to power off the whole system.

System Utilities

BIOS Setup Utility

The BIOS Setup Utility is a hardware configuration program built into your computer's BIOS (Basic Input/Output System).

Your computer is already properly configured and optimized, and you do not need to run this utility. However, if you encounter configuration problems, you may need to run Setup. Please also refer to Chapter 4 Troubleshooting when problem arises.

To activate the BIOS Utility, press **F2** during POST (when "Press <F2> to enter Setup" message is prompted on the bottom of screen).

Press **F2** to enter setup. The default parameter of F12 Boot Menu is set to "disabled". If you want to change boot device without entering BIOS Setup Utility, please set the parameter to "enabled".

Press <F12> during POST to enter multi-boot menu. In this menu, user can change boot device without entering BIOS SETUP Utility.

PhoenixBIOS Setup Utility					
Information	Main	Advanced	Security	Boot	Exit
CPU Type :	Genunie Intel (R) CPU				
CPU Speed :	1.66GHz				
HDD Model Name :					
HDD Serial Number :					
ATAPI Model Name :	None				
ATAPI Serial Number :	None				
BIOS Version:	V1.10				
VGA BIOS Ver	Intel V1256				
Serial Number	xxxxxxxxxxxxxxxxxxxxxxxx			22 Byte	
Asset Tag Number	N/A			32 Byte	
Produce Name	TravelMate 4200			16 Byte	
Manufacturer Name:	Acer			16 Byte	
UUID:	xxxxxxxxxxxxxxxxxxxxxxxx			32 Byte	
F1 Help ↑↓ Select Item F5/F6 Change Values F9 Setup Defaults Esc Exit ←→ Select Menu Enter Select ▶ Sub-Menu F10 Save and Exit					

Navigating the BIOS Utility

There are six menu options: Info., Main, System Devices, Security, Boot, and Exit.

Follow these instructions:

- To choose a menu, use the cursor left/right keys (← →).
- To choose a parameter, use the cursor up/down keys (↑ ↓).
- To change the value of a parameter, press F3 or F6.
- A plus sign (+) indicates the item has sub-items. Press ENTER to expand this item.
- Press ESC while you are in any of the menu options to go to the Exit menu.
- In any menu, you can load default settings by pressing F9. You can also press F10 to save any changes made and exit the BIOS Setup Utility.

NOTE: You can change the value of a parameter if it is enclosed in square brackets. Navigation keys for a particular menu are shown on the bottom of the screen. Help for parameters are found in the Item Specific Help part of the screen. Read this carefully when making changes to parameter values. **Please note that system information is subject to different models.**

Information

PhoenixBIOS Setup Utility

Information
Main
Advanced
Security
Boot
Exit

```

CPU Type :          Genunie Intel (R) CPU
CPU Speed :        1.66GHz

HDD Model Name :
HDD Serial Number :
ATAPI Model Name : None
ATAPI Serial Number : None

BIOS Version:      V1.10
VGA BIOS Ver      Intel V1256

Serial Number      xxxxxxxxxxxxxxxxxxxxxxxx          22 Byte
Asset Tag Number   N/A                          32 Byte
Produce Name       TravelMate 4200                 16 Byte
Manufacturer Name: Acer                             16 Byte
UUID:              xxxxxxxxxxxxxxxxxxxxxxxx          32 Byte
    
```

F1 Help
↑↓ Select Item
F5/F6 Change Values
F9 Setup Defaults

Esc Exit
←→ Select Menu
Enter Select ▶ Sub-Menu
F10 Save and Exit

NOTE: The system information is subject to different models. Please refer to your laptop for actual model name and CPU type.

Parameter	Description
CPU Type	This field shows the CPU type and speed of the system.
IDE1 Model Name	This field shows the model name of HDD installed on primary IDE master.
IDE1 Serial Number	This field displays the serial number of HDD installed on primary IDE master.
IDE2I Model Name	This field displays the mofel name of devices installed on secondary IDE master. The hard disk drive or optical drive model name is automatically detected by the system.
IDE2 Serial Number	This field shows the serial number of devices installed on secondary IDE master.
System BIOS ver	Displays system BIOS version.
VGA BIOS Ver	This field displays the VGA firmware version of the system.
KBC Ver	This field shows the keyboard
Serial Number	This field displays the serial number of this unit.
Asset Tag Number	This field displays the asset tag number of the system.
Product Name	This field shows product name of the system.
Manufacturer Name	This field displays the manufacturer of this system.

Parameter	Description
UUID Number	This will be visible only when an internal LAN device is presenting. UUID=32bytes

Main

The Main screen displays a summary of your computer hardware information, and also includes basic setup parameters. It allows the user to specify standard IBM PC AT system parameters.

PhoenixBIOS Setup Utility					
Information	Main	Advanced	Security	Boot	Exit
					Item Specific Help
System Time:	[22:03:28]				<Tab>, <Shift-Tab>, or <Enter> selects field.
System Date:	[12/21/2005]				
System Memory:	640 KB	Shows system base memory size			
Extended Memory:	255 MB	Shows extended memory size			
Video Memory	[64MB]	VGA memory size			
Quiet Boot:	[Enabled]				
Power on display:	[Auto]				
Network boot	[Enabled]				
F12 Boot Menu	[Disabled]				
D2D Recovery	[Enabled]				
F1 Help	↑↓ Select Item	F5/F6 Change Values	F9 Setup Defaults		
Esc Exit	←→ Select Menu	Enter Select	▶ Sub-Menu	F10 Save and Exit	

NOTE: The screen above is for your reference only. Actual values may differ.

The table below describes the parameters in this screen. Settings in **boldface** are the default and suggested parameter settings.

Parameter	Description	Format/Option
System Time	Sets the system time. The hours are displayed with 24-hour format.	Format: HH:MM:SS (hour:minute:second) System Time
System Date	Sets the system date.	Format MM/DD/YYYY (month/day/year) System Date
System Memory	This field reports the memory size of the system. Memory size is fixed to 640MB	
Extended Memory	This field reports the memory size of the extended memory in the system. Extended Memory size=Total memory size-1MB	
VGA Memory	Shows the VGA memory size. VGA Memory size=64/128MB	
Quiet Boot	Determines if Customer Logo will be displayed or not; shows Summary Screen is disabled or enabled. Enabled: Customer Logo is displayed, and Summary Screen is disabled. Disabled: Customer Logo is not displayed, and Summary Screen is enabled.	Option: Enabled or Disabled
Power on display	Auto: During power process, the system will detect if any display device is connected on external video port. If any external display device is connected, the power on display will be in CRT (or projector) only mode. Otherwise it will be in LCD only mode. Both: Simultaneously enable both the integrated LCD screen and the system's external video port (for an external CRT or projector).	Option: Auto or Both
Network Boot	Enables, disables the system boot from LAN (remote server).	Option: Enabled or Disabled
F12 Boot Menu	Enables, disables Boot Menu during POST.	Option: Disabled or Enabled
D2D Recovery	Enables, disables D2D Recovery function. The function allows the user to create a hidden partition on hard disc drive to store operation system and restore the system to factory defaults.	Option: Enabled or Disabled

NOTE: The sub-items under each device will not be shown if the device control is set to disable or auto. This is because the user is not allowed to control the settings in these cases.

Advanced

The Advanced screen contains parameters involving your hardware devices. It also provides advanced settings of the system.

PhoenixBIOS Setup Utility			
Information	Main	Advanced	Security
		Boot	Exit
Infrared Port (FIR)		[Enabled]	Item Specific Help
			Configure Infrared Port using options: [Disable] No configuration [Enabled] User configuration
F1 Help	↑ ↓ Select Item	F5/F6 Change Values	F9 Setup Defaults
Esc Exit	← → Select Menu	Enter Select ▶ Sub-Menu	F10 Save and Exit

The table below describes the parameters in the screen. Settings in **boldface** are the default and suggested parameter settings.

	Description	Option
Infrared Port	Configure serial port B using options: [Disabled]: No configuration [Enabled]: User configuration [Auto]: BIOS or OS chooses configuration (OS Controlled) Displayedd when controlled by OS	Disabled Enabled Auto

Security

The Security screen contains parameters that help safeguard and protect your computer from unauthorized use.

PhoenixBIOS Setup Utility					
Information	Main	Advanced	Security	Boot	Exit
Supervisor Password Is : Clear User Password Is : Clear HDD Password Is: Clear Set Supervisor Password [Enter] Set User Password [Enter] Set Hdd Password [Enter] Password on Boot [Disabled]					Item Specific Help Supervisor Password controls accesses of the whole setup utility. It can be used to boot up when Password on boot is enabled.
F1 Help	↑ ↓	Select Item	F5/F6	Change Values	F9 Setup Defaults
Esc Exit	← →	Select Menu	Enter	Select ▶ Sub-Menu	F10 Save and Exit

The table below describes the parameters in this screen. Settings in **boldface** are the default and suggested parameter settings.

Parameter	Description	Option
User Password is	Shows the setting of the user password.	Clear or Set
Supervisor Password is	Shows the setting of the Supervisor password	Clear or Set
Set User Password	Press Enter to set the user password. When user password is set, this password protects the BIOS Setup Utility from unauthorized access. The user can enter Setup menu only and does not have right to change the value of parameters.	
Set Supervisor Password	Press Enter to set the supervisor password. When set, this password protects the BIOS Setup Utility from unauthorized access. The user can not either enter the Setup menu nor change the value of parameters.	
Primary HardDisk Security	Enables or disables primary hard disk security function.	
Password on Boot	Defines whether a password is required or not while the events defined in this group happened. The following sub-options are all requires the Supervisor password for changes and should be grayed out if the user password was used to enter setup.	Disabled or Enabled

NOTE: When you are prompted to enter a password, you have three tries before the system halts. Don't forget your password. If you forget your password, you may have to return your notebook computer to your dealer to reset it.

Setting a Password

Follow these steps as you set the user or the supervisor password:

1. Use the **F4** and **F5** keys to highlight the Set Supervisor Password parameter and press the **ENTER** key. The Set Supervisor Password box appears:

Set Supervisor Password

Enter New Password []

Confirm New Password []

2. Type a password in the "Enter New Password" field. The password length can not exceeds 8 alphanumeric characters (A-Z, a-z, 0-9, not case sensitive). Retype the password in the "Confirm New Password" field.

IMPORTANT: Be very careful when typing your password because the characters do not appear on the screen.

3. Press **ENTER**.
4. After setting the password, the computer sets the User Password parameter to "Set".
4. If desired, you can opt to enable the Password on boot parameter.
5. When you are done, press **F10** to save the changes and exit the BIOS Setup Utility.

Removing a Password

Follow these steps:

1. Use the **↑** and **↓** keys to highlight the Set Supervisor Password parameter and press the **ENTER** key. The Set Password box appears:

Set Supervisor Password		
Enter current password	[]
Enter New Password	[]
Confirm New Password	[]

2. Type the current password in the Enter Current Password field and press **ENTER**.
3. Press **ENTER** twice **without** typing anything in the Enter New Password and Confirm New Password fields. The computer then sets the Supervisor Password parameter to “Clear”.
4. When you have changed the settings, press **F10** to save the changes and exit the BIOS Setup Utility.

Changing a Password

1. Use the **↑** and **↓** keys to highlight the Set Supervisor Password parameter and press the **ENTER** key. The Set Password box appears:

Set Supervisor Password		
Enter current password	[]
Enter New Password	[]
Confirm New Password	[]

2. Type the current password in the Enter Current Password field and press **ENTER**.
3. Type a password in the Enter New Password field. Retype the password in the Confirm New Password field.
4. Press **ENTER**. After setting the password, the computer sets the User Password parameter to “Set”.
5. If desired, you can enable the Password on boot parameter.
6. When you are done, press **F10** to save the changes and exit the BIOS Setup Utility.

If the verification is OK, the screen will display as following.

Setup Notice	
Changes have been saved.	
[continue]	

The password setting is complete after the user presses **F10**.

If the current password entered does not match the actual current password, the screen will show you the Setup Warning.

Setup Warning
Invalid password
Re-enter Password
[continue]

If the new password and confirm new password strings do not match, the screen will display the following message.

Setup Warning
Password do not match
Re-enter Password

Boot

This menu allows the user to decide the order of boot devices to load the operating system. Bootable devices includes the distette drive in module bay, the onboard hard disk drive and the CD-ROM in module bay.

PhoenixBIOS Setup Utility					
Information	Main	Advanced	Security	Boot	Exit
<p>Boot priority order:</p> <ul style="list-style-type: none">1: IDE 0: TOSHIBA MK6025GAS-(PM)2: IDE 1: MATSHITADVD-RAM UJ-845S3: IDE 2:4: USB FDD:5: PCI LAN: Broadcom MBA6: USB HDD:7: USB KEY:8: USB CDROM:					<p>Item Specific Help</p> <p>Use <↑> or <↓> to select a device, then press <F6> to move it up the list, or <F5> to move it down the list. Press <Esc> to escape the menu.</p>
F1 Help	↑↓ Select Item	F5/F6 Change Values	F9 Setup Defaults		
Esc Exit	←→ Select Menu	Enter Select	▶ Sub-Menu	F10 Save and Exit	

Exit

The Exit screen contains parameters that help safeguard and protect your computer from unauthorized use.

PhoenixBIOS Setup Utility					
Information	Main	Advanced	Security	Boot	Exit
Exit Saving Changes Exit Disarding Changes Load Setup Defaults Discard Changes Save Changes				Item Specific Help Exit System Setup and save your changes to CMOS.	
F1 Help	↑↓ Select Item	F5/F6 Change Values	F9 Setup Defaults		
Esc Exit	←→ Select Menu	Enter Select	▶ Sub-Menu	F10 Save and Exit	

The table below describes the parameters in this screen.

Parameter	Description
Exit Saving Changes	Exit System Setup and save your changes to CMOS.
Exit Discarding Changes	Exit utility without saving setup data to CMOS.
Load Setup Default	Load default values for all SETUP item.
Discard Changes	Load previous values from CMOS for all SETUP items.
Save Changes	Save Setup Data to CMOS.

BIOS Flash Utility

The BIOS flash memory update is required for the following conditions:

- New versions of system programs
- New features or options
- Restore a BIOS when it becomes corrupted.

Use the Phlash utility to update the system BIOS flash ROM.

NOTE: If you do not have a crisis recovery diskette at hand, then you should create a **Crisis Recovery Diskette** before you use the Phlash utility.

NOTE: Do not install memory-related drivers (XMS, EMS, DPMS) when you use the Phlash.

NOTE: Please use the AC adaptor power supply when you run the Phlash utility. If the battery pack does not contain enough power to finish BIOS flash, you may not boot the system because the BIOS is not completely loaded.

Follow the steps below to run the Phlash:

First, you have to create a crisis diskette. Follow the steps to create a crisis diskette.

1. Insert a floppy disk to the notebook under Windows mode.
2. Execute "wincri.exe"
3. Wait for few minutes. The process will completed automatically.

After you have created crisis diskette, you can then recovery the fail system.

1. Insert the Crisis diskette to the computer.
2. Press Fn+Esc and power on the sytem.
3. The systme will execute the file automatically. Wait for few minutes the system will reboot as the entire process completed.

Machine Disassembly and Replacement

This chapter contains step-by-step procedures on how to disassemble the notebook computer for maintenance and troubleshooting.

To disassemble the computer, you need the following tools:

- Wrist grounding strap and conductive mat for preventing electrostatic discharge
- Small Philips screw driver
- Philips screwdriver
- Plastic flat head screw driver
- Tweezers

NOTE: The screws for the different components vary in size. During the disassembly process, group the screws with the corresponding components to avoid mismatch when putting back the components. When you remove the stripe cover, please be careful not to scrape the cover.

General Information

Before You Begin

Before proceeding with the disassembly procedure, make sure that you do the following:

1. Turn off the power to the system and all peripherals.
2. Unplug the AC adapter and all power and signal cables from the system.
3. Remove the battery pack.

Disassembly Procedure Flowchart

The flowchart on the succeeding page gives you a graphic representation on the entire disassembly sequence and instructs you on the components that need to be removed during servicing. For example, if you want to remove the system board, you must first remove the keyboard, then disassemble the inside assembly frame in that order.

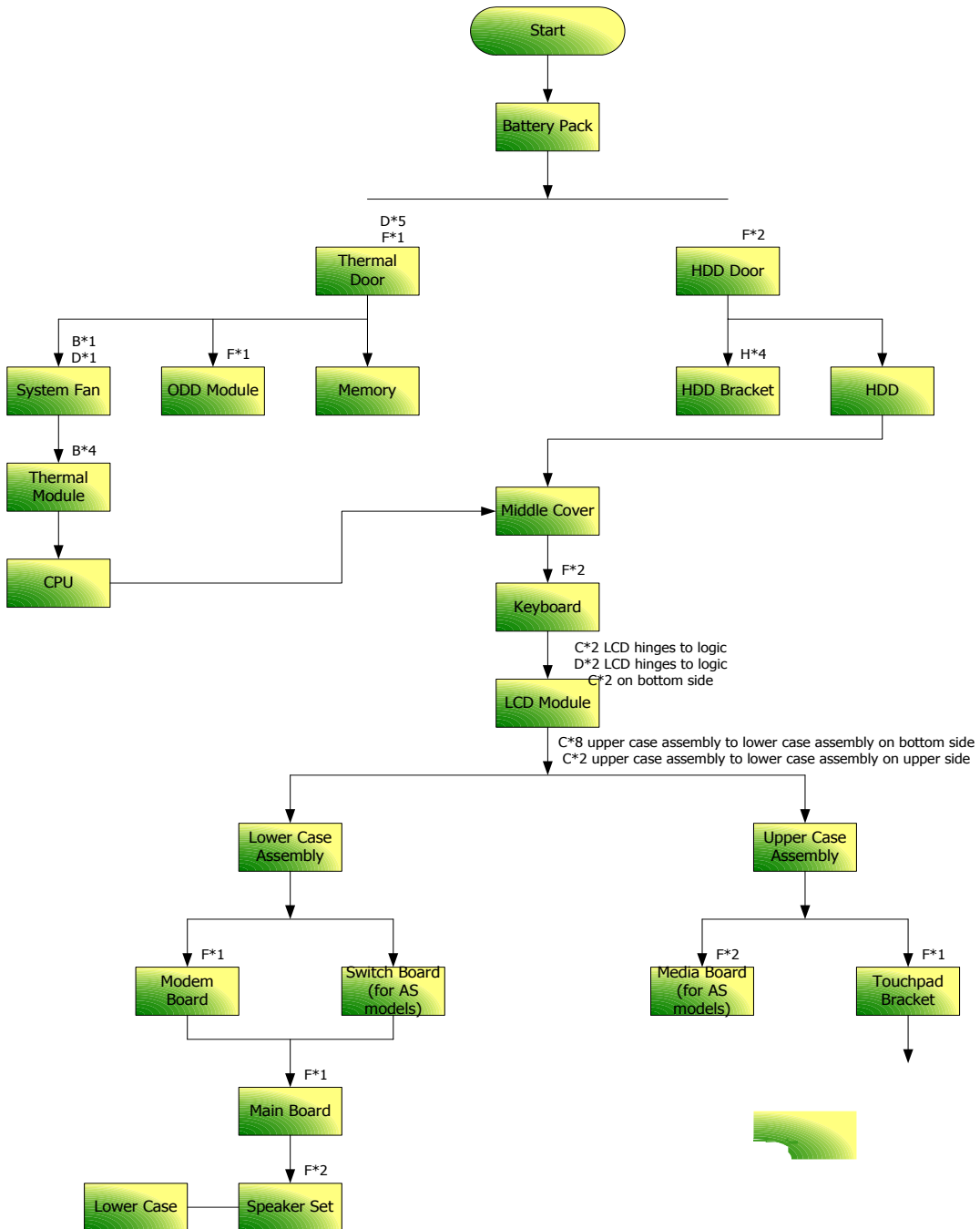



Screw List

Item	Description	Part Number
A	SCREW M2.5*3(NL)	86.TAVV5.001
B	SCREW M2.5*6(NL)	86.TAVV5.002
C	SCREW M2.5*10(NL)	86.TAVV5.003
D	SCREW M2.5*15(NL)	86.TAVV5.004
E	SCREW M2*2.2	86.TAVV5.005
F	SCREW M2*3(NL)	86.TAVV5.006
G	SCREW M2*4	86.TAVV5.007
H	SCREW M3*4(NL)	86.TAVV5.008
I	SCREW D-SUB 4#X40* 1/5-NI (NL)	86.TAVV5.009

Removing the Battery Pack

1. Slide the battery latch then remove the battery.



Removing the HDD Module/Memory/System Fan/Thermal Module/CPU/ODD Module and LCD Module

Removing the HDD Module

1. Remove the two screws fastening the HDD door.
2. Detach the HDD door from the notebook.



3. Pull the HDD module outwards to disconnect the HDD module from the main board.
4. Take out the HDD module carefully.

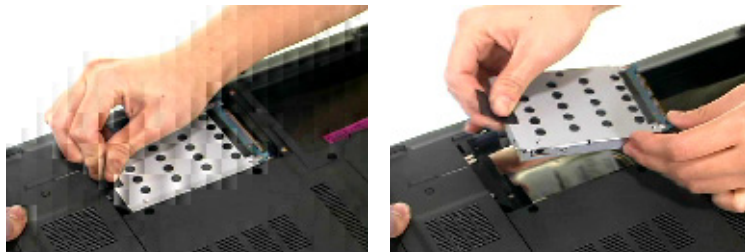

Removing the Memory/System Fan/Thermal Module/CPU

1. Remove the six screws fastening the thermal door. (M2.5*15(NL) for red circle; M2*3(NL) for yellow circle)
2. Detach the thermal door from the notebook.
3. Pop out the memory then remove it



4. Use a tweezer to take out the fan cable as shown.
5. Disconnect the fan cable from the main board.



6. Remove the two screws fastening the system fan.
7. Take out the system fan from the main unit.



8. Remove the four screws fastening the thermal module.
9. Then detach the thermal module carefully.



10. Use a flat-headed screwdriver to release the CPU lock (Turn anti-clockwise).
11. Detach the CPU from the CPU socket carefully.

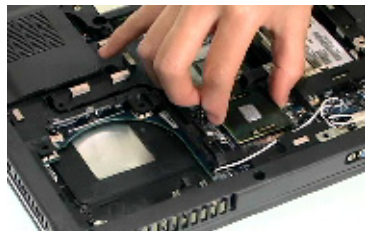
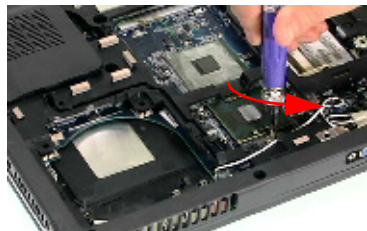

12. Tear off the tape fastening the antenna set.
13. Then remove the antenna protection cover.

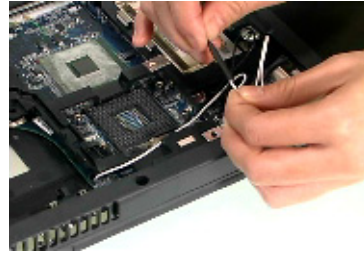

14. Remove the screw holding the mini cover.
15. Detach the mini cover from the main unit.



Removing the ODD Module

1. First, remove the screw fastening the ODD module as shown.
2. Push the ODD module outwards then remove it.



Removing the LCD Module

1. Open the LCD module as shown (See the left and the middle picture).
2. Detach the middle cover from the main unit carefully.



3. Remove the screw fastening the keyboard.
4. Then turn over the keyboard as shown.

5. Disconnect the keyboard cable from the main board.



6. Turn over the notebook, remove two screws fastening the LCD module on the bottom.
7. Then turn the notebook to the front side. Take out the antenna then disconnect the LCD cable (See the middle and the right images).

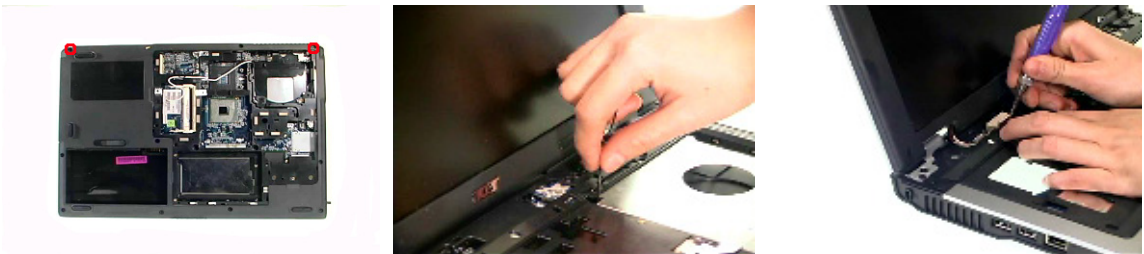

8. Remove four screws fastening the LCD module (M2.5*10(NL) for yellow circles; M2.5*15(NL) for red circles).
9. Then detach the entire LCD module from the main unit carefully.



Disassembling the Main Unit

Separate the Main Unit Into the Upper and the Lower Case Assembly

1. Remove two screws fastening the upper case assembly to the lower case assembly.
2. Disconnect the LED board cable from the main board.

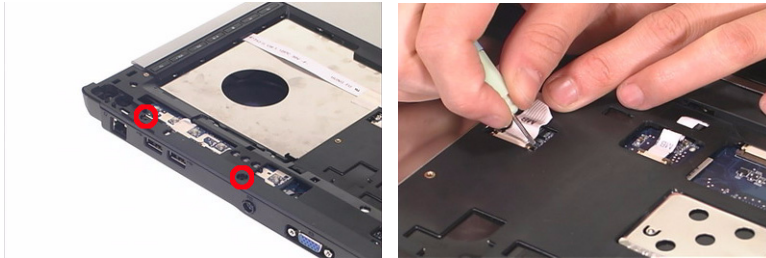

3. Disconnect the touchpad cable from the main board.
4. Remove eight screws fastening the upper case assembly and the lower case assembly on the bottom as shown.
5. Detach the upper case assembly carefully.

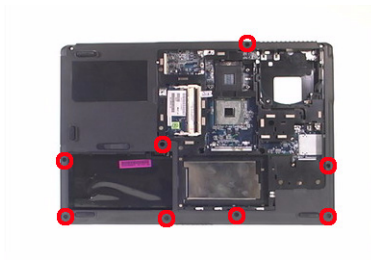

Disassembling the Upper Case Assembly

6. Remove the two screws fastening the media board.
7. Take out the media board cable from the lower case as shown.
8. Detach the media board from the upper case carefully.

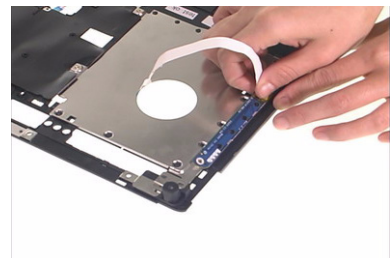
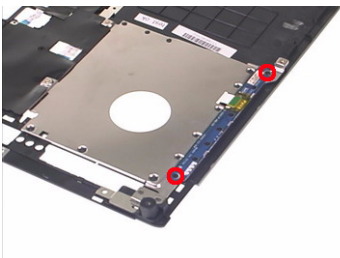

NOTE: Only Aspire 5650 series have media board.

9. Tear off the mylar on top of the touchpad bracket.
10. Remove the screws holding the touchpad bracket.
11. Then detach the touchpad bracket from the upper case.

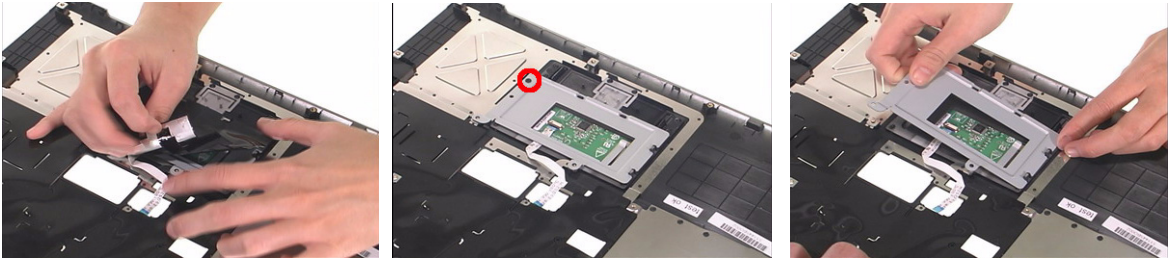

12. Disconnect the touchpad FFC.
13. Then remove the touchpad FFC from the touchpad.
14. Detach the touchpad from the upper case.

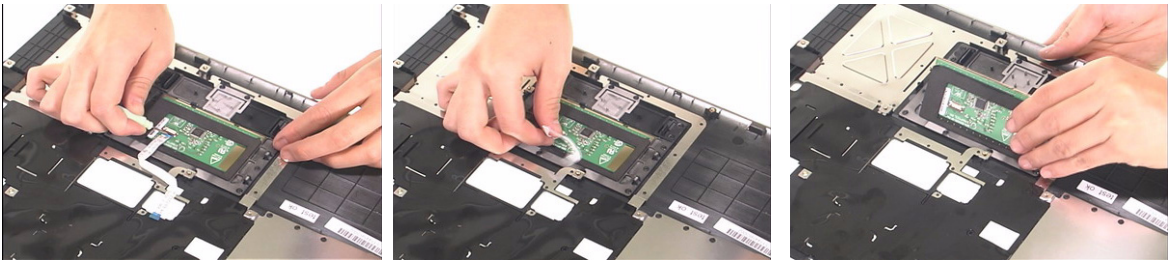

Disassembling the Lower Case Assembly

1. Detach the switch board from the main board.
2. Remove the screw fastening the modem board.

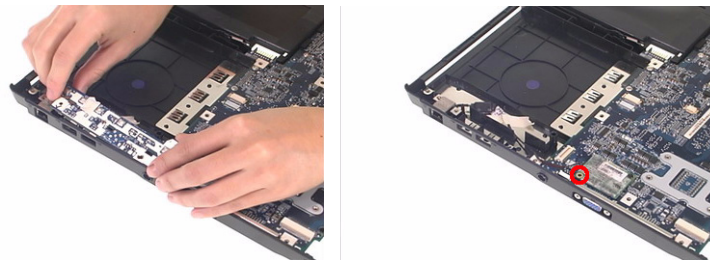

3. Disconnect the modem board from the main board then detach the modem board.
4. Detach the modem cable from the lower case.

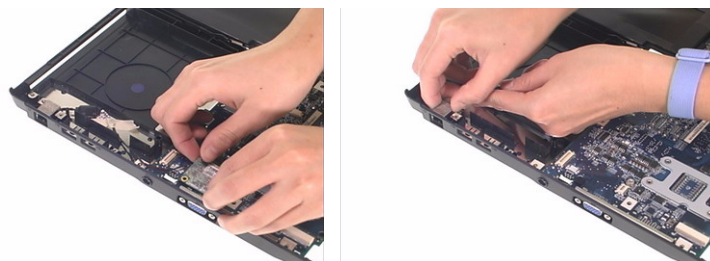

5. Disconnect the speaker cable from the main board.
6. Then disconnect the microphone cable from the main board.

7. Remove the screw fastening the main board to the lower case.

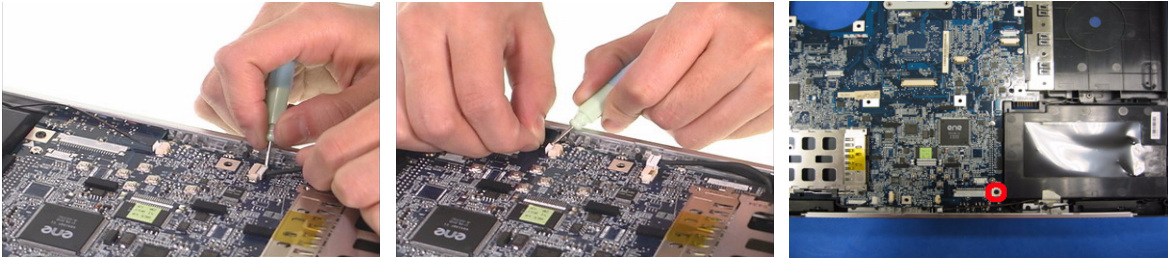

8. Pull the lower case outwards as the image shows and detach the main board from the lower case carefully.
9. Take out the microphone from the lower case.

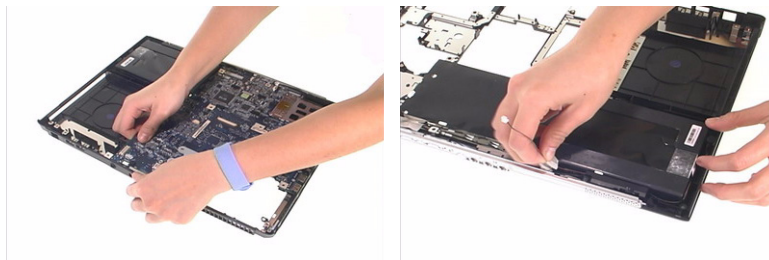

10. Remove the two screws fastening the speaker set.
11. Take out the speaker from the lower case.



Disassembling the LCD Module

1. Remove the four screw caps as shown.
2. Remove the four screws holding the LCD bezel.
3. Then detach the LCD bezel from the LCD module.



4. Remove the screw fastening the LCD inverter.
5. Take out the LCD inverter from the LCD cover, then disconnect the LCD cable from the inverter.
6. Disconnect the LCD power cable on the other side.

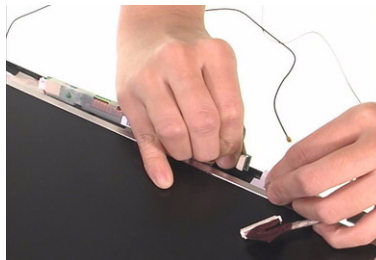

7. Remove the two screws fastening the LCD assembly.
8. Take out the LCD assembly from the LCD panel.
9. Tear off the tape fastening the LCD cable.

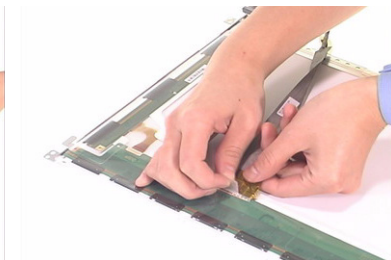

10. Remove the four screws fastening the LCD right bracket.
11. Remove the LCD right bracket.

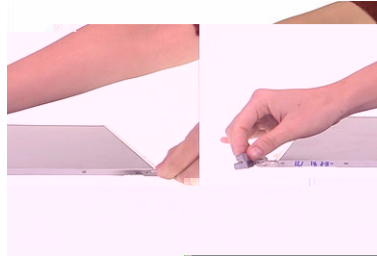
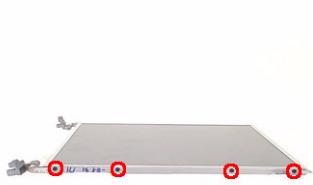

12. Remove the four screws holding the LCD left bracket.
13. Remove the LCD left bracket.

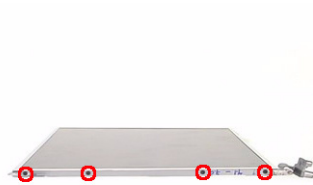

Disassembling the External Modules

Disassembling the HDD Module

1. Remove two screws holding the HDD bracket on one side.
2. Remove another two screws fastening the HDD bracket on the other side.
3. Detach the HDD from the HDD bracket.



Disassembling the ODD Module

1. Remove the three screws holding the optical bracket.
2. Remove the optical bracket from the optical disk drive.



Troubleshooting

Use the following procedure as a guide for computer problems.

NOTE: The diagnostic tests are intended to test only Acer products. Non-Acer products, prototype cards, or modified options can give false errors and invalid system responses.

1. Obtain the failing symptoms in as much detail as possible.
2. Verify the symptoms by attempting to re-create the failure by running the diagnostic test or by repeating the same operation.
3. Use the following table with the verified symptom to determine which page to go to.

Symptoms (Verified)	Go To
Power failure. (The power indicator does not go on or stay on.)	"Power System Check" on page 69.
POST does not complete. No beep or error codes are indicated.	"Power-On Self-Test (POST) Error Message" on page 72 "Undetermined Problems" on page 84
POST detects an error and displayed messages on screen.	"Error Message List" on page 73
Other symptoms (i.e. LCD display problems or others).	"Power-On Self-Test (POST) Error Message" on page 72
Symptoms cannot be re-created (intermittent problems).	Use the customer-reported symptoms and go to "Power-On Self-Test (POST) Error Message" on page 72 "Intermittent Problems" on page 83 "Undetermined Problems" on page 84

System Check Procedures

External Diskette Drive Check

Do the following to isolate the problem to a controller, driver, or diskette. A write-enabled, diagnostic diskette is required.

NOTE: Make sure that the diskette does not have more than one label attached to it. Multiple labels can cause damage to the drive or cause the drive to fail.

Do the following to select the test device.

1. Boot from the diagnostics diskette and start the diagnostics program.
2. See if FDD Test is passed as the program runs to FDD Test.
3. Follow the instructions in the message window.

If an error occurs with the internal diskette drive, reconnect the diskette connector on the system board.

If the error still remains:

1. Reconnect the external diskette drive/DVD-ROM module.
2. Replace the external diskette drive/CD-ROM module.
3. Replace the main board.

External CD-ROM Drive Check

Do the following to isolate the problem to a controller, drive, or CD-ROM. Make sure that the CD-ROM does not have any label attached to it. The label can cause damage to the drive or can cause the drive to fail.

Do the following to select the test device:

1. Boot from the diagnostics diskette and start the diagnostics program.
2. See if CD-ROM Test is passed when the program runs to CD-ROM Test.
3. Follow the instructions in the message window.

If an error occurs, reconnect the connector on the System board. If the error still remains:

1. Reconnect the external diskette drive/CD-ROM module.
2. Replace the external diskette drive/CD-ROM module.
3. Replace the main board.

Keyboard or Auxiliary Input Device Check

Remove the external keyboard if the internal keyboard is to be tested.

If the internal keyboard does not work or an unexpected character appears, make sure that the flexible cable extending from the keyboard is correctly seated in the connector on the system board.

If the keyboard cable connection is correct, run the Keyboard Test.

If the tests detect a keyboard problem, do the following one at a time to correct the problem. Do not replace a non-defective FRU:

1. Reconnect the keyboard cables.
2. Replace the keyboard.
3. Replace the main board.

The following auxiliary input devices are supported by this computer:

- Numeric keypad
- External keyboard

If any of these devices do not work, reconnect the cable connector and repeat the failing operation.

Memory check

Memory errors might stop system operations, show error messages on the screen, or hang the system.

1. Boot from the diagnostics diskette and start the doagmpstotics program (please refer to main board).
2. Go to the diagnostic memory in the test items.
3. Press F2 in the test items.
4. Follow the instructions in the message window.

NOTE: Make sure that the DIMM is fully installed into the connector. A loose connection can cause an error.

Power System Check

To verify the symptom of the problem, power on the computer using each of the following power sources:

1. Remove the battery pack.
2. Connect the power adapter and check that power is supplied.
3. Disconnect the power adapter and install the charged battery pack; then check that power is supplied by the battery pack.

If you suspect a power problem, see the appropriate power supply check in the following list:

- "Check the Power Adapter" on page 70
- "Check the Battery Pack" on page 71

Check the Power Adapter

Unplug the power adapter cable from the computer and measure the output voltage at the plug of the power adapter cable. See the following figure

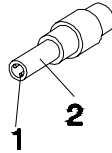

Pin 1: +19 to +20.5V
Pin 2: 0V, Ground

1. If the voltage is not correct, replace the power adapter.
2. If the voltage is within the range, do the following:
 - Replace the System board.
 - If the problem is not corrected, see “Undetermined Problems” on page 84.
 - If the voltage is not correct, go to the next step.

NOTE: An audible noise from the power adapter does not always indicate a defect.

3. If the power-on indicator does not light up, check the power cord of the power adapter for correct continuity and installation.
4. If the operational charge does not work, see “Check the Battery Pack” on page 71.

Check the Battery Pack

To check the battery pack, do the following:

From Software:

1. Check out the Power Management in control Panel
2. In Power Meter, confirm that if the parameters shown in the screen for Current Power Source and Total Battery Power Remaining are correct.
3. Repeat the steps 1 and 2, for both battery and adapter.
4. This helps you identify first the problem is on recharging or discharging.

From Hardware:

1. Power off the computer.
2. Remove the battery pack and measure the voltage between battery terminals 1(+) and 6(ground). See the following figure

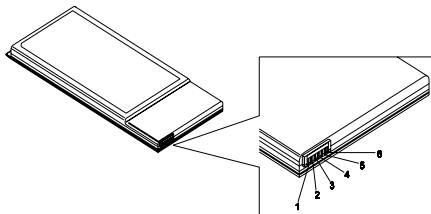

3. If the voltage is still less than 7.5 Vdc after recharging, replace the battery.

To check the battery charge operation, use a discharged battery pack or a battery pack that has less than 50% of the total power remaining when installed in the computer.

If the battery status indicator does not light up, remove the battery pack and let it return to room temperature. Re-install the battery pack.

If the charge indicator still does not light up, replace the battery pack. If the charge indicator still does not light up, replace the DC/DC charger board.

Touchpad Check

If the touchpad doesn't work, do the following actions one at a time to correct the problem. Do not replace a non-defective FRU:

1. Reconnect the touchpad cables.
2. Replace the touchpad.
3. Replace the system board.

After you use the touchpad, the pointer drifts on the screen for a short time. This self-acting pointer movement can occur when a slight, steady pressure is applied to the touchpad pointer. This symptom is not a hardware problem. No service actions are necessary if the pointer movement stops in a short period of time.

Power-On Self-Test (POST) Error Message

The POST error message index lists the error message and their possible causes. The most likely cause is listed first.

NOTE: Perform the FRU replacement or actions in the sequence shown in FRU/Action column, if the FRU replacement does not solve the problem, put the original part back in the computer. Do not replace a non-defective FRU.

This index can also help you determine the next possible FRU to be replaced when servicing a computer.

If the symptom is not listed, see “Undetermined Problems” on page 84.

The following lists the error messages that the BIOS displays on the screen and the error symptoms classified by function.

NOTE: Most of the error messages occur during POST. Some of them display information about a hardware device, e.g., the amount of memory installed. Others may indicate a problem with a device, such as the way it has been configured.

NOTE: If the system fails after you make changes in the BIOS Setup Utility menus, reset the computer, enter Setup and install Setup defaults or correct the error.

Index of Error Messages

Error Code List

Error Codes	Error Messages
006	Equipment Configuration Error Causes: 1. CPU BIOS Update Code Mismatch 2. IDE Primary Channel Master Drive Error (The causes will be shown before "Equipment Configuration Error")
010	Memory Error at xxxx:xxxx:xxxxh (R:xxxxh, W:xxxxh)
070	Real Time Clock Error
071	CMOS Battery Bad
072	CMOS Checksum Error
110	System disabled. Incorrect password is specified.
<No error code>	Battery critical LOW In this situation BIOS will issue 4 short beeps then shut down system, no message will show.
<No error code>	Thermal critical High In this situation BIOS will shut down system, not show message.

Error Message List

Error Messages	FRU/Action in Sequence
Failure Fixed Disk	Reconnect hard disk drive connector. "Load Default Settings" in BIOS Setup Utility. Hard disk drive System board
Stuck Key	see "Keyboard or Auxiliary Input Device Check" on page 68.
Keyboard error	see "Keyboard or Auxiliary Input Device Check" on page 68.
Keyboard Controller Failed	see "Keyboard or Auxiliary Input Device Check" on page 68.
Keyboard locked - Unlock key switch	Unlock external keyboard
Monitor type does not match CMOS - Run Setup	Run "Load Default Settings" in BIOS Setup Utility.
Shadow RAM Failed at offset: nnnn	BIOS ROM System board
System RAM Failed at offset: nnnn	DIMM System board
Extended RAM Failed at offset: nnnn	DIMM System board
System battery is dead - Replace and run Setup	Replace RTC battery and Run BIOS Setup Utility to reconfigure system time, then reboot system.
System CMOS checksum bad - Default configuration used	RTC battery Run BIOS Setup Utility to reconfigure system time, then reboot system.
System timer error	RTC battery Run BIOS Setup Utility to reconfigure system time, then reboot system. System board

Error Message List

Error Messages	FRU/Action in Sequence
Real time clock error	RTC battery Run BIOS Setup Utility to reconfigure system time, then reboot system. System board
Previous boot incomplete - Default configuration used	Run "Load Default Settings" in BIOS Setup Utility. RTC battery System board
Memory size found by POST differed from CMOS	Run "Load Default Settings" in BIOS Setup Utility. DIMM System board
Diskette drive A error	Check the drive is defined with the proper diskette type in BIOS Setup Utility See "External Diskette Drive Check" on page 68.
Incorrect Drive A type - run SETUP	Check the drive is defined with the proper diskette type in BIOS Setup Utility
System cache error - Cache disabled	System board
CPU ID:	System board
DMA Test Failed	DIMM System board
Software NMI Failed	DIMM System board
Fail-Safe Timer NMI Failed	DIMM System board
Device Address Conflict	Run "Load Default Settings" in BIOS Setup Utility. RTC battery System board
Allocation Error for device	Run "Load Default Settings" in BIOS Setup Utility. RTC battery System board
Failing Bits: nnnn	DIMM BIOS ROM System board
Fixed Disk n	None
Invalid System Configuration Data	BIOS ROM System board
I/O device IRQ conflict	Run "Load Default Settings" in BIOS Setup Utility. RTC battery System board
Operating system not found	Enter Setup and see if fixed disk and drive A: are properly identified. Diskette drive Hard disk drive System board

Error Message List

No beep Error Messages	FRU/Action in Sequence
No beep, power-on indicator turns off and LCD is blank.	Power source (battery pack and power adapter). See "Power System Check" on page 69.. Ensure every connector is connected tightly and correctly. Reconnect the DIMM. LED board. System board.
No beep, power-on indicator turns on and LCD is blank.	Power source (battery pack and power adapter). See "Power System Check" on page 69.. Reconnect the LCD connector Hard disk drive LCD inverter ID LCD cable LCD Inverter LCD System board
No beep, power-on indicator turns on and LCD is blank. But you can see POST on an external CRT.	Reconnect the LCD connectors. LCD inverter ID LCD cable LCD inverter LCD System board
No beep, power-on indicator turns on and a blinking cursor shown on LCD during POST.	Ensure every connector is connected tightly and correctly. System board
No beep during POST but system runs correctly.	Speaker System board

Phoenix BIOS Beep Codes

Code	Beeps	POST Routine Description
02h		Verify Real Mode
03h		Disable Non-Maskable Interrupt (NMI)
04h		Get CPU type
06h		Initialize system hardware
08h		Initialize chipset with initial POST values
09h		Set IN POST flag
0Ah		Initialize CPU registers
0Bh		Enable CPU cache
0Ch		Initialize caches to initial POST values
0Eh		Initialize I/O component
0Fh		Initialize the local bus IDE
10h		Initialize Power Management
11h		Load alternate registers with initial POST values
12h		Restore CPU control word during warm boot
13h		Initialize PCI Bus Mastering devices
14h		Initialize keyboard controller
16h	1-2-2-3	BIOS ROM checksum
17h		Initialize cache before memory autosize
18h		8254 timer initialization
1Ah		8237 DMA controller initialization
1Ch		Reset Programmable Interrupt Controller
20h	1-3-1-1	Test DRAM refresh
22h	1-3-1-3	Test 8742 Keyboard Controller
24h		Set ES segment register to 4 GB
26h		Enable A20 line
28h		Autosize DRAM
29h		Initialize POST Memory Manager
2Ah		Clear 215 KB base RAM
2Ch	1-3-4-1	RAM failure on address line xxxx
2Eh	1-3-4-3	RAM failure on data bits xxxx of low byte of memory bus
2Fh		Enable cache before system BIOS shadow
30h	1-4-1-1	RAM failure on data bits xxxx of high byte of memory bus
32h		Test CPU bus-clock frequency
33h		Initialize Phoenix Dispatch Manager
36h		Warm start shut down
38h		Shadow system BIOS ROM
3Ah		Autosize cache
3Ch		Advanced configuration of chipset registers
3Dh		Load alternate registers with CMOS values
42h		Initialize interrupt vectors
45h		POST device initialization

Code	Beeps	POST Routine Description
46h	2-1-2-3	Check ROM copyright notice
48h		Check video configuration against CMOS
49h		Initialize PCI bus and devices
4Ah		Initialize all video adapters in system
4Bh		QuietBoot start (optional)
4Ch		Shadow video BIOS ROM
4Eh		Display BIOS copyright notice
50h		Display CPU type and speed
51h		Initialize EISA board
52h		Test keyboard
54h		Set key click if enabled
58h	2-2-3-1	Test for unexpected interrupts
59h		Initialize POST display service
5Ah		Display prompt "Press F2 to enter SETUP"
5Bh		Disable CPU cache
5Ch		Test RAM between 512 and 640 KB
60h		Test extended memory
62h		Test extended memory address lines
64h		Jump to User Patch1
66h		Configure advanced cache registers
67h		Initialize Multi Processor APIC
68h		Enable external and CPU caches
69h		Setup System Management Mode (SMM) area
6Ah		Display external L2 cache size
6Bh		Load custom defaults (optional)
6Ch		Display shadow-area message
6Eh		Display possible high address for UMB recovery
70h		Display error messages
72h		Check for configuration errors
76h		Check for keyboard errors
7Ch		Set up hardware interrupt vectors
7Eh		Initialize coprocessor if present
80h		Disable onboard Super I/O ports and IRQs
81h		Late POST device initialization
82h		Detect and install external RS232 ports
83h		Configure non-MCD IDE controllers
84h		Detect and install external parallel ports
85h		Initialize PC-compatible PnP ISA devices
86h		Re-initialize onboard I/O ports
87h		Configure Motherboard Configurable Devices (optional)
88h		Initialize BIOS Area
89h		Enable Non-Maskable Interrupts (NMIs)
8Ah		Initialize Extended BIOS Data Area
8Bh		Test and initialize PS/2 mouse

Code	Beeps	POST Routine Description
8Ch		Initialize floppy controller
8Fh		Determine number of ATA drives (optional)
90h		Initialize hard-disk controllers
91h		Initialize local-bus hard-disk controllers
92h		Jump to UserPatch2
93h		Build MPTABLE for multi-processor boards
95h		Install CD ROM for boot
96h		Clear huge ES segment register
97h		Fixup Multi Processor table
98h	1-2	Search for option ROMs. One long, two short beeps on checksum failure.
99h		Check for SMART drive (optional)
9Ah		Shadow option ROMs
9Ch		Set up Power Management
9Dh		Initialize security engine (optional)
9Eh		Enable hardware interrupts
9Fh		Determine number of ATA and SCSI drives
A0h		Set time of day
A2h		Check key lock
A4h		Initialize Typematic rate
A8h		Erase F2 prompt
AAh		Scan for F2 key stroke
ACh		Enter SETUP
A Eh		Clear Boot flag
B0h		Check for errors
B2h		POST done- prepare to boot operating system
B4h	1	One short beep before boot
B5h		Terminate QuietBoot (optional)
B6h		Check password (optional)
B9h		Prepare Boot
BAh		Initialize DMI parameters
BBh		Initialize PnP Option ROMs
BCh		Clear parity checkers
BDh		Display MultiBoot menu
BEh		Clear screen (optional)
BFh		Check virus and backup reminders
C0h		Try to boot with INT 19
C1h		Initialize POST Error Manager (PEM)
C2h		Initialize error logging
C3h		Initialize error display function
C4h		Initialize system error handler
C5h		PnPnd dual CMOS (optional)
C6h		Initialize notebook docking (optional)
C7h		Initialize notebook docking late
C8h		Force check (optional)
C9h		Extended checksum (optional)

Code	Beeps	POST Routine Description
D2h		Unknown interrupt

Code	Beeps	POST Routine Description
E0h		Initialize the chipset
E1h		Initialize the bridge
E2h		Initialize the CPU
E3h		Initialize the system timer
E4h		Initialize system I/O
E5h		Check force recovery boot
E6h		Checksum BIOS ROM
E7h		Go to BIOS
E8h		Set Huge Segment
E9h		Initialize Multi Processor
EAh		Initialize OEM special code
EBh		Initialize PIC and DMA
ECh		Initialize Memory type
EDh		Initialize Memory size
EEh		Shadow Boot Block
EFh		System memory test
F0h		Initialize interrupt vectors
F1h		Initialize Run Time Clock
F2h		Initialize video
F3h		Initialize System Management Mode
F4h	1	Output one beep before boot
F5h		Boot to Mini DOS
F6h		Clear Huge Segment
F7h		Boot to Full DOS

Index of Symptom-to-FRU Error Message

LCD-Related Symptoms

Symptom / Error	Action in Sequence
LCD backlight doesn't work LCD is too dark LCD brightness cannot be adjusted LCD contrast cannot be adjusted	Enter BIOS Utility to execute "Load Setup Default Settings", then reboot system. Reconnect the LCD connectors. Keyboard (if contrast and brightness function key doesn't work). LCD inverter ID LCD cable LCD inverter LCD System board
Unreadable LCD screen Missing pels in characters Abnormal screen Wrong color displayed	Reconnect the LCD connector LCD inverter ID LCD cable LCD inverter LCD System board
LCD has extra horizontal or vertical lines displayed.	LCD inverter ID LCD inverter LCD cable LCD System board

Indicator-Related Symptoms

Symptom / Error	Action in Sequence
Indicator incorrectly remains off or on, but system runs correctly	Reconnect the inverter board Inverter board System board

Power-Related Symptoms

Symptom / Error	Action in Sequence
Power shuts down during operation	Power source (battery pack and power adapter). See "Power System Check" on page 69. Battery pack Power adapter Hard drive & battery connection board System board
The system doesn't power-on.	Power source (battery pack and power adapter). See "Power System Check" on page 69. Battery pack Power adapter Hard drive & battery connection board System board
The system doesn't power-off.	Power source (battery pack and power adapter). See "Power System Check" on page 69. Hold and press the power switch for more than 4 seconds. System board

Power-Related Symptoms

Symptom / Error	Action in Sequence
Battery can't be charged	See "Check the Battery Pack" on page 71. Battery pack System board

PCMCIA-Related Symptoms

Symptom / Error	Action in Sequence
System cannot detect the PC Card (PCMCIA)	PCMCIA slot assembly System board
PCMCIA slot pin is damaged.	PCMCIA slot assembly

Memory-Related Symptoms

Symptom / Error	Action in Sequence
Memory count (size) appears different from actual size.	Enter BIOS Setup Utility to execute "Load Default Settings, then reboot system. DIMM System board

Speaker-Related Symptoms

Symptom / Error	Action in Sequence
In Windows, multimedia programs, no sound comes from the computer.	Audio driver Speaker System board
Internal speakers make noise or emit no sound.	Speaker System board

Power Management-Related Symptoms

Symptom / Error	Action in Sequence
The system will not enter hibernation	See "Save to Disk (S4)" on page 42. Keyboard (if control is from the keyboard) Hard disk drive System board
The system doesn't enter hibernation mode and four short beeps every minute.	Press Fn+  and see if the computer enters hibernation mode. Touchpad Keyboard Hard disk connection board Hard disk drive System board
The system doesn't enter standby mode after closing the LCD	See "Save to Disk (S4)" on page 42. LCD cover switch System board
The system doesn't resume from hibernation mode.	See "Save to Disk (S4)" on page 42. Hard disk connection board Hard disk drive System board
The system doesn't resume from standby mode after opening the LCD.	See "Save to Disk (S4)" on page 42. LCD cover switch System board

Power Management-Related Symptoms

Symptom / Error	Action in Sequence
Battery fuel gauge in Windows doesn't go higher than 90%.	Remove battery pack and let it cool for 2 hours. Refresh battery (continue use battery until power off, then charge battery). Battery pack System board
System hangs intermittently.	Reconnect hard disk/CD-ROM drives. Hard disk connection board System board

Peripheral-Related Symptoms

Symptom / Error	Action in Sequence
System configuration does not match the installed devices.	Enter BIOS Setup Utility to execute "Load Default Settings", then reboot system. Reconnect hard disk/CD-ROM/diskette drives.
External display does not work correctly.	Press Fn+F5, LCD/CRT/Both display switching System board
USB does not work correctly	System board
Print problems.	Ensure the "Parallel Port" in the "Onboard Devices Configuration" of BIOS Setup Utility is set to Enabled. Onboard Devices Configuration Run printer self-test. Printer driver Printer cable Printer System Board
Serial or parallel port device problems.	Ensure the "Serial Port" in the Devices Configuration" of BIOS Setup Utility is set to Enabled. Device driver Device cable Device System board

Keyboard/Touchpad-Related Symptoms

Symptom / Error	Action in Sequence
Keyboard (one or more keys) does not work.	Reconnect the keyboard cable. Keyboard System board
Touchpad does not work.	Reconnect touchpad cable. Touchpad board System board

Modem-Related Symptoms

Symptom / Error	Action in Sequence
Internal modem does not work correctly.	Modem phone port modem combo board System board

NOTE: If you cannot find a symptom or an error in this list and the problem remains, see "Undetermined Problems" on page 84.

Intermittent Problems

Intermittent system hang problems can be caused by a variety of reasons that have nothing to do with a hardware defect, such as: cosmic radiation, electrostatic discharge, or software errors. FRU replacement should be considered only when a recurring problem exists.

When analyzing an intermittent problem, do the following:

1. Run the advanced diagnostic test for the system board in loop mode at least 10 times.
2. If no error is detected, do not replace any FRU.
3. If any error is detected, replace the FRU. Rerun the test to verify that there are no more errors.

Undetermined Problems

The diagnostic problems does not identify which adapter or device failed, which installed devices are incorrect, whether a short circuit is suspected, or whether the system is inoperative.

Follow these procedures to isolate the failing FRU (do not isolate non-defective FRU).

NOTE: Verify that all attached devices are supported by the computer.

NOTE: Verify that the power supply being used at the time of the failure is operating correctly. (See "Power System Check" on page 69.):

1. Power-off the computer.
2. Visually check them for damage. If any problems are found, replace the FRU.
3. Remove or disconnect all of the following devices:
 - Non-Acer devices
 - Printer, mouse, and other external devices
 - Battery pack
 - Hard disk drive
 - DIMM
 - CD-ROM/Diskette drive Module
 - PC Cards
4. Power-on the computer.
5. Determine if the problem has changed.
6. If the problem does not recur, reconnect the removed devices one at a time until you find the failing FRU.
7. If the problem remains, replace the following FRU one at a time. Do not replace a non-defective FRU:
 - System board
 - LCD assembly

Jumper and Connector Locations

Board Layout

Top View

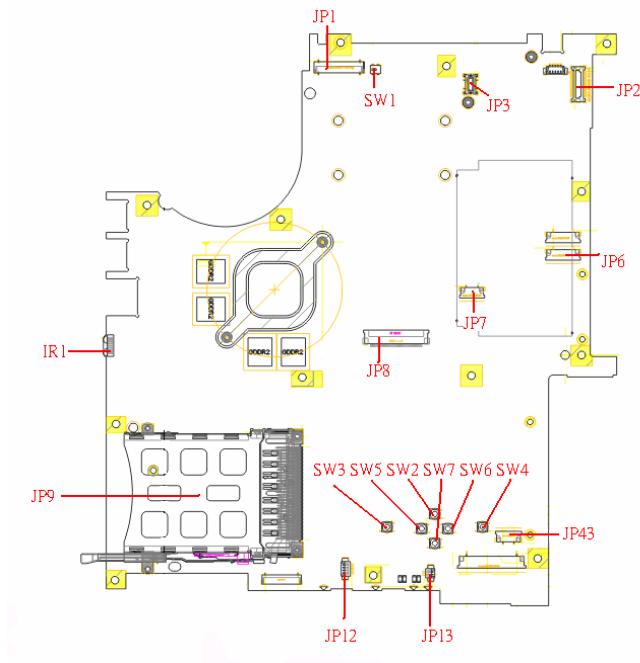

1	JP1	LCD Connector	10	SW7	Touchpad Down Button
2	SW1	Lid Switch	11	SW2	Touchpad Up Button
3	JP3	MDC Connector	12	SW5	Touchpad Left Button
4	JP2	Power Button Connector	13	SW3	Touchpad Left Button
5	JP6	Media Board Connector	14	JP13	Internal Microphone Connector
6	JP7	Touchpad Board Connector	15	JP12	Internal Speaker Connector
7	JP43	SIM Card Connector	16	JP9	PCMCIA Socket
8	SW4	Touchpad Right Button	17	IR1	FIR Module
9	SW6	Touchpad Left Button	18	JP8	Internal Keyboard Connector

Bottom View

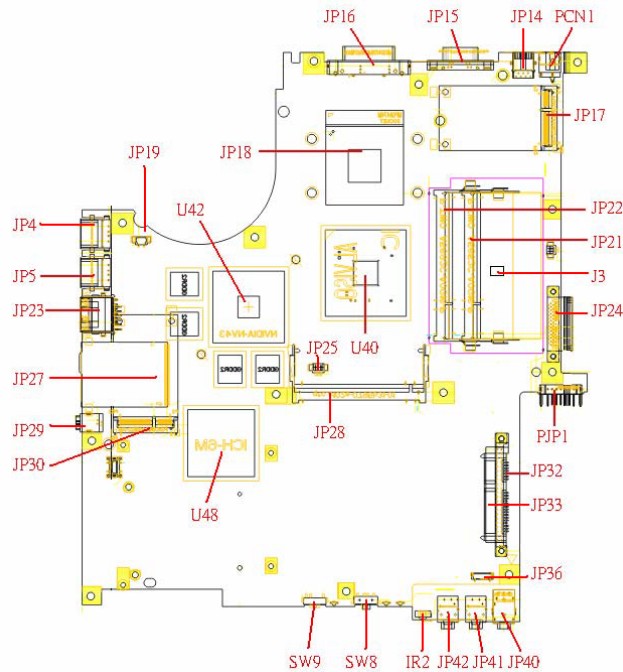

NOTE: This is engineering sample. The image above may not be exactly the same as the real main board you get.

1	JP19	FAN Connector	17	JP40	Headphone/SPDIF Jack
2	U42	VGA Chipset	18	JP41	Line-In Jack
3	JP18	CPU Socket	19	JP42	Microphone-in Jack
4	JP16	DVI Connector	20	IR2	CIR Module
5	JP15	CRT Connector	21	SW8	Wireless LAN Switch
6	JP14	TV-Out Connector	22	SW9	Bluetooth and 3G Switch
7	PCN1	DC-IN Jack	23	U48	South Bridge Chipset
8	JP17	Mini Card Connector	24	JP30	Mini Card Connector
9	JP22	DDRII so-DIMM Socket	25	JP29	IEEE 1394 Connector
10	JP21	DDRII so-DIMM Socket	26	JP27	5 IN1 Socket
11	J3	Clear CMOS Jumper	27	JP23	RJ45 Connector
12	JP24	ODD Connector	28	JP5	USB Connector
13	PJP1	Battery Connector	29	JP4	USB Connector
14	JP32	HDD Connector (SATA)	30	JP28	MINIPCI Connector (TV-Tuner)
15	JP33	HDD Connector (PATA)	31	JP25	FAN Connector
16	JP36	Bluetooth Connector	32	U40	North Bridge Chipset

Jumper Board Layout

Switch Board Top View

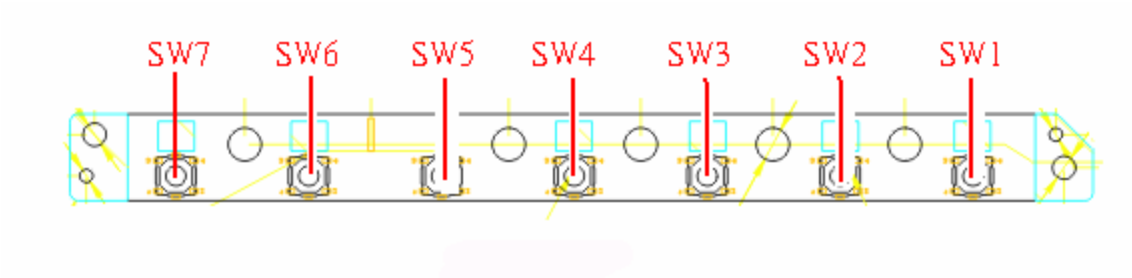

Label	Description
SW1	Arcade/TV tunver switch
SW2	Volume Up switch
SW3	Volume Down switch
SW4	Play/Pause switch
SW5	Stop switch
SW6	Forward/Next switch
SW7	Backward/Previous switch

Media Board Top View

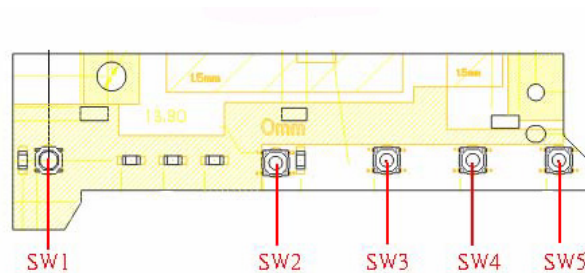

Label	Description
SW1	Power Button
SW2	E-mail Button
SW3	Internet Button
SW4	User Button
SW5	E-Power Button

Media Board Bottom View

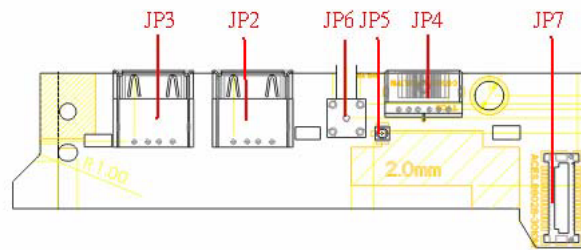

Label	Description
JP3	USB Connector
JP2	USB Connector
JP6	RF INe Connector
JP5	RF Cable Connector
JP4	AV IN Connector
JP7	Board to Main Board Connector

LS-2923P Power Board Top View

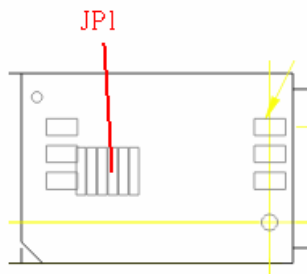

Label	Description
JP1	SIM Card Connector

Jumper Setting

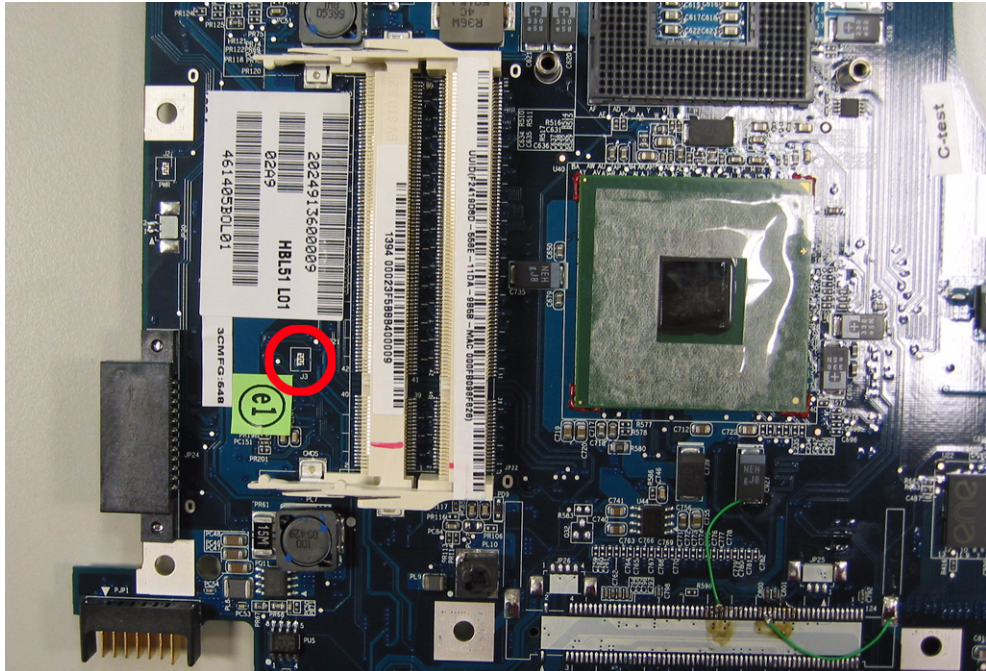

Label	Description
J3	Clear CMOS Jumper Note: J3 locates at bottom side of the main board as the red circle highlighted.

FRU (Field Replaceable Unit) List

This chapter gives you the FRU (Field Replaceable Unit) list in global configurations of Aspire 5680/5630/3690/Travelmate 4280/4230/2490. Please refer to this chapter whenever ordering for parts to repair or for RMA (Return Merchandise Authorization).

Please note that WHEN ORDERING FRU PARTS, you should check the most up-to-date information available on your regional web or channel. For whatever reasons a part number change is made, it will not be noted on the printed Service Guide. For ACER AUTHORIZED SERVICE PROVIDERS, your Acer office may have a DIFFERENT part number code from those given in the FRU list of this printed Service Guide. You MUST use the local FRU list provided by your regional Acer office to order FRU parts for repair and service of customer machines.





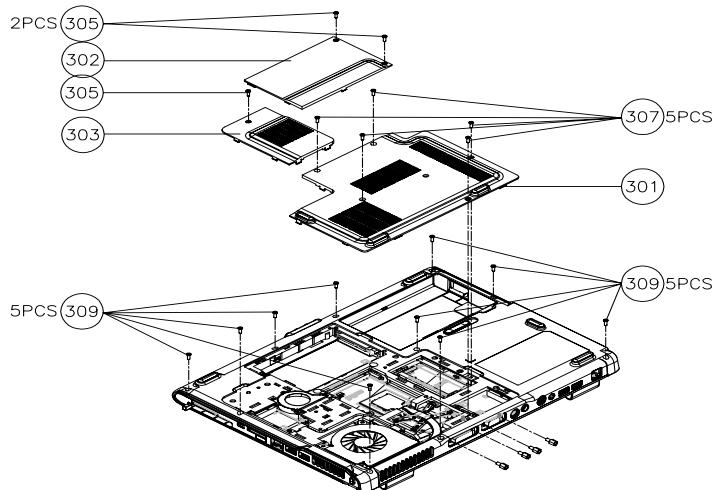
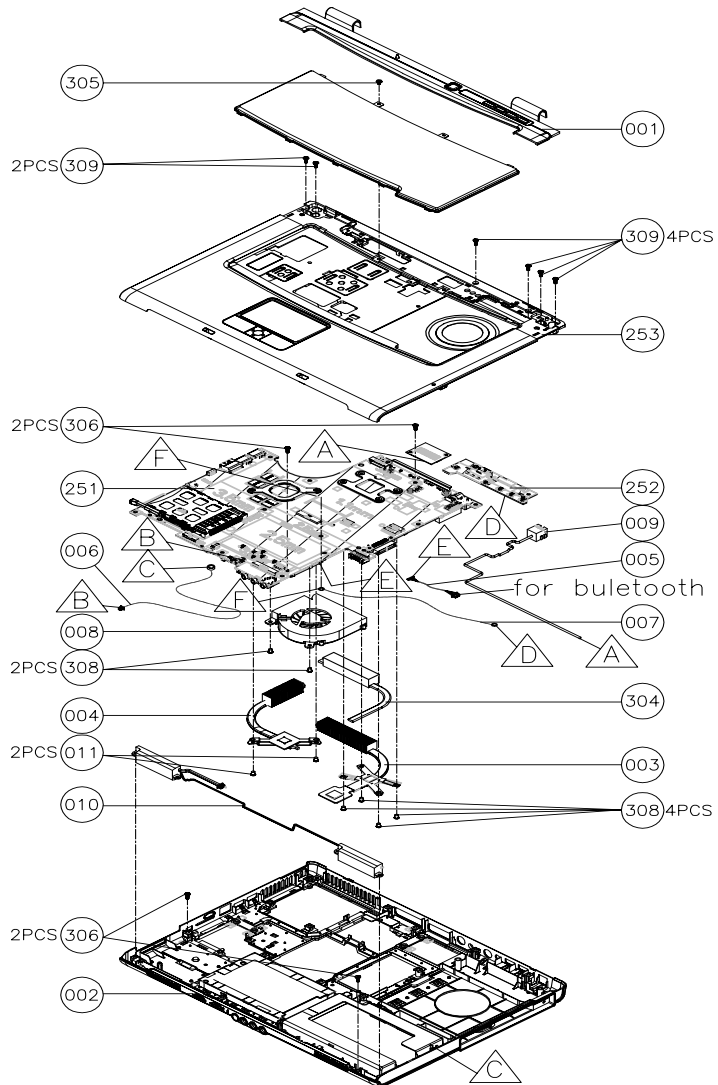



NOTE: To scrap or to return the defective parts, you should follow the local government ordinance or regulations on how to dispose it properly, or follow the rules set by your regional Acer office on how to return it.



Exploded Diagram





CATEGORY	PARTNAME	DESCRIPTION	Acer PN
ADAPTER			
	ADAPTER 90W 3PIN DELTA ADP-90SB BBAC	ADAPTER 90W 3PIN DELTA ADP-90SB BBAC	AP.09001.003
	ADAPTER 90W 3PIN LITEON PA-1900-04LR	ADAPTER 90W 3PIN LITEON PA-1900-04LR	AP.09003.006
	ADAPTER 90W 3PIN LISHIN SLS0202C19A20LF	ADAPTER 90W 3PIN LISHIN SLS0202C19A20LF	AP.09006.004
BATTERY			
	BATTERY LI-ION 6 CELLS 4000MAH SANYO	BATTERY LI-ION 6 CELLS 4000MAH SANYO	BT.00603.017
	BATTERY LI-ION 6 CELLS 4000MAH PANASONIC	BATTERY LI-ION 6 CELLS 4000MAH PANASONIC	BT.00605.004
	BATTERY LI-ION 6 CELLS 4000MAH SONY	BATTERY LI-ION 6 CELLS 4000MAH SONY	BT.00604.008
BOARD			
	MODEM BOARD FOXCONN T60M845.02	MODEM BOARD FOXCONN T60M845.02	54.TAVV5.001
	BLUETOOTH MODULE FOXCONN T60H928.00 (BRM2045)	BLUETOOTH MODULE FOXCONN T60H928.00 (BRM2045)	54.TAVV5.002
	MINI PCI WIRELESS BOARD 802.11 A/B/G MOW1 INTEL MM872612	MINI PCI WIRELESS BOARD 802.11 A/B/G MOW1 INTEL MM872612	KI.GLN01.001
	MINI PCI WIRELESS BOARD 802.11 A/B/G MOW2 INTEL MM872659	MINI PCI WIRELESS BOARD 802.11 A/B/G MOW2 INTEL MM872659	KI.GLN01.002
	MINI PCI WIRELESS BOARD 802.11 A/B/G ROW INTEL MM874511	MINI PCI WIRELESS BOARD 802.11 A/B/G ROW INTEL MM874511	KI.GLN01.003
	MINI PCI WIRELESS BOARD 802.11 A/B/G JPN	MINI PCI WIRELESS BOARD 802.11 A/B/G JPN	KI.GLN01.004
	SWITCH BOARD W/O TV AS/TM	SWITCH BOARD W/O TV AS/TM	55.TAVV5.001
	SIM BOARD W/FFC	SIM BOARD W/FFC	55.TAVV5.002
	INVERTER BOARD - 15 IN.	INVERTER BOARD - 15 IN.	19.TAVV5.001
	INVERTER BOARD - 15.4 IN.	INVERTER BOARD - 15.4 IN.	19.TAVV5.002
N/A	EXPRESS CARD	EXPRESS CARD	55.TAVV5.003
CABLE			
	FFC CABLE - T/P TO MB	FFC CABLE - T/P TO MB	50.TAVV5.001

CATEGORY	PARTNAME	DESCRIPTION	Acer PN
	RJ-11 CABLE	RJ-11 CABLE	50.TAVV5.002
	BLUETOOTH CABLE	BLUETOOTH CABLE	50.TAVV5.003
	LCD WIRESET - 15 IN.	LCD WIRESET - 15 IN.	50.TAVV5.004
	LCD WIRESET - 15.4	LCD WIRESET - 15.4	50.TAVV5.005
N/A	POWER CORD US 3 PIN	POWER CORD US 3 PIN	27.TAVV5.001
	POWER CORD EU 3 PIN	POWER CORD EU 3 PIN	27.TAVV5.002
	POWER CORD AUS 3 PIN	POWER CORD AUS 3 PIN	27.TAVV5.003
	POWER CORD UK 3 PIN	POWER CORD UK 3 PIN	27.TAVV5.004
	POWER CORD CHINA 3 PIN	POWER CORD CHINA 3 PIN	27.TAVV5.005
	POWER CORD SWISS 3 PIN	POWER CORD SWISS 3 PIN	27.TAVV5.006
	POWER CORD ITALIAN 3 PIN	POWER CORD ITALIAN 3 PIN	27.TAVV5.007
	POWER CORD DENMARK 3 PIN	POWER CORD DENMARK 3 PIN	27.TAVV5.008
	POWER CORD JP 3 PIN	POWER CORD JP 3 PIN	27.TAVV5.009
	POWER CORD SOUTH AFRICA 3 PIN	POWER CORD SOUTH AFRICA 3 PIN	27.TAVV5.010
	POWER CORD KOERA 3 PIN	POWER CORD KOERA 3 PIN	27.TAVV5.011
	POWER CORD ISRAEL 3 PIN	POWER CORD ISRAEL 3 PIN	27.TAVV5.012
	POWER CORD INDIA 3 PIN	POWER CORD INDIA 3 PIN	27.TAVV5.013
	POWER CORD TWN 3 PIN	POWER CORD TWN 3 PIN	27.TAVV5.014
CASE/COVER/BRACKET ASSEMBLY			
	MIDDLE COVER TM	MIDDLE COVER TM	42.TAVV5.001
	UPPER CASE TM W/O TV	UPPER CASE TM W/O TV	60.TAVV5.001
	LOWER CASE W/O CARD 1394 FIR DVI TV	LOWER CASE W/O CARD 1394 FIR DVI TV	60.TAVV5.002
	THERMAL DOOR	THERMAL DOOR	42.TAVV5.002
	MINI DOOR	MINI DOOR	42.TAVV5.003
	T/P BRACKET W/MYLAR	T/P BRACKET W/MYLAR	33.TAVV5.001

CATEGORY	PARTNAME	DESCRIPTION	Acer PN
	OPTICAL BRACKET	OPTICAL BRACKET	33.TAVV5.002
	HDD DOOR TM	HDD DOOR TM	42.TAVV5.004
	HDD BRACKET	HDD BRACKET	33.TAVV5.003
	DVD/CDRW COMBO BEZEL	DVD/CDRW COMBO BEZEL	42.TAVV5.005
	DVD DUAL BEZEL	DVD DUAL BEZEL	42.TAVV5.006
	DVD SUPER MULTI BEZEL HLDS	DVD SUPER MULTI BEZEL HLDS	42.TAVV5.010
LCD			
	ASSY LCD MODULE 15 IN. XGA AUO (B150XG02. V4) TM FOR WIRELESS	ASSY LCD MODULE 15 IN. XGA AUO (B150XG02. V4) TM FOR WIRELESS	N/A
	ASSY LCD MODULE 15.4 WXGA TM FOR WIRELESS	ASSY LCD MODULE 15.4 WXGA TM FOR WIRELESS	N/A
	LCD 15 IN. XGA AUO (B150XG02. V4) LF	LCD 15 IN. XGA AUO (B150XG02. V4) LF	LK.15005.010
	LCD 15 IN. XGA QDI QD15XL06 V.3 LF	LCD 15 IN. XGA QDI QD15XL06 V.3 LF	LK.15009.008
	LCD 15 IN. XGA LG LP154X08-TLA2 LF	LCD 15 IN. XGA LG LP154X08-TLA2 LF	LK.15008.019
	LCD 15 IN. XGA CMO N150X3-L09 Rev. C1 LF	LCD 15 IN. XGA CMO N150X3-L09 Rev. C1 LF	LK.1500D.013
	LCD 15 IN. XGA SAMSUNG LTN150XB-L03-V LF	LCD 15 IN. XGA SAMSUNG LTN150XB-L03-V LF	LK.15006.008
	LCD 15.4 WXGA LG LP154W01-TLA1 LF	LCD 15.4 WXGA LG LP154W01-TLA1 LF	LK.15408.013
	LCD 15.4 WXGA SAMSUNG LTN154X3-L01-100 LF	LCD 15.4 WXGA SAMSUNG LTN154X3-L01-100 LF	LK.15406.014
	LCD 15.4 WXGA AUO B154EW01 V.8 LF	LCD 15.4 WXGA AUO B154EW01 V.8 LF	LK.15405.005
	LCD 15.4 WXGA CMO N154I1-L0B Rev. C1 LF	LCD 15.4 WXGA CMO N154I1-L0B Rev. C1 LF	LK.1540D.005
	LCD 15.4 WXGA QDI QD15TL07-01 LF	LCD 15.4 WXGA QDI QD15TL07-01 LF	LK.15409.008
	LCD PANEL 15 IN. WITH LOGO W/15 IN. ANTENNA TM	LCD PANEL 15 IN. WITH LOGO W.15 IN. ANTENNA TM	60.TAVV5.003
	LCD PANEL 15.4 IN. WITH LOGO W/ 15.4 IN. ANTENNA TM	LCD PANEL 15.4 IN. WITH LOGO W/ 15.4 IN. ANTENNA TM	60.TAVV5.005
	LCD BEZEL - 15 IN.	LCD BEZEL - 15 IN.	60.TAVV5.004
	LCD BEZEL - 15.4 TEXTURE	LCD BEZEL - 15.4 TEXTURE	60.TAVV5.006
	LCD BRACKET SET (R&L) - 15	LCD BRACKET SET (R&L) - 15	6K.TAVV5.001
	LCD BRACKET SET (R&L) - 15.4	LCD BRACKET SET (R&L) - 15.4	6K.TAVV5.003

CATEGORY	PARTNAME	DESCRIPTION	Acer PN
COMMUNICATION MODULE			
	WIRELESS ANTENNA 15 IN.	WIRELESS ANTENNA 15 IN.	50.TAVV5.011
	WIRELESS ANTENNA 15.4 IN.	WIRELESS ANTENNA 15.4 IN.	50.TAVV5.012
MISCELLANEOUS			
N/A	LCD RUBBER	LCD RUBBER	47.TAVV5.001
	LATCH RUBBER	LATCH RUBBER	47.TAVV5.006
	LCD SCREW PAD	LCD SCREW PAD	47.TAVV5.002
CPU/PROCESSOR			
N/A	CPU INTEL YONAH FSB-667 DUAL CORE 2.16G 2M	CPU INTEL YONAH FSB-667 DUAL CORE 2.16G 2M	KC.26001.DTP
	CPU INTEL YONAH FSB-667 DUAL CORE 2.0G 2M	CPU INTEL YONAH FSB-667 DUAL CORE 2.0G 2M	KC.25001.DTP
	CPU INTEL YONAH FSB-667 DUAL CORE 1.83G 2M	CPU INTEL YONAH FSB-667 DUAL CORE 1.83G 2M	KC.24001.DTP
	CPU INTEL YONAH FSB-667 DUAL CORE 1.66G 2M	CPU INTEL YONAH FSB-667 DUAL CORE 1.66G 2M	KC.23001.DTP
OPTICAL DRIVE			
	DVD/CDRW COMBO MODULE	DVD/CDRW COMBO MODULE	N/A
	DVD/CDRW COMBO DRIVE PANASONIC UJDA-770 LF	DVD/CDRW COMBO DRIVE PANASONIC UJDA-770 LF	KO02406.13
	DVD/CDRW COMBO DRIVE HLDS GCC-4244N LF	DVD/CDRW COMBO DRIVE HLDS GCC-4244N LF	KO.0240A.005
	DVD DUAL MODULE TRAY IN	DVD DUAL MODULE TRAY IN	N/A
	DVD DUAL DRIVE PIONEER DVR-K16RA TRAY IN	DVD DUAL DRIVE PIONEER DVR-K16RA TRAY IN	KU.00805.023
	DVD DUAL DRIVE PANASONIC UJ-850B TRAY IN	DVD DUAL DRIVE PANASONIC UJ-850B TRAY IN	KU.00807.022
	DVD DUAL DRIVE LITEON SOSW-833S TRAY IN	DVD DUAL DRIVE LITEON SOSW-833S TRAY IN	KU.00804.019
	DVD DUAL DRIVE HLDS GWA-4082N TRAY IN	DVD DUAL DRIVE HLDS GWA-4082N TRAY IN	KU0080D.019
	DVD SUPER MULTI MODULE HLDS GSA-4028N TRAY IN	DVD SUPER MULTI MODULE HLDS GSA-4028N TRAY IN	N/A
DVD SUPER MULTI DRIVE HLDS GSA-4028N TRAY IN	DVD SUPER MULTI DRIVE HLDS GSA-4028N TRAY IN	KU.0080D.017	
HDD/HARD DISK DRIVE			
	HDD PATA 80G 5400RPM SEAGATE MERCURY2 ST98823A FW:3.04 (ROHS)	HDD PATA 80G 5400RPM SEAGATE MERCURY2 ST98823A FW:3.04 (ROHS)	KH.08001.014
	HDD PATA 80G 5400RPM HGST MORAGA+ HTS541080G9AT00 FW:A56J (ROHS)	HDD PATA 80G 5400RPM HGST MORAGA+ HTS541080G9AT00 FW:A56J (ROHS)	KH.08007.013
	HDD PATA 80G 5400RPM WD ML40 WD800-22HCTO (ROHS)	HDD PATA 80G 5400RPM WD ML40 WD800-22HCTO (ROHS)	KH.08008.027
KEYBOARD			

CATEGORY	PARTNAME	DESCRIPTION	Acer PN
	KEYBOARD DARFON CHINESE TM	KEYBOARD DARFON CHINESE TM	KB.TNT07.001
	KEYBOARD DARFON THAILAND TM	KEYBOARD DARFON THAILAND TM	KB.TNT07.003
	KEYBOARD DARFON HEBREW TM	KEYBOARD DARFON HEBREW TM	KB.TNT07.023
	KEYBOARD DARFON KOREA TM	KEYBOARD DARFON KOREA TM	TBA
	KEYBOARD DARFON ARABIAN TM	KEYBOARD DARFON ARABIAN TM	KB.TNT07.018
	KEYBOARD DARFON US INTERNATIONAL TM	KEYBOARD DARFON US INTERNATIONAL TM	KB.TNT07.002
	KEYBOARD DARFON RUSSIA TM	KEYBOARD DARFON RUSSIA TM	KB.TNT07.014
	KEYBOARD DARFON GREEK TM	KEYBOARD DARFON GREEK TM	KB.TNT07.021
	KEYBOARD DARFON CZECH REPUBLIC TM	KEYBOARD DARFON CZECH REPUBLIC TM	KB.TNT07.012
	KEYBOARD DARFON UK TM	KEYBOARD DARFON UK TM	KB.TNT07.005
	KEYBOARD DARFON SWEDEN TM	KEYBOARD DARFON SWEDEN TM	KB.TNT07.015
	KEYBOARD DARFON FRENCH TM	KEYBOARD DARFON FRENCH TM	KB.TNT07.007
	KEYBOARD DARFON PORTUGUESE TM	KEYBOARD DARFON PORTUGUESE TM	KB.TNT07.011
	KEYBOARD DARFON SWISS/G TM	KEYBOARD DARFON SWISS/G TM	KB.TNT07.008
	KEYBOARD DARFON DENMARK TM	KEYBOARD DARFON DENMARK TM	KB.TNT07.017
	KEYBOARD DARFON ITALIAN TM	KEYBOARD DARFON ITALIAN TM	KB.TNT07.006
	KEYBOARD DARFON BELGIUM TM	KEYBOARD DARFON BELGIUM TM	KB.TNT07.009
	KEYBOARD DARFON GERMAN TM	KEYBOARD DARFON GERMAN TM	KB.TNT07.004
	KEYBOARD DARFON CANADA FRANCH TM	KEYBOARD DARFON CANADA FRANCH TM	KB.TNT07.020
	KEYBOARD DARFON NORWAY TM	KEYBOARD DARFON NORWAY TM	KB.TNT07.016
KEYBOARD DARFON HUNGARY TM	KEYBOARD DARFON HUNGARY TM	KB.TNT07.013	
KEYBOARD DARFON SPANISH TM	KEYBOARD DARFON SPANISH TM	KB.TNT07.010	
KEYBOARD DARFON TURKEY TM	KEYBOARD DARFON TURKEY TM	KB.TNT07.022	
LCD			
N/A	ASSY LCD MODULE 15 IN. XGA AUO (B150XG02. V4) TM FOR WIRELESS	ASSY LCD MODULE 15 IN. XGA AUO (B150XG02. V4) TM FOR WIRELESS	N/A
	ASSY LCD MODULE 15.4 WXGA TM FOR WIRELESS	ASSY LCD MODULE 15.4 WXGA TM FOR WIRELESS	N/A
MAINBOARD			
	MAINBOARD 945GM UMA 10/100 W/ O EXPRESS CARD, CARD READER, CPU, MEMORY	MAINBOARD 945GM UMA 10/100 W/ O EXPRESS CARD, CARD READER, CPU, MEMORY	MB.A9302.001
PCMCIA SLOT/PC CARD SLOT			
N/A	PCMCIA SOCKET	PCMCIA SOCKET	22.TAVV5.001
MEMORY			

CATEGORY	PARTNAME	DESCRIPTION	Acer PN
	MEMORY 512MB DDR II 533 NANYA NT512T64UHA1FN-37B	MEMORY 512MB DDR II 533 NANYA NT512T64UHA1FN-37B	KN.51203.023
	MEMORY 512MB DDR II 533 INFINEON HYS64T64020HDL-3.7-A	MEMORY 512MB DDR II 533 INFINEON HYS64T64020HDL-3.7-A	KN.51202.021
	MEMORY 512MB DDR II 533 MICRON MT8HTF6464HDY-53EB3	MEMORY 512MB DDR II 533 MICRON MT8HTF6464HDY-53EB3	KN.51204.019
	MEMORY 512MB DDR II 533 SAMSUNG M470T6554CZ3-CD500	MEMORY 512MB DDR II 533 SAMSUNG M470T6554CZ3-CD500	KN.5120B.015
	MEMORY 512MB DDR II 533 HYNIX HYMP564S64P6-C4	MEMORY 512MB DDR II 533 HYNIX HYMP564S64P6-C4	KN.5120G.005
FAN			
	FAN ASSY - UMA	FAN ASSY - UMA	23.TAVV5.001
HEATSINK			
	THERMAL MODULE - CPU	THERMAL MODULE - CPU	60.TAVV5.009
MISCELLANEOUS			
N/A	NAME PLATE - TM4200	NAME PLATE - TM4200	40.TAVV5.001
	RUBBER FOOT - LARGE	RUBBER FOOT - LARGE	47.TAVV5.003
	RUBBER FOOT - MIDDLE	RUBBER FOOT - MIDDLE	47.TAVV5.004
	RUBBER FOOT - SMALL	RUBBER FOOT - SMALL	47.TAVV5.005
	LATCH RUBBER	LATCH RUBBER	47.TAVV5.006
	THERMAL DOOR RUBBER	THERMAL DOOR RUBBER	47.TAVV5.007
POINTING DEVICE			
	TOUCHPAD W/SPONGE	TOUCHPAD W/SPONGE	56.TAVV5.001
SPEAKER			
	SPEAKER SET (R&L)	SPEAKER SET (R&L)	23.TAVV5.002
	MIC	MIC	23.TAVV5.003
SCREW			

CATEGORY	PARTNAME	DESCRIPTION	Acer PN
N/A	SCREW M2.5*3(NL)	SCREW M2.5*3(NL)	86.TAVV5.001
	SCREW M2.5*6(NL)	SCREW M2.5*6(NL)	86.TAVV5.002
	SCREW M2.5*10(NL)	SCREW M2.5*10(NL)	86.TAVV5.003
	SCREW M2.5*15(NL)	SCREW M2.5*15(NL)	86.TAVV5.004
	SCREW M2*2.2	SCREW M2*2.2	86.TAVV5.005
	SCREW M2*3(NL)	SCREW M2*3(NL)	86.TAVV5.006
	SCREW M2*4	SCREW M2*4	86.TAVV5.007
	SCREW M3*4(NL)	SCREW M3*4(NL)	86.TAVV5.008
	SCREW D-SUB 4#X40* 1/5-NI (NL)	SCREW D-SUB 4#X40* 1/5-NI (NL)	86.TAVV5.009

Model Definition and Configuration

Aspire 5680/5630/3690 Series

Aspire 5680

Model	Country	Description	HDD 1 (GB)	ODD	Card Reader	Wireless LAN	Bluetooth
AS5683 WLMi	France	AS5683WLMi XPHFRA NB7PSE128SG 2*512/100/8L/5R/CB_abg	N100GB5.4 KS	NSM8XSL OT	5 in 1-Build in	INT3945AB G_MOW2	N
AS5683 WLMi	Germany	AS5683WLMi XPHDE7 NB7PSE128SG 2*512/100/8L/5R/CB_abg	N100GB5.4 KS	NSM8XSL OT	5 in 1-Build in	INT3945AB G_MOW2	N
AS5683 WLMi	Spain	AS5683WLMi XPHESA NB7PSE128SG 2*512/100/8L/5R/CB_abg	N100GB5.4 KS	NSM8XSL OT	5 in 1-Build in	INT3945AB G_MOW2	N
AS5683 WLMi	Italy	AS5683WLMi XPHIT1 NB7PSE128SG 2*512/100/8L/5R/CB_abg	N100GB5.4 KS	NSM8XSL OT	5 in 1-Build in	INT3945AB G_MOW2	N
AS5683 WLMi	Italy	AS5683WLMi XPHWIT21W NB7PSE128SG 2*512/100/8L/5R/CB_abg	N100GB5.4 KS	NSM8XSL OT	5 in 1-Build in	INT3945AB G_MOW2	N
AS5683 WLMi	UK	AS5683WLMi XPHUK1 NB7PSE128SG 2*512/100/8L/5R/CB_abg	N100GB5.4 KS	NSM8XSL OT	5 in 1-Build in	INT3945AB G_MOW2	N
AS5683 WLMi	UK	AS5683WLMi XPHWUK21W NB7PSE128SG 2*512/100/8L/5R/CB_abg	N100GB5.4 KS	NSM8XSL OT	5 in 1-Build in	INT3945AB G_MOW2	N
AS5683 WLMi	France	AS5683WLMi XPHWFRB1W NB7PSE128SG 2*512/100/8L/5R/CB_abg	N100GB5.4 KS	NSM8XSL OT	5 in 1-Build in	INT3945AB G_MOW2	N
AS5685 WLMi	Philippines	AS5685WLMi XPHPH1 NB7PSE128SG 2*512/120/BT/8L/5R/CB_abg	N120GB5.4 KS	NSM8XSL OT	5 in 1-Build in	INT3945AB G_MOW1	FOX_BRM_2.0
AS5685 WLMi	Philippines	AS5685WLMi XPHPH1 NB7PSE128SG 2*512/120/8L/5R/CB_abg	N120GB5.4 KS	NSM8XSL OT	5 in 1-Build in	INT3945AB G_MOW2	N
AS5684 WLMi	Italy	AS5684WLMi MCEIT7 NB7PSE128SG 2*1G/160/BT/8L/5R/CB_abg	N160GB5.4 KS	NSM8XSL OT	5 in 1-Build in	INT3945AB G_MOW2	FOX_BRM_2.0
AS5684 WLMi	France	AS5684WLMi MCEFRF NB7PSE128SG 2*512/120/8L/5R/CB_abg	N120GB5.4 KS	NSM8XSL OT	5 in 1-Build in	INT3945AB G_MOW2	N
AS5683 WLMi	Spain	AS5683WLMi XPHESA NB7PSE128SG 2*512/120/BT/8L/5R/CB_abg	N120GB5.4 KS	NSM8XSL OT	5 in 1-Build in	INT3945AB G_MOW2	FOX_BRM_2.0
AS5683 WLMi	France	AS5683WLMi XPHFRA NB7PSE128SG 2*512/120/8L/5R/CB_abg	N120GB5.4 KS	NSM8XSL OT	5 in 1-Build in	INT3945AB G_MOW2	N

Aspire 5680

Model	Country	Description	HDD 1 (GB)	ODD	Card Reader	Wireless LAN	Bluetooth
AS5683 WLMi	Spain	AS5683WLMi XPHESA NB7PSE128SG 2*512/120/ 8L/5R/CB_abg	N120GB5.4 KS	NSM8XSL OT	5 in 1-Build in	INT3945AB G_MOW2	N
AS5683 WLMi	Italy	AS5683WLMi XPHIT1 NB7PSE128SG 2*512/120/ 8L/5R/CB_abg	N120GB5.4 KS	NSM8XSL OT	5 in 1-Build in	INT3945AB G_MOW2	N
AS5683 WLMi	Germany	AS5683WLMi XPHDE7 NB7PSE128SG 2*512/120/ 8L/5R/CB_abg	N120GB5.4 KS	NSM8XSL OT	5 in 1-Build in	INT3945AB G_MOW2	N
AS5683 WLMi	Switzerland	AS5683WLMi XPHSW5 NB7PSE128SG 2*512/120/ 8L/5R/CB_abg	N120GB5.4 KS	NSM8XSL OT	5 in 1-Build in	INT3945AB G_MOW2	N
AS5683 WLMi	UK	AS5683WLMi XPHUK1 NB7PSE128SG 2*512/120/ 8L/5R/CB_abg	N120GB5.4 KS	NSM8XSL OT	5 in 1-Build in	INT3945AB G_MOW2	N
AS5683 WLMi	UK	AS5683WLMi XPHWUK21W NB7PSE128SG 2*512/120/ 8L/5R/CB_abg	N120GB5.4 KS	NSM8XSL OT	5 in 1-Build in	INT3945AB G_MOW2	N
AS5683 WLMi	Germany	AS5683WLMi XPHWDE21W NB7PSE128SG 2*512/120/ 8L/5R/CB_abg	N120GB5.4 KS	NSM8XSL OT	5 in 1-Build in	INT3945AB G_MOW2	N
AS5683 WLMi	France	AS5683WLMi XPHWFRB1W NB7PSE128SG 2*512/120/ 8L/5R/CB_abg	N120GB5.4 KS	NSM8XSL OT	5 in 1-Build in	INT3945AB G_MOW2	N
AS5683 WLMi	Italy	AS5683WLMi XPHWIT21W NB7PSE128SG 2*512/120/ 8L/5R/CB_abg	N120GB5.4 KS	NSM8XSL OT	5 in 1-Build in	INT3945AB G_MOW2	N

Aspire 5630

Model	Country	Description	Memory 1	Memory 2	HDD 1 (GB)	Card Reader	Wireless LAN	Bluetooth
AS5633 WLMi	Australia/ New Zealand	AS5633WLMi XPHAU1 G72MV128 1*1G/120/BT/ 8L/5R/CB_abg	SO1GBII 5	N	N120GB 5.4K	5 in 1- Build in	INT3945 ABG_MO W1	FOX_BR M_2.0
AS5633 WLMi	Indonesia	AS5633WLMi XPHIN1 G72MV128 1*1G/120/BT/ 8L/5R/CB_abg	SO1GBII 5	N	N120GB 5.4K	5 in 1- Build in	INT3945 ABG_MO W1	FOX_BR M_2.0
AS5633 WLMi	USA/ Canada - Canadian French	AS5633WLMi MCECF G72MV128 2*512/120/BT/ 8L/5R/CB_abg	SO512M BII5	SO512M BII5	N120GB 5.4K	5 in 1- Build in	INT3945 ABG_MO W1	FOX_BR M_2.0
AS5633 WLMi	USA/ Canada - Canadian French	AS5633WLMi MCEUS G72MV128 2*512/120/BT/ 8L/5R/CB_abg	SO512M BII5	SO512M BII5	N120GB 5.4K	5 in 1- Build in	INT3945 ABG_MO W1	FOX_BR M_2.0
AS5633 WLMi	Australia/ New Zealand	AS5633WLMi MCEAU1 G72MV128 2*512/120/BT/ 8L/5R/CB_abg	SO512M BII5	SO512M BII5	N120GB 5.4K	5 in 1- Build in	INT3945 ABG_MO W1	FOX_BR M_2.0

Aspire 5630

Model	Country	Description	Memory 1	Memory 2	HDD 1 (GB)	Card Reader	Wireless LAN	Bluetooth
AS5633 WLMi	Belgium	AS5633WLMi MCEBE6 G72MV128 2*512/100/6L/5R_abg	SO512M BII5	SO512M BII5	N100GB 5.4K	5 in 1-Build in	INT3945 ABG_MO W2	N
AS5633 WLMi	Eastern Europe	AS5633WLMi MCECS5 G72MV128 2*512/100/6L/5R_abg	SO512M BII5	SO512M BII5	N100GB 5.4K	5 in 1-Build in	INT3945 ABG_MO W2	N
AS5633 WLMi	Spain	AS5633WLMi MCEESJ G72MV128 2*512/100/6L/5R_abg	SO512M BII5	SO512M BII5	N100GB 5.4K	5 in 1-Build in	INT3945 ABG_MO W2	N
AS5633 WLMi	Germany	AS5633WLMi MCEDEB G72MV128 2*512/100/6L/5R_abg	SO512M BII5	SO512M BII5	N100GB 5.4K	5 in 1-Build in	INT3945 ABG_MO W2	N
AS5633 WLMi	Germany	AS5633WLMi MCEDEA G72MV128 2*512/100/6L/5R_abg	SO512M BII5	SO512M BII5	N100GB 5.4K	5 in 1-Build in	INT3945 ABG_MO W2	N
AS5633 WLMi	Denmark	AS5633WLMi MCEDK6 G72MV128 2*512/100/6L/5R_abg	SO512M BII5	SO512M BII5	N100GB 5.4K	5 in 1-Build in	INT3945 ABG_MO W2	N
AS5633 WLMi	France	AS5633WLMi MCEFRF G72MV128 2*512/100/6L/5R_abg	SO512M BII5	SO512M BII5	N100GB 5.4K	5 in 1-Build in	INT3945 ABG_MO W2	N
AS5633 WLMi	Italy	AS5633WLMi MCEIT7 G72MV128 2*512/100/6L/5R_abg	SO512M BII5	SO512M BII5	N100GB 5.4K	5 in 1-Build in	INT3945 ABG_MO W2	N
AS5633 WLMi	Holland	AS5633WLMi MCENL6 G72MV128 2*512/100/6L/5R_abg	SO512M BII5	SO512M BII5	N100GB 5.4K	5 in 1-Build in	INT3945 ABG_MO W1	N
AS5633 WLMi	Norway	AS5633WLMi MCENO5 G72MV128 2*512/100/6L/5R_abg	SO512M BII5	SO512M BII5	N100GB 5.4K	5 in 1-Build in	INT3945 ABG_MO W2	N
AS5633 WLMi	Eastern Europe	AS5633WLMi MCEPL7 G72MV128 2*512/100/6L/5R_abg	SO512M BII5	SO512M BII5	N100GB 5.4K	5 in 1-Build in	INT3945 ABG_MO W2	N
AS5633 WLMi	Slovenia/Croatia	AS5633WLMi MCESI1 G72MV128 2*512/100/6L/5R_abg	SO512M BII5	SO512M BII5	N100GB 5.4K	5 in 1-Build in	INT3945 ABG_MO W2	N
AS5633 WLMi	Portugal	AS5633WLMi MCEPT6 G72MV128 2*512/100/6L/5R_abg	SO512M BII5	SO512M BII5	N100GB 5.4K	5 in 1-Build in	INT3945 ABG_MO W2	N
AS5633 WLMi	Russia	AS5633WLMi MCERU9 G72MV128 2*512/100/6L/5R_abg	SO512M BII5	SO512M BII5	N100GB 5.4K	5 in 1-Build in	INT3945 ABG_MO W2	N
AS5633 WLMi	Sweden/Finland	AS5633WLMi MCESV5 G72MV128 2*512/100/6L/5R_abg	SO512M BII5	SO512M BII5	N100GB 5.4K	5 in 1-Build in	INT3945 ABG_MO W2	N
AS5633 WLMi	Switzerland	AS5633WLMi MCESW8 G72MV128 2*512/100/6L/5R_abg	SO512M BII5	SO512M BII5	N100GB 5.4K	5 in 1-Build in	INT3945 ABG_MO W2	N
AS5633 WLMi	UK	AS5633WLMi MCEUK5 G72MV128 2*512/100/6L/5R_abg	SO512M BII5	SO512M BII5	N100GB 5.4K	5 in 1-Build in	INT3945 ABG_MO W2	N
AS5633 WLMi	Turkey	AS5633WLMi MCETR5 G72MV128 2*512/100/6L/5R_abg	SO512M BII5	SO512M BII5	N100GB 5.4K	5 in 1-Build in	INT3945 ABG_MO W2	N

Aspire 5630

Model	Country	Description	Memory 1	Memory 2	HDD 1 (GB)	Card Reader	Wireless LAN	Bluetooth
AS5633 WLMi	UK	AS5633WLMi MCEWUK1 G72MV128 2*512/100/6L/5R/CB_abg	SO512M BII5	SO512M BII5	N100GB 5.4K	5 in 1-Build in	INT3945 ABG_MO W2	N
AS5633 WLMi	Eastern Europe	AS5633WLMi MCECS5 G72MV128 2*512/100/6L/5R/CB_abg	SO512M BII5	SO512M BII5	N100GB 5.4K	5 in 1-Build in	INT3945 ABG_MO W2	N
AS5633 WLMi	Belgium	AS5633WLMi MCEBE6 G72MV128 2*512/100/6L/5R/CB_abg	SO512M BII5	SO512M BII5	N100GB 5.4K	5 in 1-Build in	INT3945 ABG_MO W2	N
AS5633 WLMi	Germany	AS5633WLMi MCEDEB G72MV128 2*512/100/6L/5R/CB_abg	SO512M BII5	SO512M BII5	N100GB 5.4K	5 in 1-Build in	INT3945 ABG_MO W2	N
AS5633 WLMi	Germany	AS5633WLMi MCEDEA G72MV128 2*512/100/6L/5R/CB_abg	SO512M BII5	SO512M BII5	N100GB 5.4K	5 in 1-Build in	INT3945 ABG_MO W2	N
AS5633 WLMi	Denmark	AS5633WLMi MCEDK6 G72MV128 2*512/100/6L/5R/CB_abg	SO512M BII5	SO512M BII5	N100GB 5.4K	5 in 1-Build in	INT3945 ABG_MO W2	N
AS5633 WLMi	France	AS5633WLMi MCEFRF G72MV128 2*512/100/6L/5R/CB_abg	SO512M BII5	SO512M BII5	N100GB 5.4K	5 in 1-Build in	INT3945 ABG_MO W2	N
AS5633 WLMi	Spain	AS5633WLMi MCEESJ G72MV128 2*512/100/6L/5R/CB_abg	SO512M BII5	SO512M BII5	N100GB 5.4K	5 in 1-Build in	INT3945 ABG_MO W2	N
AS5633 WLMi	Italy	AS5633WLMi MCEIT7 G72MV128 2*512/100/6L/5R/CB_abg	SO512M BII5	SO512M BII5	N100GB 5.4K	5 in 1-Build in	INT3945 ABG_MO W2	N
AS5633 WLMi	Holland	AS5633WLMi MCENL6 G72MV128 2*512/100/6L/5R/CB_abg	SO512M BII5	SO512M BII5	N100GB 5.4K	5 in 1-Build in	INT3945 ABG_MO W1	N
AS5633 WLMi	Norway	AS5633WLMi MCENO5 G72MV128 2*512/100/6L/5R/CB_abg	SO512M BII5	SO512M BII5	N100GB 5.4K	5 in 1-Build in	INT3945 ABG_MO W2	N
AS5633 WLMi	Eastern Europe	AS5633WLMi MCEPL7 G72MV128 2*512/100/6L/5R/CB_abg	SO512M BII5	SO512M BII5	N100GB 5.4K	5 in 1-Build in	INT3945 ABG_MO W2	N
AS5633 WLMi	Portugal	AS5633WLMi MCEPT6 G72MV128 2*512/100/6L/5R/CB_abg	SO512M BII5	SO512M BII5	N100GB 5.4K	5 in 1-Build in	INT3945 ABG_MO W2	N
AS5633 WLMi	Slovenia/Croatia	AS5633WLMi MCESI1 G72MV128 2*512/100/6L/5R/CB_abg	SO512M BII5	SO512M BII5	N100GB 5.4K	5 in 1-Build in	INT3945 ABG_MO W2	N
AS5633 WLMi	Russia	AS5633WLMi MCERU9 G72MV128 2*512/100/6L/5R/CB_abg	SO512M BII5	SO512M BII5	N100GB 5.4K	5 in 1-Build in	INT3945 ABG_MO W2	N
AS5633 WLMi	Sweden/Finland	AS5633WLMi MCESV5 G72MV128 2*512/100/6L/5R/CB_abg	SO512M BII5	SO512M BII5	N100GB 5.4K	5 in 1-Build in	INT3945 ABG_MO W2	N
AS5633 WLMi	Turkey	AS5633WLMi MCETR5 G72MV128 2*512/100/6L/5R/CB_abg	SO512M BII5	SO512M BII5	N100GB 5.4K	5 in 1-Build in	INT3945 ABG_MO W2	N
AS5633 WLMi	Switzerland	AS5633WLMi MCESW8 G72MV128 2*512/100/6L/5R/CB_abg	SO512M BII5	SO512M BII5	N100GB 5.4K	5 in 1-Build in	INT3945 ABG_MO W2	N

Aspire 5630

Model	Country	Description	Memory 1	Memory 2	HDD 1 (GB)	Card Reader	Wireless LAN	Bluetooth
AS5633 WLMi	UK	AS5633WLMi MCEUK5 G72MV128 2*512/100/6L/5R/CB_abg	SO512M BII5	SO512M BII5	N100GB 5.4K	5 in 1-Build in	INT3945 ABG_MO W2	N
AS5633 WLMi	Germany	AS5633WLMi MCEWDE1 G72MV128 2*512/100/6L/5R/CB_abg	SO512M BII5	SO512M BII5	N100GB 5.4K	5 in 1-Build in	INT3945 ABG_MO W2	N
AS5633 WLMi	France	AS5633WLMi MCEWFR1 G72MV128 2*512/100/6L/5R/CB_abg	SO512M BII5	SO512M BII5	N100GB 5.4K	5 in 1-Build in	INT3945 ABG_MO W2	N
AS5633 WLMi	Italy	AS5633WLMi MCEWIT1 G72MV128 2*512/100/6L/5R/CB_abg	SO512M BII5	SO512M BII5	N100GB 5.4K	5 in 1-Build in	INT3945 ABG_MO W2	N
AS5633 WLMi	France	AS5633WLMi MCEWFR11W G72MV128 2*512/100/6L/5R/CB_abg	SO512M BII5	SO512M BII5	N100GB 5.4K	5 in 1-Build in	INT3945 ABG_MO W2	N
AS5633 WLMi	Germany	AS5633WLMi MCEWDE11W G72MV128 2*512/100/6L/5R/CB_abg	SO512M BII5	SO512M BII5	N100GB 5.4K	5 in 1-Build in	INT3945 ABG_MO W2	N
AS5633 WLMi	Middle East	AS5633WLMi MCEAR1 G72MV128 2*512/100/6L/5R/CB_bg	SO512M BII5	SO512M BII5	N100GB 5.4K	5 in 1-Build in	INT3945 BG	N
AS5633 WLMi	Middle East	AS5633WLMi MCEAR2 G72MV128 2*512/100/6L/5R/CB_bg	SO512M BII5	SO512M BII5	N100GB 5.4K	5 in 1-Build in	INT3945 BG	N
AS5633 WLMi	Italy	AS5633WLMi MCEWIT11W G72MV128 2*512/100/6L/5R/CB_abg	SO512M BII5	SO512M BII5	N100GB 5.4K	5 in 1-Build in	INT3945 ABG_MO W2	N
AS5633 WLMi	UK	AS5633WLMi MCEWUK11W G72MV128 2*512/100/6L/5R/CB_abg	SO512M BII5	SO512M BII5	N100GB 5.4K	5 in 1-Build in	INT3945 ABG_MO W2	N
AS5633 WLMi	Italy	AS5633WLMi MCEIT7 G72MV128 2*512/80/6L/5R/CB_abg	SO512M BII5	SO512M BII5	N80GB5.4K	5 in 1-Build in	INT3945 ABG_MO W2	N
AS5633 WLMi	Greece	AS5633WLMi XPHL1 G72MV128 2*512/80/6L/5R/CB_abg	SO512M BII5	SO512M BII5	N80GB5.4K	5 in 1-Build in	INT3945 ABG_MO W2	N
AS5634 WLMi	Spain	AS5634WLMi MCEESJ G72MV128 2*512/120/6L/5R/CB_abg	SO512M BII5	SO512M BII5	N120GB 5.4K	5 in 1-Build in	INT3945 ABG_MO W2	N
AS5633 WLMi	Middle East	AS5633WLMi MCEAR1 G72MV128 2*512/120/6L/5R/CB_bg	SO512M BII5	SO512M BII5	N120GB 5.4K	5 in 1-Build in	INT3945 BG	N
AS5633 WLMi	Middle East	AS5633WLMi MCEAR2 G72MV128 2*512/120/6L/5R/CB_bg	SO512M BII5	SO512M BII5	N120GB 5.4K	5 in 1-Build in	INT3945 BG	N
AS5633 WLMi	Eastern Europe	AS5633WLMi MCECS5 G72MV128 2*512/120/6L/5R/CB_abg	SO512M BII5	SO512M BII5	N120GB 5.4K	5 in 1-Build in	INT3945 ABG_MO W2	N
AS5633 WLMi	Belgium	AS5633WLMi MCEBE6 G72MV128 2*512/120/6L/5R/CB_abg	SO512M BII5	SO512M BII5	N120GB 5.4K	5 in 1-Build in	INT3945 ABG_MO W2	N
AS5633 WLMi	Germany	AS5633WLMi MCEDEB G72MV128 2*512/120/6L/5R/CB_abg	SO512M BII5	SO512M BII5	N120GB 5.4K	5 in 1-Build in	INT3945 ABG_MO W2	N

Aspire 5630

Model	Country	Description	Memory 1	Memory 2	HDD 1 (GB)	Card Reader	Wireless LAN	Bluetooth
AS5633 WLMi	Germany	AS5633WLMi MCEDEA G72MV128 2*512/120/6L/5R/CB_abg	SO512M BII5	SO512M BII5	N120GB 5.4K	5 in 1-Build in	INT3945 ABG_MO W2	N
AS5633 WLMi	Spain	AS5633WLMi MCEESJ G72MV128 2*512/120/6L/5R/CB_abg	SO512M BII5	SO512M BII5	N120GB 5.4K	5 in 1-Build in	INT3945 ABG_MO W2	N
AS5633 WLMi	Denmark	AS5633WLMi MCEDK6 G72MV128 2*512/120/6L/5R/CB_abg	SO512M BII5	SO512M BII5	N120GB 5.4K	5 in 1-Build in	INT3945 ABG_MO W2	N
AS5633 WLMi	France	AS5633WLMi MCEFRF G72MV128 2*512/120/6L/5R/CB_abg	SO512M BII5	SO512M BII5	N120GB 5.4K	5 in 1-Build in	INT3945 ABG_MO W2	N
AS5633 WLMi	Holland	AS5633WLMi MCENL6 G72MV128 2*512/120/6L/5R/CB_abg	SO512M BII5	SO512M BII5	N120GB 5.4K	5 in 1-Build in	INT3945 ABG_MO W1	N
AS5633 WLMi	Italy	AS5633WLMi MCEIT7 G72MV128 2*512/120/6L/5R/CB_abg	SO512M BII5	SO512M BII5	N120GB 5.4K	5 in 1-Build in	INT3945 ABG_MO W2	N
AS5633 WLMi	Norway	AS5633WLMi MCENO5 G72MV128 2*512/120/6L/5R/CB_abg	SO512M BII5	SO512M BII5	N120GB 5.4K	5 in 1-Build in	INT3945 ABG_MO W2	N
AS5633 WLMi	Eastern Europe	AS5633WLMi MCEPL7 G72MV128 2*512/120/6L/5R/CB_abg	SO512M BII5	SO512M BII5	N120GB 5.4K	5 in 1-Build in	INT3945 ABG_MO W2	N
AS5633 WLMi	Slovenia/Croatia	AS5633WLMi MCESI1 G72MV128 2*512/120/6L/5R/CB_abg	SO512M BII5	SO512M BII5	N120GB 5.4K	5 in 1-Build in	INT3945 ABG_MO W2	N
AS5633 WLMi	Portugal	AS5633WLMi MCEPT6 G72MV128 2*512/120/6L/5R/CB_abg	SO512M BII5	SO512M BII5	N120GB 5.4K	5 in 1-Build in	INT3945 ABG_MO W2	N
AS5633 WLMi	Russia	AS5633WLMi MCERU9 G72MV128 2*512/120/6L/5R/CB_abg	SO512M BII5	SO512M BII5	N120GB 5.4K	5 in 1-Build in	INT3945 ABG_MO W2	N
AS5633 WLMi	Sweden/Finland	AS5633WLMi MCESV5 G72MV128 2*512/120/6L/5R/CB_abg	SO512M BII5	SO512M BII5	N120GB 5.4K	5 in 1-Build in	INT3945 ABG_MO W2	N
AS5633 WLMi	Turkey	AS5633WLMi MCETR5 G72MV128 2*512/120/6L/5R/CB_abg	SO512M BII5	SO512M BII5	N120GB 5.4K	5 in 1-Build in	INT3945 ABG_MO W2	N
AS5633 WLMi	Switzerland	AS5633WLMi MCESW8 G72MV128 2*512/120/6L/5R/CB_abg	SO512M BII5	SO512M BII5	N120GB 5.4K	5 in 1-Build in	INT3945 ABG_MO W2	N
AS5633 WLMi	UK	AS5633WLMi MCEUK5 G72MV128 2*512/120/6L/5R/CB_abg	SO512M BII5	SO512M BII5	N120GB 5.4K	5 in 1-Build in	INT3945 ABG_MO W2	N
AS5633 WLMi	Italy	AS5633WLMi MCEWIT11W G72MV128 2*512/120/6L/5R/CB_abg	SO512M BII5	SO512M BII5	N120GB 5.4K	5 in 1-Build in	INT3945 ABG_MO W2	N
AS5633 WLMi	Germany	AS5633WLMi MCEWDE11W G72MV128 2*512/120/6L/5R/CB_abg	SO512M BII5	SO512M BII5	N120GB 5.4K	5 in 1-Build in	INT3945 ABG_MO W2	N
AS5633 WLMi	France	AS5633WLMi MCEWFR11W G72MV128 2*512/120/6L/5R/CB_abg	SO512M BII5	SO512M BII5	N120GB 5.4K	5 in 1-Build in	INT3945 ABG_MO W2	N

Aspire 5630

Model	Country	Description	Memory 1	Memory 2	HDD 1 (GB)	Card Reader	Wireless LAN	Bluetooth
AS5633 WLMi	UK	AS5633WLMi MCEWUK11W G72MV128 2*512/120/6L/5R/CB_abg	SO512M BII5	SO512M BII5	N120GB 5.4K	5 in 1- Build in	INT3945 ABG_MO W2	N

Aspire 3690

Model	RO	Description	CPU	LCD	Memory 1	Memory 2	HDD 1 (GB)	Wireless LAN	Bluetooth
AS3692 WLMi	EMEA	AS3692WLMi XPHSA1 UMA 1*512/100/6L/5R/ CB_bg_0.3C_AN	CM420	N15.4W XGAG	SO512 MBII5	N	N100G B5.4K	ABT_B RM431 8BG	N
AS3692 WLMi	EMEA	AS3692WLMi XPHDK1 UMA 1*512/100/6L/5R/ CB_bg_0.3C_AN	CM420	N15.4W XGAG	SO512 MBII5	N	N100G B5.4K	ABT_B RM431 8BG	N
AS3692 WLMi	EMEA	AS3692WLMi XPHBE1 UMA 1*512/100/6L/5R/ CB_bg_0.3C_AN	CM420	N15.4W XGAG	SO512 MBII5	N	N100G B5.4K	ABT_B RM431 8BG	N
AS3692 WLMi	EMEA	AS3692WLMi XPHNL1 UMA 1*512/100/6L/5R/ CB_bg_0.3C_AN	CM420	N15.4W XGAG	SO512 MBII5	N	N100G B5.4K	ABT_B RM431 8BG	N
AS3692 WLMi	EMEA	AS3692WLMi XPHNO1 UMA 1*512/100/6L/5R/ CB_bg_0.3C_AN	CM420	N15.4W XGAG	SO512 MBII5	N	N100G B5.4K	ABT_B RM431 8BG	N
AS3692 WLMi	EMEA	AS3692WLMi XPHRU2 UMA 1*512/100/6L/5R/ CB_bg_0.3C_AN	CM420	N15.4W XGAG	SO512 MBII5	N	N100G B5.4K	ABT_B RM431 8BG	N
AS3692 WLMi	EMEA	AS3692WLMi XPHSV1 UMA 1*512/100/6L/5R/ CB_bg_0.3C_AN	CM420	N15.4W XGAG	SO512 MBII5	N	N100G B5.4K	ABT_B RM431 8BG	N
AS3692 WLMi	EMEA	AS3692WLMi XPHCS2 UMA 1*512/100/6L/5R/ CB_bg_0.3C_AN	CM420	N15.4W XGAG	SO512 MBII5	N	N100G B5.4K	ABT_B RM431 8BG	N
AS3692 WLMi	EMEA	AS3692WLMi XPHHU6 UMA 1*512/100/6L/5R/ CB_bg_0.3C_AN	CM420	N15.4W XGAG	SO512 MBII5	N	N100G B5.4K	ABT_B RM431 8BG	N
AS3692 WLMi	EMEA	AS3692WLMi XPHFRA UMA 1*512/100/6L/5R/ CB_bg_0.3C_AN	CM420	N15.4W XGAG	SO512 MBII5	N	N100G B5.4K	ABT_B RM431 8BG	N
AS3692 WLMi	EMEA	AS3692WLMi XPHPL6 UMA 1*512/100/6L/5R/ CB_bg_0.3C_AN	CM420	N15.4W XGAG	SO512 MBII5	N	N100G B5.4K	ABT_B RM431 8BG	N
AS3692 WLMi	EMEA	AS3692WLMi XPHSLO2 UMA 1*512/100/6L/5R/ CB_bg_0.3C_AN	CM420	N15.4W XGAG	SO512 MBII5	N	N100G B5.4K	ABT_B RM431 8BG	N
AS3692 WLMi	EMEA	AS3692WLMi XPHESA UMA 1*512/100/6L/5R/ CB_bg_0.3C_AN	CM420	N15.4W XGAG	SO512 MBII5	N	N100G B5.4K	ABT_B RM431 8BG	N
AS3692 WLMi	EMEA	AS3692WLMi XPHDE7 UMA 1*512/100/6L/5R/ CB_bg_0.3C_AN	CM420	N15.4W XGAG	SO512 MBII5	N	N100G B5.4K	ABT_B RM431 8BG	N
AS3692 WLMi	EMEA	AS3692WLMi XPHPT1 UMA 1*512/100/6L/5R/ CB_bg_0.3C_AN	CM420	N15.4W XGAG	SO512 MBII5	N	N100G B5.4K	ABT_B RM431 8BG	N

Aspire 3690

Model	RO	Description	CPU	LCD	Memory 1	Memory 2	HDD 1 (GB)	Wireless LAN	Bluetooth
AS3692 WLMi	EMEA	AS3692WLMi XPHEL1 UMA 1*512/100/6L/5R/ CB_bg_0.3C_AN	CM420	N15.4W XGAG	SO512 MBII5	N	N100G B5.4K	ABT_B RM431 8BG	N
AS3692 WLMi	EMEA	AS3692WLMi XPHIS1 UMA 1*512/100/6L/5R/ CB_bg_0.3C_AN	CM420	N15.4W XGAG	SO512 MBII5	N	N100G B5.4K	ABT_B RM431 8BG	N
AS3692 WLMi	EMEA	AS3692WLMi XPHIT1 UMA 1*512/100/6L/5R/ CB_bg_0.3C_AN	CM420	N15.4W XGAG	SO512 MBII5	N	N100G B5.4K	ABT_B RM431 8BG	N
AS3692 WLMi	EMEA	AS3692WLMi XPHTR1 UMA 1*512/100/6L/5R/ CB_bg_0.3C_AN	CM420	N15.4W XGAG	SO512 MBII5	N	N100G B5.4K	ABT_B RM431 8BG	N
AS3692 WLMi	EMEA	AS3692WLMi XPHAR1 UMA 1*512/100/6L/5R/ CB_bg_0.3C_AN	CM420	N15.4W XGAG	SO512 MBII5	N	N100G B5.4K	ABT_B RM431 8BG	N
AS3692 WLMi	EMEA	AS3692WLMi XPHSW5 UMA 1*512/100/6L/5R/ CB_bg_0.3C_AN	CM420	N15.4W XGAG	SO512 MBII5	N	N100G B5.4K	ABT_B RM431 8BG	N
AS3692 WLMi	EMEA	AS3692WLMi XPHUK1 UMA 1*512/100/6L/5R/ CB_bg_0.3C_AN	CM420	N15.4W XGAG	SO512 MBII5	N	N100G B5.4K	ABT_B RM431 8BG	N
AS3692 WLMi	EMEA	AS3692WLMi XPHSA1 UMA 2*512/120/6L/5R/ CB_bg_0.3C_AN	CM420	N15.4W XGAG	SO512 MBII5	SO512 MBII5	N120G B5.4K	ABT_B RM431 8BG	N
AS3692 WLMi	EMEA	AS3692WLMi XPHDK1 UMA 2*512/120/6L/5R/ CB_bg_0.3C_AN	CM420	N15.4W XGAG	SO512 MBII5	SO512 MBII5	N120G B5.4K	ABT_B RM431 8BG	N
AS3692 WLMi	EMEA	AS3692WLMi XPHBE1 UMA 2*512/120/6L/5R/ CB_bg_0.3C_AN	CM420	N15.4W XGAG	SO512 MBII5	SO512 MBII5	N120G B5.4K	ABT_B RM431 8BG	N
AS3692 WLMi	EMEA	AS3692WLMi XPHFRA UMA 2*512/120/6L/5R/ CB_bg_0.3C_AN	CM420	N15.4W XGAG	SO512 MBII5	SO512 MBII5	N120G B5.4K	ABT_B RM431 8BG	N
AS3692 WLMi	EMEA	AS3692WLMi XPHDE7 UMA 2*512/120/6L/5R/ CB_bg_0.3C_AN	CM420	N15.4W XGAG	SO512 MBII5	SO512 MBII5	N120G B5.4K	ABT_B RM431 8BG	N
AS3692 WLMi	EMEA	AS3692WLMi XPHNL1 UMA 2*512/120/6L/5R/ CB_bg_0.3C_AN	CM420	N15.4W XGAG	SO512 MBII5	SO512 MBII5	N120G B5.4K	ABT_B RM431 8BG	N
AS3692 WLMi	EMEA	AS3692WLMi XPHNO1 UMA 2*512/120/6L/5R/ CB_bg_0.3C_AN	CM420	N15.4W XGAG	SO512 MBII5	SO512 MBII5	N120G B5.4K	ABT_B RM431 8BG	N
AS3692 WLMi	EMEA	AS3692WLMi XPHRU2 UMA 2*512/120/6L/5R/ CB_bg_0.3C_AN	CM420	N15.4W XGAG	SO512 MBII5	SO512 MBII5	N120G B5.4K	ABT_B RM431 8BG	N
AS3692 WLMi	EMEA	AS3692WLMi XPHSV1 UMA 2*512/120/6L/5R/ CB_bg_0.3C_AN	CM420	N15.4W XGAG	SO512 MBII5	SO512 MBII5	N120G B5.4K	ABT_B RM431 8BG	N
AS3692 WLMi	EMEA	AS3692WLMi XPHCS2 UMA 2*512/120/6L/5R/ CB_bg_0.3C_AN	CM420	N15.4W XGAG	SO512 MBII5	SO512 MBII5	N120G B5.4K	ABT_B RM431 8BG	N
AS3692 WLMi	EMEA	AS3692WLMi XPHHU6 UMA 2*512/120/6L/5R/ CB_bg_0.3C_AN	CM420	N15.4W XGAG	SO512 MBII5	SO512 MBII5	N120G B5.4K	ABT_B RM431 8BG	N

Aspire 3690

Model	RO	Description	CPU	LCD	Memory 1	Memory 2	HDD 1 (GB)	Wireless LAN	Bluetooth
AS3692 WLMi	EMEA	AS3692WLMi XPHPL6 UMA 2*512/120/6L/5R/ CB_bg_0.3C_AN	CM420	N15.4W XGAG	SO512 MBII5	SO512 MBII5	N120G B5.4K	ABT_B RM431 8BG	N
AS3692 WLMi	EMEA	AS3692WLMi XPHSLO2 UMA 2*512/120/6L/5R/ CB_bg_0.3C_AN	CM420	N15.4W XGAG	SO512 MBII5	SO512 MBII5	N120G B5.4K	ABT_B RM431 8BG	N
AS3692 WLMi	EMEA	AS3692WLMi XPHESA UMA 2*512/120/6L/5R/ CB_bg_0.3C_AN	CM420	N15.4W XGAG	SO512 MBII5	SO512 MBII5	N120G B5.4K	ABT_B RM431 8BG	N
AS3692 WLMi	EMEA	AS3692WLMi XPHPT1 UMA 2*512/120/6L/5R/ CB_bg_0.3C_AN	CM420	N15.4W XGAG	SO512 MBII5	SO512 MBII5	N120G B5.4K	ABT_B RM431 8BG	N
AS3692 WLMi	EMEA	AS3692WLMi XPHL1 UMA 2*512/120/6L/5R/ CB_bg_0.3C_AN	CM420	N15.4W XGAG	SO512 MBII5	SO512 MBII5	N120G B5.4K	ABT_B RM431 8BG	N
AS3692 WLMi	EMEA	AS3692WLMi XPHIS1 UMA 2*512/120/6L/5R/ CB_bg_0.3C_AN	CM420	N15.4W XGAG	SO512 MBII5	SO512 MBII5	N120G B5.4K	ABT_B RM431 8BG	N
AS3692 WLMi	EMEA	AS3692WLMi XPHIT1 UMA 2*512/120/6L/5R/ CB_bg_0.3C_AN	CM420	N15.4W XGAG	SO512 MBII5	SO512 MBII5	N120G B5.4K	ABT_B RM431 8BG	N
AS3692 WLMi	EMEA	AS3692WLMi XPHTR1 UMA 2*512/120/6L/5R/ CB_bg_0.3C_AN	CM420	N15.4W XGAG	SO512 MBII5	SO512 MBII5	N120G B5.4K	ABT_B RM431 8BG	N
AS3692 WLMi	EMEA	AS3692WLMi XPHAR1 UMA 2*512/120/6L/5R/ CB_bg_0.3C_AN	CM420	N15.4W XGAG	SO512 MBII5	SO512 MBII5	N120G B5.4K	ABT_B RM431 8BG	N
AS3692 WLMi	EMEA	AS3692WLMi XPHSW5 UMA 2*512/120/6L/5R/ CB_bg_0.3C_AN	CM420	N15.4W XGAG	SO512 MBII5	SO512 MBII5	N120G B5.4K	ABT_B RM431 8BG	N
AS3692 WLMi	EMEA	AS3692WLMi XPHUK1 UMA 2*512/120/6L/5R/ CB_bg_0.3C_AN	CM420	N15.4W XGAG	SO512 MBII5	SO512 MBII5	N120G B5.4K	ABT_B RM431 8BG	N
AS3692 WLMi	AAP	AS3692WLMi XPHAU1 UMA 1*512/60/6L/ 5R_bg_0.3C_AN	CM420	N15.4W XGAF	SO512 MBII5	N	N60GB 5.4K	ABT_B RM431 8BG	N
AS3692 WLMi	PA	AS3692WLMi XPHEN1 UMA 1*512/60/6L/ 5R_bg_0.3C_AN	CM420	N15.4W XGAF	SO512 MBII5	N	N60GB 5.4K	ABT_B RM431 8BG	N
AS3692 WLMi	PA	AS3692WLMi XPHES1 UMA 1*512/60/6L/ 5R_bg_0.3C_AN	CM420	N15.4W XGAF	SO512 MBII5	N	N60GB 5.4K	ABT_B RM431 8BG	N
AS3692 WLMi	PA	AS3692WLMi XPHFR1 UMA 1*512/60/6L/ 5R_bg_0.3C_AN	CM420	N15.4W XGAF	SO512 MBII5	N	N60GB 5.4K	ABT_B RM431 8BG	N
AS3692 WLMi	PA	AS3692WLMi XPHXC1 UMA 1*512/60/6L/ 5R_bg_0.3C_AN	CM420	N15.4W XGAF	SO512 MBII5	N	N60GB 5.4K	ABT_B RM431 8BG	N
AS3692 NWLMi	EMEA	AS3692NWLMi LINPUSPL3 UMA 1*512/60/6L/5R/ CB_bg_0.3C_AN	CM420	N15.4W XGAGF	SO512 MBII5	N	N60GB 5.4K	ABT_B RM431 8BG	N
AS3692 NWLMi	EMEA	AS3692NWLMi LINPUSPL3 UMA 1*512/100/6L/5R/ CB_bg_0.3C_AN	CM420	N15.4W XGAGF	SO512 MBII5	N	N100G B5.4K	ABT_B RM431 8BG	N

Aspire 3690

Model	RO	Description	CPU	LCD	Memory 1	Memory 2	HDD 1 (GB)	Wireless LAN	Bluetooth
AS3692 WLMi	EMEA	AS3692WLMi XPHPL3 UMA 1*512/60/6L/5R/ CB_bg_0.3C_AN	CM420	N15.4W XGAGF	SO512 MBII5	N	N60GB 5.4K	ABT_B RM431 8BG	N
AS3692 WLMi	EMEA	AS3692WLMi XPHPL3 UMA 1*512/120/6L/5R/ CB_bg_0.3C_AN	CM420	N15.4W XGAGF	SO512 MBII5	N	N120G B5.4K	ABT_B RM431 8BG	N
AS3692 WLMi	EMEA	AS3692WLMi XPHPL3 UMA 2*512/120/6L/5R/ CB_bg_0.3C_AN	CM420	N15.4W XGAGF	SO512 MBII5	SO512 MBII5	N120G B5.4K	ABT_B RM431 8BG	FOX_B RM_2.0
AS3692 WLMi	EMEA	AS3692WLMi XPHPL3 UMA 1*512/100/6L/5R/ CB_bg_0.3C_AN	CM420	N15.4W XGAGF	SO512 MBII5	N	N100G B4.2K	ABT_B RM431 8BG	FOX_B RM_2.0
AS3692 WLMi	EMEA	AS3692WLMi XPHDE7 UMA 1*512/60/6L/5R/ CB_bg_0.3C_AN	CM420	N15.4W XGAGF	SO512 MBII5	N	N60GB 5.4K	ABT_B RM431 8BG	N
AS3692 WLMi	EMEA	AS3692WLMi XPHBE1 UMA 2*512/80/6L/5R/ CB_bg_0.3C_AN	CM420	N15.4W XGAGF	SO512 MBII5	SO512 MBII5	N80GB 5.4K	ABT_B RM431 8BG	N
AS3692 WLMi	EMEA	AS3692WLMi XPHNL1 UMA 2*512/80/6L/5R/ CB_bg_0.3C_AN	CM420	N15.4W XGAGF	SO512 MBII5	SO512 MBII5	N80GB 5.4K	ABT_B RM431 8BG	N
AS3692 WLMi	EMEA	AS3692WLMi XPHSW5 UMA 2*512/80/6L/5R/ CB_bg_0.3C_AN	CM420	N15.4W XGAGF	SO512 MBII5	SO512 MBII5	N80GB 5.4K	ABT_B RM431 8BG	N
AS3692 WLMi	EMEA	AS3692WLMi XPHDE7 UMA 2*512/80/6L/5R/ CB_bg_0.3C_AN	CM420	N15.4W XGAGF	SO512 MBII5	SO512 MBII5	N80GB 5.4K	ABT_B RM431 8BG	N
AS3692 WLMi	EMEA	AS3692WLMi MCEBE6 UMA 1*512/100/6L/5R/ CB_bg_0.3C_AN	CM420	N15.4W XGAG	SO512 MBII5	N	N100G B5.4K	ABT_B RM431 8BG	N
AS3692 WLMi	EMEA	AS3692WLMi MCEAR1 UMA 1*512/100/6L/5R/ CB_bg_0.3C_AN	CM420	N15.4W XGAG	SO512 MBII5	N	N100G B5.4K	ABT_B RM431 8BG	N
AS3692 WLMi	EMEA	AS3692WLMi MCEAR2 UMA 1*512/100/6L/5R/ CB_bg_0.3C_AN	CM420	N15.4W XGAG	SO512 MBII5	N	N100G B5.4K	ABT_B RM431 8BG	N
AS3692 WLMi	EMEA	AS3692WLMi MCEAR1 UMA 2*512/120/6L/5R/ CB_bg_0.3C_AN	CM420	N15.4W XGAG	SO512 MBII5	SO512 MBII5	N120G B5.4K	ABT_B RM431 8BG	N
AS3692 WLMi	EMEA	AS3692WLMi MCEAR2 UMA 2*512/120/6L/5R/ CB_bg_0.3C_AN	CM420	N15.4W XGAG	SO512 MBII5	SO512 MBII5	N120G B5.4K	ABT_B RM431 8BG	N
AS3692 WLMi	EMEA	AS3692WLMi MCEDEA UMA 2*512/120/6L/5R/ CB_bg_0.3C_AN	CM420	N15.4W XGAG	SO512 MBII5	SO512 MBII5	N120G B5.4K	ABT_B RM431 8BG	N
AS3692 WLMi	EMEA	AS3692WLMi MCEBE6 UMA 2*512/120/6L/5R/ CB_bg_0.3C_AN	CM420	N15.4W XGAG	SO512 MBII5	SO512 MBII5	N120G B5.4K	ABT_B RM431 8BG	N
AS3692 WLMi	EMEA	AS3692WLMi MCECS5 UMA 2*512/120/6L/5R/ CB_bg_0.3C_AN	CM420	N15.4W XGAG	SO512 MBII5	SO512 MBII5	N120G B5.4K	ABT_B RM431 8BG	N
AS3692 WLMi	EMEA	AS3692WLMi MCEDEB UMA 1*512/100/6L/5R/ CB_bg_0.3C_AN	CM420	N15.4W XGAG	SO512 MBII5	N	N100G B5.4K	ABT_B RM431 8BG	N

Aspire 3690

Model	RO	Description	CPU	LCD	Memory 1	Memory 2	HDD 1 (GB)	Wireless LAN	Bluetooth
AS3692 WLMi	EMEA	AS3692WLMi MCEDEA UMA 1*512/100/6L/5R/ CB_bg_0.3C_AN	CM420	N15.4W XGAG	SO512 MBII5	N	N100G B5.4K	ABT_B RM431 8BG	N
AS3692 WLMi	EMEA	AS3692WLMi MCECS5 UMA 1*512/100/6L/5R/ CB_bg_0.3C_AN	CM420	N15.4W XGAG	SO512 MBII5	N	N100G B5.4K	ABT_B RM431 8BG	N
AS3692 WLMi	EMEA	AS3692WLMi MCEDK6 UMA 1*512/100/6L/5R/ CB_bg_0.3C_AN	CM420	N15.4W XGAG	SO512 MBII5	N	N100G B5.4K	ABT_B RM431 8BG	N
AS3692 WLMi	EMEA	AS3692WLMi MCEFRF UMA 1*512/100/6L/5R/ CB_bg_0.3C_AN	CM420	N15.4W XGAG	SO512 MBII5	N	N100G B5.4K	ABT_B RM431 8BG	N
AS3692 WLMi	EMEA	AS3692WLMi MCEDK6 UMA 2*512/120/6L/5R/ CB_bg_0.3C_AN	CM420	N15.4W XGAG	SO512 MBII5	SO512 MBII5	N120G B5.4K	ABT_B RM431 8BG	N
AS3692 WLMi	EMEA	AS3692WLMi MCEESJ UMA 1*512/100/6L/5R/ CB_bg_0.3C_AN	CM420	N15.4W XGAG	SO512 MBII5	N	N100G B5.4K	ABT_B RM431 8BG	N
AS3692 WLMi	EMEA	AS3692WLMi MCEESJ UMA 2*512/120/6L/5R/ CB_bg_0.3C_AN	CM420	N15.4W XGAG	SO512 MBII5	SO512 MBII5	N120G B5.4K	ABT_B RM431 8BG	N
AS3692 WLMi	EMEA	AS3692WLMi MCEDEB UMA 2*512/120/6L/5R/ CB_bg_0.3C_AN	CM420	N15.4W XGAG	SO512 MBII5	SO512 MBII5	N120G B5.4K	ABT_B RM431 8BG	N
AS3692 WLMi	EMEA	AS3692WLMi MCENL6 UMA 2*512/120/6L/5R/ CB_bg_0.3C_AN	CM420	N15.4W XGAG	SO512 MBII5	SO512 MBII5	N120G B5.4K	ABT_B RM431 8BG	N
AS3692 WLMi	EMEA	AS3692WLMi MCEIT7 UMA 2*512/120/6L/5R/ CB_bg_0.3C_AN	CM420	N15.4W XGAG	SO512 MBII5	SO512 MBII5	N120G B5.4K	ABT_B RM431 8BG	N
AS3692 WLMi	EMEA	AS3692WLMi MCEIT7 UMA 1*512/100/6L/5R/ CB_bg_0.3C_AN	CM420	N15.4W XGAG	SO512 MBII5	N	N100G B5.4K	ABT_B RM431 8BG	N
AS3692 WLMi	EMEA	AS3692WLMi MCENO5 UMA 1*512/100/6L/5R/ CB_bg_0.3C_AN	CM420	N15.4W XGAG	SO512 MBII5	N	N100G B5.4K	ABT_B RM431 8BG	N
AS3692 WLMi	EMEA	AS3692WLMi MCEFRF UMA 2*512/120/6L/5R/ CB_bg_0.3C_AN	CM420	N15.4W XGAG	SO512 MBII5	SO512 MBII5	N120G B5.4K	ABT_B RM431 8BG	N
AS3692 WLMi	EMEA	AS3692WLMi MCENL6 UMA 1*512/100/6L/5R/ CB_bg_0.3C_AN	CM420	N15.4W XGAG	SO512 MBII5	N	N100G B5.4K	ABT_B RM431 8BG	N
AS3692 WLMi	EMEA	AS3692WLMi MCEPL7 UMA 1*512/100/6L/5R/ CB_bg_0.3C_AN	CM420	N15.4W XGAG	SO512 MBII5	N	N100G B5.4K	ABT_B RM431 8BG	N
AS3692 WLMi	EMEA	AS3692WLMi MCEPT6 UMA 1*512/100/6L/5R/ CB_bg_0.3C_AN	CM420	N15.4W XGAG	SO512 MBII5	N	N100G B5.4K	ABT_B RM431 8BG	N
AS3692 WLMi	EMEA	AS3692WLMi MCEPT6 UMA 2*512/120/6L/5R/ CB_bg_0.3C_AN	CM420	N15.4W XGAG	SO512 MBII5	SO512 MBII5	N120G B5.4K	ABT_B RM431 8BG	N
AS3692 WLMi	EMEA	AS3692WLMi MCEPL7 UMA 2*512/120/6L/5R/ CB_bg_0.3C_AN	CM420	N15.4W XGAG	SO512 MBII5	SO512 MBII5	N120G B5.4K	ABT_B RM431 8BG	N

Aspire 3690

Model	RO	Description	CPU	LCD	Memory 1	Memory 2	HDD 1 (GB)	Wireless LAN	Bluetooth
AS3692 WLMi	EMEA	AS3692WLMi MCENO5 UMA 2*512/120/6L/5R/ CB_bg_0.3C_AN	CM420	N15.4W XGAG	SO512 MBII5	SO512 MBII5	N120G B5.4K	ABT_B RM431 8BG	N
AS3692 WLMi	EMEA	AS3692WLMi MCERU9 UMA 2*512/120/6L/5R/ CB_bg_0.3C_AN	CM420	N15.4W XGAG	SO512 MBII5	SO512 MBII5	N120G B5.4K	ABT_B RM431 8BG	N
AS3692 WLMi	EMEA	AS3692WLMi MCESI1 UMA 2*512/120/6L/5R/ CB_bg_0.3C_AN	CM420	N15.4W XGAG	SO512 MBII5	SO512 MBII5	N120G B5.4K	ABT_B RM431 8BG	N
AS3692 WLMi	EMEA	AS3692WLMi MCESI1 UMA 1*512/100/6L/5R/ CB_bg_0.3C_AN	CM420	N15.4W XGAG	SO512 MBII5	N	N100G B5.4K	ABT_B RM431 8BG	N
AS3692 WLMi	EMEA	AS3692WLMi MCERU9 UMA 1*512/100/6L/5R/ CB_bg_0.3C_AN	CM420	N15.4W XGAG	SO512 MBII5	N	N100G B5.4K	ABT_B RM431 8BG	N
AS3692 WLMi	EMEA	AS3692WLMi MCESV5 UMA 1*512/100/6L/5R/ CB_bg_0.3C_AN	CM420	N15.4W XGAG	SO512 MBII5	N	N100G B5.4K	ABT_B RM431 8BG	N
AS3692 WLMi	EMEA	AS3692WLMi MCESW8 UMA 1*512/100/6L/5R/ CB_bg_0.3C_AN	CM420	N15.4W XGAG	SO512 MBII5	N	N100G B5.4K	ABT_B RM431 8BG	N
AS3692 WLMi	EMEA	AS3692WLMi MCESV5 UMA 2*512/120/6L/5R/ CB_bg_0.3C_AN	CM420	N15.4W XGAG	SO512 MBII5	SO512 MBII5	N120G B5.4K	ABT_B RM431 8BG	N
AS3692 WLMi	EMEA	AS3692WLMi MCESW8 UMA 2*512/120/6L/5R/ CB_bg_0.3C_AN	CM420	N15.4W XGAG	SO512 MBII5	SO512 MBII5	N120G B5.4K	ABT_B RM431 8BG	N
AS3692 WLMi	EMEA	AS3692WLMi MCEUK5 UMA 2*512/120/6L/5R/ CB_bg_0.3C_AN	CM420	N15.4W XGAG	SO512 MBII5	SO512 MBII5	N120G B5.4K	ABT_B RM431 8BG	N
AS3692 WLMi	EMEA	AS3692WLMi MCETR5 UMA 2*512/120/6L/5R/ CB_bg_0.3C_AN	CM420	N15.4W XGAG	SO512 MBII5	SO512 MBII5	N120G B5.4K	ABT_B RM431 8BG	N
AS3692 WLMi	EMEA	AS3692WLMi MCEWDE11W UMA 2*512/120/6L/5R/ CB_bg_0.3C_AN	CM420	N15.4W XGAG	SO512 MBII5	SO512 MBII5	N120G B5.4K	ABT_B RM431 8BG	N
AS3692 WLMi	EMEA	AS3692WLMi MCEUK5 UMA 1*512/100/6L/5R/ CB_bg_0.3C_AN	CM420	N15.4W XGAG	SO512 MBII5	N	N100G B5.4K	ABT_B RM431 8BG	N
AS3692 WLMi	EMEA	AS3692WLMi MCETR5 UMA 1*512/100/6L/5R/ CB_bg_0.3C_AN	CM420	N15.4W XGAG	SO512 MBII5	N	N100G B5.4K	ABT_B RM431 8BG	N
AS3692 WLMi	EMEA	AS3692WLMi MCEWDE11W UMA 1*512/100/6L/5R/ CB_bg_0.3C_AN	CM420	N15.4W XGAG	SO512 MBII5	N	N100G B5.4K	ABT_B RM431 8BG	N
AS3692 WLMi	EMEA	AS3692WLMi MCEWFR11W UMA 1*512/100/6L/5R/ CB_bg_0.3C_AN	CM420	N15.4W XGAG	SO512 MBII5	N	N100G B5.4K	ABT_B RM431 8BG	N
AS3692 WLMi	EMEA	AS3692WLMi MCEWUK11W UMA 1*512/100/6L/5R/ CB_bg_0.3C_AN	CM420	N15.4W XGAG	SO512 MBII5	N	N100G B5.4K	ABT_B RM431 8BG	N
AS3692 WLMi	EMEA	AS3692WLMi MCEWIT11W UMA 1*512/100/6L/5R/ CB_bg_0.3C_AN	CM420	N15.4W XGAG	SO512 MBII5	N	N100G B5.4K	ABT_B RM431 8BG	N

Aspire 3690

Model	RO	Description	CPU	LCD	Memory 1	Memory 2	HDD 1 (GB)	Wireless LAN	Bluetooth
AS3692 WLMi	EMEA	AS3692WLMi MCEWFR11W UMA 2*512/120/6L/5R/CB_bg_0.3C_AN	CM420	N15.4W XGAG	SO512 MBII5	SO512 MBII5	N120G B5.4K	ABT_B RM431 8BG	N
AS3692 WLMi	EMEA	AS3692WLMi MCEWIT11W UMA 2*512/120/6L/5R/CB_bg_0.3C_AN	CM420	N15.4W XGAG	SO512 MBII5	SO512 MBII5	N120G B5.4K	ABT_B RM431 8BG	N
AS3692 WLMi	EMEA	AS3692WLMi MCEWUK11W UMA 2*512/120/6L/5R/CB_bg_0.3C_AN	CM420	N15.4W XGAG	SO512 MBII5	SO512 MBII5	N120G B5.4K	ABT_B RM431 8BG	N
AS3691 WLMi	PA	AS3691WLMi MCECF UMA 1*512/100/6L/5R/CB_bg_0.3C_AN	CM410	N15.4W XGAG	SO512 MBII5	N	N100G B5.4K	ABT_B RM431 8BG	N
AS3691 WLMi	PA	AS3691WLMi MCEES1 UMA 1*512/100/6L/5R/CB_bg_0.3C_AN	CM410	N15.4W XGAG	SO512 MBII5	N	N100G B5.4K	ABT_B RM431 8BG	N
AS3691 WLMi	PA	AS3691WLMi MCECF UMA 2*512/100/6L/5R/CB_bg_0.3C_AN	CM410	N15.4W XGAG	SO512 MBII5	SO512 MBII5	N100G B5.4K	ABT_B RM431 8BG	N
AS3691 WLMi	PA	AS3691WLMi MCEES1 UMA 2*512/100/6L/5R/CB_bg_0.3C_AN	CM410	N15.4W XGAG	SO512 MBII5	SO512 MBII5	N100G B5.4K	ABT_B RM431 8BG	N
AS3691 WLMi	PA	AS3691WLMi MCEUS UMA 1*512/100/6L/5R/CB_bg_0.3C_AN	CM410	N15.4W XGAG	SO512 MBII5	N	N100G B5.4K	ABT_B RM431 8BG	N
AS3691 WLMi	PA	AS3691WLMi MCEUS UMA 2*512/100/6L/5R/CB_bg_0.3C_AN	CM410	N15.4W XGAG	SO512 MBII5	SO512 MBII5	N100G B5.4K	ABT_B RM431 8BG	N
AS3692 NWLMi	EMEA	AS3692NWLMi LINPUSAR7 UMA 1*512/60/6L/5R/CB_bg_0.3C_AN	CM420	N15.4W XGAGF	SO512 MBII5	N	N60GB 5.4K	ABT_B RM431 8BG	N
AS3692 NWLMi	EMEA	AS3692NWLMi LINPUSAR9 UMA 1*512/60/6L/5R/CB_bg_0.3C_AN	CM420	N15.4W XGAGF	SO512 MBII5	N	N60GB 5.4K	ABT_B RM431 8BG	N
AS3692 NWLMi	EMEA	AS3692NWLMi LINPUSARC UMA 1*512/60/6L/5R/CB_bg_0.3C_AN	CM420	N15.4W XGAGF	SO512 MBII5	N	N60GB 5.4K	ABT_B RM431 8BG	N
AS3692 NWLMi	EMEA	AS3692NWLMi LINPUSRU5 UMA 1*512/60/6L/5R/CB_bg_0.3C_AN	CM420	N15.4W XGAGF	SO512 MBII5	N	N60GB 5.4K	ABT_B RM431 8BG	N
AS3692 WLMi	PA	AS3692WLMi MCECF UMA 1*512/80/6L/5R/CB_bg_0.3C_AN	CM420	N15.4W XGAGF	SO512 MBII5	N	N80GB 5.4K	ABT_B RM431 8BG	N
AS3692 WLMi	PA	AS3692WLMi MCEUS UMA 1*512/80/6L/5R/CB_bg_0.3C_AN	CM420	N15.4W XGAGF	SO512 MBII5	N	N80GB 5.4K	ABT_B RM431 8BG	N
AS3692 WLMi	PA	AS3692WLMi MCEES1 UMA 1*512/80/6L/5R/CB_bg_0.3C_AN	CM420	N15.4W XGAGF	SO512 MBII5	N	N80GB 5.4K	ABT_B RM431 8BG	N
AS3692 WLMi	EMEA	AS3692WLMi MCEPL7 UMA 1*512/120/BT/8L/5R/CB_bg_0.3C_AN	CM420	N15.4W XGAG	SO512 MBII5	N	N120G B5.4K	ABT_B RM431 8BG	FOX_B RM_2.0
AS3692 NWLMi	EMEA	AS3692NWLMi LINPUSPL3 UMA 1*512/60/8L/5R/CB_bg_0.3C_AN	CM420	N15.4W XGAG	SO512 MBII5	N	N60GB 5.4K	ABT_B RM431 8BG	N

Aspire 3690

Model	RO	Description	CPU	LCD	Memory 1	Memory 2	HDD 1 (GB)	Wireless LAN	Bluetooth
AS3692 NWLMI	EMEA	AS3692NWLMI LINPUSPL3 UMA 1*512/120/8L/5R/ CB_bg_0.3C_AN	CM420	N15.4W XGAG	SO512 MBII5	N	N120G B5.4K	ABT_B RM431 8BG	N
AS3692 WLMi	EMEA	AS3692WLMi MCEPL7 UMA 1*512/60/8L/5R/ CB_bg_0.3C_AN	CM420	N15.4W XGAG	SO512 MBII5	N	N60GB 5.4K	ABT_B RM431 8BG	N
AS3692 WLMi	EMEA	AS3692WLMi MCEPL7 UMA 1*512/80/8L/5R/ CB_bg_0.3C_AN	CM420	N15.4W XGAG	SO512 MBII5	N	N80GB 5.4K	ABT_B RM431 8BG	FOX_B RM_2.0
AS3692 WLMi	EMEA	AS3692WLMi XPHNL1 UMA 2*512/80/4L/5R/ CB_bg_0.3C_AN	CM420	N15.4W XGAGF	SO512 MBII5	SO512 MBII5	N80GB 5.4K	ABT_B RM431 8BG	N
AS3692 WLMi	EMEA	AS3692WLMi XPHBE1 UMA 2*512/80/4L/5R/ CB_bg_0.3C_AN	CM420	N15.4W XGAGF	SO512 MBII5	SO512 MBII5	N80GB 5.4K	ABT_B RM431 8BG	N
AS3692 WLMi	EMEA	AS3692WLMi XPHSW4 UMA 2*512/80/4L/5R/ CB_bg_0.3C_AN	CM420	N15.4W XGAGF	SO512 MBII5	SO512 MBII5	N80GB 5.4K	ABT_B RM431 8BG	N
AS3692 WLMi	PA	AS3692WLMi MCECF UMA 2*512/120/6L/5R/ CB_bg_0.3C_AN	CM420	N15.4W XGAGF	SO512 MBII5	SO512 MBII5	N120G B5.4K	ABT_B RM431 8BG	N
AS3692 WLMi	PA	AS3692WLMi MCEUS UMA 2*512/120/6L/5R/ CB_bg_0.3C_AN	CM420	N15.4W XGAGF	SO512 MBII5	SO512 MBII5	N120G B5.4K	ABT_B RM431 8BG	N
AS3692 WLMi	PA	AS3692WLMi MCEES1 UMA 2*512/120/6L/5R/ CB_bg_0.3C_AN	CM420	N15.4W XGAGF	SO512 MBII5	SO512 MBII5	N120G B5.4K	ABT_B RM431 8BG	N
AS3692 WLMi	PA	AS3692WLMi XPHXC1 UMA 2*512/120/4L/5R/ CB_bg_0.3C_AN	CM420	N15.4W XGAGF	SO512 MBII5	SO512 MBII5	N120G B5.4K	ABT_B RM431 8BG	N
AS3692 WLMi	PA	AS3692WLMi XPHXC1 UMA 1*512/80/6L/5R/ CB_bg_0.3C_AN	CM420	N15.4W XGAGF	SO512 MBII5	N	N80GB 5.4K	ABT_B RM431 8BG	N
AS3693 WLMi	PA	AS3693WLMi MCEUS UMA 2*512/120/6L/5R/ CB_bg_0.3C_AN	CM430	N15.4W XGAGF	SO512 MBII5	SO512 MBII5	N120G B5.4K	ABT_B RM431 8BG	N
AS3693 WLMi	PA	AS3693WLMi MCEES1 UMA 2*512/120/6L/5R/ CB_bg_0.3C_AN	CM430	N15.4W XGAGF	SO512 MBII5	SO512 MBII5	N120G B5.4K	ABT_B RM431 8BG	N
AS3692 WLMi	PA	AS3692WLMi XPHXC1 UMA 2*512/120/6L/5R/ CB_bg_0.3C_AN	CM420	N15.4W XGAGF	SO512 MBII5	SO512 MBII5	N120G B5.4K	ABT_B RM431 8BG	N
AS3693 WLMi	PA	AS3693WLMi XPHXC1 UMA 2*512/120/6L/5R/ CB_bg_0.3C_AN	CM430	N15.4W XGAGF	SO512 MBII5	SO512 MBII5	N120G B5.4K	ABT_B RM431 8BG	N
AS3693 WLMi	PA	AS3693WLMi MCECF UMA 2*512/120/6L/5R/ CB_bg_0.3C_AN	CM430	N15.4W XGAGF	SO512 MBII5	SO512 MBII5	N120G B5.4K	ABT_B RM431 8BG	N
AS3692 WLMi	EMEA	AS3692WLMi XPHPL3 UMA 1*512/80/6L/5R/ CB_bg_0.3C_AN	CM420	N15.4W XGAGF	SO512 MBII5	N	N80GB 5.4K	ABT_B RM431 8BG	N
AS3692 WLMi	EMEA	AS3692WLMi XPHPL3 UMA 2*512/80/6L/5R/ CB_bg_0.3C_AN	CM420	N15.4W XGAGF	SO512 MBII5	SO512 MBII5	N80GB 5.4K	ABT_B RM431 8BG	N

Aspire 3690

Model	RO	Description	CPU	LCD	Memory 1	Memory 2	HDD 1 (GB)	Wireless LAN	Bluetooth
AS3692 WLMi	EMEA	AS3692WLMi XPHPL6 UMA 1*512/120/6L/5R/ CB_bg_0.3C_AN	CM420	N15.4W XGAGF	SO512 MBII5	N	N120G B5.4K	ABT_B RM431 8BG	N
AS3692 WLMi	EMEA	AS3692WLMi MCEBE6 UMA 1*512/120/6L/5R/ CB_bg_0.3C_AN	CM420	N15.4W XGAG	SO512 MBII5	N	N120G B5.4K	ABT_B RM431 8BG	N
AS3692 WLMi	EMEA	AS3692WLMi MCEAR1 UMA 1*512/120/6L/5R/ CB_bg_0.3C_AN	CM420	N15.4W XGAG	SO512 MBII5	N	N120G B5.4K	ABT_B RM431 8BG	N
AS3692 WLMi	EMEA	AS3692WLMi MCEAR2 UMA 1*512/120/6L/5R/ CB_bg_0.3C_AN	CM420	N15.4W XGAG	SO512 MBII5	N	N120G B5.4K	ABT_B RM431 8BG	N
AS3692 WLMi	EMEA	AS3692WLMi MCEDEB UMA 1*512/120/6L/5R/ CB_bg_0.3C_AN	CM420	N15.4W XGAG	SO512 MBII5	N	N120G B5.4K	ABT_B RM431 8BG	N
AS3692 WLMi	EMEA	AS3692WLMi MCEDK6 UMA 1*512/120/6L/5R/ CB_bg_0.3C_AN	CM420	N15.4W XGAG	SO512 MBII5	N	N120G B5.4K	ABT_B RM431 8BG	N
AS3692 WLMi	EMEA	AS3692WLMi MCEDEA UMA 1*512/120/6L/5R/ CB_bg_0.3C_AN	CM420	N15.4W XGAG	SO512 MBII5	N	N120G B5.4K	ABT_B RM431 8BG	N
AS3692 WLMi	EMEA	AS3692WLMi MCEESJ UMA 1*512/120/6L/5R/ CB_bg_0.3C_AN	CM420	N15.4W XGAG	SO512 MBII5	N	N120G B5.4K	ABT_B RM431 8BG	N
AS3692 WLMi	EMEA	AS3692WLMi MCECS5 UMA 1*512/120/6L/5R/ CB_bg_0.3C_AN	CM420	N15.4W XGAG	SO512 MBII5	N	N120G B5.4K	ABT_B RM431 8BG	N
AS3692 WLMi	EMEA	AS3692WLMi MCENO5 UMA 1*512/120/6L/5R/ CB_bg_0.3C_AN	CM420	N15.4W XGAG	SO512 MBII5	N	N120G B5.4K	ABT_B RM431 8BG	N
AS3692 WLMi	EMEA	AS3692WLMi MCERU9 UMA 1*512/120/6L/5R/ CB_bg_0.3C_AN	CM420	N15.4W XGAG	SO512 MBII5	N	N120G B5.4K	ABT_B RM431 8BG	N
AS3692 WLMi	EMEA	AS3692WLMi MCEPL7 UMA 1*512/120/6L/5R/ CB_bg_0.3C_AN	CM420	N15.4W XGAG	SO512 MBII5	N	N120G B5.4K	ABT_B RM431 8BG	N
AS3692 WLMi	EMEA	AS3692WLMi MCEPT6 UMA 1*512/120/6L/5R/ CB_bg_0.3C_AN	CM420	N15.4W XGAG	SO512 MBII5	N	N120G B5.4K	ABT_B RM431 8BG	N
AS3692 WLMi	EMEA	AS3692WLMi MCENL6 UMA 1*512/120/6L/5R/ CB_bg_0.3C_AN	CM420	N15.4W XGAG	SO512 MBII5	N	N120G B5.4K	ABT_B RM431 8BG	N
AS3692 WLMi	EMEA	AS3692WLMi MCEIT7 UMA 1*512/120/6L/5R/ CB_bg_0.3C_AN	CM420	N15.4W XGAG	SO512 MBII5	N	N120G B5.4K	ABT_B RM431 8BG	N
AS3692 WLMi	EMEA	AS3692WLMi MCEFRF UMA 1*512/120/6L/5R/ CB_bg_0.3C_AN	CM420	N15.4W XGAG	SO512 MBII5	N	N120G B5.4K	ABT_B RM431 8BG	N
AS3692 WLMi	EMEA	AS3692WLMi MCES11 UMA 1*512/120/6L/5R/ CB_bg_0.3C_AN	CM420	N15.4W XGAG	SO512 MBII5	N	N120G B5.4K	ABT_B RM431 8BG	N
AS3692 WLMi	EMEA	AS3692WLMi MCEUUK11U UMA 1*512/120/6L/5R/ CB_bg_0.3C_AN	CM420	N15.4W XGAG	SO512 MBII5	N	N120G B5.4K	ABT_B RM431 8BG	N

Aspire 3690

Model	RO	Description	CPU	LCD	Memory 1	Memory 2	HDD 1 (GB)	Wireless LAN	Bluetooth
AS3692 WLMi	EMEA	AS3692WLMi MCEUK6 UMA 1*512/120/6L/5R/ CB_bg_0.3C_AN	CM420	N15.4W XGAG	SO512 MBII5	N	N120G B5.4K	ABT_B RM431 8BG	N
AS3692 WLMi	EMEA	AS3692WLMi MCETR5 UMA 1*512/120/6L/5R/ CB_bg_0.3C_AN	CM420	N15.4W XGAG	SO512 MBII5	N	N120G B5.4K	ABT_B RM431 8BG	N
AS3692 WLMi	EMEA	AS3692WLMi MCESW8 UMA 1*512/120/6L/5R/ CB_bg_0.3C_AN	CM420	N15.4W XGAG	SO512 MBII5	N	N120G B5.4K	ABT_B RM431 8BG	N
AS3692 WLMi	EMEA	AS3692WLMi MCEUK5 UMA 1*512/120/6L/5R/ CB_bg_0.3C_AN	CM420	N15.4W XGAG	SO512 MBII5	N	N120G B5.4K	ABT_B RM431 8BG	N
AS3692 WLMi	EMEA	AS3692WLMi MCESV5 UMA 1*512/120/6L/5R/ CB_bg_0.3C_AN	CM420	N15.4W XGAG	SO512 MBII5	N	N120G B5.4K	ABT_B RM431 8BG	N
AS3692 WLMi	EMEA	AS3692WLMi MCEWDE11W UMA 1*512/120/6L/5R/CB_bg_0.3C_AN	CM420	N15.4W XGAG	SO512 MBII5	N	N120G B5.4K	ABT_B RM431 8BG	N
AS3692 WLMi	EMEA	AS3692WLMi MCEWUK11W UMA 1*512/120/6L/5R/CB_bg_0.3C_AN	CM420	N15.4W XGAG	SO512 MBII5	N	N120G B5.4K	ABT_B RM431 8BG	N
AS3692 WLMi	EMEA	AS3692WLMi MCEWIT11W UMA 1*512/120/6L/5R/ CB_bg_0.3C_AN	CM420	N15.4W XGAG	SO512 MBII5	N	N120G B5.4K	ABT_B RM431 8BG	N
AS3692 WLMi	EMEA	AS3692WLMi MCEWUK21W UMA 1*512/120/6L/5R/CB_bg_0.3C_AN	CM420	N15.4W XGAG	SO512 MBII5	N	N120G B5.4K	ABT_B RM431 8BG	N
AS3692 WLMi	EMEA	AS3692WLMi MCEWFR11W UMA 1*512/120/6L/5R/CB_bg_0.3C_AN	CM420	N15.4W XGAG	SO512 MBII5	N	N120G B5.4K	ABT_B RM431 8BG	N
AS3692 WLMi	EMEA	AS3692WLMi XPHAR1 UMA 1*512/120/6L/5R/ CB_bg_0.3C_AN	CM420	N15.4W XGAG	SO512 MBII5	N	N120G B5.4K	ABT_B RM431 8BG	N
AS3692 WLMi	EMEA	AS3692WLMi XPHEL1 UMA 1*512/120/6L/5R/ CB_bg_0.3C_AN	CM420	N15.4W XGAG	SO512 MBII5	N	N120G B5.4K	ABT_B RM431 8BG	N
AS3692 WLMi	EMEA	AS3692WLMi XPHCS2 UMA 1*512/120/6L/5R/ CB_bg_0.3C_AN	CM420	N15.4W XGAG	SO512 MBII5	N	N120G B5.4K	ABT_B RM431 8BG	N
AS3692 WLMi	EMEA	AS3692WLMi XPHDK1 UMA 1*512/120/6L/5R/ CB_bg_0.3C_AN	CM420	N15.4W XGAG	SO512 MBII5	N	N120G B5.4K	ABT_B RM431 8BG	N
AS3692 WLMi	EMEA	AS3692WLMi XPHBE1 UMA 1*512/120/6L/5R/ CB_bg_0.3C_AN	CM420	N15.4W XGAG	SO512 MBII5	N	N120G B5.4K	ABT_B RM431 8BG	N
AS3692 WLMi	EMEA	AS3692WLMi XPHDE7 UMA 1*512/120/6L/5R/ CB_bg_0.3C_AN	CM420	N15.4W XGAG	SO512 MBII5	N	N120G B5.4K	ABT_B RM431 8BG	N
AS3692 WLMi	EMEA	AS3692WLMi XPHFRA UMA 1*512/120/6L/5R/ CB_bg_0.3C_AN	CM420	N15.4W XGAG	SO512 MBII5	N	N120G B5.4K	ABT_B RM431 8BG	N
AS3692 WLMi	EMEA	AS3692WLMi XPHHU6 UMA 1*512/120/6L/5R/ CB_bg_0.3C_AN	CM420	N15.4W XGAG	SO512 MBII5	N	N120G B5.4K	ABT_B RM431 8BG	N

Aspire 3690

Model	RO	Description	CPU	LCD	Memory 1	Memory 2	HDD 1 (GB)	Wireless LAN	Bluetooth
AS3692 WLMi	EMEA	AS3692WLMi XPHIS1 UMA 1*512/120/6L/5R/ CB_bg_0.3C_AN	CM420	N15.4W XGAG	SO512 MBII5	N	N120G B5.4K	ABT_B RM431 8BG	N
AS3692 WLMi	EMEA	AS3692WLMi XPHESA UMA 1*512/120/6L/5R/ CB_bg_0.3C_AN	CM420	N15.4W XGAG	SO512 MBII5	N	N120G B5.4K	ABT_B RM431 8BG	N
AS3692 WLMi	EMEA	AS3692WLMi XPHIT1 UMA 1*512/120/6L/5R/ CB_bg_0.3C_AN	CM420	N15.4W XGAG	SO512 MBII5	N	N120G B5.4K	ABT_B RM431 8BG	N
AS3692 WLMi	EMEA	AS3692WLMi XPHPT1 UMA 1*512/120/6L/5R/ CB_bg_0.3C_AN	CM420	N15.4W XGAG	SO512 MBII5	N	N120G B5.4K	ABT_B RM431 8BG	N
AS3692 WLMi	EMEA	AS3692WLMi XPHSLO2 UMA 1*512/120/6L/5R/ CB_bg_0.3C_AN	CM420	N15.4W XGAG	SO512 MBII5	N	N120G B5.4K	ABT_B RM431 8BG	N
AS3692 WLMi	EMEA	AS3692WLMi XPHNL1 UMA 1*512/120/6L/5R/ CB_bg_0.3C_AN	CM420	N15.4W XGAG	SO512 MBII5	N	N120G B5.4K	ABT_B RM431 8BG	N
AS3692 WLMi	EMEA	AS3692WLMi XPHNO1 UMA 1*512/120/6L/5R/ CB_bg_0.3C_AN	CM420	N15.4W XGAG	SO512 MBII5	N	N120G B5.4K	ABT_B RM431 8BG	N
AS3692 WLMi	EMEA	AS3692WLMi XPHRU2 UMA 1*512/120/6L/5R/ CB_bg_0.3C_AN	CM420	N15.4W XGAG	SO512 MBII5	N	N120G B5.4K	ABT_B RM431 8BG	N
AS3692 WLMi	EMEA	AS3692WLMi XPHSA1 UMA 1*512/120/6L/5R/ CB_bg_0.3C_AN	CM420	N15.4W XGAG	SO512 MBII5	N	N120G B5.4K	ABT_B RM431 8BG	N
AS3692 WLMi	EMEA	AS3692WLMi XPHTR1 UMA 1*512/120/6L/5R/ CB_bg_0.3C_AN	CM420	N15.4W XGAG	SO512 MBII5	N	N120G B5.4K	ABT_B RM431 8BG	N
AS3692 WLMi	EMEA	AS3692WLMi XPHSW5 UMA 1*512/120/6L/5R/ CB_bg_0.3C_AN	CM420	N15.4W XGAG	SO512 MBII5	N	N120G B5.4K	ABT_B RM431 8BG	N
AS3692 WLMi	EMEA	AS3692WLMi XPHUK1 UMA 1*512/120/6L/5R/ CB_bg_0.3C_AN	CM420	N15.4W XGAG	SO512 MBII5	N	N120G B5.4K	ABT_B RM431 8BG	N
AS3692 WLMi	EMEA	AS3692WLMi XPHSV1 UMA 1*512/120/6L/5R/ CB_bg_0.3C_AN	CM420	N15.4W XGAG	SO512 MBII5	N	N120G B5.4K	ABT_B RM431 8BG	N

TravelMate 4280/4230/2490 Series

TravelMate 4280

Model	RO	Description	Memory 1	Memory 2	HDD 1 (GB)	Wireless LAN	Bluetooth
TM428 3WLMi	EMEA	TM4283WLMi XPHBE1 NB7PSE128SC 2*512/80/ 8L/5R_abg_1.3C_AN	SO512MBII 5	SO512MBII 5	N80GB5.4K S	INT3945AB G_MOW2	N
TM428 3WLMi	EMEA	TM4283WLMi XPHCS2 NB7PSE128SC 2*512/80/ 8L/5R_abg_1.3C_AN	SO512MBII 5	SO512MBII 5	N80GB5.4K S	INT3945AB G_MOW2	N
TM428 3WLMi	EMEA	TM4283WLMi XPHAR1 NB7PSE128SC 2*512/80/ 8L/5R_abg_1.3C_AN	SO512MBII 5	SO512MBII 5	N80GB5.4K S	INT3945AB G_MOW1	N
TM428 3WLMi	EMEA	TM4283WLMi XPHBE1 NB7PSE128SC 2*512/120/ 8L/5R_abg_1.3C_AN	SO512MBII 5	SO512MBII 5	N120GB5.4 KS	INT3945AB G_MOW2	N
TM428 3WLMi	EMEA	TM4283WLMi XPHDE7 NB7PSE128SC 2*512/120/ 8L/5R_abg_1.3C_AN	SO512MBII 5	SO512MBII 5	N120GB5.4 KS	INT3945AB G_MOW2	N
TM428 3WLMi	EMEA	TM4283WLMi XPHCS2 NB7PSE128SC 2*512/120/ 8L/5R_abg_1.3C_AN	SO512MBII 5	SO512MBII 5	N120GB5.4 KS	INT3945AB G_MOW2	N
TM428 3WLMi	EMEA	TM4283WLMi XPHAR1 NB7PSE128SC 2*512/120/ 8L/5R_abg_1.3C_AN	SO512MBII 5	SO512MBII 5	N120GB5.4 KS	INT3945AB G_MOW1	N
TM428 3WLMi	EMEA	TM4283WLMi XPHL1 NB7PSE128SC 2*512/120/ 8L/5R_abg_1.3C_AN	SO512MBII 5	SO512MBII 5	N120GB5.4 KS	INT3945AB G_MOW2	N
TM428 3WLMi	EMEA	TM4283WLMi XPHFRA NB7PSE128SC 2*512/120/ 8L/5R_abg_1.3C_AN	SO512MBII 5	SO512MBII 5	N120GB5.4 KS	INT3945AB G_MOW2	N
TM428 3WLMi	EMEA	TM4283WLMi XPHESA NB7PSE128SC 2*512/120/ 8L/5R_abg_1.3C_AN	SO512MBII 5	SO512MBII 5	N120GB5.4 KS	INT3945AB G_MOW2	N
TM428 3WLMi	EMEA	TM4283WLMi XPHDK1 NB7PSE128SC 2*512/120/ 8L/5R_abg_1.3C_AN	SO512MBII 5	SO512MBII 5	N120GB5.4 KS	INT3945AB G_MOW2	N
TM428 3WLMi	EMEA	TM4283WLMi XPHESA NB7PSE128SC 2*512/80/ 8L/5R_abg_1.3C_AN	SO512MBII 5	SO512MBII 5	N80GB5.4K S	INT3945AB G_MOW2	N
TM428 3WLMi	EMEA	TM4283WLMi XPHL1 NB7PSE128SC 2*512/80/ 8L/5R_abg_1.3C_AN	SO512MBII 5	SO512MBII 5	N80GB5.4K S	INT3945AB G_MOW2	N
TM428 3WLMi	EMEA	TM4283WLMi XPHDK1 NB7PSE128SC 2*512/80/ 8L/5R_abg_1.3C_AN	SO512MBII 5	SO512MBII 5	N80GB5.4K S	INT3945AB G_MOW2	N
TM428 3WLMi	EMEA	TM4283WLMi XPHFRA NB7PSE128SC 2*512/80/ 8L/5R_abg_1.3C_AN	SO512MBII 5	SO512MBII 5	N80GB5.4K S	INT3945AB G_MOW2	N
TM428 3WLMi	EMEA	TM4283WLMi XPHDE7 NB7PSE128SC 2*512/80/ 8L/5R_abg_1.3C_AN	SO512MBII 5	SO512MBII 5	N80GB5.4K S	INT3945AB G_MOW2	N
TM428 3WLMi	EMEA	TM4283WLMi XPHIS1 NB7PSE128SC 2*512/80/ 8L/5R_abg_1.3C_AN	SO512MBII 5	SO512MBII 5	N80GB5.4K S	INT3945BG	N

TravelMate 4280

Model	RO	Description	Memory 1	Memory 2	HDD 1 (GB)	Wireless LAN	Bluetooth
TM428 3WLMi	EMEA	TM4283WLMi XPBIT1 NB7PSE128SC 2*512/80/8L/5R_abg_1.3C_AN	SO512MBII 5	SO512MBII 5	N80GB5.4K S	INT3945AB G_MOW2	N
TM428 3WLMi	EMEA	TM4283WLMi XPHHU6 NB7PSE128SC 2*512/80/8L/5R_abg_1.3C_AN	SO512MBII 5	SO512MBII 5	N80GB5.4K S	INT3945AB G_MOW2	N
TM428 3WLMi	EMEA	TM4283WLMi XPHNL1 NB7PSE128SC 2*512/80/8L/5R_abg_1.3C_AN	SO512MBII 5	SO512MBII 5	N80GB5.4K S	INT3945AB G_MOW1	N
TM428 3WLMi	EMEA	TM4283WLMi XPHNL1 NB7PSE128SC 2*512/120/8L/5R_abg_1.3C_AN	SO512MBII 5	SO512MBII 5	N120GB5.4 KS	INT3945AB G_MOW1	N
TM428 3WLMi	EMEA	TM4283WLMi XPHHU6 NB7PSE128SC 2*512/120/8L/5R_abg_1.3C_AN	SO512MBII 5	SO512MBII 5	N120GB5.4 KS	INT3945AB G_MOW2	N
TM428 3WLMi	EMEA	TM4283WLMi XPHIS1 NB7PSE128SC 2*512/120/8L/5R_bg_1.3C_AN	SO512MBII 5	SO512MBII 5	N120GB5.4 KS	INT3945BG	N
TM428 3WLMi	EMEA	TM4283WLMi XPBIT1 NB7PSE128SC 2*512/120/8L/5R_abg_1.3C_AN	SO512MBII 5	SO512MBII 5	N120GB5.4 KS	INT3945AB G_MOW2	N
TM428 3WLMi	EMEA	TM4283WLMi XPHT1 NB7PSE128SC 2*512/120/8L/5R_abg_1.3C_AN	SO512MBII 5	SO512MBII 5	N120GB5.4 KS	INT3945AB G_MOW2	N
TM428 3WLMi	EMEA	TM4283WLMi XPHPL6 NB7PSE128SC 2*512/120/8L/5R_abg_1.3C_AN	SO512MBII 5	SO512MBII 5	N120GB5.4 KS	INT3945AB G_MOW2	N
TM428 3WLMi	EMEA	TM4283WLMi XPHNO1 NB7PSE128SC 2*512/120/8L/5R_abg_1.3C_AN	SO512MBII 5	SO512MBII 5	N120GB5.4 KS	INT3945AB G_MOW2	N
TM428 3WLMi	EMEA	TM4283WLMi XPHRU2 NB7PSE128SC 2*512/120/8L/5R_abg_1.3C_AN	SO512MBII 5	SO512MBII 5	N120GB5.4 KS	INT3945AB G_MOW2	N
TM428 3WLMi	EMEA	TM4283WLMi XPHNO1 NB7PSE128SC 2*512/80/8L/5R_abg_1.3C_AN	SO512MBII 5	SO512MBII 5	N80GB5.4K S	INT3945AB G_MOW2	N
TM428 3WLMi	EMEA	TM4283WLMi XPHRU2 NB7PSE128SC 2*512/80/8L/5R_abg_1.3C_AN	SO512MBII 5	SO512MBII 5	N80GB5.4K S	INT3945AB G_MOW2	N
TM428 3WLMi	EMEA	TM4283WLMi XPHPL6 NB7PSE128SC 2*512/80/8L/5R_abg_1.3C_AN	SO512MBII 5	SO512MBII 5	N80GB5.4K S	INT3945AB G_MOW2	N
TM428 3WLMi	EMEA	TM4283WLMi XPHT1 NB7PSE128SC 2*512/80/8L/5R_abg_1.3C_AN	SO512MBII 5	SO512MBII 5	N80GB5.4K S	INT3945AB G_MOW2	N
TM428 3WLMi	EMEA	TM4283WLMi XPHSLO2 NB7PSE128SC 2*512/80/8L/5R_abg_1.3C_AN	SO512MBII 5	SO512MBII 5	N80GB5.4K S	INT3945AB G_MOW2	N
TM428 3WLMi	EMEA	TM4283WLMi XPHSV1 NB7PSE128SC 2*512/80/8L/5R_abg_1.3C_AN	SO512MBII 5	SO512MBII 5	N80GB5.4K S	INT3945AB G_MOW2	N
TM428 3WLMi	EMEA	TM4283WLMi XPHSA1 NB7PSE128SC 2*512/120/8L/5R_abg_1.3C_AN	SO512MBII 5	SO512MBII 5	N120GB5.4 KS	INT3945AB G_MOW2	N

TravelMate 4280

Model	RO	Description	Memory 1	Memory 2	HDD 1 (GB)	Wireless LAN	Bluetooth
TM428 3WLMi	EMEA	TM4283WLMi XPHSW5 NB7PSE128SC 2*512/80/8L/5R_abg_1.3C_AN	SO512MBII 5	SO512MBII 5	N80GB5.4K S	INT3945AB G_MOW2	N
TM428 3WLMi	EMEA	TM4283WLMi XPHSLO2 NB7PSE128SC 2*512/120/8L/5R_abg_1.3C_AN	SO512MBII 5	SO512MBII 5	N120GB5.4 KS	INT3945AB G_MOW2	N
TM428 3WLMi	EMEA	TM4283WLMi XPHSV1 NB7PSE128SC 2*512/120/8L/5R_abg_1.3C_AN	SO512MBII 5	SO512MBII 5	N120GB5.4 KS	INT3945AB G_MOW2	N
TM428 3WLMi	EMEA	TM4283WLMi XPHSA1 NB7PSE128SC 2*512/80/8L/5R_abg_1.3C_AN	SO512MBII 5	SO512MBII 5	N80GB5.4K S	INT3945AB G_MOW2	N
TM428 3WLMi	EMEA	TM4283WLMi XPHTR1 NB7PSE128SC 2*512/120/8L/5R_abg_1.3C_AN	SO512MBII 5	SO512MBII 5	N120GB5.4 KS	INT3945AB G_MOW2	N
TM428 3WLMi	EMEA	TM4283WLMi XPHSW5 NB7PSE128SC 2*512/120/8L/5R_abg_1.3C_AN	SO512MBII 5	SO512MBII 5	N120GB5.4 KS	INT3945AB G_MOW2	N
TM428 3WLMi	EMEA	TM4283WLMi XPHUK1 NB7PSE128SC 2*512/120/8L/5R_abg_1.3C_AN	SO512MBII 5	SO512MBII 5	N120GB5.4 KS	INT3945AB G_MOW2	N
TM428 3WLMi	EMEA	TM4283WLMi XPPBE1 NB7PSE128SC 1*512/80/8L/5R_abg_1.3C_AN	SO512MBII 5	N	N80GB5.4K S	INT3945AB G_MOW2	N
TM428 3WLMi	EMEA	TM4283WLMi XPPCS2 NB7PSE128SC 1*512/80/8L/5R_abg_1.3C_AN	SO512MBII 5	N	N80GB5.4K S	INT3945AB G_MOW2	N
TM428 3WLMi	EMEA	TM4283WLMi XPPAR1 NB7PSE128SC 1*512/80/8L/5R_abg_1.3C_AN	SO512MBII 5	N	N80GB5.4K S	INT3945AB G_MOW1	N
TM428 3WLMi	EMEA	TM4283WLMi XPPBE1 NB7PSE128SC 2*512/100/8L/5R_abg_1.3C_AN	SO512MBII 5	SO512MBII 5	N100GB5.4 KS	INT3945AB G_MOW2	N
TM428 3WLMi	EMEA	TM4283WLMi XPPAR1 NB7PSE128SC 2*512/100/8L/5R_abg_1.3C_AN	SO512MBII 5	SO512MBII 5	N100GB5.4 KS	INT3945AB G_MOW1	N
TM428 3WLMi	EMEA	TM4283WLMi XPHUK1 NB7PSE128SC 2*512/80/8L/5R_abg_1.3C_AN	SO512MBII 5	SO512MBII 5	N80GB5.4K S	INT3945AB G_MOW2	N
TM428 3WLMi	EMEA	TM4283WLMi XPHTR1 NB7PSE128SC 2*512/80/8L/5R_abg_1.3C_AN	SO512MBII 5	SO512MBII 5	N80GB5.4K S	INT3945AB G_MOW2	N
TM428 3WLMi	EMEA	TM4283WLMi XPPEL3 NB7PSE128SC 2*512/100/8L/5R_abg_1.3C_AN	SO512MBII 5	SO512MBII 5	N100GB5.4 KS	INT3945AB G_MOW2	N
TM428 3WLMi	EMEA	TM4283WLMi XPPDE7 NB7PSE128SC 2*512/100/8L/5R_abg_1.3C_AN	SO512MBII 5	SO512MBII 5	N100GB5.4 KS	INT3945AB G_MOW2	N
TM428 3WLMi	EMEA	TM4283WLMi XPPCS2 NB7PSE128SC 2*512/100/8L/5R_abg_1.3C_AN	SO512MBII 5	SO512MBII 5	N100GB5.4 KS	INT3945AB G_MOW2	N
TM428 3WLMi	EMEA	TM4283WLMi XPPESA NB7PSE128SC 2*512/100/8L/5R_abg_1.3C_AN	SO512MBII 5	SO512MBII 5	N100GB5.4 KS	INT3945AB G_MOW2	N

TravelMate 4280

Model	RO	Description	Memory 1	Memory 2	HDD 1 (GB)	Wireless LAN	Bluetooth
TM428 3WLMi	EMEA	TM4283WLMi XPPEL3 NB7PSE128SC 1*512/80/8L/5R_abg_1.3C_AN	SO512MBII 5	N	N80GB5.4K S	INT3945AB G_MOW2	N
TM428 3WLMi	EMEA	TM4283WLMi XPPDK1 NB7PSE128SC 2*512/100/8L/5R_abg_1.3C_AN	SO512MBII 5	SO512MBII 5	N100GB5.4 KS	INT3945AB G_MOW2	N
TM428 3WLMi	EMEA	TM4283WLMi XPPESA NB7PSE128SC 1*512/80/8L/5R_abg_1.3C_AN	SO512MBII 5	N	N80GB5.4K S	INT3945AB G_MOW2	N
TM428 3WLMi	EMEA	TM4283WLMi XPPDK1 NB7PSE128SC 1*512/80/8L/5R_abg_1.3C_AN	SO512MBII 5	N	N80GB5.4K S	INT3945AB G_MOW2	N
TM428 3WLMi	EMEA	TM4283WLMi XPPDE7 NB7PSE128SC 1*512/80/8L/5R_abg_1.3C_AN	SO512MBII 5	N	N80GB5.4K S	INT3945AB G_MOW2	N
TM428 3WLMi	EMEA	TM4283WLMi XPPFRA NB7PSE128SC 1*512/80/8L/5R_abg_1.3C_AN	SO512MBII 5	N	N80GB5.4K S	INT3945AB G_MOW2	N
TM428 3WLMi	EMEA	TM4283WLMi XPPIS1 NB7PSE128SC 1*512/80/8L/5R_bg_1.3C_AN	SO512MBII 5	N	N80GB5.4K S	INT3945BG	N
TM428 3WLMi	EMEA	TM4283WLMi XPPHU6 NB7PSE128SC 1*512/80/8L/5R_abg_1.3C_AN	SO512MBII 5	N	N80GB5.4K S	INT3945AB G_MOW2	N
TM428 3WLMi	EMEA	TM4283WLMi XPPIT1 NB7PSE128SC 1*512/80/8L/5R_abg_1.3C_AN	SO512MBII 5	N	N80GB5.4K S	INT3945AB G_MOW2	N
TM428 3WLMi	EMEA	TM4283WLMi XPPHU6 NB7PSE128SC 2*512/100/8L/5R_abg_1.3C_AN	SO512MBII 5	SO512MBII 5	N100GB5.4 KS	INT3945AB G_MOW2	N
TM428 3WLMi	EMEA	TM4283WLMi XPPIS1 NB7PSE128SC 2*512/100/8L/5R_bg_1.3C_AN	SO512MBII 5	SO512MBII 5	N100GB5.4 KS	INT3945BG	N
TM428 3WLMi	EMEA	TM4283WLMi XPPIT1 NB7PSE128SC 2*512/100/8L/5R_abg_1.3C_AN	SO512MBII 5	SO512MBII 5	N100GB5.4 KS	INT3945AB G_MOW2	N
TM428 3WLMi	EMEA	TM4283WLMi XPPFRA NB7PSE128SC 2*512/100/8L/5R_abg_1.3C_AN	SO512MBII 5	SO512MBII 5	N100GB5.4 KS	INT3945AB G_MOW2	N
TM428 3WLMi	EMEA	TM4283WLMi XPPNL1 NB7PSE128SC 2*512/100/8L/5R_abg_1.3C_AN	SO512MBII 5	SO512MBII 5	N100GB5.4 KS	INT3945AB G_MOW1	N
TM428 3WLMi	EMEA	TM4283WLMi XPPNO1 NB7PSE128SC 2*512/100/8L/5R_abg_1.3C_AN	SO512MBII 5	SO512MBII 5	N100GB5.4 KS	INT3945AB G_MOW2	N
TM428 3WLMi	EMEA	TM4283WLMi XPPPT1 NB7PSE128SC 2*512/100/8L/5R_abg_1.3C_AN	SO512MBII 5	SO512MBII 5	N100GB5.4 KS	INT3945AB G_MOW2	N
TM428 3WLMi	EMEA	TM4283WLMi XPPPL6 NB7PSE128SC 2*512/100/8L/5R_abg_1.3C_AN	SO512MBII 5	SO512MBII 5	N100GB5.4 KS	INT3945AB G_MOW2	N
TM428 3WLMi	EMEA	TM4283WLMi XPPPL6 NB7PSE128SC 1*512/80/8L/5R_abg_1.3C_AN	SO512MBII 5	N	N80GB5.4K S	INT3945AB G_MOW2	N

TravelMate 4280

Model	RO	Description	Memory 1	Memory 2	HDD 1 (GB)	Wireless LAN	Bluetooth
TM428 3WLMi	EMEA	TM4283WLMi XPPPT1 NB7PSE128SC 1*512/80/8L/5R_abg_1.3C_AN	SO512MBII 5	N	N80GB5.4K S	INT3945AB G_MOW2	N
TM428 3WLMi	EMEA	TM4283WLMi XPPNO1 NB7PSE128SC 1*512/80/8L/5R_abg_1.3C_AN	SO512MBII 5	N	N80GB5.4K S	INT3945AB G_MOW2	N
TM428 3WLMi	EMEA	TM4283WLMi XPPNL1 NB7PSE128SC 1*512/80/8L/5R_abg_1.3C_AN	SO512MBII 5	N	N80GB5.4K S	INT3945AB G_MOW1	N
TM428 3WLMi	EMEA	TM4283WLMi XPPSA1 NB7PSE128SC 1*512/80/8L/5R_abg_1.3C_AN	SO512MBII 5	N	N80GB5.4K S	INT3945AB G_MOW2	N
TM428 3WLMi	EMEA	TM4283WLMi XPPRU2 NB7PSE128SC 1*512/80/8L/5R_abg_1.3C_AN	SO512MBII 5	N	N80GB5.4K S	INT3945AB G_MOW2	N
TM428 3WLMi	EMEA	TM4283WLMi XPPSLO1 NB7PSE128SC 1*512/80/8L/5R_abg_1.3C_AN	SO512MBII 5	N	N80GB5.4K S	INT3945AB G_MOW2	N
TM428 3WLMi	EMEA	TM4283WLMi XPPSV1 NB7PSE128SC 1*512/80/8L/5R_abg_1.3C_AN	SO512MBII 5	N	N80GB5.4K S	INT3945AB G_MOW2	N
TM428 3WLMi	EMEA	TM4283WLMi XPPSA1 NB7PSE128SC 2*512/100/8L/5R_abg_1.3C_AN	SO512MBII 5	SO512MBII 5	N100GB5.4 KS	INT3945AB G_MOW2	N
TM428 3WLMi	EMEA	TM4283WLMi XPPSW5 NB7PSE128SC 1*512/80/8L/5R_abg_1.3C_AN	SO512MBII 5	N	N80GB5.4K S	INT3945AB G_MOW2	N
TM428 3WLMi	EMEA	TM4283WLMi XPPSLO1 NB7PSE128SC 2*512/100/8L/5R_abg_1.3C_AN	SO512MBII 5	SO512MBII 5	N100GB5.4 KS	INT3945AB G_MOW2	N
TM428 3WLMi	EMEA	TM4283WLMi XPPRU2 NB7PSE128SC 2*512/100/8L/5R_abg_1.3C_AN	SO512MBII 5	SO512MBII 5	N100GB5.4 KS	INT3945AB G_MOW2	N
TM428 3WLMi	EMEA	TM4283WLMi XPPSV1 NB7PSE128SC 2*512/100/8L/5R_abg_1.3C_AN	SO512MBII 5	SO512MBII 5	N100GB5.4 KS	INT3945AB G_MOW2	N
TM428 3WLMi	EMEA	TM4283WLMi XPPTR1 NB7PSE128SC 2*512/100/8L/5R_abg_1.3C_AN	SO512MBII 5	SO512MBII 5	N100GB5.4 KS	INT3945AB G_MOW2	N
TM428 3WLMi	EMEA	TM4283WLMi XPPSW5 NB7PSE128SC 2*512/100/8L/5R_abg_1.3C_AN	SO512MBII 5	SO512MBII 5	N100GB5.4 KS	INT3945AB G_MOW2	N
TM428 3WLMi	EMEA	TM4283WLMi XPPUK1 NB7PSE128SC 2*512/100/8L/5R_abg_1.3C_AN	SO512MBII 5	SO512MBII 5	N100GB5.4 KS	INT3945AB G_MOW2	N
TM428 3WLMi	EMEA	TM4283WLMi XPPUK1 NB7PSE128SC 1*512/80/8L/5R_abg_1.3C_AN	SO512MBII 5	N	N80GB5.4K S	INT3945AB G_MOW2	N
TM428 3WLMi	EMEA	TM4283WLMi XPPTR1 NB7PSE128SC 1*512/80/8L/5R_abg_1.3C_AN	SO512MBII 5	N	N80GB5.4K S	INT3945AB G_MOW2	N
TM428 5WLMi	AAP	TM4285WLMi XPPAU1 NB7PSE128SC 2*512/100/BT/8L/5R_abg_1.3C_AN	SO512MBII 5	SO512MBII 5	N100GB5.4 KS	INT3945AB G_MOW1	FOX_BRM_2.0

TravelMate 4280

Model	RO	Description	Memory 1	Memory 2	HDD 1 (GB)	Wireless LAN	Bluetooth
TM428 5WLMi	PA	TM4285WLMi XPPEN1 NB7PSE128SC 2*512/100/ BT/8L/5R_abg_1.3C_AN	SO512MBII 5	SO512MBII 5	N100GB5.4 KS	INT3945AB G_MOW1	FOX_BRM_2.0
TM428 5WLMi	AAP	TM4285WLMi XPPTH2 NB7PSE128SC 2*512/100/ BT/8L/5R_bg_1.3C_AN	SO512MBII 5	SO512MBII 5	N100GB5.4 KS	INT3945BG	FOX_BRM_2.0
TM428 5WLMi	PA	TM4285WLMi XPPFR1 NB7PSE128SC 2*512/100/ BT/8L/5R_abg_1.3C_AN	SO512MBII 5	SO512MBII 5	N100GB5.4 KS	INT3945AB G_MOW1	FOX_BRM_2.0
TM428 5WLMi	PA	TM4285WLMi XPPES1 NB7PSE128SC 2*512/100/ BT/8L/5R_abg_1.3C_AN	SO512MBII 5	SO512MBII 5	N100GB5.4 KS	INT3945AB G_MOW1	FOX_BRM_2.0
TM428 5WLMi	PA	TM4285WLMi XPPXC1 NB7PSE128SC 2*512/100/ BT/8L/5R_abg_1.3C_AN	SO512MBII 5	SO512MBII 5	N100GB5.4 KS	INT3945AB G_MOW2	FOX_BRM_2.0
TM428 5WLMi	AAP	TM4285WLMi XPPIN1 NB7PSE128SC 2*512/100/ BT/8L/5R_abg_1.3C_AN	SO512MBII 5	SO512MBII 5	N100GB5.4 KS	INT3945AB G_MOW1	FOX_BRM_2.0
TM428 5WLMi	AAP	TM4285WLMi XPPMA2 NB7PSE128SC 2*512/100/ BT/8L/5R_abg_1.3C_AN	SO512MBII 5	SO512MBII 5	N100GB5.4 KS	INT3945AB G_MOW1	FOX_BRM_2.0
TM428 5WLMi	AAP	TM4285WLMi XPPWSG21W NB7PSE128SC 2*512/100/ BT/8L/5R_abg_1.3C_AN	SO512MBII 5	SO512MBII 5	N100GB5.4 KS	INT3945AB G_MOW2	FOX_BRM_2.0
TM428 4WLMi	EMEA	TM4284WLMi XPPAR8 NB7PSE128SC 2*512/100/ BT/8L/5R_abg_1.3C_AN	SO512MBII 5	SO512MBII 5	N100GB5.4 KS	INT3945AB G_MOW1	FOX_BRM_2.0
TM428 3WLMi	EMEA	TM4283WLMi XPPPL6 NB7PSE128SC 1*512/100/ BT/8L/5R_abg_1.3C_AN	SO512MBII 5	N	N100GB5.4 KS	INT3945AB G_MOW2	FOX_BRM_2.0
TM428 3WLMi	EMEA	TM4283WLMi XPPPL6 NB7PSE128SC 2*512/120/ BT/8L/5R_abg_1.3C_AN	SO512MBII 5	SO512MBII 5	N120GB5.4 KS	INT3945AB G_MOW2	FOX_BRM_2.0
TM428 3WLMi	EMEA	TM4283WLMi XPPCS2 NB7PSE128SC 2*512/100/ BT/8L/5R_abg_1.3C_AN	SO512MBII 5	SO512MBII 5	N100GB5.4 KS	INT3945AB G_MOW2	FOX_BRM_2.0
TM428 3WLMi	EMEA	TM4283WLMi XPPAR2 NB7PSE128SC 2*512/100/ BT/8L/5R_bg_1.3C_AN	SO512MBII 5	SO512MBII 5	N100GB5.4 KS	INT3945BG	FOX_BRM_2.0
TM428 5WLMi	EMEA	TM4285WLMi XPPSA1 NB7PSE128SC 2*512/120/ BT/8L/5R_abg_1.3C_AN	SO512MBII 5	SO512MBII 5	N120GB5.4 KS	INT3945AB G_MOW2	FOX_BRM_2.0
TM428 4WLMi	EMEA	TM4284WLMi XPPAR2 NB7PSE128SC 2*512/100/ BT/8L/5R_bg_1.3C_AN	SO512MBII 5	SO512MBII 5	N100GB5.4 KS	INT3945BG	FOX_BRM_2.0
TM428 3WLMi	EMEA	TM4283WLMi MCEFRF NB7PSE128SC 2*512/120/ 8L/5R_abg_1.3C_AN	SO512MBII 5	SO512MBII 5	N120GB5.4 KS	INT3945AB G_MOW2	N
TM428 3WLMi	EMEA	TM4283WLMi MCEDEB NB7PSE128SC 2*512/120/ 8L/5R_abg_1.3C_AN	SO512MBII 5	SO512MBII 5	N120GB5.4 KS	INT3945AB G_MOW2	N
TM428 3WLMi	EMEA	TM4283WLMi MCEBE6 NB7PSE128SC 2*512/120/ 8L/5R_abg_1.3C_AN	SO512MBII 5	SO512MBII 5	N120GB5.4 KS	INT3945AB G_MOW2	N

TravelMate 4280

Model	RO	Description	Memory 1	Memory 2	HDD 1 (GB)	Wireless LAN	Bluetooth
TM428 3WLMi	EMEA	TM4283WLMi MCEAR1 NB7PSE128SC 2*512/120/8L/5R_bg_1.3C_AN	SO512MBII 5	SO512MBII 5	N120GB5.4 KS	INT3945BG	N
TM428 3WLMi	EMEA	TM4283WLMi MCEAR2 NB7PSE128SC 2*512/120/8L/5R_bg_1.3C_AN	SO512MBII 5	SO512MBII 5	N120GB5.4 KS	INT3945BG	N
TM428 3WLMi	EMEA	TM4283WLMi MCESW8 NB7PSE128SC 2*512/120/8L/5R_abg_1.3C_AN	SO512MBII 5	SO512MBII 5	N120GB5.4 KS	INT3945AB G_MOW2	N
TM428 3WLMi	EMEA	TM4283WLMi MCEUK5 NB7PSE128SC 2*512/120/8L/5R_abg_1.3C_AN	SO512MBII 5	SO512MBII 5	N120GB5.4 KS	INT3945AB G_MOW2	N
TM428 3WLMi	EMEA	TM4283WLMi MCENL6 NB7PSE128SC 2*512/120/8L/5R_abg_1.3C_AN	SO512MBII 5	SO512MBII 5	N120GB5.4 KS	INT3945AB G_MOW1	N
TM428 3WLMi	EMEA	TM4283WLMi MCESI1 NB7PSE128SC 2*512/120/8L/5R_abg_1.3C_AN	SO512MBII 5	SO512MBII 5	N120GB5.4 KS	INT3945AB G_MOW2	N
TM428 3WLMi	EMEA	TM4283WLMi MCEIT7 NB7PSE128SC 2*512/120/8L/5R_abg_1.3C_AN	SO512MBII 5	SO512MBII 5	N120GB5.4 KS	INT3945AB G_MOW2	N
TM428 3WLMi	EMEA	TM4283WLMi MCEWFR11W NB7PSE128SC 2*512/120/8L/5R_abg_1.3C_AN	SO512MBII 5	SO512MBII 5	N120GB5.4 KS	INT3945AB G_MOW2	N
TM428 3WLMi	EMEA	TM4283WLMi MCEWIT11W NB7PSE128SC 2*512/120/8L/5R_abg_1.3C_AN	SO512MBII 5	SO512MBII 5	N120GB5.4 KS	INT3945AB G_MOW2	N
TM428 3WLMi	EMEA	TM4283WLMi MCEWUK11W NB7PSE128SC 2*512/120/8L/5R_abg_1.3C_AN	SO512MBII 5	SO512MBII 5	N120GB5.4 KS	INT3945AB G_MOW2	N
TM428 3WLMi	EMEA	TM4283WLMi XPPSA1 NB7PSE128SC 2*512/100/BT/8L/5R_abg_1.3C_AN	SO512MBII 5	SO512MBII 5	N100GB5.4 KS	INT3945AB G_MOW2	FOX_BRM_2.0
TM428 3WLMi	EMEA	TM4283WLMi XPPPL6 NB7PSE128SC 1*512/80/BT/8L/5R_abg_1.3C_AN	SO512MBII 5	N	N80GB5.4KS	INT3945AB G_MOW2	FOX_BRM_2.0
TM428 3WLMi	EMEA	TM4283WLMi XPPPL6 NB7PSE128SC 1*1G/120/BT/8L/5R_abg_1.3C_AN	SO1GBII5	N	N120GB5.4 KS	INT3945AB G_MOW2	FOX_BRM_2.0
TM428 3WLMi	EMEA	TM4283WLMi XPPDE1 NB7PSE128SC 2*512/120/8L/5R_abg_1.3C_AN	SO512MBII 5	SO512MBII 5	N120GB5.4 KS	INT3945AB G_MOW2	N
TM428 3WLMi	EMEA	TM4283WLMi XPPSA1 NB7PSE128SC 2*512/120/BT/6L/5R_abg_1.3C_AN	SO512MBII 5	SO512MBII 5	N120GB5.4 KS	INT3945AB G_MOW2	FOX_BRM_2.0
TM428 4WLMi	EMEA	TM4284WLMi XPPSA1 NB7PSE128SC 2*512/120/BT/6L/5R_abg_1.3C_AN	SO512MBII 5	SO512MBII 5	N120GB5.4 KS	INT3945AB G_MOW2	FOX_BRM_2.0
TM428 3WLMi	EMEA	TM4283WLMi XPPDK1 NB7PSE128SC 2*512/120/8L/5R_abg_1.3C_AN	SO512MBII 5	SO512MBII 5	N120GB5.4 KS	INT3945AB G_MOW2	N

TravelMate 4280

Model	RO	Description	Memory 1	Memory 2	HDD 1 (GB)	Wireless LAN	Bluetooth
TM428 3WLMi	EMEA	TM4283WLMi XPPBE1 NB7PSE128SC 2*512/120/8L/5R_abg_1.3C_AN	SO512MBII 5	SO512MBII 5	N120GB5.4 KS	INT3945AB G_MOW2	N
TM428 3WLMi	EMEA	TM4283WLMi XPPAR1 NB7PSE128SC 2*512/120/8L/5R_abg_1.3C_AN	SO512MBII 5	SO512MBII 5	N120GB5.4 KS	INT3945AB G_MOW2	N
TM428 3WLMi	EMEA	TM4283WLMi XPPDE7 NB7PSE128SC 2*512/120/8L/5R_abg_1.3C_AN	SO512MBII 5	SO512MBII 5	N120GB5.4 KS	INT3945AB G_MOW2	N
TM428 3WLMi	EMEA	TM4283WLMi XPPCS2 NB7PSE128SC 2*512/120/8L/5R_abg_1.3C_AN	SO512MBII 5	SO512MBII 5	N120GB5.4 KS	INT3945AB G_MOW2	N
TM428 3WLMi	EMEA	TM4283WLMi XPPHU6 NB7PSE128SC 2*512/120/8L/5R_abg_1.3C_AN	SO512MBII 5	SO512MBII 5	N120GB5.4 KS	INT3945AB G_MOW2	N
TM428 3WLMi	EMEA	TM4283WLMi XPPESA NB7PSE128SC 2*512/120/8L/5R_abg_1.3C_AN	SO512MBII 5	SO512MBII 5	N120GB5.4 KS	INT3945AB G_MOW2	N
TM428 3WLMi	EMEA	TM4283WLMi XPPIS1 NB7PSE128SC 2*512/120/8L/5R_abg_1.3C_AN	SO512MBII 5	SO512MBII 5	N120GB5.4 KS	INT3945AB G_MOW2	N
TM428 3WLMi	EMEA	TM4283WLMi XPPIT1 NB7PSE128SC 2*512/120/8L/5R_abg_1.3C_AN	SO512MBII 5	SO512MBII 5	N120GB5.4 KS	INT3945AB G_MOW2	N
TM428 3WLMi	EMEA	TM4283WLMi XPPFRA NB7PSE128SC 2*512/120/8L/5R_abg_1.3C_AN	SO512MBII 5	SO512MBII 5	N120GB5.4 KS	INT3945AB G_MOW2	N
TM428 3WLMi	EMEA	TM4283WLMi XPPEL3 NB7PSE128SC 2*512/120/8L/5R_abg_1.3C_AN	SO512MBII 5	SO512MBII 5	N120GB5.4 KS	INT3945AB G_MOW2	N
TM428 3WLMi	EMEA	TM4283WLMi XPPNL1 NB7PSE128SC 2*512/120/8L/5R_abg_1.3C_AN	SO512MBII 5	SO512MBII 5	N120GB5.4 KS	INT3945AB G_MOW2	N
TM428 3WLMi	EMEA	TM4283WLMi XPPNO1 NB7PSE128SC 2*512/120/8L/5R_abg_1.3C_AN	SO512MBII 5	SO512MBII 5	N120GB5.4 KS	INT3945AB G_MOW2	N
TM428 3WLMi	EMEA	TM4283WLMi XPPRU2 NB7PSE128SC 2*512/120/8L/5R_abg_1.3C_AN	SO512MBII 5	SO512MBII 5	N120GB5.4 KS	INT3945AB G_MOW2	N
TM428 3WLMi	EMEA	TM4283WLMi XPPPT1 NB7PSE128SC 2*512/120/8L/5R_abg_1.3C_AN	SO512MBII 5	SO512MBII 5	N120GB5.4 KS	INT3945AB G_MOW2	N
TM428 3WLMi	EMEA	TM4283WLMi XPPPL6 NB7PSE128SC 2*512/120/8L/5R_abg_1.3C_AN	SO512MBII 5	SO512MBII 5	N120GB5.4 KS	INT3945AB G_MOW2	N
TM428 3WLMi	EMEA	TM4283WLMi XPPSLO1 NB7PSE128SC 2*512/120/8L/5R_abg_1.3C_AN	SO512MBII 5	SO512MBII 5	N120GB5.4 KS	INT3945AB G_MOW2	N
TM428 3WLMi	EMEA	TM4283WLMi XPPSV1 NB7PSE128SC 2*512/120/8L/5R_abg_1.3C_AN	SO512MBII 5	SO512MBII 5	N120GB5.4 KS	INT3945AB G_MOW2	N
TM428 3WLMi	EMEA	TM4283WLMi XPPSA1 NB7PSE128SC 2*512/120/8L/5R_abg_1.3C_AN	SO512MBII 5	SO512MBII 5	N120GB5.4 KS	INT3945AB G_MOW2	N

TravelMate 4280

Model	RO	Description	Memory 1	Memory 2	HDD 1 (GB)	Wireless LAN	Bluetooth
TM428 3WLMi	EMEA	TM4283WLMi XPPSW5 NB7PSE128SC 2*512/120/8L/5R_abg_1.3C_AN	SO512MBII 5	SO512MBII 5	N120GB5.4 KS	INT3945AB G_MOW2	N
TM428 3WLMi	EMEA	TM4283WLMi XPPTTR1 NB7PSE128SC 2*512/120/8L/5R_abg_1.3C_AN	SO512MBII 5	SO512MBII 5	N120GB5.4 KS	INT3945AB G_MOW2	N
TM428 3WLMi	EMEA	TM4283WLMi XPPUK1 NB7PSE128SC 2*512/120/8L/5R_abg_1.3C_AN	SO512MBII 5	SO512MBII 5	N120GB5.4 KS	INT3945AB G_MOW2	N

TravelMate 4230

Model	RO	Description	CPU	LCD	Memory 1	Memory 2	HDD 1 (GB)	Wireless LAN	Bluetooth
TM423 3WLMi	EMEA	TM4233WLMi XPHBE1 G72MV128C 1*512/100/6L/5R_abg_1.3C_AN	C2DT5 500	N15.4W XGA	SO512M BII5	N	N100G B5.4K	INT3945A BG_MO W2	N
TM423 3WLMi	EMEA	TM4233WLMi XPHAR1 G72MV128C 1*512/100/6L/5R_abg_1.3C_AN	C2DT5 500	N15.4W XGA	SO512M BII5	N	N100G B5.4K	INT3945A BG_MO W1	N
TM423 3WLMi	EMEA	TM4233WLMi XPHBE1 G72MV128C 2*512/120/6L/5R_abg_1.3C_AN	C2DT5 500	N15.4W XGA	SO512M BII5	SO512M BII5	N120G B5.4K	INT3945A BG_MO W2	N
TM423 3WLMi	EMEA	TM4233WLMi XPHAR1 G72MV128C 2*512/120/6L/5R_abg_1.3C_AN	C2DT5 500	N15.4W XGA	SO512M BII5	SO512M BII5	N120G B5.4K	INT3945A BG_MO W1	N
TM423 3WLMi	EMEA	TM4233WLMi XPHL1 G72MV128C 2*512/120/6L/5R_abg_1.3C_AN	C2DT5 500	N15.4W XGA	SO512M BII5	SO512M BII5	N120G B5.4K	INT3945A BG_MO W2	N
TM423 3WLMi	EMEA	TM4233WLMi XPHDK1 G72MV128C 2*512/120/6L/5R_abg_1.3C_AN	C2DT5 500	N15.4W XGA	SO512M BII5	SO512M BII5	N120G B5.4K	INT3945A BG_MO W2	N
TM423 3WLMi	EMEA	TM4233WLMi XPHDE7 G72MV128C 2*512/120/6L/5R_abg_1.3C_AN	C2DT5 500	N15.4W XGA	SO512M BII5	SO512M BII5	N120G B5.4K	INT3945A BG_MO W2	N
TM423 3WLMi	EMEA	TM4233WLMi XPHCS2 G72MV128C 2*512/120/6L/5R_abg_1.3C_AN	C2DT5 500	N15.4W XGA	SO512M BII5	SO512M BII5	N120G B5.4K	INT3945A BG_MO W2	N
TM423 3WLMi	EMEA	TM4233WLMi XPHDE7 G72MV128C 1*512/100/6L/5R_abg_1.3C_AN	C2DT5 500	N15.4W XGA	SO512M BII5	N	N100G B5.4K	INT3945A BG_MO W2	N

TravelMate 4230

Model	RO	Description	CPU	LCD	Memory 1	Memory 2	HDD 1 (GB)	Wireless LAN	Bluetooth
TM423 3WLMi	EMEA	TM4233WLMi XPHCS2 G72MV128C 1*512/ 100/6L/ 5R_abg_1.3C_AN	C2DT5 500	N15.4W XGA	SO512M BII5	N	N100G B5.4K	INT3945A BG_MO W2	N
TM423 3WLMi	EMEA	TM4233WLMi XPHESA G72MV128C 1*512/ 100/6L/ 5R_abg_1.3C_AN	C2DT5 500	N15.4W XGA	SO512M BII5	N	N100G B5.4K	INT3945A BG_MO W2	N
TM423 3WLMi	EMEA	TM4233WLMi XPHL1 G72MV128C 1*512/ 100/6L/ 5R_abg_1.3C_AN	C2DT5 500	N15.4W XGA	SO512M BII5	N	N100G B5.4K	INT3945A BG_MO W2	N
TM423 3WLMi	EMEA	TM4233WLMi XPHDK1 G72MV128C 1*512/ 100/6L/ 5R_abg_1.3C_AN	C2DT5 500	N15.4W XGA	SO512M BII5	N	N100G B5.4K	INT3945A BG_MO W2	N
TM423 3WLMi	EMEA	TM4233WLMi XPHIS1 G72MV128C 1*512/ 100/6L/ 5R_bg_1.3C_AN	C2DT5 500	N15.4W XGA	SO512M BII5	N	N100G B5.4K	INT3945B G	N
TM423 3WLMi	EMEA	TM4233WLMi XPHIT1 G72MV128C 1*512/ 100/6L/ 5R_abg_1.3C_AN	C2DT5 500	N15.4W XGA	SO512M BII5	N	N100G B5.4K	INT3945A BG_MO W2	N
TM423 3WLMi	EMEA	TM4233WLMi XPHHU6 G72MV128C 1*512/ 100/6L/ 5R_abg_1.3C_AN	C2DT5 500	N15.4W XGA	SO512M BII5	N	N100G B5.4K	INT3945A BG_MO W2	N
TM423 3WLMi	EMEA	TM4233WLMi XPHFRA G72MV128C 1*512/ 100/6L/ 5R_abg_1.3C_AN	C2DT5 500	N15.4W XGA	SO512M BII5	N	N100G B5.4K	INT3945A BG_MO W2	N
TM423 3WLMi	EMEA	TM4233WLMi XPHHU6 G72MV128C 2*512/ 120/6L/ 5R_abg_1.3C_AN	C2DT5 500	N15.4W XGA	SO512M BII5	SO512M BII5	N120G B5.4K	INT3945A BG_MO W2	N
TM423 3WLMi	EMEA	TM4233WLMi XPHFRA G72MV128C 2*512/ 120/6L/ 5R_abg_1.3C_AN	C2DT5 500	N15.4W XGA	SO512M BII5	SO512M BII5	N120G B5.4K	INT3945A BG_MO W2	N
TM423 3WLMi	EMEA	TM4233WLMi XPHESA G72MV128C 2*512/ 120/6L/ 5R_abg_1.3C_AN	C2DT5 500	N15.4W XGA	SO512M BII5	SO512M BII5	N120G B5.4K	INT3945A BG_MO W2	N
TM423 3WLMi	EMEA	TM4233WLMi XPHIS1 G72MV128C 2*512/ 120/6L/ 5R_bg_1.3C_AN	C2DT5 500	N15.4W XGA	SO512M BII5	SO512M BII5	N120G B5.4K	INT3945B G	N
TM423 3WLMi	EMEA	TM4233WLMi XPHIT1 G72MV128C 2*512/ 120/6L/ 5R_abg_1.3C_AN	C2DT5 500	N15.4W XGA	SO512M BII5	SO512M BII5	N120G B5.4K	INT3945A BG_MO W2	N
TM423 3WLMi	EMEA	TM4233WLMi XPHPT1 G72MV128C 2*512/ 120/6L/ 5R_abg_1.3C_AN	C2DT5 500	N15.4W XGA	SO512M BII5	SO512M BII5	N120G B5.4K	INT3945A BG_MO W2	N

TravelMate 4230

Model	RO	Description	CPU	LCD	Memory 1	Memory 2	HDD 1 (GB)	Wireless LAN	Bluetooth
TM423 3WLMi	EMEA	TM4233WLMi XPHNO1 G72MV128C 2*512/120/6L/5R_abg_1.3C_AN	C2DT5 500	N15.4W XGA	SO512M BII5	SO512M BII5	N120G B5.4K	INT3945A BG_MO W2	N
TM423 3WLMi	EMEA	TM4233WLMi XPHPL6 G72MV128C 2*512/120/6L/5R_abg_1.3C_AN	C2DT5 500	N15.4W XGA	SO512M BII5	SO512M BII5	N120G B5.4K	INT3945A BG_MO W2	N
TM423 3WLMi	EMEA	TM4233WLMi XPHNL1 G72MV128C 2*512/120/6L/5R_abg_1.3C_AN	C2DT5 500	N15.4W XGA	SO512M BII5	SO512M BII5	N120G B5.4K	INT3945A BG_MO W1	N
TM423 3WLMi	EMEA	TM4233WLMi XPHNL1 G72MV128C 1*512/100/6L/5R_abg_1.3C_AN	C2DT5 500	N15.4W XGA	SO512M BII5	N	N100G B5.4K	INT3945A BG_MO W1	N
TM423 3WLMi	EMEA	TM4233WLMi XPHNO1 G72MV128C 1*512/100/6L/5R_abg_1.3C_AN	C2DT5 500	N15.4W XGA	SO512M BII5	N	N100G B5.4K	INT3945A BG_MO W2	N
TM423 3WLMi	EMEA	TM4233WLMi XPHRU2 G72MV128C 1*512/100/6L/5R_abg_1.3C_AN	C2DT5 500	N15.4W XGA	SO512M BII5	N	N100G B5.4K	INT3945A BG_MO W2	N
TM423 3WLMi	EMEA	TM4233WLMi XPHPL6 G72MV128C 1*512/100/6L/5R_abg_1.3C_AN	C2DT5 500	N15.4W XGA	SO512M BII5	N	N100G B5.4K	INT3945A BG_MO W2	N
TM423 3WLMi	EMEA	TM4233WLMi XPHPT1 G72MV128C 1*512/100/6L/5R_abg_1.3C_AN	C2DT5 500	N15.4W XGA	SO512M BII5	N	N100G B5.4K	INT3945A BG_MO W2	N
TM423 3WLMi	EMEA	TM4233WLMi XPHSLO2 G72MV128C 1*512/100/6L/5R_abg_1.3C_AN	C2DT5 500	N15.4W XGA	SO512M BII5	N	N100G B5.4K	INT3945A BG_MO W2	N
TM423 3WLMi	EMEA	TM4233WLMi XPHSV1 G72MV128C 1*512/100/6L/5R_abg_1.3C_AN	C2DT5 500	N15.4W XGA	SO512M BII5	N	N100G B5.4K	INT3945A BG_MO W2	N
TM423 3WLMi	EMEA	TM4233WLMi XPHSA1 G72MV128C 1*512/100/6L/5R_abg_1.3C_AN	C2DT5 500	N15.4W XGA	SO512M BII5	N	N100G B5.4K	INT3945A BG_MO W2	N
TM423 3WLMi	EMEA	TM4233WLMi XPHSA1 G72MV128C 2*512/120/6L/5R_abg_1.3C_AN	C2DT5 500	N15.4W XGA	SO512M BII5	SO512M BII5	N120G B5.4K	INT3945A BG_MO W2	N
TM423 3WLMi	EMEA	TM4233WLMi XPHSW5 G72MV128C 1*512/100/6L/5R_abg_1.3C_AN	C2DT5 500	N15.4W XGA	SO512M BII5	N	N100G B5.4K	INT3945A BG_MO W2	N
TM423 3WLMi	EMEA	TM4233WLMi XPHSV1 G72MV128C 2*512/120/6L/5R_abg_1.3C_AN	C2DT5 500	N15.4W XGA	SO512M BII5	SO512M BII5	N120G B5.4K	INT3945A BG_MO W2	N

TravelMate 4230

Model	RO	Description	CPU	LCD	Memory 1	Memory 2	HDD 1 (GB)	Wireless LAN	Blueto oth
TM423 3WLMi	EMEA	TM4233WLMi XPHRU2 G72MV128C 2*512/120/6L/5R_abg_1.3C_AN	C2DT5 500	N15.4W XGA	SO512M BII5	SO512M BII5	N120G B5.4K	INT3945A BG_MO W2	N
TM423 3WLMi	EMEA	TM4233WLMi XPHSLO2 G72MV128C 2*512/120/6L/5R_abg_1.3C_AN	C2DT5 500	N15.4W XGA	SO512M BII5	SO512M BII5	N120G B5.4K	INT3945A BG_MO W2	N
TM423 3WLMi	EMEA	TM4233WLMi XPHSW5 G72MV128C 2*512/120/6L/5R_abg_1.3C_AN	C2DT5 500	N15.4W XGA	SO512M BII5	SO512M BII5	N120G B5.4K	INT3945A BG_MO W2	N
TM423 3WLMi	EMEA	TM4233WLMi XPHUK1 G72MV128C 2*512/120/6L/5R_abg_1.3C_AN	C2DT5 500	N15.4W XGA	SO512M BII5	SO512M BII5	N120G B5.4K	INT3945A BG_MO W2	N
TM423 3WLMi	EMEA	TM4233WLMi XPHTR1 G72MV128C 2*512/120/6L/5R_abg_1.3C_AN	C2DT5 500	N15.4W XGA	SO512M BII5	SO512M BII5	N120G B5.4K	INT3945A BG_MO W2	N
TM423 3WLMi	EMEA	TM4233WLMi XPHUK1 G72MV128C 1*512/100/6L/5R_abg_1.3C_AN	C2DT5 500	N15.4W XGA	SO512M BII5	N	N100G B5.4K	INT3945A BG_MO W2	N
TM423 3WLMi	EMEA	TM4233WLMi XPHTR1 G72MV128C 1*512/100/6L/5R_abg_1.3C_AN	C2DT5 500	N15.4W XGA	SO512M BII5	N	N100G B5.4K	INT3945A BG_MO W2	N
TM423 3WLMi	EMEA	TM4233WLMi XPHPL6 G72MV128C 1*512/100/BT/6L/5R_abg_1.3C_AN	C2DT5 500	N15.4W XGA	SO512M BII5	N	N100G B5.4K	INT3945A BG_MO W2	FOX_B RM_2.0
TM423 3WLMi	EMEA	TM4233WLMi XPHPL6 G72MV128C 2*512/120/BT/6L/5R_abg_1.3C_AN	C2DT5 500	N15.4W XGA	SO512M BII5	SO512M BII5	N120G B5.4K	INT3945A BG_MO W2	FOX_B RM_2.0
TM423 5WLMi	AAP	TM4235WLMi XPHPH1 G72MV128C 2*512/120/BT/8L/5R_abg_1.3C_AN	C2DT7 200	N15.4W XGAF	SO512M BII5	SO512M BII5	N120G B5.4K	INT3945A BG_MO W2	FOX_B RM_2.0
TM423 3WLMi	AAP	TM4233WLMi XPHAU1 G72MV128C 1*1G/120/8L/5R_abg_1.3C_AN	C2DT5 500	N15.4W XGAF	SO1GBII 5	N	N120G B5.4K	INT3945A BG_MO W1	N
TM423 3WLMi	AAP	TM4233WLMi XPHPH1 G72MV128C 1*1G/120/8L/5R_abg_1.3C_AN	C2DT5 500	N15.4W XGAF	SO1GBII 5	N	N120G B5.4K	INT3945A BG_MO W2	N
TM423 3WLMi	AAP	TM4233WLMi XPPAU1 G72MV128C 1*1G/120/8L/5R_abg_1.3C_AN	C2DT5 500	N15.4W XGAF	SO1GBII 5	N	N120G B5.4K	INT3945A BG_MO W1	N
TM423 4WLMi	AAP	TM4234WLMi XPPAU1 G72MV128C 1*1G/120/8L/5R_abg_1.3C_AN	C2DT5 600	N15.4W XGAF	SO1GBII 5	N	N120G B5.4K	INT3945A BG_MO W1	N
TM423 4WLMi	AAP	TM4234WLMi XPHAU1 G72MV128C 1*1G/120/8L/5R_abg_1.3C_AN	C2DT5 600	N15.4W XGAF	SO1GBII 5	N	N120G B5.4K	INT3945A BG_MO W1	N

TravelMate 4230

Model	RO	Description	CPU	LCD	Memory 1	Memory 2	HDD 1 (GB)	Wireless LAN	Bluetooth
TM423 4WLMi	EMEA	TM4234WLMi XPPAR8 G72MV128C 2*512/100/BT/8L/5R_bg_1.3C_AN	C2DT5 600	N15.4W XGA	SO512M BII5	SO512M BII5	N100G B5.4K	INT3945A BG_MO W1	FOX_B RM_2.0
TM423 3WLMi	EMEA	TM4233WLMi XPPDE7 G72MV128C 1*512/100/6L/5R_abg_1.3C_AN	C2DT5 500	N15.4W XGA	SO512M BII5	N	N100G B5.4K	INT3945A BG_MO W2	N
TM423 3WLMi	EMEA	TM4233WLMi XPHDK1 G72MV128C 1*512/60/6L/5R_abg_1.3C_AN	C2DT5 500	N15.4W XGA	SO512M BII5	N	N60GB 5.4K	INT3945A BG_MO W2	N
TM423 3WLMi	EMEA	TM4233WLMi MCEAR1 G72MV128C 1*512/100/6L/5R_bg_1.3C_AN	C2DT5 500	N15.4W XGA	SO512M BII5	N	N100G B5.4K	INT3945B G	N
TM423 3WLMi	EMEA	TM4233WLMi MCEAR2 G72MV128C 1*512/100/6L/5R_bg_1.3C_AN	C2DT5 500	N15.4W XGA	SO512M BII5	N	N100G B5.4K	INT3945B G	N
TM423 3WLMi	EMEA	TM4233WLMi MCEAR1 G72MV128C 2*512/120/6L/5R_bg_1.3C_AN	C2DT5 500	N15.4W XGA	SO512M BII5	SO512M BII5	N120G B5.4K	INT3945A BG_MO W2	N
TM423 3WLMi	EMEA	TM4233WLMi MCEAR2 G72MV128C 2*512/120/6L/5R_bg_1.3C_AN	C2DT5 500	N15.4W XGA	SO512M BII5	SO512M BII5	N120G B5.4K	INT3945A BG_MO W2	N
TM423 3WLMi	EMEA	TM4233WLMi MCEDEB G72MV128C 1*512/100/6L/5R_abg_1.3C_AN	C2DT5 500	N15.4W XGA	SO512M BII5	N	N100G B5.4K	INT3945A BG_MO W2	N
TM423 3WLMi	EMEA	TM4233WLMi MCEBE6 G72MV128C 1*512/100/6L/5R_abg_1.3C_AN	C2DT5 500	N15.4W XGA	SO512M BII5	N	N100G B5.4K	INT3945A BG_MO W2	N
TM423 3WLMi	EMEA	TM4233WLMi MCEDEB G72MV128C 2*512/120/6L/5R_abg_1.3C_AN	C2DT5 500	N15.4W XGA	SO512M BII5	SO512M BII5	N120G B5.4K	INT3945A BG_MO W2	N
TM423 3WLMi	EMEA	TM4233WLMi MCEBE6 G72MV128C 2*512/120/6L/5R_abg_1.3C_AN	C2DT5 500	N15.4W XGA	SO512M BII5	SO512M BII5	N120G B5.4K	INT3945A BG_MO W2	N
TM423 3WLMi	EMEA	TM4233WLMi MCENL6 G72MV128C 2*512/120/6L/5R_abg_1.3C_AN	C2DT5 500	N15.4W XGA	SO512M BII5	SO512M BII5	N120G B5.4K	INT3945A BG_MO W2	N
TM423 3WLMi	EMEA	TM4233WLMi MCEFRF G72MV128C 2*512/120/6L/5R_abg_1.3C_AN	C2DT5 500	N15.4W XGA	SO512M BII5	SO512M BII5	N120G B5.4K	INT3945A BG_MO W2	N
TM423 3WLMi	EMEA	TM4233WLMi MCEIT7 G72MV128C 2*512/120/6L/5R_abg_1.3C_AN	C2DT5 500	N15.4W XGA	SO512M BII5	SO512M BII5	N120G B5.4K	INT3945A BG_MO W2	N

TravelMate 4230

Model	RO	Description	CPU	LCD	Memory 1	Memory 2	HDD 1 (GB)	Wireless LAN	Blueto oth
TM423 3WLMi	EMEA	TM4233WLMi MCENL6 G72MV128C 1*512/100/6L/5R_abg_1.3C_AN	C2DT5 500	N15.4W XGA	SO512M BII5	N	N100G B5.4K	INT3945A BG_MO W1	N
TM423 3WLMi	EMEA	TM4233WLMi MCEFRF G72MV128C 1*512/100/6L/5R_abg_1.3C_AN	C2DT5 500	N15.4W XGA	SO512M BII5	N	N100G B5.4K	INT3945A BG_MO W2	N
TM423 3WLMi	EMEA	TM4233WLMi MCEIT7 G72MV128C 1*512/100/6L/5R_abg_1.3C_AN	C2DT5 500	N15.4W XGA	SO512M BII5	N	N100G B5.4K	INT3945A BG_MO W2	N
TM423 3WLMi	EMEA	TM4233WLMi MCES11 G72MV128C 1*512/100/6L/5R_abg_1.3C_AN	C2DT5 500	N15.4W XGA	SO512M BII5	N	N100G B5.4K	INT3945A BG_MO W2	N
TM423 3WLMi	EMEA	TM4233WLMi MCEWFR11W G72MV128C 1*512/100/6L/5R_abg_1.3C_AN	C2DT5 500	N15.4W XGA	SO512M BII5	N	N100G B5.4K	INT3945A BG_MO W2	N
TM423 3WLMi	EMEA	TM4233WLMi MCESW8 G72MV128C 1*512/100/6L/5R_abg_1.3C_AN	C2DT5 500	N15.4W XGA	SO512M BII5	N	N100G B5.4K	INT3945A BG_MO W2	N
TM423 3WLMi	EMEA	TM4233WLMi MCEUK5 G72MV128C 1*512/100/6L/5R_abg_1.3C_AN	C2DT5 500	N15.4W XGA	SO512M BII5	N	N100G B5.4K	INT3945A BG_MO W2	N
TM423 3WLMi	EMEA	TM4233WLMi MCES11 G72MV128C 2*512/120/6L/5R_abg_1.3C_AN	C2DT5 500	N15.4W XGA	SO512M BII5	SO512M BII5	N120G B5.4K	INT3945A BG_MO W2	N
TM423 3WLMi	EMEA	TM4233WLMi MCESW8 G72MV128C 2*512/120/6L/5R_abg_1.3C_AN	C2DT5 500	N15.4W XGA	SO512M BII5	SO512M BII5	N120G B5.4K	INT3945A BG_MO W2	N
TM423 3WLMi	EMEA	TM4233WLMi MCEUK5 G72MV128C 2*512/120/6L/5R_abg_1.3C_AN	C2DT5 500	N15.4W XGA	SO512M BII5	SO512M BII5	N120G B5.4K	INT3945A BG_MO W2	N
TM423 3WLMi	EMEA	TM4233WLMi MCEWUK11W G72MV128C 2*512/120/6L/5R_abg_1.3C_AN	C2DT5 500	N15.4W XGA	SO512M BII5	SO512M BII5	N120G B5.4K	INT3945A BG_MO W2	N
TM423 3WLMi	EMEA	TM4233WLMi MCEWUK11W G72MV128C 1*512/100/6L/5R_abg_1.3C_AN	C2DT5 500	N15.4W XGA	SO512M BII5	N	N100G B5.4K	INT3945A BG_MO W2	N
TM423 3WLMi	EMEA	TM4233WLMi MCEWFR11W G72MV128C 2*512/120/6L/5R_abg_1.3C_AN	C2DT5 500	N15.4W XGA	SO512M BII5	SO512M BII5	N120G B5.4K	INT3945A BG_MO W2	N

TravelMate 4230

Model	RO	Description	CPU	LCD	Memory 1	Memory 2	HDD 1 (GB)	Wireless LAN	Blueto oth
TM423 3WLMi	EMEA	TM4233WLMi MCEWIT11W G72MV128C 2*512/120/6L/5R_abg_1.3C_AN	C2DT5 500	N15.4W XGA	SO512M BII5	SO512M BII5	N120G B5.4K	INT3945A BG_MO W2	N
TM423 3WLMi	EMEA	TM4233WLMi MCEWIT11W G72MV128C 1*512/100/6L/5R_abg_1.3C_AN	C2DT5 500	N15.4W XGA	SO512M BII5	N	N100G B5.4K	INT3945A BG_MO W2	N
TM423 5WLMi	AAP	TM4235WLMi XPHAU1 G72MV128C 1*1G/160/8L/5R_abg_1.3C_AN	C2DT7 200	N15.4W XGAF	SO1GBII 5	N	N160G B5.4K	INT3945A BG_MO W1	N
TM423 5WLMi	AAP	TM4235WLMi XPPAU1 G72MV128C 1*1G/160/8L/5R_abg_1.3C_AN	C2DT7 200	N15.4W XGAF	SO1GBII 5	N	N160G B5.4K	INT3945A BG_MO W1	N
TM423 3WLMi	EMEA	TM4233WLMi XPHPL6 G72MV128C 1*512/80/BT/8L/5R_abg_1.3C_AN	C2DT5 500	N15.4W XGA	SO512M BII5	N	N80GB 5.4K	INT3945A BG_MO W2	FOX_B RM_2.0
TM423 3WLMi	EMEA	TM4233WLMi XPHPL6 G72MV128C 1*1G/120/BT/8L/5R_abg_1.3C_AN	C2DT5 500	N15.4W XGA	SO1GBII 5	N	N120G B5.4K	INT3945A BG_MO W2	FOX_B RM_2.0
TM423 3WLMi	EMEA	TM4233WLMi XPPDE1 G72MV128C 1*512/120/6L/5R_abg_1.3C_AN	C2DT5 500	N15.4W XGA	SO512M BII5	N	N120G B5.4K	INT3945A BG_MO W2	N
TM423 3WLMi	EMEA	TM4233WLMi MCEAR1 G72MV128C 1*512/120/6L/5R_bg_1.3C_AN	C2DT5 500	N15.4W XGA	SO512M BII5	N	N120G B5.4K	INT3945A BG_MO W2	N
TM423 3WLMi	EMEA	TM4233WLMi MCEAR2 G72MV128C 1*512/120/6L/5R_bg_1.3C_AN	C2DT5 500	N15.4W XGA	SO512M BII5	N	N120G B5.4K	INT3945A BG_MO W2	N
TM423 3WLMi	EMEA	TM4233WLMi MCEFRF G72MV128C 1*512/120/6L/5R_abg_1.3C_AN	C2DT5 500	N15.4W XGA	SO512M BII5	N	N120G B5.4K	INT3945A BG_MO W2	N
TM423 3WLMi	EMEA	TM4233WLMi MCEDEB G72MV128C 1*512/120/6L/5R_abg_1.3C_AN	C2DT5 500	N15.4W XGA	SO512M BII5	N	N120G B5.4K	INT3945A BG_MO W2	N
TM423 3WLMi	EMEA	TM4233WLMi MCEBE6 G72MV128C 1*512/120/6L/5R_abg_1.3C_AN	C2DT5 500	N15.4W XGA	SO512M BII5	N	N120G B5.4K	INT3945A BG_MO W2	N
TM423 3WLMi	EMEA	TM4233WLMi MCES11 G72MV128C 1*512/120/6L/5R_abg_1.3C_AN	C2DT5 500	N15.4W XGA	SO512M BII5	N	N120G B5.4K	INT3945A BG_MO W2	N
TM423 3WLMi	EMEA	TM4233WLMi MCEIT7 G72MV128C 1*512/120/6L/5R_abg_1.3C_AN	C2DT5 500	N15.4W XGA	SO512M BII5	N	N120G B5.4K	INT3945A BG_MO W2	N

TravelMate 4230

Model	RO	Description	CPU	LCD	Memory 1	Memory 2	HDD 1 (GB)	Wireless LAN	Blueto oth
TM423 3WLMi	EMEA	TM4233WLMi MCENL6 G72MV128C 1*512/120/6L/5R_abg_1.3C_AN	C2DT5 500	N15.4W XGA	SO512M BII5	N	N120G B5.4K	INT3945A BG_MO W2	N
TM423 3WLMi	EMEA	TM4233WLMi MCEW8 G72MV128C 1*512/120/6L/5R_abg_1.3C_AN	C2DT5 500	N15.4W XGA	SO512M BII5	N	N120G B5.4K	INT3945A BG_MO W2	N
TM423 3WLMi	EMEA	TM4233WLMi MCEUK5 G72MV128C 1*512/120/6L/5R_abg_1.3C_AN	C2DT5 500	N15.4W XGA	SO512M BII5	N	N120G B5.4K	INT3945A BG_MO W2	N
TM423 3WLMi	EMEA	TM4233WLMi MCEWFR11W G72MV128C 1*512/120/6L/5R_abg_1.3C_AN	C2DT5 500	N15.4W XGA	SO512M BII5	N	N120G B5.4K	INT3945A BG_MO W2	N
TM423 3WLMi	EMEA	TM4233WLMi MCEWIT11W G72MV128C 1*512/120/6L/5R_abg_1.3C_AN	C2DT5 500	N15.4W XGA	SO512M BII5	N	N120G B5.4K	INT3945A BG_MO W2	N
TM423 3WLMi	EMEA	TM4233WLMi MCEWUK11W G72MV128C 1*512/120/6L/5R_abg_1.3C_AN	C2DT5 500	N15.4W XGA	SO512M BII5	N	N120G B5.4K	INT3945A BG_MO W2	N
TM423 3WLMi	EMEA	TM4233WLMi XPHAR1 G72MV128C 1*512/120/6L/5R_bg_1.3C_AN	C2DT5 500	N15.4W XGA	SO512M BII5	N	N120G B5.4K	INT3945A BG_MO W2	N
TM423 3WLMi	EMEA	TM4233WLMi XPHBE1 G72MV128C 1*512/120/6L/5R_abg_1.3C_AN	C2DT5 500	N15.4W XGA	SO512M BII5	N	N120G B5.4K	INT3945A BG_MO W2	N
TM423 3WLMi	EMEA	TM4233WLMi XPHCS2 G72MV128C 1*512/120/6L/5R_abg_1.3C_AN	C2DT5 500	N15.4W XGA	SO512M BII5	N	N120G B5.4K	INT3945A BG_MO W2	N
TM423 3WLMi	EMEA	TM4233WLMi XPHDE7 G72MV128C 1*512/120/6L/5R_abg_1.3C_AN	C2DT5 500	N15.4W XGA	SO512M BII5	N	N120G B5.4K	INT3945A BG_MO W2	N
TM423 3WLMi	EMEA	TM4233WLMi XPHDK1 G72MV128C 1*512/120/6L/5R_abg_1.3C_AN	C2DT5 500	N15.4W XGA	SO512M BII5	N	N120G B5.4K	INT3945A BG_MO W2	N
TM423 3WLMi	EMEA	TM4233WLMi XPHL1 G72MV128C 1*512/120/6L/5R_abg_1.3C_AN	C2DT5 500	N15.4W XGA	SO512M BII5	N	N120G B5.4K	INT3945A BG_MO W2	N
TM423 3WLMi	EMEA	TM4233WLMi XPHESA G72MV128C 1*512/120/6L/5R_abg_1.3C_AN	C2DT5 500	N15.4W XGA	SO512M BII5	N	N120G B5.4K	INT3945A BG_MO W2	N

TravelMate 4230

Model	RO	Description	CPU	LCD	Memory 1	Memory 2	HDD 1 (GB)	Wireless LAN	Bluetooth
TM423 3WLMi	EMEA	TM4233WLMi XPHFRA G72MV128C 1*512/120/6L/5R_abg_1.3C_AN	C2DT5 500	N15.4W XGA	SO512M BII5	N	N120G B5.4K	INT3945A BG_MO W2	N
TM423 3WLMi	EMEA	TM4233WLMi XPHHU6 G72MV128C 1*512/120/6L/5R_abg_1.3C_AN	C2DT5 500	N15.4W XGA	SO512M BII5	N	N120G B5.4K	INT3945A BG_MO W2	N
TM423 3WLMi	EMEA	TM4233WLMi XPHIS1 G72MV128C 1*512/120/6L/5R_abg_1.3C_AN	C2DT5 500	N15.4W XGA	SO512M BII5	N	N120G B5.4K	INT3945A BG_MO W2	N
TM423 3WLMi	EMEA	TM4233WLMi XPHIT1 G72MV128C 1*512/120/6L/5R_abg_1.3C_AN	C2DT5 500	N15.4W XGA	SO512M BII5	N	N120G B5.4K	INT3945A BG_MO W2	N
TM423 3WLMi	EMEA	TM4233WLMi XPHNL1 G72MV128C 1*512/120/6L/5R_abg_1.3C_AN	C2DT5 500	N15.4W XGA	SO512M BII5	N	N120G B5.4K	INT3945A BG_MO W2	N
TM423 3WLMi	EMEA	TM4233WLMi XPHNO1 G72MV128C 1*512/120/6L/5R_abg_1.3C_AN	C2DT5 500	N15.4W XGA	SO512M BII5	N	N120G B5.4K	INT3945A BG_MO W2	N
TM423 3WLMi	EMEA	TM4233WLMi XPHPL6 G72MV128C 1*512/120/6L/5R_abg_1.3C_AN	C2DT5 500	N15.4W XGA	SO512M BII5	N	N120G B5.4K	INT3945A BG_MO W2	N
TM423 3WLMi	EMEA	TM4233WLMi XPHRU2 G72MV128C 1*512/120/6L/5R_abg_1.3C_AN	C2DT5 500	N15.4W XGA	SO512M BII5	N	N120G B5.4K	INT3945A BG_MO W2	N
TM423 3WLMi	EMEA	TM4233WLMi XPHPT1 G72MV128C 1*512/120/6L/5R_abg_1.3C_AN	C2DT5 500	N15.4W XGA	SO512M BII5	N	N120G B5.4K	INT3945A BG_MO W2	N
TM423 3WLMi	EMEA	TM4233WLMi XPHSA1 G72MV128C 1*512/120/6L/5R_abg_1.3C_AN	C2DT5 500	N15.4W XGA	SO512M BII5	N	N120G B5.4K	INT3945A BG_MO W2	N
TM423 3WLMi	EMEA	TM4233WLMi XPHSLO2 G72MV128C 1*512/120/6L/5R_abg_1.3C_AN	C2DT5 500	N15.4W XGA	SO512M BII5	N	N120G B5.4K	INT3945A BG_MO W2	N
TM423 3WLMi	EMEA	TM4233WLMi XPHSV1 G72MV128C 1*512/120/6L/5R_abg_1.3C_AN	C2DT5 500	N15.4W XGA	SO512M BII5	N	N120G B5.4K	INT3945A BG_MO W2	N
TM423 3WLMi	EMEA	TM4233WLMi XPHSW5 G72MV128C 1*512/120/6L/5R_abg_1.3C_AN	C2DT5 500	N15.4W XGA	SO512M BII5	N	N120G B5.4K	INT3945A BG_MO W2	N
TM423 3WLMi	EMEA	TM4233WLMi XPHTR1 G72MV128C 1*512/120/6L/5R_abg_1.3C_AN	C2DT5 500	N15.4W XGA	SO512M BII5	N	N120G B5.4K	INT3945A BG_MO W2	N

TravelMate 4230

Model	RO	Description	CPU	LCD	Memory 1	Memory 2	HDD 1 (GB)	Wireless LAN	Bluetooth
TM423 3WLMi	EMEA	TM4233WLMi XPHUK1 G72MV128C 1*512/120/6L/5R_abg_1.3C_AN	C2DT5 500	N15.4W XGA	SO512M BII5	N	N120G B5.4K	INT3945A BG_MO W2	N
TM423 3WLMi	EMEA	TM4233WLMi XPHIS1 G72MV128C 1*512/120/6L/5R_abg_1.3C_AN	C2DT5 500	N15.4W XGA	SO512M BII5	N	N120G B5.4K	INT3945A BG_MO W2	N

TravelMate 2490

Model	RO	Description	Group1	CPU	Memory 1	DIMM 2	HDD 1 (GB)	Wireless LAN	Bluetooth
TM249 2WLMi	PA	TM2492WLMi XPHEN1 UMAC 1*512/60/6L/5R_bg_0.3C_AN	TM249 2WL	CM420	SO512M BII5	N	N60GB5.4K	ABT_BR M4318BG	N
TM249 2WLMi	PA	TM2492WLMi XPHFR1 UMAC 1*512/60/6L/5R_bg_0.3C_AN	TM249 2WL	CM420	SO512M BII5	N	N60GB5.4K	ABT_BR M4318BG	N
TM249 2WLMi	PA	TM2492WLMi XPHES1 UMAC 1*512/60/6L/5R_bg_0.3C_AN	TM249 2WL	CM420	SO512M BII5	N	N60GB5.4K	ABT_BR M4318BG	N
TM249 2WLMi	PA	TM2492WLMi XPHXC1 UMAC 1*512/60/6L/5R_bg_0.3C_AN	TM249 2WL	CM420	SO512M BII5	N	N60GB5.4K	ABT_BR M4318BG	N
TM249 2WLMi	AAP	TM2492WLMi XPHAU1 UMAC 1*512/60/6L/5R_bg_0.3C_AN	TM249 2WL	CM420	SO512M BII5	N	N60GB5.4K	ABT_BR M4318BG	N
TM249 2WLMi	EMEA	TM2492WLMi XPHSA1 UMAC 1*512/100/6L/5R_bg_0.3C_AN	TM249 2WL	CM420	SO512M BII5	N	N100GB5.4K	ABT_BR M4318BG	N
TM249 2WLMi	EMEA	TM2492WLMi XPHDK1 UMAC 1*512/100/6L/5R_bg_0.3C_AN	TM249 2WL	CM420	SO512M BII5	N	N100GB5.4K	ABT_BR M4318BG	N
TM249 2WLMi	EMEA	TM2492WLMi XPHFRA UMAC 1*512/100/6L/5R_bg_0.3C_AN	TM249 2WL	CM420	SO512M BII5	N	N100GB5.4K	ABT_BR M4318BG	N
TM249 2WLMi	EMEA	TM2492WLMi XPHDE7 UMAC 1*512/100/6L/5R_bg_0.3C_AN	TM249 2WL	CM420	SO512M BII5	N	N100GB5.4K	ABT_BR M4318BG	N
TM249 2WLMi	EMEA	TM2492WLMi XPHBE1 UMAC 1*512/100/6L/5R_bg_0.3C_AN	TM249 2WL	CM420	SO512M BII5	N	N100GB5.4K	ABT_BR M4318BG	N

TravelMate 2490

Model	RO	Description	Group1	CPU	Memory 1	DIMM 2	HDD 1 (GB)	Wireless LAN	Bluetooth
TM249 2WLMi	EMEA	TM2492WLMi XPHNL1 UMAC 1*512/100/6L/ 5R_bg_0.3C_AN	TM249 2WL	CM420	SO512M BII5	N	N100GB5 .4K	ABT_BR M4318BG	N
TM249 2WLMi	EMEA	TM2492WLMi XPHNO1 UMAC 1*512/100/6L/ 5R_bg_0.3C_AN	TM249 2WL	CM420	SO512M BII5	N	N100GB5 .4K	ABT_BR M4318BG	N
TM249 2WLMi	EMEA	TM2492WLMi XPHRU2 UMAC 1*512/100/6L/ 5R_bg_0.3C_AN	TM249 2WL	CM420	SO512M BII5	N	N100GB5 .4K	ABT_BR M4318BG	N
TM249 2WLMi	EMEA	TM2492WLMi XPHSV1 UMAC 1*512/100/6L/ 5R_bg_0.3C_AN	TM249 2WL	CM420	SO512M BII5	N	N100GB5 .4K	ABT_BR M4318BG	N
TM249 2WLMi	EMEA	TM2492WLMi XPHCS2 UMAC 1*512/100/6L/ 5R_bg_0.3C_AN	TM249 2WL	CM420	SO512M BII5	N	N100GB5 .4K	ABT_BR M4318BG	N
TM249 2WLMi	EMEA	TM2492WLMi XPHHU6 UMAC 1*512/100/6L/ 5R_bg_0.3C_AN	TM249 2WL	CM420	SO512M BII5	N	N100GB5 .4K	ABT_BR M4318BG	N
TM249 2WLMi	EMEA	TM2492WLMi XPHPL6 UMAC 1*512/100/6L/ 5R_bg_0.3C_AN	TM249 2WL	CM420	SO512M BII5	N	N100GB5 .4K	ABT_BR M4318BG	N
TM249 2WLMi	EMEA	TM2492WLMi XPHSLO2 UMAC 1*512/100/6L/ 5R_bg_0.3C_AN	TM249 2WL	CM420	SO512M BII5	N	N100GB5 .4K	ABT_BR M4318BG	N
TM249 2WLMi	EMEA	TM2492WLMi XPHESA UMAC 1*512/100/6L/ 5R_bg_0.3C_AN	TM249 2WL	CM420	SO512M BII5	N	N100GB5 .4K	ABT_BR M4318BG	N
TM249 2WLMi	EMEA	TM2492WLMi XPHPT1 UMAC 1*512/100/6L/ 5R_bg_0.3C_AN	TM249 2WL	CM420	SO512M BII5	N	N100GB5 .4K	ABT_BR M4318BG	N
TM249 2WLMi	EMEA	TM2492WLMi XPHL1 UMAC 1*512/100/6L/ 5R_bg_0.3C_AN	TM249 2WL	CM420	SO512M BII5	N	N100GB5 .4K	ABT_BR M4318BG	N
TM249 2WLMi	EMEA	TM2492WLMi XPHIS1 UMAC 1*512/100/6L/ 5R_bg_0.3C_AN	TM249 2WL	CM420	SO512M BII5	N	N100GB5 .4K	ABT_BR M4318BG	N
TM249 2WLMi	EMEA	TM2492WLMi XPHIT1 UMAC 1*512/100/6L/ 5R_bg_0.3C_AN	TM249 2WL	CM420	SO512M BII5	N	N100GB5 .4K	ABT_BR M4318BG	N
TM249 2WLMi	EMEA	TM2492WLMi XPHTR1 UMAC 1*512/100/6L/ 5R_bg_0.3C_AN	TM249 2WL	CM420	SO512M BII5	N	N100GB5 .4K	ABT_BR M4318BG	N

TravelMate 2490

Model	RO	Description	Group1	CPU	Memory 1	DIMM 2	HDD 1 (GB)	Wireless LAN	Bluetooth
TM249 2WLMi	EMEA	TM2492WLMi XPHAR1 UMAC 1*512/100/6L/ 5R_bg_0.3C_AN	TM249 2WL	CM420	SO512M BII5	N	N100GB5 .4K	ABT_BR M4318BG	N
TM249 2WLMi	EMEA	TM2492WLMi XPHSW5 UMAC 1*512/100/6L/ 5R_bg_0.3C_AN	TM249 2WL	CM420	SO512M BII5	N	N100GB5 .4K	ABT_BR M4318BG	N
TM249 2WLMi	EMEA	TM2492WLMi XPHUK1 UMAC 1*512/100/6L/ 5R_bg_0.3C_AN	TM249 2WL	CM420	SO512M BII5	N	N100GB5 .4K	ABT_BR M4318BG	N
TM249 2WLMi	EMEA	TM2492WLMi XPPSA1 UMAC 1*512/100/6L/ 5R_bg_0.3C_AN	TM249 2WL	CM420	SO512M BII5	N	N100GB5 .4K	ABT_BR M4318BG	N
TM249 2WLMi	EMEA	TM2492WLMi XPPDK1 UMAC 1*512/100/6L/ 5R_bg_0.3C_AN	TM249 2WL	CM420	SO512M BII5	N	N100GB5 .4K	ABT_BR M4318BG	N
TM249 2WLMi	EMEA	TM2492WLMi XPPBE1 UMAC 1*512/100/6L/ 5R_bg_0.3C_AN	TM249 2WL	CM420	SO512M BII5	N	N100GB5 .4K	ABT_BR M4318BG	N
TM249 2WLMi	EMEA	TM2492WLMi XPPNL1 UMAC 1*512/100/6L/ 5R_bg_0.3C_AN	TM249 2WL	CM420	SO512M BII5	N	N100GB5 .4K	ABT_BR M4318BG	N
TM249 2WLMi	EMEA	TM2492WLMi XPPNO1 UMAC 1*512/100/6L/ 5R_bg_0.3C_AN	TM249 2WL	CM420	SO512M BII5	N	N100GB5 .4K	ABT_BR M4318BG	N
TM249 2WLMi	EMEA	TM2492WLMi XPPRU2 UMAC 1*512/100/6L/ 5R_bg_0.3C_AN	TM249 2WL	CM420	SO512M BII5	N	N100GB5 .4K	ABT_BR M4318BG	N
TM249 2WLMi	EMEA	TM2492WLMi XPPFRA UMAC 1*512/100/6L/ 5R_bg_0.3C_AN	TM249 2WL	CM420	SO512M BII5	N	N100GB5 .4K	ABT_BR M4318BG	N
TM249 2WLMi	EMEA	TM2492WLMi XPPSV1 UMAC 1*512/100/6L/ 5R_bg_0.3C_AN	TM249 2WL	CM420	SO512M BII5	N	N100GB5 .4K	ABT_BR M4318BG	N
TM249 2WLMi	EMEA	TM2492WLMi XPPCS2 UMAC 1*512/100/6L/ 5R_bg_0.3C_AN	TM249 2WL	CM420	SO512M BII5	N	N100GB5 .4K	ABT_BR M4318BG	N
TM249 2WLMi	EMEA	TM2492WLMi XPPHU6 UMAC 1*512/100/6L/ 5R_bg_0.3C_AN	TM249 2WL	CM420	SO512M BII5	N	N100GB5 .4K	ABT_BR M4318BG	N
TM249 2WLMi	EMEA	TM2492WLMi XPPPL6 UMAC 1*512/100/6L/ 5R_bg_0.3C_AN	TM249 2WL	CM420	SO512M BII5	N	N100GB5 .4K	ABT_BR M4318BG	N

TravelMate 2490

Model	RO	Description	Group1	CPU	Memory 1	DIMM 2	HDD 1 (GB)	Wireless LAN	Bluetooth
TM249 2WLMi	EMEA	TM2492WLMi XPPDE7 UMAC 1*512/100/6L/ 5R_bg_0.3C_AN	TM249 2WL	CM420	SO512M BII5	N	N100GB5 .4K	ABT_BR M4318BG	N
TM249 2WLMi	EMEA	TM2492WLMi XPPSLO1 UMAC 1*512/100/6L/ 5R_bg_0.3C_AN	TM249 2WL	CM420	SO512M BII5	N	N100GB5 .4K	ABT_BR M4318BG	N
TM249 2WLMi	EMEA	TM2492WLMi XPPESA UMAC 1*512/100/6L/ 5R_bg_0.3C_AN	TM249 2WL	CM420	SO512M BII5	N	N100GB5 .4K	ABT_BR M4318BG	N
TM249 2WLMi	EMEA	TM2492WLMi XPPPT1 UMAC 1*512/100/6L/ 5R_bg_0.3C_AN	TM249 2WL	CM420	SO512M BII5	N	N100GB5 .4K	ABT_BR M4318BG	N
TM249 2WLMi	EMEA	TM2492WLMi XPPIS1 UMAC 1*512/ 100/6L/ 5R_bg_0.3C_AN	TM249 2WL	CM420	SO512M BII5	N	N100GB5 .4K	ABT_BR M4318BG	N
TM249 2WLMi	EMEA	TM2492WLMi XPPIT1 UMAC 1*512/100/6L/ 5R_bg_0.3C_AN	TM249 2WL	CM420	SO512M BII5	N	N100GB5 .4K	ABT_BR M4318BG	N
TM249 2WLMi	EMEA	TM2492WLMi XPPTR1 UMAC 1*512/100/6L/ 5R_bg_0.3C_AN	TM249 2WL	CM420	SO512M BII5	N	N100GB5 .4K	ABT_BR M4318BG	N
TM249 2WLMi	EMEA	TM2492WLMi XPPEL3 UMAC 1*512/100/6L/ 5R_bg_0.3C_AN	TM249 2WL	CM420	SO512M BII5	N	N100GB5 .4K	ABT_BR M4318BG	N
TM249 2WLMi	EMEA	TM2492WLMi XPPAR1 UMAC 1*512/100/6L/ 5R_bg_0.3C_AN	TM249 2WL	CM420	SO512M BII5	N	N100GB5 .4K	ABT_BR M4318BG	N
TM249 2WLMi	EMEA	TM2492WLMi XPPSW5 UMAC 1*512/100/6L/ 5R_bg_0.3C_AN	TM249 2WL	CM420	SO512M BII5	N	N100GB5 .4K	ABT_BR M4318BG	N
TM249 2WLMi	EMEA	TM2492WLMi XPPUK1 UMAC 1*512/100/6L/ 5R_bg_0.3C_AN	TM249 2WL	CM420	SO512M BII5	N	N100GB5 .4K	ABT_BR M4318BG	N
TM249 2WLMi	EMEA	TM2492WLMi XPHPL6 UMAC 1*512/60/BT/6L/ 5R_bg_0.3C_AN	TM249 2WL	CM420	SO512M BII5	N	N60GB5. 4K	ABT_BR M4318BG	FOX_BRM_ 2.0
TM249 2WLMi	EMEA	TM2492WLMi XPHPL6 UMAC 1*512/100/BT/6L/ 5R_bg_0.3C_AN	TM249 2WL	CM420	SO512M BII5	N	N100GB5 .4K	ABT_BR M4318BG	FOX_BRM_ 2.0
TM249 2WLMi	EMEA	TM2492WLMi XPPPL6 UMAC 1*512/60/BT/6L/ 5R_bg_0.3C_AN	TM249 2WL	CM420	SO512M BII5	N	N60GB5. 4K	ABT_BR M4318BG	FOX_BRM_ 2.0

TravelMate 2490

Model	RO	Description	Group1	CPU	Memory 1	DIMM 2	HDD 1 (GB)	Wireless LAN	Bluetooth
TM249 2WLMi	EMEA	TM2492WLMi XPPPL6 UMAC 1*512/100/BT/6L/ 5R_bg_0.3C_AN	TM249 2WL	CM420	SO512M BII5	N	N100GB5 .4K	ABT_BR M4318BG	FOX_BRM_ 2.0
TM249 2WLMi	AAP	TM2492WLMi XPHPH1 UMAC 1*512/100/6L/ 5R_bg_0.3C_AN	TM249 2WL	CM420	SO512M BII5	N	N100GB5 .4K	ABT_BR M4318BG	N
TM249 2WLMi	AAP	TM2492WLMi XPHPH1 UMAC 1*512/100/BT/6L/ 5R_bg_0.3C_AN	TM249 2WL	CM420	SO512M BII5	N	N100GB5 .4K	ABT_BR M4318BG	FOX_BRM_ 2.0
TM249 2NWLMi	EMEA	TM2492NWLMi LINPUSCS2 UMAC 1*512/100/BT/8L/ 5R_bg_0.3C_AN	TM249 2WL	CM420	SO512M BII5	N	N100GB5 .4K	ABT_BR M4318BG	FOX_BRM_ 2.0
TM249 2WLMi	EMEA	TM2492WLMi XPHCS2 UMAC 1*512/100/BT/8L/ 5R_bg_0.3C_AN	TM249 2WL	CM420	SO512M BII5	N	N100GB5 .4K	ABT_BR M4318BG	FOX_BRM_ 2.0
TM249 2WLMi	EMEA	TM2492WLMi XPPCS2 UMAC 1*512/100/BT/8L/ 5R_bg_0.3C_AN	TM249 2WL	CM420	SO512M BII5	N	N100GB5 .4K	ABT_BR M4318BG	FOX_BRM_ 2.0
TM249 2WLMi	EMEA	TM2492WLMi XPPRU2 UMAC 1*512/100/BT/8L/ 5R_bg_0.3C_AN	TM249 2WL	CM420	SO512M BII5	N	N100GB5 .4K	ABT_BR M4318BG	FOX_BRM_ 2.0
TM249 2WLMi	EMEA	TM2492WLMi MCEDEB UMAC 1*512/100/6L/ 5R_bg_0.3C_AN	TM249 2WL	CM420	SO512M BII5	N	N100GB5 .4K	ABT_BR M4318BG	N
TM249 2WLMi	EMEA	TM2492WLMi MCEBE6 UMAC 1*512/100/6L/ 5R_bg_0.3C_AN	TM249 2WL	CM420	SO512M BII5	N	N100GB5 .4K	ABT_BR M4318BG	N
TM249 2WLMi	EMEA	TM2492WLMi MCEAR1 UMAC 1*512/100/6L/ 5R_bg_0.3C_AN	TM249 2WL	CM420	SO512M BII5	N	N100GB5 .4K	ABT_BR M4318BG	N
TM249 2WLMi	EMEA	TM2492WLMi MCEAR2 UMAC 1*512/100/6L/ 5R_bg_0.3C_AN	TM249 2WL	CM420	SO512M BII5	N	N100GB5 .4K	ABT_BR M4318BG	N
TM249 2WLMi	EMEA	TM2492WLMi MCESW8 UMAC 1*512/100/6L/ 5R_bg_0.3C_AN	TM249 2WL	CM420	SO512M BII5	N	N100GB5 .4K	ABT_BR M4318BG	N
TM249 2WLMi	EMEA	TM2492WLMi MCEWIT11W UMAC 1*512/100/6L/ 5R_bg_0.3C_AN	TM249 2WL	CM420	SO512M BII5	N	N100GB5 .4K	ABT_BR M4318BG	N
TM249 2WLMi	EMEA	TM2492WLMi MCES11 UMAC 1*512/100/6L/ 5R_bg_0.3C_AN	TM249 2WL	CM420	SO512M BII5	N	N100GB5 .4K	ABT_BR M4318BG	N

TravelMate 2490

Model	RO	Description	Group1	CPU	Memory 1	DIMM 2	HDD 1 (GB)	Wireless LAN	Bluetooth
TM249 2WLMi	EMEA	TM2492WLMi MCEIT7 UMAC 1*512/100/6L/ 5R_bg_0.3C_AN	TM249 2WL	CM420	SO512M BII5	N	N100GB5.4K	ABT_BR M4318BG	N
TM249 2WLMi	EMEA	TM2492WLMi MCENL6 UMAC 1*512/100/6L/ 5R_bg_0.3C_AN	TM249 2WL	CM420	SO512M BII5	N	N100GB5.4K	ABT_BR M4318BG	N
TM249 2WLMi	EMEA	TM2492WLMi MCEWFR11W UMAC 1*512/100/6L/ 5R_bg_0.3C_AN	TM249 2WL	CM420	SO512M BII5	N	N100GB5.4K	ABT_BR M4318BG	N
TM249 2WLMi	EMEA	TM2492WLMi MCEFRF UMAC 1*512/100/6L/ 5R_bg_0.3C_AN	TM249 2WL	CM420	SO512M BII5	N	N100GB5.4K	ABT_BR M4318BG	N
TM249 2WLMi	EMEA	TM2492WLMi MCEUK5 UMAC 1*512/100/6L/ 5R_bg_0.3C_AN	TM249 2WL	CM420	SO512M BII5	N	N100GB5.4K	ABT_BR M4318BG	N
TM249 2WLMi	EMEA	TM2492WLMi MCEWUK11W UMAC 1*512/100/6L/ 5R_bg_0.3C_AN	TM249 2WL	CM420	SO512M BII5	N	N100GB5.4K	ABT_BR M4318BG	N
TM249 1WLMi	PA	TM2491WLMi XPPEN1 UMAC 1*512/80/6L/ 5R_bg_0.3C_AN	TM249 1WL	CM410	SO512M BII5	N	N80GB5.4K	ABT_BR M4318BG	N
TM249 1WLMi	PA	TM2491WLMi XPPFR1 UMAC 1*512/80/6L/ 5R_bg_0.3C_AN	TM249 1WL	CM410	SO512M BII5	N	N80GB5.4K	ABT_BR M4318BG	N
TM249 1WLMi	PA	TM2491WLMi XPPES1 UMAC 1*512/80/6L/ 5R_bg_0.3C_AN	TM249 1WL	CM410	SO512M BII5	N	N80GB5.4K	ABT_BR M4318BG	N
TM249 1WLMi	PA	TM2491WLMi XPPXC1 UMAC 1*512/80/6L/ 5R_bg_0.3C_AN	TM249 1WL	CM410	SO512M BII5	N	N80GB5.4K	ABT_BR M4318BG	N
TM249 2WLMi	PA	TM2492WLMi XPPEN1 UMAC 1*512/80/6L/ 5R_bg_0.3C_AN	TM249 2WL	CM420	SO512M BII5	N	N80GB5.4K	ABT_BR M4318BG	N
TM249 2WLMi	PA	TM2492WLMi XPPFR1 UMAC 1*512/80/6L/ 5R_bg_0.3C_AN	TM249 2WL	CM420	SO512M BII5	N	N80GB5.4K	ABT_BR M4318BG	N
TM249 2WLMi	PA	TM2492WLMi XPPES1 UMAC 1*512/80/6L/ 5R_bg_0.3C_AN	TM249 2WL	CM420	SO512M BII5	N	N80GB5.4K	ABT_BR M4318BG	N
TM249 2WLMi	PA	TM2492WLMi XPPXC1 UMAC 1*512/80/6L/ 5R_bg_0.3C_AN	TM249 2WL	CM420	SO512M BII5	N	N80GB5.4K	ABT_BR M4318BG	N

TravelMate 2490

Model	RO	Description	Group1	CPU	Memory 1	DIMM 2	HDD 1 (GB)	Wireless LAN	Bluetooth
TM249 2WLMi	PA	TM2492WLMi XPPEN1 UMAC 2*512/120/6L/ 5R_bg_0.3C_AN	TM249 2WL	CM420	SO512M BII5	SO51 2MBII 5	N120GB5 .4K	ABT_BR M4318BG	N
TM249 2WLMi	PA	TM2492WLMi XPPFR1 UMAC 2*512/120/6L/ 5R_bg_0.3C_AN	TM249 2WL	CM420	SO512M BII5	SO51 2MBII 5	N120GB5 .4K	ABT_BR M4318BG	N
TM249 2WLMi	PA	TM2492WLMi XPPES1 UMAC 2*512/120/6L/ 5R_bg_0.3C_AN	TM249 2WL	CM420	SO512M BII5	SO51 2MBII 5	N120GB5 .4K	ABT_BR M4318BG	N
TM249 2WLMi	PA	TM2492WLMi XPPXC1 UMAC 2*512/120/6L/ 5R_bg_0.3C_AN	TM249 2WL	CM420	SO512M BII5	SO51 2MBII 5	N120GB5 .4K	ABT_BR M4318BG	N
TM249 3WLMi	PA	TM2493WLMi XPPEN1 UMAC 2*512/120/6L/ 5R_bg_0.3C_AN	TM249 3WL	CM430	SO512M BII5	SO51 2MBII 5	N120GB5 .4K	ABT_BR M4318BG	N
TM249 3WLMi	PA	TM2493WLMi XPPFR1 UMAC 2*512/120/6L/ 5R_bg_0.3C_AN	TM249 3WL	CM430	SO512M BII5	SO51 2MBII 5	N120GB5 .4K	ABT_BR M4318BG	N
TM249 3WLMi	PA	TM2493WLMi XPPES1 UMAC 2*512/120/6L/ 5R_bg_0.3C_AN	TM249 3WL	CM430	SO512M BII5	SO51 2MBII 5	N120GB5 .4K	ABT_BR M4318BG	N
TM249 3WLMi	PA	TM2493WLMi XPPXC1 UMAC 2*512/120/6L/ 5R_bg_0.3C_AN	TM249 3WL	CM430	SO512M BII5	SO51 2MBII 5	N120GB5 .4K	ABT_BR M4318BG	N
TM249 2WLMi	EMEA	TM2492WLMi XPHPL6 UMAC 1*512/120/BT/8L/ 5R_bg_0.3C_AN	TM249 2WL	CM420	SO512M BII5	N	N120GB5 .4K	ABT_BR M4318BG	FOX_BRM_2.0
TM249 2WLMi	EMEA	TM2492WLMi XPPPL6 UMAC 1*512/120/BT/8L/ 5R_bg_0.3C_AN	TM249 2WL	CM420	SO512M BII5	N	N120GB5 .4K	ABT_BR M4318BG	FOX_BRM_2.0
TM249 2WLMi	EMEA	TM2492WLMi XPHPL6 UMAC 1*512/60/BT/8L/ 5R_bg_0.3C_AN	TM249 2WL	CM420	SO512M BII5	N	N60GB5. 4K	ABT_BR M4318BG	FOX_BRM_2.0
TM249 2WLMi	EMEA	TM2492WLMi XPPPL6 UMAC 1*512/60/BT/8L/ 5R_bg_0.3C_AN	TM249 2WL	CM420	SO512M BII5	N	N60GB5. 4K	ABT_BR M4318BG	FOX_BRM_2.0
TM249 2WLMi	EMEA	TM2492WLMi XPPRU2 UMAC 1*512/80/BT/8L/ 5R_bg_0.3C_AN	TM249 2WL	CM420	SO512M BII5	N	N80GB5. 4K	ABT_BR M4318BG	FOX_BRM_2.0
TM249 2WLMi	EMEA	TM2492WLMi MCEBE6 UMAC 1*512/120/6L/ 5R_bg_0.3C_AN	TM249 2WL	CM420	SO512M BII5	N	N120GB5 .4K	ABT_BR M4318BG	N

TravelMate 2490

Model	RO	Description	Group1	CPU	Memory 1	DIMM 2	HDD 1 (GB)	Wireless LAN	Bluetooth
TM249 2WLMi	EMEA	TM2492WLMi MCEAR1 UMAC 1*512/120/6L/ 5R_bg_0.3C_AN	TM249 2WL	CM420	SO512M BII5	N	N120GB5 .4K	ABT_BR M4318BG	N
TM249 2WLMi	EMEA	TM2492WLMi MCEAR2 UMAC 1*512/120/6L/ 5R_bg_0.3C_AN	TM249 2WL	CM420	SO512M BII5	N	N120GB5 .4K	ABT_BR M4318BG	N
TM249 2WLMi	EMEA	TM2492WLMi MCENL6 UMAC 1*512/120/6L/ 5R_bg_0.3C_AN	TM249 2WL	CM420	SO512M BII5	N	N120GB5 .4K	ABT_BR M4318BG	N
TM249 2WLMi	EMEA	TM2492WLMi MCESW8 UMAC 1*512/120/6L/ 5R_bg_0.3C_AN	TM249 2WL	CM420	SO512M BII5	N	N120GB5 .4K	ABT_BR M4318BG	N
TM249 2WLMi	EMEA	TM2492WLMi MCEUK5 UMAC 1*512/120/6L/ 5R_bg_0.3C_AN	TM249 2WL	CM420	SO512M BII5	N	N120GB5 .4K	ABT_BR M4318BG	N
TM249 2WLMi	EMEA	TM2492WLMi MCEDEB UMAC 1*512/120/6L/ 5R_bg_0.3C_AN	TM249 2WL	CM420	SO512M BII5	N	N120GB5 .4K	ABT_BR M4318BG	N
TM249 2WLMi	EMEA	TM2492WLMi MCESI1 UMAC 1*512/120/6L/ 5R_bg_0.3C_AN	TM249 2WL	CM420	SO512M BII5	N	N120GB5 .4K	ABT_BR M4318BG	N
TM249 2WLMi	EMEA	TM2492WLMi MCEIT7 UMAC 1*512/120/6L/ 5R_bg_0.3C_AN	TM249 2WL	CM420	SO512M BII5	N	N120GB5 .4K	ABT_BR M4318BG	N
TM249 2WLMi	EMEA	TM2492WLMi MCEFRF UMAC 1*512/120/6L/ 5R_bg_0.3C_AN	TM249 2WL	CM420	SO512M BII5	N	N120GB5 .4K	ABT_BR M4318BG	N
TM249 2WLMi	EMEA	TM2492WLMi MCEWFR11W UMAC 1*512/120/6L/ 5R_bg_0.3C_AN	TM249 2WL	CM420	SO512M BII5	N	N120GB5 .4K	ABT_BR M4318BG	N
TM249 2WLMi	EMEA	TM2492WLMi MCEWUK11W UMAC 1*512/120/6L/ 5R_bg_0.3C_AN	TM249 2WL	CM420	SO512M BII5	N	N120GB5 .4K	ABT_BR M4318BG	N
TM249 2WLMi	EMEA	TM2492WLMi MCEWIT11W UMAC 1*512/120/6L/ 5R_bg_0.3C_AN	TM249 2WL	CM420	SO512M BII5	N	N120GB5 .4K	ABT_BR M4318BG	N
TM249 2WLMi	EMEA	TM2492WLMi XPHCS2 UMAC 1*512/120/6L/ 5R_bg_0.3C_AN	TM249 2WL	CM420	SO512M BII5	N	N120GB5 .4K	ABT_BR M4318BG	N
TM249 2WLMi	EMEA	TM2492WLMi XPHAR1 UMAC 1*512/120/6L/ 5R_bg_0.3C_AN	TM249 2WL	CM420	SO512M BII5	N	N120GB5 .4K	ABT_BR M4318BG	N

TravelMate 2490

Model	RO	Description	Group1	CPU	Memory 1	DIMM 2	HDD 1 (GB)	Wireless LAN	Bluetooth
TM249 2WLMi	EMEA	TM2492WLMi XPHBE1 UMAC 1*512/120/6L/ 5R_bg_0.3C_AN	TM249 2WL	CM420	SO512M BII5	N	N120GB5 .4K	ABT_BR M4318BG	N
TM249 2WLMi	EMEA	TM2492WLMi XPHDE7 UMAC 1*512/120/6L/ 5R_bg_0.3C_AN	TM249 2WL	CM420	SO512M BII5	N	N120GB5 .4K	ABT_BR M4318BG	N
TM249 2WLMi	EMEA	TM2492WLMi XPHFRA UMAC 1*512/120/6L/ 5R_bg_0.3C_AN	TM249 2WL	CM420	SO512M BII5	N	N120GB5 .4K	ABT_BR M4318BG	N
TM249 2WLMi	EMEA	TM2492WLMi XPHHU6 UMAC 1*512/120/6L/ 5R_bg_0.3C_AN	TM249 2WL	CM420	SO512M BII5	N	N120GB5 .4K	ABT_BR M4318BG	N
TM249 2WLMi	EMEA	TM2492WLMi XPHIS1 UMAC 1*512/120/6L/ 5R_bg_0.3C_AN	TM249 2WL	CM420	SO512M BII5	N	N120GB5 .4K	ABT_BR M4318BG	N
TM249 2WLMi	EMEA	TM2492WLMi XPHESA UMAC 1*512/120/6L/ 5R_bg_0.3C_AN	TM249 2WL	CM420	SO512M BII5	N	N120GB5 .4K	ABT_BR M4318BG	N
TM249 2WLMi	EMEA	TM2492WLMi XPHL1 UMAC 1*512/120/6L/ 5R_bg_0.3C_AN	TM249 2WL	CM420	SO512M BII5	N	N120GB5 .4K	ABT_BR M4318BG	N
TM249 2WLMi	EMEA	TM2492WLMi XPHDK1 UMAC 1*512/120/6L/ 5R_bg_0.3C_AN	TM249 2WL	CM420	SO512M BII5	N	N120GB5 .4K	ABT_BR M4318BG	N
TM249 2WLMi	EMEA	TM2492WLMi XPHNL1 UMAC 1*512/120/6L/ 5R_bg_0.3C_AN	TM249 2WL	CM420	SO512M BII5	N	N120GB5 .4K	ABT_BR M4318BG	N
TM249 2WLMi	EMEA	TM2492WLMi XPHPT1 UMAC 1*512/120/6L/ 5R_bg_0.3C_AN	TM249 2WL	CM420	SO512M BII5	N	N120GB5 .4K	ABT_BR M4318BG	N
TM249 2WLMi	EMEA	TM2492WLMi XPHIT1 UMAC 1*512/120/6L/ 5R_bg_0.3C_AN	TM249 2WL	CM420	SO512M BII5	N	N120GB5 .4K	ABT_BR M4318BG	N
TM249 2WLMi	EMEA	TM2492WLMi XPHPL6 UMAC 1*512/120/6L/ 5R_bg_0.3C_AN	TM249 2WL	CM420	SO512M BII5	N	N120GB5 .4K	ABT_BR M4318BG	N
TM249 2WLMi	EMEA	TM2492WLMi XPHNO1 UMAC 1*512/120/6L/ 5R_bg_0.3C_AN	TM249 2WL	CM420	SO512M BII5	N	N120GB5 .4K	ABT_BR M4318BG	N
TM249 2WLMi	EMEA	TM2492WLMi XPHRU2 UMAC 1*512/120/6L/ 5R_bg_0.3C_AN	TM249 2WL	CM420	SO512M BII5	N	N120GB5 .4K	ABT_BR M4318BG	N

TravelMate 2490

Model	RO	Description	Group1	CPU	Memory 1	DIMM 2	HDD 1 (GB)	Wireless LAN	Bluetooth
TM249 2WLMi	EMEA	TM2492WLMi XPHSV1 UMAC 1*512/120/6L/ 5R_bg_0.3C_AN	TM249 2WL	CM420	SO512M BII5	N	N120GB5 .4K	ABT_BR M4318BG	N
TM249 2WLMi	EMEA	TM2492WLMi XPHTR1 UMAC 1*512/120/6L/ 5R_bg_0.3C_AN	TM249 2WL	CM420	SO512M BII5	N	N120GB5 .4K	ABT_BR M4318BG	N
TM249 2WLMi	EMEA	TM2492WLMi XPHSLO2 UMAC 1*512/120/6L/ 5R_bg_0.3C_AN	TM249 2WL	CM420	SO512M BII5	N	N120GB5 .4K	ABT_BR M4318BG	N
TM249 2WLMi	EMEA	TM2492WLMi XPHSW5 UMAC 1*512/120/6L/ 5R_bg_0.3C_AN	TM249 2WL	CM420	SO512M BII5	N	N120GB5 .4K	ABT_BR M4318BG	N
TM249 2WLMi	EMEA	TM2492WLMi XPHSA1 UMAC 1*512/120/6L/ 5R_bg_0.3C_AN	TM249 2WL	CM420	SO512M BII5	N	N120GB5 .4K	ABT_BR M4318BG	N
TM249 2WLMi	EMEA	TM2492WLMi XPHUK1 UMAC 1*512/120/6L/ 5R_bg_0.3C_AN	TM249 2WL	CM420	SO512M BII5	N	N120GB5 .4K	ABT_BR M4318BG	N
TM249 2WLMi	EMEA	TM2492WLMi XPPAR1 UMAC 1*512/120/6L/ 5R_bg_0.3C_AN	TM249 2WL	CM420	SO512M BII5	N	N120GB5 .4K	ABT_BR M4318BG	N
TM249 2WLMi	EMEA	TM2492WLMi XPPBE1 UMAC 1*512/120/6L/ 5R_bg_0.3C_AN	TM249 2WL	CM420	SO512M BII5	N	N120GB5 .4K	ABT_BR M4318BG	N
TM249 2WLMi	EMEA	TM2492WLMi XPPDE7 UMAC 1*512/120/6L/ 5R_bg_0.3C_AN	TM249 2WL	CM420	SO512M BII5	N	N120GB5 .4K	ABT_BR M4318BG	N
TM249 2WLMi	EMEA	TM2492WLMi XPPCS2 UMAC 1*512/120/6L/ 5R_bg_0.3C_AN	TM249 2WL	CM420	SO512M BII5	N	N120GB5 .4K	ABT_BR M4318BG	N
TM249 2WLMi	EMEA	TM2492WLMi XPPHU6 UMAC 1*512/120/6L/ 5R_bg_0.3C_AN	TM249 2WL	CM420	SO512M BII5	N	N120GB5 .4K	ABT_BR M4318BG	N
TM249 2WLMi	EMEA	TM2492WLMi XPPESA UMAC 1*512/120/6L/ 5R_bg_0.3C_AN	TM249 2WL	CM420	SO512M BII5	N	N120GB5 .4K	ABT_BR M4318BG	N
TM249 2WLMi	EMEA	TM2492WLMi XPPDK1 UMAC 1*512/120/6L/ 5R_bg_0.3C_AN	TM249 2WL	CM420	SO512M BII5	N	N120GB5 .4K	ABT_BR M4318BG	N
TM249 2WLMi	EMEA	TM2492WLMi XPPFRA UMAC 1*512/120/6L/ 5R_bg_0.3C_AN	TM249 2WL	CM420	SO512M BII5	N	N120GB5 .4K	ABT_BR M4318BG	N

TravelMate 2490

Model	RO	Description	Group1	CPU	Memory 1	DIMM 2	HDD 1 (GB)	Wireless LAN	Bluetooth
TM249 2WLMi	EMEA	TM2492WLMi XPPPEL3 UMAC 1*512/120/6L/ 5R_bg_0.3C_AN	TM249 2WL	CM420	SO512M BII5	N	N120GB5 .4K	ABT_BR M4318BG	N
TM249 2WLMi	EMEA	TM2492WLMi XPPNL1 UMAC 1*512/120/6L/ 5R_bg_0.3C_AN	TM249 2WL	CM420	SO512M BII5	N	N120GB5 .4K	ABT_BR M4318BG	N
TM249 2WLMi	EMEA	TM2492WLMi XPPIS1 UMAC 1*512/120/6L/ 5R_bg_0.3C_AN	TM249 2WL	CM420	SO512M BII5	N	N120GB5 .4K	ABT_BR M4318BG	N
TM249 2WLMi	EMEA	TM2492WLMi XPPIT1 UMAC 1*512/120/6L/ 5R_bg_0.3C_AN	TM249 2WL	CM420	SO512M BII5	N	N120GB5 .4K	ABT_BR M4318BG	N
TM249 2WLMi	EMEA	TM2492WLMi XPPPT1 UMAC 1*512/120/6L/ 5R_bg_0.3C_AN	TM249 2WL	CM420	SO512M BII5	N	N120GB5 .4K	ABT_BR M4318BG	N
TM249 2WLMi	EMEA	TM2492WLMi XPPPL6 UMAC 1*512/120/6L/ 5R_bg_0.3C_AN	TM249 2WL	CM420	SO512M BII5	N	N120GB5 .4K	ABT_BR M4318BG	N
TM249 2WLMi	EMEA	TM2492WLMi XPPNO1 UMAC 1*512/120/6L/ 5R_bg_0.3C_AN	TM249 2WL	CM420	SO512M BII5	N	N120GB5 .4K	ABT_BR M4318BG	N
TM249 2WLMi	EMEA	TM2492WLMi XPPRU2 UMAC 1*512/120/6L/ 5R_bg_0.3C_AN	TM249 2WL	CM420	SO512M BII5	N	N120GB5 .4K	ABT_BR M4318BG	N
TM249 2WLMi	EMEA	TM2492WLMi XPPSV1 UMAC 1*512/120/6L/ 5R_bg_0.3C_AN	TM249 2WL	CM420	SO512M BII5	N	N120GB5 .4K	ABT_BR M4318BG	N
TM249 2WLMi	EMEA	TM2492WLMi XPPSLO1 UMAC 1*512/120/6L/ 5R_bg_0.3C_AN	TM249 2WL	CM420	SO512M BII5	N	N120GB5 .4K	ABT_BR M4318BG	N
TM249 2WLMi	EMEA	TM2492WLMi XPPTR1 UMAC 1*512/120/6L/ 5R_bg_0.3C_AN	TM249 2WL	CM420	SO512M BII5	N	N120GB5 .4K	ABT_BR M4318BG	N
TM249 2WLMi	EMEA	TM2492WLMi XPPSW5 UMAC 1*512/120/6L/ 5R_bg_0.3C_AN	TM249 2WL	CM420	SO512M BII5	N	N120GB5 .4K	ABT_BR M4318BG	N
TM249 2WLMi	EMEA	TM2492WLMi XPPSA1 UMAC 1*512/120/6L/ 5R_bg_0.3C_AN	TM249 2WL	CM420	SO512M BII5	N	N120GB5 .4K	ABT_BR M4318BG	N
TM249 2WLMi	EMEA	TM2492WLMi XPPUK1 UMAC 1*512/120/6L/ 5R_bg_0.3C_AN	TM249 2WL	CM420	SO512M BII5	N	N120GB5 .4K	ABT_BR M4318BG	N

Test Compatible Components

This computer's compatibility is tested and verified by Acer's internal testing department. All of its system functions are tested under Windows® XP Home environment.

Refer to the following lists for components, adapter cards, and peripherals which have passed these tests. Regarding configuration, combination and test procedures, please refer to the Aspire 5680/5630/3690 Travelmate 4280/4230/2490 series Compatibility Test Report released by the Acer Mobile System Testing Department.

Microsoft Windows XP Environment Test

Item	Specifications
Processor	Aspire 3000: MOBILE SEMPRON 2800+ 25W D MOBILE SEMPRON 3000+ 25W D Aspire 5000 MOBILE TURION 64 ML28 MOBILE TURION 64 ML30 MOBILE TURION 64 ML32 MOBILE TURION 64 ML34 MOBILE TURION 64 ML37
Memory	SO-DIMM DDR333 1GB EBD11UD8ADD A SO-DIMM DDR333 256MB HYS64D320 20HDL-6-C 32X64 (.11U) SO-DIMM DDR333 256MB NT256D64SH8C0GM-6K (.11U) SO-DIMM DDR333 256MB M470L3224 FT0-CB3 (.13U) SO-DIMM DDR333 256MB HYMD232M6 46D6-J AA SO-DIMM DDR333 512MB HYS64D64020HBDL-6-C 64MX64 (0.11U/ GREEN) SO-DIMM DDR333 512MB M470L6524 BT0-CB300 (512MB) SO-DIMM 512MB HYMD564M646B6-J
LCD	15.4" WXGA NB LC AU B154EW01V.5 15.4" WXGA NB LCD SAMSUNGLTN154X3-L01-0 non-glare 15.4" WXGA NB LCD LPL LP154W01-TL12 (lead-free) 15.4" WXGA NB LCD QDI QD15TL02V.01 NON-GLARE TYPE 15.4" WXGA NB LCD QDI QD15TL02-03 NON-GLARE TYPE LEAD-FREE 15.4" WXGA CMO LCD N154I1-L09 15.4" WXGA NB LCD AUO B154W01V.7 (Glare type) 15.4" WXGA NB LCD LPL LP154W1-A5K2 GLARE TYPE 15.4" WXGA NB LCD QDI QD15TL02-02 GLARE TYPE 15.4" WXGA NB LCD QDI QD15TL02-04 GLARE TYPE LEAD-FREE 15.4" WXGA NB LCD N154I1-L07GLARE TYPE
LCD	15" XGA NB LCD AUO B150XG01V2.XXXXX (Driver IC:MEC/TOS 15" XGA NB LCD SAMSUNG LTN150XB-L03-C00 MADE IN CHINA 15" XGA NB LCD LG LP150X08-A3MADE IN CHINA 15" XGA NB LCD QDI QD150XL06-01(160NITS) 15" XGA NB LCD N150X3-L07 V.C2
Hard Disk Drive	40G SEAGATE 2.5 4200RPM N1 ST94019A 2M F/W 3.05 40G TOSHIBA 2.5" 4200RPM PLUTO MK4025GAS (ROHS) F/W KA100A 40G HGST 2.5" 4.2RPM MORAGA+HTS424040M9AT00 13G1132 F/W:A71A 60G SEAGATE 2.5" 4.2RPM N2ST960821A F/W 3.01 60G TOSHIBA 2.5" 4200RPM PLUTO MK6025GAS (ROHS) F/W KA200 80G TOSHIBA 2.5" 4200RPM PLUTO MK8025GAS (ROHS) F/W KA023 80G HGST MORAGA 4200RPM IC25N0 80ATMR04-0 08K635 FW:AD4A

Item	Specifications
ODD	24X COMBO KME UJDA-760 FOR K ESTREL 8X DVD DUAL LITEON SOSW-852SSINGLE LAYER FOR KESTREL #PRS7 8X DVD DUAL , LITEON SOSW-833,DOUBLE LAYER,GBASE FOR CRANE 8X DVD DUAL,PANASONIC UJ-840BAA2,DOUBLE LAYER,GBASE FR CRANE 8X SUPERMULTI,PANASONIC UJ-840BAA,DOUBLE LAYER,GBASE(CRANE)
AC Adapter (3 pin)	Delta NB Asapter 65W, SADP-65KB BF Lite-on NB Adapter 65W, PA-1650-02 LSE NB Adapter 65W, P0335A1965
Power Cord	King Cord
Battery Li-Ion, 8 cells	LI-ION KESTREL 4S2P 4.4Ah W/OINDICATOR (W/Z SANYO CELLS) LI-ION KESTREL 4S2P PANASONIC PACK CELL 4.4AH W/O INDICATOR
Network Adapters	
LAN Ethernet/10baseT/100base	3Com Etherlink III 3C589D IBM EtherJet CardBus Adapter 10/100 Intel Ether Express Pro/100 Mobile Adapter MBLA3200 Xircom CardBus Ethernet 10/100 32 Bit CBE-10/100BTX
Multifunction Card (Combo)	3Com Megahertz 10/100 LAN + 56K Modem PC Card Xircom RealPort CardBus Ethenet 10/100 + Modem 56
LAN Token Ring	IBM Token Ring 16/4 Adapter II
Wireless LAN Card	IBM Wireless LAN Cardbus Adapter Intel Pro-Wireless LAN PC Card Proxim Skyline 802.11a Cardbus PC Card Cisco Aironet 350 series Wireless Lan Card NeWeb Wireless Lan Card 802.11b
Modem Adapters	
Modem (up to 56K)	3Com Megahertz 56K Modem PC Card Xircom Credit Card Modem 56 IBM 56K Double Jack Modem
ISDN	US Robotics Megahertz 128K ISDN Card 405R17T7117M IBM OBI International ISDN PC Card
I/O Peripheral	
I/O - Display	Acer 211c 21" Viewsonic PF790 19" Acer FP751 17" TFT LCD IBM Color TFT LCD 14" Compaq Color Monitor NET Color Monitor 20" Mozo 17" TFT LCD (DVI)
I/O - Projector	NEC MultiSync MT-1040
I/O - Legacy (Parallel) Printer/Scanner	Canon BJC-600J Epson Stylus Color 740 Parallel Interface HP DeskJet 890C HP DeskJet 880C Parallel Interface HP LaserJet 6MP HP LaserJet 2200

Item	Specifications
I/O - IR Printer	HP LaserJet 6MP use IR HP LaserJet 2200 use IR
I/O - USB Keyboard/Mouse	Chicony USB Keyboard KU-8933 Microsoft Natural Keyboard Pro Acer Aspire USB mouse Logicool US Mouse Logitech Cordless Mouseman Wheel USB Interface Logitech USB Wheel Mouse M-BB48 Microsoft IntelliMouse Optical USB Interface
I/O - Legacy (PS2/Serial) Keyboard/ Mouse	IBM 101 key keyboard IBM 109 key keyboard Acer PS2 keyboard Acer KB-101A IBM Numeric Keypad III IBM Numeric Keypad Acer Mouse IBM PS2 Mini Mouse IBM PS2 Mouse Logitech Cordless MouseMan Wheel PS2 interface Logitech Serial Mouse M-M35 Microsoft IntelliMouse PS2 interface Microsoft IntelliMouse Optical PS2 interface Logitech First Mouse Three Button Serial Mouse
I/O - USB (Printer/Scanner)	Epson Stylus Color 740 USB interface HP DeskJet 880C USB interface Canon CanonScan D1250 (USB 2.0, JP OS only) HP ScanJet 3300C Color Scanner
I/O - USB (Speaker/Joystick))	JS USB Digital Speaker Panasonic USB Speaker EAB-MPC57USB AIWA Multimedia Digital Speaker Microsoft SideWinder Precision Pro Joystick Logitech WingMan RumblePad
I/O - USB Camera	Intel Easy PC Camera Logitech QuickCam Express Internet Logitech QuickCam Home PC Video Camera Orange Micro USB 2.0 Web Cam
I/O - USB Storage Drive	Logitech CDRW +DVDROM combo USB interface Iomega USB Zip 250MB
I/O-USB Flash Drive	IBM 32MB USB Memory key Apacer USB Handy Drive 32MB Apacer USB Handy Drive 256MB
I/O - USB Hub	Belkin 4 Port USB Hub Eizo I Station USB Hub Elecom USB Hub 4 Port Sanwa USB Hub 4 Port 4 Port Hub USB 2.0
I/O - Access Point (802.11b)	Hitachi DC-CN3300 Lucent RG-1000 Lucent WavePoint-II Cisco Aironet 350 Orinoco AP-500

Item	Specifications
I/O Access Point (802.11a/b)	Intel Dual Pro/Wireless 5000
I/O Access Point (802.11a)	Intel Pro/Wireless 5000
PCMCIA	
PCMCIA - ATA	IBM Microdrive 340MB IBM Microdrive 1G Iomega Click! 40MB Sony Memory Stick 64MB Sandisk Flash Card 20MB Apacer SD Flash Card 128MB Apacer SD Flash Card 256MB Transcend SD Card 32MB Transcend SD Card 256MB Hagiwara sys-com SD Card 256MBT
PCMCIA - USB 2.0	Apricorn EZ-USB2.0 Cardbus PC Card DTK USB 2.0 2Port CardBus Host Controller Adaptec USB2CONNECT
PCMCIA - 1394	Buffalo 1394 Interface Cardbus IFC-ILCB/DV I-O Data 1394 Interface Cardbus CB1394/DVC Pixela 1394 Cardbus PC Card PIX-PCMC/FW1
PCMCIA-SCSI	Adaptec 1408 or B SCSI CB NewMedia Bus Toaster SCSI II
PCMCIA - Bluetooth	IBM Community Bluetooth PC Card Toshiba Bluetooth PC Card

Online Support Information

This section describes online technical support services available to help you repair your Acer Systems.

If you are a distributor, dealer, ASP or TPM, please refer your technical queries to your local Acer branch office. Acer Branch Offices and Regional Business Units may access our website. However some information sources will require a user i.d. and password. These can be obtained directly from Acer CSD Taiwan.

Acer's Website offers you convenient and valuable support resources whenever you need them.

In the Technical Information section you can download information on all of Acer's Notebook, Desktop and Server models including:

- Service guides for all models
- User's manuals
- Training materials
- Bios updates
- Software utilities
- Spare parts lists
- TABs (Technical Announcement Bulletin)

For these purposes, we have included an Acrobat File to facilitate the problem-free downloading of our technical material.

Also contained on this website are:

- Detailed information on Acer's International Traveler's Warranty (ITW)
- Returned material authorization procedures
- An overview of all the support services we offer, accompanied by a list of telephone, fax and email contacts for all your technical queries.

We are always looking for ways to optimize and improve our services, so if you have any suggestions or comments, please do not hesitate to communicate these to us.

Free Manuals Download Website

<http://myh66.com>

<http://usermanuals.us>

<http://www.somanuals.com>

<http://www.4manuals.cc>

<http://www.manual-lib.com>

<http://www.404manual.com>

<http://www.luxmanual.com>

<http://aubethermostatmanual.com>

Golf course search by state

<http://golfingnear.com>

Email search by domain

<http://emailbydomain.com>

Auto manuals search

<http://auto.somanuals.com>

TV manuals search

<http://tv.somanuals.com>