

E3360
First Edition
August 2007



Xonar D2X

Audio Card

Quick Installation Guide

1.1 Installation requirements

To ensure a successful installation of the Xonar D2X audio card, your computer must meet the following requirements:

- One PCI Express 1.0 (or higher) compatible slot for the audio card
- One available 4-pin power cable from PC's power supply unit
- Microsoft® Windows® Vista/XP(32/64bit)/MCE2005
- Intel® Pentium® 4 1.4GHz or AMD Athlon 1400 CPU or faster CPU
- > 256 MB DRAM system memory
- > 60 MB available HDD space for driver installation package; > 200MB space available for Ableton Live and > 320MB for Cakewalk package
- CD-ROM drive (or DVD-ROM drive) for software installation
- High-quality headphones, powered analog speakers, or digital speakers with Dolby Digital or DTS decoders to enjoy the Ultra-High Fidelity sounds of the card

Before the installation, check your ASUS Xonar D2X audio card package for the following items:

- ASUS Xonar D2X audio card
- ASUS Xonar D2X support CD
- Ableton™ Live Lite software CD
- Cakewalk™ Production Plus Pack CD (Sonar LE, Dimension LE, and Project5 LE)
- PowerDVD 7.0 software DVD player CD
- Additional MIDI bracket and adaptor cable x1
- S/PDIF TOSLINK optical adaptors x2
- S/PDIF TOSLINK optical cable x1
- 3.5mm-to-RCA cables for 8-channel output x4
- Dolby Demo CD
- Quick Installation Guide

1.2 Card installation

To install the Xonar D2X audio card:

1. Touch the metal back or side panel of the computer to avoid static electricity.
2. Power OFF the computer, the monitor, and all other peripheral devices connected to your computer.
3. Unplug the computer power cord from your computer and power outlet.
4. Remove the chassis cover.
5. Locate an empty PCIE slot on the motherboard.
6. Connect the power cable of the power supply to the power connector on the audio card.
7. Align and insert the audio card into the PCIE slot until it seats in place. Make sure the goldfingers are properly inserted to the slot.
8. Secure the bracket screw that holds the audio card in place. Refer to the picture below for the bracket screw hole.
9. Put back the chassis cover.
10. Reconnect all cables.
11. Plug the power cord to the computer and to a power outlet.
12. Power ON the computer.



the PCI Express high-quality audio card requires additional power from your computer. If the power cable is not connected properly, the audio card will not work at all.

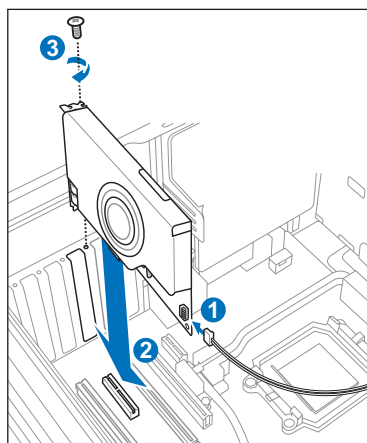

When removing the power cable from the Xonar D2X audio card, make sure to pull outward the 4-pin header first, then unplug it from the power connector as the following pictures show. Do not forcefully remove the header from the power connector; doing so may pull up the power connector from the audio card and cause damage!

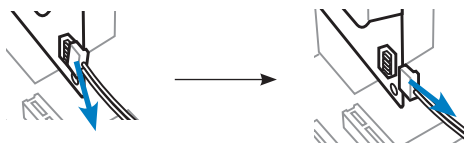

1.3 Driver installation

After installing the Xonar D2X audio card on your computer, you need to install the device driver that enables the Xonar D2X audio card to work with Windows operating system.



The version and content of the driver CD are subject to change without notice.

If you have already installed the ASUS Xonar D2X audio card, the Found New Hardware Wizard window may pop up before or during driver installation. See figure below.



1.3.1 Installing the Audio Card Driver

To install the device driver:

1. Click **Cancel** from the **Found New Hardware wizard** window.
2. Insert the ASUS Xonar D2X support CD into your optical drive.
If autorun is enabled, the ASUS Xonar Card Driver screen appears automatically. Go to step 5.
If Autorun is not enabled in your computer, perform step 3.
3. Click **My Computer** on your desktop and double-click the optical drive icon.
4. Double-click the **setup.exe** icon located on the optical drive.
5. Follow the on-screen instructions to complete the installation. Read the "**END USER LICENSE AGREEMENT**" in the process and make sure that you understand and accept it before continuing the installation.
6. When the installation finishes, you may be prompted to restart your computer. You can choose to restart the computer later if desired.

1.4 Connecting speakers

LED color definition



This audio card comes with LEDs in different colors that defines each port.

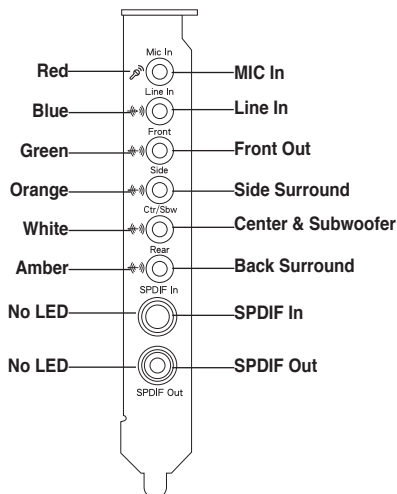

For Analog Spakers

2 Speakers

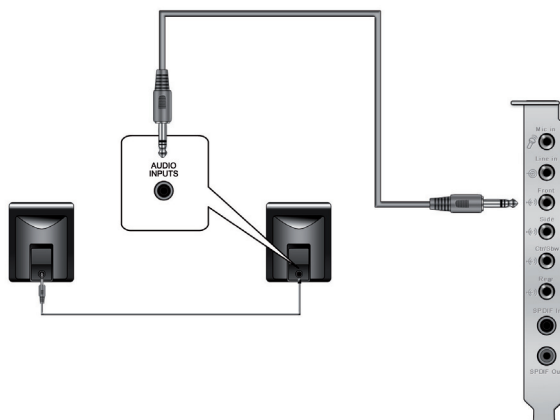

2.1 Speakers

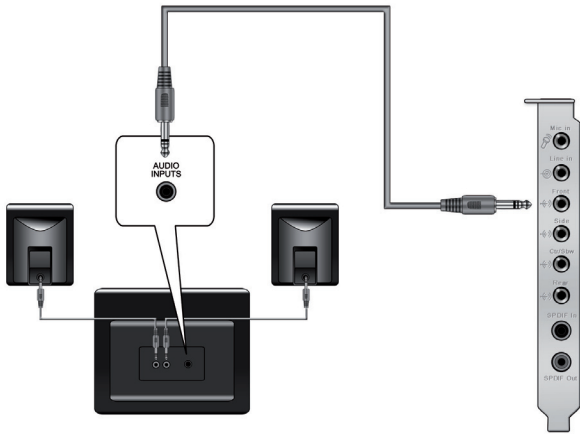

4 Speakers

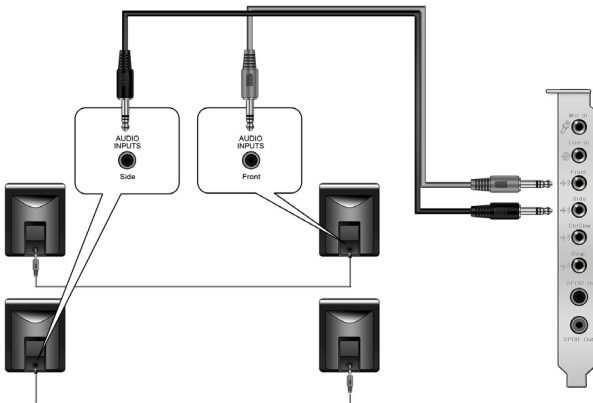

4.1 Speakers

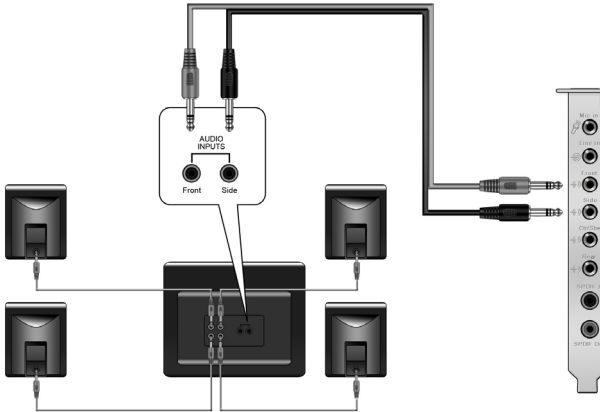

5.1 Speakers

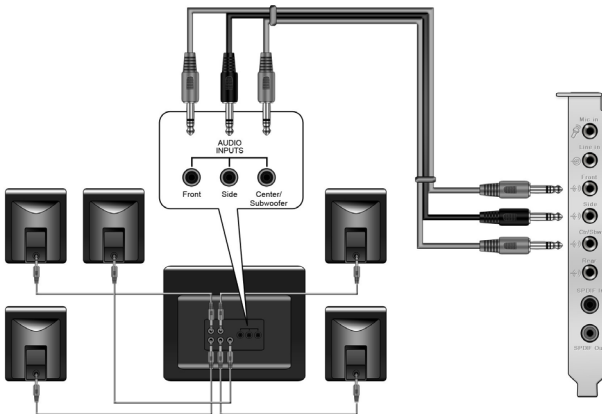

6.1 Speakers

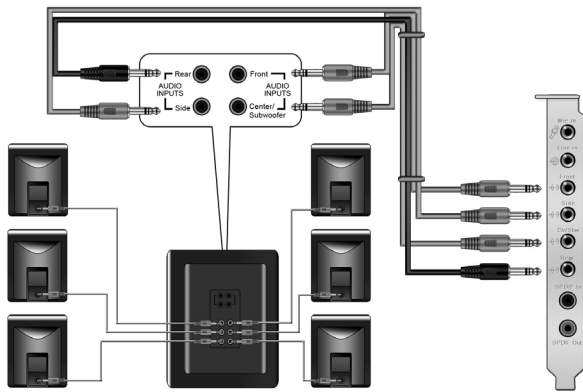

7.1 Speakers

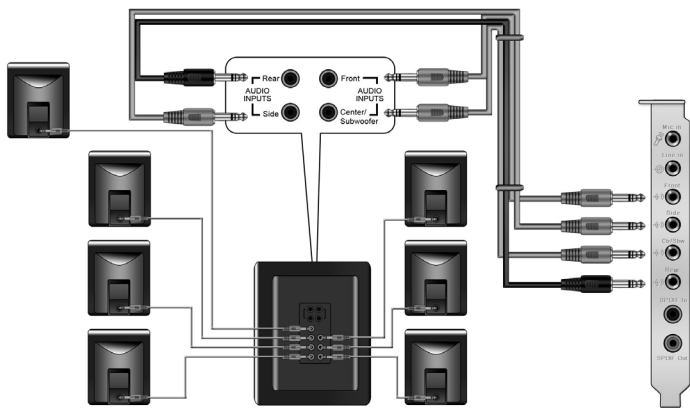

For Digital Speakers

SPDIF Out

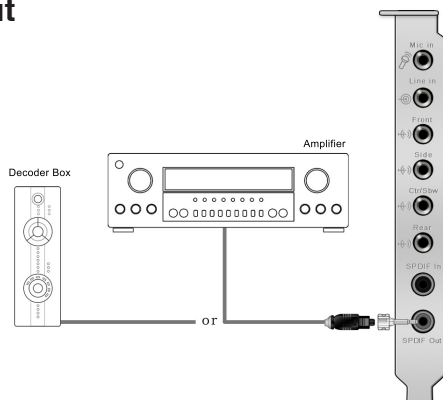

Plug the optical TOSLINK adaptor into the S/PDIF-Out combo connector. Then, connect your decoder's S/PDIF in port to the optical adaptor with the TOSLINK optical cable



You can also use a coaxial cable for a S/PDIF connection. Just plug the coaxial RCA male connector to the S/PDIF-Out combo jack and connect the other end into the coaxial S/PDIF input on your decoder.

SPDIF

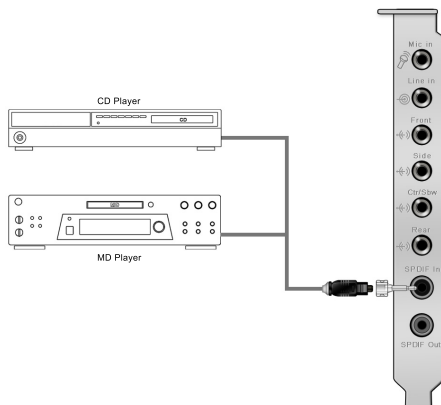

Plug the optical TOSLINK adaptor into the S/PDIF-In combo connector. Then, connect your MD/CD/DVD player's S/PDIF out port to the optical adaptor with the TOSLINK optical cable



You can also use a coaxial cable for a S/PDIF digital connection. Just plug the coaxial RCA male connector to the S/PDIF-In combo jack and connect the other end into the coaxial S/PDIF output on the player.

Connecting headphone / microphone

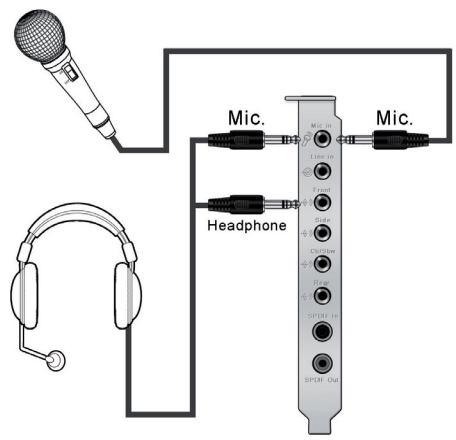

Connecting Line-In audio sources

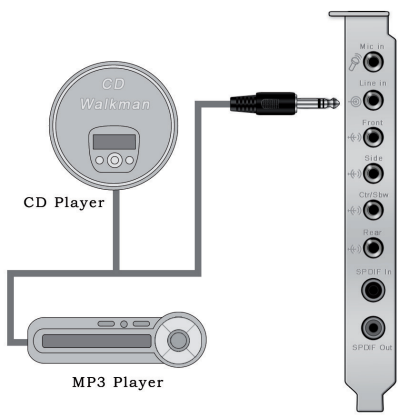

Free Manuals Download Website

<http://myh66.com>

<http://usermanuals.us>

<http://www.somanuals.com>

<http://www.4manuals.cc>

<http://www.manual-lib.com>

<http://www.404manual.com>

<http://www.luxmanual.com>

<http://aubethermostatmanual.com>

Golf course search by state

<http://golfingnear.com>

Email search by domain

<http://emailbydomain.com>

Auto manuals search

<http://auto.somanuals.com>

TV manuals search

<http://tv.somanuals.com>