

M2N-E SLI



Motherboard

E2830

First Edition
October 2006

Copyright © 2006 ASUSTeK COMPUTER INC. All Rights Reserved.

No part of this manual, including the products and software described in it, may be reproduced, transmitted, transcribed, stored in a retrieval system, or translated into any language in any form or by any means, except documentation kept by the purchaser for backup purposes, without the express written permission of ASUSTeK COMPUTER INC. ("ASUS").

Product warranty or service will not be extended if: (1) the product is repaired, modified or altered, unless such repair, modification or alteration is authorized in writing by ASUS; or (2) the serial number of the product is defaced or missing.

ASUS PROVIDES THIS MANUAL "AS IS" WITHOUT WARRANTY OF ANY KIND, EITHER EXPRESS OR IMPLIED, INCLUDING BUT NOT LIMITED TO THE IMPLIED WARRANTIES OR CONDITIONS OF MERCHANTABILITY OR FITNESS FOR A PARTICULAR PURPOSE. IN NO EVENT SHALL ASUS, ITS DIRECTORS, OFFICERS, EMPLOYEES OR AGENTS BE LIABLE FOR ANY INDIRECT, SPECIAL, INCIDENTAL, OR CONSEQUENTIAL DAMAGES (INCLUDING DAMAGES FOR LOSS OF PROFITS, LOSS OF BUSINESS, LOSS OF USE OR DATA, INTERRUPTION OF BUSINESS AND THE LIKE), EVEN IF ASUS HAS BEEN ADVISED OF THE POSSIBILITY OF SUCH DAMAGES ARISING FROM ANY DEFECT OR ERROR IN THIS MANUAL OR PRODUCT.

SPECIFICATIONS AND INFORMATION CONTAINED IN THIS MANUAL ARE FURNISHED FOR INFORMATIONAL USE ONLY, AND ARE SUBJECT TO CHANGE AT ANY TIME WITHOUT NOTICE, AND SHOULD NOT BE CONSTRUED AS A COMMITMENT BY ASUS. ASUS ASSUMES NO RESPONSIBILITY OR LIABILITY FOR ANY ERRORS OR INACCURACIES THAT MAY APPEAR IN THIS MANUAL, INCLUDING THE PRODUCTS AND SOFTWARE DESCRIBED IN IT.

Products and corporate names appearing in this manual may or may not be registered trademarks or copyrights of their respective companies, and are used only for identification or explanation and to the owners' benefit, without intent to infringe.

Contents

Notices	vii
Safety information	viii
About this guide.....	ix
Typography	x
M2N-E SLI specifications summary.....	xi
 Chapter 1: Product introduction	
1.1 Welcome!	1-1
1.2 Package contents	1-1
1.3 Special features	1-2
1.3.1 Product highlights	1-2
1.3.2 ASUS Special features.....	1-4
 Chapter 2: Hardware information	
2.1 Before you proceed	2-1
2.2 Motherboard overview	2-2
2.2.1 Placement direction	2-2
2.2.2 Screw holes.....	2-2
2.2.3 Motherboard layout	2-3
2.2.4 Layout Contents	2-4
2.3 Central Processing Unit (CPU)	2-5
2.3.1 Installing the CPU.....	2-5
2.3.2 Installing the heatsink and fan	2-7
2.4 System memory.....	2-10
2.4.1 Overview	2-10
2.4.2 Memory configurations	2-10
2.4.3 Installing a DIMM	2-15
2.4.4 Removing a DIMM.....	2-15
2.5 Expansion slots	2-16
2.5.1 Installing an expansion card	2-16
2.5.2 Configuring an expansion card	2-16
2.5.3 Interrupt assignments.....	2-17
2.5.4 PCI slots	2-17
2.5.5 PCI Express x1 slot	2-18
2.5.6 PCI Express x16 slots.....	2-18

Contents

2.6	Jumpers	2-19
2.7	Connectors	2-22
2.7.1	Rear panel connectors	2-22
2.7.2	Internal connectors.....	2-24

Chapter 3: Powering up

3.1	Starting up for the first time	3-1
3.2	Powering off the computer.....	3-2
3.2.1	Using the OS shut down function	3-2
3.2.2	Using the dual function power switch.....	3-2

Chapter 4: BIOS setup

4.1	Managing and updating your BIOS	4-1
4.1.1	Creating a bootable floppy disk	4-1
4.1.2	Updating the BIOS.....	4-2
4.1.3	Saving the current BIOS file	4-4
4.1.4	ASUS CrashFree BIOS 3 utility	4-5
4.1.5	ASUS EZ Flash 2 utility.....	4-7
4.1.6	ASUS Update utility	4-8
4.2	BIOS setup program.....	4-11
4.2.1	BIOS menu screen.....	4-12
4.2.2	Menu bar	4-12
4.2.3	Legend bar	4-13
4.2.4	Menu items	4-13
4.2.5	Sub-menu items.....	4-13
4.2.6	Configuration fields.....	4-13
4.2.7	Pop-up window.....	4-14
4.2.8	General help	4-14
4.3	Main menu.....	4-15
4.3.1	System Time	4-15
4.3.2	System Date	4-15
4.3.3	Legacy Diskette A	4-15
4.3.5	Primary and Secondary IDE Master/Slave	4-16
4.3.6	SATA 1, 2, 3, 4.....	4-18
4.3.7	HDD SMART Monitoring.....	4-19

Contents

4.3.8	Installed Memory	4-19
4.4	Advanced menu	4-20
4.4.1	JumperFree Configuration.....	4-20
4.4.3	CPU Configuration	4-23
4.4.4	PCIePnP	4-25
4.4.5	Onboard Device Configuration	4-26
4.4.6	SLI Configuration.....	4-31
4.5	Power menu	4-32
4.5.1	ACPI Suspend Type	4-32
4.5.2	ACPI APIC Support	4-32
4.5.3	APM Configuration	4-33
4.5.4	Hardware Monitor.....	4-35
4.6	Boot menu	4-37
4.6.1	Boot Device Priority	4-37
4.6.2	Removable Drives.....	4-38
4.6.3	Hard Disk Drives.....	4-38
4.6.4	Boot Settings Configuration	4-39
4.6.5	Security.....	4-41
4.7	Tools menu	4-43
	ASUS EZ Flash 2.....	4-43
4.8	Exit menu.....	4-44

Chapter 5: Software support

5.1	Installing an operating system.....	5-1
5.2	Support CD information	5-1
5.2.1	Running the support CD.....	5-1
5.2.2	Drivers menu	5-2
5.2.3	Utilities menu	5-3
5.2.4	Manuals menu	5-4
5.2.5	ASUS Contact information	5-5
5.2.6	Other information	5-5
5.3	Software information.....	5-8
5.3.1	Cool 'n' Quiet!™ Technology	5-8
5.3.2	ASUS PC Probe II	5-10

Contents

- 5.4 RAID configurations 5-16
 - 5.4.1 Installing hard disks..... 5-17
 - 5.4.2 NVIDIA® RAID configurations..... 5-18
- 5.5 Creating a RAID driver disk 5-25

- Chapter 6: NVIDIA® SLI™ technology support
 - 6.1 Overview 6-1
 - Requirements..... 6-1
 - 6.2 Dual graphics card setup 6-2
 - 6.2.1 Installing SLI-ready graphics cards..... 6-2
 - 6.2.2 Installing the device drivers 6-5
 - 6.2.3 Enabling the multi-GPU feature in Windows..... 6-5

Notices

Federal Communications Commission Statement

This device complies with Part 15 of the FCC Rules. Operation is subject to the following two conditions:

- This device may not cause harmful interference, and
- This device must accept any interference received including interference that may cause undesired operation.

This equipment has been tested and found to comply with the limits for a Class B digital device, pursuant to Part 15 of the FCC Rules. These limits are designed to provide reasonable protection against harmful interference in a residential installation. This equipment generates, uses and can radiate radio frequency energy and, if not installed and used in accordance with manufacturer's instructions, may cause harmful interference to radio communications. However, there is no guarantee that interference will not occur in a particular installation. If this equipment does cause harmful interference to radio or television reception, which can be determined by turning the equipment off and on, the user is encouraged to try to correct the interference by one or more of the following measures:

- Reorient or relocate the receiving antenna.
- Increase the separation between the equipment and receiver.
- Connect the equipment to an outlet on a circuit different from that to which the receiver is connected.
- Consult the dealer or an experienced radio/TV technician for help.



The use of shielded cables for connection of the monitor to the graphics card is required to assure compliance with FCC regulations. Changes or modifications to this unit not expressly approved by the party responsible for compliance could void the user's authority to operate this equipment.

Canadian Department of Communications Statement

This digital apparatus does not exceed the Class B limits for radio noise emissions from digital apparatus set out in the Radio Interference Regulations of the Canadian Department of Communications.

This class B digital apparatus complies with Canadian ICES-003.

Safety information

Electrical safety

- To prevent electrical shock hazard, disconnect the power cable from the electrical outlet before relocating the system.
- When adding or removing devices to or from the system, ensure that the power cables for the devices are unplugged before the signal cables are connected. If possible, disconnect all power cables from the existing system before you add a device.
- Before connecting or removing signal cables from the motherboard, ensure that all power cables are unplugged.
- Seek professional assistance before using an adapter or extension cord. These devices could interrupt the grounding circuit.
- Make sure that your power supply is set to the correct voltage in your area. If you are not sure about the voltage of the electrical outlet you are using, contact your local power company.
- If the power supply is broken, do not try to fix it by yourself. Contact a qualified service technician or your retailer.

Operation safety

- Before installing the motherboard and adding devices on it, carefully read all the manuals that came with the package.
- Before using the product, make sure all cables are correctly connected and the power cables are not damaged. If you detect any damage, contact your dealer immediately.
- To avoid short circuits, keep paper clips, screws, and staples away from connectors, slots, sockets and circuitry.
- Avoid dust, humidity, and temperature extremes. Do not place the product in any area where it may become wet.
- Place the product on a stable surface.
- If you encounter technical problems with the product, contact a qualified service technician or your retailer.



The symbol of the crossed out wheeled bin indicates that the product (electrical and electronic equipment) should not be placed in municipal waste. Check local regulations for disposal of electronic products.

About this guide

This user guide contains the information you need when installing and configuring the motherboard.

How this guide is organized

This manual contains the following parts:

- **Chapter 1: Product introduction**
This chapter describes the features of the motherboard and the new technology it supports.
- **Chapter 2: Hardware information**
This chapter lists the hardware setup procedures that you have to perform when installing system components. It includes description of the switches, jumpers, and connectors on the motherboard.
- **Chapter 3: Powering up**
This chapter describes the power up sequence, the vocal POST messages, and ways of shutting down the system.
- **Chapter 4: BIOS setup**
This chapter tells how to change system settings through the BIOS Setup menus. Detailed descriptions of the BIOS parameters are also provided.
- **Chapter 5: Software support**
This chapter describes the contents of the support CD that comes with the motherboard package.
- **Chapter 6: NVIDIA® SLI™ technology support**
This chapter tells how to install SLI-ready PCI Express graphics cards.

Where to find more information

Refer to the following sources for additional information and for product and software updates.

1. ASUS websites
The ASUS website provides updated information on ASUS hardware and software products. Refer to the ASUS contact information.
2. Optional documentation
Your product package may include optional documentation, such as warranty flyers, that may have been added by your dealer. These documents are not part of the standard package.

Conventions used in this guide

To make sure that you perform certain tasks properly, take note of the following symbols used throughout this manual.



DANGER/WARNING: Information to prevent injury to yourself when trying to complete a task.



CAUTION: Information to prevent damage to the components when trying to complete a task.



IMPORTANT: Instructions that you **MUST** follow to complete a task.



NOTE: Tips and additional information to help you complete a task.

Typography

Bold text

Indicates a menu or an item to select

Italics

Used to emphasize a word or a phrase

<Key>

Keys enclosed in the less-than and greater-than sign means that you must press the enclosed key

Example: <Enter> means that you must press the Enter or Return key

<Key1>+<Key2>+<Key3>

If you must press two or more keys simultaneously, the key names are linked with a plus sign (+)

Example: <Ctrl>+<Alt>+<D>

Command

Means that you must type the command exactly as shown, then supply the required item or value enclosed in brackets

Example: At the DOS prompt, type the command line:

awdf flash M2N-E SLI .ROM

M2N-E SLI specifications summary

CPU	Socket AM2 for AMD Athlon™ 64 FX/AMD Athlon™ 64 X2 /AMD Athlon 64™/AMD Sempron™ processors Supports AMD Cool 'n' Quiet™ Technology AMD64 architecture enables simultaneous 32-bit and 64-bit computing AMD Live!™ ready
Chipset	NVIDIA® nForce® 500 SLI™ MCP
System bus	2000 / 1600 MT/s
Memory	Dual-channel memory architecture <ul style="list-style-type: none"> - 4 x 240-pin DIMM sockets support unbuffered ECC/non-ECC DDR2 800/667/533 MHz memory modules - Supports up to 8 GB system memory
Expansion slots	2 x PCI Express™ x16 slots Supports NVIDIA® SLI™ Technology (both at x8 mode) 2 x PCI Express™ x1 slots 2 x PCI 2.2 slots
Scalable Link Interface (SLI™)	Supports two identical NVIDIA® SLI™-ready graphics card ASUS two-slot thermal design
Storage	NVIDIA® nForce® 500 SLI™ MCP supports: <ul style="list-style-type: none"> - 2 x IDE connector for up to four Ultra DMA 133/100/66/33 devices - 4 x Serial ATA 3.0 Gb/s connectors support four Serial ATA devices - RAID 0, RAID 1, RAID 0+1, RAID 5, and JBOD configurations spanning across Serial ATA drives
LAN	NVIDIA® nForce® 500 SLI™ MCP built-in Gigabit MAC with external Attansic PHY Supports TCP/IP Acceleration
Audio	C-Media Superior Quality Audio 7.1 channel audio CODEC (Vista ready) Supports S/PDIF Out interface
IEEE 1394a	VIA 1394 controller supports 2 x 1394a ports
USB 2.0	Supports up to 8 USB 2.0/1.1 ports (four at mid-board, four on the rear panel)
ASUS Exclusive Overclocking features	AI Overclocking (intelligent CPU frequency tuner) Stepless Frequency Selection(SFS) allows FSB tuning from 200 MHz up to 400 MHz at 1 MHz increment ASUS C.P.R. (CPU Parameter Recall) Adjustable FSB/DDR2 ratio. Fixed PCI/PCIe frequencies

(continued on the next page)

M2N-E SLI specifications summary

Special features	ASUS EZ DIY: <ul style="list-style-type: none"> - Q-Connector - ASUS CrashFree BIOS 3 - ASUS EZ Flash 2 ASUS Q-Fan 2 ASUS MyLogo2
Rear panel	1 x Parallel port 1 x PS/2 keyboard port (purple) 1 x PS/2 mouse port (green) 1 x IEEE 1394a port 1 x COM port 1 x S/PDIF Out port 1 x LAN (RJ-45) ports 4 x USB 2.0/1.1 ports 8-channel audio ports
Internal connectors	2 x USB 2.0 connectors support four additional USB 2.0 ports 1 x Floppy disk drive connector 2 x IDE connector for four devices 4 x Serial ATA connectors 1 x CPU / 1 x Chassis / 1 x Power fan connectors 1 x IEEE 1394a connector S/PDIF out connector Front panel audio connector CD audio in connectors 24-pin ATX power connector 4-pin ATX 12 V power connector System panel connector
BIOS features	4 Mb BIOS ROM, AWARD BIOS, PnP, DMI 2.0, WfM2.0, SM BIOS 2.3
Manageability	WOL by PME, WOR by PME, Chassis intrusion, PXE
Power requirements	ATX power supply with 24-pin and 4-pin 12V plugs ATX 12V 2.0 compliant
Support CD contents	Device drivers ASUS PC Probe II ASUS Update NVIDIA® MediaShield™ RAID Anti-virus software (OEM version)

*Specifications are subject to change without notice.

This chapter describes the motherboard features and the new technologies it supports.

1 Product introduction

Chapter summary

1.1	Welcome!	1-1
1.2	Package contents	1-1
1.3	Special features	1-2

1.1 Welcome!

Thank you for buying an ASUS® M2N-E SLI motherboard!

The motherboard delivers a host of new features and latest technologies, making it another standout in the long line of ASUS quality motherboards!

Before you start installing the motherboard, and hardware devices on it, check the items in your package with the list below.

1.2 Package contents

Check your motherboard package for the following items.

Motherboard	ASUS M2N-E SLI motherboard
Cables	2 x Serial ATA signal cables 1 x Serial ATA power cable with dual plugs 1 x Ultra DMA 133/100/66 cable 1 x Floppy disk drive cable
Accessories	I/O shield ASUS SLI™ bridge 1 x ASUS Q-Connector Kit (USB, System panel; Retail version only)
Application CDs	ASUS motherboard support CD
Documentation	User guide



If any of the above items is damaged or missing, contact your retailer.

1.3 Special features

1.3.1 Product highlights

Latest processor technology



The motherboard comes with a 940-pin AM2 socket that supports AMD Athlon™ 64 FX/AMD Athlon™ 64 X2/AMD Athlon™ 64/AMD Sempron™ processors. With an integrated low-latency high-bandwidth memory controller and a highly scalable HyperTransport™ technology-based system bus, the motherboard provides a powerful platform for your diverse computing needs, increased office productivity, and enhanced digital media experience. See page 2-5 for details.

Scalable Link Interface (SLI™) technology



The NVIDIA® Scalable Link Interface (SLI™) technology allows two graphics processing units (GPUs) in a single system. This technology takes advantage of the PCI Express™ bus architecture and features intelligent hardware and software solutions that allows multiple GPUs to work together and achieve exceptional graphics performance. See Chapter 6 for details.

AMD Cool 'n' Quiet!™ Technology



The motherboard supports the AMD Cool 'n' Quiet!™ Technology that dynamically and automatically changes the CPU speed, voltage and amount of power depending on the task the CPU performs. See pages 4-25, 5-3 and 5-9.

Gigabit LAN



The motherboard comes with a Gigabit LAN controller built into the NVIDIA® nForce™ 500 SLI™ chipset to meet your growing networking needs. The controller uses the PCI Express segment to provide faster data bandwidth for your Internet, LAN, and file sharing requirements. See page 2-22 for details.

DDR2 memory support



The motherboard supports DDR2 memory that features data transfer rates of 800/667/533 MHz to meet the higher bandwidth requirements of the latest 3D graphics, multimedia, and Internet applications. The dual-channel DDR2 architecture doubles the bandwidth of your system memory to boost system performance, eliminating bottlenecks with peak bandwidths of up to 12.8 GB/s. See pages 2-10 to 2-13 for details.

Serial ATA 3Gb/s RAID

The motherboard supports the next-generation Serial ATA hard drives based on the SATA 3Gb/s storage specification. The onboard NVIDIA nForce® 500 SLI™ MCP allows RAID 0, RAID 1, RAID 0+1, RAID 5, and JBOD. See page 2-25.

PCI Express™ interface

The motherboard fully supports PCI Express, the latest I/O interconnect technology that speeds up the PCI bus. PCI Express features point-to-point serial interconnections between devices and allows higher clockspeeds by carrying data in packets. This high speed interface is software compatible with existing PCI specifications. See page 2-18 for details.

S/PDIF digital sound ready

The motherboard supports the S/PDIF Out function through the S/PDIF interfaces on the rear panel. The S/PDIF technology turns your computer into a high-end entertainment system with digital connectivity to powerful audio and speaker systems. See page 2-23 for details.



This function can only work under C-Media official driver.

USB 2.0 technology

The motherboard implements the Universal Serial Bus (USB) 2.0 specification, dramatically increasing the connection speed from the 12 Mbps bandwidth on USB 1.1 to a fast 480 Mbps on USB 2.0. USB 2.0 is backward compatible with USB 1.1. See page 2-23 and 2-27 for details.

IEEE 1394a support

The IEEE 1394a interface provides high-speed and flexible PC connectivity to a wide range of peripherals and devices compliant to the IEEE 1394a standard. The IEEE 1394a interface allows up to 400 Mbps transfer rates through simple, low-cost, high-bandwidth asynchronous (real-time) data interfacing between computers, peripherals, and consumer electronic devices such as camcorders, VCRs, printers, TVs, and digital cameras. See page 2-26 for details.

1.3.2 ASUS Special features

ASUS Two-slot thermal design

The motherboard is designed with two PCI Express x1 slots placed between the PCI Express x16 slots allowing an increase in airflow between the two PCI Express x16 graphics cards. This special design permits more room for ventilation thus lowering the overall system temperature.

ASUS CrashFree BIOS 3



The ASUS CrashFree BIOS 3 allows users to restore corrupted BIOS data from a USB flash disk containing the BIOS file. This utility saves users the cost and hassle of buying a replacement BIOS chip. See page 4-5 for details.

ASUS EZ Flash 2



EZ Flash 2 is a user-friendly BIOS update utility. Simply press the predefined hotkey to launch the utility and update the BIOS without entering the OS. Update your BIOS easily without preparing a bootable diskette or using an OS-based flash utility. See page 4-7 for details.

ASUS Q-Connector



ASUS Q-Connector allows you to easily connect or disconnect the chassis front panel cables to the motherboard. This unique module eliminates the trouble of connecting the system panel cables one at a time and avoiding wrong cable connections.

ASUS Q-Fan 2 technology



The ASUS Q-Fan technology smartly adjusts the CPU and chassis fan speeds according to the system loading to ensure quiet, cool, and efficient operation. See page 4-35 for details.

ASUS MyLogo2™



This new feature present in the motherboard allows you to personalize and add style to your system with customizable boot logos.

This chapter lists the hardware setup procedures that you have to perform when installing system components. It includes description of the jumpers and connectors on the motherboard.

Hardware ² information

Chapter summary

2.1	Before you proceed	2-1
2.2	Motherboard overview	2-2
2.3	Central Processing Unit (CPU)	2-5
2.4	System memory.....	2-10
2.5	Expansion slots	2-16
2.6	Jumpers	2-19
2.7	Connectors	2-22

2.1 Before you proceed

Take note of the following precautions before you install motherboard components or change any motherboard settings.



- Make sure that your power supply unit (PSU) can provide at least the minimum power required by your system. See “8. ATX power connectors” on page 2-26 for details.
- Unplug the power cord from the wall socket before touching any component.
- Use a grounded wrist strap or touch a safely grounded object or to a metal object, such as the power supply case, before handling components to avoid damaging them due to static electricity
- Hold components by the edges to avoid touching the ICs on them.
- Whenever you uninstall any component, place it on a grounded antistatic pad or in the bag that came with the component.
- Before you install or remove any component, ensure that the ATX power supply is switched off or the power cord is detached from the power supply. Failure to do so may cause severe damage to the motherboard, peripherals, and/or components.

Onboard LED

The motherboard comes with a standby power LED that lights up to indicate that the system is ON, in sleep mode, or in soft-off mode. This is a reminder that you should shut down the system and unplug the power cable before removing or plugging in any motherboard component. The illustration below shows the location of the onboard LED.

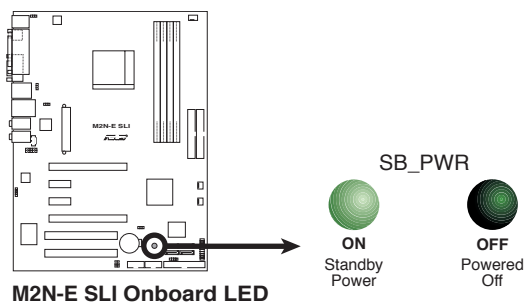

2.2 Motherboard overview

Before you install the motherboard, study the configuration of your chassis to ensure that the motherboard fits into it.



Make sure to unplug the power cord before installing or removing the motherboard. Failure to do so can cause you physical injury and damage motherboard components.

2.2.1 Placement direction

When installing the motherboard, make sure that you place it into the chassis in the correct orientation. The edge with external ports goes to the rear part of the chassis as indicated in the image below.

2.2.2 Screw holes

Place six (6) screws into the holes indicated by circles to secure the motherboard to the chassis.



Do not overtighten the screws! Doing so can damage the motherboard.

Place this side towards the rear of the chassis

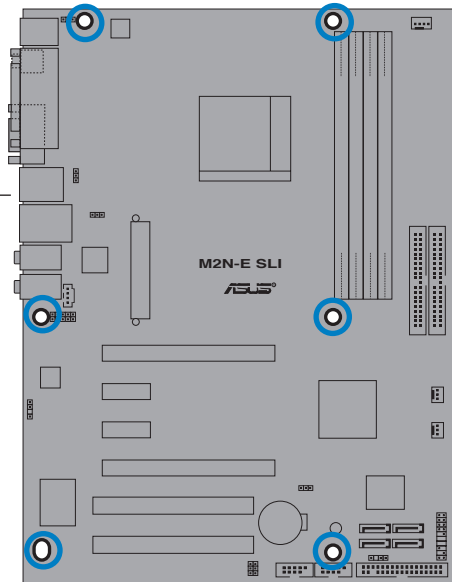

2.2.3 Motherboard layout

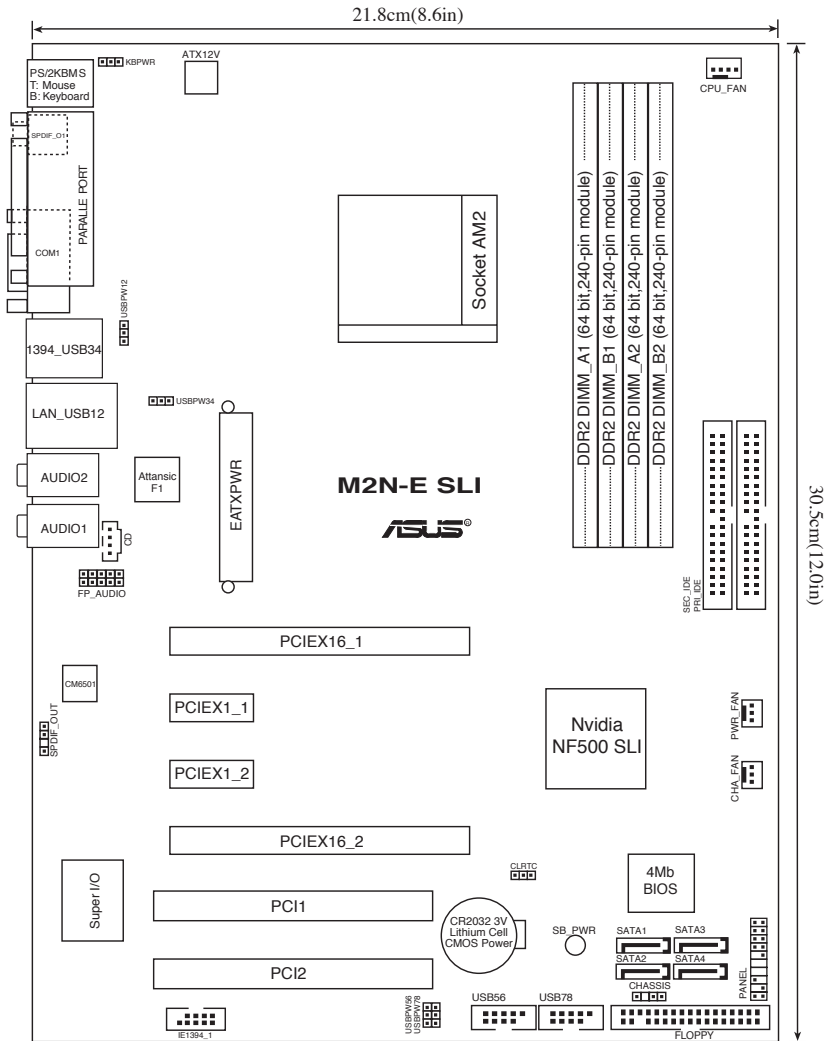

2.2.4 Layout Contents

Slots	Page
1. DDR2 DIMM slots	2-10
2. PCI slots	2-17
3. PCI Express x16 slot	2-18
4. PCI Express x1 slot	2-18

Slots	Page
1. CLRTC (3-pin CLRTC1)	2-19
2. USB device wake-up (3-pin USBPW12, USBPW34, USBPW56, USBPW78, USBPW910)	2-20
3. Keyboard Power (3-pin KBPWR)	2-21

Rear panel connectors	Page
1. PS/2 mouse port (green)	2-22
2. Parallel port	2-22
3. Serial (COM) port	2-22
4. IEEE 1394a port	2-22
5. LAN (RJ-45) port	2-22
6. Line In port (light blue)	2-22
7. Microphone port (pink)	2-22
8. Line Out port (lime)	2-22
9. USB 2.0 ports 3 and 4	2-23
10. USB 2.0 ports 1 and 2	2-23
11. Coaxial S/PDIF out port	2-23
12. PS/2 keyboard port (purple)	2-23

Internal connectors	Page
1. Floppy disk drive connector (34-1 pin FLOPPY)	2-23
2. Primary/Secondary IDE connector (40-1 pin PRI_IDE, SEC_IDE)	2-24
3. nForce 500 SLI Serial ATA connectors (7-pin SATA1, SATA2, SATA3, SATA4)	2-25
4. CPU fan connector (3-pin CPU_FAN)	2-26
5. Power fan connector (3-pin PWR_FAN)	2-26
6. Chassis fan connector (3-pin CHA_FAN)	2-26
7. USB headers (10-1 USB56, USB78)	2-27
8. IEEE 1394a port connector (10-1 pin IE1394_1)	2-27
9. ATX power connector (24-pin EATXPWR1)	2-28
10. ATX 12V power connector (4-pin ATX12V1)	2-28
11. Internal audio connectors (4-pin CD/AUX)	2-29
12. Front panel audio connector (10-1 pin FP_AUDIO)	2-29
13. System panel connector (20-8 pin PANEL)	2-30
• System power LED (2-pin LED)	
• Hard disk drive activity LED (2-pin IDE_LED)	
• System warning speaker (4-pin SPEAKER)	
• ATX power button/soft-off button (2-pin PWR)	
• Reset button (2-pin RESET)	

2.3 Central Processing Unit (CPU)

The motherboard comes with a 940-pin AM2 socket designed for the AMD Athlon™ 64 X2/AMD Athlon™ 64 FX/AMD Athlon™ 64 and AMD Sempron™ processors.



Make sure you use a CPU is designed for the AM2 socket. The CPU fits in only one correct orientation. DO NOT force the CPU into the socket to prevent bending the connectors on the socket and damaging the CPU!

2.3.1 Installing the CPU

To install a CPU:

1. Locate the CPU socket on the motherboard.

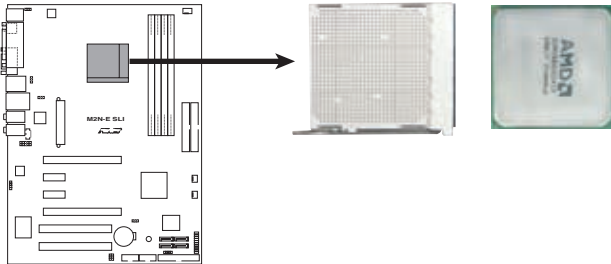

M2N-E SLI CPU Socket M2

2. Unlock the socket by pressing the lever sideways, then lift it up to a 90° angle.

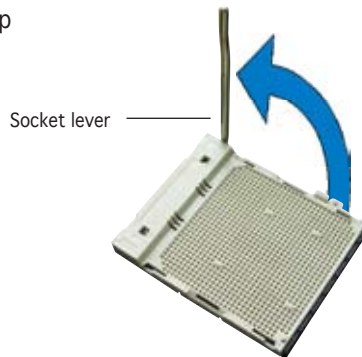

Make sure that the socket lever is lifted up to a 90° angle; otherwise, the CPU will not fit in completely.

3. Position the CPU above the socket such that the CPU corner with the gold triangle matches the socket corner with a small triangle.

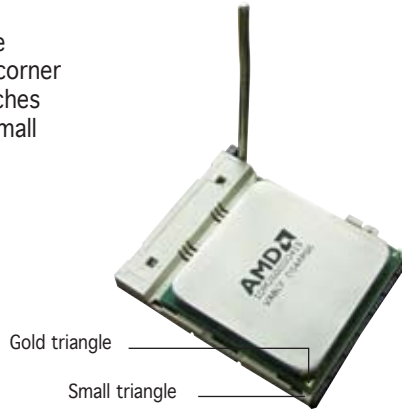

5. When the CPU is in place, push down the socket lever to secure the CPU. The lever clicks on the side tab to indicate that it is locked.
6. Install a CPU heatsink and fan following the instructions that came with the heatsink package.



2.3.2 Installing the heatsink and fan

The the AMD Athlon™ FX, AMD Athlon 64™, AMD Sempron™ or AMD Athlon™ X2 processor require a specially designed heatsink and fan assembly to ensure optimum thermal condition and performance.



Make sure that you use only qualified heatsink and fan assembly.

Follow these steps to install the CPU heatsink and fan.

1. Place the heatsink on top of the installed CPU, making sure that the heatsink fits properly on the retention module base.



- The retention module base is already installed on the motherboard upon purchase.
 - You do not have to remove the retention module base when installing the CPU or installing other motherboard components.
 - If you purchased a separate CPU heatsink and fan assembly, make sure that a Thermal Interface Material is properly applied to the CPU heatsink or CPU before you install the heatsink and fan assembly.
-

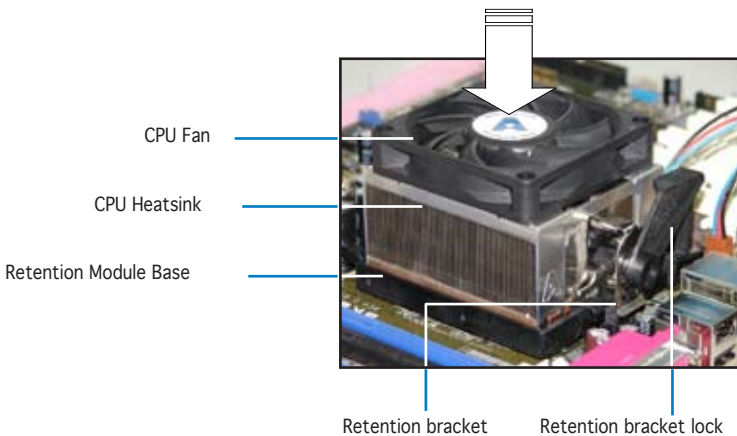

Your boxed CPU heatsink and fan assembly should come with installation instructions for the CPU, heatsink, and the retention mechanism. If the instructions in this section do not match the CPU documentation, follow the latter.

2. Attach one end of the retention bracket to the retention module base.

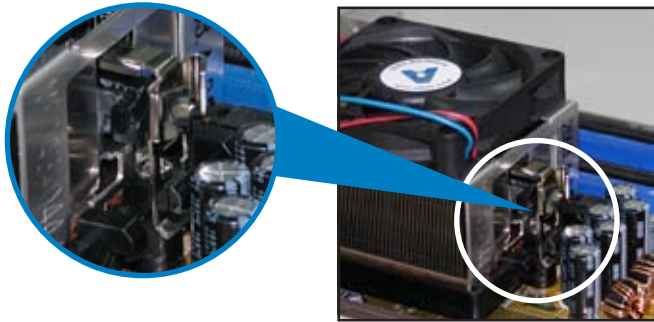

3. Align the other end of the retention bracket (near the retention bracket lock) to the retention module base. A clicking sound denotes that the retention bracket is in place.



Make sure that the fan and heatsink assembly perfectly fits the retention mechanism module base, otherwise you cannot snap the retention bracket in place.



4. Push down the retention bracket lock on the retention mechanism to secure the heatsink and fan to the module base.

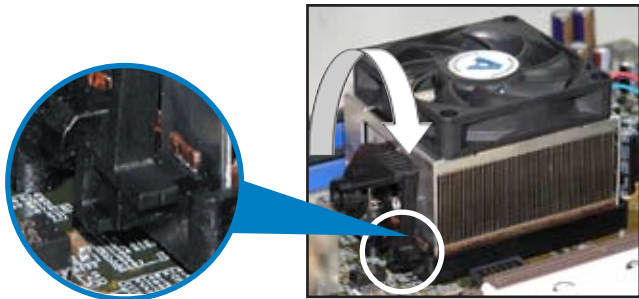

- When the fan and heatsink assembly is in place, connect the CPU fan cable to the connector on the motherboard labeled CPU_FAN.

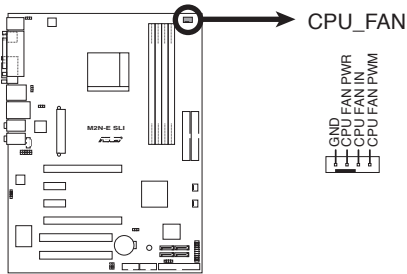

M2N-E SLI CPU Fan Connector



Do not forget to connect the CPU fan connector! Hardware monitoring errors can occur if you fail to plug this connector.

2.4 System memory

2.4.1 Overview

The motherboard comes with four Double Data Rate 2 (DDR2) Dual Inline Memory Modules (DIMM) sockets.

A DDR2 module has the same physical dimensions as a DDR DIMM but has a 240-pin footprint compared to the 184-pin DDR DIMM. DDR2 DIMMs are notched differently to prevent installation on a DDR DIMM socket.

The figure illustrates the location of the DDR2 DIMM sockets:

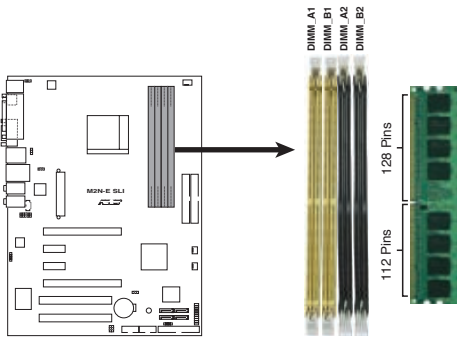

M2N-E SLI 240-pin DDR2 DIMM Sockets

Channel	Sockets
Channel A	DIMM_A1 and DIMM_A2
Channel B	DIMM_B1 and DIMM_B2

2.4.2 Memory configurations

You may install 256 MB, 512 MB, 1 GB, and 2GB unbuffered ECC/non-ECC DDR2 DIMMs into the DIMM sockets.

Recommended Memory Configurations

Mode	Sockets			
	DIMM_A1	DIMM_A2	DIMM_B1	DIMM_B2
Single Channel	Populated	-	-	-
	-	Populated	-	-
	-	-	Populated	-
	-	-	-	Populated
Dual-channel (1)	Populated	-	Populated	-
	-	Populated	-	Populated
Dual-channel (2)	Populated	Populated	Populated	Populated

-
- * For dual-channel memory configuration (2), you may:
 - install identical DIMMs in all four sockets OR
 - install an identical DIMM pair in DIMM_A1 and DIMM_B1 (yellow sockets) and another identical DIMM pair in DIMM_A2 and DIMM_B2 (black sockets)
 - * Always use identical DDR2 DIMM pairs for dual-channel model. For optimum compatibility, we recommend that you obtain memory modules from the same vendor. Visit the ASUS website (www.asus.com) for the latest Qualified Vendors List.
-



Important notice on installing Windows® XP 32-bit version

If you install Windows® XP 32-bit version Operating System (OS), the limitation of this OS version is that it may reserve a certain amount of memory space for system devices. We recommend that you install less than 3 GB system memory if you would like to work under Windows® XP 32-bit version OS. The excess memory installation will not cause any usage problem, but it will not give users the benefit of manipulating this excess memory space.

Visit the ASUS FAQ site for further explanation:

<http://support.asus.com/faq/faq.aspx?SLanguage=en-us>

Under General Search, make the selections as shown, then click Search. Click the article titled “4GB memory installed but less memory size detected.”



This motherboard can support 8 GB physical memory on the operating systems listed below. You may install a maximum of 2 GB DIMMs on each slot.

32-bit	64-bit
Windows® 2000 Advanced Server	Windows® Server 2003 Standard x64 Edition
Windows® Server 2003 Enterprise Edition	Windows® XP Professional x64 Edition
	Windows® Server 2003 Enterprise x64 Edition

Qualified Vendors List DDR2-800

DDR2 Size	Vendor	Model	Side(s)	Component	DIMM socket support		
					A*	B*	C*
512MB	KINGSTON	K4T51083QC	SS	KVR800D2N5/512	V	V	V
1024MB	KINGSTON	K4T51083QC	DS	KVR800D2N5/1G	V	V	V
1024MB	KINGSTON	Heat-Sink Package	DS	KHX6400D2LL/1G	V	V	V
1024MB	KINGSTON	Heat-Sink Package	SS	KHX6400D2LLK2/1GN	V	V	V
2048MB	KINGSTON	Heat-Sink Package	DS	KHX6400D2K2/2G	V	V	V
512MB	Qimonda	HYB18T256800AF25F	DS	HYS64T64020HU-25F-A	V	V	V
256MB	Qimonda	HYB18T512160BF-25F	SS	HYS64T32000HU-25F-B	V	V	V
512MB	Qimonda	HYB18T512800BF25F	SS	HYS64T64000HU-25F-B	V	V	V
1024MB	Qimonda	HYB18T512800BF25F	DS	HYS64T128020HU-25F-B	V	V	V
512MB	SAMSUNG	EDD339XX	SS	M378T6553CZ3-CE7	V	V	V
256MB	SAMSUNG	K4T51163QC-ZCE7	SS	M378T3354CZ3-CE7	V	V	V
512MB	Hynix	HY5PS12821BFP-S5	SS	HYMP564U64BP8-S5	V	V	V
1024MB	Hynix	HY5PS12821BFP-S5	DS	HYMP512U64BP8-S5	V	V	V
512MB	MICRON	5JAIIZ9DQQ	SS	MT8HTF6464AY-80EA3	V	V	V
1024MB	MICRON	5JAIIZ9DQQ	DS	MT16HTF12864AY-80EA3	V	V	V
512MB	MICRON	5ZD22D9GKX	SS	MT8HTF6464AY-80ED4	V	V	V
1024MB	MICRON	5ZD22D9GKX	DS	MT16HTF12864AY-80ED4	V	V	V
512MB	MICRON	6CD22D9GKX	SS	MT8HTF6464AY-80ED4	V	V	V
1024MB	MICRON	6CD22D9GKX	DS	MT16HTF12864AY-80ED4	V	V	V
1024MB	CORSAIR	Heat-Sink Package	DS	CM2X1024-6400C4	V	V	V
1024MB	ELPIDA	E1108AB-8E-E(ECC)	SS	EBE10EE8ABFA-8E-E	V	V	V
2048MB	ELPIDA	E1108AB-8E-E(ECC)	DS	EBE21EE8ABFA-8E-E	V	V	V
512MB	A-DATA	N/A	SS	M20AD6G3H3160J1E52	V	V	V
512MB	A-DATA	AD29608A8A-25EG	SS	M20AD6G3H3160I1E5E	V	V	V
512MB	Crucial	Heat-Sink Package	SS	BL6464AA804.8FD	V	V	V
1024MB	Crucial	Heat-Sink Package	DS	BL12864AA804.16FD	V	V	V
1024MB	Apacer	Heat-Sink Package	DS	AHU01GE800C5K1C	V	V	V

Qualified Vendors List DDR2-667

DDR2 Size	Vendor	Model	Side(s)	Component	DIMM socket support		
					A*	B*	C*
512MB	KINGSTON	E5108AE-6E-E	SS	KVR667D2N5/512	√	√	√
1024MB	KINGSTON	E5108AE-6E-E	DS	KVR667D2N5/1G	√	√	√
512MB	KINGSTON	E5108AE-6E-E	SS	KVR667D2E5/512	√	√	√
256MB	KINGSTON	HYB18T256800AF3	SS	KVR667D2N5/256	√	√	√
512MB	KINGSTON	D6408TEBGL3U	SS	KVR667D2N5/512	√	√	√
1024MB	KINGSTON	D6408TEBGL3U	DS	KVR667D2N5/1G	√	√	√
256MB	KINGSTON	HYB18T256800AF3S	SS	KVR667D2N5/256	√	√	√
256MB	Qimonda	HYB18T512160AF-3S	SS	HYS64T32000HU-3S-A	√	√	√
512MB	Qimonda	HYB18T512800AF3S	SS	HYS64T64000HU-3S-A	√	√	√
1024MB	Qimonda	HYB18T512800AF3S	DS	HYS64T128020HU-3S-A	√	√	√
256MB	Qimonda	HYB18T256800AF3S(ECC)	SS	HYS72T32000HU-3S-A	√	√	√
512MB	Qimonda	HYB18T512800AF3S(ECC)	SS	HYS72T64000HU-3S-A	√	√	√
1024MB	Qimonda	HYB18T512800AF3S(ECC)	DS	HYS72T128020HU-3S-A	√	√	√
512MB	Qimonda	HYB18T512800BF3S(ECC)	SS	HYS72T64000HU-3S-B	√	√	√
1024MB	Qimonda	HYB18T512800BF3S(ECC)	DS	HYS72T128020HU-3S-B	√	√	√
256MB	Qimonda	HYB18T512160BF-3S	SS	HYS64T32000HU-3S-B	√	√	√
512MB	Qimonda	HYB18T512800BF3S	SS	HYS64T64000HU-3S-B	√	√	√
1024MB	Qimonda	HYB18T512800BF3S	DS	HYS64T128020HU-3S-B	√	√	√
256MB	SAMSUNG	K4T51163QC-ZCE6	SS	M378T3354CZ0-CE6	√	√	√
512MB	SAMSUNG	ZCE6K4T51083QC	SS	M378T6553CZ0-CE6	√	√	√
1024MB	SAMSUNG	ZCE6K4T51083QC	DS	M378T2953CZ0-CE6	√	√	√
512MB	Hynix	HY5PS12821AFP-Y5	SS	HYMP564U64AP8-Y5	√	√	√
1024MB	Hynix	HY5PS1G831FP-Y5(ECC)	SS	HYMP112U72P8-Y5	√	√	√
512MB	Hynix	HY5PS12821AFP-Y5(ECC)	SS	HYMP564U72AP8-Y5	√	√	√
1024MB	Hynix	HY5PS12821AFP-Y5(ECC)	DS	HYMP512U72AP8-Y5	√	√	√
512MB	Hynix	HY5PS12821AFP-Y4	SS	HYMP564U64AP8-Y4	√	√	√
512MB	Hynix	HY5PS12821AFP-Y4(ECC)	SS	HYMP564U72AP8-Y4	√	√	√
512MB	CORSAIR	64M8CFEG	SS	V5S12MB667D2	√	√	√
1024MB	CORSAIR	64M8CFEG	SS	VS1GB667D2	√	√	√
256MB	ELPIDA	E2508AB-6E-E	SS	EBE25UC8ABFA-6E-E	√	√	√
512MB	ELPIDA	E5108AE-6E-E	SS	EBE51UD8AEFA-6E-E	√	√	√
512MB	A-DATA	AD29608A8A-3EG	SS	M20AD5G3H316611C52	√	√	√
1024MB	A-DATA	AD29608A8A-3EG	DS	M20AD5G3I417611C52	√	√	√
1024MB	crucial	Heat-Sink Package	DS	BL12864AA663.16FD	√	√	√
1024MB	crucial	Heat-Sink Package	DS	BL12864AL664.16FD	√	√	√
1024MB	Apacer	E5108AE-6E-E	DS	78.01092.420	√	√	√
512MB	Apacer	AM4B5708GQJS7E	SS	AU512E667C5KBGC	√	√	√
1024MB	Apacer	AM4B5708GQJS7E	DS	AU01GE667C5KBGC	√	√	√
512MB	Apacer	AM4B5708GQJS7E	SS	AU512E667C5KBGC	√	√	√
1024MB	Apacer	N/A	DS	AU01GE667C5KBGC	√	√	√
512MB	Kingmax	KKEA88B4LAUG-29DX	SS	KLCC28F-A8KB5	√	√	√
1024MB	Kingmax	KKEA88B4LAUG-29DX	DS	KLCD48F-A8KB5	√	√	√

Qualified Vendors List DDR2-667

DDR2 Size	Vendor	Model	Side(s)	Component	DIMM socket support		
					A*	B*	C*
512MB	Transcend	E5108AE-6E-E	SS	TS64MLQ64V6J	V	V	V
1024MB	Transcend	E5108AE-6E-E	DS	TS128MLQ64V6J	V	V	V
512MB	Transcend	J12Q3AB-6	SS	JM367Q643A-6	V	V	V
1024MB	Transcend	J12Q3AB-6	DS	JM388Q643A-6	V	V	V

Qualified Vendors List DDR2-533

DDR2 Size	Vendor	Model	Side(s)	Component	DIMM socket support		
					A*	B*	C*
256MB	KINGSTON	E5116AF-5C-E	SS	KVR533D2N4/256	V	V	V
512MB	KINGSTON	HYB18T512800AF37	SS	KVR533D2N4/512	V	V	V
1024MB	KINGSTON	5YDIID9GCT	DS	KVR533D2N4/1G	V	V	V
256MB	Qimonda	HYB18T512160AF-3.7	SS	HYS64T32000HU-3.7-A	V	V	V
512MB	Qimonda	HYB18T512800AF37	SS	HYS64T64000HU-3.7-A	V	V	V
1024MB	Qimonda	HYB18T512800AF37	DS	HYS64T128020HU-3.7-A	V	V	V
256MB	Qimonda	HYB18T5121608BF-3.7	SS	HYS64T32000HU-3.7-B	V	V	V
512MB	Qimonda	HYB18T512800BF37	SS	HYS64T64000HU-3.7-B	V	V	V
256MB	Qimonda	HYB18T256800AF37(ECC)	SS	HYS72T32000HU-3.7-A	V	V	V
1024MB	Qimonda	HYB18T512800AF37(ECC)	DS	HYS72T128020HU-3.7-A	V	V	V
512MB	Hynix	HY5PS12821F-C4	SS	HYMP564U648-C4	V	V	V
1024MB	Hynix	HY5PS12821F-C4	DS	HYMP512U648-C4	V	V	V
1024MB	Hynix	HY5PS12821F-C4(ECC)	DS	HYMP512U728-C4	V	V	V
512MB	Hynix	HY5PS12821FP-C4(ECC)	SS	HYMP564U728-C4	V	V	V
512MB	Hynix	HY5PS12821AFP-C3	SS	HYMP564U64AP8-C3	V	V	V
1024MB	Hynix	HY5PS12821AFP-C3	DS	HYMP512U64AP8-C3	V	V	V
512MB	ELPIDA	E5108AB-5C-E(ECC)	SS	EBE51ED8ABFA-5C-E	V	V	V
512MB	ELPIDA	E5108AB-5C-E	SS	EBE51UD8ABFA-5C-E	V	V	V
512MB	KINGMAX	E5108AE-5C-E	SS	KLBC28F-A8EB4	V	V	V
512MB	KINGMAX	KKEA88E4AAK-37	SS	KLBC28F-A8KE4	V	V	V
1024MB	KINGMAX	5MB22D9DCN	DS	KLBD48F-A8ME4	V	V	V

Side(s): SS - Single-sided DS - Double-sided

DIMM Support:

- A - Supports one module inserted in any slot for a single-channel memory configuration.
- B - Supports one pair of modules inserted into either the yellow slots or the black slots as one pair of dual-channel memory configuration.
- C - Supports three modules inserted into both the yellow and black slots as two pairs of dual-channel memory configuration.



Visit the ASUS website (www.asus.com) for the latest memory Qualified Vendor List (QVL).

2.4.3 Installing a DIMM



Unplug the power supply before adding or removing DIMMs or other system components. Failure to do so can cause severe damage to both the motherboard and the components.

To install a DIMM:

1. Unlock a DIMM socket by pressing the retaining clips outward.
2. Align a DIMM on the socket such that the notch on the DIMM matches the break on the socket.
3. Firmly insert the DIMM into the socket until the retaining clips snap back in place and the DIMM is properly seated.

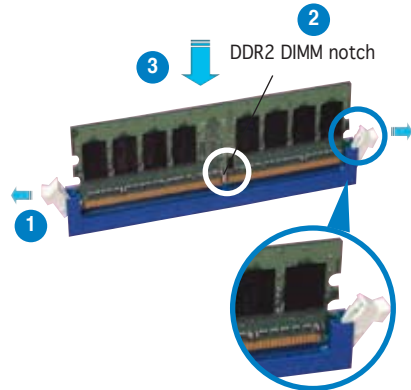

Unlocked retaining clip



- A DDR2 DIMM is keyed with a notch so that it fits in only one direction. Do not force a DIMM into a socket to avoid damaging the DIMM.
- The DDR2 DIMM sockets do not support DDR DIMMs. DO not install DDR DIMMs to the DDR2 DIMM sockets.

2.4.4 Removing a DIMM

To remove a DIMM:

1. Simultaneously press the retaining clips outward to unlock the DIMM.



Support the DIMM lightly with your fingers when pressing the retaining clips. The DIMM might get damaged when it flips out with extra force.

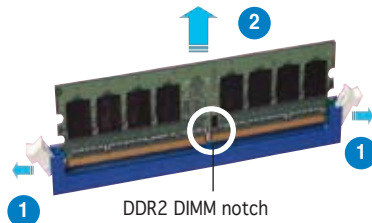

2. Remove the DIMM from the socket.

2.5 Expansion slots

In the future, you may need to install expansion cards. The following sub-sections describe the slots and the expansion cards that they support.



Make sure to unplug the power cord before adding or removing expansion cards. Failure to do so may cause you physical injury and damage motherboard components.

2.5.1 Installing an expansion card

To install an expansion card:

1. Before installing the expansion card, read the documentation that came with it and make the necessary hardware settings for the card.
2. Remove the system unit cover (if your motherboard is already installed in a chassis).
3. Remove the bracket opposite the slot that you intend to use. Keep the screw for later use.
4. Align the card connector with the slot and press firmly until the card is completely seated on the slot.
5. Secure the card to the chassis with the screw you removed earlier.
6. Replace the system cover.

2.5.2 Configuring an expansion card

After installing the expansion card, configure the it by adjusting the software settings.

1. Turn on the system and change the necessary BIOS settings, if any. See Chapter 4 for information on BIOS setup.
2. Assign an IRQ to the card. Refer to the tables on the next page.
3. Install the software drivers for the expansion card.



When using PCI cards on shared slots, ensure that the drivers support “Share IRQ” or that the cards do not need IRQ assignments; otherwise, conflicts will arise between the two PCI groups, making the system unstable and the card inoperable.

2.5.3 Interrupt assignments

Standard interrupt assignments

IRQ	Priority	Standard function
0	1	System Timer
1	2	Keyboard Controller
2	–	Redirect to IRQ#9
4	12	Communications Port (COM1)*
5	13	IRQ Holder for PCI Steering*
6	14	Floppy Disk Controller
7	15	Printer Port (LPT1)*
8	3	System CMOS/Real Time Clock
9	4	IRQ Holder for PCI Steering*
10	5	IRQ Holder for PCI Steering*
11	6	IRQ Holder for PCI Steering*
12	7	PS/2 Compatible Mouse Port*
13	8	Numeric Data Processor
14	9	Primary IDE Channel

* These IRQs are usually available for ISA or PCI devices.

IRQ assignments for this motherboard

	A	B	C	D	E	F	G	H
PCI Slot 1		shared						
PCI Slot 2			shared					
On board 1394	shared							
PCIe x16 slot 1	shared							
PCIe x16 slot 2						shared		
PCIe x1 slot 1							shared	
PCIe x1 slot 2					shared			

2.5.4 PCI slots

The PCI slots support cards such as a LAN card, SCSI card, USB card, and other cards that comply with PCI specifications. Refer to the figure below for the location of the slots.

2.5.5 PCI Express x1 slot

This motherboard supports PCI Express x1 network cards, SCSI cards and other cards that comply with the PCI Express specifications. Refer to the figure below for the location of the slot.

2.5.6 PCI Express x16 slots

This motherboard supports PCI Express x16 graphics cards that comply with the PCI Express specifications. Refer to the figure below for the location of the slots.

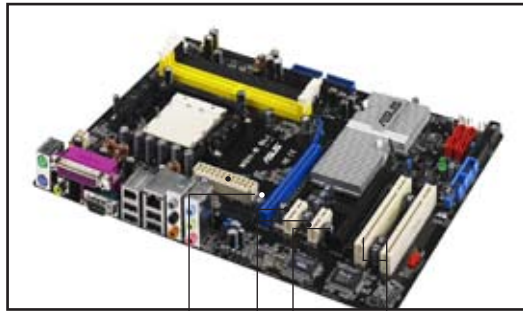

PCI Express x16 blue slot (at x16 speed) PCI slots
 PCI Express x1 slot PCI Express x 16 black slot (at x8 speed)



- In single card mode, we recommend that you use the blue PCI Express x16 (PCIEX16_1) slot.
- Due to chipset limitation, the black PCI Express x16 (PCIEX16_2) slot can only operate at x8 speed.
- Connect a rear chassis fan to the chassis (CHA_FAN) connector when using two graphics cards for better thermal environment. See page 2-28 for details.
- We recommend that you provide sufficient power when running NVIDIA® SLI™ mode. See pages 2-29 and 2-30 for details.

Recommended PCI Express x16 configurations

Mode	PCIEX16_1 (Blue) slot		PCIEX16_2 (Black) slot	
	Card type	Speed	Card type	Speed
Non-SLI mode	PCIe x16 graphics card	x16	NA	
	PCIe x16 graphics card	x8	PCIe x16 graphics card	x8
	PCIe x16 graphics card	x8	Other PCIe devices	x8, x4, x1
Dual graphics card in SLI Mode	Two identical NVIDIA® SLI™ Edition graphics cards at x8, x8 speed			

2.6 Jumpers

1. Clear RTC RAM (CLRTC)

This jumper allows you to clear the Real Time Clock (RTC) RAM in CMOS. You can clear the CMOS memory of date, time, and system setup parameters by erasing the CMOS RTC RAM data. The onboard button cell battery powers the RAM data in CMOS, which include system setup information such as system passwords.

To erase the RTC RAM:

1. Turn OFF the computer and unplug the power cord.
2. Remove the onboard battery.
3. Move the jumper cap from pins 1-2 (default) to pins 2-3. Keep the cap on pins 2-3 for about 5~10 seconds, then move the cap back to pins 1-2.
4. Re-install the battery.
5. Plug the power cord and turn ON the computer.
6. Hold down the key during the boot process and enter BIOS setup to re-enter data.



Except when clearing the RTC RAM, never remove the cap on CLRTC jumper default position. Removing the cap will cause system boot failure!

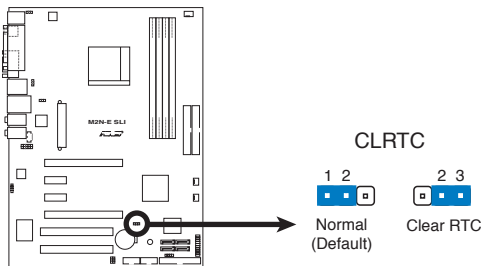

M2N-E SLI Clear RTC RAM



You do not need to clear the RTC when the system hangs due to overclocking. For system failure due to overclocking, use the C.P.R. (CPU Parameter Recall) feature. Shut down and reboot the system so the BIOS can automatically reset parameter settings to default values.

2. USB device wake-up (3-pin USBPW12, USBPW34, USBPW56, USBPW78)

Set these jumpers to +5V to wake up the computer from S1 sleep mode (CPU stopped, DRAM refreshed, system running in low power mode) using the connected USB devices. Set to +5VSB to wake up from S3 and S4 sleep modes (no power to CPU, DRAM in slow refresh, power supply in reduced power mode).

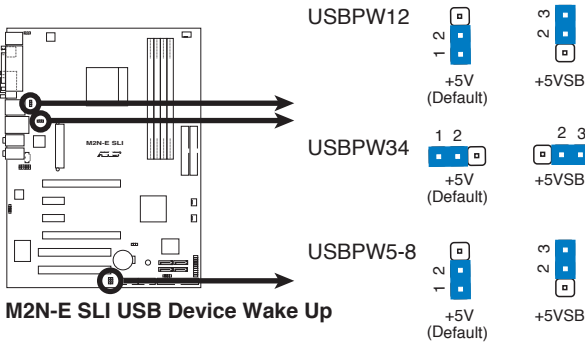

- The USB device wake-up feature requires a power supply that can provide 500mA on the +5VSB lead for each USB port; otherwise, the system would not power up.
- The total current consumed must NOT exceed the power supply capability (+5VSB) whether under normal condition or in sleep mode.

3. Keyboard power (3-pin KBPWR)

This jumper allows you to enable or disable the keyboard wake-up feature. Set this jumper to pins 2-3 (+5VSB) if you wish to wake up the computer when you press a key on the keyboard (the default value is [Disabled]). This feature requires an ATX power supply that can supply at least 1A on the +5VSB lead, and a corresponding setting in the BIOS (see section 2.5.5 APM Configuration).

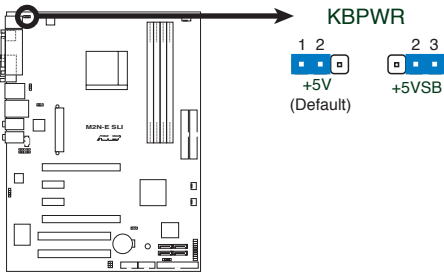

M2N-E SLI Keyboard Power Setting

2.7 Connectors

2.7.1 Rear panel connectors

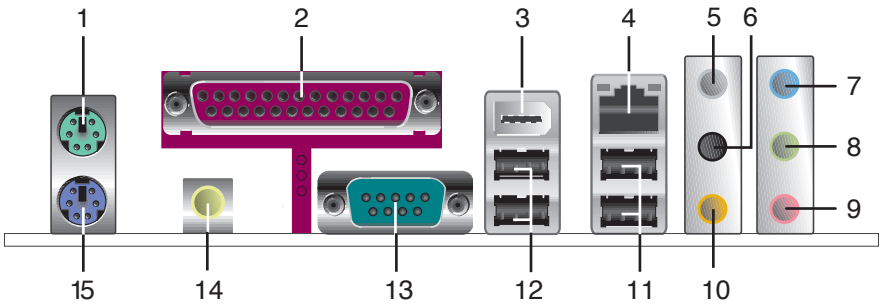

1. **PS/2 mouse port (green).** This port is for a PS/2 mouse.
2. **Parallel port.** This 25-pin port connects a parallel printer, a scanner, or other devices.
3. **IEEE 1394a port.** This 6-pin IEEE 1394a port provides high-speed connectivity for audio/video devices, storage peripherals, PCs, or portable devices.
4. **LAN (RJ-45) port.** Supported by the NVIDIA® nForce™ 500 Gigabit MAC with external Attansic PHY, this port allows Gigabit connection to a Local Area Network (LAN) through a network hub. Refer to the table below for the LAN port LED indications.

LAN port LED indications

ACT/LINK LED		SPEED LED	
Status	Description	Status	Description
OFF	No link	OFF	10 Mbps connection
GREEN	Linked	ORANGE	100 Mbps connection
BLINKING	Data activity	GREEN	1 Gbps connection

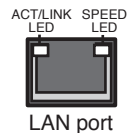

5. **Side Speaker Out port (gray).** This port connects the side speakers in an 8-channel audio configuration.
6. **Rear Speaker Out port (black).** This port connects the rear speakers in a 4-channel, 6-channel, or 8-channel audio configuration.

7. **Line In port (light blue).** This port connects the tape, CD, DVD player, or other audio sources.
8. **Line Out port (lime).** This port connects a headphone or a speaker. In 4-channel, 6-channel, and 8-channel configuration, the function of this port becomes Front Speaker Out.
9. **Microphone port (pink).** This port connects a microphone.



Refer to the audio configuration table below for the function of the audio ports in 2, 4, 6 or 8-channel configuration.

10. **Center/Subwoofer port (orange).** This port connects the center/subwoofer speakers.

Audio 2, 4, 6, or 8-channel configuration

Port	Headset 2-channel	4-channel	6-channel	8-channel
Light Blue	Line In	Line In	Line In	Line In
Lime	Line Out	Front Speaker Out	Front Speaker Out	Front Speaker Out
Pink	Mic In	Mic In	Mic In	Mic In
Orange	–	–	Center/Subwoofer	Center/Subwoofer
Black	–	Rear Speaker Out	Rear Speaker Out	Rear Speaker Out
Gray	–	–	–	Side Speaker Out

11. **USB 2.0 ports 3 and 4.** These two 4-pin Universal Serial Bus (USB) ports are available for connecting USB 2.0 devices.
12. **USB 2.0 ports 1 and 2.** These two 4-pin Universal Serial Bus (USB) ports are available for connecting USB 2.0 devices.
13. **Serial port (COM port).** This 9-pin COM port is for pointing devices and other serial devices.
14. **Coaxial S/PDIF Out port.** This port connects an external audio output device via a coaxial S/PDIF cable.
15. **PS/2 keyboard port (purple).** This port is for a PS/2 keyboard.

2.7.2 Internal connectors

1. Floppy disk drive connector (34-1 pin FLOPPY)

This connector is for the provided floppy disk drive (FDD) signal cable. Insert one end of the cable to this connector, then connect the other end to the signal connector at the back of the floppy disk drive.



The Pin 5 on the connector is removed to prevent incorrect cable connection when using an FDD cable with a covered Pin 5.

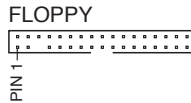
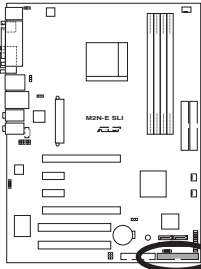

NOTE: Orient the red markings on the floppy ribbon cable to PIN 1.

M2N-E SLI Floppy Disk Drive Connector

2. IDE connector (40-1 pin PRI_IDE, SEC_IDE)

The onboard IDE connector is for the Ultra DMA 133/100/66 signal cable. There are three connectors on each Ultra DMA 133/100/66 signal cable: blue, black, and gray. Connect the blue connector to the motherboard's IDE connector, then select one of the following modes to configure your device.

	Drive jumper setting	Mode of device(s)	Cable connector
Single device	Cable-Select or Master	-	Black
Two devices	Cable-Select	Master	Black
		Slave	Gray
	Master	Master	Black or gray
	Slave	Slave	



- Pin 20 on the IDE connector is removed to match the covered hole on the Ultra DMA cable connector. This prevents incorrect insertion when you connect the IDE cable.
- Use the 80-conductor IDE cable for Ultra DMA 100/66 IDE devices.



If any device jumper is set as “Cable-Select,” make sure all other device jumpers have the same setting.

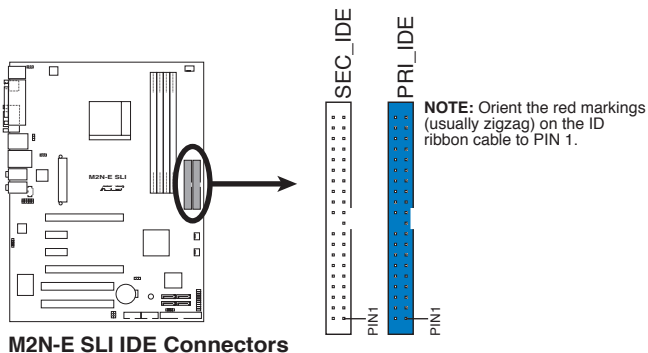

3. Serial ATA connectors (7-pin SATA1, SATA2, SATA3, SATA4)

These connectors are for the Serial ATA signal cables for Serial ATA 3.0 Gb/s hard disk and optical disk drives. The Serial ATA 3.0 Gb/s is backward compatible with Serial ATA 1.5 Gb/s specification.

If you installed Serial ATA hard disk drives, you can create a RAID 0, RAID 1, RAID 0+1, RAID 5, or JBOD configuration through the onboard NVIDIA® MediaShield™ controller.



The RAID function of these connectors is set to [Disabled] by default. If you intend to create a Serial ATA RAID set using these connectors, enable the RAID Enabled item in the SATA Configuration sub-menu in the BIOS. See section “4.4.7 Onboard Device Configuration” for details.

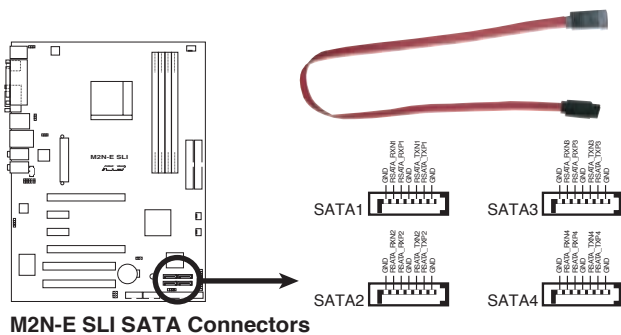

Connect the right-angle side of the SATA signal cable to the SATA device or you may connect the right-angle side of the SATA cable to the onboard SATA port to avoid placement conflict with huge graphics cards.

right angle side

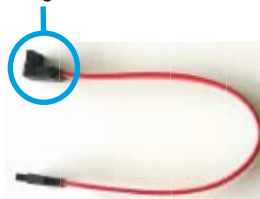

4. CPU, Chassis, and Power fan connectors
(3-pin CPU_FAN, 3-pin PWR_FAN, 3-pin CHA_FAN)

The fan connectors support cooling fans of 350mA~2000mA (24 W max.) or a total of 1A~3.48A (41.76 W max.) at +12V. Connect the fan cables to the fan connectors on the motherboard, making sure that the black wire of each cable matches the ground pin of the connector.



- Do not forget to connect the fan cables to the fan connectors. Lack of sufficient air flow inside the system may damage the motherboard components. These are not jumpers! DO NOT place jumper caps on the fan connectors!
- The ASUS Q-Fan function is supported using the CPU Fan (CPU_FAN) and Chassis Fan (CHA_FAN) connectors only.

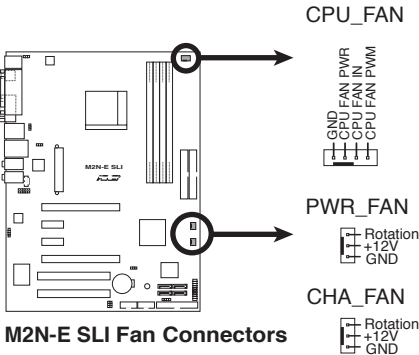

5. USB connectors (10-1 pin USB56, USB78)

These connectors are for USB 2.0 ports. Connect the USB module cable to any of these connectors, then install the module to a slot opening at the back of the system chassis. These USB connectors comply with USB 2.0 specification that supports up to 480 Mbps connection speed.

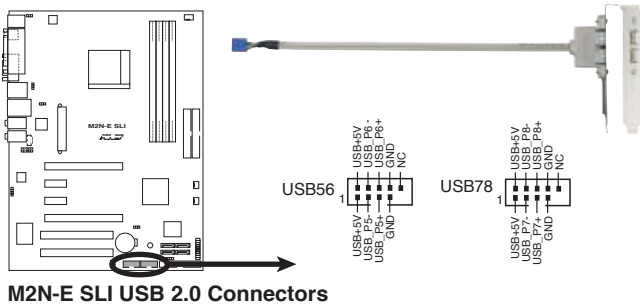

Never connect a 1394 cable to the USB connectors. Doing so will damage the motherboard!



The USB module is purchased separately.

5. IEEE 1394a port connector (10-1 pin IE1394_1)

This connector is for a IEEE 1394a port. Connect the IEEE 1394a module cable to this connector, then install the module to a slot opening at the back of the system chassis.

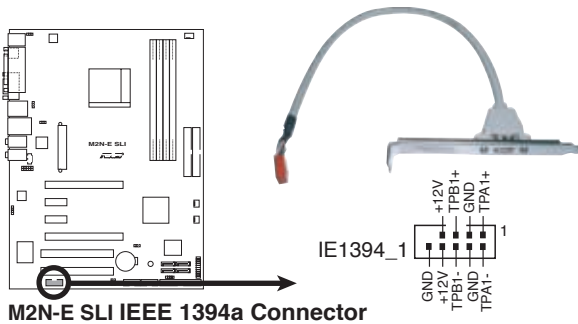

The IEEE 1394a module is purchased separately.

6. ATX power connectors (24-pin EATXPWR1,4-pin ATX12V)

These connectors are for an ATX power supply plugs. The power supply plugs are designed to fit these connectors in only one orientation. Find the proper orientation and push down firmly until the connectors completely fit.



- Do not forget to connect the 4-pin ATX +12 V power plug; otherwise, the system will not boot.
- Use of a PSU with a higher power output is recommended when configuring a system with more power-consuming devices. The system may become unstable or may not boot up if the power is inadequate.
- Make sure that your power supply unit (PSU) can provide at least the minimum power required by your system. See the table below for details.

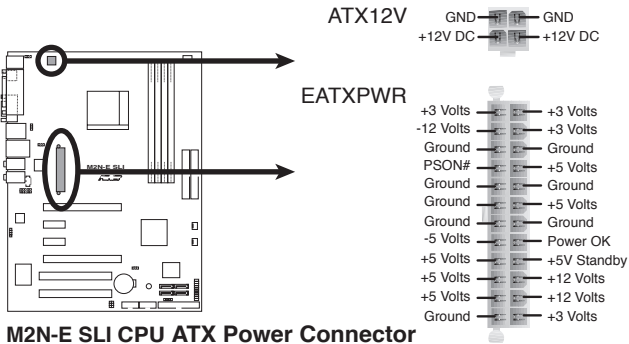

7. Internal audio connectors (4-pin CD)

These connectors allow you to receive stereo audio input from sound sources such as a CD-ROM, TV-tuner, or MPEG card.

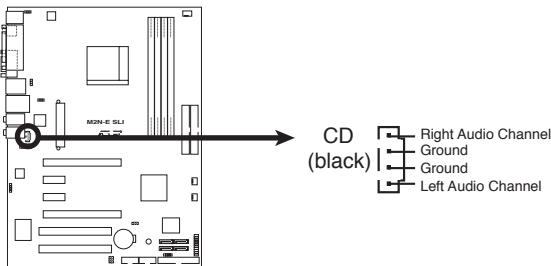

8. Front panel audio connector (10-1 pin FP_AUDIO)

This connector is for a chassis-mounted front panel audio I/O module that supports either HD or legacy AC '97 audio standard. Connect one end of the front panel audio I/O module cable to this connector.

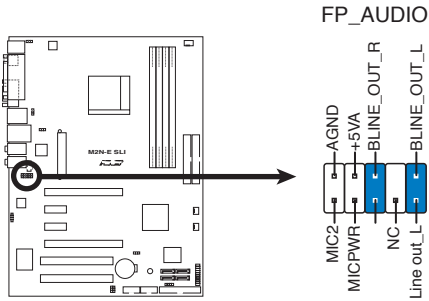

M2N-E SLI Front panel audio connector

9. Digital audio connector (4-1 pin SPDIF)

This connector is for an additional Sony/Philips Digital Interface (S/PDIF) port(s). Connect the S/PDIF Out module cable to this connector, then install the module to a slot opening at the back of the system chassis.

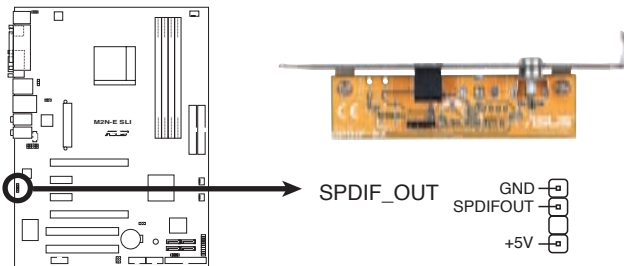

M2N-E SLI Digital Audio Connector



The S/PDIF module is purchased separately.

10. System panel connector (20-pin PANEL)

This connector supports several chassis-mounted functions.

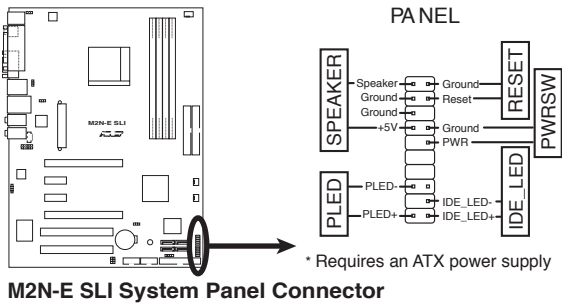

- **System power LED (2-pin PLED)**
This 2-pin connector is for the system power LED. Connect the chassis power LED cable to this connector. The system power LED lights up when you turn on the system power, and blinks when the system is in sleep mode.
- **Hard disk drive activity LED (2-pin IDE_LED)**
This 2-pin connector is for the HDD Activity LED. Connect the HDD Activity LED cable to this connector. The IDE LED lights up or flashes when data is read from or written to the HDD.
- **System warning speaker (4-pin SPEAKER)**
This 4-pin connector is for the chassis-mounted system warning speaker. The speaker allows you to hear system beeps and warnings.
- **ATX power button/soft-off button (2-pin PWRSW)**
This connector is for the system power button. Pressing the power button turns the system on or puts the system in sleep or soft-off mode depending on the BIOS settings. Pressing the power switch for more than four seconds while the system is ON turns the system OFF.
- **Reset button (2-pin RESET)**
This 2-pin connector is for the chassis-mounted reset button for system reboot without turning off the system power.

Q-Connector (System panel)

ASUS Q-Connector allows you to easily to connect the chassis front panel cables to the motherboard. Perform these steps to install ASUS Q-Connector.

Step 1

Connect the front panel cables to their respective connectors on the ASUS Q-Connector. Refer to the labels on the Q-Connector for proper connection and pin definition.

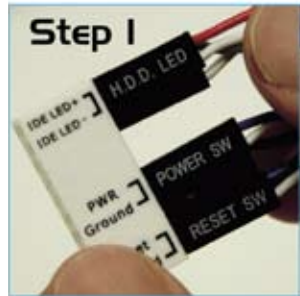

Step 2

Carefully connect the ASUS Q-Connector to the System panel connector.



The ASUS Q-Connector fits only in one orientation; if it doesn't fit, try reversing it.



When installed, the Q-connector appears as shown.



This chapter describes the power up sequence and ways of shutting down the system.

Powering up **3**

Chapter summary

3

- 3.1 Starting up for the first time..... 3-1
- 3.2 Powering off the computer..... 3-2

3.1 Starting up for the first time

1. After making all the connections, replace the system case cover.
2. Be sure that all switches are off.
3. Connect the power cord to the power connector at the back of the system chassis.
4. Connect the power cord to a power outlet that is equipped with a surge protector.
5. Turn on the devices in the following order:
 - a. Monitor
 - b. External SCSI devices (starting with the last device on the chain)
 - c. System power
6. After applying power, the system power LED on the system front panel case lights up. For systems with ATX power supplies, the system LED lights up when you press the ATX power button. If your monitor complies with “green” standards or if it has a “power standby” feature, the monitor LED may light up or switch between orange and green after the system LED turns on.

The system then runs the power-on self tests or POST. While the tests are running, the BIOS beeps or additional messages appear on the screen. If you do not see anything within 30 seconds from the time you turned on the power, the system may have failed a power-on test. Check the jumper settings and connections or call your retailer for assistance.
7. At power on, hold down the key to enter the BIOS Setup. Follow the instructions in Chapter 4.

3.2 Powering off the computer

3.2.1 Using the OS shut down function

If you are using Windows® 2000:

1. Click the Start button then click Shut Down...
2. Make sure that the Shut Down option button is selected, then click the OK button to shut down the computer.
3. The power supply should turn off after Windows® shuts down.

If you are using Windows® XP:

1. Click the Start button then select Turn Off Computer.
2. Click the Turn Off button to shut down the computer.
3. The power supply should turn off after Windows® shuts down.

3.2.2 Using the dual function power switch

While the system is ON, pressing the power switch for less than four seconds puts the system to sleep mode or to soft-off mode, depending on the BIOS setting. Pressing the power switch for more than four seconds lets the system enter the soft-off mode regardless of the BIOS setting. Refer to section “4.5 Power Menu” in Chapter 4 for details.

This chapter tells how to change the system settings through the BIOS Setup menus. Detailed descriptions of the BIOS parameters are also provided.

BIOS setup 4

Chapter summary

4.1	Managing and updating your BIOS	4-1
4.2	BIOS setup program.....	4-11
4.3	Main menu.....	4-15
4.4	Advanced menu	4-20
4.5	Power menu	4-32
4.6	Boot menu	4-37
4.7	Tools menu	4-43
4.8	Exit menu.....	4-44

4.1 Managing and updating your BIOS

The following utilities allow you to manage and update the motherboard Basic Input/Output System (BIOS) setup.

1. **Award BIOS Flash Utility** (Updates the BIOS in DOS mode using a bootable floppy disk.)
2. **ASUS CrashFree BIOS 3** (Updates the BIOS using a bootable USB flash disk, floppy disk or the motherboard support CD when the BIOS file fails or gets corrupted.)
3. **ASUS EZ Flash 2** (Updates the BIOS in DOS using a floppy disk or the motherboard support CD.)
4. **ASUS Update** (Updates the BIOS in Windows® environment.)

Refer to the corresponding sections for details on these utilities.



Save a copy of the original motherboard BIOS file to a bootable floppy disk in case you need to restore the BIOS in the future. Copy the original motherboard BIOS using the ASUS Update or AwardBIOS Flash utilities.

4.1.1 Creating a bootable floppy disk

1. Do either one of the following to create a bootable floppy disk.

DOS environment

- a. Insert a 1.44MB floppy disk into the drive.
- b. At the DOS prompt, type `format A:/S` then press <Enter>.

Windows® XP environment

- a. Insert a 1.44 MB floppy disk to the floppy disk drive.
- b. Click **Start** from the Windows® desktop, then select **My Computer**.
- c. Select the 3 1/2 Floppy Drive icon.
- d. Click **File** from the menu, then select **Format**. A **Format 3 1/2 Floppy Disk** window appears.
- e. Select **Create an MS-DOS startup disk** from the format options field, then click **Start**.

Windows® 2000 environment

To create a set of boot disks for Windows® 2000:

- a. Insert a formatted, high density 1.44 MB floppy disk into the drive.
- b. Insert the Windows® 2000 CD to the optical drive.

- c. Click Start, then select **Run**.
 - d. From the Open field, type
D:\bootdisk\makeboot a:
 assuming that D: is your optical drive.
 - e. Press <Enter>, then follow screen instructions to continue.
2. Copy the original or the latest motherboard BIOS file to the bootable floppy disk.

4.1.2 Updating the BIOS

The Basic Input/Output System (BIOS) can be updated using the AwardBIOS Flash Utility. Follow these instructions to update the BIOS using this utility.

1. Download the latest BIOS file from the ASUS web site. Rename the file to **m2nesli.bin** and save it to a floppy disk.



Save only the updated BIOS file in the floppy disk to avoid loading the wrong BIOS file.

2. Copy the AwardBIOS Flash Utility (awdfash.exe) from the Software folder of the support CD to the floppy disk with the latest BIOS file.
3. Boot the system in DOS mode using the bootable floppy disk you created earlier.
4. When the **A:>** appears, replace the bootable floppy disk with the floppy disk containing the new BIOS file and the Award BIOS Flash Utility.
5. At the prompt, type **awdfash** then press <Enter>. The Award BIOS Flash Utility screen appears.

```

AwardBIOS Flash Utility for ASUS V1.01
(C) Phoenix Technologies Ltd. All Rights Reserved

For NF-CK804-M2N-E SLI          DATE: 11/18/2004
Flash Type - SST 49LF004A/B /3.3V

File Name to Program: 

Message: Please input File Name!
  
```

6. Type the BIOS file name in the **File Name to Program** field, then press <Enter>.

```
AwardBIOS Flash Utility for ASUS V1.01
(C) Phoenix Technologies Ltd. All Rights Reserved

For NF-CK804-M2N-E SLI          DATE: 11/18/2004
Flash Type - SST 49LF004A/B /3.3V

File Name to Program: m2nesli.bin

Message: Do You Want To Save Bios (Y/N)
```

7. Press <N> when the utility prompts you to save the current BIOS file. The following screen appears.
8. The utility verifies the BIOS file in the floppy disk and starts flashing the BIOS file.

```
AwardBIOS Flash Utility for ASUS V1.01
(C) Phoenix Technologies Ltd. All Rights Reserved

For NF-CK804-M2N-E SLI          DATE: 11/18/2004
Flash Type - SST 49LF004A/B /3.3V

File Name to Program: m2nesli.bin

Program Flashing Memory - OFE00 OK

Write OK      No Update      Write Fail

Warning: Don't Turn Off Power Or Reset System!
```



Do not turn off or reset the system during the flashing process!

9. The utility displays a **Flashing Complete** message indicating that you have successfully flashed the BIOS file. Remove the floppy disk then press <F1> to restart the system.

```
AwardBIOS Flash Utility for ASUS V1.01
(C) Phoenix Technologies Ltd. All Rights Reserved

For NF-CK804-M2N-E SLI          DATE: 11/18/2004
Flash Type - SST 49LF004A/B /3.3V

File Name to Program: m2nesli.bin

Flashing Complete
Press <F1> to Continue

Write OK      No Update      Write Fail

F1 Reset
```

4.1.3 Saving the current BIOS file

You can use the AwardBIOS Flash Utility to save the current BIOS file. You can load the current BIOS file when the BIOS file gets corrupted during the flashing process.



Make sure that the floppy disk has enough disk space to save the file.

To save the current BIOS file using the AwardBIOS Flash Utility:

1. Follow steps 1 to 6 of the previous section.
2. Press <Y> when the utility prompts you to save the current BIOS file. The following screen appears.

```
AwardBIOS Flash Utility for ASUS V1.01
(C) Phoenix Technologies Ltd. All Rights Reserved

For NF-CK804-M2N-E SLI          DATE: 11/18/2004
Flash Type - SST 49LF004A/B /3.3V

File Name to Program: m2nesli.bin
Save current BIOS as:

Message:
```

3. Type a filename for the current BIOS file in the **Save current BIOS as** field, then press <Enter>.

```
AwardBIOS Flash Utility for ASUS V1.01
(C) Phoenix Technologies Ltd. All Rights Reserved

For NF-CK804-M2N-E SLI          DATE: 11/18/2004
Flash Type - SST 49LF004A/B /3.3V

File Name to Program: m2nesli.bin
Checksum: DAD6h
Save current BIOS as: m2nesli2.bin

Message: Please Wait!
```

4. The utility saves the current BIOS file to the floppy disk, then returns to the BIOS flashing process.

```
AwardBIOS Flash Utility for ASUS V1.01
(C) Phoenix Technologies Ltd. All Rights Reserved

For NF-CK804-M2N-E SLI          DATE: 11/18/2004
Flash Type - SST 49LF004A/B /3.3V

File Name to Program: m2nesli2.bin
Now Backup System BIOS to
File!

Message: Please Wait!
```

4.1.4 ASUS CrashFree BIOS 3 utility

The ASUS CrashFree BIOS 3 is an auto recovery tool that allows you to restore the BIOS file when it fails or gets corrupted during the updating process. You can update a corrupted BIOS file using the motherboard support CD, floppy, or USB flash disk that contains the updated BIOS file.



Prepare the motherboard support CD, floppy, or USB flash disk containing the updated motherboard BIOS before using this utility.

Recovering the BIOS from the support CD

To recover the BIOS from the support CD:

1. Turn on the system.
2. Insert the motherboard support CD to the optical drive.
3. The utility displays the following message and automatically checks the CD for the BIOS file.

```
Award BootBlock BIOS v1.0
Copyright (c) 2000, Award Software, Inc.

BIOS ROM checksum error
Detecting IDE ATAPI device...
```

When found, the utility reads the BIOS file and starts flashing the corrupted BIOS file.

```
Award BootBlock BIOS v1.0
Copyright (c) 2000, Award Software, Inc.

BIOS ROM checksum error
Detecting IDE ATAPI device...
Found CDRom, try to Boot from it... Pass
```

4. Restart the system after the utility completes the updating process.

Recovering the BIOS from the USB flash disk

To recover the BIOS from the USB flash disk:

1. Insert the USB flash disk that contains BIOS file to the USB port.
2. Turn on the system.
3. The utility will automatically checks the devices for the BIOS file When found, the utility reads the BIOS file and starts flashing the corrupted BIOS file.
4. Restart the system after the utility completes the updating process.



- Use only a USB flash disk smaller than 8GB with single partition and FAT 32/16/12 format.
- DO NOT shut down or reset the system while updating the BIOS! Doing so can cause system boot failure!

Recovering the BIOS from a floppy disk

To recover the BIOS from the support CD:

1. Remove any CD from the optical drive, then turn on the system.
2. Insert the floppy disk with the original or updated BIOS file to the floppy disk drive.
3. The utility displays the following message and automatically checks the floppy disk for the original or updated BIOS file.

```
Award BootBlock BIOS v1.0
Copyright (c) 2000, Award Software, Inc.

BIOS ROM checksum error
Detecting IDE ATAPI device...
```

When no CD is found, the utility automatically checks the optical drive for the original or updated BIOS file. The utility then updates the corrupted BIOS file.

```
Award BootBlock BIOS v1.0
Copyright (c) 2000, Award Software, Inc.

BIOS ROM checksum error
Detecting IDE ATAPI device...
  Found CDRom, try to Boot from it... Fail

Detecting floppy drive A media...
```



DO NOT shut down or reset the system while updating the BIOS! Doing so can cause system boot failure!

4. Restart the system after the utility completes the updating process.



The recovered BIOS may not be the latest BIOS version for this motherboard. Visit the ASUS website (www.asus.com) to download the latest BIOS file.

4.1.5 ASUS EZ Flash 2 utility

The ASUS EZ Flash 2 feature allows you to update the BIOS without having to go through the long process of booting from a floppy disk and using a DOS-based utility. You can launch ASUS EZ Flash 2 by press <Alt> + <F2> during the Power-On Self-Test (POST).

To update the BIOS using EZ Flash 2:

1. Go to the ASUS website (www.asus.com) and download the latest BIOS file for your motherboard.
2. Save the BIOS file to a floppy disk or a USB flash disk then restart your computer.
3. You can launch the EZ Flash 2 in two ways:
(1) Insert the floppy disk or USB flash disk that contains the BIOS file into the floppy disk drive or the USB port.

Press <Alt> + <F2> during POST to display the following.

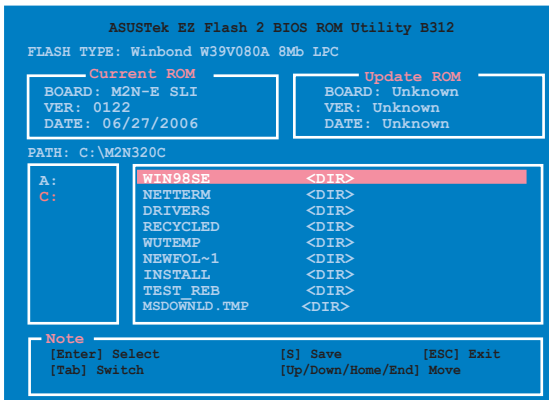

(2) Enter BIOS setup program. Go to the Tools menu then select EZ Flash 2 and press <Enter>.

You can switch between drives by pressing <Tab> before the correct file is found. Then press <Enter>.

4. When the correct BIOS file is found, EZ Flash 2 performs the BIOS update process and automatically reboots the system when done.



- This function can support devices such as USB flash disk, hard disk, or floppy disk with FAT 32/16/12 format only.
- Do not shut down or reset the system while updating the BIOS to prevent system boot failure!

4.1.6 ASUS Update utility

The ASUS Update is a utility that allows you to manage, save, and update the motherboard BIOS in Windows® environment. The ASUS Update utility allows you to:

- Save the current BIOS file
- Download the latest BIOS file from the Internet
- Update the BIOS from an updated BIOS file
- Update the BIOS directly from the Internet, and
- View the BIOS version information.

This utility is available in the support CD that comes with the motherboard package.



ASUS Update requires an Internet connection either through a network or an Internet Service Provider (ISP).

Installing ASUS Update

To install ASUS Update:

1. Place the support CD in the optical drive. The **Drivers** menu appears.
2. Click the **Utilities** tab, then click **Install ASUS Update VX.XX.XX**. See page 5-3 for the **Utilities** screen menu.
3. The ASUS Update utility is copied to your system.



Quit all Windows® applications before you update the BIOS using this utility.

- From the FTP site, select the BIOS version that you wish to download. Click **Next**.
- Follow the screen instructions to complete the update process.



The ASUS Update utility is capable of updating itself through the Internet. Always update the utility to avail all its features.



Updating the BIOS through a BIOS file

To update the BIOS through a BIOS file:

- Launch the ASUS Update utility from the Windows® desktop by clicking **Start > Programs > ASUS > ASUSUpdate > ASUSUpdate**. The ASUS Update main window appears.
- Select **Update BIOS from a file** option from the drop-down menu, then click **Next**.



- Locate the BIOS file from the **Open** window, then click **Open**.
- Follow the screen instructions to complete the update process.



4.2 BIOS setup program

This motherboard supports a programmable Low-Pin Count (LPC) chip that you can update using the provided utility described in section “4.1 Managing and updating your BIOS.”

Use the BIOS Setup program when you are installing a motherboard, reconfiguring your system, or prompted to “Run Setup.” This section explains how to configure your system using this utility.

Even if you are not prompted to use the Setup program, you can change the configuration of your computer in the future. For example, you can enable the security password feature or change the power management settings. This requires you to reconfigure your system using the BIOS Setup program so that the computer can recognize these changes and record them in the CMOS RAM of the LPC chip.

The LPC chip on the motherboard stores the Setup utility. When you start up the computer, the system provides you with the opportunity to run this program. Press during the Power-On Self-Test (POST) to enter the Setup utility; otherwise, POST continues with its test routines.

If you wish to enter Setup after POST, reboot the system by doing any of the following procedures:

- **Restart using the OS standard shut-down procedure.**
- **Press <Ctrl>+<Alt>+ simultaneously.**
- **Press the reset button on the system chassis.**
- **Press the power button to turn the system off then back on.**



Using the power button, reset button, or the <Ctrl>+<Alt>+ keys to force reset from a running operating system can cause damage to your data or system. We recommend to always shut-down the system properly from the operating system.

The Setup program is designed to make it as easy to use as possible. Being a menu-driven program, it lets you scroll through the various sub-menus and make your selections from the available options using the navigation keys.



- The default BIOS settings for this motherboard apply for most conditions to ensure optimum performance. If the system becomes unstable after changing any BIOS settings, load the default settings to ensure system compatibility and stability. Select the Load Default Settings item under the Exit Menu. See section “4.8 Exit Menu.”
- The BIOS setup screens shown in this section are for reference purposes only, and may not exactly match what you see on your screen.
- Visit the ASUS website (www.asus.com) to download the latest BIOS file for this motherboard.

4.2.3 Legend bar

At the bottom of the Setup screen is a legend bar. The keys in the legend bar allow you to navigate through the various setup menus. The following table lists the keys found in the legend bar with their corresponding functions.

Navigation Key	Function
<F1>	Displays the General Help screen
<F5>	Loads setup default values
<Esc>	Exits the BIOS setup or returns to the main menu from a sub-menu
Left or Right arrow	Selects the menu item to the left or right
Up or Down arrow	Moves the highlight up or down between fields
Page Down or - (minus)	Scrolls backward through the values for the highlighted field
Page Up or + (plus)	Scrolls forward through the values for the highlighted field
<Enter>	Brings up a selection menu for the highlighted field
<F10>	Saves changes and exit

4.2.4 Menu items

The highlighted item on the menu bar displays the specific items for that menu. For example, selecting **Main** shows the Main menu items.

The other items (Advanced, Power, Boot, and Exit) on the menu bar have their respective menu items.

4.2.5 Sub-menu items

A solid triangle before each item on any menu screen means that the item has a sub-menu. To display the sub-menu, select the item and press <Enter>.

4.2.6 Configuration fields

These fields show the values for the menu items. If an item is user-configurable, you can change the value of the field opposite the item. You cannot select an item that is not user-configurable.

A configurable field is enclosed in brackets, and is highlighted when selected. To change the value of a field, select it then press <Enter> to display a list of options. Refer to “4.2.7 Pop-up window.”

4.2.7 Pop-up window

Select a menu item then press <Enter> to display a pop-up window with the configuration options for that item.

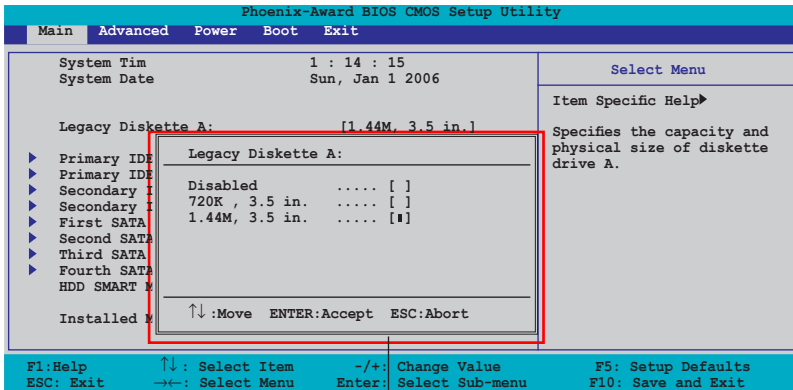

Pop-up menu

4.2.8 General help

At the top right corner of the menu screen is a brief description of the selected item.

4.3 Main menu

When you enter the BIOS Setup program, the Main menu screen appears, giving you an overview of the basic system information.



Refer to section “4.2.1 BIOS menu screen” for information on the menu screen items and how to navigate through them.

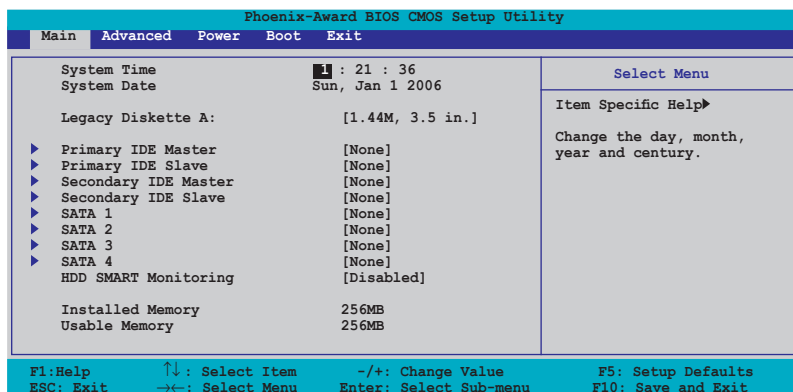

4.3.1 System Time [xx:xx:xx]

Allows you to set the system time.

4.3.2 System Date [Day, xx/xx/xxxx]

Allows you to set the system date.

4.3.3 Legacy Diskette A [1.44M, 3.5 in.]

Sets the type of floppy drive installed. Configuration options: [Disabled] [720K , 3.5 in.] [1.44M, 3.5 in.]

4.3.5 Primary and Secondary IDE Master/Slave

While entering Setup, the BIOS automatically detects the presence of IDE devices. There is a separate sub-menu for each IDE device. Select a device item then press <Enter> to display the IDE device information.

Phoenix-Award BIOS CMOS Setup Utility		
Main		
Primary IDE Master		Select Menu
Primary IDE Master	[Auto]	Item Specific Help▶▶
Access Mode	[Auto]	Press [Enter] to select
Capacity	0 MB	
Cylinder	0	
Head	0	
Sector	0	
PIO Mode	[Auto]	
UDMA Mode	[Auto]	
Transfer Mode	None	

F1: Help ↑↓: Select Item -/+ : Change Value F5: Setup Defaults
ESC: Exit →←: Select Menu Enter: Select Sub-menu F10: Save and Exit

The BIOS automatically detects the values opposite the dimmed items (Capacity, Cylinder, Head, Sector and Transfer Mode). These values are not user-configurable. These items show N/A if no IDE device is installed in the system.

Primary IDE Master/Slave [Auto]; Secondary IDE Master/Slave [Auto]

Select [Auto] to automatically detect an IDE hard disk drive. If automatic detection is successful, the BIOS automatically fills in the correct values for the remaining fields on this sub-menu. If the hard disk was already formatted on a previous system, the setup BIOS may detect incorrect parameters. Select [Manual] to manually enter the IDE hard disk drive parameters. If no drive is installed select [None].

Configuration options: [None] [Auto] [Manual]

Access Mode [Auto]

The default [Auto] allows automatic detection of an IDE hard disk drive. Select [CHS] for this item if you set the IDE Primary Master/Slave to [Manual].

Configuration options: [CHS] [LBA] [Large] [Auto]



Before attempting to configure a hard disk drive, make sure you have the correct configuration information supplied by the drive manufacturer. Incorrect settings may cause the system to fail to recognize the installed hard disk.

Capacity

Displays the auto-detected hard disk capacity. This item is not configurable.

Cylinder

Shows the number of the hard disk cylinders. This item is not configurable.

Head

Shows the number of the hard disk read/write heads. This item is not configurable.

Sector

Shows the number of sectors per track. This item is not configurable.

PIO Mode

Sets the PIO mode for the IDE device.

Configuration options: [Auto] [Mode 0] [Mode 1] [Mode 2] [Mode 3] [Mode 4]

UDMA Mode

Disables or sets the UDMA mode.

Configuration options: [Disabled] [Auto]

Transfer Mode

Shows the Transfer mode. This item is not configurable.



After entering the IDE hard disk drive information into BIOS, use a disk utility, such as FDISK, to partition and format new IDE hard disk drives. This is necessary so that you can write or read data from the hard disk. Make sure to set the partition of the Primary IDE hard disk drives to active.

4.3.6 SATA 1, 2, 3, 4

While entering Setup, the BIOS automatically detects the presence of Serial ATA devices. There is a separate sub-menu for each SATA device. Select a device item then press <Enter> to display the SATA device information.

Phoenix-Award BIOS CMOS Setup Utility			
Main			
SATA 1		Select Menu	
Extended IDE Drive	Auto	Item Specific Help▶▶ Press [Enter] to select	
Access Mode	[Auto]		
Capacity	0 MB		
Cylinder	0		
Head	0		
Landing Zone	0		
Sector	0		
F1: Help	↑↓: Select Item	-/+ : Change Value	F5: Setup Defaults
ESC: Exit	→←: Select Menu	Enter: Select Sub-menu	F10: Save and Exit

The BIOS automatically detects the values opposite the dimmed items (Capacity, Cylinder, Head, Precomp, Landing Zone and Sector). These values are not user-configurable. These items show 0 if no SATA device is installed in the system.

Extended IDE Drive [Auto]

Selects the type of fixed disk connected to the system.
Configuration options: [None] [Auto]

Access Mode [Auto]

Sets the sector addressing mode.
Configuration options: [Large] [Auto]



Before attempting to configure a hard disk drive, make sure you have the correct configuration information supplied by the drive manufacturer. Incorrect settings may cause the system to fail to recognize the installed hard disk.

Capacity

Displays the auto-detected hard disk capacity. This item is not configurable.

Cylinder

Shows the number of the hard disk cylinders. This item is not configurable.

Head

Shows the number of the hard disk read/write heads. This item is not configurable.

Landing Zone

Shows the number of landing zone per track. This item is not configurable.

Sector

Shows the number of sectors per track. This item is not configurable.



After entering the IDE hard disk drive information into BIOS, use a disk utility, such as FDISK, to partition and format new IDE hard disk drives. This is necessary so that you can write or read data from the hard disk. Make sure to set the partition of the Primary IDE hard disk drives to active.

4.3.7 HDD SMART Monitoring [Disabled]

Allows you to enable or disable the HDD Self-Monitoring Analysis and Reporting Technology (SMART) feature.

Configuration options: [Disabled] [Enabled]

4.3.8 Installed Memory

Shows the size of installed memory.

4.4 Advanced menu

The Advanced menu items allow you to change the settings for the CPU and other system devices.



Take caution when changing the settings of the Advanced menu items. Incorrect field values can cause the system to malfunction.

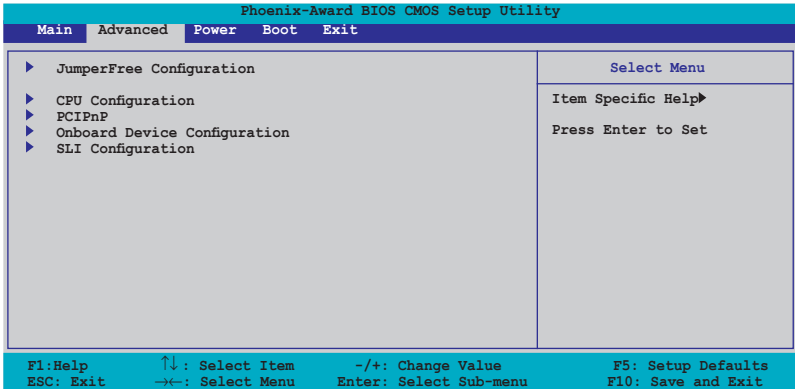

4.4.1 JumperFree Configuration

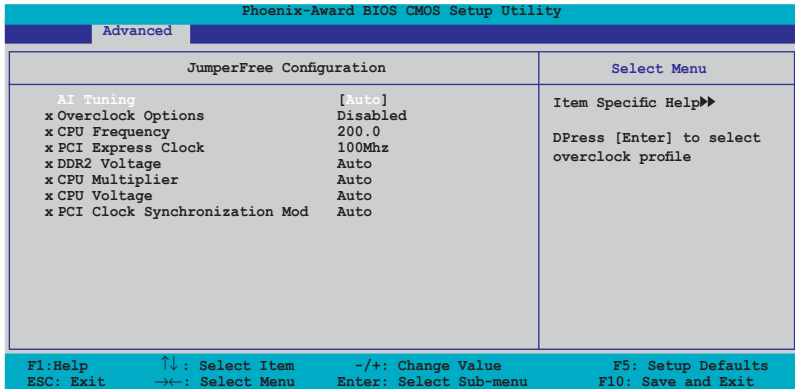

Overclock Profile [Auto]

Allows selection of CPU overclocking options to achieve desired CPU internal frequency. Select either one of the preset overclocking configuration options:

Manual	Allows you to individually set overclocking parameters.
Auto	Loads the optimal settings for the system.
Standard	Loads the standard settings for the system.
AI Overclock	Loads overclocking profiles with optimal parameters for stability when overclocking.



The following items are user-configurable only when the Overclock Profile item is set to [Manual].

CPU Frequency [XXX] (value is auto-detected)

Indicates the frequency sent by the clock generator to the system bus and PCI bus. The bus frequency (external frequency) multiplied by the bus multiple equals the CPU speed. The value of this item is auto-detected by BIOS. The values range from 200 to 400. Refer to the following table for the correct Front Side Bus and CPU External Frequency settings.



Selecting a very high CPU frequency may cause the system to become unstable! If this happens, revert to the default setting.

PCI Express Clock [100MHz]

Allows you to set the PCI Express clock. Key-in a decimal value between 100-200 MHz. Configuration options: [100Mhz] [101Mhz~[145Mhz]

DDR2 Voltage [Auto]

Sets the operating DDR voltage. Configuration options: [Auto] [1.80V] [1.85V] [1.90V] [1.95V]

CPU Multiplier [Auto]

Sets the operating CPU multiplier. The configuration options vary depending on the type of CPU installed. Configuration options: [Auto] [5x] [6x] [7x] [8x] [9x]

CPU Voltage [Auto]

Sets the operating CPU voltage. The configuration options vary depending on the model of processor installed.

PCI Clock Synchronization Mode [Auto]

Sets the PCI Clock Synchronization mode.

Configuration options: [Auto] [To CPU] [33.33MHz]

4.4.3 CPU Configuration

Phoenix-Award BIOS CMOS Setup Utility		
Advanced		
CPU Configuration		Select Menu
CPU Type	AMD Sempron(tm) Processor 3200+	Item Specific Help▶▶
CPU Speed	1800MHz	DRAM timing and control
Cache RAM	128K	
▶ DRAM Configuration		
Hyper Transport Frequency	[Auto]	
AMD Live!	[Disabled]	
AMD Cool'n'Quiet Function	[Disabled]	
F1: Help ↑↓: Select Item -/+ : Change Value F5: Setup Defaults ESC: Exit →←: Select Menu Enter: Select Sub-menu F10: Save and Exit		

DRAM Configuration

The items in this sub-menu show the DRAM-related information auto-detected by the BIOS.

Phoenix-Award BIOS CMOS Setup Utility		
Advanced		
DRAM Configuration		Select Menu
Memory Clock Frequency	[Auto]	Item Specific Help▶▶▶
▶ DRAM Timing Control		Setting platform Memclock or limit valu
Tcl	[Auto]	
Trod	[Auto]	
Trp	[Auto]	
Tras	[Auto]	
Trc	[Auto]	
Twr	[Auto]	
Trrd	[Auto]	
Trwt	[Auto]	
Twtr	[Auto]	
Trtp	[Auto]	
Twzrd	[Auto]	
Twzwr	[Auto]	
Trdrd	[Auto]	
Trfc	[Auto]	
1T/2T Memory Timing	[Auto]	
F1: Help ↑↓: Select Item -/+ : Change Value F5: Setup Defaults ESC: Exit →←: Select Menu Enter: Select Sub-menu F10: Save and Exit		

Memory Clock Frequency[Auto]

Sets platform Memclock or limit value.

Configuration options:

[Auto] [DDR2 400] [DDR2 533] [DDR2 667] [DDR2 800]

DRAM Timing Control

Load Fail-Safe Defaults

Configuration options: [YES] [NO]

USB Keyboard Support [Enabled]

Configuration options: [Disabled] [Enabled]

USB Mouse Support [Enabled]

Configuration options: [Disabled] [Enabled]

Onboard FDC Controller [Enabled]

Configuration options: [Disabled] [Enabled]

CKE Fine Delay [Auto]

Configuration options: [Auto] [No delay] [1/64 MEMCLK delay] [2/64 MEMCLK delay] [3/64 MEMCLK delay] [4/64 MEMCLK delay] [5/64 MEMCLK delay]...[30/64 MEMCLK delay] [31/64 MEMCLK delay]

CKE Setup Time [Auto]

Configuration options: [Auto] [1/2 MEMCLK] [1 MEMCLK]

CS/ODT Fine Delay [Auto]

Configuration options: [Auto] [No delay] [1/64 MEMCLK delay] [2/64 MEMCLK delay] [3/64 MEMCLK delay] [4/64 MEMCLK delay] [5/64 MEMCLK delay]...[30/64 MEMCLK delay] [31/64 MEMCLK delay]

CS/ODT Setup Time [Auto]

Configuration options: [Auto] [1/2 MEMCLK] [1 MEMCLK]

Address/Command Fine Delay [Auto]

Configuration options: [Auto] [No delay] [1/64 MEMCLK delay] [2/64 MEMCLK delay] [3/64 MEMCLK delay] [4/64 MEMCLK delay] [5/64 MEMCLK delay]...[30/64 MEMCLK delay] [31/64 MEMCLK delay]

Address/Command Setup Time [Auto]

Configuration options: [Auto] [1/2 MEMCLK] [1 MEMCLK]

Tcl[Auto]

Configuration options: [Auto] [3] [4] [5] [6]

Trcd[Auto]

Configuration options: [Auto] [3] [4] [5] [6]

Trp[Auto]

Configuration options: [Auto] [3] [4] [5] [6]

Tras[Auto]

Configuration options: [Auto] [5] [6] [7] [8] [9] [10] [11]

Trc[Auto]

Configuration options: [Auto] [11] [12] [13] [14] [15] [16] [17]

Twr[Auto]

Configuration options: [Auto] [3] [4] [5] [6]

Trrd[Auto]

Configuration options: [Auto] [2] [3] [4] [5]

Trwt[Auto]

Configuration options: [Auto] [2] [3] [4] [5] [6] [7] [8]

Twtr[Auto]

Configuration options: [Auto] [1] [2] [3]

Trtp[Auto]

Configuration options: [Auto] [2/4] [3/5]

Twrrd[Auto]

Configuration options: [Auto] [0] [1] [2] [3]

Twrrwr[Auto]

Configuration options: [Auto] [1] [2] [3]

Trdrd[Auto]

Configuration options: [Auto] [2] [3] [4] [5]

Trfc[Auto]

Configuration options: [Auto] [0] [1] [2] [3]

1T/2T Memory Timing[Auto]

Configuration Options: [Auto] [1T] [2T]

Hyper Transport Frequency [Auto]

Configuration options: [1x] [2x] [3x] [4x] [5x] [Auto]

AMD Live! [Disabled]

Enables or disables AMD Live! technology.

Configuration options: [Disabled] [Enabled]

AMD Cool'n'Quiet Function [Disabled]

Enables or disables the AMD Cool'n'Quiet function.

Configuration options: [Auto] [Disabled]

4.4.4 PCIPnP

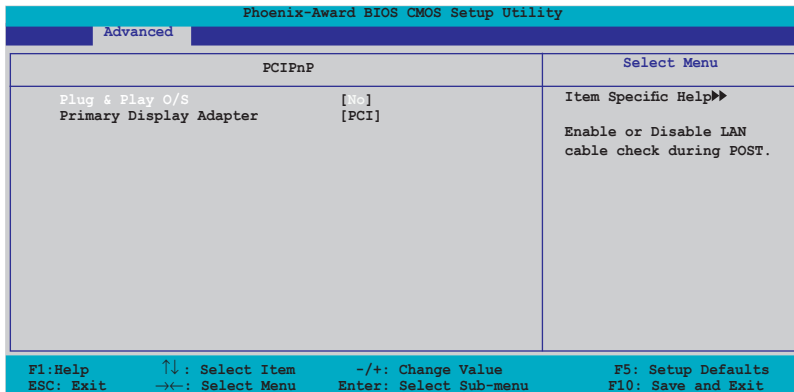

Plug & Play O/S[No]

When set to [No], the BIOS configures all the devices in the system.

When set to [Yes] and if you install a Plug and Play operating system, the operating system configures the Plug and Play devices not required for boot.

Configuration options: [No] [Yes]

Primary Display Adapter[PCI]

Allows selection of graphics controller to use as the primary boot device.

Configuration options: [PCI] [PCI-E]

4.4.5 Onboard Device Configuration

Phoenix-Award BIOS CMOS Setup Utility	
Advanced	
Onboard Device Configuration	Select Menu
<ul style="list-style-type: none">▶ IDE Function Setup▶ NVRAID Configuration▶ USB ConfigurationOnboard nVidia LAN [Enabled]Onboard LAN Boot ROM [Disabled]Onboard USB Audio [Enabled]Onboard 1394 [Enabled]Serial Port1 Address [3F8/IRQ4]Parallel Port Address [378/IRQ7]Parallel Port Mode [EPP]x ECP Mode Use DMA 3	Item Specific Help▶▶
F1: Help ↑↓: Select Item -/+ : Change Value F5: Setup Defaults	ESC: Exit →←: Select Menu Enter: Select Sub-menu F10: Save and Exit

IDE Function Setup

This item in this sub-menu allows you to enable or disable IDE functions.

Phoenix-Award BIOS CMOS Setup Utility	
Advanced	
IDE Function Setup	Select Menu
OnChip IDE Channel0 [Enabled] OnChip IDE Channel1 [Enabled] IDE DMA transfer access [Enabled] SATA Port 1,2 [Enabled] SATA DMA transfer [Enabled] SATA Port 3,4 [Enabled] SATA2 DMA transfer [Enabled] IDE Prefetch Mode [Enabled]	Item Specific Help▶▶
F1: Help ↑↓: Select Item -/+ : Change Value F5: Setup Defaults	ESC: Exit →←: Select Menu Enter: Select Sub-menu F10: Save and Exit

OnChip IDE Channel0[Enabled]

Allows to disable or enable OnChip IDE Channel0

Configuration options: [Disabled] [Enabled]

OnChip IDE Channel1[Enabled]

Allows to disable or enable OnChip IDE Channel1

Configuration options: [Disabled] [Enabled]

IDE DMA transfer access[Enabled]

Allows to disable or enable IDE DMA transfer access

Configuration options: [Disabled] [Enabled]

SATA Port 1, 2[Enabled]

Allows to disable or enable OnChip SATA(Port 1, Port 2)

Configuration options: [Disabled] [Enabled]

SATA DMA transfer [Enabled]

Allows to disable or enable to switch to support SATA DMA transfer

Configuration options: [Disabled] [Enabled]

SATA Port 3, 4[Enabled]

Allows to disable or enable OnChip SATA2(Port 3, Port 4)

Configuration options: [Disabled] [Enabled]

SATA2 DMA transfer [Enabled]

Allows to disable or enable to switch to support SATA2 DMA transfer

Configuration options: [Disabled] [Enabled]

IDE Prefetch Mode[Enabled]

Allows to disable or enable IDE PIO read prefetch mode. When prefetch is enabled, either 16-bit or 32-bit are allowed on IDE bus.

Configuration options: [Disabled] [Enabled]

NVRAID Configuration

This item in this sub-menu allows you to set up RAID feature.

Phoenix-Award BIOS CMOS Setup Utility		
Advanced		
NVRAID Configuration		Select Menu
RAID Enable		[Disabled]
x SATA 1	RAID	[Disabled]
x SATA 2	RAID	[Disabled]
x SATA 3	RAID	[Disabled]
x SATA 4	RAID	[Disabled]

F1: Help ↑↓: Select Item -/+ : Change Value F5: Setup Defaults
ESC: Exit →←: Select Menu Enter: Select Sub-menu F10: Save and Exit

RAID Enable[Disabled]

Allows to disable or enable nVIDIA RAID feature.
Configuration options: [Disabled] [Enabled]



The following items are user-configurable only when the RAID Enable is set to [Enabled].

SATA 1 RAID[Disabled]

Selects this device as RAID set.
Configuration options: [Disabled] [Enabled]

SATA 2 RAID[Disabled]

Selects this device as RAID set.
Configuration options: [Disabled] [Enabled]

SATA 3 RAID[Disabled]

Selects this device as RAID set.
Configuration options: [Disabled] [Enabled]

SATA 4 RAID[Disabled]

Selects this device as RAID set.
Configuration options: [Disabled] [Enabled]

USB Configuration

The items in this sub-menu allows you to set the USB configuration.

Phoenix-Award BIOS CMOS Setup Utility			
Advanced			
USB Configuration		Select Menu	
USB Controller	[Enabled]	Item Specific Help▶▶ Press [Enter] to set.	
USB 2.0 Controller	[Enabled]		
USB Legacy support	[Enabled]		
F1: Help	↑↓: Select Item	-/+ : Change Value	F5: Setup Defaults
ESC: Exit	→←: Select Menu	Enter: Select Sub-menu	F10: Save and Exit

USB Controller[enabled]

Enables or disables USB 1.1 and 2.0 Controller
Configuration options: [Disabled] [Enabled]



When USB Controller is set to [Disabled], both USB 2.0 Controller and USB Legacy support will be disabled..

USB 2.0 Controller[enabled]

Enables or disables 2.0 Controller
Configuration options: [Disabled] [Enabled]



When USB 2.0 Controller is set to [Disabled], audio function will be disabled.

USB 2.0 Legacy support[enabled]

Enables or disables USB legacy device (USB keyboard and USB mouse) support.
Configuration options: [Disabled] [Enabled]

Onboard nVidia LAN[Enabled]

Enable or Disable Onboard NV LAN Interface.
Configuration options: [Enabled] [Disabled]

Onboard LAN Boot ROM[Disabled]

Enable or Disable the bootrom of the onboard LAN.
Configuration options: [Enabled] [Disabled]

Onboard USB Audio[Enabled]

Enable or Disable Onboard USB Audio.

Configuration options: [Enabled] [Disabled]

Onboard 1394[Enabled]

Enable or Disable Onboard 1394.

Configuration options: [Enabled] [Disabled]

Serial Port1 Address [3F8/IRQ4]

Allows you to select the Serial Port1 base address.

Configuration options: [Disabled] [3F8/IRQ4] [2F8/IRQ3] [3E8/IRQ4] [2E8/IRQ3] [Auto]

Parallel Port Address [378/IRQ7]

Allows you to select the Parallel Port base addresses.

Configuration options: [Disabled] [378/IRQ7] [278/IRQ5] [3BC/IRQ7]

Parallel Port Mode [EPP]

Allows you to select the Parallel Port mode.

Configuration options: [Normal] [EPP] [ECP] [Bi-Directional]

ECP Mode Use DMA [3]

Allows selection of ECP Mode.

Configuration options: [1] [3]

4.4.6 SLI Configuration

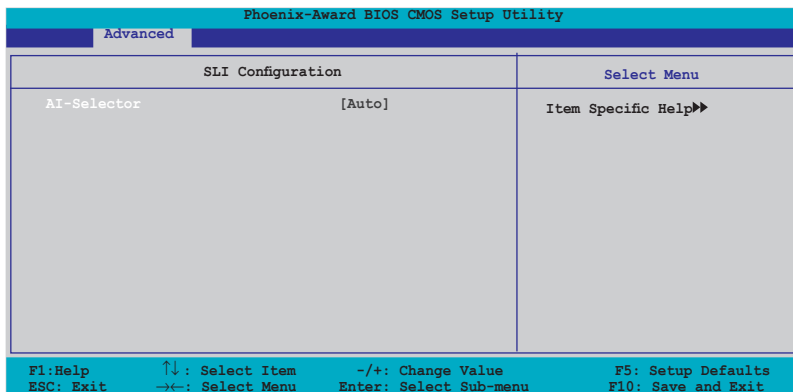

AI-Selector[Auto]

Allows selection of the Scalable Link Interface mode. When set to Auto, BIOS detects the setting of SLI EZ Selector Card. Set to Normal when using single PCI-E graphic cardplugged.

Configuration: [Auto] [Single Video Card] [Dual Video Card]

4.5 Power menu

The Power menu items allow you to change the settings for the Advanced Configuration and Power Interface (ACPI) and the Advanced Power Management (APM). Select an item then press <Enter> to display the configuration options.

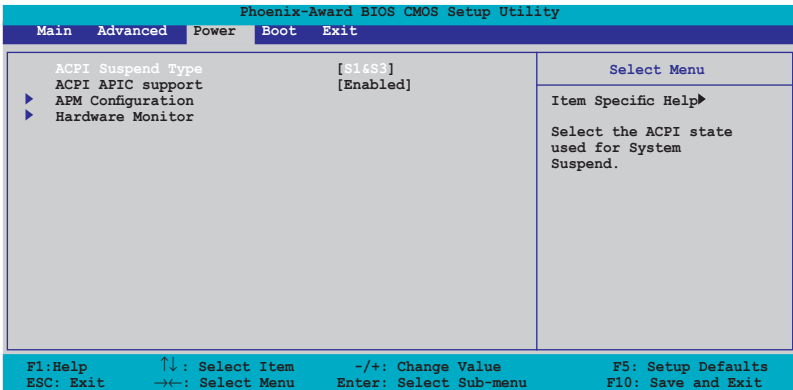

4.5.1 ACPI Suspend Type [S1&S3]

Allows you to select the Advanced Configuration and Power Interface (ACPI) state to be used for system suspend.

Configuration options: [S1(POS)] [S3(STR)] [S1&S3]

4.5.2 ACPI APIC Support [Enabled]

Allows you to enable or disable the Advanced Configuration and Power Interface (ACPI) support in the Application-Specific Integrated Circuit (ASIC). When set to Enabled, the ACPI APIC table pointer is included in the RSDT pointer list.

Configuration options: [Disabled] [Enabled]

4.5.3 APM Configuration

Phoenix-Award BIOS CMOS Setup Utility			
Power			
APM Configuration		Select Menu	
Restore on AC Power Loss	[Power-Off]	Item Specific Help▶▶ Press [ENTER] to select whether or not to restart the system after AC power loss.	
PWR Button < 4 secs	[Instant-Off]		
Power On By PCI/PCIE Devices	[Disabled]		
Power On By External Modems	[Disabled]		
Power On By RTC Alarm	[Disabled]		
x Date (of Month) Alarm	0		
x Alarm Time (hh:mm)	0 : 0 : 0		
HPET Support	[Enabled]		
Power Up By PS/2 Mouse	[Disabled]		
Power Up By PS/2 Keyboard	[Disabled]		
F1: Help	↑↓: Select Item	-/+ : Change Value	F5: Setup Defaults
ESC: Exit	→←: Select Menu	Enter: Select Sub-menu	F10: Save and Exit

Restore on AC Power Loss [Power-Off]

Allows you to enable or disable the Restore on AC Power Loss function. Configuration options: [Power-Off] [Power-On]

PWR Button < 4 secs [Instant-Off]

Allows you to set the event after the power button is pressed for more than 4 seconds. Configuration options: [Suspend] [Instant-Off]

Power On By PCI/PCIE Devices [Disabled]

When set to [Enabled], this parameter allows you to turn on the system through a PCI LAN or modem card. This feature requires an ATX power supply that provides at least 1A on the +5VSB lead. Configuration options: [Disabled] [Enabled]

Power On By External Modems [Disabled]

This allows either settings of [Enabled] or [Disabled] for powering up the computer when the external modem receives a call while the computer is in Soft-off mode. Configuration options: [Disabled] [Enabled]



The computer cannot receive or transmit data until the computer and applications are fully running. Thus, connection cannot be made on the first try. Turning an external modem off and then back on while the computer is off causes an initialization string that turns the system power on.

Power On By RTC Alarm [Disabled]

Allows you to enable or disable RTC to generate a wake event. When this item is set to Enabled, the items Date of Month Alarm and Time (hh:mm:ss) Alarm items become user-configurable with set values.

Configuration options: [Disabled] [Enabled]

Date of Month Alarm [Disabled]

To set the date of alarm, highlight this item and press <Enter> to display the Day of Month Alarm pop-up menu. Key-in a value within the specified range then press <Enter>. Configuration options: [Min=0] [Max=31]

Time (hh:mm) Alarm [Disabled]

To set the time of alarm:

1. Highlight this item and press <Enter> to display a pop-up menu for the hour field.
2. Key-in a value (Min=0, Max=23), then press <Enter>.
3. Press <TAB> to move to the minutes field then press <Enter>.
4. Key-in a minute value (Min=0, Max=59), then press <Enter>.
5. Press <TAB> to move to the seconds field then press <Enter>.
6. Key-in a value (Min=0, Max=59), then press <Enter>.

HPET Support [Enabled]

Allows you to enable or disable the HPET Support.

Configuration options: [Disabled] [Enabled]

Power Up By PS/2 Mouse [Disabled]

When set to [Enabled], this parameter allows you to use the PS/2 mouse to turn on the system. This feature requires an ATX power supply that provides at least 1A on the +5VSB lead.

Configuration options: [Disabled] [Enabled]

Power On By PS/2 Keyboard [Disabled]

Allows you to disable the Power On by PS/2 keyboard function or set specific keys on the PS/2 keyboard to turn on the system. This feature requires an ATX power supply that provides at least 1A on the +5VSB lead.

Configuration options: [Disabled] [Space Bar] [Ctrl-ESC] [Power Key]

4.5.4 Hardware Monitor

The items in this sub-menu displays the hardware monitor values automatically detected by the BIOS. It also allows you to change CPU Q-Fan feature-related parameters. Select an item then press <Enter> to display the configuration options.

Phoenix-Award BIOS CMOS Setup Utility		
Power		
Hardware Monitor		Select Menu
CPU Q-Fan Control	Disabled	Item Specific Help▶▶ Press [Enter] to enable or disable
x CPU Q-Fan Profile	Performance	
Chassis Q-Fan Control	[Disabled]	
x Chassis Q-Fan Profile	Performance	
Vcore Voltage	[1.36V]	
3.3V Voltage	[3.31V]	
5V Voltage	[4.97V]	
12V Voltage	[11.90V]	
CPU Temperature	45°C	
M/B Temperature	36°C	
CPU FAN Speed	3260 RPM	
CHASSIS FAN Speed	0 RPM	
Power FAN Speed	0 RPM	
CPU Fan Speed warning	[800 RPM]	

F1: Help ↑↓: Select Item -/+ : Change Value F5: Setup Defaults
ESC: Exit →←: Select Menu Enter: Select Sub-menu F10: Save and Exit

CPU/Chassis Q-Fan Control [Disabled]

Allows you to enable or disable the CPU/Chassis Q-Fan controller.
Configuration options: [Disabled] [Enabled]

CPU/Chassis Q-Fan Profile [Performance]

Allows you to set the CPU/Chassis Q-Fan type.
Configuration options: [Performance] [Optimal] [Silent]



Only when the Q-Fan Control is set to [Enabled], Q-Fan Profile are configurable.

VCORE Voltage[1.36V]

Allows you to enable or ignore the VCore voltage..
Configuration options: [1.36V] [Ignore]

3.3V Voltage[3.31V]

Allows you to set or ignore the 3.3V voltage.
Configuration options: [3.31V] [Ignore]

5V Voltage[4.97V]

Allows you to set or ignore the 5V voltage.
Configuration options: [4.97V] [Ignore]

12V Voltage[11.90V]

Allows you to set or ignore the 12V voltage.

Configuration options: [11.90V] [Ignore]

CPU Temperature, M/B Temperature

The onboard hardware monitor automatically detects and displays the motherboard and CPU temperatures. These items are not user-configurable.

CPU FAN Speed, CHASSIS FAN Speed, POWER Fan Speed

The onboard hardware monitor automatically detects and displays the Chassis, CPU, and power fan speeds in rotations per minute (RPM). If the fan is not connected to the motherboard, the field shows 0. These items are not user-configurable.

CPU Fan Speed warning [800 RPM]

Enables or disables the CPU Fan speed warning feature.

Configuration options: [Disabled] [800 RPM] [1200 RPM] [1600 RPM]



Please be careful when the CPU Fan speed warning is set to [Disabled]. It will not produce a warning message during POST even the fan is bad or not present.

4.6 Boot menu

The Boot menu items allow you to change the system boot options. Select an item then press <Enter> to display the sub-menu.

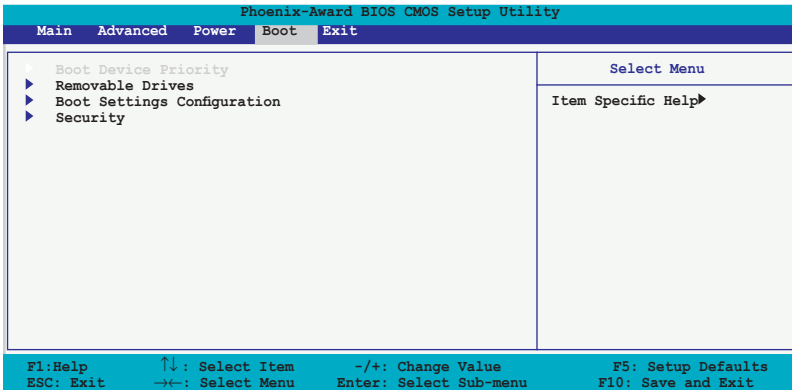

4.6.1 Boot Device Priority

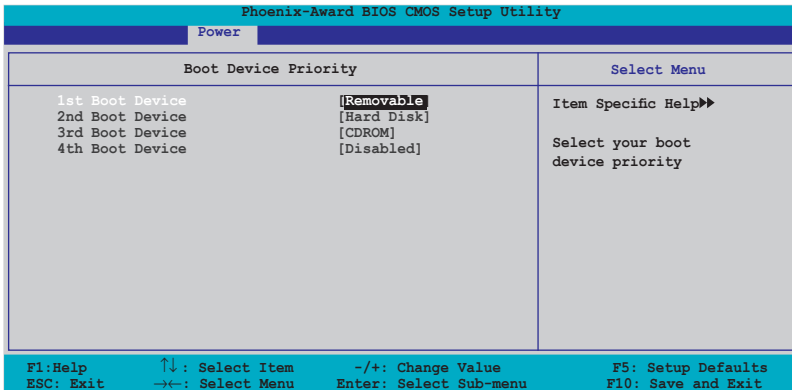

1st ~ xxth Boot Device [Removable]

These items specify the boot device priority sequence from the available devices. The number of device items that appears on the screen depends on the number of devices installed in the system.

Configuration options: [Removable] [Hard Disk] [CDROM] [Disabled]

4.6.2 Removable Drives

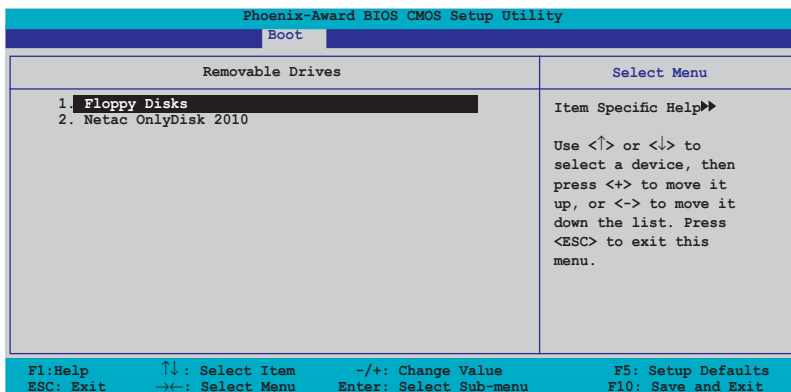

1. Floppy Disks

Allows you to assign a removable drive attached to the system.

2. Netac OnlyDisk 2010

Allows you to assign a removable drive attached to the system.

4.6.3 Boot Settings Configuration

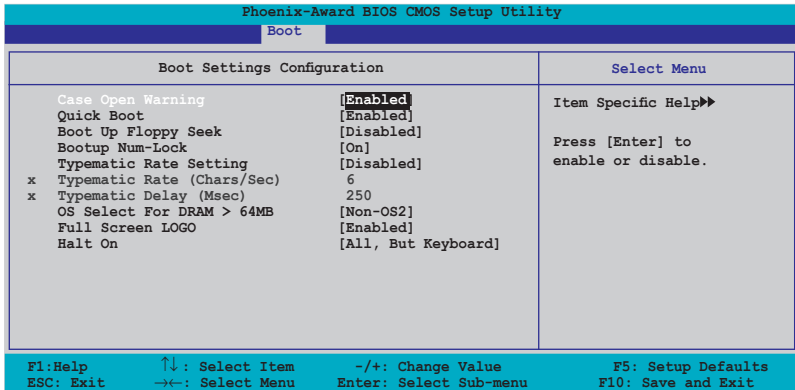

Case Open Warning [Enabled]

Enables or disables the chassis open status feature. Setting to Enabled, clears the chassis open status. Refer to section "2.7 Internal connectors" for setting details.

Configuration options: [Disabled] [Enabled]

Quick Boot [Enabled]

Allows you to enable or disable the system quick boot feature. When Enabled, the system skips certain tests while booting.

Configuration options: [Disabled] [Enabled]

Boot Up Floppy Seek [Disabled]

Enable this item to check for a boot floppy disk during POST.

Configuration options: [Disabled] [Enabled]

Bootup Num-Lock [On]

Allows you to select the power-on state for the NumLock.

Configuration options: [Off] [On]

Typematic Rate Setting [Disabled]

Allows you to set the keystroke rate. Enable this item to configure the Typematic Rate (Chars/Sec) and the Typematic Delay (Msec).

Configuration options: [Disabled] [Enabled]



The items Typematic Rate (Chars/Sec) and Typematic Delay (Msec) becomes user-configurable only when the item Typematic Rate Setting is enabled.

Typematic Rate (Chars/Sec) [6]

Allows you to select the rate at which a character repeats when you hold a key. Configuration options: [6] [8] [10] [12] [15] [20] [24] [30]

Typematic Delay (Msec) [250]

Allows you to set the delay before keystrokes begin to repeat.

Configuration options: [250] [500] [750] [1000]

OS Select for DRAM > 64MB [Non-OS2]

Set this item to OS2 only when you are running on an OS/2 operating system with an installed RAM of greater than 64 KB.

Configuration options: [Non-OS2] [OS2]

Full Screen LOGO [Enabled]

Allows you to enable or disable the full screen logo display feature.

Configuration options: [Disabled] [Enabled]



-
- Make sure that the above item is set to [Enabled] if you want to use the ASUS MyLogo2™ feature.
 - See section “5.4.1 ASUS MyLogo2™” for details.
-

Halt On [All, But Keyboard]

Allows you to error report type.

Configuration options: [All Errors] [No Errors] [All, But Keyboard]

[All, But Diskette] [All, But Disk/Key]

4.6.4 Security

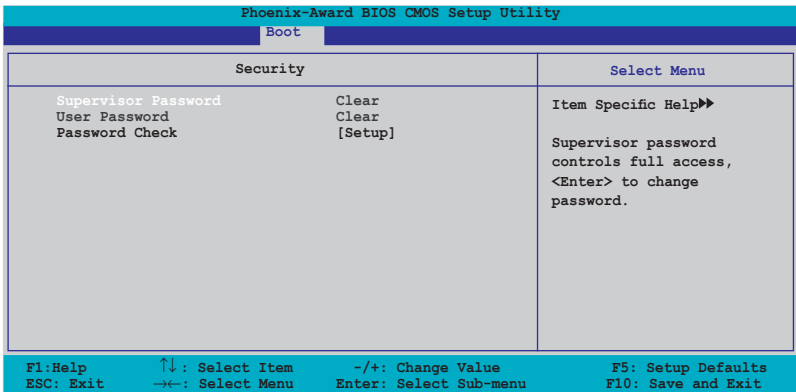

Supervisor Password User Password

These fields allow you to set passwords:

To set a password:

1. Select an item then press <Enter>.
2. Type in a password using a combination of a maximum of eight (8) alpha-numeric characters, then press <Enter>.
3. When prompted, confirm the password by typing the exact characters again, then press <Enter>. The password field setting is changed to Set.

To clear the password:

1. Select the password field and press <Enter> twice. The following message appears:



2. Press any key to continue. The password field setting is changed to Clear.

A note about passwords

The Supervisor password is required to enter the BIOS Setup program preventing unauthorized access. The User password is required to boot the system preventing unauthorized use.

Forgot your password?

If you forget your password, you can clear it by erasing the CMOS Real Time Clock (RTC) RAM. The RAM data containing the password information is powered by the onboard button cell battery. If you need to erase the CMOS RAM, refer to section “2.6 Jumpers” for instructions.

Password Check

This field requires you to enter the password before entering the BIOS setup or the system. Select [Setup] to require the password before entering the BIOS Setup. Select [System] to require the password before entering the system.

Configuration options: [Setup] [System]

4.7 Tools menu

The Tools menu items allow you to change the system boot options. Select an item then press <Enter> to display the sub-menu.

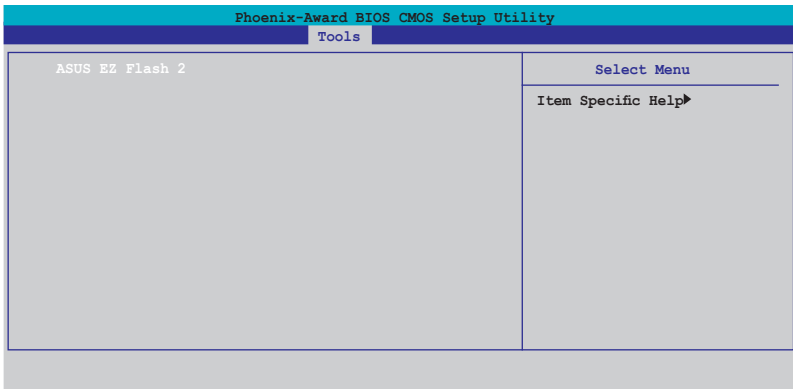

ASUS EZ Flash 2

Allows you to run ASUS EZ Flash 2. Press <Enter> to start EZ Flash 2 then from the confirmation screen, use the left or right arrows to select [Yes] or [No] then press <Enter>. See page 4-5 for details.

The following screen appears if you select [Yes]. Follow screen instructions to flash the BIOS.

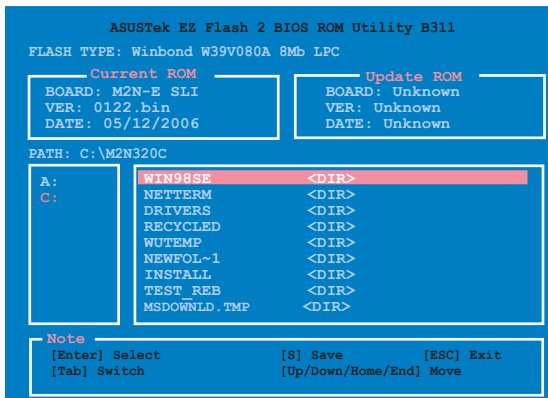

4.8 Exit menu

The Exit menu items allow you to load the optimal or failsafe default values for the BIOS items, and save or discard your changes to the BIOS items.

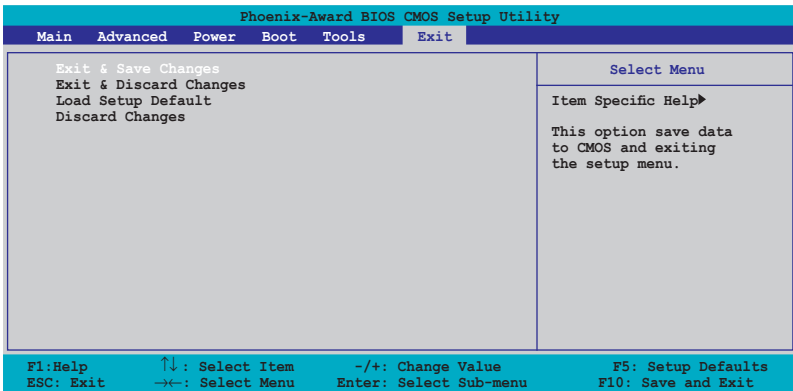

Pressing <Esc> does not immediately exit this menu. Select one of the options from this menu or <F10> from the legend bar to exit.

Exit & Save Changes

Once you are finished making your selections, choose this option from the Exit menu to ensure the values you selected are saved to the CMOS RAM. An onboard backup battery sustains the CMOS RAM so it stays on even when the PC is turned off. When you select this option, a confirmation window appears. Select **Yes** to save changes and exit.



If you attempt to exit the Setup program without saving your changes, the program prompts you with a message asking if you want to save your changes before exiting. Press <Enter> to save the changes while exiting.

Exit & Discard Changes

Select this option only if you do not want to save the changes that you made to the Setup program. If you made changes to fields other than System Date, System Time, and Password, the BIOS asks for a confirmation before exiting.

Load Setup Defaults

This option allows you to load the default values for each of the parameters on the Setup menus. When you select this option or if you press <F5>, a confirmation window appears. Select **Yes** to load default values. Select **Exit & Save Changes** or make other changes before saving the values to the non-volatile RAM.

Discard Changes

This option allows you to discard the selections you made and restore the previously saved values. After selecting this option, a confirmation appears. Select **Yes** to discard any changes and load the previously saved values.

This chapter describes the contents of the support CD that comes with the motherboard package.

5 Software support

Chapter summary

5.1	Installing an operating system.....	5-1
5.2	Support CD information	5-1
5.3	Software information	5-8
5.4	RAID configurations	5-16
5.5	Creating a RAID driver disk	5-25

5.1 Installing an operating system

This motherboard supports Windows® 2000/XP operating systems (OS). Always install the latest OS version and corresponding updates to maximize the features of your hardware.



- Motherboard settings and hardware options vary. Use the setup procedures presented in this chapter for reference only. Refer to your OS documentation for detailed information.
- Make sure that you install Windows® 2000 Service Pack 4 or the Windows® XP Service Pack 2 or later versions before installing the drivers for better compatibility and system stability.

5.2 Support CD information

The support CD that came with the motherboard package contains the drivers, software applications, and utilities that you can install to avail all motherboard features.



The contents of the support CD are subject to change at any time without notice. Visit the ASUS website(www.asus.com) for updates.

5.2.1 Running the support CD

Place the support CD to the optical drive. The CD automatically displays the Drivers menu if Autorun is enabled in your computer.



Click an icon to display support CD/motherboard information

Click an item to install



If Autorun is NOT enabled in your computer, browse the contents of the support CD to locate the file ASSETUP.EXE from the BIN folder. Double-click the ASSETUP.EXE to run the CD.

5.2.2 Drivers menu

The drivers menu shows the available device drivers if the system detects installed devices. Install the necessary drivers to activate the devices.



NVIDIA nForce Chipset Driver

Installs the NVIDIA® Chipset drivers for the NVIDIA® nForce® 500 SLI chipset.

C-Media CM6501 Audio Driver

Installs the C-Media CM6501 audio driver and application.

AMD Cool'n'Quiet Driver

Installs the AMD Cool 'n' Quiet! driver and application.

USB 2.0 Driver

Installs the Universal Serial Bus 2.0 (USB 2.0) driver.

5.2.3 Utilities menu

The Utilities menu shows the applications and other software that the motherboard supports.



ASUS PC Probe II

This smart utility monitors the fan speed, CPU temperature, and system voltages, and alerts you of any detected problems. This utility helps you keep your computer in healthy operating condition.

ASUS Update

Allows you to download the latest version of the BIOS from the ASUS website.



Before using the ASUS Update, make sure that you have an Internet connection so you can connect to the ASUS website.

ASUS AMD Cool 'n' Quiet Utility

Installs the AMD® Cool 'n' Quiet! software.

ADOBE Acrobat Reader V7.0

Installs the Adobe® Acrobat® Reader that allows you to open, view, and print documents in Portable Document Format (PDF).

Microsoft DirectX 9.0c

Installs the Microsoft® DirectX 9.0 driver. The Microsoft DirectX® 9.0 is a multimedia technology that enhances computer graphics and sound. DirectX® improves the multimedia features of your computer so you can enjoy watching TV and movies, capturing videos, or playing games in your computer. Visit the Microsoft website (www.microsoft.com) for updates.

Anti-virus Utility

The anti-virus application detects and protects your computer from viruses that destroys data.

5.2.4 Make Disk menu

The Make Disk menu contains items to create the NVIDIA® nForce® 500-SLI or Silicon Image SATA RAID driver disk.



Make NV SATA/RAID 32bit 2000 Driver

Make NV SATA/RAID 32bit XP Driver

Make NV SATA/RAID 32bit 2003 Driver

Allows you to create an NVIDIA® Serial ATA RAID driver disk for a 32-bit 2000/XP/2003 system.

Make NV SATA/RAID 64bit XP Driver Make NV SATA/RAID 64bit 2003 Driver

Allows you to create an NVIDIA® Serial ATA RAID driver disk for a 64-bit XP/2003 system.

5.2.5 Manuals menu

The Manuals menu contains a list of supplementary user manuals. Click an item to open the folder of the user manual.



- Most user manual files are in Portable Document Format (PDF). Install the Adobe® Acrobat® Reader from the Utilities menu before opening a user manual file.
- Some user manuals listed in this menu may not be applicable for this motherboard model.



NVIDIA RAID User's Guide

Allows you to open the NVIDIA® RAID User's Guide.

5.2.6 ASUS Contact information

Click the Contact tab to display the ASUS contact information. You can also find this information on the inside front cover of this user guide.



5.2.7 Other information

The icons on the top right corner of the screen give additional information on the motherboard and the contents of the support CD. Click an icon to display the specified information.

Motherboard Info

Displays the general specifications of the motherboard.



5.3 Software information

Most of the applications in the support CD have wizards that will conveniently guide you through the installation. View the online help or readme file that came with the software application for more information.

5.3.1 Cool 'n' Quiet!™ Technology

The motherboard supports the AMD Cool 'n' Quiet!™ Technology that dynamically and automatically change the CPU speed, voltage, and amount of power depending on the task the CPU performs.

Enabling Cool 'n' Quiet!™ Technology

To enable Cool 'n' Quiet!™ Technology:

1. Turn on the system and enter BIOS by pressing the key during the Power On Self-Tests (POST).
2. Go to Advanced -> CPU Configuration -> AMD Cool 'n'Quiet Function and set it to [Enabled]. See section "4.4 Advanced Menu."
3. Save your changes and exit BIOS Setup.
4. Reboot your computer and set your Power Option Properties depending on your operating system.

Windows® 2000/XP

1. From the Windows® 2000/XP operating system, click the Start button. Select Settings, then Control Panel.
2. Make sure the Control Panel is set to Classic View.
3. Double-click the Display icon in the Control Panel then select the Screen Saver tab.
4. Click the Power... button. The following dialog box appears.
5. From the Power schemes combo list box, select Minimal Power Management.
6. Click OK to effect settings.



Make sure to install the Cool 'n' Quiet!™ driver and application before using this feature.



- The AMD Cool 'n' Quiet!™ technology feature works only with the AMD heatsink and fan assembly with monitor chip
- If you purchased a separate heatsink and fan package, use the ASUS Q-Fan technology feature to automatically adjust the CPU fan speed according to your system loading.

Launching the Cool 'n' Quiet!™ software

The motherboard support CD includes the Cool 'n' Quiet!™ software that enables you to view your system's real-time CPU Frequency and voltage.



Make sure to install the Cool 'n' Quiet!™ software from the motherboard support CD. Refer to section "5.2.3 Utilities menu" for details.

To launch the Cool 'n' Quiet!™ program:

1. If you are using Windows® 2000, click the Start button. Select Programs-> ASUS -> Cool & Quiet -> Cool & Quiet.
2. If you are using Windows® XP, click the Start button. Select All Programs-> ASUS -> Cool & Quiet -> Cool & Quiet.
3. The Cool 'n' Quiet!™ technology screen appears and displays the current CPU Frequency and CPU Voltage.



5.3.2 ASUS PC Probe II

PC Probe II is a utility that monitors the computer's vital components, and detects and alerts you of any problem with these components. PC Probe II senses fan rotations, CPU temperature, and system voltages, among others. Because PC Probe II is software-based, you can start monitoring your computer the moment you turn it on. With this utility, you are assured that your computer is always at a healthy operating condition.

Installing PC Probe II

To install PC Probe II on your computer:

1. Place the support CD to the optical drive. The Drivers installation tab appears if your computer has an enabled Autorun feature.



If Autorun is not enabled in your computer, browse the contents of the support CD to locate the setup.exe file from the ASUS PC Probe II folder. Double-click the setup.exe file to start installation.

2. Click the Utilities tab, then click ASUS PC Probe II.
3. Follow the screen instructions to complete installation.

Launching PC Probe II

You can launch the PC Probe II right after installation or anytime from the Windows® desktop.

To launch the PC Probe II from the Windows® desktop, click Start > All Programs > ASUS > PC Probe II > PC Probe II v1.00.43. The PC Probe II main window appears.

After launching the application, the PC Probe II icon appears in the Windows® taskbar. Click this icon to close or restore the application.









Using PC Probe II

Main window

The PC Probe II main window allows you to view the current status of your system and change the utility configuration. By default, the main window displays the Preference section. You can close or restore the Preference section by clicking on the triangle on the main window right handle.



Click to close the Preference panel

Button	Function
	Opens the Configuration window
	Opens the Report window
	Opens the Desktop Management Interface window
	Opens the Peripheral Component Interconnect window
	Opens the Windows Management Instrumentation window
	Opens the hard disk drive, memory, CPU usage window
	Shows/Hides the Preference section
	Minimizes the application
	Closes the application

Sensor alert

When a system sensor detects a problem, the main window right handle turns red, as the illustrations below show.



When displayed, the monitor panel for that sensor also turns red. Refer to the Monitor panels section for details.

Preferences

You can customize the application using the Preference section in the main window. Click the box before each preference to activate or deactivate.

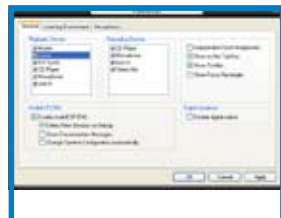

Hardware monitor panels

The hardware monitor panels display the current value of a system sensor such as fan rotation, CPU temperature, and voltages.

The hardware monitor panels come in two display modes: hexagonal (large) and rectangular (small). When you check the Enable Monitoring Panel option from the Preference section, the monitor panels appear on your computer's desktop.



Large display



Small display

Changing the monitor panels position

To change the position of the monitor panels in the desktop, click the arrow down button of the Scheme options, then select another position from the list box. Click OK when finished.



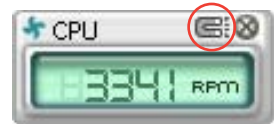

Moving the monitor panels

All monitor panels move together using a magnetic effect. If you want to detach a monitor panel from the group, click the horseshoe magnet icon. You can now move or reposition the panel independently.



Adjusting the sensor threshold value

You can adjust the sensor threshold value in the monitor panel by clicking the  or  buttons. You can also adjust the threshold values using the Config window.

You cannot adjust the sensor threshold values in a small monitoring panel.

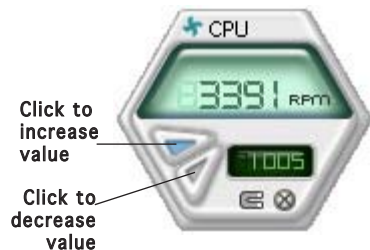

Monitoring sensor alert

The monitor panel turns red when a component value exceeds or is lower than the threshold value. Refer to the illustrations below.



Large display



Small display

WMI browser

Click **WMI** to display the WMI (Windows Management Instrumentation) browser. This browser displays various Windows® management information. Click an item from the left panel to display on the right panel. Click the plus sign (+) before WMI Information to display the available information.



You can enlarge or reduce the browser size by dragging the bottom right corner of the browser.

DMI browser

Click **DMI** to display the DMI (Desktop Management Interface) browser. This browser displays various desktop and system information. Click the plus sign (+) before DMI Information to display the available information.



PCI browser

Click **PCI** to display the PCI (Peripheral Component Interconnect) browser. This browser provides information on the PCI devices installed on your system. Click the plus sign (+) before the PCI Information item to display available information.

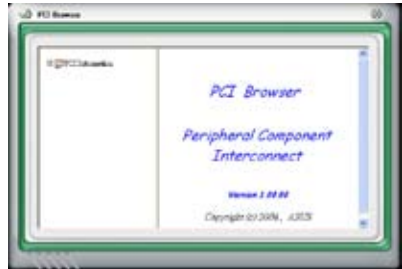

Usage

The Usage browser displays real-time information on the CPU, hard disk drive space, and memory usage. Click **USAGE** to display the Usage browser.

CPU usage

The CPU tab displays real-time CPU usage in line graph representation.



Hard disk drive space usage

The Hard Disk tab displays the used and available hard disk drive space. The left panel of the tab lists all logical drives. Click a hard disk drive to display the information on the right panel. The pie chart at the bottom of the window represents the used (blue) and the available HDD space.



Memory usage

The Memory tab shows both used and available physical memory. The pie chart at the bottom of the window represents the used (blue) and the available physical memory.



Configuring PC Probe II

Click **CONFIG** to view and adjust the sensor threshold values.

The Config window has two tabs: Sensor/Threshold and Preference. The Sensor/Threshold tab enables you to activate the sensors or to adjust the sensor threshold values. The Preference tab allows you to customize sensor alerts, or change the temperature scale.



Loads the default threshold values for each sensor

Applies your changes

Cancel or ignores your changes

Loads your saved configuration
Saves your configuration

5.4 RAID configurations

The motherboard comes with the NVIDIA® SLI Southbridge RAID controllers that allow you to configure IDE and Serial ATA hard disk drives as RAID sets. The motherboard supports the following RAID configurations.

RAID 0 (*Data striping*) optimizes two identical hard disk drives to read and write data in parallel, interleaved stacks. Two hard disks perform the same work as a single drive but at a sustained data transfer rate, double that of a single disk alone, thus improving data access and storage. Use of two new identical hard disk drives is required for this setup.

RAID 1 (*Data mirroring*) copies and maintains an identical image of data from one drive to a second drive. If one drive fails, the disk array management software directs all applications to the surviving drive as it contains a complete copy of the data in the other drive. This RAID configuration provides data protection and increases fault tolerance to the entire system. Use two new drives or use an existing drive and a new drive for this setup. The new drive must be of the same size or larger than the existing drive.

RAID 0+1 is *data striping* and *data mirroring* combined without parity (redundancy data) having to be calculated and written. With the RAID 0+1 configuration you get all the benefits of both RAID 0 and RAID 1 configurations. Use four new hard disk drives or use an existing drive and three new drives for this setup.

RAID 5 stripes both data and parity information across three or more hard disk drives. Among the advantages of RAID 5 configuration include better HDD performance, fault tolerance, and higher storage capacity. The RAID 5 configuration is best suited for transaction processing, relational database applications, enterprise resource planning, and other business systems. Use a minimum of three identical hard disk drives for this setup.

RAID 1+0 is a striped configuration with each stripe a RAID 1 array of drives. It combines the features of both RAID 1 and RAID 0. Fault tolerance is provided through *mirroring* while adding performance through *striping*. This offers higher performance than a RAID 1 configuration but at a much higher cost. A minimum of four hard disk drives is required for this setup.

JBOD (*Spanning*) stands for Just a Bunch of Disks and refers to hard disk drives that are not yet configured as a RAID set. This configuration stores the same data redundantly on multiple disks that appear as a single disk on the operating system. Spanning does not deliver any advantage over using separate disks independently and does not provide fault tolerance or other RAID performance benefits.



If you want to boot the system from a hard disk drive included in a RAID set, copy first the RAID driver from the support CD to a floppy disk before you install an operating system to a selected hard disk drive. Refer to section “5.6 Creating a RAID driver disk” for details.

5.4.1 Installing hard disks

The motherboard supports Ultra DMA /133/100/66 and Serial ATA hard disk drives. For optimal performance, install identical drives of the same model and capacity when creating a disk array.

Installing Parallel ATA hard disks

To install IDE hard disks for a RAID configuration:

1. Set the jumpers of each hard disk as Master/Master or Slave/Slave.
2. Install the hard disks into the drive bays.
3. Connect the HDD signal cables.
4. Connect a 4-pin power cable to the power connector on each drive.

Installing Serial ATA (SATA) hard disks

To install the SATA hard disks for a RAID configuration:

1. Install the SATA hard disks into the drive bays.
2. Connect the SATA signal cables.
3. Connect a SATA power cable to the power connector on each drive.



Refer to the RAID controllers user manual in the motherboard support CD for detailed information on RAID configurations. See section “5.2.4 Manuals menu”.

5.4.2 NVIDIA® RAID configurations

The motherboard includes a high performance IDE RAID controller integrated in the NVIDIA® SLI southbridge chipset. It supports RAID 0, RAID 1, RAID 0+1, and JBOD with four independent Serial ATA channels.

Setting the BIOS RAID items

After installing the hard disk drives, make sure to set the necessary RAID items in the BIOS before setting your RAID configuration.

To set the BIOS RAID items:

1. Boot the system and press during the Power-On Self-Test (POST) to enter the BIOS Setup Utility.
2. From the **Advanced > Onboard Devices Configuration > NVRAID Configuration** menu item in the BIOS set the RAID Enabled item to Enabled. The succeeding items become user-configurable.
3. Select and enable the IDE or SATA drive(s) that you want to configure as RAID. See section “5.4.3 Onboard Devices Configuration” for details.
4. Save your changes and Exit Setup.



For detailed descriptions on the NVIDIA® RAID configuration, refer to the “NVIDIA® RAID User’s Manual” found in your motherboard support CD.

Entering the NVIDIA® RAID utility

To enter the NVIDIA® RAID utility:

1. Boot up your computer.
2. During POST, press <F10> to display the main menu of the utility.



The RAID BIOS setup screens shown in this section are for reference only, and may not exactly match the items on your screen.

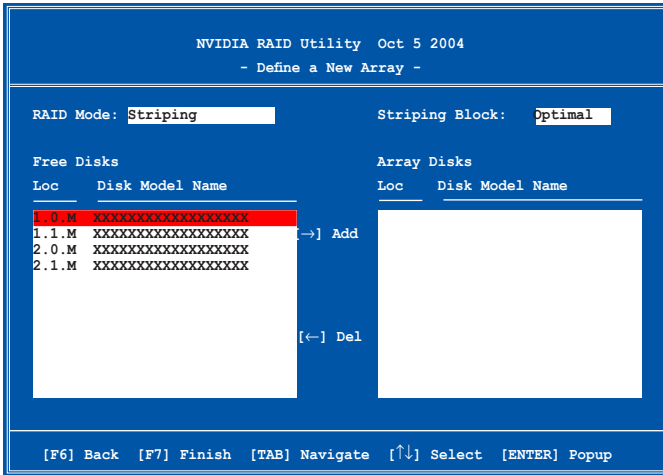

At the bottom of the screen are the navigation keys. These keys allow you to move through and select menu options.

Creating a RAID Volume

To create a RAID volume:

1. From the NVIDIA® RAID utility Define a New Array menu, select **RAID Mode** then press <Enter>. The following submenu appears.

Use the up or down arrow keys to select a RAID mode then press <Enter>.

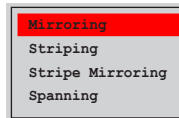

2. Press <TAB> select the Striping Block then press <Enter>. The following submenu appears:

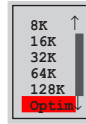

If you selected Striping or Stripe Mirroring, use the up or down arrow keys to select the stripe size for your RAID 0 array then press <Enter>. The available values range from 8 KB to 128 KB. The default selection is 128 KB. The strip value should be chosen based on the planned drive usage.

- 8 /16 KB - low disk usage
- 64 KB - typical disk usage
- 128 KB - performance disk usage



TIP: For server systems, we recommend using a lower array block size. For multimedia computer systems used mainly for audio and video editing, we recommend a higher array block size for optimum performance.

3. Press <TAB> to select the Free Disks area. Use the left or right arrow keys to assign the array disks.
4. Press <F7> to create RAID set. The following message box appears.

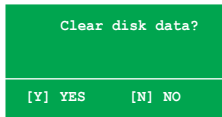

5. Press <Y> to clear the selected disks or <N> to proceed without clearing the disks. The following screen appears.



Take caution in using this option. All data on the RAID drives will be lost!

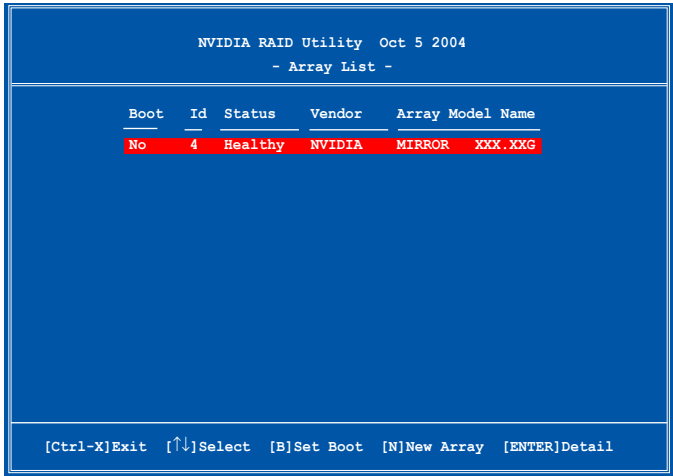

A new set of navigation keys is displayed on the bottom of the screen.

6. Press <Ctrl+X> to save settings and exit.

Rebuilding a RAID array

To rebuild a RAID array:

1. From the Array List menu, use the up or down arrow keys to select a RAID array then press <Enter>. The RAID Array details appear.

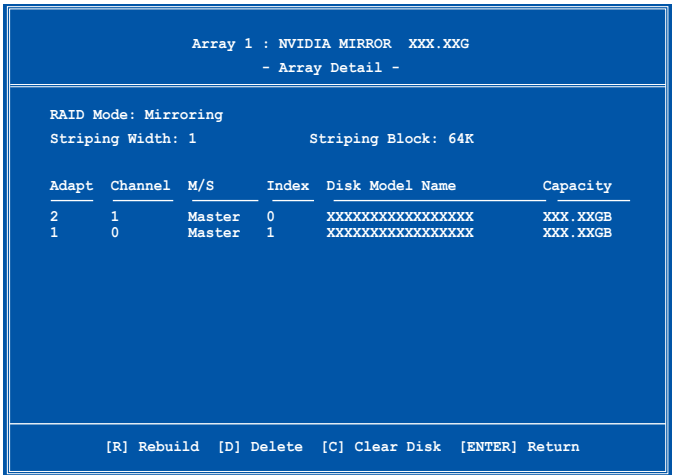

A new set of navigation keys is displayed on the bottom of the screen.

2. Press <R> to rebuild a RAID array. The following screen appears.

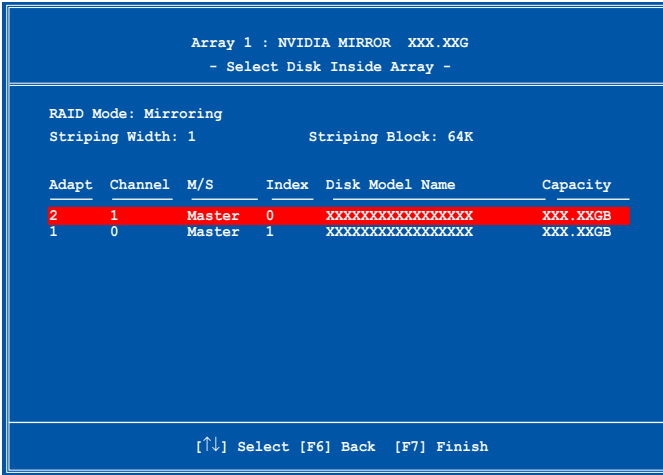

3. Use the up or down arrow keys to select a RAID array to rebuild, then press <F7>. The following confirmation message appears.

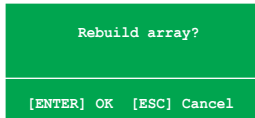

4. Press <Enter> to start rebuilding array or press <Esc> to cancel.
5. After the rebuild process, the Array list menu appears.

Deleting a RAID array

To delete a RAID array:

1. From the Array List menu, use the up or down arrow keys to select a RAID array then press <Enter>. The RAID Array details appear.

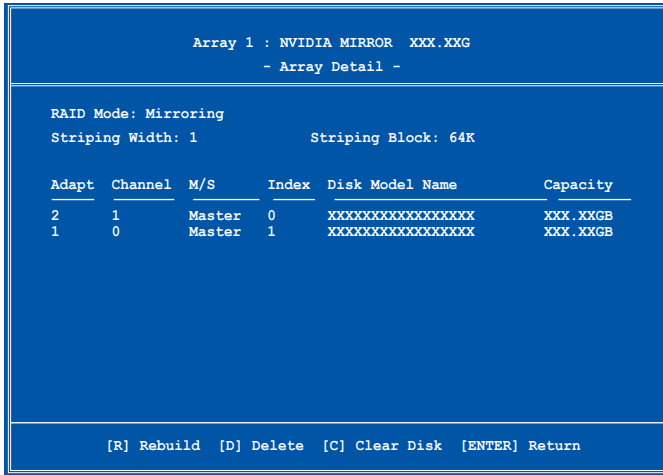

A new set of navigation keys is displayed on the bottom of the screen.

2. Press <D> to delete a RAID array. The following confirmation message appears.

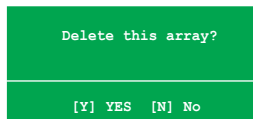

3. Press <Y> to delete array or press <N> to cancel.



Take caution in using this option. All data on the RAID drives will be lost!

4. If you selected Yes, the Define a New Array menu appears.

Clearing a disk data

To clear disk data:

1. From the Array List menu, use the up or down arrow keys to select a RAID array then press <Enter>. The RAID Array details appear.

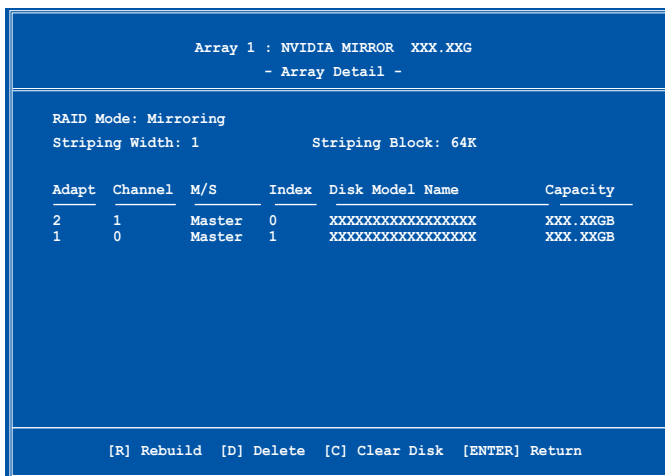

A new set of navigation keys is displayed on the bottom of the screen.

2. Press <C> to clear disk. The following confirmation message appears.

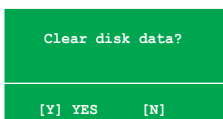

5. Press <Y> to clear the disk data or press <N> to cancel.



Take caution in using this option. All data on the RAID drives will be lost!

5.5 Creating a RAID driver disk

A floppy disk with the RAID driver is required when installing Windows® 2000/XP operating system on a hard disk drive that is included in a RAID set.

To create a RAID driver disk:

1. Place the motherboard support CD into the CD-ROM drive.
2. When the Drivers menu appears, select the RAID driver disk you want to create:
 - Click **Make NVIDIA RAID Driver** to create an NVIDIA® RAID driver disk.
 - Click **Make Silicon SATA RAID Driver Disk** to create a Silicon Image SATAraid™ RAID driver disk.

Or

Browse the contents of the support CD to locate the driver disk utility.

- Go to `\Drivers\Chipset\WINXP_2K\Driver_Disk` for the NVIDIA® RAID driver disk utility.
- Go to `\Drivers\Sil3114` for the Silicon Image RAID driver disk utility.



Refer to section “5.2.2 Drivers menu” for details.

4. Insert floppy disk to floppy disk drive.
5. Follow succeeding screen information to complete process.
6. Write-protect the floppy disk to avoid computer virus infection.

To install the RAID driver:

1. During the OS installation, the system prompts you to press the F6 key to install third-party SCSI or RAID driver.
2. Press <F6> then insert the floppy disk with RAID driver into the floppy disk drive.
3. Follow the succeeding screen instructions to complete the installation.



Due to chipset limitation, the Serial ATA ports supported by the NVIDIA chipset doesn't support Serial Optical Disk Drives (Serial ODD) under DOS.

This chapter tells how to install SLI-ready
PCI Express graphics cards.

NVIDIA® SLI™ **technology support**

Chapter summary

6.1	Overview	6-1
6.2	Dual graphics cards setup	6-2

6.1 Overview

The motherboard supports the NVIDIA® SLI™ (Scalable Link Interface) - Intel® Edition technology that allows you to install two identical PCI Express™ x16 graphics cards. Follow the installation procedures in this section.

Requirements

- You should have two identical SLI-ready graphics cards that are NVIDIA® certified.
- Make sure that your graphics card driver supports the NVIDIA SLI technology. Download the latest driver from the NVIDIA website (www.nvidia.com).
- Make sure that your power supply unit (PSU) can provide at least the minimum power required by your system. See “9. ATX power connectors” on page 2-28 for details.



-
- The NVIDIA SLI technology supports Windows® XP™ 32-bit/64bit operating system only.
 - Visit the NVIDIA zone website (<http://www.nzone.com>) for the latest certified graphics card and supported 3D application list.
-

6.2 Dual graphics card setup

6.2.1 Installing SLI-ready graphics cards



Install only identical SLI-ready graphics cards that are NVIDIA®-certified. Different types of graphics cards will not work together properly.

To install the graphics cards:

1. Prepare two graphics cards. Each graphics card should have goldfingers for the SLI connector.

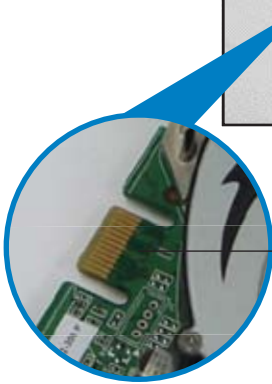

Goldfingers

2. Remove the metal bracket covers opposite the two PCI Express x16 slots.

3. Insert one graphics card into either the blue or black slot. Make sure that the card is properly seated on the slot.

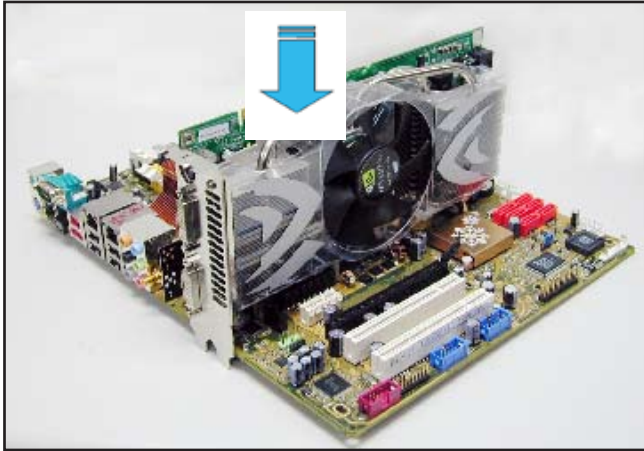

4. Insert the second graphics card into the other slot. Make sure that the card is properly seated on the slot.

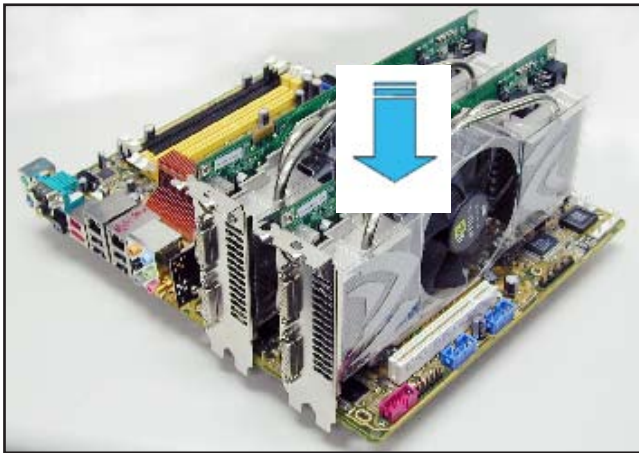

If required, connect an auxiliary power source to the PCI Express graphics cards.

5. Align and insert the SLI connector to the goldfingers on each graphics card. Make sure that the connector is firmly in place.

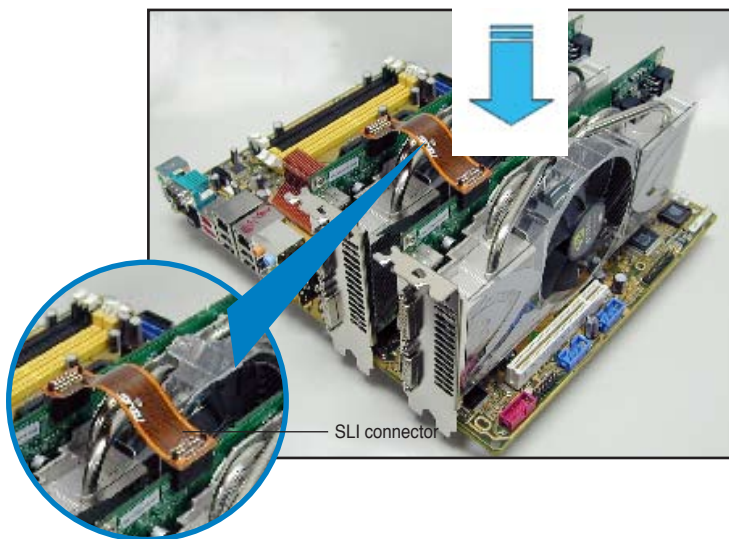

6. When installing two VGA cards using a 20-pin ATX PSU with sufficient+12v capability, we recommend that you connect the auxillary power source from the power supply to the graphics card. Refer to the PSU documentation for dual VGA power requirements.
7. Connect a VGA cable or a DVI-I cable to the graphics card/s.



We recommend to install an additional chassis fan for better thermal environment.

6.2.2 Installing the device drivers

Refer to the documentation that came with your graphics card package to install the device drivers.



Make sure that your PCI Express graphics card driver supports the NVIDIA SLI technology. Download the latest driver from the NVIDIA website (www.nvidia.com).

6.2.3 Enabling the multi-GPU feature in Windows®

After installing your graphics cards and the device drivers, enable the Multi-Graphics Processing Unit (GPU) feature in the NVIDIA nView properties.

To enable the multi-GPU feature:

1. Click the NVIDIA Settings icon on your Windows taskbar.



NVIDIA Settings icon

2. From the pop-up menu, select nView Desktop Manager then click nView Properties.



3. From the nView Desktop Manager window, select the Desktop Management tab.
4. Click Properties to display the Display Properties dialog box.



- From the Display Properties dialog box, select the Settings tab then click Advanced.



- Select the NVIDIA GeForce tab.

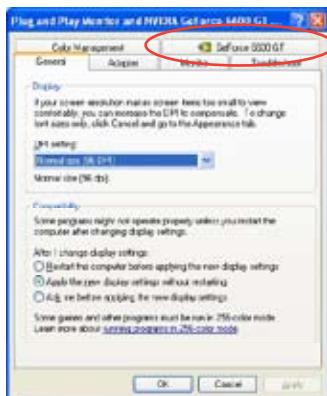

- Click the slider to display the following screen, then select the SLI multi-GPU item.

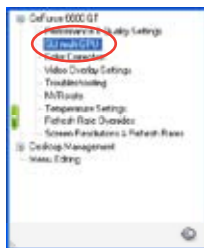

Slider



- Click the Enable SLI multi-GPU check box.
- Click OK when done.

Free Manuals Download Website

<http://myh66.com>

<http://usermanuals.us>

<http://www.somanuals.com>

<http://www.4manuals.cc>

<http://www.manual-lib.com>

<http://www.404manual.com>

<http://www.luxmanual.com>

<http://aubethermostatmanual.com>

Golf course search by state

<http://golfingnear.com>

Email search by domain

<http://emailbydomain.com>

Auto manuals search

<http://auto.somanuals.com>

TV manuals search

<http://tv.somanuals.com>