

# MAXIMUS VI GENE



# Motherboard

**Copyright © 2013 ASUSTeK COMPUTER INC. All Rights Reserved.**

No part of this manual, including the products and software described in it, may be reproduced, transmitted, transcribed, stored in a retrieval system, or translated into any language in any form or by any means, except documentation kept by the purchaser for backup purposes, without the express written permission of ASUSTeK COMPUTER INC. ("ASUS").

Product warranty or service will not be extended if: (1) the product is repaired, modified or altered, unless such repair, modification of alteration is authorized in writing by ASUS; or (2) the serial number of the product is defaced or missing.

ASUS PROVIDES THIS MANUAL "AS IS" WITHOUT WARRANTY OF ANY KIND, EITHER EXPRESS OR IMPLIED, INCLUDING BUT NOT LIMITED TO THE IMPLIED WARRANTIES OR CONDITIONS OF MERCHANTABILITY OR FITNESS FOR A PARTICULAR PURPOSE. IN NO EVENT SHALL ASUS, ITS DIRECTORS, OFFICERS, EMPLOYEES OR AGENTS BE LIABLE FOR ANY INDIRECT, SPECIAL, INCIDENTAL, OR CONSEQUENTIAL DAMAGES (INCLUDING DAMAGES FOR LOSS OF PROFITS, LOSS OF BUSINESS, LOSS OF USE OR DATA, INTERRUPTION OF BUSINESS AND THE LIKE), EVEN IF ASUS HAS BEEN ADVISED OF THE POSSIBILITY OF SUCH DAMAGES ARISING FROM ANY DEFECT OR ERROR IN THIS MANUAL OR PRODUCT.

SPECIFICATIONS AND INFORMATION CONTAINED IN THIS MANUAL ARE FURNISHED FOR INFORMATIONAL USE ONLY, AND ARE SUBJECT TO CHANGE AT ANY TIME WITHOUT NOTICE, AND SHOULD NOT BE CONSTRUED AS A COMMITMENT BY ASUS. ASUS ASSUMES NO RESPONSIBILITY OR LIABILITY FOR ANY ERRORS OR INACCURACIES THAT MAY APPEAR IN THIS MANUAL, INCLUDING THE PRODUCTS AND SOFTWARE DESCRIBED IN IT.

Products and corporate names appearing in this manual may or may not be registered trademarks or copyrights of their respective companies, and are used only for identification or explanation and to the owners' benefit, without intent to infringe.

**Offer to Provide Source Code of Certain Software**

This product contains copyrighted software that is licensed under the General Public License ("GPL"), under the Lesser General Public License Version ("LGPL") and/or other Free Open Source Software Licenses. Such software in this product is distributed without any warranty to the extent permitted by the applicable law. Copies of these licenses are included in this product.

Where the applicable license entitles you to the source code of such software and/or other additional data, you may obtain it for a period of three years after our last shipment of the product, either

(1) for free by downloading it from <http://support.asus.com/download>

or

(2) for the cost of reproduction and shipment, which is dependent on the preferred carrier and the location where you want to have it shipped to, by sending a request to:

ASUSTeK Computer Inc.  
Legal Compliance Dept.  
15 Li Te Rd.,  
Beitou, Taipei 112  
Taiwan

In your request please provide the name, model number and version, as stated in the About Box of the product for which you wish to obtain the corresponding source code and your contact details so that we can coordinate the terms and cost of shipment with you.

The source code will be distributed WITHOUT ANY WARRANTY and licensed under the same license as the corresponding binary/object code.

This offer is valid to anyone in receipt of this information.

ASUSTeK is eager to duly provide complete source code as required under various Free Open Source Software licenses. If however you encounter any problems in obtaining the full corresponding source code we would be much obliged if you give us a notification to the email address [gpl@asus.com](mailto:gpl@asus.com), stating the product and describing the problem (please DO NOT send large attachments such as source code archives, etc. to this email address).

# Contents

Safety information.....	vi
About this guide.....	vii
MAXIMUS VI GENE specifications summary.....	ix
Package contents.....	xiii
Installation tools and components.....	xiv
<b>Chapter 1: Product Introduction</b>	
<b>1.1 Special features.....</b>	<b>1-1</b>
1.1.1 Product highlights.....	1-1
1.1.2 ROG Gaming Features .....	1-2
1.1.3 ROG exclusive features .....	1-3
1.1.4 ASUS special features .....	1-4
1.1.5 ROG rich bundled software.....	1-4
<b>1.2 Motherboard overview.....</b>	<b>1-5</b>
1.2.1 Before you proceed.....	1-5
1.2.2 Motherboard layout.....	1-6
1.2.3 Central Processing Unit (CPU) .....	1-8
1.2.4 System memory .....	1-9
1.2.5 Expansion slots.....	1-25
1.2.6 Onboard buttons .....	1-27
1.2.7 Jumpers .....	1-29
1.2.8 Onboard LEDs .....	1-30
1.2.9 Internal connectors.....	1-39
1.2.10 Probelt.....	1-48
<b>Chapter 2: Basic Installation 2-1</b>	
<b>2.1 Building your PC system.....</b>	<b>2-1</b>
2.1.1 Motherboard installation.....	2-1
2.1.2 CPU installation.....	2-3
2.1.3 CPU heatsink and fan assembly installation .....	2-4
2.1.4 DIMM installation.....	2-6
2.1.5 ATX Power connection.....	2-7
2.1.6 SATA device connection.....	2-8
2.1.7 Front I/O Connector .....	2-9
2.1.8 Expansion Card installation.....	2-10
2.1.9 mPCIe Combo II installation.....	2-11

<b>2.2</b>	<b>BIOS update utility</b> .....	<b>2-17</b>
<b>2.3</b>	<b>Motherboard rear and audio connections</b> .....	<b>2-18</b>
	2.3.1 Rear I/O connection .....	2-18
	2.3.2 Audio I/O connections .....	2-19
<b>2.4</b>	<b>Starting up for the first time</b> .....	<b>2-23</b>
<b>2.5</b>	<b>Turning off the computer</b> .....	<b>2-23</b>

**Chapter 3: BIOS setup**

<b>3.1</b>	<b>Knowing BIOS</b> .....	<b>3-1</b>
<b>3.2</b>	<b>BIOS setup program</b> .....	<b>3-2</b>
	3.2.1 EZ Mode.....	3-3
	3.2.2 Advanced Mode .....	3-4
<b>3.3</b>	<b>My Favorites</b> .....	<b>3-6</b>
<b>3.4</b>	<b>Extreme Tweaker menu</b> .....	<b>3-7</b>
<b>3.5</b>	<b>Main menu</b> .....	<b>3-26</b>
<b>3.6</b>	<b>Advanced menu</b> .....	<b>3-28</b>
	3.6.1 CPU Configuration .....	3-29
	3.6.2 PCH Configuration .....	3-31
	3.6.3 SATA Configuration .....	3-33
	3.6.4 System Agent Configuration.....	3-34
	3.6.5 USB Configuration .....	3-36
	3.6.6 Platform Misc Configuration .....	3-37
	3.6.7 Onboard Devices Configuration.....	3-38
	3.6.8 APM .....	3-40
	3.6.9 Network Stack.....	3-41
	3.6.10 ROG Effects.....	3-41
<b>3.7</b>	<b>Monitor menu</b> .....	<b>3-42</b>
<b>3.8</b>	<b>Boot menu</b> .....	<b>3-45</b>
<b>3.9</b>	<b>Tools menu</b> .....	<b>3-50</b>
	3.9.1 ASUS EZ Flash 2 Utility .....	3-50
	3.9.2 ROG Secure Erase .....	3-50
	3.9.3 ASUS O.C. Profile.....	3-52
	3.9.3 ASUS SPD Information .....	3-53
	3.9.4 ROG OC Panel H-Key Configure.....	3-53
<b>3.10</b>	<b>Exit menu</b> .....	<b>3-55</b>
<b>3.11</b>	<b>Updating BIOS</b> .....	<b>3-56</b>
	3.11.1 EZ Update .....	3-56
	3.11.2 ASUS EZ Flash 2 .....	3-57
	3.11.3 ASUS CrashFree BIOS 3.....	3-58
	3.11.4 ASUS BIOS Updater.....	3-59



## **Chapter 4: Software support**

<b>4.1</b>	<b>Installing an operating system</b> .....	<b>4-1</b>
<b>4.2</b>	<b>Support DVD information</b> .....	<b>4-1</b>
4.2.1	Running the support DVD .....	4-1
4.2.2	Obtaining the software manuals .....	4-2
<b>4.3</b>	<b>Software information</b> .....	<b>4-3</b>
<b>4.4</b>	<b>AI Suite 3</b> .....	<b>4-3</b>
4.4.1	Dual Intelligent Processors 4 with 4-Way Optimization .....	4-6
4.4.2	EZ Update .....	4-13
4.4.3	USB 3.0 Boost .....	4-14
4.4.4	System Information .....	4-15
4.4.5	USB BIOS Flashback .....	4-17
4.4.6	Ai Charger+ .....	4-19
4.4.7	USB Charger+ .....	4-20
4.4.8	Audio configurations .....	4-21
<b>4.5</b>	<b>ROG Connect</b> .....	<b>4-22</b>
<b>4.6</b>	<b>MemTweakIt</b> .....	<b>4-24</b>
<b>4.7</b>	<b>RAMDisk</b> .....	<b>4-26</b>
<b>4.7</b>	<b>Sonic Radar</b> .....	<b>4-29</b>
4.7.1	Main menu .....	4-29
4.7.2	Game presets and Radar Selection .....	4-31
4.7.3	Advanced Settings .....	4-32
<b>4.8</b>	<b>Perfect Voice</b> .....	<b>4-34</b>

## **Chapter 5: RAID support**

<b>5.1</b>	<b>RAID configurations</b> .....	<b>5-1</b>
5.1.1	RAID definitions .....	5-1
5.1.2	Installing Serial ATA hard disks .....	5-2
5.1.3	Setting the RAID item in BIOS .....	5-2
5.1.4	Intel® Rapid Storage Technology Option ROM utility .....	5-3
<b>5.2</b>	<b>Creating a RAID driver disk</b> .....	<b>5-7</b>
5.2.1	Creating a RAID driver disk without entering the OS .....	5-7
5.2.2	Creating a RAID driver disk in Windows® .....	5-8
5.2.3	Installing the RAID driver during Windows® OS installation .....	5-8

## **Appendices**

<b>Notices</b> .....	<b>A-1</b>
<b>ASUS contact information</b> .....	<b>A-4</b>

## Safety information

### Electrical safety

- To prevent electrical shock hazard, disconnect the power cable from the electrical outlet before relocating the system.
- When adding or removing devices to or from the system, ensure that the power cables for the devices are unplugged before the signal cables are connected. If possible, disconnect all power cables from the existing system before you add a device.
- Before connecting or removing signal cables from the motherboard, ensure that all power cables are unplugged.
- Seek professional assistance before using an adapter or extension cord. These devices could interrupt the grounding circuit.
- Ensure that your power supply is set to the correct voltage in your area. If you are not sure about the voltage of the electrical outlet you are using, contact your local power company.
- If the power supply is broken, do not try to fix it by yourself. Contact a qualified service technician or your retailer.

### Operation safety

- Before installing the motherboard and adding devices on it, carefully read all the manuals that came with the package.
- Before using the product, ensure all cables are correctly connected and the power cables are not damaged. If you detect any damage, contact your dealer immediately.
- To avoid short circuits, keep paper clips, screws, and staples away from connectors, slots, sockets and circuitry.
- Avoid dust, humidity, and temperature extremes. Do not place the product in any area where it may become wet.
- Place the product on a stable surface.
- If you encounter technical problems with the product, contact a qualified service technician or your retailer.

## About this guide

This user guide contains the information you need when installing and configuring the motherboard.

## How this guide is organized

This guide contains the following parts:

- **Chapter 1: Product introduction**  
This chapter describes the features of the motherboard and the new technology it supports. It includes description of the switches, jumpers, and connectors on the motherboard.
- **Chapter 2: Basic Installation**  
This chapter lists the hardware setup procedures that you have to perform when installing system components.
- **Chapter 3: BIOS setup**  
This chapter tells how to change system settings through the BIOS Setup menus. Detailed descriptions of the BIOS parameters are also provided.
- **Chapter 4: Software support**  
This chapter describes the contents of the support DVD that comes with the motherboard package and the software.
- **Chapter 5: RAID support**  
This chapter describes the RAID configurations.

## Where to find more information

Refer to the following sources for additional information and for product and software updates.

1. **ASUS website**  
The ASUS website ([www.asus.com](http://www.asus.com)) provides updated information on ASUS hardware and software products.
2. **Optional documentation**  
Your product package may include optional documentation, such as warranty flyers, that may have been added by your dealer. These documents are not part of the standard package.

## Conventions used in this guide

To ensure that you perform certain tasks properly, take note of the following symbols used throughout this manual.



**DANGER/WARNING:** Information to prevent injury to yourself when trying to complete a task.



**CAUTION:** Information to prevent damage to the components when trying to complete a task



**IMPORTANT:** Instructions that you **MUST** follow to complete a task.



**NOTE:** Tips and additional information to help you complete a task.

## Typography

**Bold text**

Indicates a menu or an item to select.

*Italics*

Used to emphasize a word or a phrase.

<Key>

Keys enclosed in the less-than and greater-than sign means that you must press the enclosed key.

Example: <Enter> means that you must press the Enter or Return key.

<Key1> + <Key2> + <Key3>

If you must press two or more keys simultaneously, the key names are linked with a plus sign (+).

# MAXIMUS VI GENE specifications summary

CPU	<p>LGA1150 socket for the 4th Generation Intel® Core™ i7/Intel® Core™ i5/Intel® Core™ i3, Pentium®, and Celeron® processors</p> <p>Supports 22nm CPU</p> <p>Supports Intel® Turbo Boost Technology 2.0*</p> <p>* The Intel® Turbo Boost Technology 2.0 support depends on the CPU types.</p> <p>** Refer to <a href="http://www.asus.com">www.asus.com</a> for Intel CPU support list</p>
Chipset	Intel® Z87 Express Chipset
Memory	<p>Dual channel memory architecture</p> <p>4 x DIMM, max. 32GB, DDR3 3000 (O.C.) / 2800 (O.C.) / 2666 (O.C.) / 2600 (O.C.) / 2500 (O.C.) / 2400 (O.C.) / 2200 (O.C.) / 2133 (O.C.) / 2000 (O.C.) / 1866 (O.C.) / 1800 (O.C.) / 1600 / 1333 MHz, non-ECC, un-buffered memory</p> <p>Supports Intel® Extreme Memory Profile (XMP)</p> <p>* Hyper DIMM support is subject to the physical characteristics of individual CPUs.</p> <p>** Please refer to Memory QVL (Qualified Vendors List) for details.</p>
Expansion slots	<p>2 x PCI Express 3.0*/2.0 x16 slots (single at native x16, dual at x8/x8)</p> <p>1 x PCI Express 2.0 x4 slot</p> <p>1 x mini-PCI Express 2.0 x1 slot on mPCIe Combo II expansion card</p> <p>* PCIe 3.0 speed is supported by Intel® 4th generation Core™ Processors.</p>
VGA	<p><b>Integrated Intel® HD Graphics Processor</b></p> <p>HDMI with max. resolution of 4096 x 2160 @ 24Hz / 2560 x 1600 @ 60Hz</p> <p>Intel® InTru™ 3D, Intel® Quick Sync Video, Intel® Clear Video HD Technology, and Intel® Insider™</p>
Multi-GPU support	Support NVIDIA® SLI® Technology / AMD CrossFireX™ Technology
Storage	<p><b>Intel® Z87 Express Chipset:</b></p> <p>6 x SATA 6 Gb/s ports*</p> <ul style="list-style-type: none"> <li>- Intel® Rapid Storage Technology 12 supports RAID 0, 1, 5, and 10</li> <li>- Intel® Smart Response Technology, Intel® Rapid Start Technology, and Intel® Smart Connect Technology**</li> </ul> <p>1 x M.2 (NGFF) Socket 2 on mPCIe Combo II expansion card</p> <ul style="list-style-type: none"> <li>- Supports PCI Express 2.0 x1 and SATA 6Gb/s standard</li> <li>- Supports M.2 (NGFF) Type 2242 (22mm x 42mm) SSD card</li> </ul> <p><b>ASMedia® SATA 6Gb/s controller:</b></p> <p>2 x SATA 6 Gb/s ports ***</p> <p>* SATA 6Gb/s port 5 will be disabled when M.2 (NGFF) slot on mPCIe Combo II is in use.</p> <p>** The supported functions depend on the CPU installed.</p> <p>*** These SATA ports are for data hard drives only. ATAPI devices are not supported.</p>

(continued on the next page)

LAN	1 x Intel® I217-V Gigabit LAN Controller
Audio	<p><b>ROG SupremeFX Audio 8-Channel High Definition Audio</b></p> <ul style="list-style-type: none"> <li>- SupremeFX Shielding Technology</li> <li>- ELNA® Premium Audio Capacitors</li> <li>- Front DAC playback Signal-to-Noise Ratio (A-weighted, Differential output): 115 dB</li> <li>- ADC recording Signal-to-Noise Ratio (A-weighted): 104 dB</li> <li>- Content Protection for Full Rate lossless DVD Audio, Blu-ray DVD, and HD-DVD audio content playback</li> <li>- Jack-detection, Multi-streaming, Front Panel Jack-retasking</li> <li>- Optical S/PDIF out port at back panel</li> </ul> <p><b>Audio Feature:</b></p> <ul style="list-style-type: none"> <li>- Sonic Radar</li> <li>- DTS Connect</li> </ul>
USB	<p><b>Intel® Z87 Express Chipset</b></p> <p>4 x USB 3.0 ports (2 ports at back panel [blue], 2 ports at mid-board [red]*)</p> <p>8 x USB 2.0 ports (4 ports at back panel, 1 in front of for ROG Connect; 4 ports at mid-board**)</p> <p><b>ASMedia® USB 3.0 SuperSpeed USB HUB controller</b></p> <p>4 x USB 3.0 ports (4 ports at back panel [blue])</p> <p>* Supports ASUS USB3.0 Boost, UASP standard on the Intel® native USB 3.0 is only supported under Windows® 8.</p> <p>** 2 x USB2.0 ports at mid-board shares with ROG extension (ROG_EXT) port.</p>
Back I/O Ports	<p>1 x Clear CMOS button</p> <p>1 x ROG Connect button</p> <p>4 x USB 2.0 ports (1 port can be switched to ROG Connect)</p> <p>6 x USB 3.0 ports [blue]</p> <p>1 x LAN (RJ45) port</p> <p>1 x Optical S/PDIF out</p> <p>1 x HDMI port</p> <p>6 x Audio jacks</p>

*(continued on the next page)*

<p style="text-align: center;"><b>ROG Exclusive Features</b></p>	<p><b>mPCIe Combo II</b> (mPCIe/M.2 combo card)</p> <p><b>Extreme Engine Digi+ III</b></p> <ul style="list-style-type: none"> <li>- Full digital 8+2 phase CPU/DRAM power</li> <li>- NexFET™ Power Block MOSFET</li> <li>- 60A BlackWing Chokes</li> <li>- 10K Black Metallic Capacitors</li> </ul> <p><b>ROG GameFirst II</b></p> <p><b>ROG RAMDisk</b></p> <p><b>CPU Level Up</b></p> <p><b>ROG Connect*</b></p> <ul style="list-style-type: none"> <li>- RC Diagram</li> <li>- RC Remote</li> <li>- RC Poster</li> </ul> <p><b>UEFI BIOS features</b></p> <ul style="list-style-type: none"> <li>- Extreme Tweaker</li> <li>- Tweaker's Paradise</li> <li>- ROG SSD Secure Erase</li> <li>- BIOS Print</li> <li>- GPU.DIMM Post</li> <li>- O.C. Profile</li> <li>- ROG Pulse</li> </ul> <p><b>Probelt</b></p> <p>* The dedicated ROG Connect cable is purchased separately.</p>
	<p style="text-align: center;"><b>Special Features</b></p>

*(continued on the next page)*

<b>Internal Connectors</b>	<ul style="list-style-type: none"> <li>1 x USB 3.0 connector supports additional 2 USB 3.0 ports</li> <li>2 x USB 2.0 connectors support additional 4 USB 2.0 ports (1 connector shares with ROG_EXT header)</li> <li>1 x ROG Extension (ROG_EXT) header</li> <li>8 x SATA 6Gb/s connectors</li> <li>1 x 4-pin CPU fan connector</li> <li>1 x 4-pin CPU optional fan connector</li> <li>3 x 4-pin Chassis fan connectors</li> <li>1 x 24-pin EATX power connector</li> <li>1 x 8-pin EATX 12V Power connector</li> <li>10 x Probelts Measurement Points</li> <li>1 x LN2 Mode jumper</li> <li>1 x Power-on button</li> <li>1 x Reset button</li> <li>1 x MemOK! button</li> <li>1 x Directkey button</li> <li>1 x DRCT (DirectKey) header</li> <li>1 x S/PDIF out header</li> <li>1 x Front panel audio connector (AAFP)</li> <li>1 x System panel connector</li> <li>1 x TPM connector</li> <li>1 x mPCIe Combo II connector</li> </ul>
<b>BIOS Features</b>	64 Mb UEFI AMI BIOS, PnP, DMI 2.0, WfM 2.0, SM BIOS 2.5, ACPI 2.0a, Multi-language BIOS
<b>Manageability</b>	WfM2.0, DMI2.0, WOL by PME, PXE
<b>Software</b>	<ul style="list-style-type: none"> <li>Drivers</li> <li>ROG GameFirst II</li> <li>ROG RAMDisk</li> <li>ROG CPU-Z</li> <li>ROG Mem TweakIt</li> <li>Kaspersky® Anti-Virus</li> <li>DAEMON Tools Pro Standard</li> <li>ASUS WebStorage</li> <li>ASUS Utilities</li> </ul>
<b>Form Factor</b>	mATX Form Factor, 9.6" x 9.6" (24.4cm x 24.4cm)



Specifications are subject to change without notice.



## Package contents



Check your motherboard package for the following items.

Motherboard	ROG MAXIMUS VI GENE
Cables	3 x 2-in-1 SATA 6 Gb/s cables 1 x SLI® bridge
Accessories	I/O Shield 1 x mPCIe Combo II expansion card 1 x 12-in-1 ROG cable label 1 x 2-in-1 Q-Connector kit 1 x ROG Door Hanger
Application DVD	ROG motherboard support DVD
Documentation	User guide

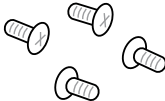

If any of the above items is damaged or missing, contact your retailer.

## Installation tools and components

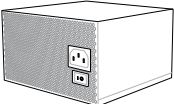
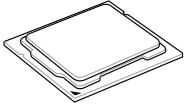
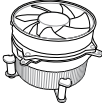
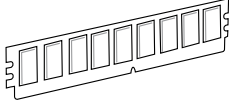
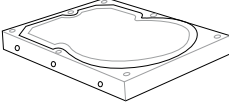
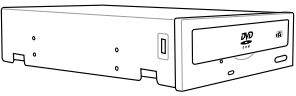
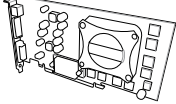
	
1 bag of screws	Phillips (cross) screwdriver
	
PC chassis	Power supply unit
	
Intel LGA 1150 CPU	Intel LGA 1150 compatible CPU Fan
	
DDR3 DIMM	SATA hard disk drive
	
SATA optical disc drive (optional)	Graphics card (optional)



The tools and components in the table above are not included in the motherboard package.

# Product introduction

# 1

## 1.1 Special features

### 1.1.1 Product highlights

#### Republic of Gamers

The Republic of Gamers offers you the best of the best. We offer the best hardware engineering, the fastest performance, the most innovative ideas, and we welcome the best gamers to join in. In the Republic of Gamers, mercy rules are only for the weak, and bragging rights means everything. We believe in making statements and we excel in competitions. If your character matches our trait, then join the elite Republic of Gamers and make your presence felt.

#### LGA1150 socket for 4th Generation Intel® Core™ i7 / Intel® Core™ i5 / Intel® Core™ i3, Pentium® and Celeron® Processors

This motherboard supports 4th generation Intel® Core™ i7/ Intel® Core™ i5/ Intel® Core™ i3, Pentium® and Celeron® processors in the LGA1150 package. It provides great graphics and system performance with its GPU, dual-channel DDR3 memory slots, and PCI Express 2.0/3.0 expansion slots.

#### Intel® Z87 Express Chipset

Intel® Z87 Express Chipset is a single-chipset that supports the LGA1150 socket 4th generation Intel® Core™ i7/ Intel® Core™ i5/ Intel® Core™ i3, Pentium® and Celeron® processors. It utilizes the serial point-to-point links, which increases bandwidth and enhances the system's performance. It natively supports up to six USB 3.0 ports for up to ten times faster transfer rate than USB 2.0, and enables the iGPU function for Intel® integrated graphics performance.

#### PCI Express® 3.0

PCI Express® 3.0 (PCIe 3.0) is the PCI Express bus standard that provides twice the performance and speed of PCIe 2.0. It provides an optimal graphics performance, unprecedented data speed, and seamless transition with its complete backward compatibility to PCIe 1.0/2.0 devices.

#### SLI®/CrossFire™ On-Demand

This motherboard features a unique PCIe 3.0 bridge chip to support multi-GPU SLI®/ CrossFireX™ graphics cards for an unrivaled gaming performance. With the Intel® Z87 platform to optimize the PCIe allocation of multiple GPUs, it supports up to 4-WAY GPU SLI® or CrossFireX™ configuration.

## 1.1.2 ROG Gaming Features

### SupremeFX

The re-engineered ROG-exclusive SupremeFX audio technology features an onboard 8-channel high-definition sound of true audiophile-grade performance that is equal in power, clarity, and range to dedicated sound cards. Its unique Red Line Shielding and special metallic cover provides pristine sound and a highly attractive look for the motherboard that is in keeping with the ROG style. The Japan-made premium ELNA capacitor ensures warm natural sound with exceptional clarity for all your gaming and multimedia activities. SupremeFX revolutionizes the way you hear games, movies, music, and even other people via chat - letting you rule and discover a totally whole new dimension of superior audio.

### Sonic Radar

Sonic Radar, an audio software designed for First Person Shooting (FPS) games, shows the precise direction and intensity of where a sound is coming from. In-game sound including gunshots, footprints, voice call-outs, or even a ticking bomb, is visualized as radar signals on the Sonic Radar display, providing you the advantage to know potential threats and avoid sneaky surprises.

### GameFirst II

ASUS GameFirst II, with cFOS Traffic Shaping technology, provides a powerful and user-friendly network control to easily frag your gaming system. Featuring the EZ Mode for beginners' setup and Advanced Mode for professionals' tweaking, your frags comes first.

### Intel Gigabit LAN

The LAN solution from Intel has been long known to have a better throughput, lower CPU utilization as well as better stability. With the Intel Gigabit LAN solutions onboard, the ultimate network experience can therefore be delivered to its users like never before.

## 1.1.3 ROG exclusive features

### mPCIe Combo II

The next evolution of the mPCIe Combo card gives you even better expandability with the latest standards in connectivity. You get mini PCI Express 2.0 plus USB 2.0, which is perfect for connecting Wi-Fi and Bluetooth modules to give your desktop instant wireless.

The compact but versatile card further future-proofs your build with M.2 (NGFF) connectivity for SSDs. M.2 is a fast and power-efficient standard that aims to replace mPCIe and mSATA, designed to optimize SSD performance. mPCIe Combo II works with your high speed M.2 SSDs and makes the most of their potential, helping you reduce load times to make your OS and games even faster.

### Extreme Engine Digi+ III

Extreme Engine Digi+ III offers you a hardcore power delivery for a challenging and extreme gaming enjoyment. It utilizes the best components such as NexFET™ Power Block MOSFETs, BlackWing chokes with special fin design, and super-premium 10K black metallic solid state capacitors. The NexFET™ Power Block MOSFETs combine great durability and up to 90% efficiency under normal operation. BlackWing chokes can handle as much as 60A of power, which is twice that of generic chokes. The special fin design, with its highly conductive and efficient gold-treated coating, results in 3-5°C lower choke temperatures for added stability and ensures minimal-loss power delivery. Super-premium 10K Black Metallic solid state capacitors are forged for overclocking and the most extreme demands, lasting up to five times longer than generic capacitors with 20% wider temperature tolerance.

### RAMDisk

RAMDisk is an innovative program that reserves a part of your system's memory and turns it into a high-speed virtual drive where you can store cache files and game apps for instant access. By optimizing your SSD, RAMDisk allows you to automatically backup, update, and restore files.



---

**NOTE:** RAMDisk only supports 64-bit operating systems.

---

### CPU Level Up

With ROG's CPU Level Up, overclocking has never been so easy, or cost-free. Simply select the processor that you want to overclock to, and the motherboard will do the rest.

### ROG Connect

ROG Connect allows you to monitor the status of your desktop PC and tweak its parameters in real-time via a notebook. ROG Connect links your main system to a notebook through a USB cable, allowing you to view real-time POST code and hardware status readouts on your notebook, as well as make on-the-fly parameter adjustments at a purely hardware level.



---

The The dedicated ROG Connect cable is purchased separately.

---

## 1.1.4 ASUS special features

### AI Suite 3

With its user-friendly interface, ASUS AI Suite 3 consolidates all the exclusive ASUS features into one simple-to-use software package. It allows you to supervise fan speed control, voltage and sensor readings. This all-in-one software offers diverse and ease to use functions, with no need to switch back and forth between different utilities.

### USB BIOS FlashBack

USB BIOS Flashback offers a hassle-free updating solution for your ultimate convenience. Simply install a USB storage device containing the BIOS file, press the BIOS Flashback button for three seconds, and the UEFI BIOS is automatically updated even without entering the existing the BIOS or operating system. It also allows you to regularly check for UEFI BIOS updates, and download the latest BIOS automatically.

## 1.1.5 ROG rich bundled software

### Kaspersky® Anti-Virus

Kaspersky® Anti-Virus Personal offers premium antivirus protection for individual users and home offices. It is based on advanced antivirus technologies. The product incorporates the Kaspersky® Anti-Virus engine, which is renowned for malicious program detection rates that are among the industry's highest.

### DAEMON Tools Pro Standard

DAEMON Tools Pro offers essential functionality to backup CD, DVD and Blu-ray discs. It converts optical media into virtual discs and emulates devices to work with the virtual copies. DAEMON Tools Pro organizes data, music, video, and photo collections on a PC, notebook, or netbook.

### ROG CPU-Z

ROG CPU-Z is a customized ROG version utility authorized by Intel's CPU Identification (CPUID) that allows you to gather information of the main devices of your system. It gives you the information and status of your CPU, motherboard, memory, and the whole component. Use the ROG look of reporting your system's current information with ROG CPU-Z.

### MemTweakIt

MemTweakIt is a DRAM efficiency tool that allows you to read DRAM timings and allows you to post and share your DRAM configuration scores to the ROG website.

### DTS Connect

To get the most out of your audio entertainment across all formats and quality levels, DTS Connect combines two enabling technologies. DTS Neo:PC™ upmixes stereo sources (CDs, MP3s, WMAs, internet radio) into as many as 7.1 channels of incredible surround sound. Consumers can connect their PC to a home theater system. DTS Interactive is capable of performing mult-channel encoding of DTS bitstreams on personal computers, and sending encoded bitstreams out of a digital audio connection (such as S/PDIF or HDMI) designed to deliver audio to an external decoder.

## 1.2 Motherboard overview

### 1.2.1 Before you proceed

Take note of the following precautions before you install motherboard components or change any motherboard settings.



- 
- Unplug the power cord from the wall socket before touching any component.
  - Before handling components, use a grounded wrist strap or touch a safely grounded object or a metal object, such as the power supply case, to avoid damaging them due to static electricity.
  - Hold components by the edges to avoid touching the ICs on them.
  - Whenever you uninstall any component, place it on a grounded antistatic pad or in the bag that came with the component.
  - Before you install or remove any component, ensure that the ATX power supply is switched off or the power cord is detached from the power supply. Failure to do so may cause severe damage to the motherboard, peripherals, or components.
-

## 1.2.2 Motherboard layout

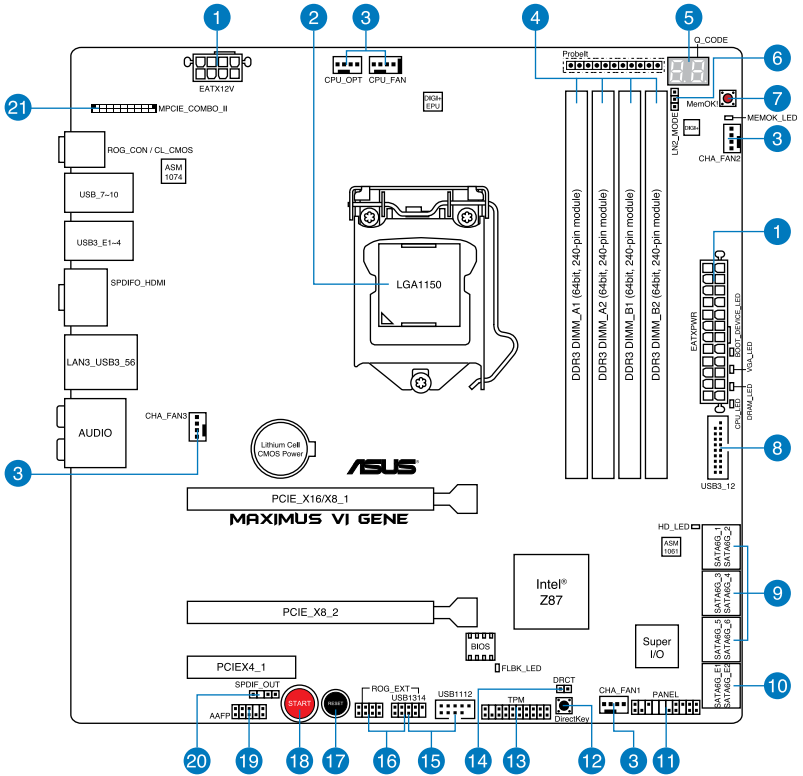

Refer to [1.2.9 Internal connectors](#) and [2.3.1 Rear I/O connection](#) for more information about rear panel connectors and internal connectors.



## Layout contents

Connectors/Jumpers/Buttons and switches/Slots	Page
1. ATX power connectors (24-pin EATXPWR; 8-pin EATX12V)	1-44
2. LGA1150 CPU Socket	1-8
3. CPU, chassis, and optional fan connectors (4-pin CPU_FAN; 4-pin CPU_OPT; 4-pin CHA_FAN1-3)	1-43
4. DDR3 DIMM slots	1-9
5. Q_Code LEDs	1-32
6. LN2 Mode jumper (3-pin LN2_MODE)	1-29
7. MemOK! button	1-28
8. USB 3.0 connectors (20-1 pin USB3_12)	1-40
9. Intel® Z87 Serial ATA 6 Gb/s connectors (7-pin SATA6G_1-6 [red])	1-39
10. ASMedia® Serial ATA 6 Gb/s connectors (7-pin SATA6G_E1/2 [red])	1-40
11. System panel connector (20-8 pin PANEL)	1-45
12. DirectKey button	1-45
13. TPM connector (20-1 pin TPM)	1-47
14. DirectKey connector (2-pin DRCT)	1-46
15. USB 2.0 connectors (10-1 pin USB1112; USB1314)	1-42
16. ROG Extension connector (18-1 pin ROG_EXT)	1-47
17. RESET button	1-27
18. START (Power-on) button	1-27
19. Front panel audio connector (10-1 pin AAFP)	1-41
20. Digital audio connector (4-1 pin SPDIF_OUT)	1-41
21. mPCIe Combo II connector (36-2-pin MPCIE_COMBO_II)	1-46

## 1.2.3 Central Processing Unit (CPU)

The motherboard comes with a surface mount LGA1150 socket designed for the 4th Generation Intel® Core™ i7 / Intel® Core™ i5 / Intel® Core™ i3, Pentium®, and Celeron® processors.

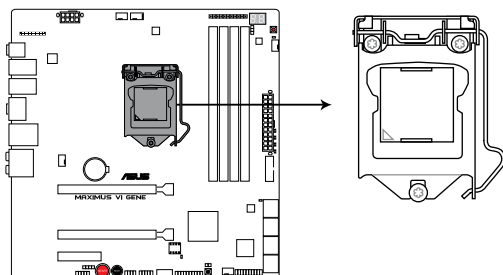

**MAXIMUS VI GENE CPU LGA1150**



- 
- **Ensure that all power cables are unplugged before installing the CPU.**
  - **Ensure that you install the correct CPU designed for LGA1150 only. DO NOT install a CPU designed for LGA1155 and LGA1156 sockets on the LGA1150 socket.**
  - **Upon purchase of the motherboard, ensure that the PnP cap is on the socket and the socket contacts are not bent. Contact your retailer immediately if the PnP cap is missing, or if you see any damage to the PnP cap/socket contacts/motherboard components. ASUS will shoulder the cost of repair only if the damage is shipment/transit-related.**
  - **Keep the cap after installing the motherboard. ASUS will process Return Merchandise Authorization (RMA) requests only if the motherboard comes with the cap on the LGA1150 socket.**
  - **The product warranty does not cover damage to the socket contacts resulting from incorrect CPU installation/removal, or misplacement/loss/incorrect removal of the PnP cap.**
-

## 1.2.4 System memory

The motherboard comes with four Double Data Rate 3 (DDR3) Dual Inline Memory Modules (DIMM) slots.



A DDR3 module is notched differently from a DDR or DDR2 module. DO NOT install a DDR or DDR2 memory module to the DDR3 slot.

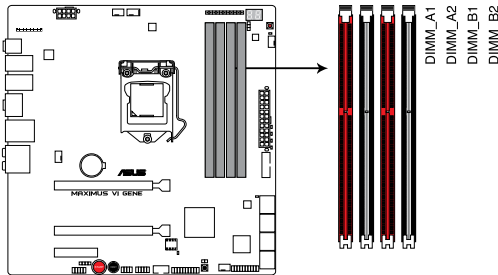

MAXIMUS VI GENE 240-pin DDR3 DIMM sockets

### Recommended memory configurations

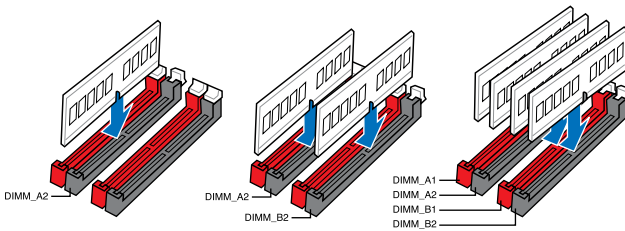

## Memory configurations

You may install 1GB, 2GB, 4GB and 8GB unbuffered and non-ECC DDR3 DIMMs into the DIMM sockets.



- 
- Memory module with memory frequency higher than 2133 MHz and its corresponding timing or the loaded XMP profile is not the JEDEC memory standard. The stability and compatibility of these memory modules depend on the CPU's capabilities and other installed devices.
  - You may install varying memory sizes in Channel A and Channel B. The system maps the total size of the lower-sized channel for the dual-channel configuration. Any excess memory from the higher-sized channel is then mapped for single-channel operation.
  - According to Intel CPU spec, DIMM voltage below 1.65V is recommended to protect the CPU.
  - Always install DIMMs with the same CAS latency. For optimal compatibility, we recommend that you install memory modules of the same version or date code (D/C) from the same vendor. Check with the retailer to get the correct memory modules.
  - Due to the memory address limitation on 32-bit Windows OS, when you install 4GB or more memory on the motherboard, the actual usable memory for the OS can be about 3GB or less. For effective use of memory, we recommend that you do any of the following:
    - a) Use a maximum of 3GB system memory if you are using a 32-bit Windows OS.
    - b) Install a 64-bit Windows OS when you want to install 4GB or more on the motherboard.
    - c) For more details, refer to the Microsoft® support site at <http://support.microsoft.com/kb/929605/en-us>.
  - This motherboard does not support DIMMs made up of 512Mb (64MB) chips or less (Memory chip capacity counts in Megabit, 8 Megabit/Mb = 1 Megabyte/MB).
- 



- 
- The default memory operation frequency is dependent on its Serial Presence Detect (SPD), which is the standard way of accessing information from a memory module. Under the default state, some memory modules for overclocking may operate at a lower frequency than the vendor-marked value. To operate at the vendor-marked or at a higher frequency, refer to section 3.4 **Extreme Tweaker menu** for manual memory frequency adjustment.
  - For system stability, use a more efficient memory cooling system to support a full memory load (4 DIMMs) or overclocking condition.
-

## MAXIMUS VI GENE Motherboard Qualified Vendors Lists (QVL)

### DDR3 3000 MHz capability

Vendors	Part No.	Size	SS/ DS	Chip Brand	Chip NO.	Timing	Voltage	DIMM socket support (Optional)	
								2	4
G.SKILL	F3-3000C12Q-16GTXDG	16GB ( 4x 4GB )	SS	-	-	12-14-14-35	1.65	•	•
CORSAIR	CML8GX3M2A3000C12R	8GB (2 x 4B )	SS			12-14-14-36	1.65	•	•

### DDR3 2800 MHz capability

Vendors	Part No.	Size	SS/ DS	Chip Brand	Chip NO.	Timing	Voltage	DIMM socket support (Optional)	
								2	4
AVEXIR	AVD3U28001204G-4CI	16GB ( 4x 4GB )	DS	-	-	12-14-14-35	1.65V	•	•
CORSAIR	CMD16GX3M4A2800C11	16GB ( 4x 4GB )	DS	-	-	11-14-14-35	1.65V	•	•
CORSAIR	CMD16GX3M4A2800C12	16GB ( 4x 4GB )	DS	-	-	12-14-14-36	1.65V	•	•
G.SKILL	F3-2800C11D-8GTXD	8GB ( 2x 4GB )	DS	-	-	11-13-13-35	1.65V	•	•
G.SKILL	F3-2800C11Q-16GTXD	16GB ( 4x 4GB )	DS	-	-	11-13-13-35	1.65V	•	•
G.SKILL	F3-2800C11D-8GTXDG	8GB ( 2x 4GB )	DS	-	-	11-14-14-35	1.65V	•	•
G.SKILL	F3-2800C11Q-16GTXDG	16GB ( 4x 4GB )	DS	-	-	11-13-13-35	1.65V	•	•
G.SKILL	F3-2800C12Q-32GTXXG	32GB ( 4 x 8GB )	DS	-	-	12-13-13-35	1.65V	•	•
G.SKILL	F3-2800C10D-8GBTXD	8GB ( 2x 4GB )	DS	-	-	10-13-13-35	1.65V	•	•

### DDR3 2666 MHz capability

Vendors	Part No.	Size	SS/ DS	Chip Brand	Chip NO.	Timing	Voltage	DIMM socket support (Optional)	
								2	4
Apacer	78.BAGFF.AFC0C(XMP)	8GB ( 2x 4GB )	DS	-	-	12-13-13-35	-	•	•
Apacer	78.BAGFR.AFD0C(XMP)	8GB ( 2x 4GB )	DS	-	-	12-13-13-35	-	•	•
Apacer	78.CAGFF.AFD0C(XMP)	16GB ( 2x 8GB )	DS	-	-	12-13-13-35	-	•	•
G.SKILL	F3-2666C11Q-32GTXD(XMP)	32GB ( 4x 8GB )	DS	-	-	-	1.65	•	•
G.SKILL	F3-2666CL10Q-16GBZHD(XMP)	16GB ( 4x 4GB )	DS	-	-	10-12-12-31	1.65	•	•
GEIL	GOC332GB2666C11QC(XMP)	32GB ( 4x 8GB )	DS	-	-	11-13-13-32	1.65	•	•
Team	TXD34G2666HC11CBK(XMP)	8GB ( 2x 4GB )	SS	-	-	11-13-13-35	1.65	•	•
Team	TXD38G2666HC11CBK(XMP)	16GB ( 2x 8GB )	DS	-	-	11-13-13-35	1.65	•	•

### DDR3 2600 MHz capability

Vendors	Part No.	Size	SS/ DS	Chip Brand	Chip NO.	Timing	Voltage	DIMM socket support (Optional)	
								2	4
A-DATA	AX3U2600GW8G11(XMP)	16GB ( 2x 8GB )	DS	-	-	11-13-13-35	1.65	•	•

## DDR3 2500 MHz capability

Vendors	Part No.	Size	SS/DS	Chip Brand	Chip NO.	Timing	Voltage	DIMM socket support (Optional)	
								2	4
G.SKILL	F3-20000CL10Q-16GBZHD(XMP)	16GB (4x 4GB)	DS	-	-	10-11-11-31	1.65	•	•

## DDR3 2400 MHz capability

Vendors	Part No.	Size	SS/DS	Chip Brand	Chip NO.	Timing	Voltage	DIMM socket support (Optional)	
								2	4
A-DATA	AX3U2400GC4G10 (XMP)	4GB	DS	-	-	10-12-12-31	1.65	•	•
A-DATA	AX3U2400GW8G11 (XMP)	16GB (2x 8GB)	DS	-	-	11-13-13-35	1.65	•	•
Apacer	78.BAGFL.AFD0C (XMP)	8GB (2x 4GB)	DS	-	-	11-12-12-30	-	•	•
Apacer	783BAGF3.AFD0C (XMP)	8GB (2x 4GB)	DS	-	-	11-11-11-30	-	•	•
CORSAIR	CMGTX8(XMP)	8GB (4x 2GB)	SS	-	-	10-12-10-30	1.65	•	•
CORSAIR	CMZ16GX3M2A2400C10 (Ver4.21)	16GB (2x 8GB)	DS	-	-	10-12-12-31	1.65	•	•
CORSAIR	CMZ16GX3M4A2400C9R (Ver4.13)(XMP)	16GB (4x 4GB)	DS	-	-	2400 9-11-11-31	1.65	•	•
G.SKILL	F3-19200CL10Q-32GBZHD (XMP)	32GB (4x 8GB)	DS	-	-	10-12-12-31	1.65	•	•
G.SKILL	F3-19200CL11Q-16GBZHD (XMP)	16GB (4x 4GB)	DS	-	-	11-11-11-31	1.65	•	•
G.SKILL	F3-19200CL11Q-16GBZHD (XMP)	16GB (4x 4GB)	DS	-	-	11-11-11-31	1.65	•	•
G.SKILL	F3-19200CL9D-4GBPIS (XMP)	4G (2x 2G)	DS	-	-	9-11-9-28	1.65	•	•
G.SKILL	F3-19200CL9Q-16GBZMD (XMP)	16GB (4x 4GB)	DS	-	-	9-11-11-31	1.65	•	•
GEIL	GOC316GB2400C10QC (XMP)	16GB (4x 4GB)	DS	-	-	10-11-11-30	1.65	•	•
GEIL	GOC316GB2400C11QC (XMP)	16GB (4x 4GB)	DS	-	-	11-11-11-30	1.65	•	•
Kingston	KHX2400C11D3K4/8GX (XMP)	8GB (4x 2GB)	SS	-	-	11-13-11-30	1.65	•	•
KINGSTON	KHX24C11K4/16X (XMP)	16GB (4x 4GB)	DS	-	-	11-13-13-30	1.65	•	•
KINGSTON	KHX24C11T2K2/8X (XMP)	8GB (2x 4GB)	DS	-	-	-	1.65	•	•
KINGSTON	KHX24C11T3K4/32X (XMP)	32GB (4x 8GB)	DS	-	-	9-9-9-24	1.65	•	•
Patriot	PVV34G2400C9K (XMP)	4GB (2x 2GB)	DS	-	-	9-11-9-27	1.66	•	•
Patriot	PXD38G2400C11K (XMP)	8GB (2x 4GB)	DS	-	-	11-11-11-30	1.65	•	•
Patriot	PXD38G2400C11K (XMP)	8GB (2x 4GB)	DS	-	-	2400 11-11-30	1.65	•	•
Team	TXD38G2400HC10QBK (XMP)	8GB	DS	-	-	10-12-12-31	1.65	•	•

## DDR3 2200 MHz capability

Vendors	Part No.	Size	SS/DS	Chip Brand	Chip NO.	Timing	Voltage	DIMM socket support (Optional)	
								2	4
G.SKILL	F3-17600CL7D-4GBFLS(XMP)	4G (2x 2G)	DS	-	-	7-10-10-28	1.65	•	
GEIL	GET34GB2200C9DC(XMP)	4GB (2x 2GB)	DS	-	-	9-10-9-28	1.65	•	•
GEIL	GET38GB2200C9ADC(XMP)	8GB (2x 4GB)	SS	-	-	9-11-9-28	1.65	•	
KINGMAX	FLKE85F-B8KJAA-FEIS(XMP)	4GB (2x 2GB)	DS	Kingmax	N/A	-	-	•	

## DDR3 2133 MHz capability

Vendors	Part No.	Size	SS/DS	Chip Brand	Chip NO.	Timing	Voltage	DIMM socket support (Optional)	
								2	4
A-DATA	AX3U2133XC4G10(XMP)	4GB	DS	-	-	10-11-11-30	1.65	•	•
A-DATA	AX3U2133XW8G10(XMP)	16GB (2x8GB)	DS	-	-	10-11-11-30	1.65	•	•
A-DATA	AX3U2133XW8G10(XMP)	8GB	DS	-	-	10-11-11-30	1.65	•	•
Apacer	78.BAGE4.AFD0C(XMP)	8GB (2x4GB)	DS	-	-	9-9-9-24	-	•	•
Apacer	AHU04GFB33CAQ3R(XMP)	4GB	DS	-	-	11-13-13-31	-	•	•
CORSAIR	CMD8GX3M2A2133C9 (Ver1.5)(XMP)	8GB (2x4GB)	DS	-	-	9-11-10-27	1.5	•	
CORSAIR	CMT4GX3M2B2133C9 (Ver7.1)(XMP)	4GB (2x2GB)	DS	-	-	9-10-9-27	1.5	•	•
CORSAIR	CMT4GX3M2B2133C9 (XMP)	4GB (2x2GB)	DS	-	-	9-10-9-27	1.5	•	•
G.SKILL	F3-17000CL11Q2-64GBZLD (XMP)	64GB (8x8GB)	DS	-	-	11-11-11-30	1.5	•	•
G.SKILL	F3-17000CL9Q-16GBXLD (XMP)	16GB (4x4GB)	DS	-	-	9-11-9-28	1.65	•	•
G.SKILL	F3-17000CL9Q-16GBZH (XMP)	16GB (4x4GB)	DS	-	-	9-11-10-28	1.65	•	•
G.SKILL	F3-17066CL9D-8GBPID (XMP)	8GB (2x4GB)	DS	-	-	9-9-9-24	1.65	•	•
G.SKILL	F3-2133C11Q-32GZL (XMP)	32GB (4x8GB)	DS	-	-	11-11-11-31	1.5	•	•
KINGSTON	KHX2133C11D3K4/16GX (XMP)	16GB (4x4GB)	DS	-	-	11-12-11-30	1.65	•	•
KINGSTON	KHX21C11T3FK8/64X (XMP)	64GB (8x8GB)	DS	-	-	9-9-9-24	1.5	•	•
Patriot	PV316G213C1K (XMP)	16GB (2x8GB)	DS	-	-	11-11-11-30	1.5	•	•
Patriot	PVV34G2133C9K (XMP)	4GB (2x2GB)	DS	-	-	9-11-9-27	1.66	•	•

(continued on the next page)

## DDR3 2133 MHz capability

Vendors	Part No.	Size	SS/DS	Chip Brand	Chip NO.	Timing	Voltage	DIMM socket support (Optional)	
								2	4
Patriot	PXD38G2133C11K(XMP)	8GB (2x4GB)	DS	-	-	9-9-9-24	1.65	•	•
Patriot	PXD38G2133C11K (XMP)	8GB (2x4GB)	DS	-	-	2133 11-11-11-27	1.5	•	•
Team	TLD38G2133HC11ABK (XMP)	8GB	DS	-	-	11-11-11-31	1.65	•	•
Team	TXD34096M2133HC11A-V (XMP)	4GB	DS	-	-	11-11-11-31	1.65	•	•

## DDR3 2000 MHz capability

Vendors	Part No.	Size	SS/DS	Chip Brand	Chip NO.	Timing	Voltage	DIMM socket support (Optional)	
								2	4
AEXEA	AXA3ES2G2000LG28V (XMP)	2GB	DS	-	-	-	1.65	•	•
AEXEA	AXA3ES4GK2000LG28V (XMP)	4GB (2x2GB)	DS	-	-	-	1.65	•	•
Apacer	78.AAGD5.9KD (XMP)	6GB (3x2GB)	DS	-	-	9-9-9-27	-	•	•
Asint	SLA302G08-ML2HB (XMP)	4GB	DS	Hynix	H5TQ2G83BFRH9C	9-9-9-27	-	•	•
G.SKILL	F3-16000CL9D-4GBRH (XMP)	4GB (2x2GB)	DS	-	-	9-9-9-24	1.65	•	•
G.SKILL	F3-16000CL9D-4GBTD (XMP)	4GB (2x2GB)	DS	-	-	9-9-9-24	1.65	•	•
GEIL	GUP34GB2000C9DC (XMP)	4GB (2x2GB)	DS	-	-	9-9-9-28	1.65	•	•
Patriot	PV736G2000ELK (XMP)	6GB (3x2GB)	DS	-	-	7-7-7-20	1.65	•	•
Patriot	PX7312G2000ELK (XMP)	12GB (3x4GB)	DS	-	-	9-11-9-27	1.65	•	•
Silicon Power	SP002GBLYU200S02 (XMP)	2GB	DS	-	-	-	-	•	•
Team	TXD32048M2000C9-L (XMP)	2GB	DS	Team	T3D1288LT-20	9-9-9-24	1.5	•	•
Team	TXD32048M2000C9-L (XMP)	2GB	DS	Team	T3D1288RT-20	9-9-9-24	1.6	•	•



## DDR3 1866 MHz capability

Vendors	Part No.	Size	SS/ DS	Chip Brand	Chip NO.	Timing	Voltage	DIMM socket support (Optional)	
								2	4
A-DATA	AX3U1866XW8G10(XMP)	16GB (2x8GB)	DS	-	-	10-11-10-30	1.5	•	•
CORSAIR	CMD16GX3M2A1866C9 (Ver5.29)(XMP)	16GB (2x8GB)	DS	-	-	1866 9-9-9-27	1.5	•	
CORSAIR	CMD16GX3M4A1866C9 (Ver4.13)(XMP)	16GB (4x4GB)	DS	-	-	9-10-9-27	1.5	•	•
CORSAIR	CMD16GX3M4A1866C9 (Ver8.16)(XMP)	16GB (4x4GB)	DS	-	-	9-10-9-27	1.5	•	•
CORSAIR	CMD8GX3M2A1866C9 (Ver4.13)(XMP)	8GB (2x4GB)	DS	-	-	-	1.5	•	•
CORSAIR	CMD8GX3M2A1866C9 (Ver5.12)(XMP)	8GB (2x4GB)	DS	-	-	9-10-9-27	1.5	•	
CORSAIR	CMD8GX3M2A1866C9 (Ver8.16)(XMP)	8GB (2x4GB)	DS	-	-	9-10-9-27	1.5	•	
CORSAIR	CMT32GX3M4X1866C9(Ver3. 23)(XMP)	32GB (4x8GB)	DS	-	-	9-10-9-27	1.5	•	•
CORSAIR	CMZ16GX3M4X1866C9R (Ver8.16)(XMP)	16GB (4x4GB)	DS	-	-	9-10-9-27	1.5	•	
CORSAIR	CMZ16GX3M4X1866C9R(Ver 8.16)(XMP)	16GB (4x4GB)	DS	-	-	9-10-9-27	1.5	•	•
CORSAIR	CMZ32GX3M4X1866C10 (Ver3.23)(XMP)	32GB (4x8GB)	DS	-	-	10-11-10-27	1.5	•	•
CORSAIR	CMZ32GX3M4X1866C10(Ver3. 23)(XMP)	32GB (4x8GB)	DS	-	-	10-11-10-27	1.5	•	•
CORSAIR	CMZ8GX3M2A1866C9 (Ver8.16)(XMP)	8GB (2x4GB)	DS	-	-	9-10-9-27	1.5	•	•
CORSAIR	CMZ8GX3M2A1866C9(XMP)	8GB (2x4GB)	DS	-	-	9-10-9-27	1.5	•	
CORSAIR	CMZ8GX3M2A1866C9G (Ver5.12)(XMP)	8GB (2x4GB)	DS	-	-	1866 9-10-9-27	1.5	•	•
Crucial	BLE4G3D1869DE1XT0.16FMD (XMP)	4GB	DS	-	-	9-9-9-27	1.5	•	•
G.SKILL	F3-14900CL10Q2-64GBZLD (XMP)	64GB (8x8GB)	DS	-	-	10-11-10-30	1.5	•	•
G.SKILL	F3-14900CL9D-8GBSR (XMP)	8GB (2x4GB)	DS	-	-	9-10-9-28	1.5	•	•
G.SKILL	F3-14900CL9Q-16GBXL (XMP)	16GB (4x4GB)	DS	-	-	9-10-9-28	1.5	•	•
G.SKILL	F3-14900CL9Q-16GBZL (XMP)	16GB (4x4GB)	DS	-	-	9-10-9-28	1.5	•	•
G.SKILL	F3-14900CL9Q-8GBFLD (XMP)	8GB (2x4GB)	DS	-	-	9-9-9-24	1.6	•	•
G.SKILL	F3-1866C9Q-32GX (XMP)	32GB (4x8GB)	DS	-	-	9-10-9-28	1.5	•	•
KINGSTON	KHX1866C9D3K2/8GX (XMP)	8GB (2x4GB)	DS	-	-	-	1.65	•	•

(continued on the next page)

## DDR3 1866 MHz capability

Vendors	Part No.	Size	SS/ DS	Chip Brand	Chip NO.	Timing	Voltage	DIMM socket support (Optional)	
								2	4
Patriot	PXD34G1866ELK (XMP)	4GB (2x2GB)	SS	-	-	9-9-9-24	1.65	•	
Patriot	PXD38G1866ELK (XMP)	8GB (2x4GB)	DS	-	-	9-11-9-27	1.65	•	•
Patriot	PXD38G1866ELK (XMP)	8GB (2x4GB)	DS	-	-	9-11-9-27	1.65	•	•
Patriot	PXD38G1866ELK (XMP)	8GB (2x4GB)	DS	-	-	1866 9-10-9-27	1.5	•	•
Team	TED34G1866HC13BK	4GB	SS	-	-	-	-	•	•
Team	TED38G1866HC-13BK	8GB	DS	-	-	-	-	•	•
Team	TLD38G1866HC10SBK (XMP)	8GB	DS	-	-	10-11-10-30	1.5	•	•

## DDR3 1800 MHz capability

Vendors	Part No.	Size	SS/ DS	Chip Brand	Chip NO.	Timing	Voltage	DIMM socket support (Optional)	
								2	4
G.SKILL	F3-14400CL9D-4GBRL(XMP)	4GB ( 2x 2GB )	DS	-	-	9-9-9-24	1.65	•	

## DDR3 1600 MHz capability

Vendors	Part No.	Size	SS/ DS	Chip Brand	Chip NO.	Timing	Voltage	DIMM socket support (Optional)	
								2	4
A-DATA	AD3U1600C2G11	2GB	SS	MICRON	D9PFJ	11-11- 11-28	-	•	•
A-DATA	AD3U1600C4G11	4GB	DS	MICRON	D9PFJ	11-11- 11-28	-	•	•
A-DATA	AD3U1600W4G11	4GB	SS	A-DATA	3WCD-1211A	11-11- 11-28	-	•	•
A-DATA	AD3U1600W8G11	8GB	DS	A-DATA	3WCD-1211A	11-11- 11-28	-	•	•
A-DATA	AX3U1600GW8G9 (XMP)	16GB (2x8GB)	DS	-	-	9-9-9-24	1.5	•	•
A-DATA	AX3U1600W8G11	16GB (2x8GB)	DS	-	-	9-11- 9-27	1.5	•	•
A-DATA	AXDU1600GW8G9B (XMP)	16GB (2x8GB)	DS	-	-	9-11- 9-27	1.65	•	•

(continued on the next page)

## DDR3 1600 MHz capability

Vendors	Part No.	Size	SS/ DS	Chip Brand	Chip NO.	Timing	Voltage	DIMM socket support (Optional)	
								2	4
AMD	AE32G1609U1-U	2GB	SS	AMD	23EY4587MB6H	-	1.5	*	*
AMD	AE34G1609U2-U	4GB	DS	AMD	23EY4587MB6H	-	1.5	*	*
AMD	AP38G1608U2K (XMP)	8GB (2x4GB)	DS	-	-	9-9-9-28	1.65	*	*
Apacer	78.B1GE3.9L10C	4GB	DS	Apacer	AM5D5908DEQSK	-	1.65	*	*
Apacer	78.B1GET.9K00C	4GB	SS	Apacer	AM5D6008BQQSK	11-11-11-28	-	*	*
Apacer	78.C1GET.9K10C	8GB	DS	Apacer	AM5D6008BQQSK	11-11-11-31	-	*	*
Apacer	AHU04GFA60C9Q3R (XMP)	4GB	DS	-	-	11-11-11-28	-	*	*
Apacer	AHU08GFA60CBT3R (XMP)	8GB	DS	-	-	9-9-9-24	-	*	*
Asint	SLA302G08-EGG1C (XMP)	4GB	DS	Asint	302G08-GG1C	9-9-9-27	-	*	*
Asint	SLA302G08-EGJ1C (XMP)	4GB	DS	Asint	302G08-GJ1C	9-9-9-27	-	*	*
Asint	SLA302G08-EGN1C	4GB	DS	ASint	302G08-GN1C	-	-	*	*
Asint	SLA304G08-ENG1B	4GB	SS	Asint	304G08-GN1B	9-11-11-28	-	*	*
Asint	SLB304G08-EGJ1B (XMP)	8GB	DS	-	-	9-9-9-27	-	*	*
Asint	SLB304G08-EGN1B	8GB	DS	ASint	304G08-GN1B	-	-	*	*
Asint	SLZ302G08-EGN1C	2GB	SS	ASint	302G08-GN1C	-	-	*	*
Asint	SLZ3128M8-EGJ1D (XMP)	2GB	DS	Asint	3128M8-GJ1D	-	-	*	*
ATP	AQ12M64B8BK0S	4GB	DS	SAMSUNG	K4B2G08460	-	NO	*	*
CORSAIR	CMD16GX3M2A1600C9 (Ver8.21)(XMP)	16GB (2x8GB)	DS	-	-	9-9-9-24	1.5	*	*
CORSAIR	CMD8GX3M2A1600C8 (Ver5.12)(XMP)	8GB (2x4GB)	DS	-	-	1600 8-8-8-24	1.5	*	*
CORSAIR	CMD8GX3M2A1600C9 (Ver2.12)(XMP)	8GB (2x4GB)	DS	-	-	9-9-9-24	1.5	*	*
CORSAIR	CMG4GX3M2A1600C6	4GB (2x2GB)	DS	-	-	6-6-6-18	1.65	*	*
CORSAIR	CML16GX3M4X1600C8 (Ver 2.12)(XMP)	16GB (4x4GB)	DS	-	-	Heat-Sink Package	1.5	*	*
CORSAIR	CMP6GX3M3A1600C8 (XMP)	6GB (3x2GB)	DS	-	-	8-8-8-24	1.65	*	*
CORSAIR	CMP6GX3M3A1600C8 (XMP)	6GB (3x2GB)	DS	-	-	8-8-8-24	1.65	*	*
CORSAIR	CMX6GX3M3C1600C7 (XMP)	6GB (3x2GB)	DS	-	-	7-8-7-20	1.65	*	*
CORSAIR	CMX8GX3M2A1600C9 (Ver3.19)(XMP)	8GB (2x4GB)	SS	-	-	9-9-9-24	1.65	*	*
CORSAIR	CMZ16GX3M2A1600C10 (Ver.3.24)(XMP)	16GB (2x8GB)	DS	-	-	10-10-10-27	1.5	*	*

(continued on the next page)

## DDR3 1600 MHz capability

Vendors	Part No.	Size	SS/ DS	Chip Brand	Chip NO.	Timing	Voltage	DIMM socket support (Optional)	
								2	4
CORSAIR	CMZ16GX3M4A1600C9 (XMP)	16GB (4x4GB)	DS	-	-	9-9-9-24	1.5	•	•
CORSAIR	CMZ32GX3M4X1600C10 (Ver2.2)(XMP)	32GB (4x8GB)	DS	-	-	10-10- 10-27	1.5	•	•
CORSAIR	CMZ8GX3M2A1600C8 (XMP)	8GB (2x4GB)	DS	-	-	8-8-8-24	1.5	•	•
CORSAIR	CMZ8GX3M4X1600C9 (Ver 2.12)(XMP)	8GB (4x2GB)	SS	-	-	9-9-9-24	1.5	•	•
CORSAIR	HX3X12G1600C9 (XMP)	12GB (6x2GB)	DS	-	-	9-9-9-24	1.6	•	•
Crucial	BL12864BN1608.8FF (XMP)	2GB (2x1GB)	SS	-	-	8-8-8-24	1.65	•	•
Crucial	BLT4G3D1608DT1TX0.16 FM(XMP)	4GB	DS	-	-	8-8-8-24	1.5	•	•
EK Memory	EKM324L28BP8- 116(XMP)	4GB (2x2GB)	DS	-	-	9	-	•	•
EK Memory	EKM324L28BP8- 116(XMP)	4GB (2x2GB)	DS	-	-	9	-	•	•
Elixir	M2X2G64CB88G7N- DG(XMP)	2GB	SS	Elixir	N2CB2G80GN-DG	9-9-9-28	-	•	•
Elixir	M2X4G64CB8HG5N- DG(XMP)	4GB	DS	Elixir	N2CB2G80GN-DG	9-9-9-28	-	•	•
Elixir	M2X8G64CB8HB5N- DG(XMP)	8GB	DS	Elixir	N2CB4G80BN-DG	9-9-9-28	1.5	•	•
G.SKILL	F3-12800CL7D- 8GBRH(XMP)	8GB (2x4GB)	DS	-	-	7-8-7-24	1.6	•	•
G.SKILL	F3-12800CL7Q-16GBXH (XMP)	16GB (4x4GB)	DS	-	-	7-8-7-24	1.6	•	•
G.SKILL	F3-12800CL8D-8GBECO (XMP)	8GB (2x4GB)	DS	-	-	8-8-8-24	1.35	•	•
G.SKILL	F3-12800CL9D-8GBRL (XMP)	8GB (2x4GB)	DS	-	-	9-9-9-24	1.5	•	•
G.SKILL	F3-12800CL9D-8GBSR2 (XMP)	8GB (2x4GB)	DS	-	-	9-9-9-24	1.25	•	•
G.SKILL	F3-12800CL9Q-16GBXL (XMP)	16GB (4x4GB)	DS	-	-	9-9-9-24	1.5	•	•
G.Skill	F3-12800CL9Q- 16GBZL(XMP)	16GB (4x4GB)	DS	-	-	9-9-9-24	1.5	•	•
G.SKILL	F3-1600C9Q-32GXM (XMP)	32GB (4x8GB)	DS	-	-	-	1.5	•	•

(continued on the next page)

## DDR3 1600 MHz capability

Vendors	Part No.	Size	SS/ DS	Chip Brand	Chip NO.	Timing	Voltage	DIMM socket support (Optional)	
								2	4
GEIL	GET316GB1600C9QC (XMP)	16GB (4x4GB)	DS	-	-	9-9-9-28	1.6	•	
GEIL	GUP34GB1600C7DC (XMP)	4GB (2x2GB)	DS	-	-	7-7-7-24	1.6	•	•
GoodRam	GR1600D364L9/2G	2GB	DS	GoodRam	GF1008KC-JN	-	-	•	•
KINGMAX	FLGE85F-C8KL9A (XMP)	2GB	SS	KINGMAX	N/A	9-9-9-28	-	•	•
KINGMAX	FLGF65F-C8KL9A (XMP)	4GB	DS	KINGMAX	N/A	9-9-9-28	-	•	•
KINGSTON	KHX16009CD3K2/8GX (XMP)	8GB (2x4GB)	DS	-	-	9-9-9-27	1.65	•	•
KINGSTON	KHX1600C9D3B1/4G (XMP)	4GB	SS	-	-	9-9-9-27	1.65	•	•
KINGSTON	KHX1600C9D3K3/12GX (XMP)	12GB (3x4GB)	DS	-	-	9	1.65	•	
KINGSTON	KHX1600C9D3K3/6GX (XMP)	6GB (3x2GB)	DS	-	-	9	1.65	•	•
KINGSTON	KHX1600C9D3K3/6GX (XMP)	6GB (3x2GB)	DS	-	-	9	1.65	•	•
KINGSTON	KHX1600C9D3K4/16GX (XMP)	16GB (4x4GB)	DS	-	-	9-9-9-24	1.65	•	•
KINGSTON	KHX1600C9D3K6/24GX (XMP)	24GB (6x4GB)	DS	-	-	9	1.65	•	•
KINGSTON	KHX1600C9D3K8/32GX (XMP)	32GB (8x4GB)	DS	-	-	9-9-9-27	1.65	•	•
KINGSTON	KHX1600C9D3L2/8GX (XMP)	8GB (2x4GB)	DS	-	-	9-9-9-24	1.35	•	•
KINGSTON	KHX1600C9D3P1K2/8G	8GB (2x4GB)	DS	-	-	9	1.5	•	•
KINGSTON	KHX16C10B1K2/16X (XMP)	16GB (2x8GB)	DS	-	-	-	1.5	•	•
KINGSTON	KHX16C9K2/16	16GB (2x 8GB)	DS	-	-	1333-9-9-9-24	1.5	•	•
KINGSTON	KHX16C9P1K2/16	16GB (2x8GB)	DS	-	-	-	1.5	•	•
KINGSTON	KVR16N11/4	4G	DS	Hynix	H5TQ2G83CFRPBC	-	1.5	•	•
KINGTIGER	KTG2G1600PG3(XMP)	2GB	DS	-	-	-	-	•	•
MICRON	MT16JTF1G64AZ-1G6D1	8GB	DS	MICRON	D9PBC	-	1.5	•	•
Micron	MT16JTF1G64AZ-1G6E1	8GB	DS	Micron	D9QBJ	-	-	•	•
MICRON	MT16KTF51264AZ-1G6M1	4GB	DS	MICRON	D9PFJ	-	-	•	•
Micron	MT8JTF51264AZ-1G6E1	4GB	SS	Micron	D9QBJ	-	-	•	•
MICRON	MT8KTF25664AZ-1G6M1	2GB	SS	MICRON	D9PFJ	-	-	•	•
Mushkin	996805(XMP)	4GB (2x2GB)	DS	-	-	6-8-6-24	1.65	•	
Mushkin	998805(XMP)	6GB (3x2GB)	DS	-	-	6-8-6-24	1.65	•	•

(continued on the next page)

## DDR3 1600 MHz capability

Vendors	Part No.	Size	SS/ DS	Chip Brand	Chip NO.	Timing	Voltage	DIMM socket support (Optional)	
								2	4
OCZ	OCZ3BE1600C8LV4GK	4GB (2x2GB)	DS	-	-	8-8-8	1.65	•	
Patriot	PGD316G1600ELK(XMP)	16GB (2x8GB)	DS	-	-	-	1.65	•	•
Patriot	PGD316G1600ELK(XMP)	16GB (2x8GB)	DS	-	-	9-9- 9-24	1.5	•	
Patriot	PGD38G1600ELK(XMP)	8GB (2x4GB)	DS	-	-	9-9-9-24	1.65	•	•
Patriot	PGD38G1600ELK(XMP)	8GB (2x4GB)	DS	-	-	9-9-9-24	1.5	•	
Patriot	PGS34G1600LLKA	4GB (2x2GB)	DS	-	-	7-7-7-20	1.7	•	•
Patriot	PGS34G1600LLKA2	4GB (2x2GB)	DS	-	-	8-8-8-24	1.7	•	•
Patriot	PV38G160C9KRD(XMP)	8GB (2x4GB)	DS	-	-	9-9-9-24	1.5	•	•
Patriot	PVV38G1600LLK(XMP)	8GB (2x4GB)	DS	-	-	8-8-8-24	1.65	•	•
Patriot	PX7312G1600LLK (XMP)	12GB (3x4GB)	DS	-	-	8-9-8-24	1.65	•	•
Patriot	PXD38G1600LLK(XMP)	8GB (2x4GB)	DS	-	-	1600 8- 9-8-24	1.65	•	•
PSC	AL9F8L93B-GN2E	4GB	SS	PSC	A3P4GF3BLF	-	-	•	•
PSC	ALAF8L93B-GN2E	8GB	DS	PSC	A3P4GF3BLF	-	-	•	•
SanMax	SMD-4G68HP-16KZ	4GB	DS	Hynix	H5TQ2G83BFRPBC	-	1.5	•	•
SanMax	SMD-4G68NG-16KK	4GB	DS	ELPIDA	J2108BDBG-GN-F	-	-	•	•
Silicon Power	SP002GBLTU160V02 (XMP)	2GB	SS	S-POWER	20YT5NG	9-11- 11-28	1.5	•	•
Silicon Power	SP004GBLTU160V02 (XMP)	4GB	DS	S-POWER	20YT5NG	9-9-9-24	1.5	•	•
Team	TXD34096M1600HC9-D (XMP)	4GB	DS	Hynix	H5TC2G83BFRH9A	9-9-9-24	1.5	•	•
Transcend	JM1600KLH-8G (626633)	8GB	DS	Transcend	TK963EBF3	-	-	•	•
Transcend	TS1GLK64V6H (620945)	8GB	DS	SAMSUNG	K4B4G0846B	-	-	•	•
Transcend	TS1GLK64W6H	8GB	DS	SAMSUNG	K4B4G0846B	11-11- 11-28-1	-	•	•
Transcend	TS512MLK64W6H	4GB	SS	SAMSUNG	K4B4G0846B	11-11- 11-28-2	-	•	•

## DDR3 1333 MHz capability

Vendors	Part No.	Size	SS/ DS	Chip Brand	Chip NO.	Timing	Voltage	DIMM socket support (Optional)	
								2	4
ACTICA	ACT1GHU64B8F1333S	1GB	SS	SAMSUNG	K4B1G0846F	-	-	*	*
ACTICA	ACT1GHU72C8G1333S	1GB	SS	SAMSUNG	K4B1G0846F (ECC)	-	-	*	*
ACTICA	ACT2GHU64B8G1333M	2GB	DS	Micron	D9KPT	-	-	*	*
ACTICA	ACT2GHU64B8G1333S	2GB	DS	SAMSUNG	K4B1G0846F	-	-	*	*
ACTICA	ACT2GHU72D8G1333M	2GB	DS	Micron	D9KPT (ECC)	-	-	*	*
ACTICA	ACT2GHU72D8G1333S	2GB	DS	SAMSUNG	K4B1G0846F (ECC)	-	-	*	*
ACTICA	ACT4GHU64B8H1333H	4GB	DS	Hynix	H5TQ2G83AFR	-	-	*	*
ACTICA	ACT4GHU72D8H1333H	4GB	DS	Hynix	H5TQ2G83AFR (ECC)	-	-	*	*
AMD	AE32G1339U1-U	2GB	SS	AMD	23EY4587MB3H	-	1.5	*	*
AMD	AE34G1339U2-U	4GB	DS	AMD	23EY4587MB3H	-	1.5	*	*
Apacer	78.A1GC6.9L1	2GB	DS	Apacer	AM5D5808FEOSBG	9	-	*	*
Apacer	78.B1GDE.9L10C	4GB	DS	Apacer	AM5D5908CEHSBG	9	-	*	*
Asint	SLA302G08-EDJ1C	2GB	SS	ASint	302G08-DJ1C	-	-	*	*
Asint	SLA304G08-EDJ1B	4GB	SS	Asint	304G08-DJ1B	9-10-10-26	-	*	*
Asint	SLB304G08-EDJ1B	8GB	DS	Asint	304G08-DJ1B	9-9-9-24	-	*	*
Asint	SLZ302G08-EDJ1C	4GB	DS	ASint	302G08-DJ1C	-	-	*	*
ATP	AQ12M72E8BKH9S	4GB	DS	SAMSUNG	K4B2G0846C (ECC)	-	-	*	*
BUFFALO	D3U1333-1G	1GB	SS	Elpida	J1108BFBG-DJ-F	-	-	*	*
BUFFALO	D3U1333-2G	2GB	DS	Elpida	J1108BFBG-DJ-F	-	-	*	*
BUFFALO	D3U1333-4G	4GB	DS	NANYA	NT5CB256M8BN-CG	-	-	*	*
CORSAIR	CMV4GX3M2A1333C9	4GB (2x2GB)	SS	-	N/A	9-9-9-24	-	*	*
CORSAIR	CMV8GX3M2A1333C9	8GB (2x4GB)	DS	-	N/A	9-9-9-24	-	*	*
CORSAIR	CMX8GX3M1A1333C9 (Ver2.2)	8GB	DS	-	-	9-9-9-24	1.5	*	*
CORSAIR	CMX8GX3M1A1333C9 (Ver3.23)	8GB	DS	-	-	9-9-9-24	1.5	*	*
CORSAIR	CMX8GX3M2A1333C9 (XMP)	8GB (2x4GB)	DS	-	-	9-9-9-24	1.5	*	*
EK Memory	EKM324L28BP8-113	4GB (2x2GB)	DS	-	-	9	-	*	*
Elixir	M2F2G64CB88G7N-CG	2GB	SS	Elixir	N2CB2G80GN-CG	-	-	*	*
ELPIDA	EBJ41UF8BCF0-DJ-F	4GB	DS	ELPIDA	J2108BCSE-DJ-F	-	-	*	*
G.SKILL	F3-10600CL9D-4GBNT	4GB (2x2GB)	DS	G.SKILL	D3 128M8CE9 2GB	9-9-9-24	1.5	*	*

(continued on the next page)

## DDR3 1333 MHz capability

Vendors	Part No.	Size	SS/ DS	Chip Brand	Chip NO.	Timing	Voltage	DIMM socket support (Optional)	
								2	4
G.SKILL	F3-10666CL7D-8GBRH (XMP)	8GB (2x4GB)	DS	-	-	7-7-7-21	1.5	•	
G.SKILL	F3-10666CL8D-4GBHK (XMP)	4GB (2x2GB)	DS	-	-	8-8-8-21	1.5	•	
G.SKILL	F3-10666CL9D-8GBRL	8GB (2x4GB)	DS	-	-	9-9-9-24	1.5	•	•
G.SKILL	F3-10666CL9D-8GBRL	8GB (2x4GB)	DS	-	-	9-9-9-24	1.5	•	•
G.SKILL	F3-10666CL9D-8GBXL	8GB (2x4GB)	DS	-	-	9-9-9-24	1.5	•	•
GEIL	GB34GB1333C7DC	4GB (2x2GB)	DS	GEIL	GL1L128M88BA15FW	7-7-7-24	1.5	•	
GEIL	GET316GB1333C9QC	16GB (4x4GB)	DS	-	-	9-9-9-24	1.5	•	•
GEIL	GG34GB1333C9DC	4GB (2x2GB)	DS	GEIL	GL1L128M88BA115FW	9-9-9-24	1.3	•	•
GEIL	GG34GB1333C9DC	4GB (2x2GB)	DS	GEIL	GL1L128M88BA15B	9-9-9-24	1.3	•	•
GEIL	GVP34GB1333C9DC	4GB (2x2GB)	DS	-	-	9-9-9-24	1.5	•	•
GEIL	GVP38GB1333C9DC	8GB (2x4GB)	DS	-	-	9-9-9-24	1.5	•	•
GoodRam	GR1333D364L9/2G	2GB	DS	Qimonda	IDSH1G-03A1F1C-13H	-	-	•	•
Hynix	HMT125U6TFR8A-H9	2GB	DS	Hynix	H5TC1G83TFR	-	-	•	•
Hynix	HMT325U6BFR8C-H9	2GB	SS	Hynix	H5TQ2G83BFR	-	-	•	•
INNODISK	M3UN-2GHJBC09	2GB	SS	Hynix	H5TQ2G83CFRH9C	9-9-9-24	-	•	•
INNODISK	M3UN-4GHJAC09	4GB	DS	Hynix	H5TQ2G83CFRH9C	9-9-9-24	-	•	•
KINGMAX	FLFD45F-B8KL9	1GB	SS	KINGMAX	KFB8FNLXF-BNF-15A	-	-	•	•
KINGMAX	FLFE85F-B8KL9	2GB	DS	KINGMAX	KFB8FNLXL-BNF-15A	-	-	•	•
KINGMAX	FLFE85F-C8KL9	2GB	SS	KINGMAX	KFC8FNLBF-GXX-12A	-	-	•	•
KINGMAX	FLFE85F-C8KL9	2GB	SS	KINGMAX	KFC8FNLXF-DXX-15A	-	-	•	•
KINGMAX	FLFE85F-C8KM9	2GB	SS	Kingmax	KFC8FNMXF-BXX-15A	-	-	•	•
KINGMAX	FLFF65F-C8KL9	4GB	DS	KINGMAX	KFC8FNLBF-GXX-12A	-	-	•	•
KINGMAX	FLFF65F-C8KL9	4GB	DS	KINGMAX	KFC8FNLXF-DXX-15A	-	-	•	•
KINGMAX	FLFF65F-C8KM9	4GB	DS	Kingmax	KFC8FNMXF-BXX-15A	-	-	•	•
KINGSTON	KVR1333D3E9S/4G	4GB	DS	Elpida	J2108ECSE-DJ-F	9	1.5	•	•
KINGSTON	KVR1333D3N9H/4G	4GB	DS	ELPIDA	J2108BDBG-GN-F	-	1.5	•	•
KINGSTON	KVR1333D3N9H/8G	8GB	DS	ELPIDA	J4208EASE-DJ-F	9-9-9-24	1.5	•	•
KINGSTON	KVR13N9S8H/4	4GB	SS	ELPIDA	J4208BBBG-GN-F	-	1.5	•	•

(continued on the next page)



## DDR3 1333 MHz capability

Vendors	Part No.	Size	SS/ DS	Chip Brand	Chip NO.	Timing	Voltage	DIMM socket support (Optional)	
								2	4
KINGTIGER	F10DA2T1680	2GB	DS	KINGTIGER	KTG1333PS1208NST-C9	-	-	*	*
KINGTIGER	KTG2G1333PG3	2GB	DS	-	-	-	-	*	*
Mach Xtreme	MXD3U133316GQ	16GB (4x4GB)	DS	-	-	-	-	*	*
Mach Xtreme	MXD3V13332GS	2GB	SS	Mach Xtreme	C2S46D30-D313	-	-	*	*
MICRON	MT16JTF1G64AZ-1G4D1	8GB	DS	MICRON	D9PCP	-	-	*	*
MICRON	MT&JTF25664AZ-1G4M1	2GB	SS	MICRON	D9PFJ	-	-	*	*
OCZ	OCZ3G1333LV4GK	4GB (2x2GB)	DS	-	-	9-9-9	1.65	*	*
OCZ	OCZ3G1333LV8GK	8GB (2x4GB)	DS	-	-	9-9-9	1.65	*	*
OCZ	OCZ3G1333LV8GK	8GB (2x4GB)	DS	-	-	9-9-9	1.65	*	*
OCZ	OCZ3RPR1333C9LV8GK	8GB (2x4GB)	DS	-	-	9-9-9	1.65	*	*
Patriot	PG38G1333EL (XMP)	8GB	DS	-	-	-	1.5	*	*
Patriot	FGD316G1333ELK (XMP)	16GB (2x8GB)	DS	-	-	9-9-9-24	1.5	*	*
Patriot	PGS34G1333LLKA	4GB (2x2GB)	DS	-	-	7-7-7-20	1.7	*	*
Patriot	PSD32G13332	2GB	DS	Prriot	PM128M8D3BU-15	9	-	*	*
RIDATA	C304627CB1AG22Fe	2GB	DS	RIDATA	C304627CB1AG22Fe	9	-	*	*
RIDATA	E304459CB1AG32Cf	4GB	DS	RIDATA	E304459CB1AG32Cf	9	-	*	*
SAMSUNG	M378B5273CH0-CH9	4GB	DS	SAMSUNG	K4B2G0846C	-	-	*	*
SAMSUNG	M378B5273DH0-CH9	4GB	DS	SAMSUNG	K4B2G08460	-	-	*	*
SAMSUNG	M378B5773DH0-CH9	2GB	SS	SAMSUNG	K4B2G08460	-	-	*	*
Silicon Power	SP001GBLTE133S01	1GB	SS	NANYA	NT5CB128M8AN-CG	-	-	*	*
Silicon Power	SP001GBLTU133S02	1GB	SS	S-POWER	10YT3E5	9	-	*	*
Silicon Power	SP002GBLTE133S01	2GB	DS	NANYA	NT5CB128M8AN-CG	-	-	*	*
Silicon Power	SP002GBLTU133V02	2GB	SS	S-POWER	20YT3NG	9-9-9-24	-	*	*
Team	TED34096M1333HC9	4GB	DS	Team	T3D2568LT-13	-	-	*	*
Team	TED38G1333HC9BK	8GB	DS	-	-	9-9-9-24	-	*	*
Transcend	JM1333KLIH-8G (623654)	8GB	DS	Transcend	TK963EBF3	-	-	*	*
Transcend	TS1GLK64V3H (620053)	8GB	DS	MICRON	D9QBJ	-	-	*	*



---

Side(s): SS - Single-sided DS - Double-sided DIMM support:

- (1) Supports one (1) module inserted into any slot as Single-channel memory configuration. We suggest that you install the module into A1 slot.
  - (2) Supports two (2) modules inserted into either the red slots or the black slots as one pair of Dual-channel memory configuration. We suggest that you install the modules into slots A1 and B1 for better compatibility.
  - (4) Supports four (4) modules inserted into both the red and black slots as two pairs of Dual-channel memory configuration.
- 



- ASUS exclusively provides hyper DIMM support function.
  - **Hyper DIMM support is subject to the physical characteristics of individual CPUs. Load the X.M.P. settings in the BIOS for the hyper DIMM support.**
  - **Visit the ASUS website for the latest QVL.**
-

## 1.2.5 Expansion slots



Unplug the power cord before adding or removing expansion cards. Failure to do so may cause you physical injury and damage motherboard components.

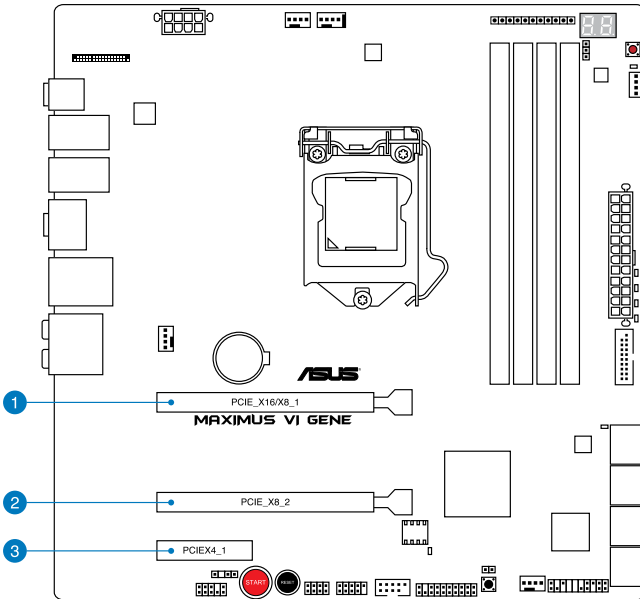

Slot No.	Slot Description
1	PCIe 3.0/2.0 x16/x8_1 slot
2	PCIe 3.0/2.0 x8_2 slot
3	PCIe 2.0 x4_1 slot

VGA Configuration	PCIe operating mode	
	PCI_E_X16/X8_1	PCI_E_X8_2
Single VGA/PCIe card	X16 (Recommend for single VGA)	N/A
Dual VGA/PCIe card	X8	X8



- We recommend that you provide sufficient power when running CrossFireX™ or SLI® mode.
- Connect a chassis fan to the motherboard connector labeled CHA\_FAN1-3 when using multiple graphics cards for better thermal environment.
- 4th generation Intel® Core™ processors support PCIe 3.0 speed rate.

## IRQ assignments for this motherboard

	A	B	C	D	E	F	G	H
PCI_E_X16/X8_1	shared	-	-	-	-	-	-	-
PCI_E_X8_2	-	shared	-	-	-	-	-	-
PCI_E_X4_1	shared	-	-	-	-	-	-	-
I.G.F.X.	shared	-	-	-	-	-	-	-
Intel LAN Controller	-	-	-	-	shared	-	-	-
SATA #0	-	shared	-	-	-	-	-	-
SATA #1	-	shared	-	-	-	-	-	-
High Definition Audio	-	-	-	-	-	-	shared	-
EHCI# 0 (USB 2.0)	-	-	-	-	-	-	-	shared
EHCI# 1 (USB 2.0)	-	-	-	-	shared	-	-	-
XHCI (USB 3.0)	-	-	-	-	-	shared	-	-
Asmedia SATA 6G Storage Controller	-	-	-	shared	-	-	-	-

## 1.2.6 Onboard buttons

Onboard buttons allow you to fine-tune performance when working on a bare or open-case system. This is ideal for overclockers and gamers who continually change settings to enhance system performance.

### 1. Power-on button

The motherboard comes with a power-on button that allows you to power up or wake up the system. The button also lights up when the system is plugged to a power source indicating that you should shut down the system and unplug the power cable before removing or installing any motherboard component.

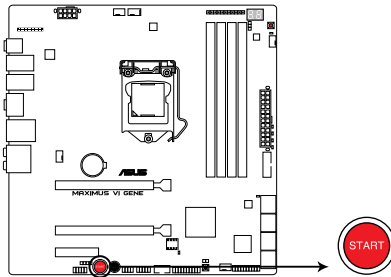

**MAXIMUS VI GENE Power on button**

### 2. Reset button

Press the reset button to reboot the system.

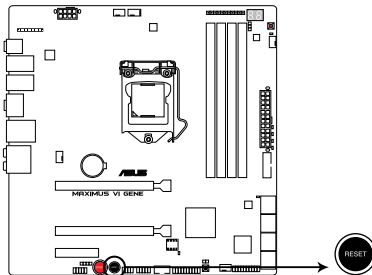

**MAXIMUS VI GENE Reset switch**

### 3. MemOK! button

Installing DIMMs that are not compatible with the motherboard may cause system boot failure, and the DRAM\_LED near the MemOK! button lights continuously. Press the MemOK! button until the MEMOK\_LED memory compatibility tuning for successful boot.

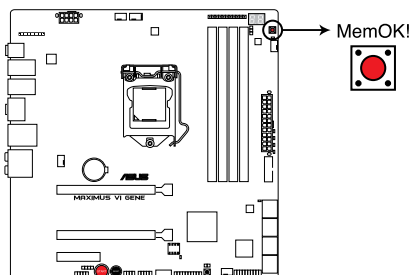

**MAXIMUS VI GENE MemOK! button**



- Refer to section **1.2.8 Onboard LEDs** for the exact location of the MEMOK\_LED.
- The DRAM\_LED also lights up when the DIMM is not properly installed. Turn off the system and reinstall the DIMM before using the MemOK! function.
- The MemOK! button does not function under Windows® OS environment.
- During the tuning process, the system loads and tests failsafe memory settings. It takes about 30 seconds for the system to test one set of failsafe settings. If the test fails, the system reboots and test the next set of failsafe settings. The blinking speed of the MEMOK\_LED increases, indicating different test processes.
- Due to memory tuning requirement, the system automatically reboots when each timing set is tested. If the installed DIMMs still fail to boot after the whole tuning process, the DRAM\_LED lights continuously. Replace the DIMMs with ones recommended in the Memory QVL (Qualified Vendors Lists) in this user manual or on the ASUS website at [www.asus.com](http://www.asus.com).
- If you turn off the computer and replace DIMMs during the tuning process, the system continues memory tuning after turning on the computer. To stop memory tuning, turn off the computer and unplug the power cord for about 5–10 seconds.
- If your system fails to boot up due to BIOS overclocking, press the MemOK! button to boot and load the BIOS default settings. A message will appear during POST reminding you that the BIOS has been restored to its default settings.
- We recommend that you download and update to the latest BIOS version from the ASUS website at [www.asus.com](http://www.asus.com) after using the MemOK! function.

#### 4. DirectKey button

This feature allows your system to go to the BIOS Setup program with the press of a button. With DirectKey, you can enter the BIOS anytime without having to press the <Del> key during POST. It also allows you to turn on or turn off your system and conveniently enter the BIOS during boot-up.

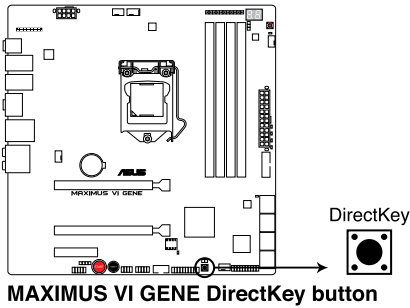

Ensure to save your data before using the DirectKey button.



- When the system is on and you press the DirectKey button, your system will shut down. Press the DirectKey button again or the Power-on button to reboot and enter the BIOS directly.
- Turn off your system using the power-on button to allow your system to go through POST (without entering the BIOS) when you reboot your system.
- Refer to section 3.8 **Boot Menu** for details about setting the DirectKey default function.

### 1.2.7 Jumpers

#### 1. LN2 Mode jumper (3-pin LN2\_MODE)

When enabled, the LN2 Mode jumper allows your system to eliminate the cold bugs in the processor during POST. It allows the processor to run at an extremely low temperature.

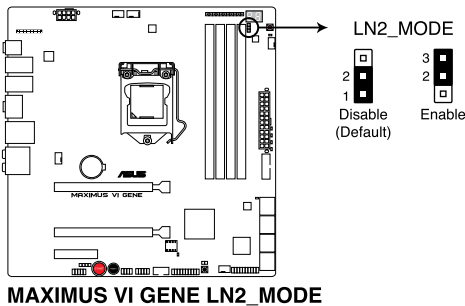

## 1.2.8 Onboard LEDs

### 1. Hard Disk LED

The hard disk LED is designed to indicate the hard disk activity. It blinks when data is being written into or read from the hard disk drive. The LED does not light up when there is no hard disk drive connected to the motherboard or when the hard disk drive does not function.

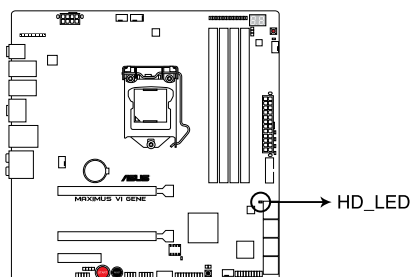

**MAXIMUS VI GENE Hard Disk LED**

### 2. MemOK! LED

**Blinking:** Indicates that MemOK! is enabled before POST.

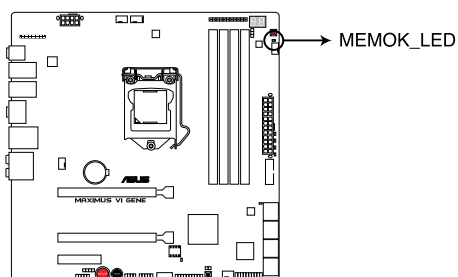

**MAXIMUS VI GENE MEMOK\_LED**



### 3. Q LED

Q LEDs check key components (CPU, DRAM, VGA card, and booting devices) in sequence during motherboard booting process. If an error is found, the corresponding LED flashes until the problem is solved. This user-friendly design provides an intuitive way to locate the root problem within seconds.

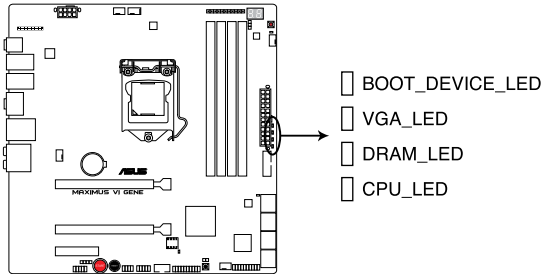

**MAXIMUS VI GENE CPU/ DRAM/  
VGA/ BOOT\_DEVICE LED**

### 4. Power LED

The motherboard comes with a power-on button that lights up to indicate that the system is ON, in sleep mode, or in soft-off mode. This is a reminder that you should shut down the system and unplug the power cable before removing or plugging in any motherboard component. The illustration below shows the location of the onboard power-on button.

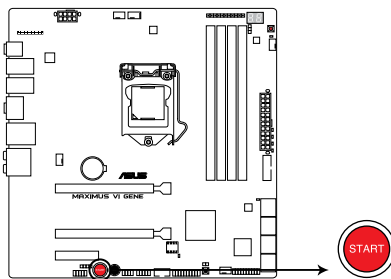

**MAXIMUS VI GENE Power on button**

## 5. BIOS Flashback LED

This LED flashes when the BIOS is updating and turns off after the BIOS update.

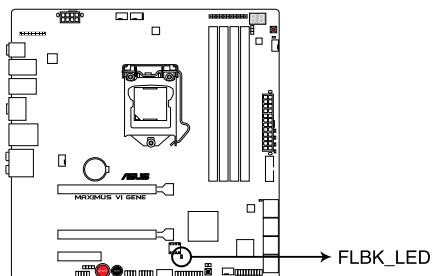

**MAXIMUS VI GENE FLBK\_LED**

## 6. Q-Code LEDs

The Q-Code LED design provides you with a 2-digit error code that displays the system status. Refer to the Q-Code table on the next page for details.

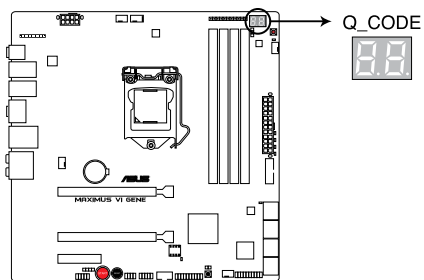

**MAXIMUS VI GENE Q\_Code LED**

## Q-Code table

Code	Description
00	Not used
01	Power on. Reset type detection (soft/hard).
02	AP initialization before microcode loading
03	System Agent initialization before microcode loading
04	PCH initialization before microcode loading
06	Microcode loading
07	AP initialization after microcode loading
08	System Agent initialization after microcode loading
09	PCH initialization after microcode loading
0B	Cache initialization
0C – 0D	Reserved for future AMI SEC error codes
0E	Microcode not found
0F	Microcode not loaded
10	PEI Core is started
11 – 14	Pre-memory CPU initialization is started
15 – 18	Pre-memory System Agent initialization is started
19 – 1C	Pre-memory PCH initialization is started
2B – 2F	Memory initialization
30	Reserved for ASL (see ASL Status Codes section below)
31	Memory Installed
32 – 36	CPU post-memory initialization
37 – 3A	Post-Memory System Agent initialization is started
3B – 3E	Post-Memory PCH initialization is started
4F	DXE IPL is started

*(continued on the next page)*

## Q-Code table

Code	Description
50 – 53	Memory initialization error. Invalid memory type or incompatible memory speed
54	Unspecified memory initialization error
55	Memory not installed
56	Invalid CPU type or Speed
57	CPU mismatch
58	CPU self test failed or possible CPU cache error
59	CPU micro-code is not found or micro-code update is failed
00	Not used
01	Power on. Reset type detection (soft/hard).
02	AP initialization before microcode loading
03	System Agent initialization before microcode loading
04	PCH initialization before microcode loading
06	Microcode loading
07	AP initialization after microcode loading
08	System Agent initialization after microcode loading
09	PCH initialization after microcode loading
0B	Cache initialization
0C – 0D	Reserved for future AMI SEC error codes
0E	Microcode not found
0F	Microcode not loaded
10	PEI Core is started
11 – 14	Pre-memory CPU initialization is started
15 – 18	Pre-memory System Agent initialization is started
19 – 1C	Pre-memory PCH initialization is started
2B – 2F	Memory initialization
30	Reserved for ASL (see ASL Status Codes section below)
31	Memory Installed
32 – 36	CPU post-memory initialization
37 – 3A	Post-Memory System Agent initialization is started

*(continued on the next page)*

## Q-Code table

Code	Description
3B – 3E	Post-Memory PCH initialization is started
4F	DXE IPL is started
50 – 53	Memory initialization error. Invalid memory type or incompatible memory speed
54	Unspecified memory initialization error
55	Memory not installed
56	Invalid CPU type or Speed
57	CPU mismatch
58	CPU self test failed or possible CPU cache error
59	CPU micro-code is not found or micro-code update is failed
5A	Internal CPU error
5B	Reset PPI is not available
5C – 5F	Reserved for future AMI error codes
E0	S3 Resume is started (S3 Resume PPI is called by the DXE IPL)
E1	S3 Boot Script execution
E2	Video repost
E3	OS S3 wake vector call
E4 – E7	Reserved for future AMI progress codes
E8	S3 Resume Failed
E9	S3 Resume PPI not Found
EA	S3 Resume Boot Script Error
EB	S3 OS Wake Error
EC – EF	Reserved for future AMI error codes
F0	Recovery condition triggered by firmware (Auto recovery)
F1	Recovery condition triggered by user (Forced recovery)
F2	Recovery process started
F3	Recovery firmware image is found
F4	Recovery firmware image is loaded
F5 – F7	Reserved for future AMI progress codes
F8	Recovery PPI is not available

*(continued on the next page)*

## Q-Code table

Code	Description
F9	Recovery capsule is not found
FA	Invalid recovery capsule
FB – FF	Reserved for future AML error codes
60	DXE Core is started
61	NVRAM initialization
62	Installation of the PCH Runtime Services
63 – 67	CPU DXE initialization is started
68	PCI host bridge initialization
69	System Agent DXE initialization is started
6A	System Agent DXE SMM initialization is started
6B – 6F	System Agent DXE initialization (System Agent module specific)
70	PCH DXE initialization is started
71	PCH DXE SMM initialization is started
72	PCH devices initialization
73 – 77	PCH DXE Initialization (PCH module specific)
78	ACPI module initialization
79	CSM initialization
7A – 7F	Reserved for future AMI DXE codes
90	Boot Device Selection (BDS) phase is started
91	Driver connecting is started
92	PCI Bus initialization is started
93	PCI Bus Hot Plug Controller Initialization
94	PCI Bus Enumeration
95	PCI Bus Request Resources
96	PCI Bus Assign Resources
97	Console Output devices connect
98	Console input devices connect
99	Super IO Initialization
9A	USB initialization is started
9B	USB Reset

*(continued on the next page)*

## Q-Code table

Code	Description
9C	USB Detect
9D	USB Enable
9E – 9F	Reserved for future AMI codes
A0	IDE initialization is started
A1	IDE Reset
A2	IDE Detect
A3	IDE Enable
A4	SCSI initialization is started
A5	SCSI Reset
A6	SCSI Detect
A7	SCSI Enable
A8	Setup Verifying Password
A9	Start of Setup
AA	Reserved for ASL (see ASL Status Codes section below)
AB	Setup Input Wait
AC	Reserved for ASL (see ASL Status Codes section below)
AD	Ready To Boot event
AE	Legacy Boot event
AF	Exit Boot Services event
B0	Runtime Set Virtual Address MAP Begin
B1	Runtime Set Virtual Address MAP End
B2	Legacy Option ROM Initialization
B3	System Reset
B4	USB hot plug
B5	PCI bus hot plug
B6	Clean-up of NVRAM
B7	Configuration Reset (reset of NVRAM settings)
B8– BF	Reserved for future AMI codes
D0	CPU initialization error
D1	System Agent initialization error

*(continued on the next page)*

## Q-Code table

Code	Description
D2	PCH initialization error
D3	Some of the Architectural Protocols are not available
D4	PCI resource allocation error. Out of Resources
D5	No Space for Legacy Option ROM
D6	No Console Output Devices are found
D7	No Console Input Devices are found
D8	Invalid password
D9	Error loading Boot Option (LoadImage returned error)
DA	Boot Option is failed (StartImage returned error)
DB	Flash update is failed
DC	Reset protocol is not available

## ACPI/ASL Checkpoints

Code	Description
0x01	System is entering S1 sleep state
0x02	System is entering S2 sleep state
0x03	System is entering S3 sleep state
0x04	System is entering S4 sleep state
0x05	System is entering S5 sleep state
0x10	System is waking up from the S1 sleep state
0x20	System is waking up from the S2 sleep state
0x30	System is waking up from the S3 sleep state
0x40	System is waking up from the S4 sleep state
0xAC	System has transitioned into ACPI mode. Interrupt controller is in PIC mode.
0xAA	System has transitioned into ACPI mode. Interrupt controller is in APIC mode.



## 1.2.9 Internal connectors

### 1. Intel® Z87 Serial ATA 6 Gb/s connectors (7-pin SATA6G\_1-6 [red])

These connectors connect to Serial ATA 6 Gb/s hard disk drives via Serial ATA 6 Gb/s signal cables.

If you installed Serial ATA hard disk drives, you can create a RAID 0, 1, 5, and 10 configuration with the Intel® Rapid Storage Technology through the onboard Intel® Z87 chipset.

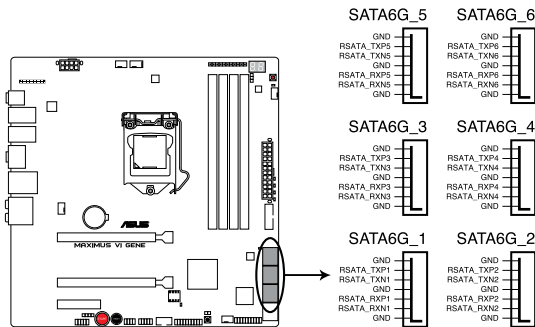

MAXIMUS VI GENE Intel® SATA 6 Gb/s connectors

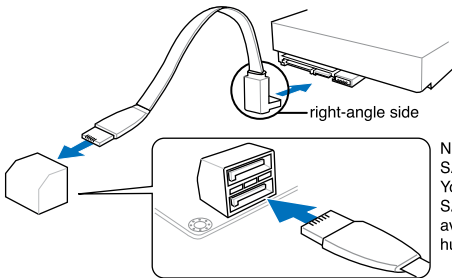

NOTE: Connect the right-angle side of SATA signal cable to SATA device. You may also connect the right-angle side of SATA cable to the onboard SATA port to avoid mechanical conflict with huge graphics cards.



- These connectors are set to **[AHCI Mode]** by default. If you intend to create a Serial ATA RAID set using these connectors, set the SATA Mode item in the BIOS to **[RAID Mode]**. Refer to section **3.6.3 SATA Configuration** for details.
- Before creating a RAID set, refer to section **5.1 RAID configurations** or the manual bundled in the motherboard support DVD.
- When using NCQ, set the SATA Mode in the BIOS to **[AHCI Mode]**. Refer to section **3.6.3 SATA Configuration** for details.



SATA 6 Gb/s port 5 will be disabled when M.2 slot on mPCIe Combo II is in use.

## 2. ASMedia® Serial ATA 6 Gb/s connectors (7-pin SATA6G\_E1/2 [red])

These connectors connect to Serial ATA 6 Gb/s hard disk drives via Serial ATA 6 Gb/s signal cables.

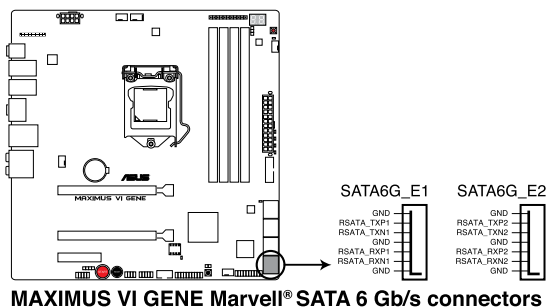

## 3. USB 3.0 connector (20-pin USB3\_12)

This connector allows you to connect a USB 3.0 module for additional USB 3.0 front or rear panel ports. With an installed USB 3.0 module, you can enjoy all the benefits of USB 3.0 including faster data transfer speeds of up to 5Gbps, faster charging time for USB-chargeable devices, optimized power efficiency, and backward compatibility with USB 2.0.

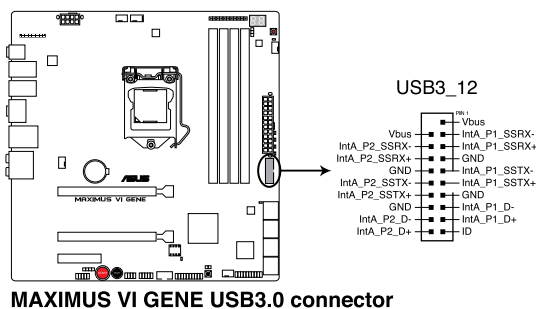

- The USB 3.0 module is purchased separately.
- These connectors are based on xHCI specification. We recommend you to install the related driver to fully use the USB 3.0 ports under Windows® 7.

#### 4. Digital audio connector (4-1 pin SPDIF\_OUT)

This connector is for an additional Sony/Philips Digital Interface (S/PDIF) port. Connect the S/PDIF Out module cable to this connector, then install the module to a slot opening at the back of the system chassis.

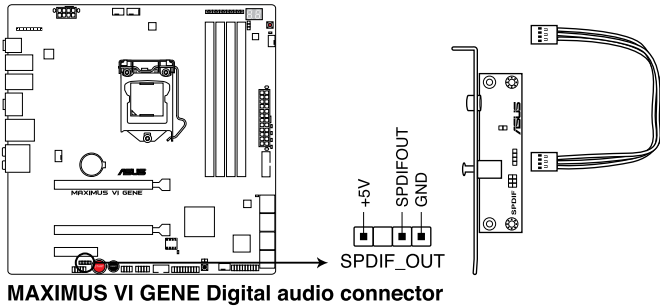

**MAXIMUS VI GENE Digital audio connector**



The S/PDIF module is purchased separately.

#### 5. Front panel audio connector (10-1 pin AAFP)

This connector is for a chassis-mounted front panel audio I/O module that supports either HD Audio or legacy AC'97 audio standard. Connect one end of the front panel audio I/O module cable to this connector.

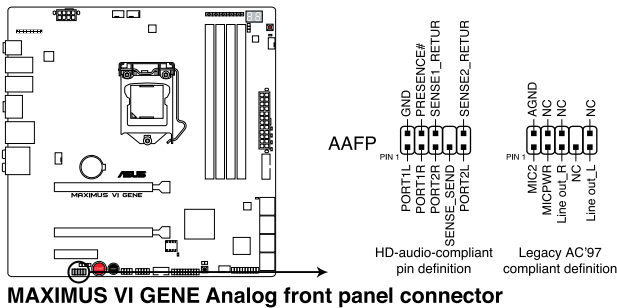

**MAXIMUS VI GENE Analog front panel connector**



- We recommend that you connect a high-definition front panel audio module to this connector to avail of the motherboard's high-definition audio capability.
- If you want to connect a high-definition or an AC'97 front panel audio module to this connector, set the **Front Panel Type** item in the BIOS setup to **[HD]** or **[AC97]**.

## 6. USB 2.0 connectors (10-1 pin USB1112; USB1314)

These connectors are for USB 2.0 ports. Connect the USB module cable to any of these connectors, then install the module to a slot opening at the back of the system chassis. These USB connectors comply with USB 2.0 specification that supports up to 480 MBps connection speed.

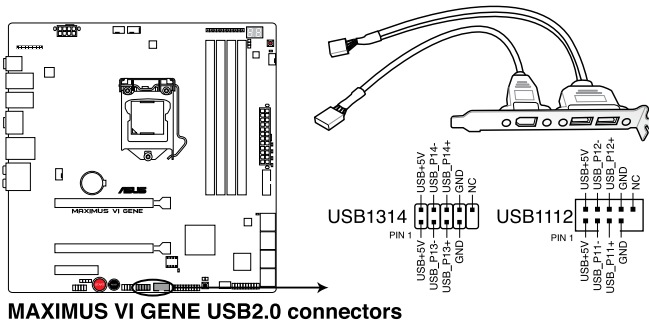

Never connect a 1394 cable to the USB connectors. Doing so will damage the motherboard!



You can connect the front panel USB cable to the ASUS Q-Connector (USB) first, and then install the Q-Connector (USB) to the USB connector onboard if your chassis supports front panel USB ports.



2 x USB2.0 ports (USB1314) at mid-board shares with ROG extension (ROG\_EXT) port.

## 7. CPU, chassis, and optional fan connectors

(4-pin CPU\_FAN; 4-pin CPU\_OPT; 4-pin CHA\_FAN1-3)

Connect the fan cables to the fan connectors on the motherboard, ensuring that the black wire of each cable matches the ground pin of the connector.

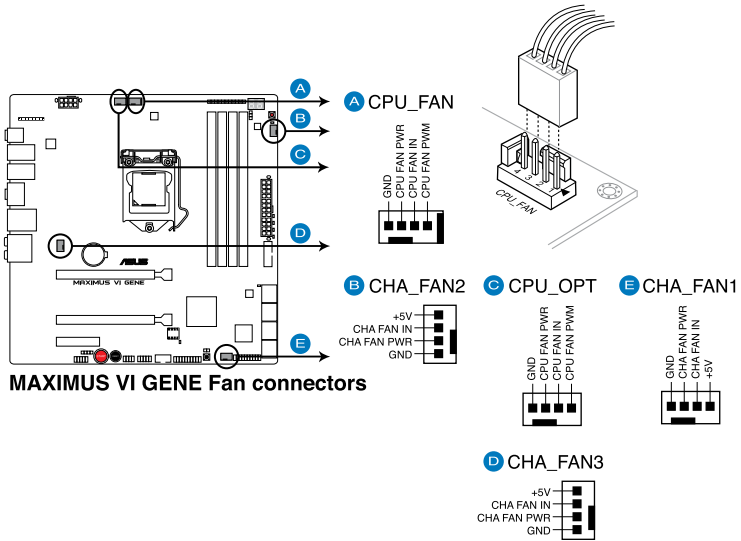

- DO NOT forget to connect the fan cables to the fan connectors. Insufficient air flow inside the system may damage the motherboard components. These are not jumpers! Do not place jumper caps on the fan connectors!
- Ensure to fully insert the 4-pin CPU fan cable to the CPU fan connector.



The CPU\_FAN connector supports the CPU fan of maximum 1A (12 W) fan power.

### 8. ATX power connectors (24-pin EATXPWR; 8-pin EATX12V)

These connectors are for ATX power supply plugs. The power supply plugs are designed to fit these connectors in only one orientation. Find the proper orientation and push down firmly until the connectors completely fit.

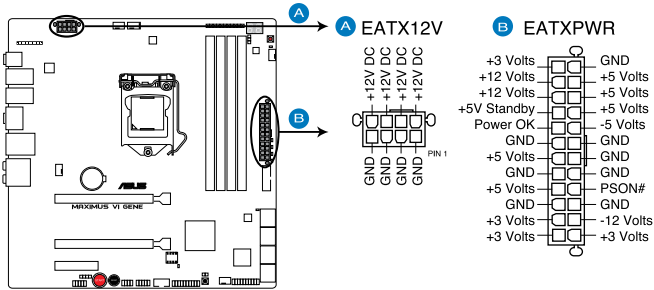

**MAXIMUS VI GENE ATX power connectors**



- For a fully configured system, we recommend that you use a power supply unit (PSU) that complies with ATX 12 V Specification 2.0 (or later version) and provides a minimum power of 350 W.
- Do not forget to connect the 4-pin/8-pin EATX12 V power plug. Otherwise, the system will not boot.
- We recommend that you use a PSU with a higher power output when configuring a system with more power-consuming devices. The system may become unstable or may not boot up if the power is inadequate.
- If you want to use two or more high-end PCI Express x16 cards, use a PSU with 1000W power or above to ensure the system stability.
- If you are uncertain about the minimum power supply requirement for your system, refer to the Recommended Power Supply Wattage Calculator at <http://support.asus.com/PowerSupplyCalculator/PSCalculator.aspx?SLanguage=en-us> for details.

## 9. System panel connector (20-8 pin PANEL)

This connector supports several chassis-mounted functions.

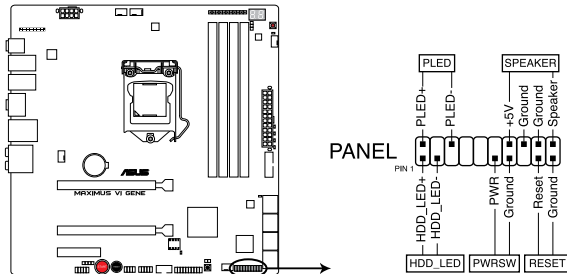

**MAXIMUS VI GENE System panel connector**

- **System power LED (2-pin PLED)**

This 2-pin connector is for the system power LED. Connect the chassis power LED cable to this connector. The system power LED lights up when you turn on the system power, and blinks when the system is in sleep mode.

- **Hard disk drive activity LED (2-pin HDD\_LED)**

This 2-pin connector is for the HDD Activity LED. Connect the HDD Activity LED cable to this connector. The HDD LED lights up or flashes when data is read from or written to the HDD.

- **System warning speaker (4-pin SPEAKER)**

This 4-pin connector is for the chassis-mounted system warning speaker. The speaker allows you to hear system beeps and warnings.

- **ATX power button/soft-off button (2-pin PWRSW)**

This connector is for the system power button. Pressing the power button turns the system on or puts the system in sleep or soft-off mode depending on the BIOS settings. Pressing the power button for more than four seconds while the system is ON turns the system OFF.

- **Reset button (2-pin RESET)**

This 2-pin connector is for the chassis-mounted reset button for system reboot without turning off the system power.

## 10. DirectKey connector (2-pin DRCT)

This connector is for the chassis-mounted button that supports the DirectKey function. Connect the button cable that supports DirectKey, from the chassis to this connector on the motherboard.

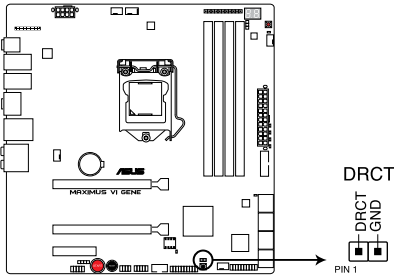

**MAXIMUS VI GENE DRCT connector**



Ensure that your chassis comes with the extra button cable that supports the DirectKey feature. Refer to the technical documentation that came with the chassis for details.

## 11. mPCIe Combo II connector (36-2-pin MPCIE\_COMBO\_II)

This connector is for the mPCIe Combo II card offers expandability solutions that also features the M.2 (NGFF) slot for M.2 SSD support.

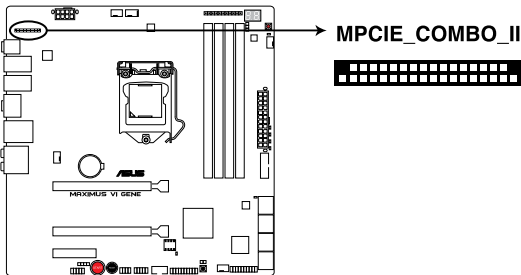

**MAXIMUS VI GENE MPCIE\_COMBO\_II**



## 12. ROG Extension - ROG\_EXT connector (18-1 pin ROG\_EXT)

This connector is for the OC Panel and the other ROG device.

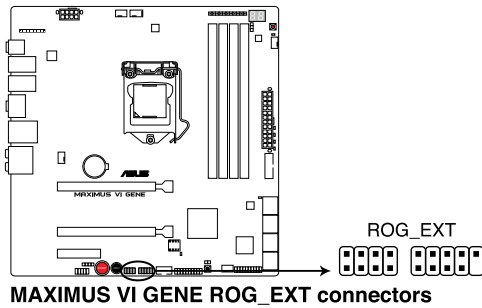

- The OC Panel is purchased separately.
- The OC Panel allows you to perform overclocking without going to the BIOS settings, loading the OS, or using overclocking software utilities.

## 13. TPM connector (20-1 pin TPM)

This connector supports a Trusted Platform Module (TPM) system, which securely store keys, digital certificates, passwords and data. A TPM system also helps enhance the network security, protects digital identities, and ensures platform integrity.

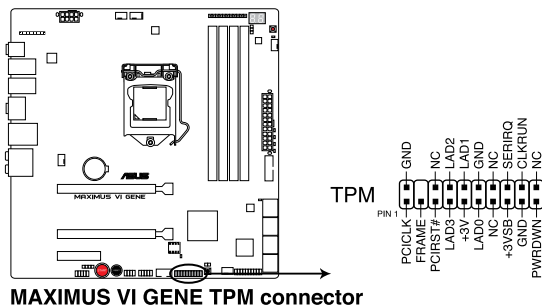

## 1.2.10 Probelt

The ROG Probelt allows you to detect your system's current voltage and OC settings. Use a multimeter to measure the Probelt points even during overclocking.

See the illustration below to locate the respective Probelt points.

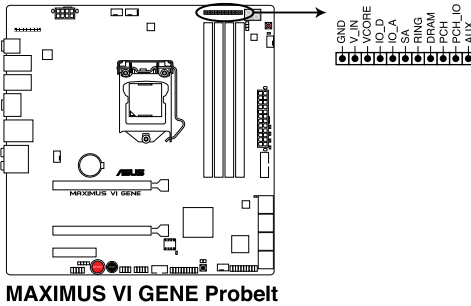

### Using Probelt

You may connect the multimeter to the motherboard as shown on the following figure.

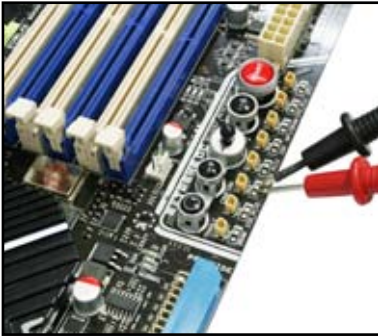

The photos above are for reference only, the actual motherboard layout and measure points location may differ by models.

# Basic Installation

# 2

## 2.1 Building your PC system

### 2.1.1 Motherboard installation



The diagrams in this section are for reference only. The motherboard layout may vary with models, but the installation steps are the same for all models.

1. Install the ASUS Q-Shield to the chassis rear I/O panel.

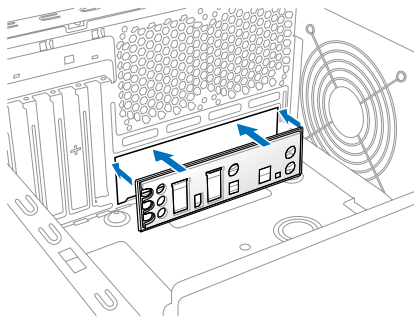

2. Place the motherboard into the chassis, ensuring that its rear I/O ports are aligned to the chassis' rear I/O panel.

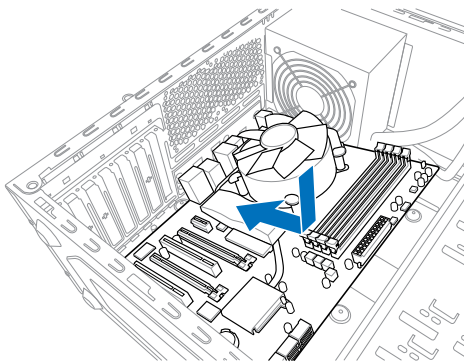

3. Place nine screws into the holes indicated by circles to secure the motherboard to the chassis.

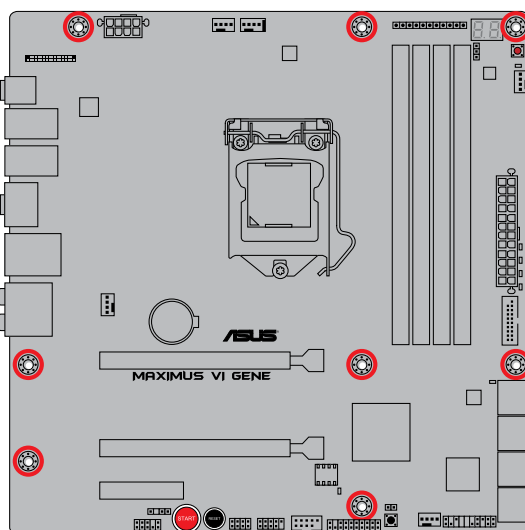
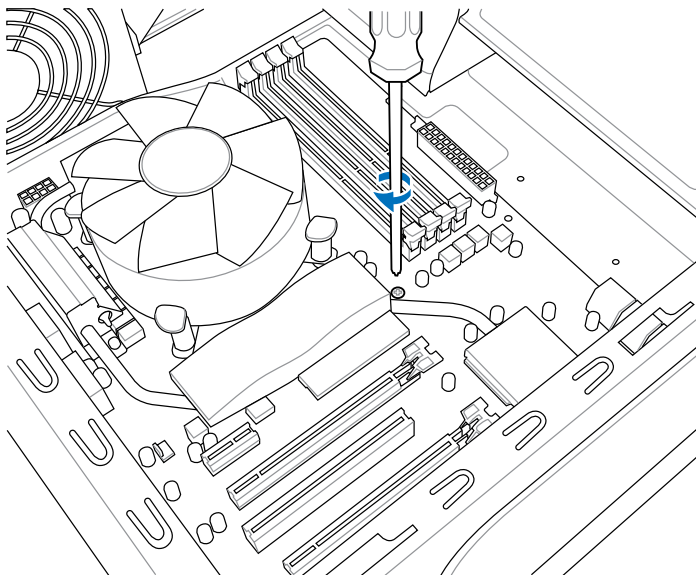

**DO NOT** overtighten the screws! Doing so can damage the motherboard.

## 2.1.2 CPU installation



Ensure that you install the correct CPU designed for LGA1150 socket only. DO NOT install a CPU designed for LGA1155 and LGA1156 sockets on the LGA1150 socket.

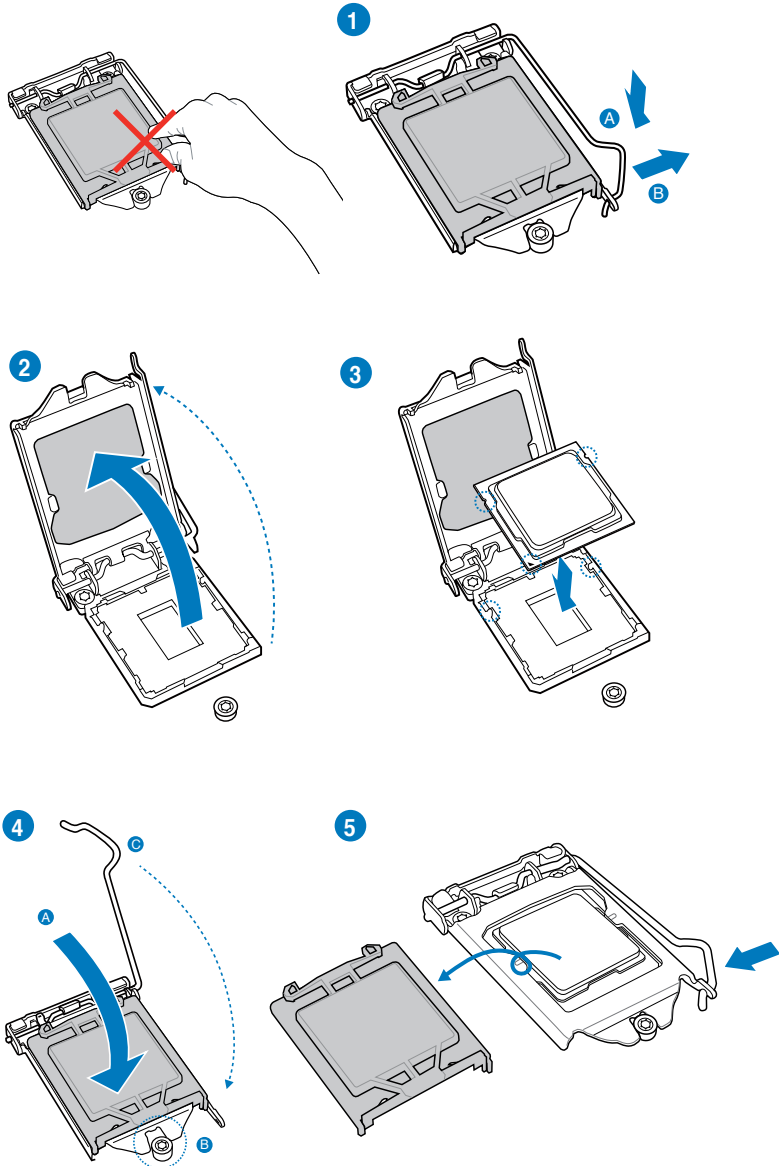

## 2.1.3 CPU heatsink and fan assembly installation

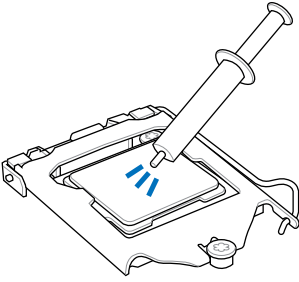

Apply the Thermal Interface Material to the CPU heatsink and CPU before you install the heatsink and fan if necessary.

To install the CPU heatsink and fan assembly

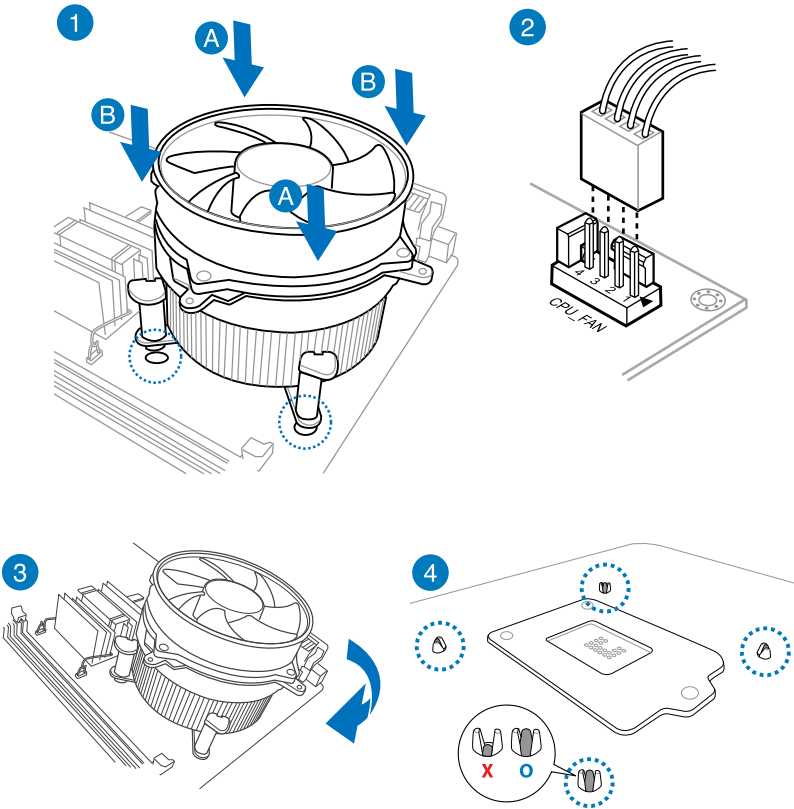

To uninstall the CPU heatsink and fan assembly

1

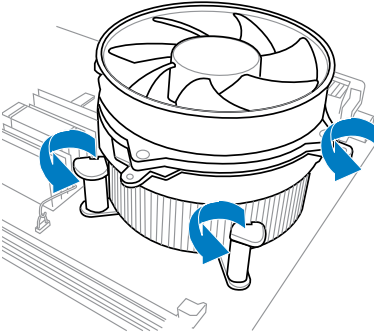

2

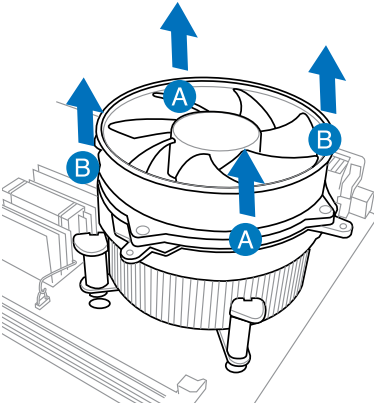

## 2.1.4 DIMM installation

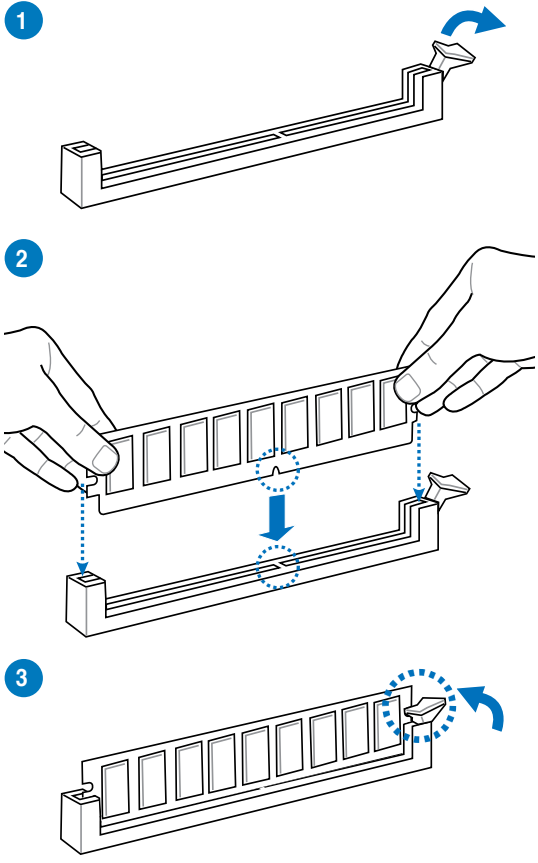

### To remove a DIMM

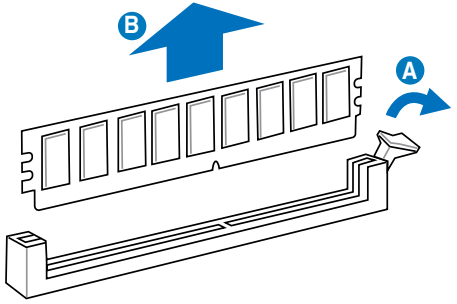



## 2.1.5 ATX Power connection

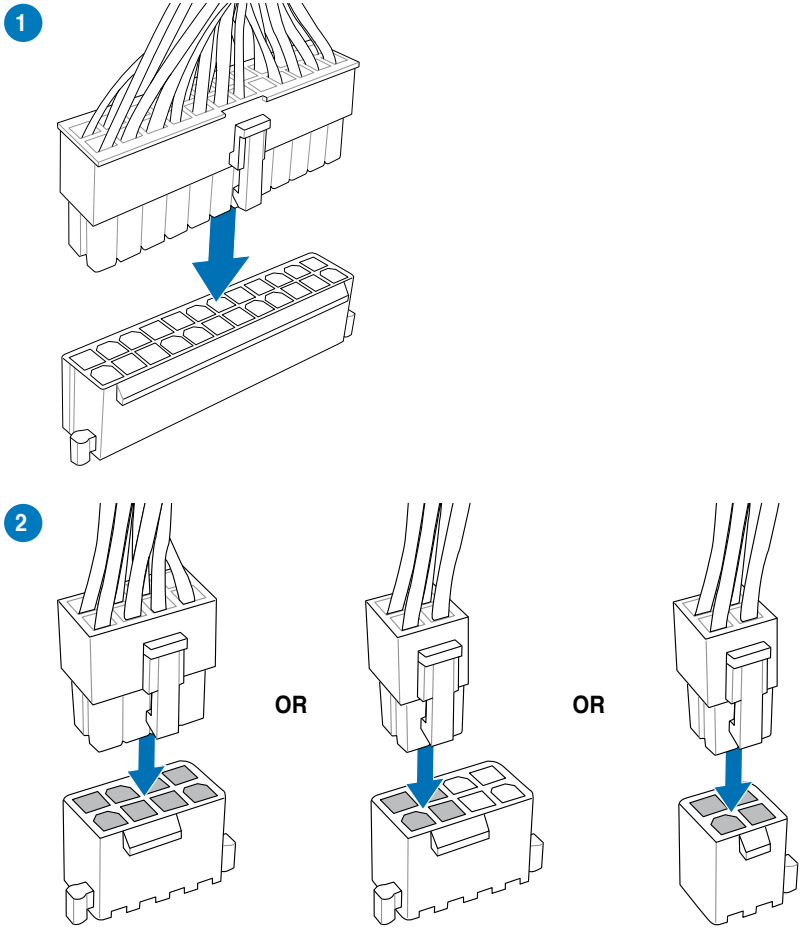

## 2.1.6 SATA device connection

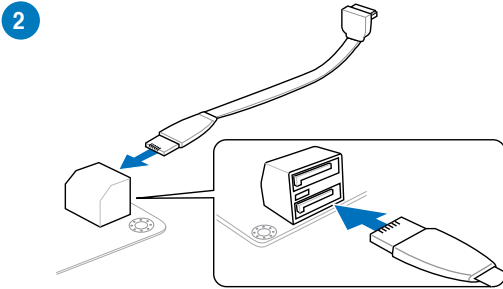
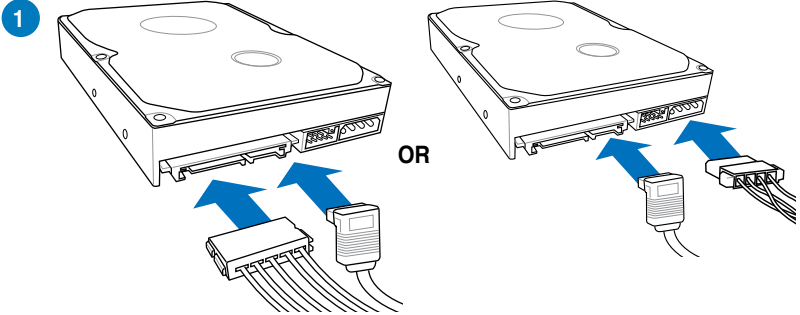

## 2.1.7 Front I/O Connector

### To install ASUS Q-Connector

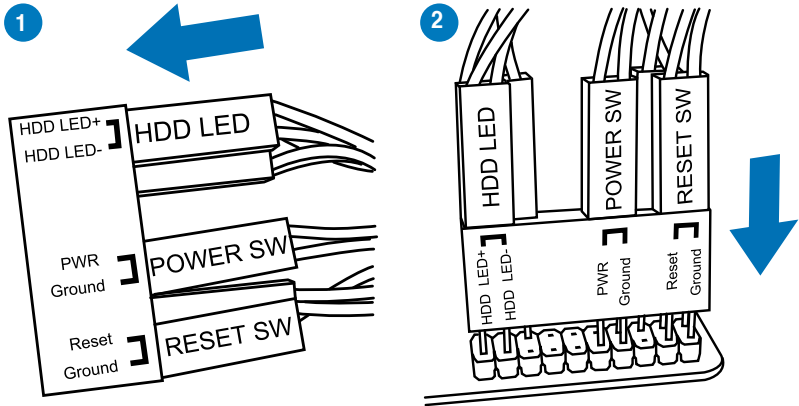

### To install USB 2.0 connector

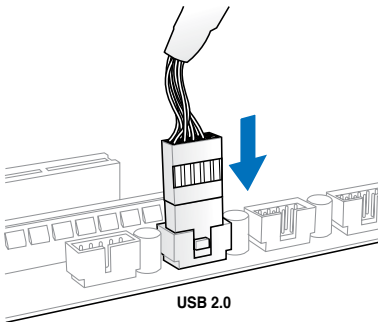

### To install front panel audio connector

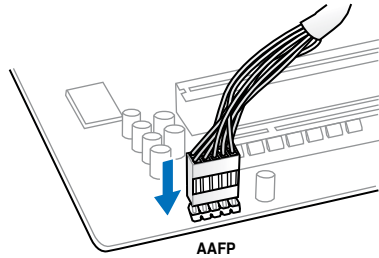

### To install USB 3.0 connector

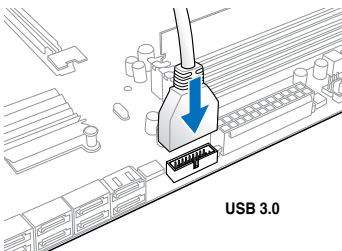

## 2.1.8 Expansion Card installation

To install PCIe x16 cards

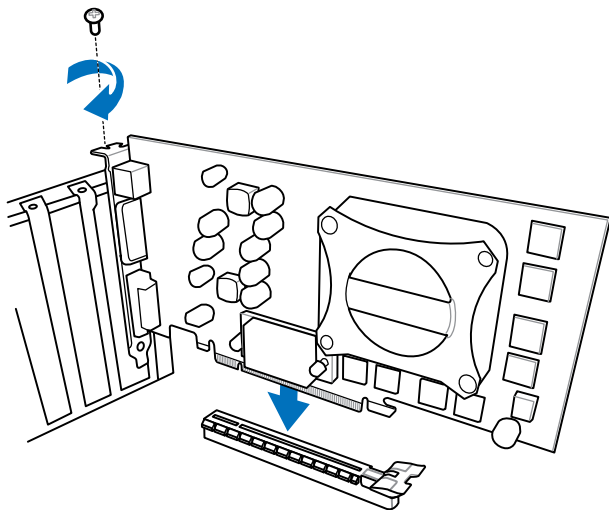

## 2.1.9 mPCIe Combo II installation

ROG mPCIe Combo II offers expandability solutions with the latest connectivity standards via the proprietary connector onboard. It provides mini PCI Express 2.0 plus USB 2.0 which is useful for connecting mPCIe and M.2 (NGFF) SSD module into your motherboard.



- The mPCIe Combo II card supports 26.8mm x 30mm half-sized mPCIe module on one side and M.2 (NGFF) type 2242 SSD card (22mm x 42mm) on the other side.
- The M.2 (NGFF) SSD, Wi-Fi, and Bluetooth modules are purchased separately.

### Installing the mPCIe Wi-Fi module

To install the mPCIe Wi-Fi module:



The Wi-Fi module is purchased separately.

1. Remove the two short screws at the back of the mPCIe Combo II card metal cover.

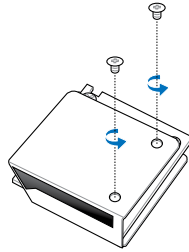

2. Remove the long screw at the front, then remove the metal cover.

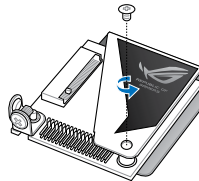

3. Set aside the plastic washers and remove the cap screws.

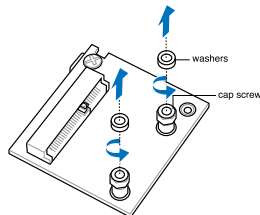

4. Align and insert the mPCIe Wi-Fi module into the mPCIe slot.
5. Press down the Wi-Fi module matching its screw holes with the screw holes on the mPCIe Combo II card.

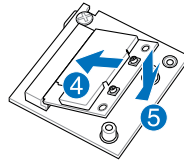

The mPCIe Wi-Fi module fits in one orientation only. If it does not fit, try reversing it.

6. Secure the mPCIe Wi-Fi module with the cap screws that you removed in step 3.



Do not overtighten the screws to prevent damage to the mPCIe Wi-Fi module or mPCIe Combo II card.

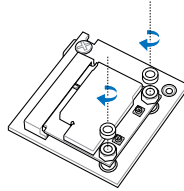

7. Connect the Wi-Fi antenna connector to the connectors on the Wi-Fi module.



The antenna connector is purchased separately.

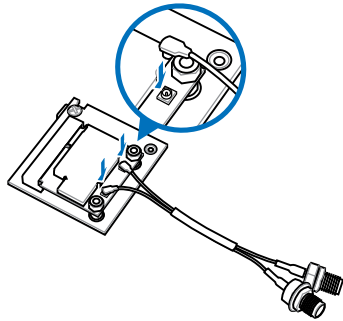

8. Replace the metal cover and secure the back of metal cover with the two short screws that you removed in step 1.

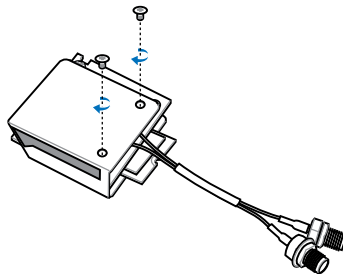

9. Secure the front of the metal cover with the long screw that you removed in step 2.

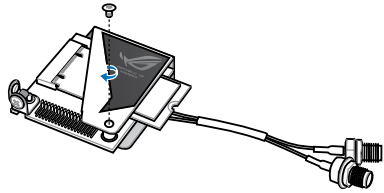

## Installing the M.2 (NGFF) SSD module

To install M.2 (NGFF) SSD module:

1. Remove the two short screws at the back of the mPCIe Combo II card metal cover.

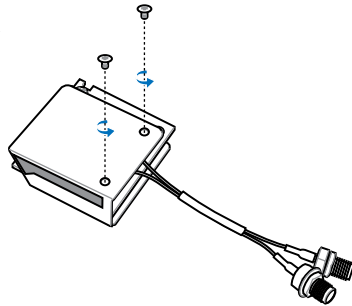

2. Remove the long screw at the front, then remove the metal cover.

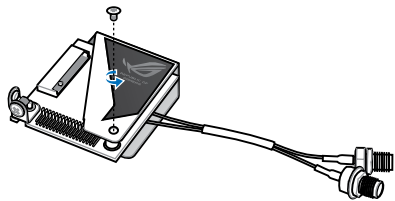

3. Align and insert the M.2 (NGFF) SSD module into the M.2 slot.

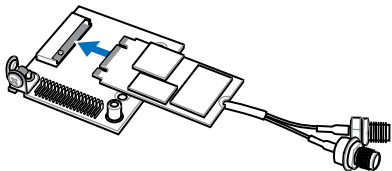

The M.2 (NGFF) SSD module fits in one orientation only. If it does not fit, try reversing it.

4. Replace the metal cover and secure the back of the metal cover with the two short screws that you removed in step 1.

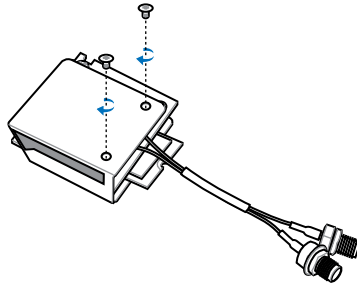

5. Secure the front of the metal cover with the long screw that you removed in step 2.

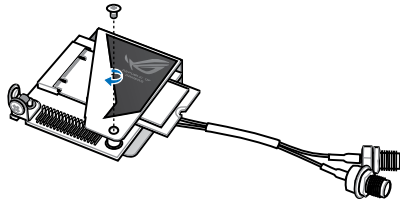

## Installing the mPCIe Combo II card

To install the mPCIe Combo II card to your motherboard:

1. Remove the black screw near the 36-2 pin connector.

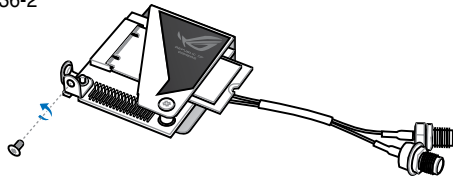

2. Locate the MPCIE\_COMBO\_II connector on the motherboard then align and insert the mPCIe Combo II card to the MPCIE\_COMBO\_II connector.

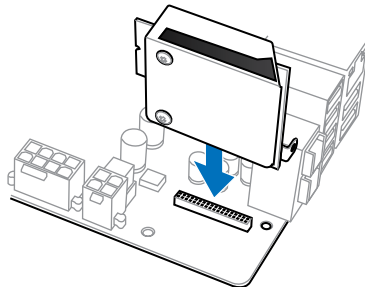

---

The mPCIe Combo II fits in one orientation only.

---



---

Insert the mPCIe Combo II carefully to prevent damage to the card, connector pins, or to the motherboard.

---



3. Secure the mPCIe Combo II card either to the motherboard or the rear I/O shield using the black screw that you removed in step 1.

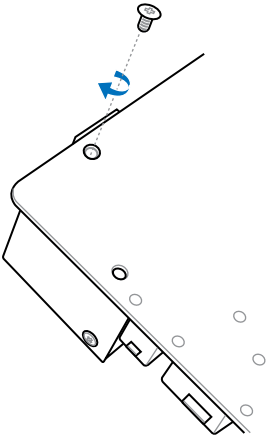

OR

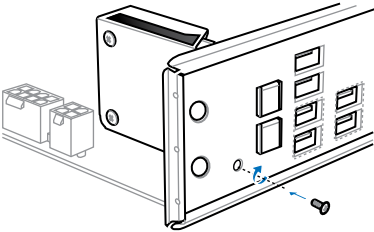

## Installing the Wi-Fi antenna connector

If you installed a Wi-Fi module on the mPCIe Combo II, you would need to install the Wi-Fi antenna connector.



The Wi-Fi antenna and its cables are purchased separately.

To install the Wi-Fi antenna connector:

1. Remove the bolt from the Wi-Fi antenna connector but leave the washer on the connector.

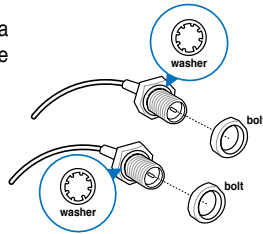

2. Insert the connector into the I/O shield's Wi-Fi port hole.

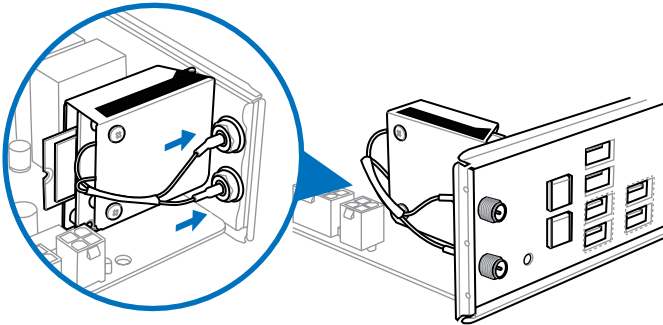

3. Replace the bolt on the connector to secure the antenna connector and the I/O shield in place.

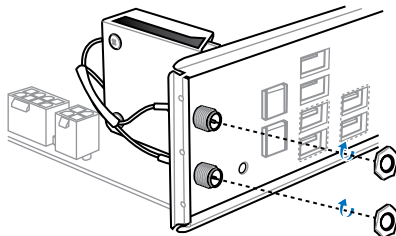

## 2.2 BIOS update utility

### USB BIOS Flashback

USB BIOS Flashback allows you to easily update the BIOS without entering the existing BIOS or operating system. Simply insert a USB storage device to the USB port, press the USB BIOS Flashback button for three seconds, and the BIOS is updated automatically.

#### To use USB BIOS Flashback:

1. Download the latest BIOS file from the ASUS website
2. Extract and rename the BIOS image file to **M6G.CAP**.
3. Copy **M6G.CAP** to the root directory of the USB flash disk drive.
4. Turn off the system and insert the USB storage device to the USB port.
5. Press the ROG Connect button and release when a flashing light appears, which indicates that the BIOS Flashback function is enabled.
6. Wait until the light goes out, indicating that the BIOS updating process is completed.

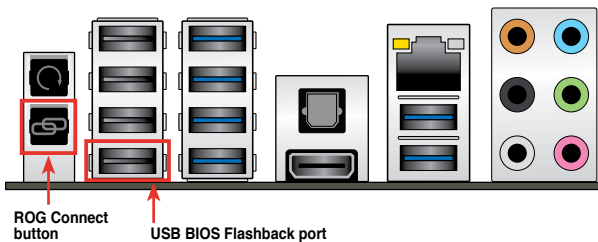

For more BIOS update utilities in BIOS setup, refer to the section **Updating BIOS** in Chapter 3.



- DO NOT unplug portable disk, power system, or press the CLR\_CMOS button while BIOS update is ongoing, otherwise update will be interrupted. In case of interruption, please follow the steps again.
- Updating BIOS may have risks. If the BIOS program is damaged during the process and results to the system's failure to boot up, please contact your local ASUS Service Center.

## 2.3 Motherboard rear and audio connections

### 2.3.1 Rear I/O connection

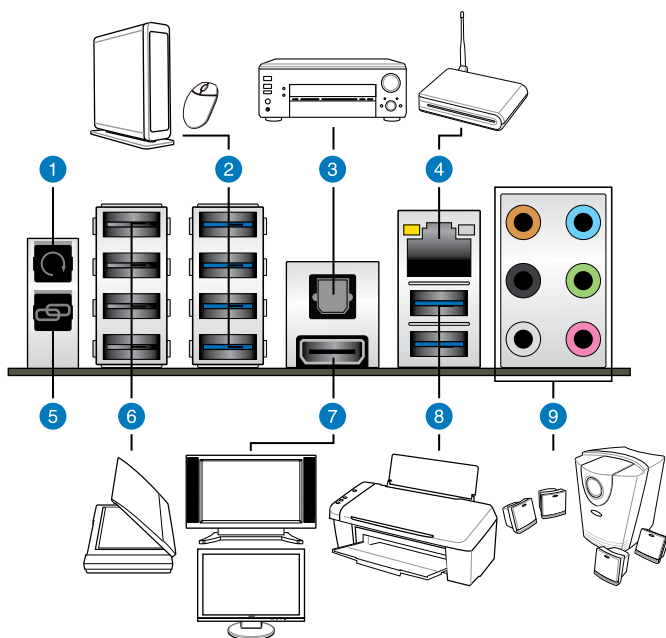

#### Rear panel connectors

1. Clear CMOS
2. ASMedia USB 3.0 port E1-4
3. Optical S/PDIF OUT port
4. LAN (RJ-45) port\*
5. ROG Connect button
6. Intel USB 2.0 port 7-10. The ROG Connect port is the port on button. It supports USB BIOS Flashback and USB Charger+
7. HDMI port
8. Intel USB 3.0 port 5 and 6
9. Audio I/O ports\*\*

\* and \*\*: Refer to the tables on the next page for LAN port LEDs, and audio port definitions.



- Due to USB 3.0 controller limitation, USB 3.0 devices can only be used under Windows® OS environment and after the USB 3.0 driver installation.
- USB 3.0 devices can only be used as data storage only.
- We strongly recommend that you connect USB 3.0 devices to USB 3.0 ports for faster and better performance for your USB 3.0 devices.
- Due to the design of the Intel® 8 series chipset, all USB devices connected to the USB 2.0 and USB 3.0 ports are controlled by the xHCI controller. Some legacy USB devices must update their firmware for better compatibility.

### \* LAN ports LED indications

Activity Link LED		Speed LED	
Status	Description	Status	Description
OFF	No link	OFF	10 Mbps connection
ORANGE	Linked	ORANGE	100 Mbps connection
BLINKING	Data activity	GREEN	1 Gbps connection

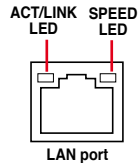

### \*\* Audio 2.1, 4.1, 5.1 or 7.1-channel configuration

Port	Headset 2.1-channel	4.1-channel	5.1-channel	7.1-channel
Light Blue	Line In	Line In	Line In	Line In
Lime	Line Out	Front Speaker Out	Front Speaker Out	Front Speaker Out
Pink	Mic In	Mic In	Mic In	Mic In
Orange	–	–	Center/Subwoofer	Center/Subwoofer
Black	–	Rear Speaker Out	Rear Speaker Out	Rear Speaker Out
Gray	–	–	–	Side Speaker Out

## 2.3.2 Audio I/O connections

### Audio I/O ports

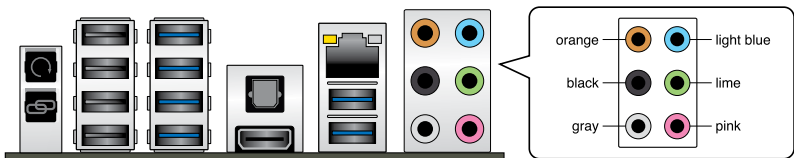

## Connect to Headphone and Mic

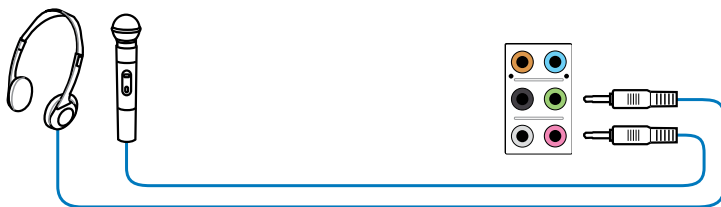

## Connect to Stereo Speakers

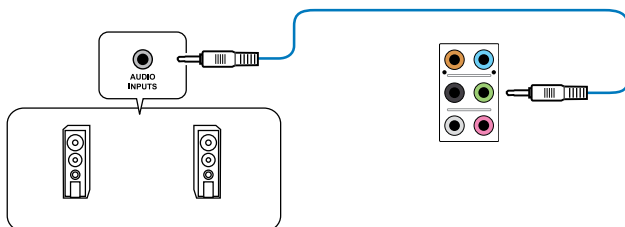

## Connect to 2.1 channel Speakers

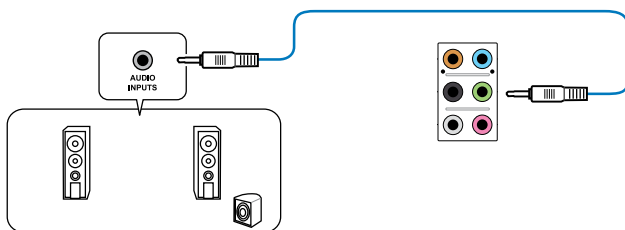

## Connect to 4.1 channel Speakers

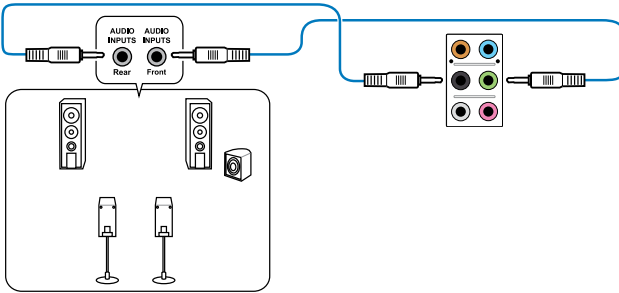

## Connect to 5.1 channel Speakers

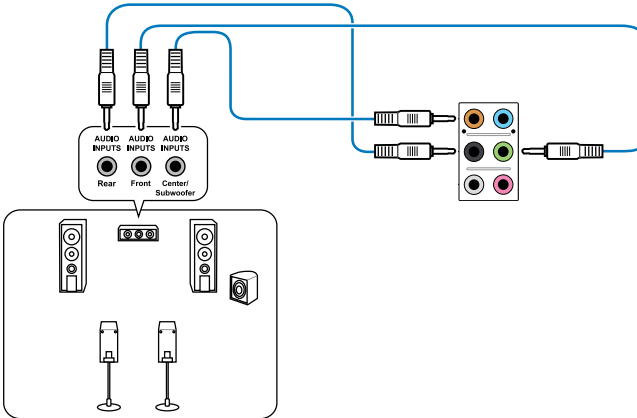

## Connect to 7.1 channel Speakers

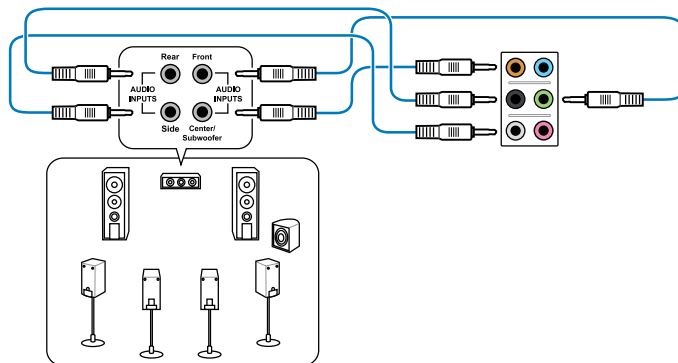



## 2.4 Starting up for the first time

1. After making all the connections, replace the system case cover.
2. Ensure that all switches are off.
3. Connect the power cord to the power connector at the back of the system chassis.
4. Connect the power cord to a power outlet that is equipped with a surge protector.
5. Turn on the devices in the following order:
  - a. Monitor
  - b. External SCSI devices (starting with the last device on the chain)
  - c. System power
6. After applying power, the system power LED on the system front panel case lights up. For systems with ATX power supplies, the system LED lights up when you press the ATX power button. If your monitor complies with the “green” standards or if it has a “power standby” feature, the monitor LED may light up or change from orange to green after the system LED turns on.

The system then runs the power-on self tests (POST). While the tests are running, the BIOS beeps (refer to the BIOS beep codes table) or additional messages appear on the screen. If you do not see anything within 30 seconds from the time you turned on the power, the system may have failed a power-on test. Check the jumper settings and connections or call your retailer for assistance.

BIOS Beep	Description
One short beep	VGA detected Quick boot set to disabled No keyboard detected
One continuous beep followed by two short beeps then a pause (repeated)	No memory detected
One continuous beep followed by three short beeps	No VGA detected
One continuous beep followed by four short beeps	Hardware component failure

7. At power on, hold down the <Delete> key to enter the BIOS Setup. Follow the instructions in Chapter 3.

## 2.5 Turning off the computer

While the system is ON, press the power button for less than four seconds to put the system on sleep mode or soft-off mode, depending on the BIOS setting. Press the power button for more than four seconds to let the system enter the soft-off mode regardless of the BIOS setting.



# BIOS setup

# 3

## 3.1 Knowing BIOS

---



The new ASUS UEFI BIOS is a Unified Extensible Interface that complies with UEFI architecture, offering a user-friendly interface that goes beyond the traditional keyboard-only BIOS controls to enable a more flexible and convenient mouse input. You can easily navigate the new UEFI BIOS with the same smoothness as your operating system. The term "BIOS" in this user manual refers to "UEFI BIOS" unless otherwise specified.

---

BIOS (Basic Input and Output System) stores system hardware settings such as storage device configuration, overclocking settings, advanced power management, and boot device configuration that are needed for system startup in the motherboard CMOS. In normal circumstances, the default BIOS settings apply to most conditions to ensure optimal performance. **DO NOT change the default BIOS settings** except in the following circumstances:

circumstances:

- An error message appears on the screen during the system bootup and requests you to run the BIOS Setup.
- You have installed a new system component that requires further BIOS settings or update.



---

Inappropriate BIOS settings may result in instability or boot failure. **We strongly recommend that you change the BIOS settings only with the help of a trained service personnel.**

---



---

When downloading or updating the BIOS file, rename it as **M6G.CAP** for this motherboard.

---

## 3.2 BIOS setup program

Use the BIOS Setup to update the BIOS or configure its parameters. The BIOS screen include navigation keys and brief onscreen help to guide you in using the BIOS Setup program.

### Entering BIOS at startup

To enter BIOS Setup at startup, press <Delete> during the Power-On Self Test (POST). If you do not press <Delete>, POST continues with its routines.

### Entering BIOS Setup after POST

To enter BIOS Setup after POST:

- Press <Ctrl>+<Alt>+<Delete> simultaneously.
- Press the reset button on the system chassis.
- Press the power button to turn the system off then back on. Do this option only if you failed to enter BIOS Setup using the first two options.



- 
- The BIOS setup screens shown in this section are for reference purposes only, and may not exactly match what you see on your screen.
  - Ensure that a USB mouse is connected to your motherboard if you want to use the mouse to control the BIOS setup program.
  - If the system becomes unstable after changing any BIOS setting, load the default settings to ensure system compatibility and stability. Select the **Load Optimized Defaults** item under the **Exit** menu or press hotkey <F5>. See section 3.9 **Exit Menu** for details.
  - If the system fails to boot after changing any BIOS setting, try to clear the CMOS and reset the motherboard to the default value. See section 1.2.6 **Onboard buttons** for information on how to erase the RTC RAM via the Clear CMOS button.
  - The BIOS setup program does not support the bluetooth devices.
- 

### BIOS menu screen

The BIOS Setup program can be used under two modes: **EZ Mode** and **Advanced Mode**. You can change modes from the **Exit** menu or from the **Exit/Advanced Mode** screen.

### 3.2.1 EZ Mode

The EZ Mode provides you an overview of the basic system information, and allows you to select the display language, system performance mode and boot device priority. To access the Advanced Mode, click **Exit/Advanced Mode**, then select **Advanced Mode** or press <F7> hot key for the advanced BIOS settings.



The default screen for entering the BIOS setup program can be changed. Refer to the **Setup Mode** item in section 3.7 **Boot menu** for details.

The screenshot shows the ASUS UEFI BIOS Utility - EZ Mode interface. Red boxes and lines highlight various features with corresponding callouts:

- Exit/Advanced Mode**: Click to display all fan speeds if available.
- Language**: Selects the display language of the BIOS setup program.
- System Information**: Displays the CPU/motherboard temperature, CPU/5V/3.3V/12V voltage output, CPU/chassis/power fan speed.
- System Performance**:
  - Power Saving**: Power Saving mode.
  - Normal**: Normal mode.
  - ASUS Optimal**: ASUS Optimal mode.
  - Quiet**: Performance and Energy Saving modes.
- Boot Priority**: Displays the selected shortcut items and the Advanced mode menus.
- Boot Menu**: Displays the system properties of the selected mode on the right hand side.
- Boot Menu (F8)**: Selects the boot device priority.
- Default (F5)**: Loads optimized default settings.



- The boot device options vary depending on the devices you installed to the system.
- **The Boot Menu (F8)** button is available only when the boot device is installed to the system.

### 3.2.2 Advanced Mode

The Advanced Mode provides advanced options for experienced end-users to configure the BIOS settings. The figure below shows an example of the Advanced Mode. Refer to the following sections for the detailed configurations.



To access the Advanced Mode, click **Exit**, then select **Advanced Mode** or press **F7** hotkey.

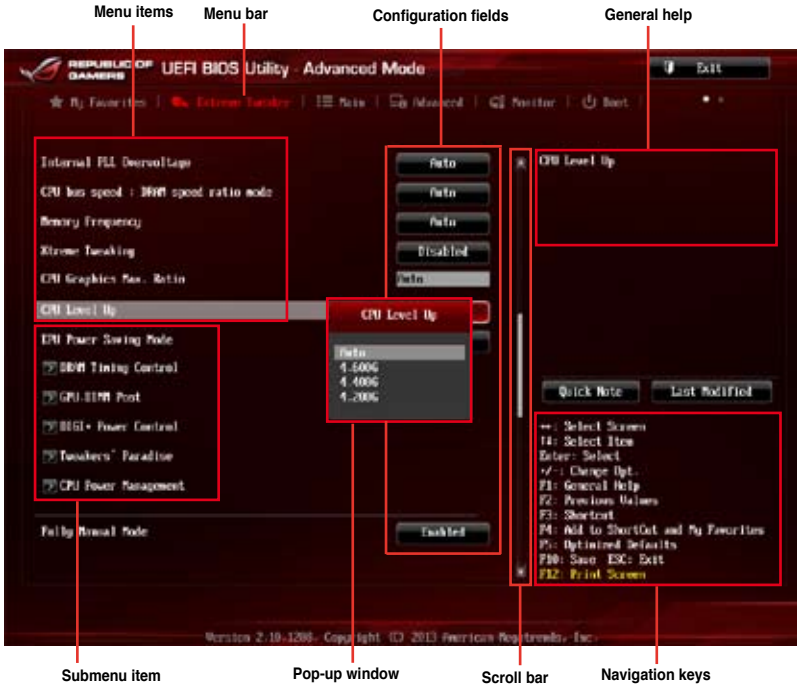

#### Menu bar

The menu bar on top of the screen has the following main items:

<b>My Favorites</b>	For saving the frequently-used system settings and configuration.
<b>Extreme Tweaker</b>	For changing the overclocking settings
<b>Main</b>	For changing the basic system configuration
<b>Advanced</b>	For changing the advanced system settings
<b>Monitor</b>	For displaying the system temperature, power status, and changing the fan settings.
<b>Boot</b>	For changing the system boot configuration
<b>Tool</b>	For configuring options for special functions
<b>Exit</b>	For selecting the exit options and loading default settings

## Menu items

The highlighted item on the menu bar displays the specific items for that menu. For example, selecting **Main** shows the Main menu items.

The other items (My Favorites, Ai Tweaker, Advanced, Monitor, Boot, Tool, and Exit) on the menu bar have their respective menu items.

## Back button

This button appears when entering a submenu. Press <Esc> or use the USB mouse to click this button to return to the previous menu screen.

## Submenu items

A greater than sign (>) before each item on any menu screen means that the item has a submenu. To display the submenu, select the item and press <Enter>.

## Pop-up window

Select a menu item and press <Enter> to display a pop-up window with the configuration options for that item.

## Scroll bar

A scroll bar appears on the right side of a menu screen when there are items that do not fit on the screen. Press the Up/Down arrow keys or <Page Up> / <Page Down> keys to display the other items on the screen.

## Navigation keys

At the bottom right corner of the menu screen are the navigation keys for the BIOS setup program. Use the navigation keys to select items in the menu and change the settings.



---

If you delete all shortcut items from the F3: Shortcut list, the default shortcut items will reappear after your next startup.

---

## General help

At the top right corner of the menu screen is a brief description of the selected item. Use <F12> key to capture the BIOS screen and save it to the removable storage device.

## Configuration fields

These fields show the values for the menu items. If an item is user-configurable, you can change the value of the field opposite the item. You cannot select an item that is not user-configurable.

A configurable field is highlighted when selected. To change the value of a field, select it and press <Enter> to display a list of options.

## Quick Note button

This button allows you to enter notes of the activities that you have done in BIOS.



- 
- The Quick Note function does not support the following keyboard functions: delete, cut, copy and paste.
  - You can only use the alphanumeric characters to enter your notes.
-

### Last Modified button

This button shows the items that you last modified and saved in BIOS Setup.

## 3.3 My Favorites

MyFavorites is your personal space where you can easily save and access your favorite BIOS items.



### Adding items to My Favorites

To add frequently-used BIOS items to My Favorites:

1. Use the arrow keys to select an item that you want to add. When using a mouse, hover the pointer to the item.
2. Press <F4> on your keyboard or right-click on your mouse to add the item to My Favorites page.



You cannot add the following items to My Favorites:

- Items with submenu options
- User-configurable items such as language and boot device order
- Configuration items such as Memory SPD Information, system time and date



### 3.4 Extreme Tweaker menu

The Extreme Tweaker menu items allow you to configure overclocking-related items.



Be cautious when changing the settings of the Extreme Tweaker menu items. Incorrect field values can cause the system to malfunction



The configuration options for this section vary depending on the CPU and DIMM model you installed on the motherboard.

Scroll down to display other BIOS items.



## Ai Overclock Tuner [Auto]

Allows you to select the CPU overclocking options to achieve the desired CPU internal frequency. Select any of these preset overclocking configuration options:

- [Auto] Loads the optimal settings for the system.
- [Manual] Allows you to individually set overclocking parameters.
- [X.M.P.] If you install memory modules supporting the eXtreme Memory Profile (X.M.P.) Technology, choose this item to set the profiles supported by your memory modules for optimizing the system performance.



---

The [X.M.P.] configuration option appears only when you install memory modules supporting the eXtreme Memory Profile(X.M.P.) Technology.

---

## ASUS MultiCore Enhancement [Enabled]

- [Enabled] Default is set to **[Enabled]** for maximum performance under XMP/Manual/ User-defined memory frequency mode.
- [Disabled] Allows you to set to default core ratio settings.

## CPU Core Ratio [Auto]

Allows you to set the CPU ratio and sync automatically, per core or all cores.

Configuration options: [Auto] [Sync All Cores] [Per Core]



---

When the CPU Core Ratio is set to **[Auto]**, the following item appears:

---

## Min CPU Cache Ratio [Auto]

Allows you to set the minimum possible ratio on the Uncore part of the processor. Use the <+> or <-> keys to adjust the value. The values depend on the CPU installed.

## Max CPU Cache Ratio [Auto]

Allows you to set the maximum possible ratio on the Uncore part of the processor. Use the <+> or <-> keys to adjust the value. The values depend on the CPU installed.



---

When the CPU Core Ratio is set to **[Synch All Cores]**, the following item appears.

---

### **1-Core Ratio Limit [Auto]**

Select **[Auto]** to apply the CPU default Turbo Ratio setting or manually assign a 1-Core Limit value that must be higher than or equal to the 2-Core Ratio Limit.



---

When the CPU Core Ratio is set to **[Per Core]**, the following item appears:

---

**1-Core Ratio Limit [Auto]**

Select **[Auto]** to apply the CPU default Turbo Ratio setting or manually assign a 1-Core Limit value that must be higher than or equal to the 2-Core Ratio Limit.

**2-Core Ratio Limit [Auto]**

Select **[Auto]** to apply the CPU default Turbo Ratio setting or manually assign a 2-Core Limit value that must be higher than or equal to the 3-Core Ratio Limit.



---

If you assign a value for 2-Core Ratio Limit, do not set the 1-Core Ratio Limit to **[Auto]**.

---

**Internal PLL Overvoltage [Auto]**

Allows you to enable the internal PLL voltage for K-SKU CPUs to get the extreme overclocking capability.

Configuration options: [Auto] [Enabled] [Disabled]

**CPU bus speed : DRAM speed ratio mode [Auto]**

Allows you to set the CPU bus speed to DRAM speed ratio mode.

[Auto]                    The DRAM speed is set to its optimized settings.

[100:100]                The CPU bus speed to DRAM speed ratio is set to 100:100.

[100:133]                The CPU bus speed to DRAM speed ratio is set to 100:133.

**Memory Frequency [Auto]**

Allows you to set the memory operating frequency. The configuration options vary with the BCLK / CPU StrapFrequency item settings.

### **Xtreme Tweaking [Disabled]**

This item may help improve some benchmarks performance.

Configuration options: [Enabled] [Disabled]

### **CPU Graphics Max. Ratio [Auto]**

Allows you to automatically optimize the CPU Graphics Ratio or manually set a value for an optimal CPU Graphics Ratio. Use the <+> or <-> keys to adjust the CPU graphics ratio. The minimum value depends on the installed CPU.

### **CPU Level Up [Auto]**

Allows you to select a CPU level, and the related parameters will be automatically adjusted according to the selected CPU level.

Configuration options: [Auto] [4.600G] [4.400G] [4.200G]

### **EPU Power Saving Mode [Disabled]**

Allows you to enable or disable the EPU power saving function.

Configuration options: [Disabled] [Enabled]

### **DRAM Timing Control**

The subitems in this menu allow you to set the DRAM timing control features. Use the <+> and <-> keys to adjust the value. To restore the default setting, type [auto] using the keyboard and press the <Enter> key.

#### **Memory Presets**

This item allows you to load the timing profiles for the memory modules. The loadable timing presets include the number of modules, the voltage

***Load 2x2GB Elpida Hyper 1.8V 2133***

Load timing profile for 2x2GB Elpida Hyper 1.8V 2133 chipset

***Load 2x2GB PSC 1.65V 2400***

Load timing profile for 2x2GB PSC 1.65V 2400 chipset

***Load 2x2GB 1T PSC 1.85V 2400***

Load timing profile for 2x2GB 1T PSC 1.85V 2400 chipset

***Load 2x2GB PSC 1.85V 2600***

Load timing profile for 2x2GB 1T PSC 1.85V 2400 chipset

***Load 2x2GB LN2 PSC 1.85V 2600***

Load timing profile for 2x2GB LN2 PSC 1.85V 2600 chipset

***Load 4x2GB PSC 1.65V 2400***

Load timing profile for 4x2GB PSC 1.65V 24000 chipset

***Load 4x2GB PSC 1.85V 2400***

Load timing profile for 4x2GB PSC 1.85V 2400 chipset

***Load 2x2GB BBSE 1.65V 2200***

Load timing profile for 2x2GB BBSE 1.65V 2200 chipset

***Load 2x2GB BBSE 1.85V 2400***

Load timing profile for Load 2x2GB BBSE 1.85V 2400 chipset

***Load 2x2GB LN2 BBSE 2.0V 2600***

Load timing profile for 2x2GB LN2 BBSE 2.0V 2600 chipset

**Load 4x2GB BBSE 1.65V 2200**

Load timing profile for 4x2GB BBSE 1.65V 2200 chipset

**Load 2x4GB Samsung 1.65V 2666**

Load timing profile for 2x4GB Samsung 1.65V 2666 chipset

**Load 2x4GB Samsung 1.85V 2666**

Load timing profile for 2x4GB Samsung 1.85V 2666 chipset

**Load 2x4GB Samsung 1.85V 2800**

Load timing profile for 2x4GB Samsung 1.85V 2800 chipset

**Load 4x4GB Samsung 1.65V 2666**

Load timing profile for 4x4GB Samsung 1.65V 2666 chipset

**Load 4x4GB Samsung 1.85V 2666**

Load timing profile for 4x4GB Samsung 1.85V 2666 chipset

**Load 2x4GB Hynix 1.65V 2600**

Load timing profile for 2x4GB Hynix 1.65V 2600 chipset

**Load 2x4GB Hynix 1.85V 2600**

Load timing profile for 2x4GB Hynix 1.85V 2600 chipset

**Load 2x4GB Hynix 1.85V 2750**

Load timing profile for 2x4GB Hynix 1.85V 2750 chipset

**Load 2x4GB LN2 Hynix 2.0V 2800**

Load timing profile for Load 2x4GB LN2 Hynix 2.0V 2800 chipset

**Load 2x4GB Hynix 1.65V 2666**

Load timing profile for Load 2x4GB Hynix 1.65V 2666 chipset

**Load 2x4GB Hynix 1.85V 2666**

Load timing profile for Load 2x4GB Hynix 1.85V 2666 chipset

**Load 2x4GB Hynix Single-sided 1.65V 2400**

Load timing profile for 2x4GB Hynix Single-sided 1.65V 2400 chipset

**Load 2x4GB Hynix Single-sided 1.85V 2400**

Load timing profile for 2x4GB Hynix Single-sided 1.85V 2400 chipset

**Load 2x4GB New Single-sided 1.85V 3000**

Load timing profile for 2x4GB New Single-sided 1.85V 3000 chipset

**Load 4x4GB New Single-sided 1.85V 2933**

Load timing profile for 4x4GB New Single-sided 1.85V 2933 chipset

**Load 2x8GB Samsung 1.65V 2400**

Load timing profile for Load 2x8GB Samsung 1.65V 2400 chipset

**Load 2x8GB Samsung 1.85V 2600**

Load timing profile for Load 2x8GB Samsung 1.85V 2600 chipset

**Load 4x8GB Samsung 1.65V 2400**

Load timing profile for Load 4x8GB Samsung 1.65V 2400 chipset

**Load 4x8GB Samsung 1.65V 2600**

Load timing profile for Load 4x8GB Samsung 1.65V 2600 chipset

**Load 2x8GB Hynix 1.85V 2600**

Load timing profile for 2x8GB Hynix 1.85V 2600 chipset

**Load 4x8GB Hynix 1.65V 2600**

Load timing profile for 4x8GB Hynix 1.65V 2600 chipset

**Load 2x8GB New Hynix 1.80V 2933**

Load timing profile for 2x8GB New Hynix 1.80V 2933 chipset

**Load 4x8GB New Hynix 1.80V 2933**

Load timing profile for 4x8GB New Hynix 1.80V 2933 chipset

**Load 2GB RAW MHz**

Load timing profile for 2GB RAW MHz chipset

**Load 4GB/8GB RAW MHz**

Load timing profile for 4GB/8GB RAW MHz chipset

**Maximus Tweak [Auto]**

[Auto] Automatically selects the mode.

[Mode 1] Memory compatibility.

[Mode 2] Overclocking and performance.



---

Changing the values in this menu may cause the system to become unstable! If this happens, revert to the default settings.

---

**Primary Timings**

**DRAM CAS# Latency [Auto]**

Configuration options: [Auto] [1] – [31]

**DRAM RAS# to CAS# Delay [Auto]**

Configuration options: [Auto] [1] – [31]

**DRAM RAS# PRE Time [Auto]**

Configuration options: [Auto] [1] – [31]

**DRAM RAS# ACT Time [Auto]**

Configuration options: [Auto] [1] – [63]

**DRAM COMMAND Mode [Auto]**

Configuration options: [Auto] [1] – [3]

**Latency Boundary A [Auto]**

Configuration options: [Auto] [1] – [27]

**Latency Boundary B [Auto]**

Configuration options: [Auto] [1] – [14]

## Secondary Timings

### **DRAM RAS# to RAS# Delay [Auto]**

Configuration options: [Auto] [1] – [15]

### **DRAM REF Cycle Time [Auto]**

Configuration options: [Auto] [1] – [511]

### **DRAM Refresh Interval [Auto]**

Configuration options: [Auto] [1] – [65535]

### **DRAM WRITE Recovery Time [Auto]**

Configuration options: [Auto] [1] – [16]

### **DRAM READ to PRE Time [Auto]**

Configuration options: [Auto] [1] – [15]

### **DRAM FOUR ACT WIN Time [Auto]**

Configuration options: [Auto] [1] – [255]

### **DRAM WRITE to READ Delay [Auto]**

Configuration options: [Auto] [1] – [15]

### **DRAM CKE Minimum pulse width [Auto]**

Configuration options: [Auto] [1] – [15]

### **DRAM CAS# Write Latency [Auto]**

Configuration options: [Auto] [1] – [31]

## RTL IOL control

### ***DRAM RTL Initial Value [Auto]***

Configuration options: [Auto] [1] - [63]

### ***DRAM RTL (CHA\_R0D0) [Auto]***

Configuration options: [Auto] [1] - [63]

### ***DRAM RTL (CHA\_R0D1) [Auto]***

Configuration options: [Auto] [1] - [63]

### ***DRAM RTL (CHA\_R1D0) [Auto]***

Configuration options: [Auto] [1] - [63]

### ***DRAM RTL (CHA\_R1D1) [Auto]***

Configuration options: [Auto] [1] - [63]

### ***DRAM RTL (CHB\_R0D0) [Auto]***

Configuration options: [Auto] [1] - [63]

### ***DRAM RTL (CHB\_R0D1) [Auto]***

Configuration options: [Auto] [1] - [63]

### ***DRAM RTL (CHB\_R1D0) [Auto]***

Configuration options: [Auto] [1] - [63]

**DRAM RTL (CHB\_R1D1) [Auto]**  
Configuration options: [Auto] [1] - [63]

**DRAM IO-L (CHA\_R0D0) [Auto]**  
Configuration options: [Auto] [1] - [15]

**DRAM IO-L (CHA\_R0D1) [Auto]**  
Configuration options: [Auto] [1] - [15]

**DRAM IO-L (CHA\_R1D0) [Auto]**  
Configuration options: [Auto] [1] - [15]

**DRAM IO-L (CHA\_R1D1) [Auto]**  
Configuration options: [Auto] [1] - [15]

**DRAM IO-L (CHB\_R0D0) [Auto]**  
Configuration options: [Auto] [1] - [15]

**DRAM IO-L (CHB\_R0D1) [Auto]**  
Configuration options: [Auto] [1] - [15]

**DRAM IO-L (CHB\_R1D0) [Auto]**  
Configuration options: [Auto] [1] - [15]

**DRAM IO-L (CHB\_R1D1) [Auto]**  
Configuration options: [Auto] [1] - [15]

### Third Timings

#### **tRDRD [Auto]**

Configuration options: [Auto] [1] – [7]

#### **tRDRD\_dr [Auto]**

Configuration options: [Auto] [1] – [15]

#### **tRDRD\_dd [Auto]**

Configuration options: [Auto] [1] – [15]

#### **tWRRD [Auto]**

Configuration options: [Auto] [1] – [63]

#### **tWRRD\_dr [Auto]**

Configuration options: [Auto] [1] – [15]

#### **tWRRD\_dd [Auto]**

Configuration options: [Auto] [1] – [15]

#### **tWRWR [Auto]**

Configuration options: [Auto] [1] – [7]

#### **tWRWR\_dr [Auto]**

Configuration options: [Auto] [1] – [15]

#### **tWRWR\_dd [Auto]**

Configuration options: [Auto] [1] – [15]

#### **Dec\_WRD**

Configuration options: [Auto] [0] – [1]



**tRDWR [Auto]**

Configuration options: [Auto] [1] – [31]

**tRDWR\_dr [Auto]**

Configuration options: [Auto] [1] – [31]

**tRDWR\_dd [Auto]**

Configuration options: [Auto] [1] – [31]

**MISC****MRC Fast Boot [Auto]**

Allows you to enable, disable or automatically set the MRC fast boot.

Configuration options: [Auto] [Enabled] [Disabled]

**DRAM CLK Period [Auto]**

Configuration options: [Auto] [1] – [14]

**Channel A DIMM Control [Enable Bot...]**

Allows you to enable or disable the Channel A DIMM slots with the following configuration options: [Enable Both DIMMS] [Disable DIMM0] [Disable DIMM1] [Disable Both DIMMS]

**Channel B DIMM Control [Enable Bot...]**

Allows you to enable or disable the Channel B DIMM slots with the following configuration options: [Enable Both DIMMS] [Disable DIMM0] [Disable DIMM1] [Disable Both DIMMS]

**Scrambler Setting [Optimized ...]**

Set this item to [Optimized (ASUS)] to enhance system stability.

Configuration options: [Optimized (ASUS)] [Default (MRC)]

**DQ Sense Amplifier [Auto]**

Reducing usually helps overclocking and over-voltage.

Configuration options: [Auto] [+16] – [-16]

**DQS Sense Amplifier [Auto]**

Reducing usually helps overclocking and over-voltage.

Configuration options: [Auto] [+16] – [-16]

**CMD Sense Amplifier [Auto]**

Reducing usually helps overclocking and over-voltage.

Configuration options: [Auto] [+16] – [-16]

**DRAM Swizzling Bit 0 [Auto]**

Enabling usually helps overclocking. Configuration options: [Auto] [Enabled] [Disabled]

**DRAM Swizzling Bit 1 [Auto]**

Enabling usually helps overclocking. Configuration options: [Auto] [Trained] [Enabled] [Disabled]

**DRAM Swizzling Bit 2 [Auto]**

Enabling usually helps overclocking. Configuration options: [Auto] [Trained] [Enabled] [Disabled]

**DRAM Swizzling Bit 3 [Auto]**

Enabling usually helps overclocking. Configuration options: [Auto] [Trained] [Enabled] [Disabled]

**RAW MHz Aid [Auto]**

Enabling usually helps overclocking at the expense of performance. Configuration options: [Auto] [Enabled] [Disabled]

**IC Optimizer [Auto]**

Enabling may help overclocking when using Samsung IC DIMMs. Configuration options: [Auto] [4G Samsung] [4G New Hynix] [4G OLD Hynix]

**GPU.DIMM Post**

Automatically detects and displays the information about the devices or memory installed on the PCIe and DIMM slots. The field shows N/A if there are no devices installed on the slots.

## DIGI+ Power Control

### CPU Load-Line Calibration [Auto]

Load-line is defined by Intel® VRM specification and affects CPU power voltage. The CPU working voltage will decrease proportionally to CPU loading. Higher load-line calibration could get higher voltage and good overclocking performance but increases the CPU and VRM thermal conditions.

Select from Level 1 to Level 8 to adjust CPU power voltage from 0% to 100%.



- The actual performance boost may vary depending on your CPU specification.
- DO NOT remove the thermal module. The thermal conditions must be monitored.

### CPU Voltage Frequency [Auto]

Switching frequency affects the VRM transient response and the thermal component conditions. Higher frequency gets quicker transient response.

Configuration options: [Auto] [Manual]



DO NOT remove the thermal module when setting this item to **[Manual]**. The thermal conditions should be monitored.



The following items appear only when you set the CPU Voltage Frequency to **[Auto]**.

#### ***VRM Spread Spectrum [Disabled]***

Enable the VRM Spread Spectrum to enhance system stability.

Configuration options: [Disabled] [Enabled]

#### ***Active Frequency Mode [Disabled]***

Enable the Active Frequency Mode for an enhanced power saving condition.

Configuration options: [Disabled] [Enabled]



The following item appears only when you set the CPU Voltage Frequency to **[Manual]**.

#### ***CPU Fixed Frequency [XXX]***

This item allows you to set a fixed CPU frequency. Use the <+> or <-> keys to adjust the valinterval.

### VCCIN MOS Volt Control [Auto]

This is the driving voltage for the MOSFET on the VCCIN Rail.

Configuration options: [Auto] [Manual] [Active VGD]

### CPU Power Phase Control [Auto]

Allows you to set the power phase control of the CPU.

- |                     |   |
|---------------------|---|
| [Standard]          | Set the phase control based on the CPU command.   |
| [Optimized]         | Set the ASUS optimized phase tuning profile.  |
| [Extreme]           | Set the full phase mode   |
| [Manual Adjustment] | Set manually to a faster phase response to increase system performance or to slower phase response to increase DRAM power efficiency. |



---

DO NOT remove the thermal module when setting this item to **[Extreme]** and **[Manual Adjustment]**. The thermal conditions should be monitored.

---



---

The following item appears only when you set the CPU Power Phase Control to **[Manual Adjustment]**.

---

#### **Manual Adjustment [Fast]**

Allows you to set a response for the CPU power phase control.

Configuration options: [Ultra Fast] [Fast] [Medium] [Regular]

### CPU Power Duty Control [T.Probe]

DIGI + VRM Duty Control adjusts the current of every VRM phase and the thermal conditions of every phase component.

- |            |   |
|------------|---|
| [T. Probe] | Select to maintain the VRM thermal balance. |
| [Extreme]  | Select to maintain the current VRM balance. |



---

DO NOT remove the thermal module. The thermal conditions should be monitored.

---

### CPU Current Capability [Auto]

DIGI + VRM CPU Current Capability provides wider total power range for overclocking. A higher value setting gets higher VRM power consumption delivery and extends the overclocking frequency range simultaneously.

Configuration options: [Auto] [100%] [110%] [120%] [130%] [140%]



---

Choose a higher value when overclocking or under a high CPU loading for extra power support.

---

### **CPU Power Thermal Control [130]**

A higher temperature brings a wider CPU power thermal range and extends the overclocking tolerance to enlarge the O.C. potential. Use the <+> and <-> keys to adjust the value. The values range from 130 to 151.



---

DO NOT remove the thermal module. The thermal conditions should be monitored.

---

### **CPU Input Boot Voltage [Auto]**

VCCIN for the CPU right at boot. Configuration options: [Auto] [0.800] – [2.440V]

### **DRAM Current Capability [100%]**

A higher value brings a wider total power range and extends the overclocking range simultaneously.

Configuration options: [100%] [110%] [120%] [130%]

### **DRAM Voltage Frequency [Auto]**

Allows you to adjust the DRAM switching frequency. Assign a fixed high DRAM frequency to increase the overclocking range or a low DRAM frequency for a better system stability.

Configuration options: [Auto] [Manual]



---

The following item appears only when you set set the DRAM Frequency Mode item to **[Manual]**.

---

### ***DRAM Fixed Frequency Mode [300]***

Allows you to set a fixed DRAM frequency. Use the <+> or <-> keys to adjust the value. The values range from 300kHz to 500kHz with a 10kHz interval.

### **DRAM Power Phase Control [Auto]**

Allows you to set the power phase control of the DRAM.

- |             |  |
|-------------|--|
| [Auto]      | Allows you to set the Auto mode.                           |
| [Optimized] | Allows you to set the ASUS optimized phase tuning profile. |
| [Extreme]   | Allows you to set the full phase mode.                     |

## Tweakers' Paradise

The subitems in this menu allow you to set the CPU ratio and features.

### **BCLK Tuning**

#### **VCCIN Shadow Voltage [Auto]**

Pseudo Voltage for VCCIN. Configuration options: [Auto] [0.800] – [2.440V]

#### **Termination Anti-Aliasing [Auto]**

Termination Anti-Aliasing can be enabled to smooth out the change of the PLL Termination Voltage, which may sometimes help to yield a better O.C. result.  
Configuration options: [Auto] [Disabled] [Enabled]

#### **Initial PLL Termination Voltage [Auto]**

Initial Voltage at which CPU BCLKs are terminated. Maintaining a level close to CPU Input Voltage will help BCLK Overclock.  
Configuration options: [Auto] [0.0000] - [3.0000]

#### **PLL Termination Reset Voltage [Auto]**

PLL Termination Reset Voltage. Configuration options: [Auto] [0.0000] - [3.0000]

#### **Eventual PLL Termination Voltage [Auto]**

Eventual PLL Termination Voltage. Configuration options: [Auto] [0.0000] - [3.0000]

#### **PCH ICC Voltage [Auto]**

Power Supply for the Integrated Clock Controller. Lower may be better. Configuration options: [Auto] [0.6000] -[2.2000]

#### **ICC Ringback Canceller [Auto]**

ICC Ringback Canceller can be used to control the noise level at the Integrated Clock Controller.

[Enable] to allow better High DMI Frequency O.C.

[Disable] to allow better Low DMI Frequency O.C.

#### **Clock Crossing VBoot [Auto]**

The instantaneous voltage value when the rising edge of BCLK DN is equal to the falling edge of the BCLK DP. Configuration options: [Auto] [0.1000] - [1.9000]

#### **Clock Crossing Reset Voltage [Auto]**

The instantaneous voltage value when the rising edge of BCLK DN is equal to the falling edge of the BCLK DP. Configuration options: [Auto] [0.1000] - [1.9000]

#### **Clock Crossing Voltage [Auto]**

The instantaneous voltage value when the rising edge of BCLK DN is equal to the falling edge of the BCLK DP. Configuration options: [Auto] [0.1000] - [1.9000]

#### **BCLK Amplitude [Auto]**

Allows you to adjust the magnitude of the BCLK.

Configuration options: [Auto] [+5] - [-5]

### **DMI Gen 2 [Auto]**

Allows you to enable or disable DMI Gen 2. Auto means Enabled. Configuration options: [Auto] [Enabled] [Disabled]

### **DMI De-emphasis Control [-6 dB]**

Configure De-emphasis control on DMI. Configuration options: [-6 dB] [-3.5 db]

### **SATA Drive Strength [Auto]**

SATA Drive Strength. Configuration options: [Auto] [+10] [-10]

### **PCIe Tuning**

#### **Internal Graphics [Auto]**

Keep IGD enabled based on setup options.

Configuration options: [Auto] [Disabled] [Enabled]

## **CPU Power Management**

The subitems in this menu allow you to set the CPU ratio and features.

### **Enhanced Intel SpeedStep Technology [Enabled]**

Allows the operating system to dynamically adjust the processor voltage and cores frequency to decrease the average power consumption and decrease average heat production.

Configuration options: [Enabled] [Disabled]

### **Turbo Mode [Enabled]**

Allows you to enable your processor cores to run faster than the base operating frequency when it is below power, current and specification limit.

Configuration options: [Disabled] [Enabled]



---

The following items appear only when you set the Turbo Mode to **[Enabled]**.

---

#### ***Turbo Mode Parameters***

##### ***Long Duration Package Power Limit [Auto]***

Allows you to limit the Turbo Ratio's time duration that exceeds the TDP (Thermal Design Power) for maximum performance. Use the <+> and <-> keys to adjust the value. The values range from 1W to 4096W.

##### ***Package Power Time Window [Auto]***

Also known as Power Limit 1, and allows you to maintain the time window for Turbo Ratio over TDP (Thermal Design Power). Use the <+> and <-> keys to adjust the value. The values range from 1 second to 127 seconds.

##### ***Short Duration Package Power Limit [Auto]***

Also known as Power Limit 2, and allows you to provide rapid protection when the package power exceeds the Power Limit 1. Use the <+> and <-> keys to adjust the value. The values range from 1W to 4096W.

##### ***CPU Integrated VR Current Limit [Auto]\****

Allows you to set a higher current limit to prevent frequency and power throttling when overclocking. Use the <+> and <-> keys to adjust the value. The values range from 0.125 to 1023.875 with a 0.125 interval.

**CPU Internal Power Switching Frequency  
Frequency Tuning Mode [Auto]**

Allows you to increase or decrease the switching frequency of the internal regulator. Decrease to help consume less power or increase to help voltage stability. When this item is set to [+], the Frequency Tuning Offset appears and allows you to set its value from 0% to 6%.



---

\* Appear only when you set the Turbo Mode to [Disabled].

---

**CPU Internal Power Fault Control  
Thermal Feedback [Auto]**

Allows the CPU to take precautionary actions when the thermal conditions of the external regulator exceeds the threshold.

Configuration options: [Auto] [Disabled] [Enabled]

**CPU Integrated VR Fault Management [Auto]**

Allows you to prevent tripping the Fully Integrated Voltage Regulator when doing over-voltage. Configuration options: [Auto] [Disabled] [Enabled]



---

We recommend to set this item to [Disable] when overclocking.

---

**CPU Internal Power Configuration  
CPU Integrated VR Efficiency Management [Auto]**

Allows you to improve power saving when the processor is in low power state. Disable this item to make the Fully Integrated Voltage Regulator work in high performance at all times.

Configuration options: [Auto] [High Performance] [Balanced]

**Power Decay Mode [Auto]**

Allows you to enable this item to improve the power saving on the Fully Integrated Voltage Regulator as the processor goes into low current state.

Configuration options: [Auto] [Disabled] [Enabled]

**Idle Power-in Response [Auto]**

Allows you to set the slew rate for the Fully Integrated Voltage Regulator as it enters manual override mode.

Configuration options: [Auto] [Regular] [Fast]

**Idle Power-out Response [Auto]**

Allows you to set the slew rate for the Fully Integrated Voltage Regulator as it exits manual override mode.

Configuration options: [Auto] [Regular] [Fast]

**Power Current Slope [Auto]**

Allows you to adjust the gradient of the high-speed active phase current balance during load transients to eliminate current imbalance, resulting from a load current oscillating near the switching frequency.

Configuration options: [Auto] [LEVEL -4] - [LEVEL 4]



### **Power Current Offset [Auto]**

Allows you to increase or decrease the output current sensed by the CPU. It finds the balance between optimal regulating while staying below the current threshold.

Configuration options: [Auto] [100%] [87.5%] [75.0%] [62.5%] [50.0%] [37.5%] [25.0%] [12.5%] [0%] [-12.5%] [-25.0%] [-37.5%] [-50.0%] [-62.5%] [-75.0%] [-87.5%] [-100%]

### **Power Fast Ramp Response [Auto]**

Allows you to increase to enhance the response of the voltage regulator during the load transient.

Configuration options: [Auto] [0.00] - [1.50]

### **CPU Internal Power Saving Control**

#### **Power Saving Level 1 Threshold [Auto]**

Lower value provides sufficient overclocking tolerance to enlarge the overclocking potential. Higher value provides better power-saving condition. Use <+> or <-> key to adjust the value. The values range from 0A to 80A at 1Amp increment.

#### **Power Saving Level 2 Threshold [Auto]**

Lower value provides sufficient overclocking tolerance to enlarge the overclocking potential. Higher value provides better power-saving condition. Use <+> or <-> key to adjust the value. The values range from 0A to 50A at 1Amp increment.

#### **Power Saving Level 3 Threshold [Auto]**

Lower value provides sufficient overclocking tolerance to enlarge the overclocking potential. Higher value provides better power-saving condition. Use <+> or <-> key to adjust the value. The values range from 0A to 30A at 1Amp increment.

## **Fully Manual Mode [Enabled]**

Allows you to enable or disable the support for voltage control via ROG Connect or OC Panel. Configuration options: [Enabled] [Disabled]

## **Max Vcore [Disabled]**

When Enabled, you can set the CPU Core Voltage to a value almost as high as the CPU Input Voltage. Configuration options: [Enabled] [Disabled]



---

This allows you to set a very high CPU Core Voltage.

---

## **CPU Core Voltage [Auto]**

Configures the amount of Voltage fed to the Cores of the processor. Increase when increasing Core Frequency. Use <+> or <-> key to adjust the value. The values range from 1.050000V to 2.200000V at 0.003125V increment. Configuration options: [Auto] [Manual Mode] [Offset Mode] [Adaptive Mode]

## Max Cache Voltage [Disabled]

When Enabled, you can set the CPU Core Voltage to a value almost as high as the CPU Input Voltage. Configuration options: [Auto] [Manual Mode] [Offset Mode] [Adaptive Mode]



---

This allows you to set a very high CPU Core Voltage.

---

## CPU Cache Voltage [Auto]

Configures the amount of Voltage fed to the UNCore of the processor including its cache. Increase when increasing CPU Cache Frequency. Use <+> or <-> key to adjust the value. The values range from 1.050000V to 2.200000V at 0.003125V increment.

## CPU Graphics Voltage [Auto]

Configures the amount of Voltage fed to the onboard graphics unit on the processor. Increase when increasing iGPU Frequency. Use <+> or <-> key to adjust the value. The values range from 0.800000V to 1.920000V at 0.001000V increment.

## CPU System Agent Voltage [Auto]

Configures the amount of Voltage fed to the System Agent of the processor including its PCIe Controller and Power Control Unit. Increase when increasing DRAM Frequency. Use <+> or <-> key to adjust the value. The values range from 0.850000V to 2.200000V at 0.003125V increment.

## CPU Analog I/O Voltage [Auto]

Configures the amount of Voltage fed for the Analog portion of the I/O on the processor. Increase when increasing DRAM Frequency. Use <+> or <-> key to adjust the value. The values range from 1.050000V to 2.200000V at 0.003125V increment.

## CPU Digital I/O Voltage [Auto]

Configures the amount of Voltage fed for the Digital portion of the I/O on the processor. Increase when increasing DRAM Frequency. Use <+> or <-> key to adjust the value. The values range from 1.000000V to 2.200000V at 0.003125V increment.

## CPU Interfacing Voltage [Auto]

A reference voltage for transmission on the DMI path. Use <+> or <-> key to adjust the value. The values range from 1.000000V to 1.600000V at 0.003125V increment.

## SVID Support [Auto]

Disabling SVID Support stops the processor from communicating with the external Voltage Regulator. Recommend disabling when overclocking. Configuration options: [Auto] [Enabled] [Disabled]

## Initial CPU Input Voltage [Auto]

Allows you to set the CPU Input Voltage. Use <+> or <-> key to adjust the value. The values range from 0.800V to 2.440V at 0.010V increment.

## Eventual CPU Input Voltage [Auto]

Allows you to set the Eventual CPU Input Voltage. Use <+> or <-> key to adjust the value. The values range from 0.800V to 2.440V at 0.010V increment.

### **DRAM Voltage [Auto]**

Allows you to set the voltage for the system memory. Use <+> or <-> key to adjust the value. The values range from 1.20V to 2.40V at 0.005V increment.

### **PCH VLX Voltage [Auto]**

Allows you to set the PCH VLX voltage. Use <+> or <-> key to adjust the value. The values range from 0.8000V to 2.0000V at 0.00625V increment.

### **PCH Voltage [Auto]**

Allows you to set the PCH voltage. Use <+> or <-> key to adjust the value. The values range from 0.7000V to 1.8000V at 0.00625V increment.

### **VTTDDR Voltage [Auto]**

Allows you to set the VTTDDR voltage. Use <+> or <-> key to adjust the value. The values range from 0.6000V to 1.4000V at 0.00625V increment.

### **DRAM CTRL REF Voltage [Auto]**

Allows you to set the fraction of DRAM voltage given as reference on the Control lines. Use <+> or <-> key to adjust the value. The values range from 0.3950x to 0.6300 at 0.0050x increment.

### **DRAM DATA REF Voltage on CHA [Auto]**

Allows you to set the fraction of DRAM voltage given as reference on the data lines of Channel A. Use <+> or <-> key to adjust the value. The values range from 0.3950x to 0.6300 at 0.0050x

### **DRAM DATA REF Voltage on CHB [Auto]**

Allows you to set the fraction of DRAM voltage given as reference on the data lines of Channel B. Use the <+> or <-> keys to adjust the value.

### **CPU Spread Spectrum [Auto]**

Allows you to enable, disable or set to automatic, the BCLK overclocking ability.  
Configuration options: [Auto] [Enabled] [Disabled]

### **BCLK Recovery [Enabled]**

Allows you to enable or disable the BCLK recovery feature.  
Configuration options: [Enabled] [Disabled] [Ignore]

### 3.5 Main menu

The Main menu screen appears when you enter the Advanced Mode of the BIOS Setup program. The Main menu provides you an overview of the basic system information, and allows you to set the system date, time, language, and security settings.



#### Security

The Security menu items allow you to change the system security settings.

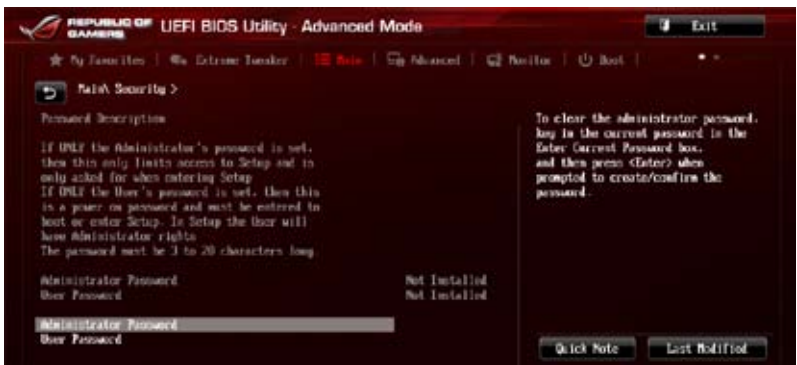

- If you have forgotten your BIOS password, erase the CMOS Real Time Clock (RTC) RAM to clear the BIOS password. See section 1.2.6 Onboard buttons and switches for information on how to erase the RTC RAM via the Clear CMOS button.
- The Administrator or User Password items on top of the screen show the default [Not Installed]. After you set a password, these items show [Installed].

## Administrator Password

If you have set an administrator password, we recommend that you enter the administrator password for accessing the system. Otherwise, you might be able to see or change only selected fields in the BIOS setup program.

### To set an administrator password:

1. Select the **Administrator Password** item and press <Enter>.
2. From the **Create New Password** box, key in a password, then press <Enter>.
3. Confirm the password when prompted.

### To change an administrator password:

1. Select the **Administrator Password** item and press <Enter>.
2. From the **Enter Current Password** box, key in the current password, then press <Enter>.
3. From the **Create New Password** box, key in a new password, then press <Enter>.
4. Confirm the password when prompted.

To clear the administrator password, follow the same steps as in changing an administrator password, but press <Enter> when prompted to create/confirm the password. After you clear the password, the **Administrator Password** item on top of the screen shows **Not Installed**.

## User Password

If you have set a user password, you must enter the user password for accessing the system. The User Password item on top of the screen shows the default Not Installed. After you set a password, this item shows Installed.

### To set a user password:

1. Select the **User Password** item and press <Enter>.
2. From the **Create New Password** box, key in a password, then press <Enter>.
3. Confirm the password when prompted.

### To change a user password:

1. Select the **User Password** item and press <Enter>.
2. From the **Enter Current Password** box, key in the current password, then press <Enter>.
3. From the **Create New Password** box, key in a new password, then press <Enter>.
4. Confirm the password when prompted.

To clear the user password, follow the same steps as in changing a user password, but press <Enter> when prompted to create/confirm the password. After you clear the password, the **User Password** item on top of the screen shows **Not Installed**.

## 3.6 Advanced menu

The Advanced menu items allow you to change the settings for the CPU and other system devices.



Be cautious when changing the settings of the Advanced menu items. Incorrect field values can cause the system to malfunction.



### 3.6.1 CPU Configuration

The items in this menu show the CPU-related information that the BIOS automatically detects.



The items in this menu may vary based on the CPU installed.



#### Intel Adaptive Thermal Monitor [Enabled]

- [Enabled] Enables the overheated CPU to throttle its clock speed to cool down.
- [Disabled] Disables the CPU thermal monitor function.

#### Hyper-threading [Enabled]

Allows a hyper-threading processor to appear as two logical processors, allowing the operating system to schedule two threads or processes simultaneously.

- [Enabled] Two threads per activated core.
- [Disabled] One thread per activated core.

#### Active Processor Cores [All]

Allows you to choose the number of CPU cores to activate in each processor package.  
Configuration options: [All] [1] [2] [3]

#### Limit CPUID Maximum [Disabled]

- [Enabled] Allows legacy operating systems to boot even without support for CPUs with extended CPUID functions.
- [Disabled] Disables this function.

### **Execute Disable Bit [Enabled]**

[Enabled] Enables the No-Execution Page Protection Technology.

[Disabled] Forces the XD feature flag to always return to zero (0).

### **Intel® Virtualization Technology [Disabled]**

[Enabled] Allows a hardware platform to run multiple operating systems separately and simultaneously, enabling one system to virtually function as several systems.

[Disabled] Disables this function.

### **Hardware Prefetcher [Enabled]**

[Enabled] Allows a hardware platform to automatically analyze the requirements and prefetch data and codes for the CPU.

[Disabled] Disables this function.

### **Adjacent Cache Line Prefetch [Enabled]**

[Enabled] Allows a hardware platform to perform adjacent cache line prefetching.

[Disabled] Disables this function.

### **Boot Performance Mode [Max Non-Tu...]**

Allows you to select the performance state that the BIOS will set before OS handoff.

Configuration options: [Max Non-Turbo Performance] [Max Battery] [Turbo Performance]

### **Dynamic Storage Accelerator [Disabled]**

Allows you to enable or disable the Dynamic Storage Accelerator for C state configuration.

Configuration options: [Enabled] [Disabled]

### **CPU Power Management Configuration**

The subitems in this menu allows you to manage and configure the CPU's power.

#### **Enhanced Intel SpeedStep Technology [Enabled]**

Allows you to enable or disable the Enhanced Intel® SpeedStep Technology (EIST).

[Disabled] The CPU runs at its default speed.

[Enabled] The operating system controls the CPU speed.

#### **Turbo Mode [Enabled]**

Allows you to set the processor cores to run faster than the marked frequency in a specific condition. Configuration options: [Enabled] [Disabled]

#### **CPU C States [Auto]**

Allows you to enable or disable the CPU C states.

Configuration options: [Auto] [Enabled] [Disabled]



---

The following items appear only when you set the CPU C States to **[Enabled]**.

---



**Enhanced C1 state [Enabled]**

Allows your processor to reduce power when the system is in idle mode.

Configuration options: [Enabled] [Disabled]

**CPU C3 Report [Enabled]**

Allows you to disable or enable the CPU C3 report to the operating system.

Configuration options: [Enabled] [Disabled]

**CPU C6 Report [Enabled]**

Allows you to disable or enable the CPU C6 report to the operating system.

Configuration options: [Enabled] [Disabled]

**C6 Latency [Short]**

Allows you to set the duration of C6 latency for C6 state.

Configuration options: [Short] [Long]

**CPU C7 Report [CPU C7s]**

Allows you to disable or enable the CPU C7 report to the operating system.

Configuration options: [Disabled] [CPU C7] [CPU C7s]

**C7 Latency [Long]**

Allows you to set the duration of C7 latency for C7 state.

Configuration options: [Short] [Long]

**Package C State Support [Auto]**

Allows you to set the a C-state according to the following configuration options: [Auto] [Enabled] [C0/C1] [C2] [C3] [C6] [CPU C7] [CPU C7s]

## 3.6.2 PCH Configuration



### PCI Express Configuration

Allows you to configure the PCI Express slots.

**DMI Link ASPM Control [Auto]**

Allows you to control the ASPM (Active State Power Management) on both Northbridge side and Southbridge side of the DMI Link.

Configuration options: [Auto] [Disabled] [Enabled]

### **ASPM Support [Disabled]**

Allows you to set the ASPM level.

Configuration options: [Disabled] [Auto] [L0s] [L1] [L0sL1]

### **PCIe Speed [Auto]**

Allows you to select the PCI Express port speed.

Configuration options: [Auto] [Gen1] [Gen2]

## **Intel (R) Rapid Start Technology [Disabled]**

Allows you to enable or disable Intel Rapid Start Technology.

Configuration options: [Enabled] [Disabled]



---

The following items appear only when you set the Intel® Rapid Start Technology to **[Enabled]**.

---

### **Entry on S3 RTC Wake [Enabled]**

The system automatically wakes up and set to Rapid Start Technology S4 mode.

Configuration options: [Enabled] [Disabled]

#### ***Entry After [0]***

This item appears only when you set the **Entry on S3 RTC Wake to [Enabled]**. This item allows you to enable the RTC wake timer at S3 entry.

The value ranges from 0 (Immediately) to 120 minutes

### **Active Page Threshold Support [Enabled]**

Allows you to enable or disable the IRST with additional partition size.

Configuration options: [Enabled] [Disabled]



---

Ensure that the caching partition size is larger than the total memory size.

---

#### ***Active Memory Threshold [0]***

This item appears only when you set the **Active Page Threshold Support to [Enabled]**. This item allows you to allocate a partition size for Active Page Threshold.

### **Hybrid Hard Disk Support [Disabled]**

Allows you to enable or disable Hybrid Hard Disk support.

Configuration options: [Enabled] [Disabled]

## **Intel (R) Smart Connect Technology**

### **ISCT Support [Disabled]**

Allow you to enable or disable the Intel® Smart Connect Technology.

Configuration options: [Enabled] [Disabled]

### 3.6.3 SATA Configuration

While entering Setup, the BIOS automatically detects the presence of SATA devices. The SATA Port items show **Empty** if no SATA device is installed to the corresponding SATA port. Scroll down to display the other BIOS items.



#### SATA Mode Selection [AHCI]

Allows you to set the SATA configuration.

[Disabled] Disables the SATA function.

[IDE] Set to [IDE] when you want to use the Serial ATA hard disk drives as Parallel ATA physical storage devices.

[AHCI] Set to [AHCI] when you want the SATA hard disk drives to use the AHCI (Advanced Host Controller Interface). The AHCI allows the onboard storage driver to enable advanced Serial ATA features that increases storage performance on random workloads by allowing the drive to internally optimize the order of commands.

[RAID] Set to [RAID] when you want to create a RAID configuration from the SATA hard disk drives.

#### Aggressive LPM Support [Auto]

Allows you to enable the PCH to aggressively enter link power state.

Configuration options: [Auto] [Disabled] [Enabled]

### S.M.A.R.T. Status Check [Enabled]

S.M.A.R.T. (Self-Monitoring, Analysis and Reporting Technology) is a monitor system. When read/write of your hard disk errors occur, this feature allows the hard disk to report warning messages during the POST. Configuration options: [Enabled] [Disabled]

### Hot Plug [Disabled] (SATA6G\_1 - SATA6G\_6 [Red])

These items appear only when you set the SATA Mode Selection item to [AHCI] or [RAID], and allow you to enable/disable SATA Hot Plug Support.

Configuration options: [Disabled] [Enabled]

## 3.6.4 System Agent Configuration



### CPU Audio Devices [Enabled]

Allows you to enable or disable CPU SA Audio devices.

Configuration options: [Enabled] [Disabled]

### Graphics Configuration

Allows you to select a primary display from iGPU, and PCIe graphical devices.

#### Primary Display [Auto]

Allows you to select the primary display from iGPU, PCIE and PCI Graphics devices.

Configuration options: [Auto] [iGPU] [PCIE]

#### iGPU Multi-Monitor [Disabled]

Allows you to enable the iGPU Multi-Monitor. The iGPU shared system memory size will be fixed at 64MB.

Configuration options: [Disabled] [Enabled]

### NB PCIe Configuration

Allows you to configure the NB PCI Express settings.

#### PCIEx16\_1/2 Link Speed [Auto]

Allows you to configure the PCIEx16 speed for slots 1 and 2.

Configuration options: [Auto] [Gen1] [Gen2] [Gen3]

**DMI Link ASPM Control [Auto]**

Allows you to enable or disable the control of Active State Power Management on SA side of the DMI Link.

Configuration options: [Auto] [Disabled] [L0s] [L1] [L0sL1]

**PEG - ASPM [Disabled]**

Allows you to control ASPM support for the PEG device.

Configuration options: [Disabled] [Auto] [ASPM L0s] [ASPM L1] [ASPM L0sL1]

**Memory Configuration**

Allows you to configure the memory configuration parameters.

**Memory Scrambler [Enabled]**

Allows you to enable or disable the Memory Scrambler support.

Configuration options: [Enabled] [Disabled]

**Memory Remap [Enabled]**

Allows you to enable remapping the memory above 4GB.

Configuration options: [Enabled] [Disabled]

## 3.6.5 USB Configuration

The items in this menu allow you to change the USB-related features.



The **USB Devices** item shows the auto-detected values. If no USB device is detected, the item shows **None**.

### Legacy USB Support [Enabled]

- [Enabled] Enables the support for USB devices on legacy operating systems (OS).
- [Disabled] The USB devices can be used only for the BIOS setup program. It cannot be recognized in boot devices list.
- [Auto] Allows the system to detect the presence of USB devices at startup. If detected, the USB controller legacy mode is enabled. If no USB device is detected, the legacy USB support is disabled.

### Intel xHCI Mode [Smart Auto]

- [Auto] Keeps the last operation of xHCI controller in OS during bootup.
- [Smart Auto] Enables the operation of xHCI controller.
- [Enabled] Enables the xHCI controller.
- [Disabled] Disables the xHCI controller.

### EHCI Hand-off [Disabled]

- [Enabled] Enables the support for operating systems without an EHCI hand-off feature.
- [Disabled] Disables the EHCI Hand-off support.

### USB Single Port Control

Allows you to enable or disable the individual USB port.



Refer to section **1.2.2 Motherboard layout** for the location of the USB ports.

## 3.6.6 Platform Misc Configuration

The items in this menu allow you to configure the platform-related features.



### PCI Express Native Power Management [Disabled]

Allows you to enhance the power saving feature of PCI Express and perform ASPM operations in the operating system.

Configuration options: [Disabled] [Enabled]



---

The following item appears only when you set the PCI Express Native Power Management to **[Enabled]**.

---

### Native ASPM [Disabled]

[Enabled] Vista controls the ASPM support for the device.

[Disabled] BIOS controls the ASPM support for the device.

## 3.6.7 Onboard Devices Configuration

Scroll down to view the other BIOS items.



### HD Audio Controller [Enabled]

[Enabled] Enables the High Definition Audio Controller.

[Disabled] Disables the controller.



---

The following items appear only when you set the HD Audio Controller to **[Enabled]**.

---

### Front Panel Type [HD]

Allows you to set the front panel audio connector (AAFP) mode to legacy AC'97 or high-definition audio depending on the audio standard that the front panel audio module supports.

[HD] Sets the front panel audio connector (AAFP) mode to high definition audio.

[AC97] Sets the front panel audio connector (AAFP) mode to legacy AC'97

### SPDIF Out Type [SPDIF]

[SPDIF] Sets to an SPDIF audio output.

[HDMI] Sets to an HDMI audio output.



### **ASM1061 Storage Controller (SATA6G\_E12) [Enabled]**

Allows you to select the ASM1061 storage controller operating mode.

[Disabled]        Disables the ASM1061 storage controller.

[Enabled]         Enables the ASM1061 storage controller.

### **Hot-plug [Disabled]**

Allows you to set the Hot Plug support.

Configuration options: [Disabled] [Enabled]

### **Intel LAN Controller [Enabled]**

[Enabled]         Enables the Intel® LAN controller.

[Disabled]        Disables the Intel® LAN controller.



---

The following item appears only when you set the Intel LAN Controller to **[Enabled]**.

---

### **Intel PXE OPROM [Disabled]**

This item appears only when you set the previous item to **[Enabled]** and allows you to enable or disable the PXE OptionRom of the Intel® LAN controller.

Configuration options: [Enabled] [Disabled]

## 3.6.8 APM



### ErP Ready [Disabled]

Allows you to switch off some power at S4+S5 or S5 to get the system ready for ErP requirement. When set to **[Enabled]**, all other PME options will be switched off.

Configuration options: [Disabled] [Enabled (S4+S5)] [Enabled (S5)]

### Restore AC Power Loss [Power Off]

[Power On] The system goes into ON state after an AC power loss.

[Power Off] The system goes into OFF state after an AC power loss.

[Last State] The system goes into either OFF or ON state, whatever the system state was before the AC power loss.

### Power On By PCIE/PCI [Disabled]

[Disabled] Disables the PCIE/PCI devices to generate a wake-on-LAN feature of the Intel®/Realtek LAN device or other installed PCIE LAN devices.

[Enabled] Enables the PCIE/PCI devices to generate a wake-on-LAN feature of the PCIE LAN devices.

### Power On By RTC [Disabled]

[Disabled] Disables RTC to generate a wake event.

[Enabled] When set to **[Enabled]**, the items **RTC Alarm Date (Days)** and **Hour/Minute/Second** will become user-configurable with set values.

### 3.6.9 Network Stack



#### Network Stack [Disabled]

This item allows you to disable or enable the UEFI network stack.

Configuration options: [Disabled] [Enable]



The following items appear only when you set the Network Stack to [Enabled].

#### Ipv4/Ipv6 PXE Support [Enabled]

Allows you to enable or disable the Ipv4/Ipv6 PXE boot option.

Configuration options: [Disabled] [Enabled]

### 3.6.10 ROG Effects



#### ROG Pulse [Enabled]

This item allows you to enable the ROG Logo animation on the upper left corner of the main menu. Configuration options: [Disabled] [Enabled]

#### Onboard LED [Enabled]

This item allows you to enable all the onboard LEDs. Configuration options: [Enabled] [Disabled]

#### SupremeFX Lighting LED [Enabled]

This item allows both Red line LED and SupremeFX logo LED turn on or off at the same time by your setting. Configuration options: [Enabled] [Disabled]

## 3.7 Monitor menu

The Monitor menu displays the system temperature/power status, and allows you to change the fan settings.



### Anti Surge Support [Enabled]

This item allows you to enable or disable the Anti Surge function.

Configuration options: [Disabled] [Enabled]

### Voltage Monitor

**CPU Core 0-3 Voltage; CPU Cache Voltage; CPU System Agent Voltage; CPU Analog I/O Voltage; CPU Digital I/O Voltage; CPU Input Voltage; DRAM Voltage; PCH Voltage; 3.3V Voltage; 5V Voltage; 12V Voltage**

The onboard hardware monitor automatically detects the voltage output through the onboard voltage regulators. Press <Enter> and select [Ignore] if you do not wish to display the detected temperatures.

### Temperature Monitor

**CPU Temperature; MB Temperature [xxx°C/xxx°F]**

The onboard hardware monitor automatically detects and displays the CPU, and motherboard. Press <Enter> and select [Ignore] if you do not wish to display the detected temperatures.

### Fan Speed Monitor

**CPU FAN Speed; CPU OPT Speed; Chassis FAN1/2/3 Speed [xxxxRPM] or [Ignored] / [N/A]**

The onboard hardware monitor automatically detects and displays the CPU fan, chassis fan, and optional fan speed in rotations per minute (RPM). If any of the fans is not connected to the motherboard, the field shows [N/A]. These items are not user-configurable. Press <Enter> and select [Ignore] if you do not wish to display the detected temperatures.

## Fan Speed Control

### CPU Q-Fan Control [Auto]

- [Disabled] Disables the Q-Fan control.
- [Auto] Enables the CPU Q-Fan control for 4-pin CPU fan. Select this mode for the PWM mode Q-Fan control.
- [Advance Mode] When a 3-pin CPU fan is installed, select this mode for the DC mode Q-Fan control.



---

The following items appear only when you set the CPU Q-Fan Control to **[Advance Mode]** and **[Auto]**.

---

### CPU Fan Speed Low Limit [600 RPM]

Allows you to disable or set the CPU fan warning speed.

Configuration options: [Ignore] [200 RPM] [300 RPM] [400 RPM] [500 RPM] [600 RPM]

#### CPU Fan Profile [Standard]

Allows you to set the appropriate performance level of the CPU fan.

- [Standard] Set to make the CPU fan adjust automatically depending on the CPU temperature.
- [Silent] Set to minimize the fan speed for quiet CPU fan operation.
- [Turbo] Set to achieve maximum CPU fan speed.
- [Manual] Set to assign the detailed fan speed control parameters.



---

The following items appear only when you set the CPU Fan Profile to **[Manual]**.

---

#### **CPU Upper Temperature [70]**

The upper temperature range is 20 to 75 degree at 1 degree increment.

#### **CPU Fan Max. Duty Cycle(%) [100]**

The maximums duty cycle range is 40 to 100% at 1% increment.

#### **CPU Lower Temperature [20]**

The lower temperature range is 20 to 75 degree at 1 degree increment.

#### **CPU Fan Min. Duty Cycle(%) [40]**

The minimums duty cycle range is 40% to 100% at 1% increment.

### **Chassis1/Chassis2/Chassis3 Q-Fan Control [Enabled]**

[Disabled] Disables the Chassis Q-Fan control feature.

[Enabled] Enables the Chassis Q-Fan control feature.

### **Chassis1/Chassis2/Chassis3 Fan Speed Low Limit [600 RPM]**

This item appears only when you enable the **Chassis Q-Fan Control** feature and allows you to disable or set the chassis fan warning speed.

Configuration options: [Ignore] [200 RPM] [300 RPM] [400 RPM] [500 RPM] [600 RPM]



---

The following items appears only when you set the Chassis1/Chassis2/Chassis3 Q-Fan Control feature to **[Enabled]**.

---

### **Chassis1/Chassis2/Chassis3 Fan Profile [Standard]**

This item allows you to set the appropriate performance level of the chassis fan.

[Standard] Sets to [Standard] to make the chassis fan automatically adjust depending on the chassis temperature.

[Silent] Sets to [Silent] to minimize the fan speed for quiet chassis fan operation.

[Turbo] Sets to [Turbo] to achieve maximum chassis fan speed.

[Manual] Sets to [Manual] to assign detailed fan speed control parameters.

---

The following four items appear only when you set **Chassis1/Chassis2/Chassis3 Fan Profile** to **[Manual]**.

---

#### ***Chassis1/Chassis2/Chassis3 Upper Temperature [70]***

Use the <+> and <-> keys to adjust the upper limit of the chassis temperature. The values range from 40°C to 75°C.

#### ***Chassis1/Chassis2/Chassis3 Fan Max. Duty Cycle(%) [100]***

Use the <+> and <-> keys to adjust the maximum chassis fan duty cycle. The values range from 60% to 100%. When the chassis temperature reaches the upper limit, the chassis fan will operate at the maximum duty cycle.

#### ***Chassis1/Chassis2/Chassis3 Lower Temperature [40]***

Displays the lower limit of the chassis temperature.

#### ***Chassis1/Chassis2/Chassis3 Fan Min. Duty Cycle(%) [60]***

Use the <+> and <-> keys to adjust the minimum chassis fan duty cycle. The values range from 60% to 100%. When the chassis temperature is under 40°C, the chassis fan will operate at the minimum duty cycle.

## 3.8 Boot menu

The Boot menu items allow you to change the system boot options.

Scroll down to display the other BIOS items.



### Boot Configuration

#### Fast Boot [Enabled]

[Disabled] Allows your system to go back to its normal boot speed.

[Enabled] Allows your system to accelerate the boot speed.



The following items appear only when you set the Fast Boot to **[Enabled]**.

#### USB Support [Partial In...]

[Disabled] All USB devices will not be available until OS boot up for a fastest POST time.

[Full Initialization] All USB devices will be available during POST. This process will extend the POST time.

[Partial Initialization] For a faster POST time, only USB ports with keyboard and mouse connections will be detected.

#### Network Stack Driver Support [Disabled]

[Disabled] Select to skip the network stack driver from loading during POST.

[Enabled] Select to load the network stack driver during POST.

#### Next Boot after AC Power Loss [Normal Boot]

[Normal Boot] Returns to normal boot on the next boot after an AC power loss.

[Fast Boot] Accelerates the boot speed on the next boot after an AC power loss.

### HW Fast Boot [Disabled]

Allows the system to enable or disable the HW Fast Boot.

Configuration options: [Disabled] [Enabled]

### DirectKey Enable [Go to BIOS...]

[Disabled] Disables the DirectKey button. The system will only power on or off when you press the DirectKey button.

[Go to BIOS Setup] Allows the system to power on and go to the BIOS Setup directly when you press the DirectKey button.

### Boot Logo Display [Auto]

[Auto] Auto adjustments for Windows requirements.

[Full Screen] Maximize the boot logo size.

[Disabled] Hid the logo during POST.



---

The following items appears only when you set the Boot Logo Display item to **[Disabled]**.

---

### Post Report [5 sec]

This item allows you to select the desired Post Report waiting time. The values range from 0 to 10 seconds or until the <Esc> button is pressed.



---

The following items appears only when you set the Boot Logo Display item to **[Auto]** or **[Full Screen]**.

---

### Post Delay Time [3 sec]

This item allows you to select a desired additional POST waiting time to easily enter the BIOS Setup. You can only execute the POST delay time during normal boot. The values range from 0 to 10 seconds.



---

This feature will only work when set under normal boot.

---

### Bootup NumLock State [On]

[On] Set the power-on state of the NumLock to **[On]**.

[Off] Set the power-on state of the NumLock to **[Off]**.

### Wait For 'F1' If Error [Enabled]

[Disabled] Disables the function.

[Enabled] The system waits for the <F1> key to be pressed when error occurs.



## Option ROM Messages [Force BIOS]

- [Force BIOS] The third-party ROM messages will be forced to display during the boot sequence.
- [Keep Current] The third-party ROM messages will be displayed only if the third-party manufacturer had set the add-on device to do so.

## Interrupt 19 Capture [Disabled]

When set to [Enabled], allows the option ROMs to trap Interrupt 19.

Configuration options: [Enabled] [Disabled]

## Setup Mode [Advanced Mode]

- [Advanced Mode] Sets Advanced Mode as the default screen for entering the BIOS setup program.
- [EZ Mode] Sets EZ Mode as the default screen for entering the BIOS setup program.

## CSM (Compatibility Support Module)

Allows you to configure the CSM (Compatibility Support Module) items to fully support the various VGA, bootable devices and add-on devices for better compatibility.

### Launch CSM [Enabled]

- [Auto] The system automatically detects the bootable devices and the add-on devices.
- [Enabled] For better compatibility, enable the CSM to fully support the non-UEFI driver add-on devices or the Windows® UEFI mode.
- [Disabled] Disable the CSM to fully support the non-UEFI driver add-on devices or the Windows® UEFI mode.



---

The following items appear when you set the Launch CSM to **[Enabled]**.

---

### ***Boot Device Control [UEFI and Legacy OpROM]***

Allows you to select the type of devices that you want to boot.

Configuration options: [UEFI and Legacy OpROM] [Legacy OpROM only] [UEFI only]

### ***Boot from Network Devices [Legacy OpROM first]***

Allows you to select the type of network devices that you want to launch.

Configuration options: [Legacy OpROM first] [UEFI driver first] [Ignore]

### ***Boot from Storage Devices [Legacy OpROM first]***

Allows you to select the type of storage devices that you want to launch.

Configuration options: [Both, Legacy OpROM first] [Both, UEFI first] [Legacy OpROM first] [UEFI driver first] [Ignore]

### ***Boot from PCIe/PCI Expansion Devices [Legacy OpROM first]***

Allows you to select the type of PCIe/PCI expansion devices that you want to launch.

Configuration options: [Legacy OpROM first] [UEFI driver first]

## Secure Boot

Allows you to configure the Windows® Secure Boot settings and manage its keys to protect the system from unauthorized access and malwares during POST.

### OS Type [Windows UE..]

- |                     |  |
|---------------------|--|
| [Windows UEFI Mode] | Allows you to select your installed operating system. Execute the Microsoft® Secure Boot check. Only select this option when booting on Windows® UEFI mode or other Microsoft® Secure Boot compliant OS. |
| [Other OS]          | Get the optimized function when booting on Windows® non-UEFI mode. Microsoft® Secure Boot only supports Windows® UEFI mode.  |



---

The following item appears only when you set the OS Type to **[Windows UEFI mode]**.

---

### Key Management

This item appears only when you set OS Type to **[Windows UEFI Mode]**. It allows you to manage the Secure Boot keys.

#### **Clear Secure Boot keys**

This item appears only when you load the default Secure Boot keys. This item allows you to clear all default Secure Boot keys.

#### **Save Secure Boot Keys**

Allows you to save the PK (Platform Keys) to a USB storage device.

### PK Management

The Platform Key (PK) locks and secures the firmware from any permissible changes. The system verifies the PK before your system enters the OS.

#### **Delete PK**

Allows you to delete the PK from your system. Once the PK is deleted, all the system's Secure Boot keys will not be active.

Configuration options: [Yes] [No]

#### **Load PK from File**

Allows you to load the downloaded PK from a USB storage device.



---

The PK file must be formatted as a UEFI variable structure with time-based authenticated variable.

---

### KEK Management

The KEK (Key-exchange Key or Key Enrollment Key) manages the Signature database (db) and Revoked Signature database (dbx).



---

Key-exchange Key (KEK) refers to Microsoft® Secure Boot Key-Enrollment Key (KEK).

---

**Delete the KEK**

Allows you to delete the KEK from your system.

Configuration options: [Yes] [No]

**Load KEK from File**

Allows you to load the downloaded KEK from a USB storage device.

**Append KEK from File**

Allows you to load the additional KEK from a storage device for an additional db and dbx loaded management.



---

The KEK file must be formatted as a UEFI variable structure with time-based authenticated variable.

---

### DB Management

The db (Authorized Signature database) lists the signers or images of UEFI applications, operating system loaders, and UEFI drivers that you can load on the single computer.

**Delete the db**

Allows you to delete the db file from your system.

Configuration options: [Yes] [No]

**Load db from File**

Allows you to load the downloaded db from a USB storage device.

**Append db from File**

Allows you to load the additional db from a storage device so that more images can be loaded securely.



---

The db file must be formatted as a UEFI variable structure with time-based authenticated variable.

---

### DBX Management

The dbx (Revoked Signature database) lists the forbidden images of db items that are no longer trusted and cannot be loaded.

**Delete the dbx**

Allows you to delete the dbx file from your system.

**Load dbx from File**

Allows you to load the downloaded dbx from a USB storage device.

Configuration options: [Yes] [No]

**Append dbx from File**

Allows you to load the additional dbx from a storage device so that more db's images cannot be loaded.



---

The dbx file must be formatted as a UEFI variable structure with time-based authenticated variable.

---

## 3.9 Tools menu

The Tools menu items allow you to configure options for special functions. Select an item then press <Enter> to display the submenu.



### 3.9.1 ASUS EZ Flash 2 Utility

Allows you to run ASUS EZ Flash 2. When you press <Enter>, a confirmation message appears. Use the left/right arrow key to select between [Yes] or [No], then press <Enter> to confirm your choice.



For more details, refer to section 3.11.2 ASUS EZ Flash 2 utility.

### 3.9.2 ROG Secure Erase

SSD speeds may lower over time as with any storage medium due to data processing. Secure Erase completely and safely cleans your SSD, restoring it to factory performance levels.



Secure Erase is only available in AHCI mode. Ensure to set the SATA mode to AHCI. Click **Advanced > SATA Configuration > AHCI**.

To launch ROG SSD Secure Erase, click **Tool > ROG SSD Secure Erase** on the Advanced mode menu.



Check the ASUS support site for a full list of SSDs tested with Secure Erase. The drive may become unstable if you run Secure Erase on an incompatible SSD.



- The time to erase the contents of your SSD may take a while depending on its size. Do not turn off the system during the process.
- Secure Erase is only supported on Intel SATA port. For more information about Intel SATA ports, refer to section 1.2.2 of this manual.



---

#### Status definition:

- Frozen** The frozen state is the result of a BIOS protective measure. The BIOS guards drives that do not have password protection by freezing them prior to booting. If the drive is frozen, a power off or hard reset of your PC must be performed to proceed with the Secure Erase.
- Locked** SSDs might be locked if the Secure Erase process is either incomplete or was stopped. This may be due to a third party software that uses a different password defined by ASUS. You have to unlock the SSD in the software before proceeding with Secure Erase.
-

### 3.9.3 ASUS O.C. Profile

This item allows you to store or load multiple BIOS settings.



The O.C. Profile Configuration items show **Not Installed** if no profile is created.

#### Add your CMOS Profile

##### Label

Allows you to input the label of the setup profiles.

##### Save to Profile

Allows you to save the current BIOS settings to the BIOS Flash, and create a profile. Key in a profile number from one to eight, press <Enter>, and then select **Yes**.

#### Load CMOS Profile

##### Load from Profile

Allows you to load the previous BIOS settings saved in the BIOS Flash. Key in the profile number that saved your BIOS settings, press <Enter>, and then select **Yes**.



- DO NOT shut down or reset the system while updating the BIOS to prevent the system boot failure!
- We recommend that you update the BIOS file only coming from the same memory/ CPU configuration and BIOS version.

#### Load/Save CMOS Profile From/To USB drive

This item allows you to load or save CMOS profiles from or to the USB drive when clicked or selected.

### 3.9.3 ASUS SPD Information

Allows you to view the DRAM SPD information.



### 3.9.4 ROG OC Panel H-Key Configure

The ROG OC Panel H-Key Configure allows you to input and save values on the CPU core voltage, CPU input voltage, BCLK Frequency, and CPU ratio in the UEFI BIOS. The saved values can be synchronized to a compatible OC Panel device and these values can be tweaked or configured using the OC Panel without going to the BIOS menu.



### **CPU Core Voltage [Auto]**

This item allows you to configure the amount of Voltage fed to the cores of the processor. You can use <+> or <-> key to raise or reduce the voltage by an increment of 0.003125V. The minimum voltage is 1.05000V and the maximum voltage is 2.20000V.

### **CPU Input Voltage [Auto]**

This item allows you to configure the input voltage to the cores of the processor. You can use <+> or <-> key to raise the voltage by an increment of 0.010V. The minimum voltage is 0.800V and the maximum voltage is 3.040V.

### **BCLK Frequency [Auto]**

This item allows you to input values to the Base Clock (BCLK) Frequency that ranges from 60 MHz to 300 MHz.

### **CPU Ratio [Auto]**

This item allows you to adjust the CPU ratio. The CPU ratio may vary according to the model of the processor.

### **Load Default**

This item allows you to load the default values of the CPU Core Voltage, CPU Input Voltage, BCLK Frequency, and CPU Ratio. The **Load Default** resets all values to **[Auto]**.

### **Save Above Settings**

This item allows you to save the new values of the CPU Core Voltage, CPU Input Voltage, BCLK Frequency, and CPU Ratio.

### **Load from profile**

This item allows you to load the previous values of the CPU Core Voltage, CPU Input Voltage, BCLK Frequency, and CPU Ratio.



## 3.10 Exit menu

The Exit menu items allow you to load the optimal default values for the BIOS items, and save or discard your changes to the BIOS items. You can access the EZ Mode from the Exit menu.



### Load Optimized Defaults

This option allows you to load the default values for each of the parameters on the Setup menus. When you select this option or if you press <F5>, a confirmation window appears. Select **Yes** to load the default values.

### Save Changes & Reset

Once you are finished making your selections, choose this option from the Exit menu to ensure the values you selected are saved. When you select this option or if you press <F10>, a confirmation window appears. Select **Yes** to save changes and exit.

### Discard Changes & Exit

This option allows you to exit the Setup program without saving your changes. When you select this option or if you press <Esc>, a confirmation window appears. Select **Yes** to discard changes and exit.

### ASUS EZ Mode

This option allows you to enter the EZ Mode screen.

### Launch EFI Shell from filesystem device

This option allows you to attempt to launch the EFI Shell application (shellx64.efi) from one of the available filesystem devices.

## 3.11 Updating BIOS

The ASUS website publishes the latest BIOS versions to provide enhancements on system stability, compatibility, or performance. However, BIOS updating is potentially risky. If there is no problem using the current version of BIOS, DO NOT manually update the BIOS. Inappropriate BIOS updating may result in the system's failure to boot. Carefully follow the instructions of this chapter to update your BIOS if necessary.



---

Visit the ASUS website at [www.asus.com](http://www.asus.com) to download the latest BIOS file for this motherboard.

---

The following utilities allow you to manage and update the motherboard BIOS setup program.

1. EZ Update: Updates the BIOS in Windows® environment.
2. ASUS EZ Flash 2: Updates the BIOS using a USB flash drive.
3. ASUS CrashFree BIOS 3: Restores the BIOS using the motherboard support DVD or a USB flash drive when the BIOS file fails or gets corrupted.
4. ASUS BIOS Updater: Updates and back ups the BIOS in DOS environment using the motherboard support DVD and a USB flash disk drive.

### 3.11.1 EZ Update

The EZ Update is a utility that allows you to update the motherboard BIOS in Windows® environment.



- 
- EZ Update requires an Internet connection either through a network or an ISP (Internet Service Provider).
  - This utility is available in the support DVD that comes with the motherboard package.
-

### 3.11.2 ASUS EZ Flash 2

ASUS EZ Flash 2 allows you to update the BIOS without having to use a bootable floppy disk or an OS-based utility.



Before you start using this utility, download the latest BIOS from the ASUS website at [www.asus.com](http://www.asus.com).

#### To update the BIOS using EZ Flash 2:

1. Insert the USB flash disk that contains the latest BIOS file to the USB port.
2. Enter the Advanced Mode of the BIOS setup program. Go to the Tool menu to select ASUS EZ Flash Utility and press <Enter> to enable it.



3. Press <Tab> to switch to the Drive field.
4. Press the Up/Down arrow keys to find the USB flash disk that contains the latest BIOS, and then press <Enter>.
5. Press <Tab> to switch to the Folder Info field.
6. Press the Up/Down arrow keys to find the BIOS file, and then press <Enter> to perform the BIOS update process. Reboot the system when the update process is done.



- 
- This function can support devices such as a USB flash disk with FAT 32/16 format and single partition only.
  - DO NOT shut down or reset the system while updating the BIOS to prevent system boot failure!
- 



Ensure to load the BIOS default settings to ensure system compatibility and stability. Select the Load Optimized Defaults item under the Exit menu. See section 3.9 **Exit Menu** for details.

---

### 3.11.3 ASUS CrashFree BIOS 3

The ASUS CrashFree BIOS 3 utility is an auto recovery tool that allows you to restore the BIOS file when it fails or gets corrupted during the updating process. You can restore a corrupted BIOS file using the motherboard support DVD or a USB flash drive that contains the BIOS file.



The BIOS file in the motherboard support DVD may be older than the BIOS file published on the ASUS official website. If you want to use the newer BIOS file, download the file at [support.asus.com](http://support.asus.com) and save it to a USB flash drive.

---

## Recovering the BIOS

### To recover the BIOS:

1. Turn on the system.
2. Insert the motherboard support DVD to the optical drive, or the USB flash drive containing the BIOS file to the USB port.
3. The utility automatically checks the devices for the BIOS file. When found, the utility reads the BIOS file and enters ASUS EZ Flash 2 automatically.
4. The system requires you to enter BIOS Setup to recover the BIOS setting. To ensure system compatibility and stability, we recommend that you press <F5> to load default BIOS values.



DO NOT shut down or reset the system while updating the BIOS! Doing so can cause system boot failure!

---

### 3.11.4 ASUS BIOS Updater

The ASUS BIOS Updater allows you to update the BIOS in DOS environment. This utility also allows you to copy the current BIOS file that you can use as a backup when the BIOS fails or gets corrupted during the updating process.



---

The succeeding utility screens are for reference only. The actual utility screen displays may not be same as shown.

---

#### Before updating BIOS

1. Prepare the motherboard support DVD and a USB flash drive in FAT32/16 format and single partition.
2. Download the latest BIOS file and BIOS Updater from the ASUS website at <http://support.asus.com> and save them on the USB flash drive.



- NTFS is not supported under DOS environment. Do not save the BIOS file and BIOS Updater to a hard disk drive or USB flash drive in NTFS format.
  - Do not save the BIOS file to a floppy disk due to low disk capacity.
- 

3. Turn off the computer and disconnect all SATA hard disk drives (optional).

#### Booting the system in DOS environment

1. Insert the USB flash drive with the latest BIOS file and BIOS Updater to the USB port.
2. Boot your computer. When the ASUS Logo appears, press <F8> to show the BIOS Boot Device Select Menu. Insert the support DVD into the optical drive and select the optical drive as the boot device.

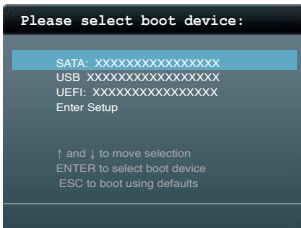

- When the Make Disk menu appears, select the FreeDOS command prompt item by pressing the item number.
- At the FreeDOS prompt, type d: and press <Enter> to switch the disk from Drive C (optical drive) to Drive D (USB flash drive).

```

Welcome to FreeDOS (http://www.freedos.org) !
C:\>d:
D:\>

```

## Updating the BIOS file

### To update the BIOS file using BIOS Updater:

- At the FreeDOS prompt, type bupdater /pc /g and press <Enter>.

```
D:\>bupdater /pc /g
```

- The BIOS Updater screen appears as below.

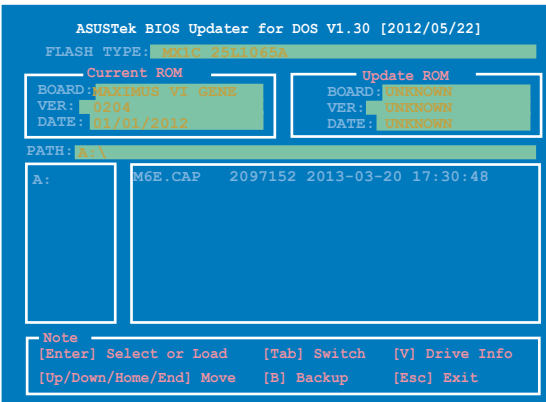

- Press <Tab> to switch between screen fields and use the <Up/Down/Home/End> keys to select the BIOS file and press <Enter>. BIOS Updater checks the selected BIOS file and prompts you to confirm BIOS update.



4. Select Yes and press <Enter>. When BIOS update is done, press <ESC> to exit BIOS Updater. Restart your computer.



---

DO NOT shut down or reset the system while updating the BIOS to prevent system boot failure!

---



- For BIOS Updater version 1.04 or later, the utility automatically exits to the DOS prompt after updating BIOS.
  - Ensure to load the BIOS default settings to ensure system compatibility and stability. Select the **Load Optimized Defaults** item under the **Exit BIOS** menu. See Chapter 3 of your motherboard user manual for details.
  - Ensure to connect all SATA hard disk drives after updating the BIOS file if you have disconnected them.
-





# Software support

## 4.1 Installing an operating system



- This motherboard supports Windows® 8 32/64-bit and Windows® 7 32/64-bit operating systems (OS).
- **Motherboard settings and hardware options vary. Use the setup procedures presented in this chapter for reference only. Refer to your OS documentation for detailed information.**

## 4.2 Support DVD information



The contents of the support DVD are subject to change at any time without notice. Visit the ASUS website at [www.asus.com](http://www.asus.com) for updates.

### 4.2.1 Running the support DVD



Ensure that you have an Administrator account before running the support DVD in Windows® 7 or Windows® 8 OS.

To run the support DVD:

1. Place the Support DVD into the optical drive.
2. In the **AutoPlay** dialog box, click **Run ASSETUP.exe**.

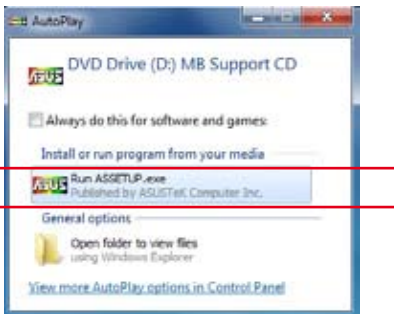

If the **AutoPlay** dialog box does not appear, browse the contents of the support DVD and double-click or tap **\\bin\\ASSETUP.EXE** to launch the **ASUS motherboard support DVD** main menu.

## Support DVD main menu

The Drivers menu shows the available device drivers if the system detects installed devices. Install the necessary drivers to use the devices.

The Manual menu contains the list of supplementary user manuals. Click an item to open the folder of the user manual.

The Video menu contains ROG related videos.

The Utilities menu shows the applications and other software that the motherboard supports.

Click an item to install



Click the Contact tab to display the ASUS contact information.

Click an icon to display DVD/motherboard information

## 4.2.2 Obtaining the software manuals

The software manuals are included in the support DVD. Follow the instructions below to get the necessary software manuals.



The software manual files are in Portable Document Format (PDF). Install the Adobe® Acrobat® Reader from the **Utilities** tab before opening the files.

To read about your motherboard's utility guide:

1. Click **Manual** tab > **ASUS Motherboard Utility Guide**.



2. From the **Manual** folder, open the folder of the software manual that you wish to read.

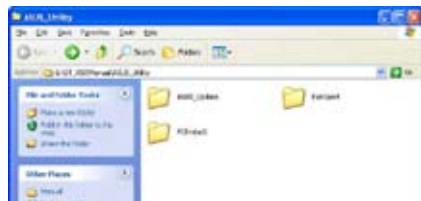

3. Some software manuals are provided in different languages. Open the language's folder to view the software manual.



The screenshots in this section are for reference only. The actual software manuals containing in the support DVD vary by models.

## 4.3 Software information

Most of the applications in the support DVD have wizards that will conveniently guide you through the installation. View the online help or readme file that came with the software application for more information.

## 4.4 AI Suite 3

AI Suite 3 is an all-in-one interface that integrates several ASUS utilities and allows you to launch and operate these utilities simultaneously.

### Installing AI Suite 3



Ensure that you have an Administrator account before installing AI Suite 3 in Windows® 7 OS or Windows® 8 OS.

To install AI Suite 3 on your computer:

#### Windows® 7 OS

1. Place the Support DVD into the optical drive.
2. In the **AutoPlay** dialog box, click **Run ASSETUP.exe** then select the **Utilities** tab

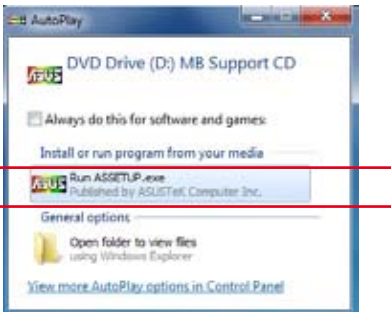

3. From the **Utilities** tab, click **AI Suite 3** then follow the succeeding onscreen instructions.

## Windows® 8 OS

1. Place the Support DVD into the optical drive then follow onscreen instructions.
2. From the **ASUS motherboard support DVD** main menu, select the **Utilities** tab and click **AI Suite 3**.
3. Follow the succeeding onscreen instructions.

If the **ASUS motherboard support DVD** main menu did not appear, try the following steps:

- a. Go to the **Start Screen** then click or tap the **Desktop** app.
- b. On the lower left corner of the Desktop, click or tap **File Explorer**  then select your DVD drive and tap or double-click the **Setup** application.

## Launching AI Suite 3

### Windows® 7 OS

From the Desktop, click **Start > All Programs > ASUS > AI Suite 3 > AI Suite 3**.

You can also launch AI Suite 3 in Windows® 7 by clicking  on the Notification area.

### Windows® 8 OS

To launch AI Suite 3 in Windows® 8, tap the **AI Suite 3** app on the Start Screen (or if you're using a mouse, click the **AI Suite 3** app on the Start screen).



## AI Suite 3 Main menu

The AI Suite 3 main menu gives you easy-access controls and insight to what's going on with your computer - allowing you to optimize performance settings while at the same time ensuring system stability.

The AI Suite main menu includes a quick-access menu bar that allows you to swiftly launch any of the integrated ASUS utilities. Click or tap  on the top-right corner of the menu to launch the menu bar.



The AI Suite 3 screenshots in this section are for reference only and can vary depending on motherboard model..

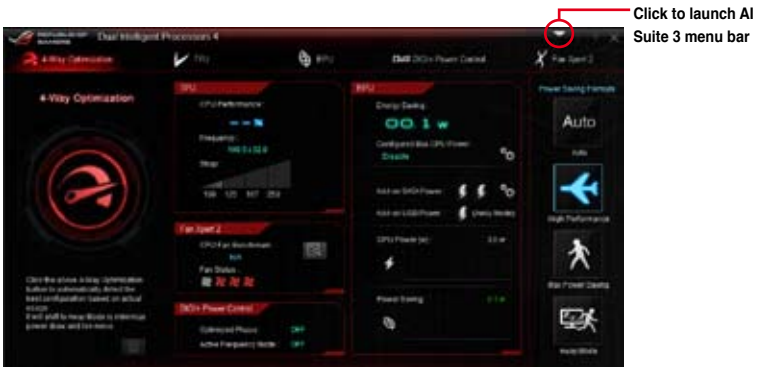

## AI Suite 3 main menu bar

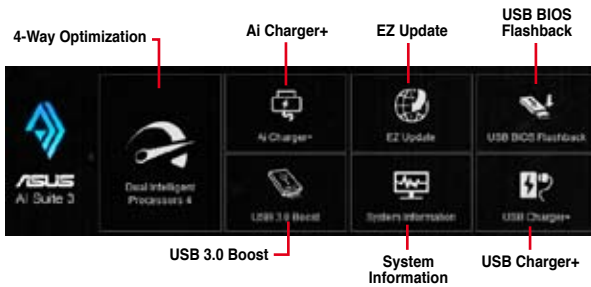

- Some functions in the AI Suite 3 main menu in this user manual may vary depending on the motherboard model.
- Refer to the software manual in the support DVD or visit the ASUS website at [www.asus.com](http://www.asus.com) for detailed software configuration.

## 4.4.1 Dual Intelligent Processors 4 with 4-Way Optimization

Dual Intelligent Processors 4 with 4-Way Optimization comes with these five utilities in one interface: 4-Way Optimization, TurboV Processing Unit (TPU), Energy Processing Unit (EPU), DIGI+ Power Control, and Fan Xpert 2.

### 4-Way Optimization

The 4-Way Optimization utility allows you to automatically tweak the TPU, EPU, DIGI + Power Control and Fan Xpert 2 to their optimal settings.



DO NOT remove your fan during the tuning process.

## TurboV Processing Unit (TPU)

TPU allows you to manually adjust the CPU frequency, CPU cache, core frequencies, DRAM frequency, and related voltages for an enhanced system stability and a performance boost.



Refer to the CPU documentation before adjusting CPU voltage settings. Setting a high voltage may damage the CPU permanently, and setting a low voltage may lead to an unstable system.



For system stability, the TPU settings are not saved in the BIOS and are not loaded during system bootup. Save your overclocking settings as a TPU profile and manually load this profile after system bootup.

## Using TPU

### CPU Frequency

Click to load the saved profile

Click to save the adjustment into a profile

Tick to enable Group Tuning

Click to undo the adjustments

Click < or > to adjust the Base Clock Frequency, CPU Ratio, and CPU Ring Ratio

Click > or < to select the number of cores to adjust



- Set the CPU Ratio Setting item in BIOS to **[Auto]** before using the CPU Frequency in TPU. Refer to the BIOS chapter of your motherboard user manual for details.
- The CPU Frequency bars show the status of the CPU cores, which vary with your CPU model.

## Voltage

Drag the slider to adjust CPU Core, CPU Cache, CPU Analog I/O, PCH Interfacing, VTDDR, and PCHVLX voltages.

Drag the slider to adjust DRAM, CPU System Agent, CPU Digital I/O, PCH, CPU Input, and PLL Termination voltages.

Drag the slider to adjust PCH ICC Voltage

Click to apply the adjustments

Click to undo the adjustments

Click to load the saved profile

Click to save the adjustment into a profile

Drag the slider to adjust the Clock Crossing Voltage

## GPU Boost

Use the ▲ to adjust the iGPU Max Voltage

Click or tap ▲ or ► to adjust the CPU VCCSA voltage

Click or tap to apply the adjustments

Click or tap to undo the adjustments

Click or tap to load the saved profile

Click or tap to save the adjustment into a profile

Click or tap to enable the default settings



## Energy Processing Unit (EPU)

EPU is an energy-processing utility that allows you to adjust the CPU, GPU, and Fan Control settings to their power-saving conditions.

### Using EPU

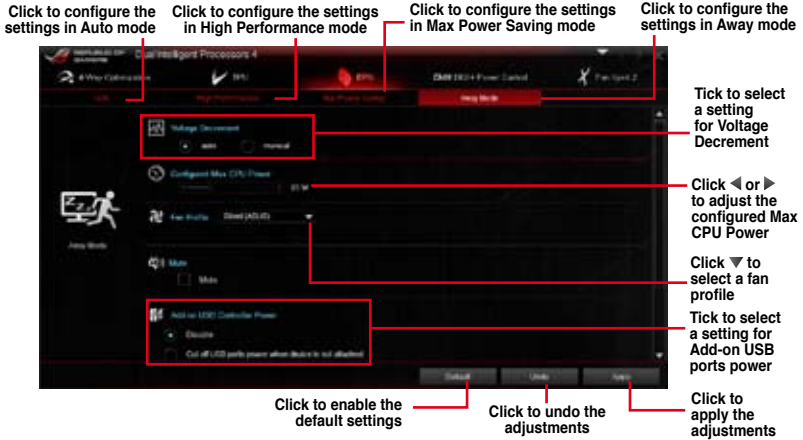

- When you enable Configured Max CPU Power for advanced energy saving condition, the CPU frequency may display 800 MHz in the Windows® OS information of your computer. However, the true CPU frequency varies depending on the wattage that you manually set. You can adjust the CPU wattage from the lowest base to your preferred default value.
- Configured Max CPU Power may decrease the total power delivery to the CPU and affects the CPU performance under system heavy load. To restore your system to its default settings, reboot your computer.

## DIGI+ Power Control

DIGI+ Power Control allows you to adjust the VRM voltage and frequency for optimal system efficiency, overall system stability and performance.

### CPU Power

You can configure the following CPU Power items:

- **CPU Power Duty Control**

CPU Power Duty Control adjusts the current of every VRM phase and the thermal conditions of every phase component.
- **CPU Load-line Calibration**

CPU Load-line Calibration adjusts the voltage range and controls the system temperature. Higher load-line calibration could get higher voltage and good overclocking performance but increases the CPU and VRM thermal conditions.
- **CPU Current Capability**

CPU Current Capability provides wider total power range for overclocking. A higher value setting gets higher VRM power consumption delivery.
- **CPU Power Thermal Control**

A higher temperature brings a wider CPU power thermal range, and extends the overclocking tolerance to enlarge overclocking potential.
- **CPU Power Phase Control**

CPU Power Phase Control allows you to get more transient and better thermal performance by increasing the phase number under heavy system loading. To increase VRM efficiency, reduce the phase number under light system loading.  
\* The system automatically sets the default to [Extreme] when using the Intel® iGPU.
- **CPU Voltage Frequency**

CPU Voltage Frequency affects the VRM transient response and thermal components. Higher VRM frequency gets quicker transient response.

### DRAM Power

You can configure the following DRAM items:

- **DRAM Power Phase Control**

Select Extreme for full phase mode to increase system performance or select Optimized for ASUS optimized phase tuning profile to increase DRAM power efficiency.
- **DRAM Current Capability**

A higher value brings a wider total power range and extends the overclocking frequency range simultaneously.
- **DRAM Voltage Frequency**

Allows you to adjust the DRAM switching frequency for system stability or to increase OC Range.



- The actual performance boost may vary depending on your CPU specification.
- Do not remove the thermal module. The thermal conditions must be monitored.

## Fan Xpert 2

Fan Xpert 2 automatically detects and tweaks the fan speeds, and provides you with optimized fan settings based on the fans' specifications and positions.

### Using Fan Xpert 2

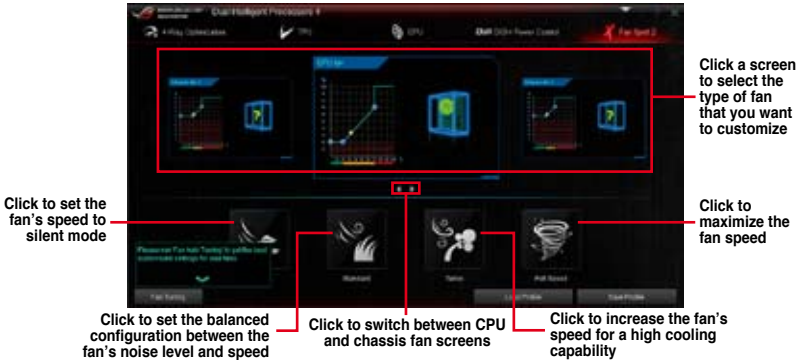

DO NOT remove your fan during the Fan Auto Tuning process.

## Customizing the fan settings

### Smart Mode

Smart Mode allows you to customize the fans' rotation speeds and responses based on your system's temperature.

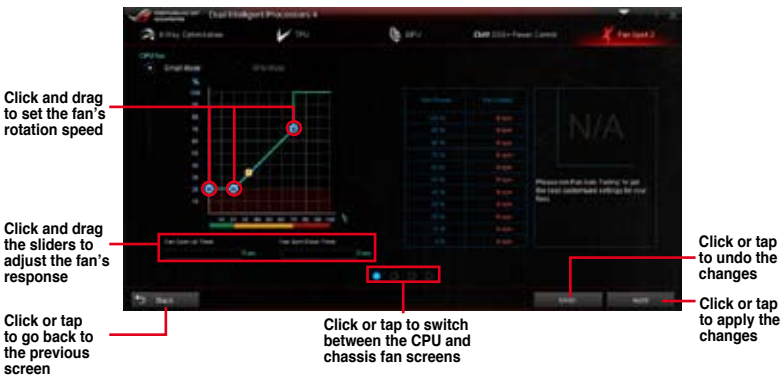

## RPM Mode

RPM Mode allows you to set the fan speed when the CPU temperature is below 75°C.



- When the CPU temperature reaches 75° C, the fan will automatically run at full speed to protect the CPU.
- For motherboard models without the CPU fan detection latch, only 4-pin CPU fans are controllable in Fan Xpert 2.
- The Fan Xpert 2 may not be able to detect the fan speed if your fan is installed with an external control kit for rotation speed.
- Fan Xpert 2 does not support 2-pin fans. If you install a 2-pin fan, it can only run at its full speed.
- If the CPU or chassis fans have been changed, the Fan Auto Tuning process should be repeated.



DO NOT remove your fan during the Fan Auto Tuning process.

## 4.4.2 EZ Update

EZ Update is a utility that allows you to automatically update your motherboard's softwares, drivers and the BIOS version easily.

With this utility, you can also manually update the BIOS and select the boot logo that will display during POST.

### Launching EZ Update

To launch EZ Update, click  on the top edge of the screen, then click **EZ Update** on the AI Suite 3 main menu bar.

### EZ Update screen

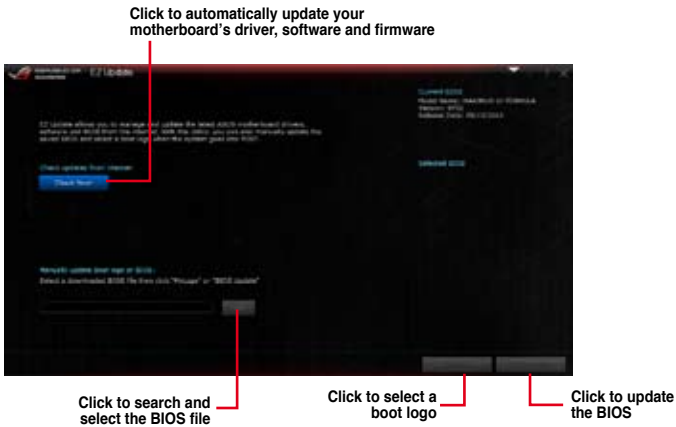

### 4.4.3 USB 3.0 Boost

USB 3.0 Boost technology supports UASP (USB Attached SCSI Protocol) that automatically speeds up the transfer rates of your USB storage devices.

#### Launching USB 3.0 Boost

To launch USB 3.0 Boost, click or tap  on the top-right corner of the AI Suite 3 main menu, then select **USB 3.0 Boost**.

#### Using the USB 3.0 Boost



---

Ensure to connect your USB 3.0 device to the USB 3.0 ports that support USB 3.0 Boost. Refer to section **2.3.1 Rear I/O connection** of your user manual for more details.

---



- USB 3.0 Boost automatically detects the USB 3.0 devices that support UASP. For a list of UASP-supported USB 3.0 devices, visit the ASUS website at [www.asus.com](http://www.asus.com).
  - The data transfer speed varies with USB devices. For a higher data transfer performance, use a USB 3.0 device.
-

## 4.4.4 System Information

This utility allows you get the detailed information of the motherboard, CPU, and memory settings.

### Launching the System Information

To launch System Information, click or tap  on the top-right corner of the AI Suite 3 main menu, then select **System Information**.

### Viewing the motherboard information

Click or tap the **MB** tab to view the motherboard's information.



### Viewing the CPU information

Click or tap the **CPU** tab to view the processor's information.



## Viewing the SPD information

Click or tap the **SPD** tab to view the memory's information.

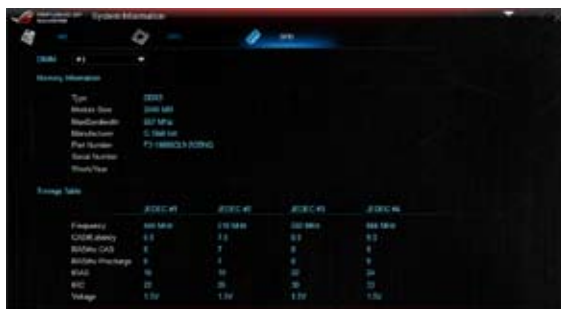



## 4.4.5 USB BIOS Flashback

USB BIOS Flashback allows you to check and save the latest BIOS version to a USB storage device. Use this utility to quickly check for the latest available BIOS and set the BIOS download schedule.

### Launching USB BIOS Flashback

To launch USB BIOS Flashback, click or tap  on the top-right corner of the AI Suite 3 main menu, then select **USB BIOS Flashback**.



USB BIOS Flashback is available only in selected motherboard models.

### Using USB BIOS Flashback



Set a schedule for the BIOS Update download

Click to check for a new BIOS update available for download

Click or tap to cancel the download schedule setting

Click or tap to apply the download schedule setting

### Scheduling the BIOS download

1. In the Download Setting field, tick **Schedule (days)** then select the number of days for the BIOS download schedule.
2. Click or tap **Apply** to save the BIOS download schedule. Click or tap **Cancel** to cancel the download schedule.

## Downloading the latest BIOS





Before you start downloading, ensure that you have installed the USB storage device to your computer's USB port that supports USB BIOS Flashback. Refer to section 2.3.1 **Rear I/O connection** of your user manual for more details.

To download the updated BIOS:

1. From the USB BIOS Flashback screen, click or tap **Check for New BIOS Update**.

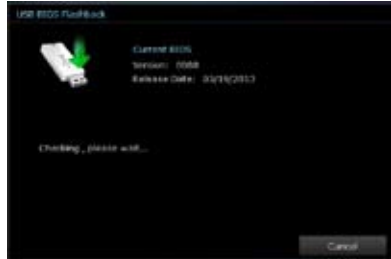
Wait for the system to check the latest BIOS version.



2. After the utility detects a new BIOS, click or tap  from the **Save to:** field, select the USB flash drive, then click or tap **Download**.

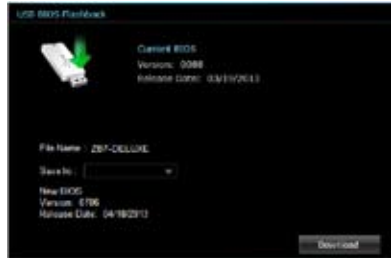

3. After the download is complete, click or tap **OK**.



## 4.4.6 Ai Charger+

Ai Charger+ allows you to fast-charge your portable BC 1.1\* mobile devices on your computer's USB port three times faster than the standard USB devices.\*\*

### Launching Ai Charger+

To launch Ai Charger+, click  on the top edge of the screen, then click **Ai Charger+** on the AI Suite 3 main menu bar.

### Ai Charger+ screen

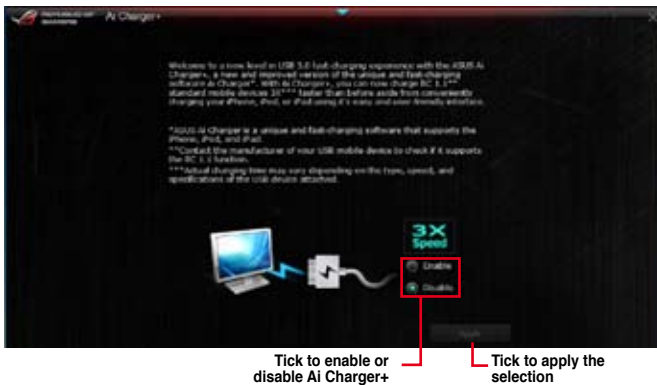

- \* Check the manufacturer if your USB device is a Battery Charging Specification 1.1 (BC 1.1) compliant or compatible device.
- \*\* Actual charging speeds may vary depending on the charging rate and specifications of your USB device.
- To ensure normal charging function, disconnect and reconnect your USB device every time you enable or disable Ai Charger+.
- The Ai Charger+ does not support USB hubs, USB extension cables, and generic USB cables.

## 4.4.7 USB Charger+

USB Charger+ allows you to quick-charge your portable USB devices even if your computer is off, in sleep mode or hibernate mode.



Before using USB Charger+, ensure to disable the ErP Ready item in the BIOS. To do this, go to **Advanced > APM > ErP Ready** in the Advanced mode then set this item to [Disabled].



USB Charger+ is available only in selected motherboard models.

### Launching USB Charger+

To launch USB Charger+, click or tap  on the top-right corner of the AI Suite 3 main menu, then select **USB Charger+**.

### Using USB Charger+



Click or tap to detect the connected USB device

Click or tap to fast-charge your USB device

Click or tap to stop charging your USB device

Click or tap to apply the settings

Click or tap to disregard the settings

Indicates that the connected USB device is in charging mode

Click or tap to select the type of USB device that you wish to charge when the system is off



Ensure to connect your USB device into the USB port that supports this utility. Refer to section **2.3.1 Rear I/O connection** of your user manual for more details.



- USB Charger+ does not support USB hubs, USB extension cables, and generic USB cables.
- USB Charger+ may not recognize some ASUS devices due to varying design.

## 4.4.8 Audio configurations

The Realtek® audio CODEC provides 8-channel audio capability to deliver the ultimate audio experience on your computer. The software provides Jack-Sensing function, S/PDIF Out support, and interrupt capability. The CODEC also includes the Realtek® proprietary UAJ® (Universal Audio Jack) technology for all audio ports, eliminating cable connection errors, and giving users plug and play convenience.

Follow the installation wizard to install the Realtek® Audio Driver from the support DVD that came with the motherboard package.

If the Realtek® audio software is correctly installed, you will find the Realtek® HD Audio Manager icon on the taskbar. Double-click on the icon to display the Realtek® HD Audio Manager.



Realtek® HD Audio Manager

### Realtek® HD Audio Manager for Windows® 8 / Windows® 7



## 4.5 ROG Connect

ROG Connect allows you to monitor and adjust the local PC through your remote PC.

### Setting up USB connection between your local and remote PC



- Install ROG Connect on the remote PC from the provided Support DVD before using ROG Connect.
- ROG Connect must work with ROG Connect Software to avail full function. Ensure that you install ROG Connect Plus on your local PC from the provided Support DVD before using ROG Connect.
- The dedicated ROG Connector cable is purchased separately.

1. Connect the provided ROG Connect cable to the local PC and the remote PC.
2. Press the ROG Connect Button and it will light up into a stable glow.
3. Double-click the RC TweakIt shortcut on the remote PC to activate the function

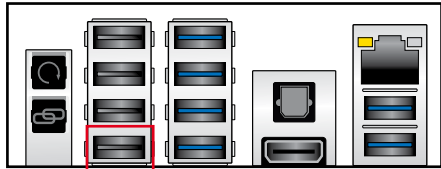

### Using RC TweakIt

To use the RC TweakIt

1. Use the sliders and buttons to monitor or adjust the settings in your local PC.



2. Click Function to display more options.



### RC Poster

RC Poster shows the status of the local system during the POST. You can switch the display mode between String and Code.



### RC Remote

RC Remote allows you to operate your local system through the ROG Connect cable.



### RC Diagram

RC Diagram allows you to monitor and record your local system status.



## 4.6 MemTweakIt

MemTweakIt is a software that you can use to view all levels of memory timings. You can validate your MemTweakIt settings to generate a memory efficiency score that you can share and compare with other users on the ROG website.

To use MemTweakIt, double-click  on the desktop.



Click **About** tab and click **REPLIC OF GAMERS** to access ROG official



## Validating and saving your MemTweakIt settings

To validate and save your configuration online:

1. Launch MemTweakIt and click **Validate**.
2. In **Online Mode**, key in your ASUS account ID and password, and click **Submit**.



Your configuration will be displayed in MemTweakIt webpage.

To validate and save your configuration manually:

1. Launch MemTweakIt and click **Validate**.
2. In **Manual Mode**, click **Save Configuration File**.



3. Key in a file name for your configuration file and click **Save**.
4. Click **validation webpage**.
5. In **MemTweakIt - Validation File Upload** window, key in your ASUS account ID and password.
6. Click **Browse**, locate the saved .cvf file, and click **Open**.
7. Click **Submit**.

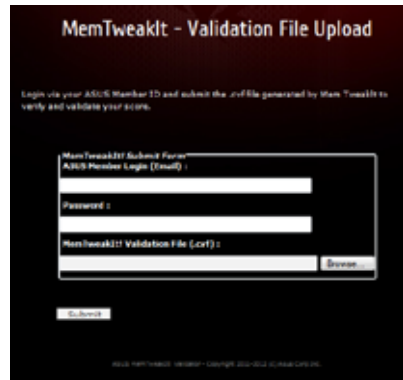

Your configuration will be displayed in MemTweakIt webpage.

## 4.7 RAMDisk

RAMDisk is a data-storage software that reserves a part of your system's memory and turns it into a high-speed virtual drive where you can store cache files and game apps for instant access.



The following folders are not suitable for RAMDisk optimization. Moving them into the RAMDisk might negatively affect the performance of your system.

- **Swap file/Page file:** The swap file is a permanent storage space used as the virtual memory expansion of the system memory. Moving the swap file into the RAM Disk simply defeats the whole purpose of having it and may affect your system's performance.
- **Startup folders:** Since RAMDisk loads during boot up together with the contents of the Junction folders, changing the location of the startup folders may cause system error and disable loading your RAMDisk.



RAMDisk supports only 64 bit OS.



To launch RAMDisk, click

### Creating/Deleting a RAMDisk drive

Your RAMDisk drive allows you to place your favorite applications and files into RAM so you can utilize your RAM speed for better read/write performance. The files that are stored inside the RAMDisk are automatically backed up every time your PC is turned off.



The startup time may take a while, depending on the size of your RAMDisk drive.

### To create RAMDisk drives:

The screenshot shows the RAMDisk application window. The interface includes a 'Disk' dropdown menu, a 'Size' slider, and an 'Add' button. Annotations with red boxes and arrows point to these elements:

- Click to create RAMDisk drives:** Points to the 'Disk' dropdown menu.
- Click the drop-down arrow to choose a drive name for your RAMDisk:** Points to the arrow on the 'Disk' dropdown menu.
- Move the slider to the right to set the size allocation:** Points to the 'Size' slider.
- Click Add to finish creating the RAMDisk drive:** Points to the 'Add' button.

The application window also displays system information: Processor: 28.11MB, Ram-Disk: 0MB, Free: 10732MB.

To delete an existing RAMDisk drive:

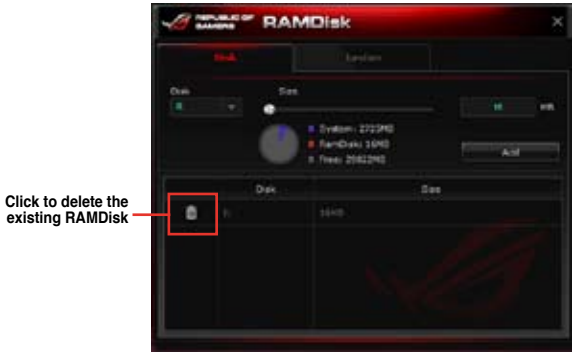

### Creating/Deleting a Junction Point

A junction point creates a link that remaps the original contents into the RAMDisk, enabling access to the desired application or data to be done purely within the original file location.

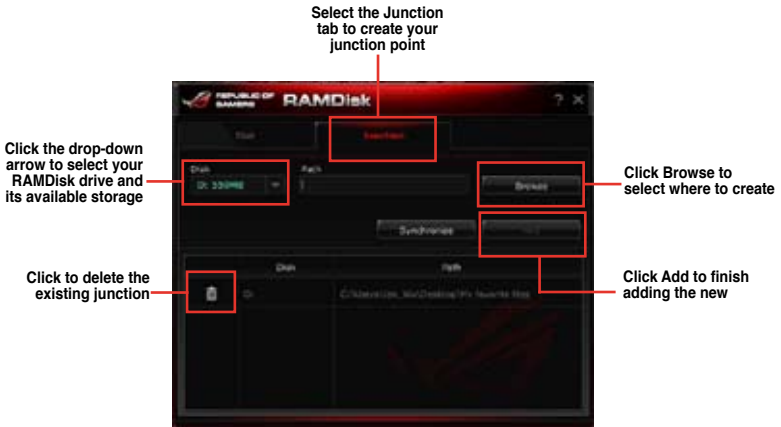

## Synchronizing backup files

After creating a junction point, RAMDisk automatically creates a backup folder in the file's original location. Use RAMDisk to manually synchronize updates with these backup files.

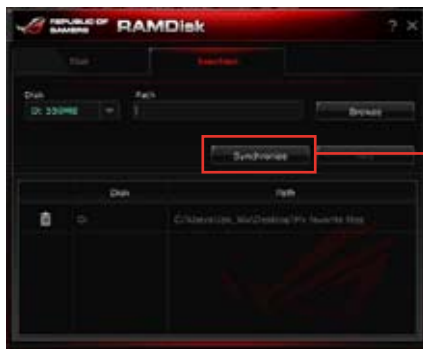

Click Synchronize to update your files

## 4.7 Sonic Radar

Sonic Radar is a head-up display (HUD) designed for First Person Shooting (FPS) games, that shows the precise direction and intensity of where a sound is coming from. In-game sound including gunshots, footsteps, voice call-outs, or even a ticking bomb, is visualized as radar signals on the Sonic Radar display - this provides you the advantage to know potential threats and act accordingly.

Sonic Radar also features a sound enhancer that amplifies a desired frequency band and minimizes ambient noise to help make the sound more clear.

### 4.7.1 Main menu

To launch Sonic Radar, go to the Desktop then click **Start > All Programs > Sonic Radar >**

**Sonic Radar** or go to the taskbar then double-click .



Sonic Radar is automatically installed when you install the Realtek Audio drivers for your ROG motherboard with SupremeFX.



**Sonic Radar display**  
Shows the intensity and direction of where a sound is coming from. An identical display can be seen on your in-game screen.

**Game Detection**  
Click to enable or disable automatic loading of optimum game preset depending on detected type of game launched.

**Advance Settings**  
Click to configure the smoothness, opacity and position of Sonic Radar Display. Also, click if you wish to configure the shortcut keys.

**Game Presets**  
Click to select optimal preset for your FPS game.

**Radar Selection**  
Click items to select which type of threat to show on the Sonic Radar Display

Click to exit  
Click to minimize window  
Click to show software information

Click to show or hide the Game presets

## Sonic Radar in-game



\* Battlefield 3. All rights reserved.

Sonic Radar display



Radar signals indicate where sound is coming from









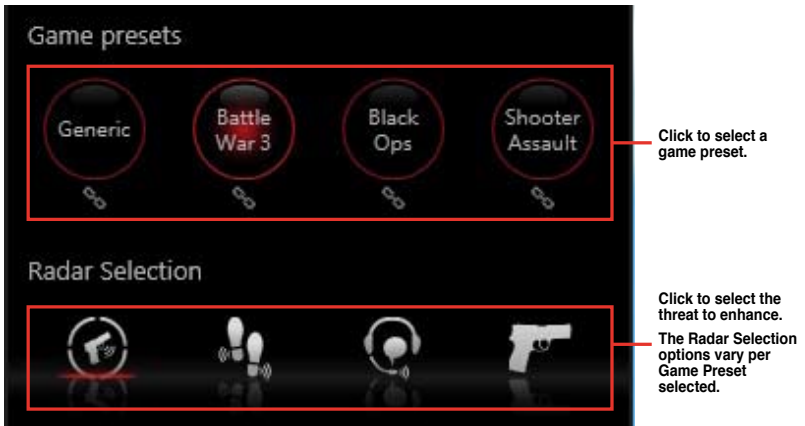

- The screen shot is for reference only and can vary depending on the game you are playing.
- All rights of the FPS game Battlefield 3 is reserved to EA Digital Illusions CE AB and Electronic Arts.

## 4.7.2 Game presets and Radar Selection

The optimized game presets and radar selection sound enhancers provide the most conducive settings that enhances your point of view while playing FPS games.



### Radar Selection options

Icon	Type of threat and description
	Enhance sound coming from all potential threats.
	Enhance sound coming from footsteps.
	Enhance sound from voice call-outs.
	Enhance sound from gunshots.
	Enhance sound from ticking bomb.
	Full range setting.
	Bass range setting.
	Mid range setting.
	High range setting.

### 4.7.3 Advanced Settings

Click  from the Sonic Radar main menu to show the Advanced Settings panel.

#### Smoothness and opacity

Allows you to adjust the texture and transparency of the Sonic Radar display.

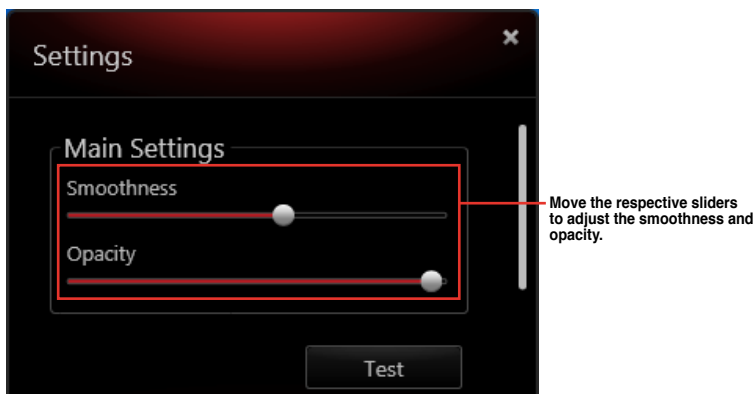

#### Radar position

Allows you to set a convenient position for the Sonic Radar display, anywhere on your in-game screen.





## Shortcut keys

Your gaming experience is further enhanced with a set of default shortcut keys that allows you to perform tasks faster and easier without exiting the game.

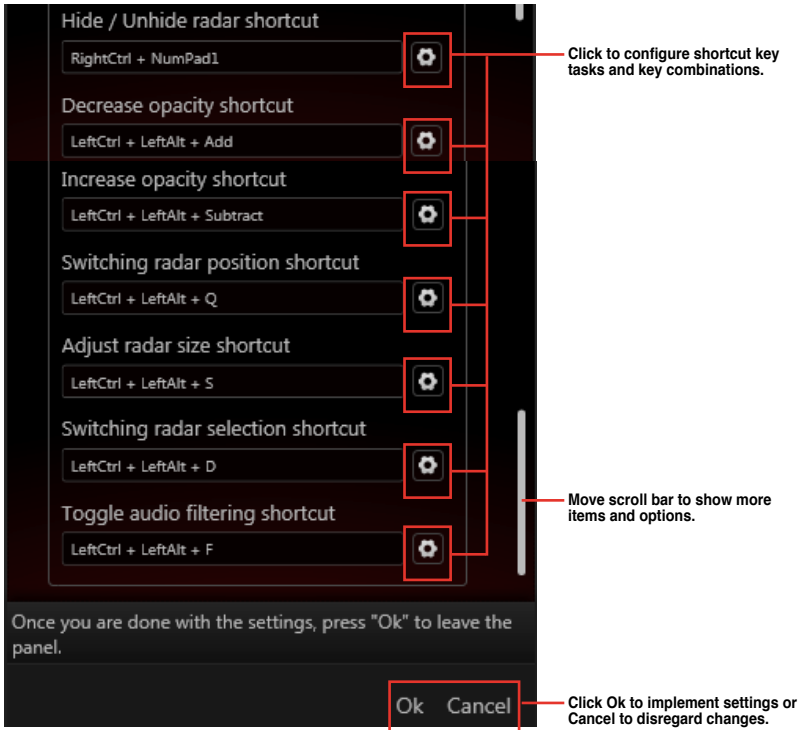

Default shortcut key	Function and description
<Right Ctrl> + Numeric Pad <0>	Hide/show the Sonic Radar display.
<Left Ctrl> + <Left Alt> + <+>	Decrease Sonic Radar display opacity.
<Left Ctrl> + <Left Alt> + <->	Increase Sonic Radar display opacity.
<Left Ctrl> + <Left Alt> + <Q>	Move Sonic Radar to any of nine (9) available positions on your in-game screen.
<Left Ctrl> + <Left Alt> + <S>	Adjust the Sonic Radar display size.
<Left Ctrl> + <Left Alt> + <D>	Set available Radar Selection depending on your game preset.
<Left Ctrl> + <Left Alt> + <F>	Enables or disables the sound enhancer.

## 4.8 Perfect Voice

Sonic Radar comes with the Perfect voice, a single microphone noise reduction solution initially designed for Voice-Over-IP (VOIP) software. With Perfect voice, you can deliver perfectly enunciated voice call-outs.

Perfect voice works via two major features: Noise Gate and Noise Reduction.

### Noise Gate

Noise gate cuts the ambient noise in pauses or periods of silence in-between words or sentences.

### Noise Reduction

Analyzes, estimates then minimizes the amount of ambient noise within words and sentences.

You can configure the Noise Gate and Noise Reduction settings via the Realtek HD Audio Manager.

To launch the Realtek HD Audio Manager, go to the Desktop then from the taskbar double-click .



---

Before configuring any of the settings, ensure that you have a headset connected to the audio ports.

---

### Realtek HD Audio Manager main menu

From the Realtek HD Audio Manager main menu, select **Microphone** then **Microphone Effects**. Refer to the screen below for a sample setting:



#### Noise Gate

Tick to enable/disable feature. Move the slider to adjust the desired effectivity level.

#### Noise Reduction

Tick to enable/disable feature. Move the slider to adjust the desired noise reduction level.

# RAID support

# 5

## 5.1 RAID configurations

The motherboard comes with the Intel® Rapid Storage Technology that supports RAID 0, RAID 1, RAID 10 and RAID 5 configuration.



---

If you want to install a Windows® operating system to a hard disk drive included in a RAID set, you have to create a RAID driver disk and load the RAID driver during OS installation. Refer to section 5.2 **Creating a RAID driver disk** for details.

---

### 5.1.1 RAID definitions

**RAID 0 (Data striping)** optimizes two identical hard disk drives to read and write data in parallel, interleaved stacks. Two hard disks perform the same work as a single drive but at a sustained data transfer rate, double that of a single disk alone, thus improving data access and storage. Use of two new identical hard disk drives is required for this setup.

**RAID 1 (Data mirroring)** copies and maintains an identical image of data from one drive to a second drive. If one drive fails, the disk array management software directs all applications to the surviving drive as it contains a complete copy of the data in the other drive. This RAID configuration provides data protection and increases fault tolerance to the entire system. Use two new drives or use an existing drive and a new drive for this setup. The new drive must be of the same size or larger than the existing drive.

**RAID 5** stripes both data and parity information across three or more hard disk drives. Among the advantages of RAID 5 configuration include better HDD performance, fault tolerance, and higher storage capacity. The RAID 5 configuration is best suited for transaction processing, relational database applications, enterprise resource planning, and other business systems. Use a minimum of three identical hard disk drives for this setup.

**RAID 10** is data striping and data mirroring combined without parity (redundancy data) having to be calculated and written. With the RAID 10 configuration you get all the benefits of both RAID 0 and RAID 1 configurations. Use four new hard disk drives or use an existing drive and three new drives for this setup.

## 5.1.2 Installing Serial ATA hard disks

The motherboard supports Serial ATA hard disk drives. For optimal performance, install identical drives of the same model and capacity when creating a disk array.

### To install the SATA hard disks for a RAID configuration:

1. Install the SATA hard disks into the drive bays.
2. Connect the SATA signal cables.
3. Connect a SATA power cable to the power connector on each drive.

## 5.1.3 Setting the RAID item in BIOS

You must enable the RAID function in the BIOS Setup before creating RAID sets using SATA HDDs. To do this:

1. Enter the BIOS Setup during POST.
2. Go to the **Advanced** menu > **SATA Configuration**, and then press <Enter>.
3. Set the SATA Mode item to [RAID Mode].
4. Save your changes, and then exit the BIOS Setup.



---

Refer to Chapter 3 for details on entering and navigating through the BIOS Setup

---



---

Due to chipset limitation, when SATA ports are set to RAID mode, all SATA ports run at RAID mode together.

---

## 5.1.4 Intel® Rapid Storage Technology Option ROM utility

To enter the Intel® Rapid Storage Technology Option ROM utility:

1. Turn on the system.
2. During POST, press <Ctrl> + <I> to display the utility main menu.

```
Intel(R) Rapid Storage Technology - Option ROM - v10.5.1.1070
Copyright(C) 2003-10 Intel Corporation. All Rights Reserved.

[ MAIN MENU ]
1. Create RAID Volume      4. Recovery Volume Options
2. Delete RAID Volume     5. Acceleration Options
3. Reset Disks to Non-RAID 6. Exit

[ DISK/VOLUME INFORMATION ]

RAID Volumes:
None defined.

Physical Devices:
Port Device Model      Serial #      Size  Type/Status (Vol ID)
0  ST3160812AS         9LS0HJA4     149.0GB Non-RAID Disk
1  ST3160812AS         9LS0F4HL     149.0GB Non-RAID Disk
2  ST3160812AS         3LS0JYL8     149.0GB Non-RAID Disk
3  ST3160812AS         9LS0BJ5H     149.0GB Non-RAID Disk

[↑↓]-Select      [ESC]-Exit      [ENTER]-Select Menu
```

The navigation keys at the bottom of the screen allow you to move through the menus and select the menu options.



The RAID BIOS setup screens shown in this section are for reference only and may not exactly match the items on your screen.



The utility supports maximum four hard disk drives for RAID configuration.

## Creating a RAID set

### To create a RAID set:

1. From the utility main menu, select **1. Create RAID Volume** and press <Enter>. The following screen appears:

```
Intel(R) Rapid Storage Technology - Option ROM - v10.5.1.1070
Copyright(C) 2003-10 Intel Corporation. All Rights Reserved.

[ CREATE VOLUME MENU ]
Name: volume
RAID Level:
Disks:
Strip Size:
Capacity:
Sync:
Create volume

[ HELP ]

Enter a unique volume name that has no special characters and is
16 characters or less.

[↑↓]-Select [ESC]-Exit [ENTER]-Select Menu
```

2. Enter a name for the RAID set and press <Enter>.
3. When the RAID Level item is selected, press the up/down arrow key to select a RAID level to create, and then press <Enter>.
4. When the Disks item is selected, press <Enter> to select the hard disk drives you want to include in the RAID set. The SELECT DISKS screen appears:

```
[ SELECT DISKS ]
Port Drive Model Serial # Size Status
0 ST3160812AS 9LS0H0A4 149.0GB Non-RAID Disk
1 ST3160812AS 9LS0F4HL 149.0GB Non-RAID Disk
2 ST3160812AS 3LS0JYL8 149.0GB Non-RAID Disk
3 ST3160812AS 9LS0BJ5H 149.0GB Non-RAID Disk

Select 2 to 6 disks to use in creating the volume.
[↑↓]-Prev/Next [SPACE]-SelectDisk [ENTER]-Done
```

5. Use the up/down arrow key to select a drive, and then press <Space> to select. A small triangle marks the selected drive. Press <Enter> after completing your selection.
6. Use the up/down arrow key to select the stripe size for the RAID array (for RAID 0, 10 and 5 only), and then press <Enter>. The available stripe size values range from 4KB to 128KB. The following are typical values:
  - RAID 0: 128KB
  - RAID 10: 64KB
  - RAID 5: 64KB



---

We recommend a lower stripe size for server systems, and a higher stripe size for multimedia computer systems used mainly for audio and video editing.

---

7. When the **Capacity** item is selected, enter the RAID volume capacity that you want and press <Enter>. The default value indicates the maximum allowed capacity.
8. When the **Create Volume** item is selected, press <Enter>. The following warning message appears:

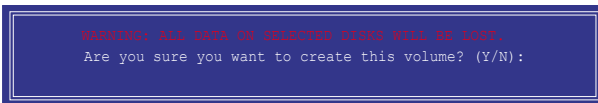

9. Press <Y> to create the RAID volume and return to the main menu, or <N> to go back to the CREATE VOLUME menu.

## Deleting a RAID set



Be cautious when deleting a RAID set. You will lose all data on the hard disk drives when you delete a RAID set.

### To delete a RAID set:

1. From the utility main menu, select **2. Delete RAID Volume** and press <Enter>. The following screen appears:

```
[ DELETE VOLUME MENU ]
Name      Level      Drives  Capacity  Status  Bootable
Volume0   RAID0 (Stripe)  2       298.0GB  Normal  Yes

[ HELP ]

Deleting a volume will reset the disks to non-RAID.

WARNING: ALL DISK DATA WILL BE DELETED.
        (This does not apply to Recovery volumes)

[↑↓]-Select      [ESC]-Previous Menu  [DEL]-Delete Volume
```

2. Use the up/down arrow key to select the RAID set you want to delete, and then press <Del>. The following warning message appears:

```
[ DELETE VOLUME VERIFICATION ]

ALL DATA IN THE VOLUME WILL BE LOST!
(This does not apply to Recovery volumes)

Are you sure you want to delete volume "Volume0"? (Y/N):
```

3. Press <Y> to delete the RAID set and return to the utility main menu, or press <N> to return to the DELETE VOLUME menu.



## Exiting the Intel® Rapid Storage Technology Option ROM utility

### To exit the utility:

1. From the utility main menu, select **5. Exit**, and then press <Enter>. The following warning message appears:

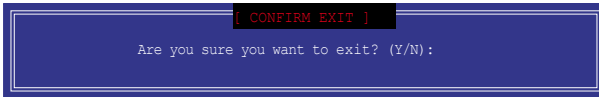

## 5.2 Creating a RAID driver disk

A floppy disk with the RAID driver is required when installing a Windows® operating system on a hard disk drive that is included in a RAID set.



---

The motherboard does not provide a floppy drive connector. You have to use a USB floppy disk drive when creating a SATA RAID driver disk.

---

### 5.2.1 Creating a RAID driver disk without entering the OS

#### To create a RAID driver disk without entering the OS:

1. Boot your computer.
2. Press <Del> during POST to enter the BIOS setup utility.
3. Set the optical drive as the primary boot device.
4. Insert the support DVD into the optical drive.
5. Save changes and exit BIOS.
6. When the Make Disk menu appears, press <1> to create a RAID driver disk.
7. Insert a formatted floppy disk into the USB floppy disk drive, then press <Enter>.
8. Follow the succeeding screen instructions to complete the process.

## 5.2.2 Creating a RAID driver disk in Windows®

To create a RAID driver disk in Windows®:

1. Start Windows®.
2. Plug the USB floppy disk drive and insert a floppy disk.
3. Place the motherboard support DVD into the optical drive.
4. Go to the **Make Disk** menu, and then click **Intel AHCI/RAID Driver Disk** to create a RAID driver disk.
5. Select **USB floppy disk drive** as the destination disk.
6. Follow the succeeding screen instructions to complete the process.



---

Write-protect the floppy disk to avoid a computer virus infection.

---

## 5.2.3 Installing the RAID driver during Windows® OS installation

To install the RAID driver for Windows® 7 or later OS:

1. During the OS installation, click **Load Driver** to allow you to select the installation media containing the RAID driver.
2. Insert the USB flash drive with RAID driver into the USB port or the support DVD into the optical drive, and then click **Browse**.
3. Click the name of the device you've inserted, go to **Drivers > RAID**, and then select the RAID driver for the corresponding OS version. Click **OK**.
4. Follow the succeeding screen instructions to complete the installation.



---

Before loading the RAID driver from a USB flash drive, you have to use another computer to copy the RAID driver from the support DVD to the USB flash drive.

---

# Appendices

## Notices

### Federal Communications Commission Statement

This device complies with Part 15 of the FCC Rules. Operation is subject to the following two conditions:

- This device may not cause harmful interference.
- This device must accept any interference received including interference that may cause undesired operation.

This equipment has been tested and found to comply with the limits for a Class B digital device, pursuant to Part 15 of the FCC Rules. These limits are designed to provide reasonable protection against harmful interference in a residential installation. This equipment generates, uses and can radiate radio frequency energy and, if not installed and used in accordance with manufacturer's instructions, may cause harmful interference to radio communications. However, there is no guarantee that interference will not occur in a particular installation. If this equipment does cause harmful interference to radio or television reception, which can be determined by turning the equipment off and on, the user is encouraged to try to correct the interference by one or more of the following measures:

- Reorient or relocate the receiving antenna.
- Increase the separation between the equipment and receiver.
- Connect the equipment to an outlet on a circuit different from that to which the receiver is connected.
- Consult the dealer or an experienced radio/TV technician for help.



---

The use of shielded cables for connection of the monitor to the graphics card is required to assure compliance with FCC regulations. Changes or modifications to this unit not expressly approved by the party responsible for compliance could void the user's authority to operate this equipment.

---

## IC: Canadian Compliance Statement

Complies with the Canadian ICES-003 Class B specifications. This device complies with RSS 210 of Industry Canada. This Class B device meets all the requirements of the Canadian interference-causing equipment regulations.

This device complies with Industry Canada license exempt RSS standard(s). Operation is subject to the following two conditions: (1) this device may not cause interference, and (2) this device must accept any interference, including interference that may cause undesired operation of the device.

Cet appareil numérique de la Classe B est conforme à la norme NMB-003 du Canada. Cet appareil numérique de la Classe B respecte toutes les exigences du Règlement sur le matériel brouilleur du Canada.

Cet appareil est conforme aux normes CNR exemptes de licence d'Industrie Canada. Le fonctionnement est soumis aux deux conditions suivantes :

- (1) cet appareil ne doit pas provoquer d'interférences et
- (2) cet appareil doit accepter toute interférence, y compris celles susceptibles de provoquer un fonctionnement non souhaité de l'appareil.

## Canadian Department of Communications Statement

This digital apparatus does not exceed the Class B limits for radio noise emissions from digital apparatus set out in the Radio Interference Regulations of the Canadian Department of Communications.

This class B digital apparatus complies with Canadian ICES-003.

## VCCI: Japan Compliance Statement

### VCCI Class B Statement

情報処理装置等電波障害自主規制について

この装置は、情報処理装置等電波障害自主規制協議会（VCCI）の基準に基づくクラスB情報技術装置です。この装置は家庭環境で使用することを目的としていますが、この装置がラジオやテレビジョン受信機に近接して使用されると、受信障害を引き起こすことがあります。

取扱説明書に従って正しい取り扱いをして下さい。

## KC: Korea Warning Statement

B급 기기 (가정용 방송통신기자재)

이 기기는 가정용(B급) 전자파적합기기로서 주로 가정에서 사용하는 것을 목적으로 하며, 모든 지역에서 사용할 수 있습니다.

\*당해 무선설비는 전파통신 가능성이 있으므로 인명안전과 관련된 서비스는 할 수 없습니다.

## REACH

Complying with the REACH (Registration, Evaluation, Authorisation, and Restriction of Chemicals) regulatory framework, we published the chemical substances in our products at ASUS REACH website at <http://csr.asus.com/english/REACH.htm>.



---

DO NOT throw the motherboard in municipal waste. This product has been designed to enable proper reuse of parts and recycling. This symbol of the crossed out wheeled bin indicates that the product (electrical and electronic equipment) should not be placed in municipal waste. Check local regulations for disposal of electronic products.

---



---

DO NOT throw the mercury-containing button cell battery in municipal waste. This symbol of the crossed out wheeled bin indicates that the battery should not be placed in municipal waste.

---

## ASUS Recycling/Takeback Services

ASUS recycling and takeback programs come from our commitment to the highest standards for protecting our environment. We believe in providing solutions for you to be able to responsibly recycle our products, batteries, other components as well as the packaging materials. Please go to <http://csr.asus.com/english/Takeback.htm> for detailed recycling information in different regions.

## ASUS contact information

### ASUSTeK COMPUTER INC.

Address	15 Li-Te Road, Peitou, Taipei, Taiwan 11259
Telephone	+886-2-2894-3447
Fax	+886-2-2890-7798
E-mail	info@asus.com.tw
Web site	www.asus.com.tw

#### *Technical Support*

Telephone	+86-21-38429911
Online support	support.asus.com

### ASUS COMPUTER INTERNATIONAL (America)

Address	800 Corporate Way, Fremont, CA 94539, USA
Telephone	+1-510-739-3777
Fax	+1-510-608-4555
Web site	usa.asus.com

#### *Technical Support*

Telephone	+1-812-282-2787
Support fax	+1-812-284-0883
Online support	support.asus.com

### ASUS COMPUTER GmbH (Germany and Austria)

Address	Harkort Str. 21-23, D-40880 Ratingen, Germany
Fax	+49-2102-959911
Web site	www.asus.de
Online contact	www.asus.de/sales

#### *Technical Support*

Telephone	+49-1805-010923*
Support Fax	+49-2102-9599-11
Online support	support.asus.com

\* EUR 0.14/minute from a German fixed landline; EUR 0.42/minute from a mobile phone.

# EC Declaration of Conformity



We, the undersigned,

**Manufacturer:** ASUS TEK COMPUTER INC.  
**Address, City:** 4F, No. 150, LITE Rd., PEITOU, TAIPEI 112, TAIWAN  
**Country:** TAIWAN  
**Authorized representative in Europe:** ASUS COMPUTER GmbH  
**Address, City:** HARGORT STR. 2-22, 40888 RATINGEN  
**Country:** GERMANY

declare the following apparatus:

**Product name :** Motherboard  
**Model name :** Maximus VI GENE

conforms with the essential requirements of the following directives:

- 2006/40/EEC-EMC Directive**
  - EN 61000-3-2:2006+A2:2009
  - EN 55013:2001+A1:2003+A2:2006
  - EN 61000-3-3:2008
  - EN 61000-3-11:2008
  - EN 55020:2007+A1:2011
- 1989/5/EEC-R & TTE Directive**
  - EN 300 328 V1.7 (12064-10)
  - EN 300 342 V1.4 (12064-10)
  - EN 300 440-2 V1.4 (12010-08)
  - EN 301 511 V9.0 (2003-03)
  - EN 301 488-7 V1.3 (2005-11)
  - EN 301 488-7 V2.1 (2006-03)
  - EN 301 508-2 V5.2 (12011-05)
  - EN 301 508-2 V5.1 (12009-05)
  - EN 301 488-17 V2.1 (2006-03)
  - EN 301 488-24 V1.5 (12010-09)
  - EN 302 326-3 V1.2 (2007-08)
  - EN 302 326-3 V1.1 (2006-04)
  - EN 301 542-2 V1.1 (2006-04)
  - EN 50060:2001
  - EN 62479:2010
  - EN 62479:2010
  - EN 302 291-1 V1.1 (2008-07)
  - EN 302 291-2 V1.1 (2008-07)
  - EN 62311:2008
- 82/2009/EEC-LVD Directive**
  - EN 60950-1/A:12:2011
  - EN 60066:2002/A:12:2011
- 2009/12/EEC-CEP Directive**
  - Regulation (EC) No. 1275/2008
  - Regulation (EC) No. 642/2009
- 82/2011/EEC-ROHS Directive**

Ver. 130208



(EC conformity marking)

**Position :** CEO  
**Name :** Jerry Shen

Signature : \_\_\_\_\_

**Declaration Date:** 19/04/2013  
**Year to begin affixing CE marking:** 2013

# DECLARATION OF CONFORMITY

Per FCC Part 2 Section 2.1077(a)



**Responsible Party Name:** Asus Computer International

**Address:** 800 Corporate Way, Fremont, CA 94539.

**Phone/Fax No:** (510)739-3777/(510)608-4555

hereby declares that the product

**Product Name :** Motherboard

**Model Number :** Maximus VI GENE

Conforms to the following specifications:

- FCC Part 15, Subpart B, Unintentional Radiators

**Supplementary Information:**

This device complies with part 15 of the FCC Rules. Operation is subject to the following two conditions: (1) This device may not cause harmful interference, and (2) this device must accept any interference received, including interference that may cause undesired operation.

Representative Person's Name : Steve Chang / President

**Signature :** \_\_\_\_\_  
**Date :** Apr. 19, 2013





## Free Manuals Download Website

<http://myh66.com>

<http://usermanuals.us>

<http://www.somanuals.com>

<http://www.4manuals.cc>

<http://www.manual-lib.com>

<http://www.404manual.com>

<http://www.luxmanual.com>

<http://aubethermostatmanual.com>

Golf course search by state

<http://golfingnear.com>

Email search by domain

<http://emailbydomain.com>

Auto manuals search

<http://auto.somanuals.com>

TV manuals search

<http://tv.somanuals.com>