

ASUS® P2B-N
Pentium® III / Pentium® II / Celeron™
NLX Motherboard

USER'S MANUAL



USER'S NOTICE

No part of this manual, including the products and software described in it, may be reproduced, transmitted, transcribed, stored in a retrieval system, or translated into any language in any form or by any means, except documentation kept by the purchaser for backup purposes, without the express written permission of ASUSTeK COMPUTER INC. ("ASUS").

ASUS PROVIDES THIS MANUAL "AS IS" WITHOUT WARRANTY OF ANY KIND, EITHER EXPRESS OR IMPLIED, INCLUDING BUT NOT LIMITED TO THE IMPLIED WARRANTIES OR CONDITIONS OF MERCHANTABILITY OR FITNESS FOR A PARTICULAR PURPOSE. IN NO EVENT SHALL ASUS, ITS DIRECTORS, OFFICERS, EMPLOYEES OR AGENTS BE LIABLE FOR ANY INDIRECT, SPECIAL, INCIDENTAL, OR CONSEQUENTIAL DAMAGES (INCLUDING DAMAGES FOR LOSS OF PROFITS, LOSS OF BUSINESS, LOSS OF USE OR DATA, INTERRUPTION OF BUSINESS AND THE LIKE), EVEN IF ASUS HAS BEEN ADVISED OF THE POSSIBILITY OF SUCH DAMAGES ARISING FROM ANY DEFECT OR ERROR IN THIS MANUAL OR PRODUCT.

Product warranty or service will not be extended if: (1) the product is repaired, modified or altered, unless such repair, modification or alteration is authorized in writing by ASUS; or (2) the serial number of the product is defaced or missing.

Products and corporate names appearing in this manual may or may not be registered trademarks or copyrights of their respective companies, and are used only for identification or explanation and to the owners' benefit, without intent to infringe.

- Intel, LANDesk, and Pentium are registered trademarks of Intel Corporation.
- Celeron is a trademark of Intel Corporation.
- Vortex and Wavetracing are trademarks of Aureal Semiconductor Incorporated.
- IBM and OS/2 are registered trademarks of International Business Machines.
- Symbios is a registered trademark of Symbios Logic Corporation.
- Windows and MS-DOS are registered trademarks of Microsoft Corporation.
- Adobe and Acrobat are registered trademarks of Adobe Systems Incorporated.

The product name and revision number are both printed on the product itself. Manual revisions are released for each product design represented by the digit before and after the period of the manual revision number. Manual updates are represented by the third digit in the manual revision number.

For previous or updated manuals, BIOS, drivers, or product release information, contact ASUS at <http://www.asus.com.tw> or through any of the means indicated on the following page.

SPECIFICATIONS AND INFORMATION CONTAINED IN THIS MANUAL ARE FURNISHED FOR INFORMATIONAL USE ONLY, AND ARE SUBJECT TO CHANGE AT ANY TIME WITHOUT NOTICE, AND SHOULD NOT BE CONSTRUED AS A COMMITMENT BY ASUS. ASUS ASSUMES NO RESPONSIBILITY OR LIABILITY FOR ANY ERRORS OR INACCURACIES THAT MAY APPEAR IN THIS MANUAL, INCLUDING THE PRODUCTS AND SOFTWARE DESCRIBED IN IT.

Copyright © 1999 ASUSTeK COMPUTER INC. All Rights Reserved.

Product Name: **ASUS P2B-N**

Manual Revision: **1.04 E407**

Release Date: **July 1999**

ASUS CONTACT INFORMATION

ASUSTeK COMPUTER INC. (Asia-Pacific)

Marketing

Address: 150 Li-Te Road, Peitou, Taipei, Taiwan 112
Telephone: +886-2-2894-3447
Fax: +886-2-2894-3449
Email: info@asus.com.tw

Technical Support

Tel (English): +886-2-2894-3447 ext. 706
Tel (Chinese): +886-2-2894-3447 ext. 111
Fax: +886-2-2895-9254
Email: tsd@asus.com.tw
Newsgroup: news2.asus.com.tw
WWW: www.asus.com.tw
FTP: ftp.asus.com.tw/pub/ASUS

ASUS COMPUTER INTERNATIONAL (America)

Marketing

Address: 6737 Mowry Avenue, Mowry Business Center, Building 2
Newark, CA 94560, USA
Fax: +1-510-608-4555
Email: info-usa@asus.com.tw

Technical Support

Fax: +1-510-608-4555
BBS: +1-510-739-3774
Email: tsd-usa@asus.com.tw
WWW: www.asus.com
FTP: ftp.asus.com.tw/pub/ASUS

ASUS COMPUTER GmbH (Europe)

Marketing

Address: Harkort Str. 25, 40880 Ratingen, BRD, Germany
Telephone: 49-2102-445011
Fax: 49-2102-442066
Email: sales@asuscom.de

Technical Support

Hotline: 49-2102-499712
BBS: 49-2102-448690
Email: tsd@asuscom.de
WWW: www.asuscom.de
FTP: ftp.asuscom.de/pub/ASUSCOM

CONTENTS

| | |
|---|-----------|
| 1. INTRODUCTION | 7 |
| 1.1 How This Manual Is Organized | 7 |
| 1.2 Item Checklist | 7 |
| 1.2.1 Motherboard | 7 |
| 1.2.2 Riser Card | 7 |
| 2. FEATURES | 8 |
| 2.1 The ASUS P2B-N Motherboard | 8 |
| 2.1.1 Specifications | 8 |
| 2.1.2 Special Features | 9 |
| 2.1.3 Performance Features | 10 |
| 2.1.4 Intelligence | 10 |
| 2.2 ASUS P2B-N Parts | 11 |
| 3. HARDWARE SETUP | 12 |
| 3.1 Motherboard Layout | 12 |
| 3.2 Riser Cards | 14 |
| 3.2.1 NLX-R Riser Card | 14 |
| 3.2.2 B9-N Riser Card | 14 |
| 3.2.3 Yeong-Yang Riser Card | 14 |
| 3.3 Hardware Setup Procedure | 17 |
| 3.4 Motherboard Settings | 17 |
| 3.5 System Memory (DIMM) | 23 |
| 3.5.1 General DIMM Notes | 23 |
| 3.5.2 DIMM Memory Installation | 24 |
| 3.6 Central Processing Unit (CPU) | 25 |
| 3.6.1 Universal Retention Mechanism | 25 |
| 3.6.2 Heatsinks | 25 |
| 3.6.3 Installing the Processor | 26 |
| 3.6.4 ASUS Smart Thermal Solutions | 28 |
| 3.6.5 Recommended Heatsinks for Slot 1 Processors | 29 |
| 3.7 Expansion Cards | 30 |
| 3.7.1 Expansion Card Installation Procedure | 30 |
| 3.7.2 Assigning IRQs for Expansion Cards | 30 |
| 3.7.3 Assigning DMA Channels for ISA Cards | 31 |
| 3.7.4 ISA Cards and Hardware Monitor | 31 |
| 3.8 External Connectors | 32 |
| 3.8.1 Back Panel Connectors | 32 |
| 3.8.2 Midboard Connectors | 35 |
| 3.8.3 Riser Card Connectors | 36 |
| 3.9 Power Connection Procedures | 41 |

CONTENTS

| | |
|--|------------|
| 4. BIOS SETUP | 42 |
| 4.1 Managing and Updating Your BIOS | 42 |
| 4.1.1 Upon First Use of the Computer System | 42 |
| 4.1.2 Updating BIOS Procedures (only when necessary) | 43 |
| 4.2 BIOS Setup | 45 |
| 4.3 Standard CMOS Setup | 46 |
| 4.4 BIOS Features Setup | 49 |
| 4.5 Chipset Features Setup | 52 |
| 4.6 Power Management Setup | 55 |
| 4.7 PNP and PCI Setup | 58 |
| 4.8 Load BIOS Defaults | 60 |
| 4.9 Load Setup Defaults | 60 |
| 4.10 Supervisor and User Password | 61 |
| 4.11 IDE HDD Auto Detection | 62 |
| 4.12 Save & Exit Setup | 63 |
| 4.13 Exit Without Saving | 63 |
| 5. SOFTWARE SETUP | 65 |
| 5.1 Support CD Main Menu (Windows 98) | 65 |
| 5.3 LDCM Local Setup | 68 |
| 5.4 LDCM Administrator Setup | 70 |
| 5.5 ASUS PC Probe | 71 |
| 5.6 ASUS LiveUpdate | 72 |
| 5.6 Driver | 73 |
| 5.7 Other | 76 |
| 5.8 Uninstalling Programs | 78 |
| 5.9 DOS and Windows 3.1 Setup for Novell | 79 |
| 5.10 Windows NT Server or Workstation | 80 |
| 5.11 Windows 95 | 82 |
| 5.12 Select Duplex Mode (optional) | 83 |
| 6. SOFTWARE REFERENCE | 85 |
| 6.1 ASUS PC Probe | 85 |
| 6.2 AudioRack32 | 91 |
| 6.3 Display Settings for Windows 95/98 | 100 |
| 6.4 Desktop Management Interface (DMI) | 102 |
| 7. APPENDIX | 105 |
| 7.1 PCI-L101 Fast Ethernet Card | 105 |
| 7.2 S370 Series CPU Cards | 107 |
| 7.3 Network Controller | 109 |
| 7.4 Glossary | 115 |

FCC & DOC COMPLIANCE

Federal Communications Commission Statement

This device complies with FCC Rules Part 15. Operation is subject to the following two conditions:

- This device may not cause harmful interference, and
- This device must accept any interference received, including interference that may cause undesired operation.

This equipment has been tested and found to comply with the limits for a Class B digital device, pursuant to Part 15 of the FCC Rules. These limits are designed to provide reasonable protection against harmful interference in a residential installation. This equipment generates, uses and can radiate radio frequency energy and, if not installed and used in accordance with manufacturer's instructions, may cause harmful interference to radio communications. However, there is no guarantee that interference will not occur in a particular installation. If this equipment does cause harmful interference to radio or television reception, which can be determined by turning the equipment off and on, the user is encouraged to try to correct the interference by one or more of the following measures:

- Re-orient or relocate the receiving antenna.
- Increase the separation between the equipment and receiver.
- Connect the equipment to an outlet on a circuit different from that to which the receiver is connected.
- Consult the dealer or an experienced radio/TV technician for help.

WARNING! Any changes or modifications to this product not expressly approved by the manufacturer could void any assurances of safety or performance and could result in violation of Part 15 of the FCC Rules.

Canadian Department of Communications Statement

This digital apparatus does not exceed the Class B limits for radio noise emissions from digital apparatus set out in the Radio Interference Regulations of the Canadian Department of Communications.

This Class B digital apparatus complies with Canadian ICES-003.

Cet appareil numérique de la classe B est conforme à la norme NMB-003 du Canada.

1. INTRODUCTION

1.1 How This Manual Is Organized

This manual is divided into the following sections:

- | | |
|------------------------------|--|
| 1. Introduction | Manual information and checklist |
| 2. Features | Information and specifications concerning this product |
| 3. Hardware Setup | Instructions on setting up the motherboard and jumpers |
| 4. BIOS Setup | Instructions on setting up the BIOS software |
| 5. Software Setup | Instructions on setting up the included support software |
| 6. Software Reference | Reference material for the included support software |
| 7. Appendix | Optional items and general reference |

1.2 Item Checklist

Please check that your package is complete. If you discover damaged or missing items, please contact your retailer.

1.2.1 Motherboard

- (1) ASUS motherboard
- (1) Universal retention mechanism for SECC2/SECC/SEPP
- (1) Support CD with drivers and utilities
- (1) Motherboard User's Manual
- (1) System housing User's Manual
- (1) NLX Form-factor system housing, riser card, and power supply
- ASUS Slim CD-ROM (optional)
- S-P2FAN or P2T-Cable for Slot 1 processors (optional)
- IrDA-compliant infrared module (optional)
- ASUS S370 CPU card series (optional)
- ASUS PCI-L101 Wake-On-LAN 10/100 Ethernet Card (optional)

NOTE: This motherboard only works with ASUS riser cards. See your dealer for more information.

1.2.2 Riser Card

- (1) ASUS Riser Card
- (1) UltraDMA/33 IDE + 3.5" floppy disk drive connector set
- OR**
- (1) UltraDMA/66 IDE cable and (1) 3.5" floppy disk drive cable
- (1) Bag of spare jumper caps
- (1) FDC slim CD-ROM cable (optional)

2. FEATURES

2.1 The ASUS P2B-N Motherboard

The ASUS P2B-N is carefully designed for the demanding PC user who wants advanced features processed by the fastest CPU.

2.1.1 Specifications

- **NLX:** Features ASUS' custom designed NLX form factor.
- **Multi-Speed:** Supports Intel Pentium® III (450MHz and faster), Pentium® II (233MHz to 450MHz), and Celeron™ SEPP (266MHz and faster) processors.
- **Multi-Cache:** Supports processors with 512, 256, 128, or 0KB Pipelined Burst Level 2 cache.
- **Anti-Boot Virus BIOS:** Features a programmable BIOS, offering enhanced Advanced Configuration Power Interface (ACPI) support for Windows 98 compatibility, built-in firmware-based virus protection through Trend ChipAway Virus codes, and autodetection of most devices for virtually automatic setup.
- **Intel AGPset:** Features Intel's 440BX AGPset with I/O subsystems and front-side bus (FSB) platform, which boosts the traditional 66MHz external bus speed to 100MHz.
- **PC100 Memory Support:** Equipped with two DIMM sockets to support Intel PC100-compliant SDRAMs (8, 16, 32, 64, 128, or 256MB) up to 512MB. These new SDRAMs are necessary to meet the critical enhanced 100MHz bus speed requirement.
- **100/10Mbps LAN (optional):** Features an onboard Intel 82558 Ethernet LAN Controller (fully integrated 10BASE-T/100BASE-TX) and a LAN Activity LED for monitoring network conditions.
- **AGP VGA (optional):** Features an onboard ATI 3D Rage Pro AGP 2X (8MB SDRAM) or Rage IIC (4MB SDRAM) for 3D hardware acceleration.
- **PCI Audio (optional):** Features onboard the ESS Solo-1 32-bit 3D positional PCI audio which supports games and applications for Sound Blaster™ and Sound Blaster Pro and full-duplex stereo.
- **Thermal Sensor Connector with Optional Sensor:** Accurately detects the CPU temperature of processors with the ASUS Smart Fan or the Intel boxed processor heatsink with fan when connected to an ASUS P2T-Cable.
- **Hardware Monitoring (optional):** Provides an easier way to examine and manage system status information, such as CPU and system voltages, temperatures, and fan status through the onboard hardware ASIC and the bundled LDCM by Intel or PC Probe from ASUS.
- **Riser Cards:** Provides NLX power, IDE, floppy drive, LAN wake up connectors; PCI/ISA slots; and USB and IrDA support.
- **Ultra DMA/33 BM IDE:** Comes with an onboard PCI Bus Master IDE controller with two connectors that supports four IDE devices in two channels, supports Ultra DMA/33, PIO Modes 3 and 4 and Bus Master IDE DMA Mode 2, and supports Enhanced IDE devices, such as Tape Backup, CD-ROM, and LS-120 drives.

2. FEATURES

- **Universal Retention Mechanism:** Supports a Pentium® III / II processor packaged in a Single Edge Contact Cartridge (SECC2/SECC) or a Celeron™ processor packaged in a Single Edge Processor Package (SEPP).
- **Wake-On-LAN Connector:** Supports Wake-On-LAN activity through an optional ASUS PCI-L101 10/100 Fast Ethernet PCI card (see *7.1 PCI-L101 LAN Card*) or a similar ethernet card.
- **IrDA:** Includes/supports an infrared module for wireless interface.
- **Slim CD-ROM:** Supports an optional ASUS slim CD-ROM drive for ASUS' custom designed NLX form factor.

2.1.2 Special Features

- **ACPI Ready:** Advanced Configuration Power Interface (ACPI) provides more Energy Saving Features for operating systems that support OS Direct Power Management (OSPM) functionality. With these features implemented in the OS, PCs can be ready around the clock, yet satisfy all the energy saving standards. To fully utilize the benefits of ACPI, an ACPI-supported OS, such as Windows 98, must be used.
- **Suspend and Go:** Suspend-to-RAM provides maximum power savings as an alternative to leaving the computer ON and QuickStart™ so that you do not fall asleep waiting for system bootup (Suspend-to-RAM supported OS required).
- **Desktop Management Interface (DMI):** Supports DMI through BIOS, which allows hardware to communicate within a standard protocol creating a higher level of compatibility. (Requires DMI-enabled components.)
- **Easy Installation:** Incorporates BIOS that supports autodetection of hard disk drives, PS/2 mouse, and Plug and Play devices to make the setup of hard disk drives, expansion cards, and other devices virtually automatic.
- **PC'98 Compliant:** Both the BIOS and hardware levels of ASUS smart series motherboards meet PC'98 compliancy. The new PC'98 requirements for systems and components are based on the following high-level goals: Support for Plug and Play compatibility and power management for configuring and managing all system components, and 32-bit device drivers and installation procedures for Windows 95/98/NT.
- **Symbios SCSI BIOS:** Supports optional ASUS SCSI controller cards through the onboard SYMBIOS firmware.

2.1.3 Performance Features

- **Concurrent PCI:** Concurrent PCI allows multiple PCI transfers from PCI mas-

2. FEATURES

ter busses to the memory and processor.

- **Double the IDE Transfer Speed:** ASUS smart series motherboards with Intel chipsets improves IDE transfer rate using Bus Master UltraDMA/33 IDE which can handle data transfer up to 33MB/s.
- **SDRAM Optimized Performance:** Supports the new generation memory - Synchronous Dynamic Random Access Memory (SDRAM) which increases the data transfer rate to 800MB/s max using PC100-compliant SDRAM.

2.1.4 Intelligence

- **Dual Function Power Button:** Pushing the power button for less than 4 seconds when the system is in the working state places the system into one of two states: sleep mode or soft-off mode, depending on the BIOS or OS setting (see **PWR Button < 4 Secs** in *4.6 Power Management Setup*). When the power button is pressed for more than 4 seconds, the system enters the soft-off mode regardless of the BIOS setting.
- **Fan Status Monitoring and Alarm (only w/ hardware monitor):** To prevent system overheat and system damage, the CPU, power supply, and system fans can be monitored for RPM and failure. All fans are set for its normal RPM range and alarm thresholds.
- **Message LED (requires ACPI OS support):** Turbo LEDs now act as information providers. Through the way a particular LED illuminates, the user can determine the stage the computer is in. A simple glimpse provides useful information to the user.
- **Remote Ring On (requires external modem):** This allows a computer with this motherboard to be turned on remotely through an external modem. With this feature, users can access their computers from anywhere in the world!
- **System Resources Alert (only w/ hardware monitor):** Today's operating systems such as Windows 95/98/NT and OS/2, require much more memory and hard drive space to present enormous user interfaces and run large applications. The system resource monitor will warn the user before the system resources are used up to prevent possible application crashes. Suggestions will give the user information on managing their limited resources more efficiently.
- **Temperature Monitoring and Alert (only w/ hardware monitor):** To prevent system overheat and system damage, there are heat sensors to monitor the CPU (the Pentium III/II processors require a special heatsink with a thermal sensor) and system temperatures to warn of damaging temperatures.
- **Voltage Monitoring and Alert (only w/ hardware monitor):** System voltage levels are monitored to ensure stable voltage to critical motherboard components. Voltage specifications are more critical for future processors, so monitoring is necessary to ensure proper system configuration and management.

2. FEATURES

2.2 ASUS P2B-N Parts

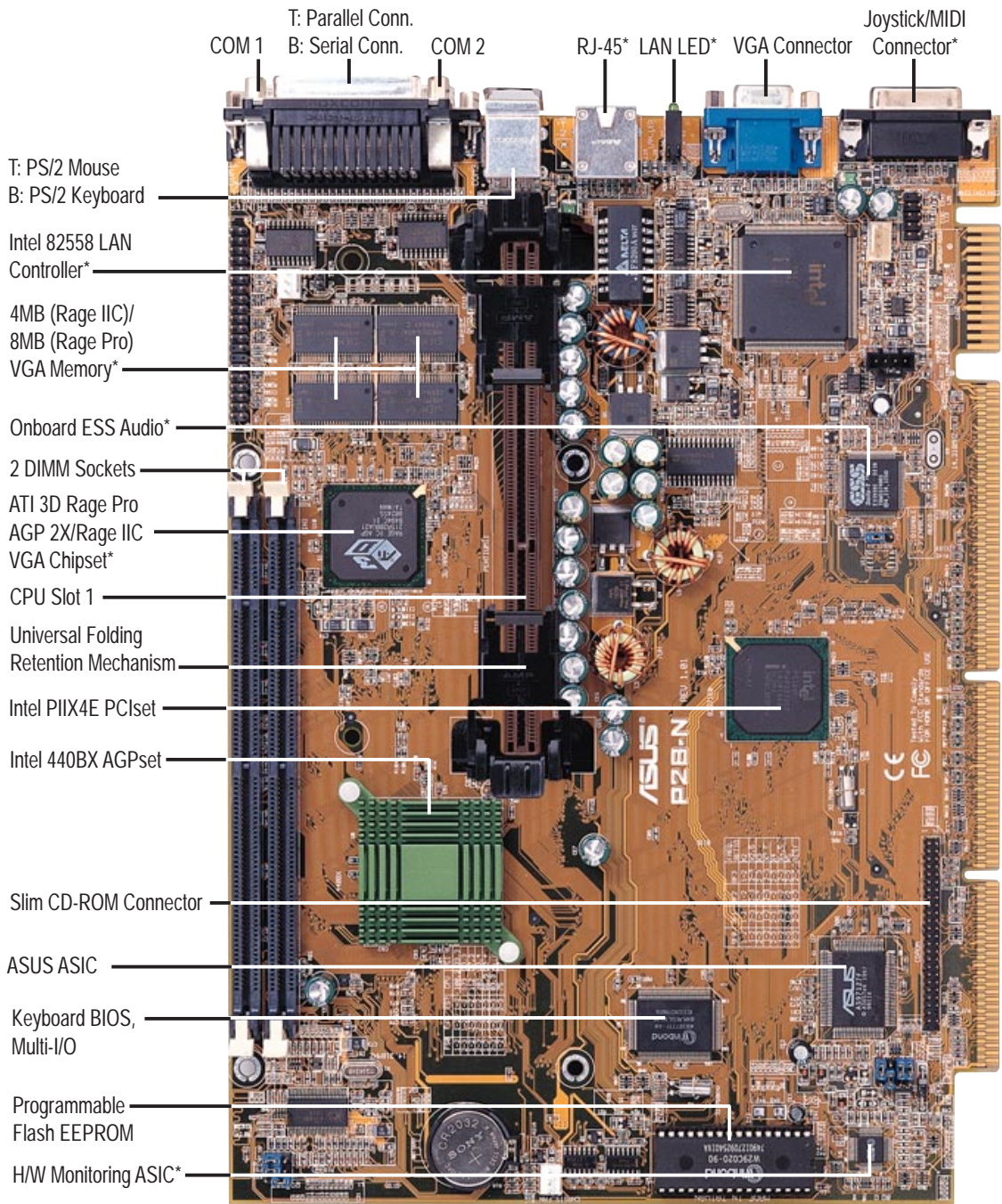

2. FEATURES
Motherboard Parts

*Optional at the time of purchase

3. HARDWARE SETUP

3.1 Motherboard Layout

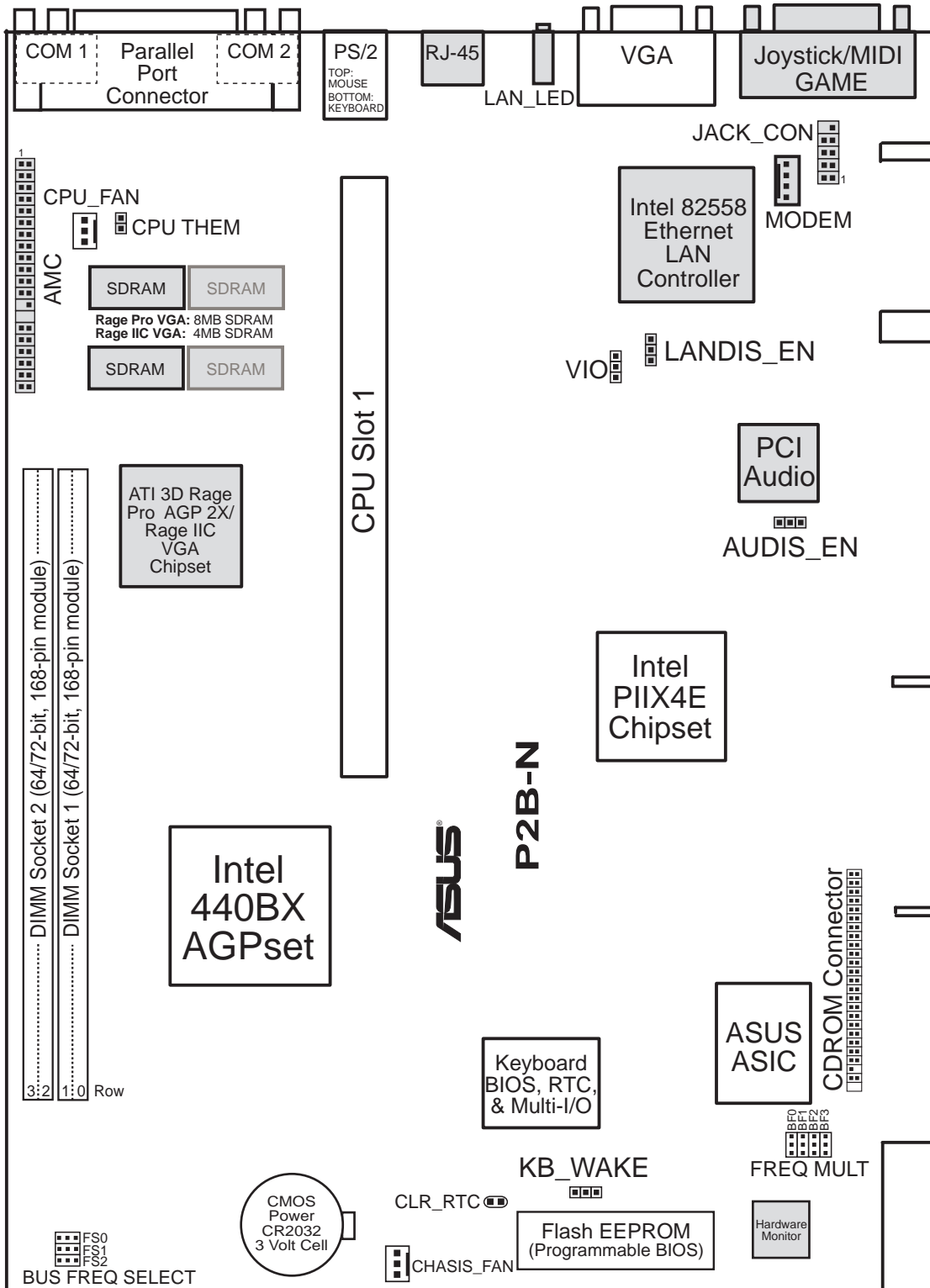

(Grayed items are optional at the time of purchase.)

3. HW SETUP
Motherboard Layout

3. HARDWARE SETUP

Motherboard Settings

- | | | |
|-----------------------|-------|--|
| 1) VIO | p. 18 | Voltage Input/Output Selection |
| 2) LANDIS_EN | p. 18 | LAN Setting (Enable/Disable) |
| 3) AUDIS_EN | p. 19 | Audio Setting (Enable/Disable) |
| 4) KB_WAKE | p. 19 | Keyboard Wake Up (Enable/Disable) |
| 5) FS0, FS1, FS2 | p. 20 | CPU External Clock (Bus) Frequency Selection |
| 6) BF0, BF1, BF2, BF3 | p. 20 | CPU Core:Bus Frequency Multiple |

Sockets

- | | | |
|-----------------|-------|--------------------------------------|
| 1) DIMM1, DIMM2 | p. 24 | 168-pin DIMM Memory Expansion Socket |
| 2) CPU Slot 1 | p. 25 | CPU Support |

Hardware Monitor

- | | | |
|-------------|-------|--------------------------|
| 1) CPU THEM | p. 29 | Thermal Sensor Connector |
|-------------|-------|--------------------------|

Back Panel Connectors

- | | | |
|---------------|-------|--|
| 1) PRINTER | p. 32 | Parallel Port Connector (25-pin female) |
| 2) COM1, COM2 | p. 32 | Serial Port Connectors (Two 9-pin male) |
| 3) PS2KBMS | p. 33 | PS/2 Mouse Connector (6-pin female) |
| 4) PS2KBMS | p. 33 | PS/2 Keyboard Connector (6-pin female) |
| 5) RJ-45 | p. 33 | Fast-Ethernet Port Connector |
| 6) LAN_LED | p. 33 | LAN Diagnostic LEDs |
| 7) VGA | p. 34 | Monitor (VGA) Output Connector (15-pin female) |
| 8) GAME | p. 34 | Joystick or MIDI Connector (15-pin female) |

Midboard Connectors

- | | | |
|---------------------|-------|--|
| 1) CPU_, CHASIS_FAN | p. 34 | CPU Fan Power (Two 3-pin blocks) |
| 2) CDROM | p. 35 | CD-ROM Drive Connector (50-3 pins) |
| 3) MODEM | p. 35 | Voice Modem In Connector (4 pins) |
| 4) AMC | p. 36 | ATI Multimedia Connector (40-3 pin block) |
| 5) JACK_CON | p. 36 | Back Panel Audio Connectors (10-1 pin block) |

3. HARDWARE SETUP

3.2 Riser Cards

3.2.1 NLX-R Riser Card

NOTE: Grayed items are optional at the time of purchase.

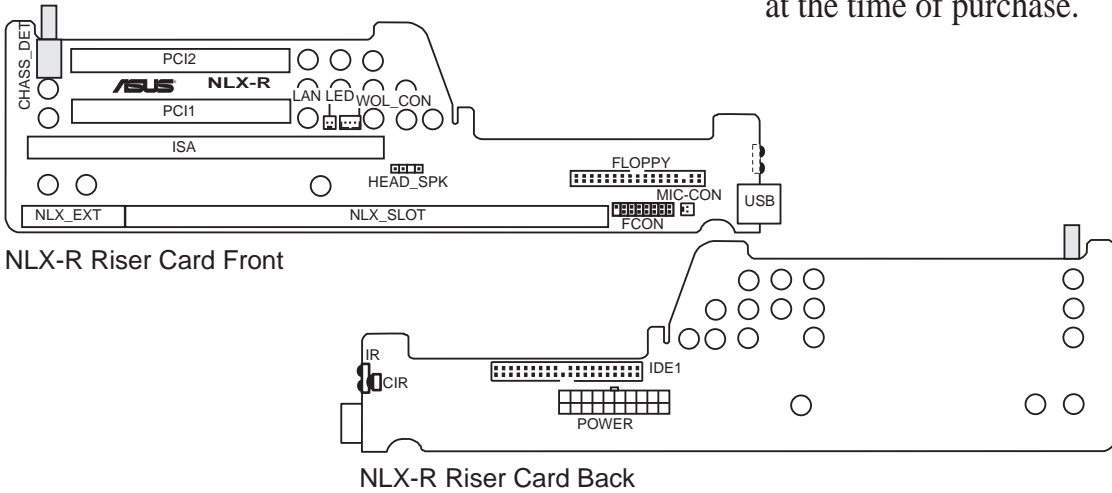

3.2.2 B9-N Riser Card

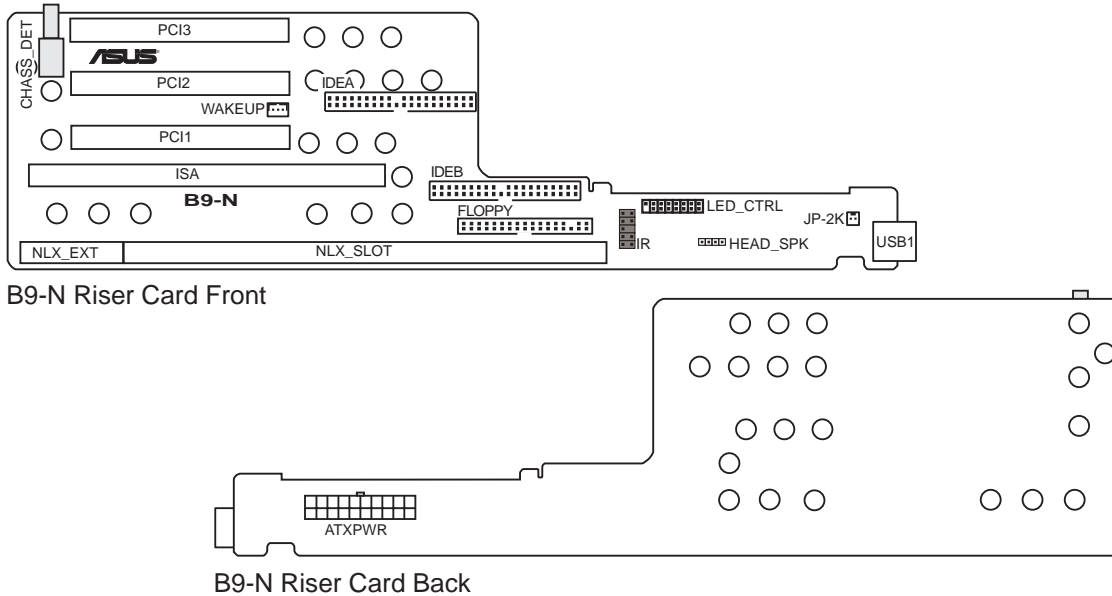

3.2.3 Yeong-Yang Riser Card

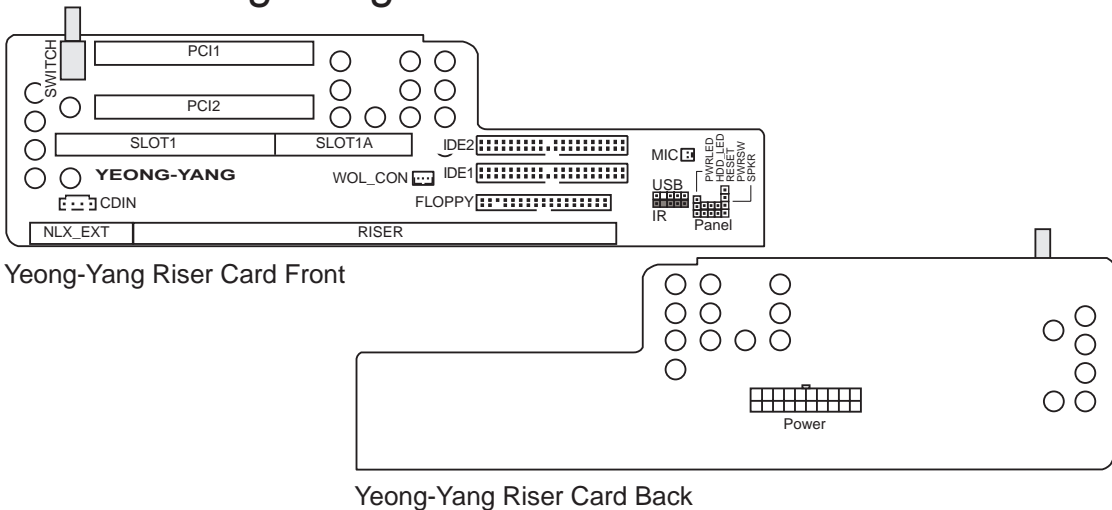

3. HARDWARE SETUP

Riser Card Expansion Slots

- | | | |
|-------------------------|-------|---------------------------------|
| 1) ISA (NLX-R) | p. 30 | 16-bit ISA Bus Expansion Slots* |
| ISA (B9-N) | | 16-bit ISA Bus Expansion Slots |
| SLOT1/1A (Yeong-Yang) | | 16-bit ISA Bus Expansion Slots |
| 2) PCI1, PCI2 (NLX-R) | p. 30 | 32-bit PCI Bus Expansion Slots |
| PCI1, PCI2, PCI3 (B9-N) | | 32-bit PCI Bus Expansion Slots |
| PCI1, PCI2 (Yeong-Yang) | | 32-bit PCI Bus Expansion Slots |

Riser Card Connectors

- | | | |
|-------------------------|-------|--|
| 1) CDIN (Yeong-Yang) | p. 36 | Stereo Audio In Connector |
| 2) LAN_LED (NLX-R) | p. 37 | LAN Activity LED Connector (2 pins) |
| WOL_CON (NLX-R) | | Wake-On-LAN Connector (3 pins) |
| WAKEUP (B9-N) | | Wake-On-LAN Connector (3 pins) |
| WOL_CON (Yeong-Yang) | | Wake-On-LAN Connector (3 pins) |
| 3) FCON (NLX-R) | p. 37 | Front Panel Connector (16-1 pins) |
| HEAD_SPK (NLX-R) | | Speaker Connector (4-1 pins) |
| LED_CTRL (B9-N) | | Front Panel Connector (16-1 pins) |
| HEAD_SPK (B9-N) | | Speaker Connector (4-1 pins) |
| PANEL (Yeong-Yang) | | Front Panel Connector (16-1 pins) |
| 4) MIC-CON (NLR-R) | p. 38 | Front Panel Microphone Jack Connector (2 pins) |
| JP-2K (B9-N) | | Front Panel Microphone Jack Connector (2 pins) |
| MIC (Yeong-Yang) | | Front Panel Microphone Jack Connector (2 pins) |
| 5) POWER | p. 38 | NLX Power Supply Connector (20-pin block) |
| ATXPWR | | NLX Power Supply Connector (20-pin block) |
| Power | | NLX Power Supply Connector (20-pin block) |
| 6) IDE1 (NLX-R) | p. 39 | IDE Connector (40-1 pins) |
| IDEA, IDEB (B9-N) | | IDE Connectors (40-1 pins) |
| IDE1, IDE2 (Yeong-Yang) | | IDE Connectors (40-1 pins) |
| 7) FLOPPY (NLX-R) | p. 39 | Floppy Drive Connector (34-1 pins) |
| FLOPPY (B9-N) | | Floppy Drive Connector (34-1 pins) |
| FLOPPY (Yeong-Yang) | | Floppy Drive Connector (34-1 pins) |
| 8) USB (NLX-R) | p. 40 | USB Ports (Two 4-pin sockets) |
| USB1 (B9-N) | | USB Ports (Two 4-pin sockets) |
| USB (Yeong-Yang) | | USB Module Connector (5-1 pins) |
| 9) IR, CIR (NLX-R) | p. 40 | IrDA-Compliant Infrared Module (Lenses) |
| IR (B9-N) | | Infrared Module Connector (10-1 pins) |
| IR (Yeong-Yang) | | Infrared Module Connector (5-1 pins) |

* The optional onboard hardware monitor uses the address 290H-297H, so legacy ISA cards must not use this address or else conflicts will occur.

3. HARDWARE SETUP

(This page was intentionally left blank.)

3. HARDWARE SETUP

3.3 Hardware Setup Procedure

Before using your computer, you must complete the following steps:

1. **Check Motherboard Settings**
2. **Install Memory Modules**
3. **Install the Central Processing Unit (CPU)**
4. **Install Expansion Cards**
5. **Connect Ribbon Cables, Panel Wires, and Power Supply**
6. **Setup the BIOS Software**

3.4 Motherboard Settings

This section explains in detail how to change your motherboard's function settings through the use of switches and/or jumpers.

WARNING! Computer motherboards and expansion cards contain very delicate Integrated Circuit (IC) chips. To protect them against damage from static electricity, you should follow some precautions whenever you work on your computer.

1. Unplug your computer when working on the inside.
2. Use a grounded wrist strap before handling computer components. If you do not have one, touch both of your hands to a safely grounded object or to a metal object, such as the power supply case.
3. Hold components by the edges and try not to touch the IC chips, leads or connectors, or other components.
4. Place components on a grounded antistatic pad or on the bag that came with the component whenever the components are separated from the system.

3. HARDWARE SETUP

1) +3V Voltage Selection (VIO)

This jumper allows you to select the voltage supplied to the DRAM, chipset, AGP, and the CPU's I/O buffer. **IMPORTANT!** Setting this jumper to *High Volt* (3.5V) may cause your system to become unstable. It is strongly recommended that you leave this jumper on its default setting of *Normal Volt* (3.3V).

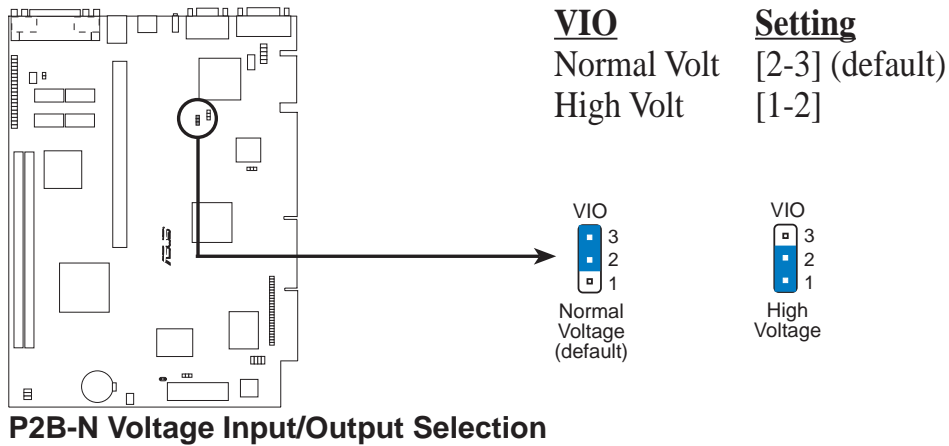

2) LAN Setting (LANDIS_EN)

The onboard Intel 10/100 Fast Ethernet may be enabled or disabled using this jumper. The default is set to *Enable*.

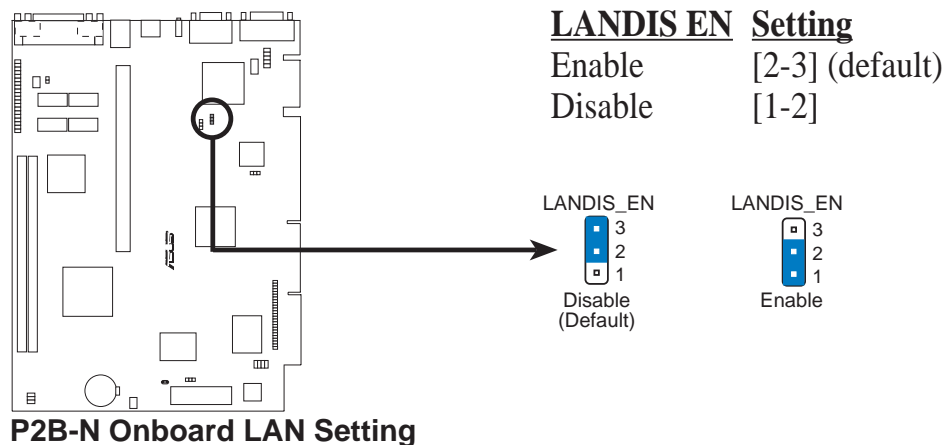



3. HARDWARE SETUP

3) Audio Setting (AUDIS_EN)

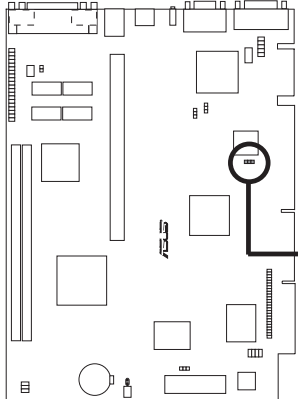
The onboard 32-bit PCI audio may be enabled or disabled using this jumper.



| <u>AUDIS EN</u> | <u>Setting</u> |
|-----------------|-----------------|
| Enable | [2-3] (default) |
| Disable | [1-2] |

| AUDIS_EN | AUDIS_EN |
|---|---|
|  |  |
| 3 2 1 | 3 2 1 |
| Disable | Enable (Default) |



P2B-N Onboard Audio Setting

4) Keyboard Wake Up (KB_WAKE)

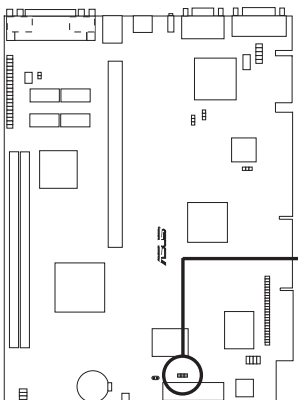
This allows you to disable or enable the keyboard power up function. Set this jumper to *Enable* if you wish to use your keyboard (by pressing the spacebar) to power up your computer. This feature requires an ATX power supply that can supply at least 300mAmp on the +5VSB lead. The default is set to *Disable* because not all computers have the appropriate ATX power supply. Your computer will not power on if you set this to *Enable* and if you do not have the right ATX power supply. **WARNING!** This jumper setting must coincide with the BIOS setting (see “Power Up By Keyboard” in the Power Management Setup of the BIOS SOFTWARE) or else conflicts will occur.



| <u>KB WAKE</u> | <u>Setting</u> |
|----------------|-----------------|
| Disable | [1-2] (default) |
| Enable | [2-3] |

| KB_WAKE | KB_WAKE |
|---|---|
|  |  |
| 3 2 1 | 3 2 1 |
| Disable (Default) | Enable |

P2B-N Keyboard Wake Up

3. HARDWARE SETUP

5) CPU Bus Frequency Selector (FS0, FS1, FS2)

This option tells the clock generator what frequency to send to the CPU, DRAM, and AGPset. This allows the selection of the CPU's *External* frequency (or *BUS Clock*). The Bus Clock multiplied by the Bus Multiple equals the CPU's *Internal* frequency (the advertised CPU speed).

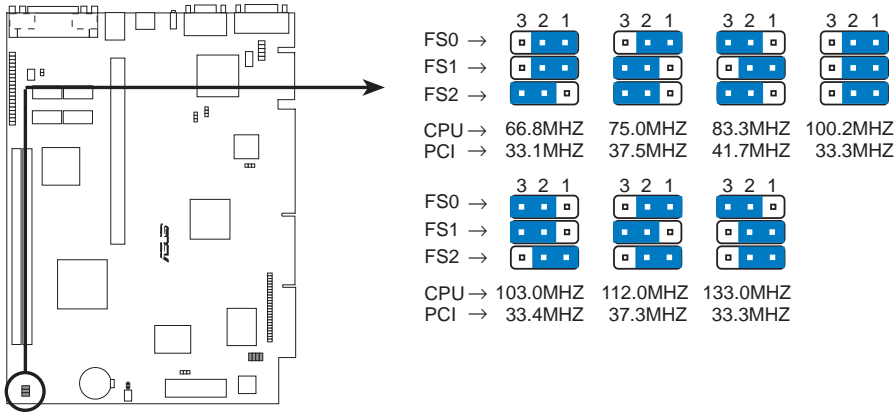

P2B-N CPU Bus Frequency Setting

6) CPU Core:Bus Frequency Multiple (BF0, BF1, BF2, BF3)

This option sets the frequency multiple between the *Internal* frequency of the CPU and the CPU's *External* frequency. These must be set in conjunction with the *CPU Bus Frequency*.

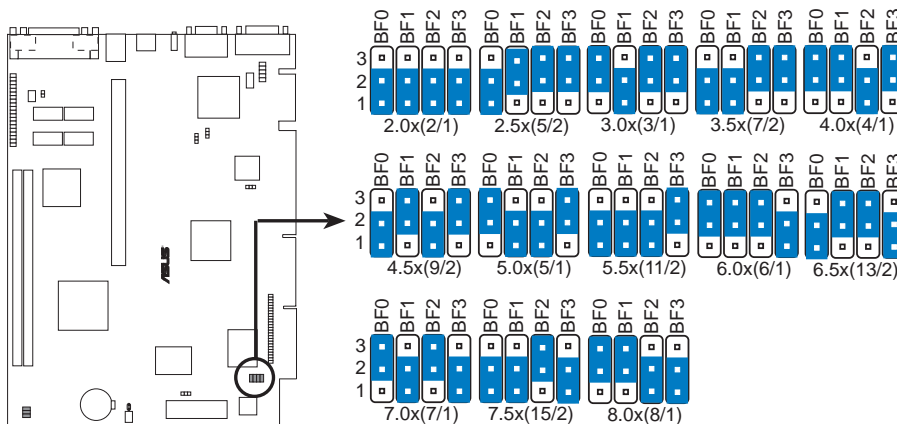

P2B-N CPU Core:Bus Frequency Multiple Selection

3. HARDWARE SETUP

Set the jumpers by the Internal speed of your processor as follows:

| Intel CPU Model | Freq. | Mult. | Bus Freq. | (CPU Bus Freq.) | | | (Freq. Multiple) | | | |
|--------------------|--------|-------|-----------|-----------------|-------|-------|------------------|-------|-------|-------|
| | | | | FS0 | FS1 | FS2 | BF0 | BF1 | BF2 | BF3 |
| Pentium III | 600MHz | 6.0x | 100MHz | [1-2] | [1-2] | [1-2] | [2-3] | [2-3] | [2-3] | [1-2] |
| Pentium III | 550MHz | 5.5x | 100MHz | [1-2] | [1-2] | [1-2] | [1-2] | [1-2] | [1-2] | [2-3] |
| Pentium III | 500MHz | 5.0x | 100MHz | [1-2] | [1-2] | [1-2] | [2-3] | [1-2] | [1-2] | [2-3] |
| Pentium III/II | 450MHz | 4.5x | 100MHz | [1-2] | [1-2] | [1-2] | [1-2] | [2-3] | [1-2] | [2-3] |
| Pentium II | 400MHz | 4.0x | 100MHz | [1-2] | [1-2] | [1-2] | [2-3] | [2-3] | [1-2] | [2-3] |
| Pentium II | 350MHz | 3.5x | 100MHz | [1-2] | [1-2] | [1-2] | [1-2] | [1-2] | [2-3] | [2-3] |
| Celeron | 500MHz | 7.5x | 66MHz | [1-2] | [1-2] | [2-3] | [1-2] | [1-2] | [2-3] | [1-2] |
| Celeron | 466MHz | 7.0x | 66MHz | [1-2] | [1-2] | [2-3] | [2-3] | [1-2] | [2-3] | [1-2] |
| Celeron | 433MHz | 6.5x | 66MHz | [1-2] | [1-2] | [2-3] | [1-2] | [2-3] | [2-3] | [1-2] |
| Celeron | 400MHz | 6.0x | 66MHz | [1-2] | [1-2] | [2-3] | [2-3] | [2-3] | [2-3] | [1-2] |
| Celeron | 366MHz | 5.5x | 66MHz | [1-2] | [1-2] | [2-3] | [1-2] | [1-2] | [1-2] | [2-3] |
| Pentium II/Celeron | 333MHz | 5.0x | 66MHz | [1-2] | [1-2] | [2-3] | [2-3] | [1-2] | [1-2] | [2-3] |
| Pentium II/Celeron | 300MHz | 4.5x | 66MHz | [1-2] | [1-2] | [2-3] | [1-2] | [2-3] | [1-2] | [2-3] |
| Pentium II/Celeron | 266MHz | 4.0x | 66MHz | [1-2] | [1-2] | [2-3] | [2-3] | [2-3] | [1-2] | [2-3] |
| Pentium II | 233MHz | 3.5x | 66MHz | [1-2] | [1-2] | [2-3] | [2-3] | [2-3] | [1-2] | [2-3] |

For updated processor settings, please visit ASUS' web site (see ASUS CONTACT INFORMATION).

WARNING! Frequencies above 100MHz exceed the specifications for the onboard Intel Chipset and are not guaranteed to be stable.

WARNING! PCI frequencies above 33MHz exceed the specifications for PCI cards and are not guaranteed to be stable.

NOTE: Overclocking your processor is not recommended. It may result in a slower speed. Voltage Regulator Output Selection (VID) is not needed for the Pentium III / II / Celeron processor because it sends VID signals directly to the onboard power controller.

3. HARDWARE SETUP

(This page was intentionally left blank.)

3. HARDWARE SETUP

3.5 System Memory (DIMM)

NOTE: No hardware or BIOS setup is required after adding or removing memory. This motherboard uses only Dual Inline Memory Modules (DIMMs). Sockets are available for **3.3Volt** (power level) unbuffered Synchronous Dynamic Random Access Memory (SDRAM). One side (with memory chips) of the DIMM takes up one row on the motherboard.

To utilize the chipset's Error Checking and Correction (ECC) feature, you must use a DIMM module with 9 chips per side (standard 8 chips/side + 1 ECC chip) and make the proper settings through **4.5 Chipset Features Setup**.

Memory speed setup is recommended through **SDRAM Configuration** in **4.5 Chipset Features Setup**.

Install memory in any combination as follows:

| DIMM Location | 168-pin DIMM | | Total Memory |
|---------------------|--|----|--------------|
| Socket 1 (Rows 0&1) | SDRAM 8, 16, 32, 64, 128, 256MB | x1 | |
| Socket 2 (Rows 2&3) | SDRAM 8, 16, 32, 64, 128, 256MB | x1 | |
| | Total System Memory (Max 512MB) | = | |

NOTE: At the time this User's Manual was written, 256MB DIMMs are only available as registered memory.

3.5.1 General DIMM Notes

- **For the system CPU bus to operate at 100MHz, use only PC100-compliant DIMMs.** When this motherboard operates at 100MHz, most system will not even boot if non-compliant modules are used because of the strict timing issues involved under this speed. If your DIMMs are not PC100-compliant, set the CPU bus frequency (FS) to 66MHz RAM to ensure system stability.
- ASUS motherboards support SPD (Serial Presence Detect) DIMMs. This is the memory of choice for best performance vs. stability.
- Two possible memory chips are supported: SDRAM with and without ECC.
- SDRAM chips are generally thinner with higher pin density than EDO (Extended Data Output) chips.
- BIOS shows SDRAM memory on bootup screen.
- Single-sided DIMMs come in 16, 32, 64,128MB; double-sided come in 32, 64, 128, 256MB.

3. HARDWARE SETUP

3.5.2 DIMM Memory Installation

Insert the module(s) as shown. Because the number of pins are different on either side of the breaks, the module will only fit in the orientation shown. DRAM SIMM modules have the same pin contacts on both sides. SDRAM DIMMs have different pin contacts on each side and therefore have a higher pin density.

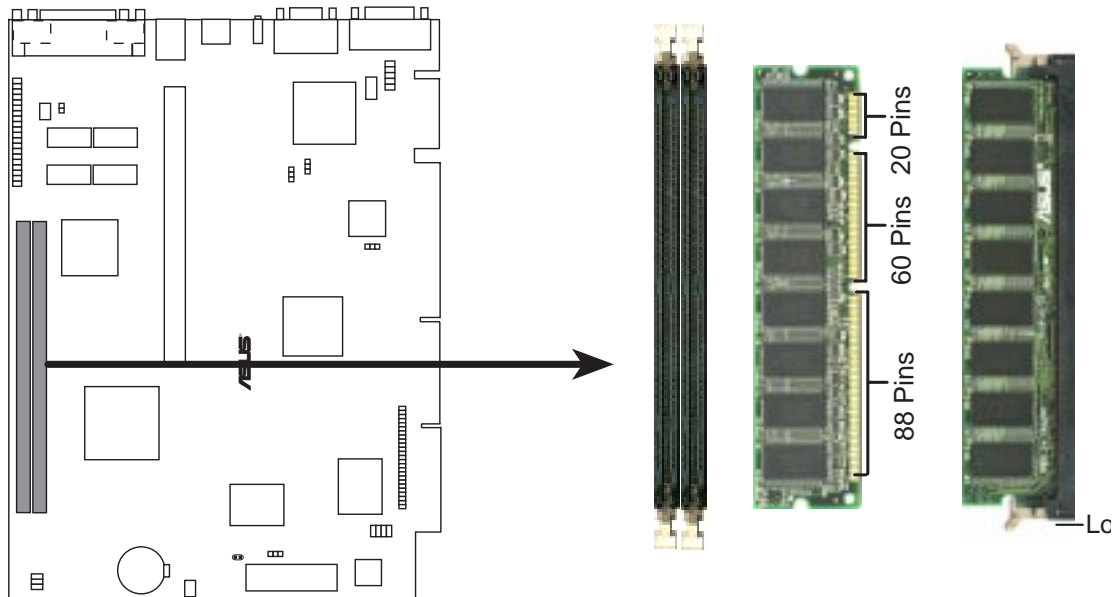

3. HW SETUP
System Memory

P2B-N 168-pin DIMM Memory Sockets

The DIMMs must be 3.3Volt unbuffered SDRAMs. To determine the DIMM type, check the notches on the DIMMs (see figure below).

168-Pin DIMM Notch Key Definitions (3.3V)

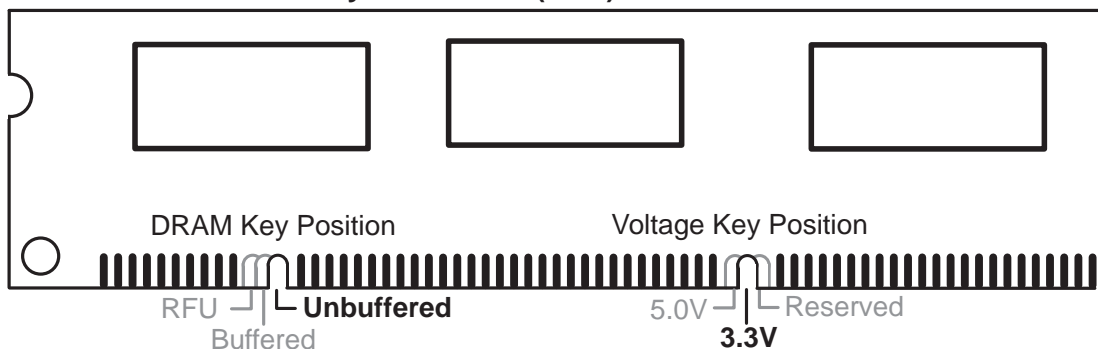

The notches on the DIMM will shift between left, center, or right to identify the type and also to prevent the wrong type from being inserted into the DIMM slot on the motherboard. You must tell your retailer the correct DIMM type before purchasing. This motherboard supports four clock signals per DIMM.

3. HARDWARE SETUP

3.6 Central Processing Unit (CPU)

NOTE: The following pictures are provided for reference purposes only. The appearance of your retention mechanism and fan may be different from the following examples.

Your motherboard provides a Slot 1 connector for a Pentium® III processor packaged in a Single Edge Contact Cartridge (SECC2), a Pentium® II processor packaged in SECC2/SECC, or a Celeron™ processor packaged in a Single Edge Processor Package (SEPP). An ASUS S370 CPU card can allow Socket 370 processors to be used on any ASUS motherboard with the Slot 1 connector (See 7.2 *S370 Series CPU Cards* for instructions on using this card).



Pentium II processor packaged in an SECC with heatsink and fan (top view)



Pentium III (in an SECC2) with heatsink and fan
NOTE: The SEPP fan (for Celeron processors) is similar to SECC2 fan except that the clamping design is different.

3.6.1 Universal Retention Mechanism

Your motherboard comes preinstalled with a Universal Retention Mechanism (URM). The URM supports Pentium III / II and Celeron processors.

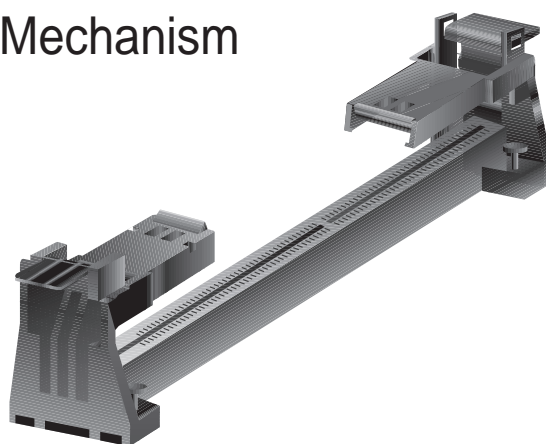

Universal Retention Mechanism (URM)

3.6.2 Heatsinks

The recommended heatsinks (see section on recommended heatsinks for Pentium III / II processors for more information) for the boxed Pentium III / II and Celeron processors are those with three-pin fans that can be connected to the fan connectors on the motherboard.

WARNING! Be sure that there is sufficient air circulation across the processor's heatsink by regularly checking that your CPU fan is working. Without sufficient circulation, the processor could overheat and damage both the processor and the motherboard. You may install an auxiliary chassis fan, if necessary.

3. HARDWARE SETUP

3.6.3 Installing the Processor

1. Unlock the URM's Folding Support Arms:

The folding support arms of the URM are locked when shipped.

To unlock the support arms, simply flip them up to an upright position.

The URM is now ready for the installation of your processor.

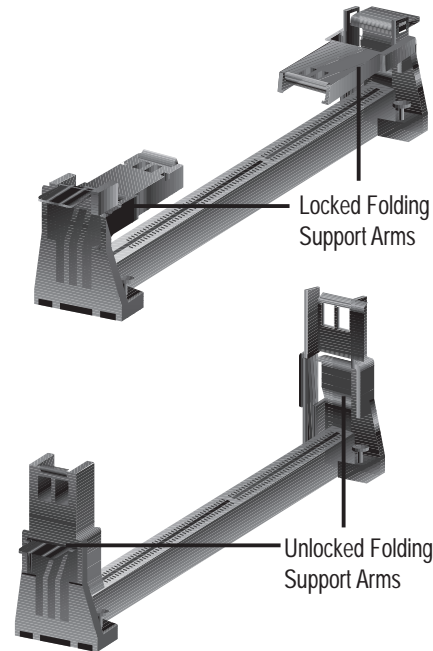

2. Attach the Heatsink

NOTE: If provided, you should follow the heatsink attachment instructions that came with your heatsink or processor. The following steps are provided only as a general guide and may not reflect those for your heatsink.

Using the SECC fan with the Pentium® II

Push the two lock arms one direction to clamp the heatsink onto the processor and the other direction to release.

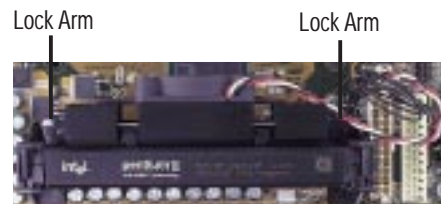

Using the SECC2 fan with the Pentium® III

Insert the four heatsink's pins through the holes of the SECC2. Place the metal clip on the ends of the pins and slide until it locks into place.

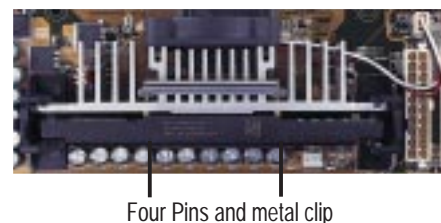

NOTE: The SEPP heatsink and fan (for Intel Celeron processors) is similar to the SECC2 heatsink and fan except that the clamping design is different.

3. HARDWARE SETUP

WARNING! Make sure the heatsink is mounted tightly against the SECC2, SECC, or SEPP; otherwise, the CPU will overheat. You may install an auxiliary fan to provide adequate circulation across the processor's passive heatsink.

3. Insert the SECC2/SECC/SEPP

SECC with Pentium® II only: Push the SECC's two locks inward until you hear a click (the picture in step 2 shows the locks in the outward position and inward in the picture below).

With the heatsink facing the motherboard's chipset, push the SECC, SECC2, or SEPP gently but firmly into the Slot 1 connector until it is fully inserted.

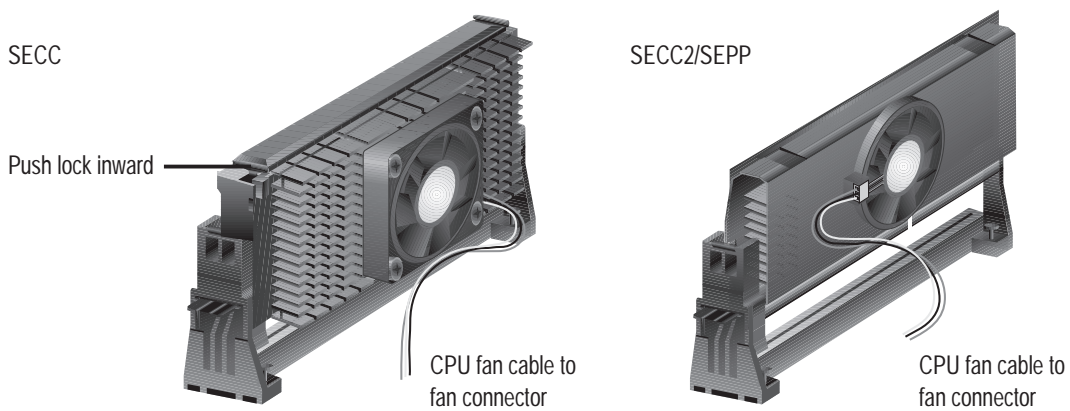

4. Secure the SECC2/SECC/SEPP

Secure the SECC2/SECC/SEPP in place by pushing the SECC2/SECC/SEPP until it is firmly seated on the Slot 1 connector.

SECC with Pentium® II only: The SECC locks should be outward when secured so that the lock shows through the retention mechanism's lock holes.

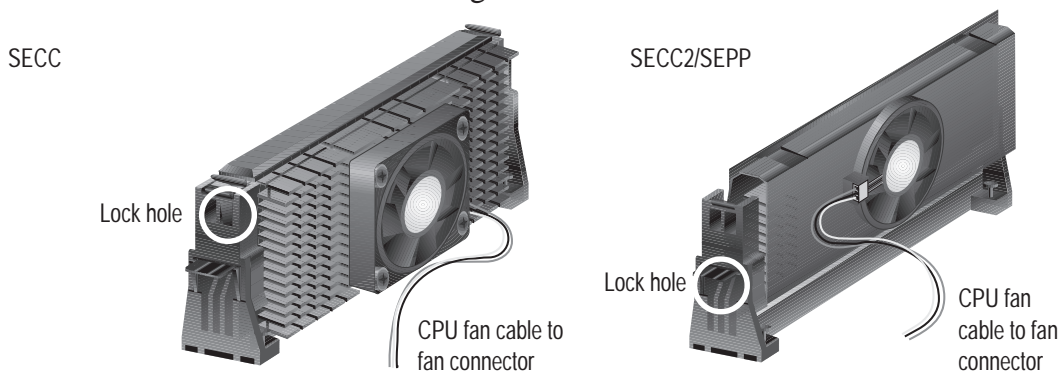

3. HARDWARE SETUP

3.6.4 ASUS Smart Thermal Solutions

(only with optional hardware monitor)

ASUS provides two smart solutions to Slot 1 CPU thermal problems: the **ASUS Smart Fan** or **ASUS S-P2FAN** and the **ASUS P2T-Cable**.

ASUS S-P2FAN

The optional ASUS Smart Fan or ASUS S-P2FAN is a CPU fan for a Pentium® II processor packaged in an SECC. Unlike other CPU thermal solutions, the ASUS S-P2FAN has an integrated thermal sensor located near the center of the CPU heat source. The sensor is optimized by ASUS to give the most accurate reading of the CPU temperature, thus provides the best protection to your computer system.

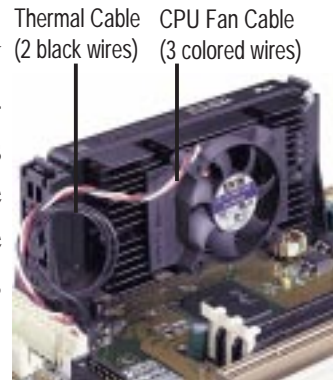

To Use the ASUS S-P2FAN

See **2. Attach the Heatsink** on the preceding page for the relevant procedures. Note that the S-P2FAN comes with a rock arm design for easy FAN/CPU installation.

ASUS P2T-Cable

The optional ASUS P2T-Cable can be used for a Pentium® III/II processor packaged in an SECC2/SECC, or a Celeron™ processor packaged in an SEPP.

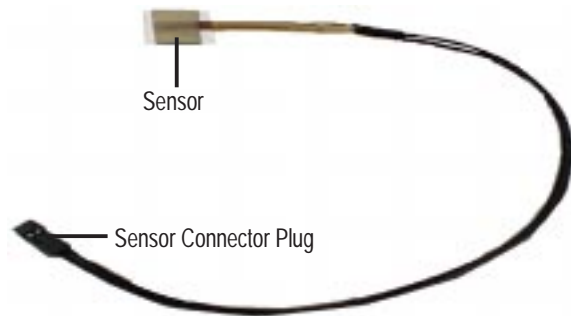

NOTE: The ASUS P2T-Cable can only be used in a Slot 1 motherboard with a 2-pin thermal sensor connector.

To Use the ASUS P2T-Cable

NOTE: The following procedures assume that you have properly attached a heatsink onto an SECC2/SECC/SEPP.

1. Simply peel off the tab from the sensor and then stick the sensor near the middle edge of the Intel boxed processor heatsink with fan (middle) or to either the upper or lower edge of the Celeron™ heatsink (right), as indicated.



3. HARDWARE SETUP

WARNING! Do not insert the sensor between the processor and heatsink, otherwise, it will cause damage to the P2T-Cable.

IMPORTANT: ASUS guarantees accurate readings only for the ASUS Smart Fan and the Intel boxed processor heatsink with fan because both have similar heat distribution and heatsink material.

2. Connect the P2T-Cable to the CPU thermal sensor connector on the motherboard.

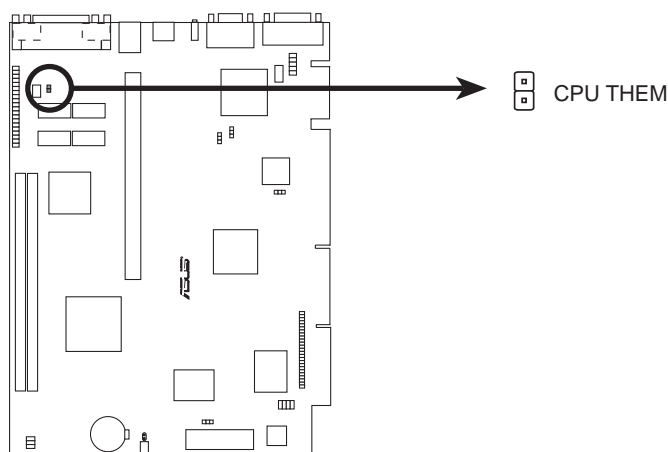

P2B-N CPU Thermal Sensor Connector

3.6.5 Recommended Heatsinks for Slot 1 Processors

The recommended heatsinks for the Slot 1 processors are those with three-pin fans, such as the ASUS Smart Fan, that can be connected to the motherboard's CPU fan connector. These heatsinks dissipate heat more efficiently and with an optional hardware monitor, they can monitor the fan's RPM and use the alert function with the Intel LANDesk Client Manager (LDCM) or the ASUS PC Probe software.



SECC Heatsink & Fan



SECC2 Heatsink & Fan

NOTE: The SEPP heatsink and fan (for Intel Celeron processors) is similar to the SECC2 heatsink and fan except that the clamping design is different.

3. HARDWARE SETUP

3.7 Expansion Cards

WARNING! Unplug your power supply when adding or removing expansion cards or other system components. Failure to do so may cause severe damage to both your motherboard and expansion cards.

3.7.1 Expansion Card Installation Procedure

1. Read the documentation for your expansion card and make any necessary hardware or software settings for your expansion card, such as jumpers.
2. Remove your computer system's cover and the bracket plate on the slot you intend to use. Keep the bracket for possible future use.
3. Carefully align the card's connectors and press firmly.
4. Secure the card on the slot with the screw you removed above.
5. Replace the computer system's cover.
6. Set up the BIOS if necessary
(such as *IRQ xx Used By ISA: Yes* in PNP AND PCI SETUP)
7. Install the necessary software drivers for your expansion card.

3.7.2 Assigning IRQs for Expansion Cards

Some expansion cards need to use an IRQ to operate. Generally, an IRQ must be exclusively assigned to one use. In a standard design, there are 16 IRQs available but most of them are already in use, leaving 6 IRQs free for expansion cards. If your motherboard has **PCI** audio onboard, an extra IRQ will be used, leaving 5 IRQs free. If your motherboard has **ISA** audio onboard, an extra 3 IRQs will be used, leaving 3 IRQs free.

Both ISA and PCI expansion cards may require the use IRQs. System IRQs are available to cards installed in the ISA expansion bus first, then any remaining IRQs are available to PCI cards. Currently, there are two types of ISA cards. The original ISA expansion card design, now referred to as legacy ISA cards, requires that you configure the card's jumpers manually and then install it in an available slot on the ISA bus. To see a map of your used and free IRQs in Windows 98, the **Control Panel** icon in **My Computer**, contains a **System** icon, which gives you a **Device Manager** tab. Double-clicking on a specific hardware device gives you the Resources tab which shows the Interrupt number and address. Make sure that no two devices use the same IRQ or your computer will experience problems when those two devices are in use at the same time.

3. HARDWARE SETUP

To simplify this process, this motherboard complies with the Plug and Play (PnP) specification, which was developed to allow automatic system configuration whenever a PnP-compliant card is added to the system. For PnP cards, IRQs are assigned automatically from those available.

If the system has both Legacy and PnP ISA cards installed, IRQs are assigned to PnP cards from those not used by Legacy cards. The PCI and PnP configuration of the BIOS setup utility can be used to indicate which IRQs are being used by Legacy cards. For older Legacy cards that do not work with the BIOS, you can contact your vendor for an ISA Configuration Utility.

An IRQ number is automatically assigned to PCI expansion cards after those used by Legacy and PnP ISA cards. In the PCI bus design, the BIOS automatically assigns an IRQ to PCI cards that require an IRQ. To install a PCI card, you need to set something called the INT (interrupt) assignment. Since all the PCI slots on this motherboard use an INTA #, be sure that the jumpers on your PCI cards are set to INT A.

3.7.3 Assigning DMA Channels for ISA Cards

Some ISA cards, both legacy and PnP, may also need to use a DMA (Direct Memory Access) channel. DMA assignments for this motherboard are handled the same way as the IRQ assignment process described earlier. You can select a DMA channel in the PCI and PnP configuration section of the BIOS Setup utility.

IMPORTANT: To avoid conflicts, reserve the necessary IRQs and DMAs for legacy ISA cards (see *4.7 PNP and PCI Setup*, choose *Yes* in **IRQ xx Used By ISA** and **DMA x Used By ISA** for those IRQs and DMAs you want to reserve).

3.7.4 ISA Cards and Hardware Monitor

The optional onboard hardware monitor uses the address 290H-297H, so legacy ISA cards must not use this address or else conflicts will occur.

3. HARDWARE SETUP

3.8 External Connectors

WARNING! Some pins are used for connectors or power sources. These are clearly separated from jumpers in *3.1 Motherboard Layout*. Placing jumper caps over these will cause damage to your motherboard.

IMPORTANT: Ribbon cables should always be connected with the red stripe to Pin 1 on the connectors. Pin 1 is usually on the side closest to the power connector on hard drives and CD-ROM drives, but may be on the opposite side on floppy disk drives. Check the connectors before installation because there may be exceptions. IDE ribbon cables must be less than 46 cm (18 in.), with the second drive connector no more than 15 cm (6 in.) from the first connector.

3.8.1 Back Panel Connectors

1) Parallel Connector (25-pin PRINTER)

You can enable the parallel port and choose the IRQ through **Onboard Parallel Port** in *4.5 Chipset Features Setup*. **NOTE:** Serial printers must be connected to the serial port.

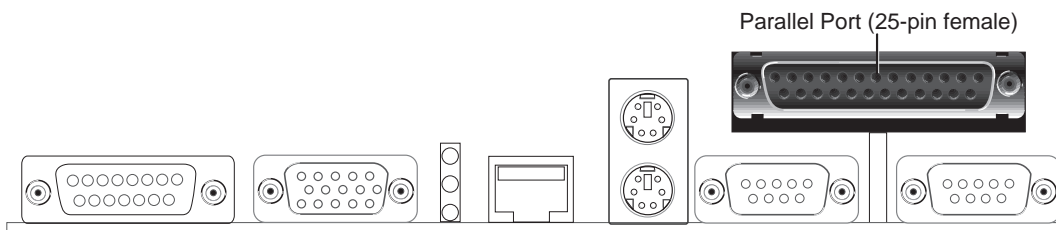

2) Serial Port Connectors (9-pin COM1 and COM2)

The two serial ports can be used for pointing devices or other serial devices. See **Onboard Serial Port** in *4.5 Chipset Features Setup*.

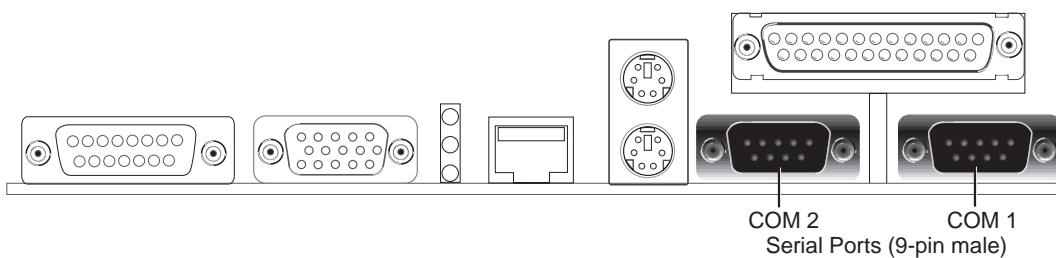

3. HARDWARE SETUP

3) PS/2 Mouse Connector (6-pin PS2KBMS)

The system will direct IRQ12 to the PS/2 mouse if one is detected. If not detected, expansion cards can use IRQ12. See **PS/2 Mouse Control** in *4.4 BIOS Features Setup*.

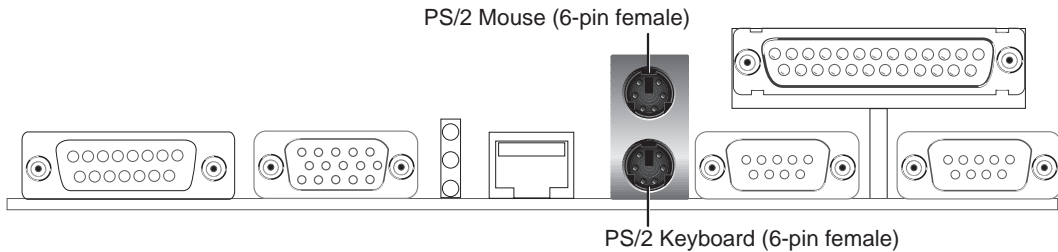

4) PS/2 Keyboard Connector (6-pin PS2KBMS)

This connector is for a standard keyboard using a PS/2 plug (mini DIN). **This connector will not allow standard AT size (large DIN) keyboard plugs. You may use a DIN to mini DIN adapter on standard AT keyboards.**

5) Fast-Ethernet Port Connector (RJ-45)

The RJ-45 connector is optional at the time of purchase. This connector allows the motherboard to connect to a Local Area Network (LAN) through a network hub.

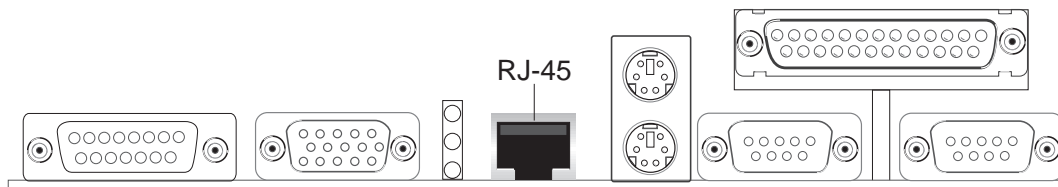

6) LAN Diagnostic LEDs (LAN_LED)

These diagnostic LEDs help indicate if there is a problem with the network connector, cable, or hub.

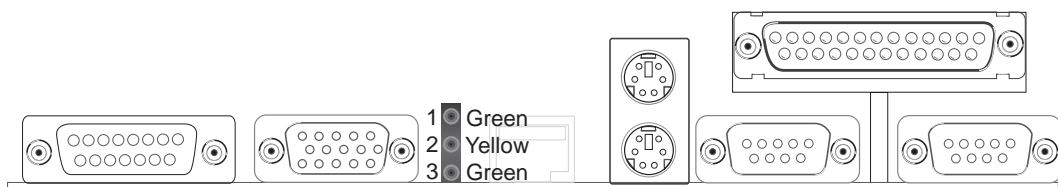

| | | LED on | LED off |
|---|----------|----------------|-----------------|
| 1 | Speed | 10Mbps | 100Mbps |
| 2 | Activity | No data | Data transfer |
| 3 | Link | Bad connection | Good connection |

3. HARDWARE SETUP

7) Monitor Connector (15-pin VGA)

This connector is for displaying on a standard VGA-compatible device.

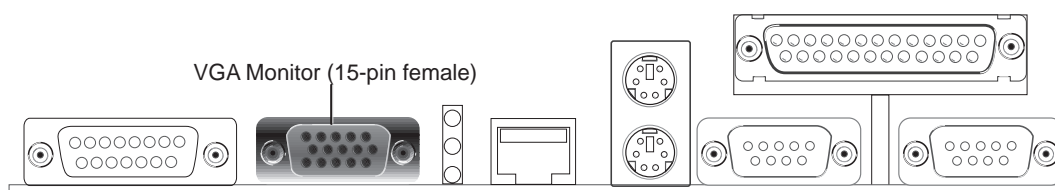

8) Joystick/MIDI Connector (15-pin GAME)

This connector is for a standard joystick or MIDI device.

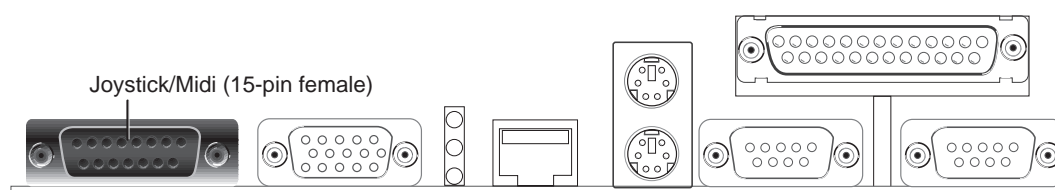

3.8.2 Midboard Connectors

1) CPU Fan Connector (3-pin CHASIS_FAN, 3-pin CPU_FAN)

These connectors support cooling fans of 500mA (6 Watts) or less. Orientate the fans so that the heat sink fins allow airflow to go across the onboard heat sink(s) instead of the expansion slots. Depending on the fan manufacturer, the wiring and plug may be different. The red wire should be positive, while the black should be ground. Connect the fan's plug to the board taking into consideration the polarity of the this connector. **NOTE: The "Rotation" signal is to be used only by a specially designed fan with rotation signal.**

WARNING! The CPU and/or motherboard will overheat if there is no airflow across the CPU and onboard heatsinks. Damage may occur to the motherboard and/or the CPU fan if these pins are incorrectly used. **These are not jumpers, do not place jumper caps over these pins.**

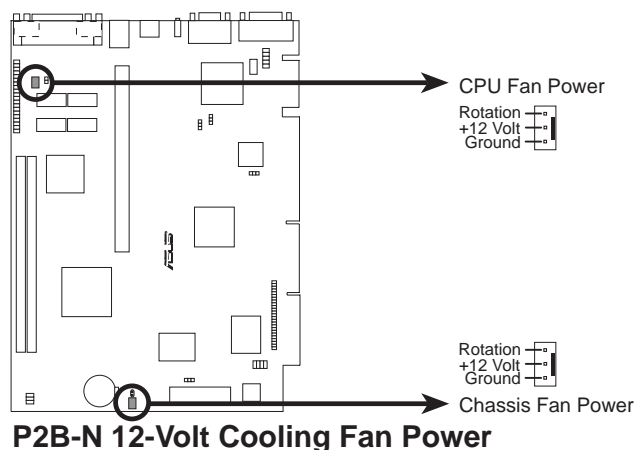

3. HARDWARE SETUP

2) CD-ROM Connector (50-3 pin CDROM)

This is a proprietary CD-ROM connector which requires a converter in order to attach to a slim CD-ROM.

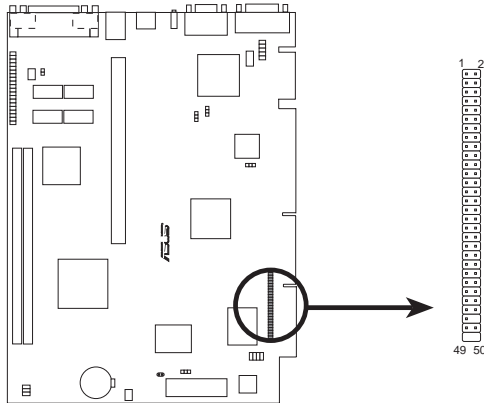

P2B-N CD-ROM Drive Connector

3) Voice Modem In Connector (4-pin MODEM)

This connector allows the onboard audio to interface with a voice modem card. It also allows the sharing of microphone and speaker between the onboard audio and the voice modem card. **NOTE:** Your voice modem card requires a similar connector to use this feature.

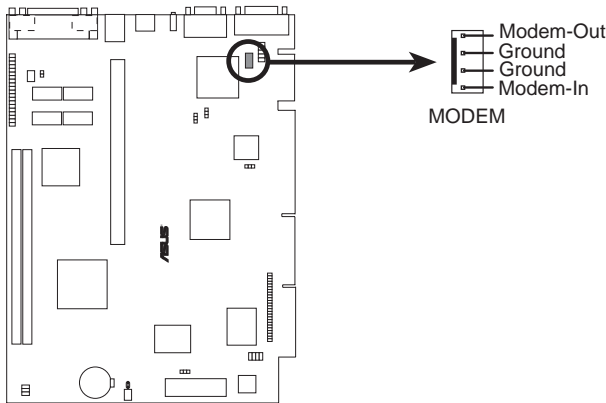

P2B-N Voice Modem In Connector

3. HARDWARE SETUP

4) ATI Multimedia Channel Connector (40-3 pin AMC)

This connector is used for ATI video accessories such as video capture cards or television tuners.

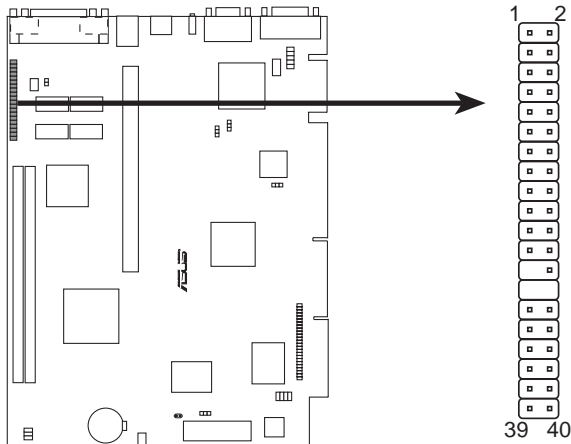

P2B-N ATI Multimedia Channel Connector

5) Audio Connectors (10-1 pin JACK_CON)

These connectors are provided for audio input and output signals.

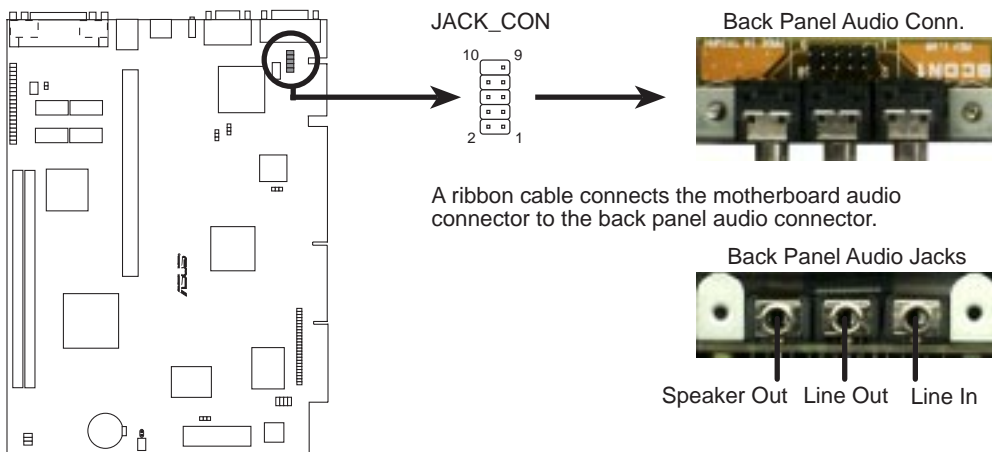

P2B-N Audio Jack Connector

3.8.3 Riser Card Connectors

1) Stereo Audio In Connector

This connector lets you receive stereo audio input from an internal CD-ROM drive or other sound sources, such as a TV tuner or MPEG card.

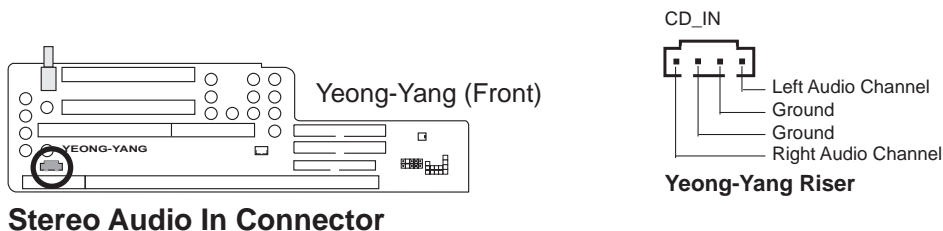

Stereo Audio In Connector

Yeong-Yang Riser

3. HARDWARE SETUP

2) LAN Activity Connectors (2-pin LAN_LED & 3-pin WOL_CON)

These connectors support Local Area Network (LAN) cards, such as the ASUS PCI-L101 (see **7.1 PCI-L101 Fast Ethernet Card**) with output signals for data transfer activity. The LAN_LED connector allows the front panel LED to flash during transfer activity between the network and the computer. The WOL_CON connector allows the system to power up when there is a wakeup package (signal) received from the network.

IMPORTANT: This feature requires that **Wake On LAN** is set to *Enabled* (see **4.6 Power Management Setup**) and that your system has an NLX power supply with at least 720mA +5V standby power.

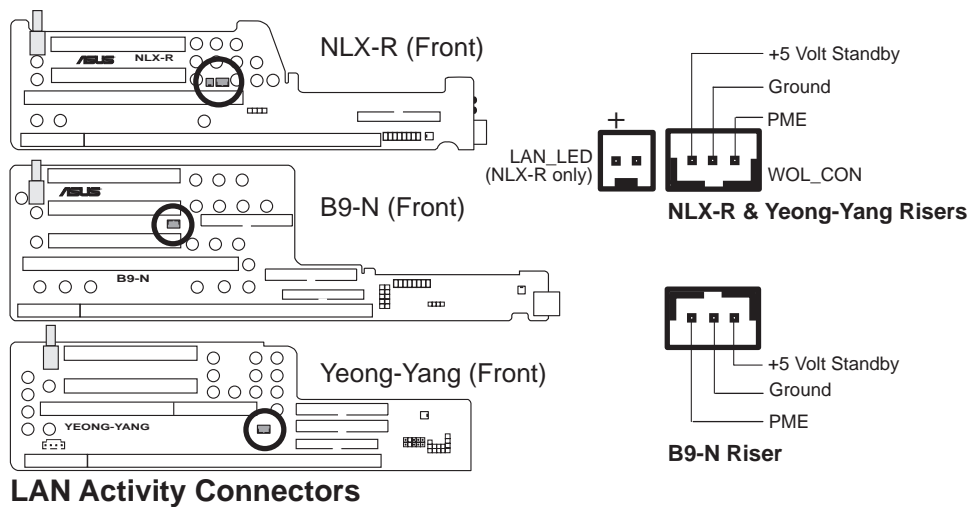

3) Front Panel Connector (16-1 pins)

This connector is used to connect the front panel display LEDs and buttons to the motherboard through a ribbon cable.

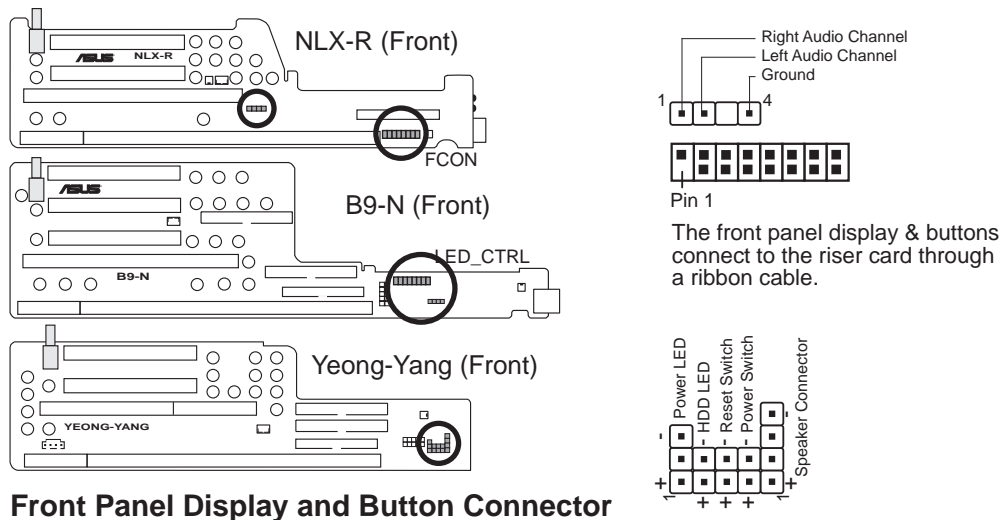

3. HW SETUP
Connectors

3. HARDWARE SETUP

4) Front Panel Microphone Connector (2-pin MIC-CON)

This connector is used to connect the front panel microphone jack to the motherboard through a ribbon cable.

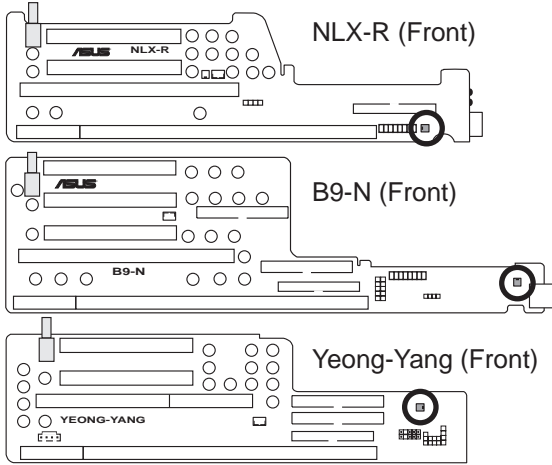

The front panel's 1/8" microphone jack connects to the riser card through a ribbon cable



Front Panel Microphone Jack

5) NLX Power Supply Connector (20-pin block)

This connector connects to an NLX power supply. The plug from the power supply will only insert in one orientation because of the different size holes. Find the proper orientation and push down firmly making sure that the pins are aligned.

IMPORTANT: Make sure that the NLX power supply can deliver at least 720mA on the 5volt standby lead (+5VSB). You may experience difficulty in powering ON your system without this specification.

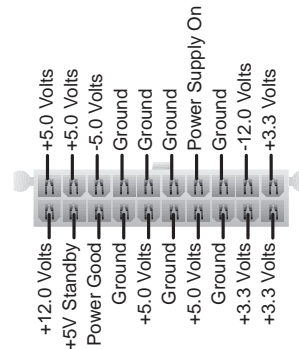
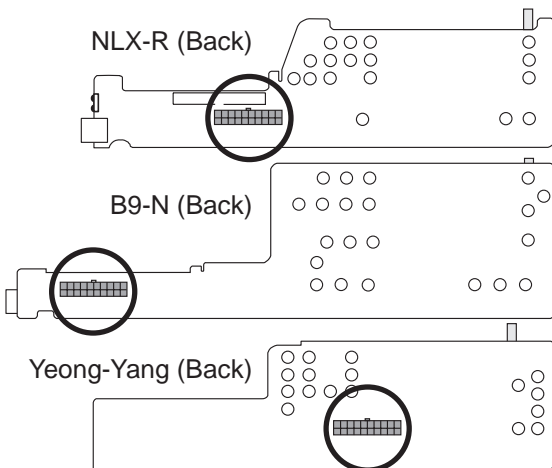

NLX Power Supply Connector

3. HARDWARE SETUP

6) IDE Connectors (40-1 pins)

This connector supports the provided IDE hard disk drive ribbon cable. After connecting one end to the riser card, connect the other end to a hard disk drive. The primary IDE channel supports both a master and a slave IDE device, but some system housings only permit a standard IDE hard drive to be installed.

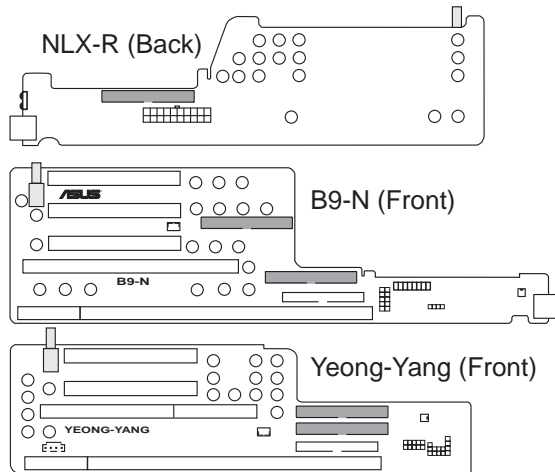

IDE Connectors



Pin 1

Orient the red stripe on the IDE ribbon cable to Pin 1

7) 3.5" Floppy Disk Drive Connector (34-1 pin FLOPPY)

This connector supports the provided floppy drive ribbon cable. After connecting the single end to the riser card, connect the other end to a 3.5" floppy disk drive. (Pin 5 is removed to prevent inserting in the wrong orientation when using ribbon cables with pin 5 plugged.)

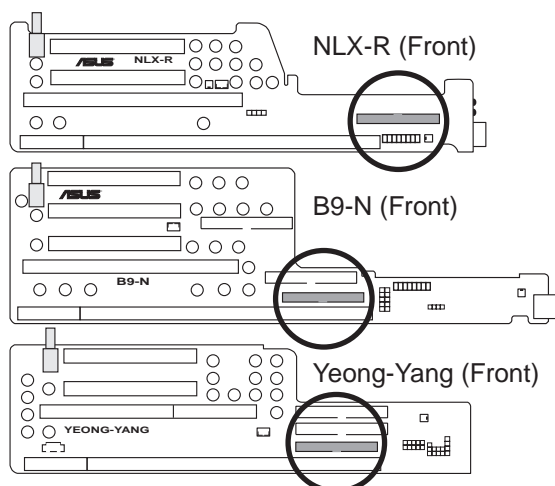

Floppy Disk Drive Connector

NLX-R Riser Pin 1



Orient the red stripe on the floppy ribbon cable to Pin 1

B9-N & Yeong-Yang Risers



Pin 1

3. HARDWARE SETUP

8) USB Ports (Two 4-pin Female Sockets) & Module Connector (5-1 pin USB)

If you have the NLX-R or B9-N risers, two Universal Serial Bus (USB) ports are available for connecting USB devices. If you have the Yeong-Yang riser, a 5-pin block is available for connecting an external connector set. This connector set can be mounted to an open slot on your computer's chassis. **USB IRQ** must be set to *Enabled* in **4.7 PNP and PCI Setup** to use USB features.

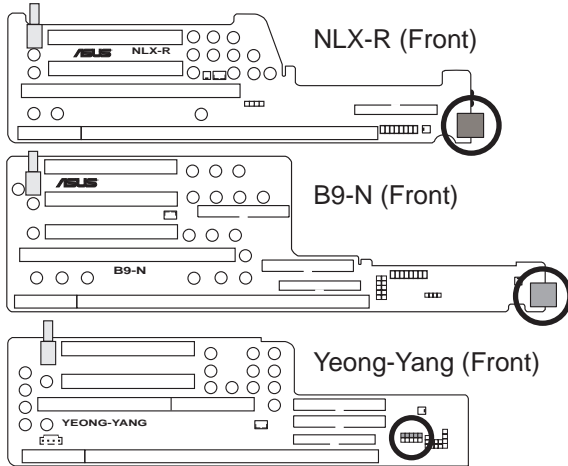

NLX-R & B9-N Risers

Port 1 Port 2



The USB ports show through the front panel

Yeong-Yang Riser

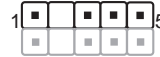

- 1: USB +5 Volt
- 2: (no connection)
- 3: USB Port 0+
- 4: USB Port 0-
- 5: GND

Universal Serial Bus (USB) Ports / USB Module Connector

9) IrDA-Compliant Infrared Module

The NLX-R riser includes an onboard infrared module for wireless transmitting and receiving of data through the front panel infrared lens. The B9-N and Yeong-Yang risers include an infrared module connector that supports an optional wireless transmitting and receiving infrared module. This module mounts to a small opening on system cases that support this feature. You must also configure the setting through **UART2 Use Infrared** (see **4.5 Chipset Features Setup**) to select whether UART2 is directed for use with COM2 or IrDA. Use the five pins as shown in Back View and connect a ribbon cable from the module to the motherboard's IR connector according to the pin definitions. An optional consumer infrared (CIR) set connects to the CIR and IR connectors simultaneously for both wireless transmitting and remote control functions through one external infrared module. **Power Up By Keyboard** in **4.6 Power Management Setup** must be *Enabled* to use Consumer Infrared (CIR) power up.

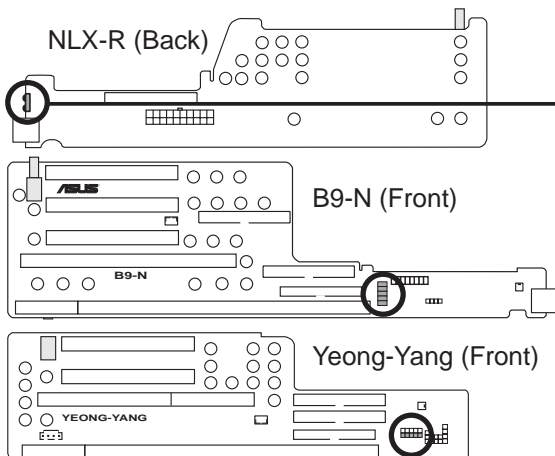

The module sends data through the front panel's infrared window

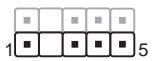
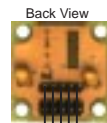
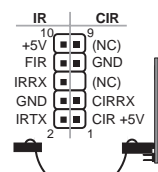

- 1: +5 Volt
- 2: (no connection)
- 3: IRRX
- 4: GND
- 5: IRTX

Infrared Module / Infrared Module Connector

3. HARDWARE SETUP

3.9 Power Connection Procedures

1. After all connections are made, close the system case cover.
 2. Be sure that all switches are off (in some systems, marked with ○).
 3. Connect the power supply cord into the power supply located on the back of your system case according to your system user's manual.
 4. Connect the power cord into a power outlet that is equipped with a surge protector.
 5. You may then turn on your devices in the following order:
 - a. Your monitor
 - b. External SCSI devices (starting with the last device on the chain)
 - c. Your system power. For ATX power supplies, you need to switch on the power supply as well as press the ATX power switch on the front of the case.
 6. The power LED on the front panel of the system case will light. For ATX power supplies, the system LED will light when the ATX power switch is pressed. The monitor LED may light up after the system's if it complies with "green" standards or if it has a power standby feature. The system will then run power-on tests. While the tests are running, additional messages will appear on the screen. If you do not see anything within 30 seconds from the time you turn on the power, the system may have failed a power-on test. Recheck your jumper settings and connections or call your retailer for assistance.
 7. During power-on, hold down <Delete> to enter BIOS setup. Follow the instructions in **4. BIOS Setup**
- * **Powering Off your computer:** You must first exit or shut down your operating system before switching off the power switch. For ATX power supplies, you can press the ATX power switch after exiting or shutting down your operating system. If you use Windows 95, click the **Start** button, click **Shut Down**, and then click **Shut down the computer?**. The power supply should turn off after Windows shuts down.

NOTE: The message "You can now safely turn off your computer" will not appear when shutting down with ATX power supplies.

4. BIOS SETUP

4.1 Managing and Updating Your BIOS

4.1.1 Upon First Use of the Computer System

It is recommended that you save a copy of the original motherboard BIOS along with a Flash Memory Writer utility (AFLASH.EXE) to a bootable floppy disk in case you need to reinstall the BIOS later. **AFLASH.EXE** is a Flash Memory Writer utility that updates the BIOS by uploading a new BIOS file to the programmable flash ROM on the motherboard. This file works only in DOS mode. To determine the BIOS version of your motherboard, check the last four numbers of the code displayed on the upper left-hand corner of your screen during bootup. Larger numbers represent a newer BIOS file.

1. Type **FORMAT A:/S** at the DOS prompt to create a bootable system floppy disk. **DO NOT** copy AUTOEXEC.BAT & CONFIG.SYS to the disk.
2. Type **COPY D:\AFLASH\AFLASH.EXE A:** (assuming D is your CD-ROM drive) to copy AFLASH.EXE to the just created boot disk.

NOTE: AFLASH works only in DOS mode. It will not work with DOS prompt in Windows and will not work with certain memory drivers that may be loaded when you boot from your hard drive. It is recommended that you reboot using a floppy.

3. Reboot your computer from the floppy disk. **NOTE:** BIOS setup must specify “Floppy” as the first item in the boot sequence.
4. In DOS mode, type **A:\AFLASH <Enter>** to run AFLASH.

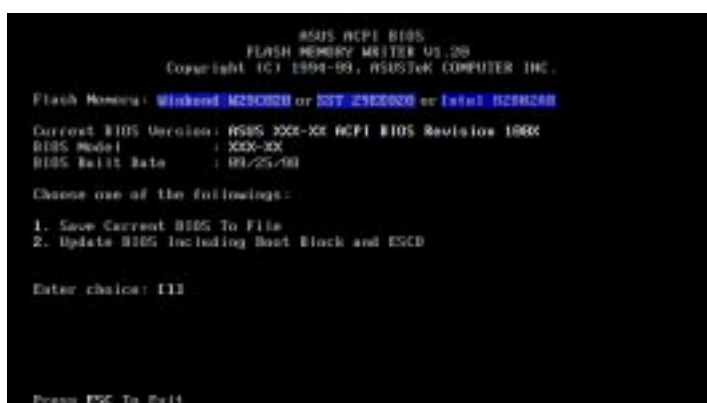

```
ASUS ACPI BIOS
FLASH MEMORY WRITER V1.20
Copyright (C) 1994-99, ASUSTek COMPUTER INC.

Flash Memory: Unknown M23C02B or SST 25E020B or Intel B27H24B

Current BIOS Version: ASUS XXXX-XX ACPI BIOS Revision 100X
BIOS Model          : XXX-XX
BIOS Build Date     : 09/25/98

Choose one of the followings:

1. Save Current BIOS To File
2. Update BIOS Including Boot Block and ESCD

Enter choice: 111

Press ESC To Exit
```

IMPORTANT: If “unknown” is displayed after **Flash Memory:**, the memory chip is either not programmable or is not supported by the ACPI BIOS and therefore, cannot be programmed by the Flash Memory Writer utility.

4. BIOS SETUP

5. Select **1. Save Current BIOS to File** from the Main menu and press <Enter>. The **Save Current BIOS To File** screen appears.

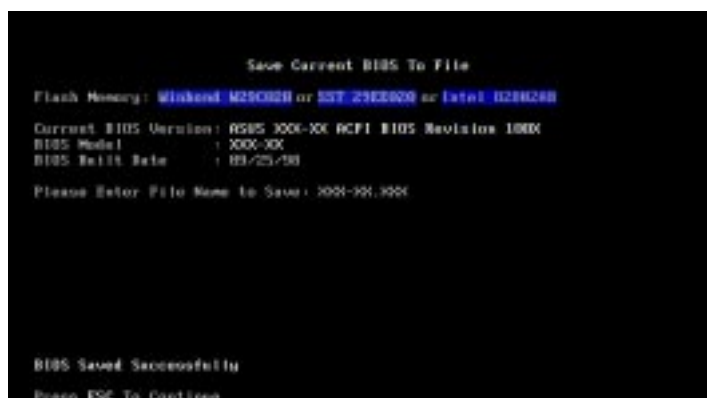

6. Type a filename and the path, for example, **A:\XXX-XX.XXX** and then press <Enter>.

4.1.2 Updating BIOS Procedures (only when necessary)

1. Download an updated ASUS BIOS file from the Internet (WWW or FTP) (see **ASUS CONTACT INFORMATION** on page 3 for details) and save to the disk you created earlier.
2. Boot from the disk you created earlier.
3. At the “A:” prompt, type **AFLASH** and then press <Enter>.
4. At the **Main Menu**, type **2** and then press <Enter>. The **Update BIOS Including Boot Block and ESCD** screen appears.
5. Type the filename of your new BIOS and the path, for example, **A:\XXX-XX.XXX**, and then press <Enter>.

NOTE: To cancel this operation, press <Enter>.



4. BIOS SETUP

6. When prompted to confirm the BIOS update, press **Y** to start the update.

```
Update BIOS including Boot Block and ESCD
Flash Memory: Winbond W25Q128 or SST 25Q032 or Intel 025A018
BIOS Version
CURRENT 3 8505 3000-00 ACPI BIOS Revision 1000
Flash.ami3 9505 3000-00 ACPI BIOS Revision 1000
BIOS Model
CURRENT 3 3000-00
Flash.ami3 3000-00
Date of BIOS Build
CURRENT 3 05/25/08
CHS664.H663 05/23/08
Notice: Boot Block is different. Check size of 1001.F10 is F200.
Are you sure (Y/N) ? [Y]
Press ESC to Return to Main Menu
```

7. The utility starts to program the new BIOS information into the flash ROM. The boot block will be updated automatically only when necessary. This will minimize the chance of a failed updating. When the programming is finished, *Flashed Successfully* will be displayed.

```
Update BIOS including Boot Block and ESCD
Flash Memory: Winbond W25Q128 or SST 25Q032 or Intel 025A018
BIOS Version
CURRENT 3 8505 3000-00 ACPI BIOS Revision 1000
Flash.ami3 9505 3000-00 ACPI BIOS Revision 1000
BIOS Model
CURRENT 3 3000-00
Flash.ami3 3000-00
Date of BIOS Build
CURRENT 3 05/25/08
CHS664.H663 05/23/08
Notice: Boot Block is different. Check size of 1001.F10 is F200.
Are you sure (Y/N) ? [Y]
Block Erasing --- Done
Programming --- 3FFF
Flashed Successfully
Press ESC to Continue
```

8. Follow the onscreen instructions to continue.

```
8505 ACPI BIOS
FLASH MEMORY WRITER V01.20
Copyright (C) 1996-09, AMISTAR COMPUTER INC.
Flash Memory: Winbond W25Q128 or SST 25Q032 or Intel 025A018
Current BIOS Version: 8505 3000-00 ACPI BIOS Revision 1000
BIOS Model: 3000-00
BIOS Build Date: 05/25/08
Choose one of the following:
1. Save Current BIOS To File
2. Update BIOS including Boot Block and ESCD
Enter choice: 11
You have flashed the EPROM. It is recommended that you turn off
the power, enter SETUP and LOAD Setup Defaults to have CMOS
updated with new BIOS when exits.
Press ESC To Exit
```

WARNING! If you encounter problems while updating the new BIOS, DO NOT turn off your system since this might prevent your system from booting up. Just repeat the process, and if the problem still persists, update the original BIOS file you saved to disk above. If the Flash Memory Writer utility was not able to successfully update a complete BIOS file, your system may not be able to boot up. If this happens, your system will need servicing.

4. BIOS SETUP

4.2 BIOS Setup

The motherboard supports two programmable Flash ROM chips: 5-Volt and 12-Volt. Either of these memory chips can be updated when BIOS upgrades are released. Use the Flash Memory Writer utility to download the new BIOS file into the ROM chip as described in detail in this section.

All computer motherboards provide a Setup utility program for specifying the system configuration and settings. If your motherboard came in a computer system, the proper configuration entries may have already been made. If so, invoke the Setup utility, as described later, and take note of the configuration settings for future reference; in particular, the hard disk specifications.

If you are installing the motherboard, reconfiguring your system or you receive a Run Setup message, you will need to enter new setup information. This section describes how to configure your system using this utility.

The BIOS ROM of the system stores the Setup utility. When you turn on the computer, the system provides you with the opportunity to run this program. This appears during the Power-On Self Test (POST). Press <Delete> to call up the Setup utility. If you are a little bit late pressing the mentioned key(s), POST will continue with its test routines, thus preventing you from calling up Setup. If you still need to call Setup, reset the system by pressing <Ctrl> + <Alt> + <Delete>, or by pressing the Reset button on the system case. You can also restart by turning the system off and then back on again. But do so only if the first two methods fail.

When you invoke Setup, the CMOS SETUP UTILITY main program screen will appear with the following options:



4. BIOS SETUP

Load Defaults

The “Load BIOS Defaults” option loads the minimum settings for troubleshooting. “Load Setup Defaults”, on the other hand, is for loading optimized defaults for regular use. Choosing defaults at this level, will modify all applicable settings.

A section at the bottom of the above screen displays the control keys for this screen. Take note of these keys and their respective uses. Another section just below the control keys section displays information on the currently highlighted item in the list.

4.3 Standard CMOS Setup

The “Standard CMOS Setup” option allows you to record some basic system hardware configuration and set the system clock and error handling. If the motherboard is already installed in a working system, you will not need to select this option anymore. However, if the configuration stored in the CMOS memory on the board gets lost or damaged, or if you change your system hardware configuration, you will need to respecify the configuration values. The configuration values usually get lost or corrupted when the power of the onboard CMOS battery weakens.



The preceding screen provides you with a list of options. At the bottom of this screen are the control keys for this screen. Take note of these keys and their respective uses.

User-configurable fields appear in a different color. If you need information on the selected field, press <F1>. The help menu will then appear to provide you with the information you need. The memory display at the lower right-hand side of the screen is read-only and automatically adjusts accordingly.

Details of Standard CMOS Setup:

Date

To set the date, highlight the “Date” field and then press either <Page Up>/<Page Down> or <+>/<-> to set the current date. Follow the month, day and year format. Valid values for month, day and year are: **Month: (1 to 12), Day: (1 to 31), Year: (up to 2079)**

4. BIOS SETUP

Time

To set the time, highlight the “Time” field and then press either <Page Up>/<Page Down> or <+>/<-> to set the current time. Follow the hour, minute and second format. Valid values for hour, minute and second are: (**Hour: (00 to 23)**, **Minute: (00 to 59)**, **Second: (00 to 59)**).

NOTE: You can bypass the date and time prompts by creating an AUTOEXEC.BAT file. For information on how to create this file, please refer to the MS-DOS manual.

Hard Disks

This field records the specifications for all non-SCSI hard disk drives installed in your system. The onboard PCI IDE connectors provide Primary and Secondary channels for connecting up to four IDE hard disks or other IDE devices. Each channel can support up to two hard disks; the first of which is the “master” and the second is the “slave”.

Specifications for SCSI hard disks need not to be entered here since they operate using device drivers and are not supported by the BIOS. If you install other SCSI controller cards, refer to their respective documentations on how to install the required SCSI drivers.

For IDE hard disk drive setup, you can:

- Use the *Auto* setting for detection during bootup.
- Use the IDE HDD AUTO DETECTION in the main menu to automatically enter the drive specifications.
- Enter the specifications yourself manually by using the “User” option.

The entries for specifying the hard disk type include **CYLS** (number of cylinders), **HEAD** (number of read/write heads), **PRECOMP** (write precompensation), **LANDZ** (landing zone), **SECTOR** (number of sectors) and **MODE**. The **SIZE** field automatically adjusts according to the configuration you specify. The documentation that comes with your hard disk should provide you with the information regarding the drive specifications.

The **MODE** entry is for IDE hard disks only, and can be ignored for MFM and ESDI drives. This entry provides three options: *Normal*, *Large*, *LBA*, or *Auto* (see below). Set **MODE** to the *Normal* for IDE hard disk drives smaller than 528MB; set it to *LBA* for drives over 528MB that support Logical Block Addressing (LBA) to allow larger IDE hard disks; set it to *Large* for drives over 528MB that do not support LBA. *Large* type of drive can only be used with MS-DOS and is very uncommon. Most IDE drives over 528MB support the *LBA* mode.

4. BIOS SETUP

Auto detection of hard disks on bootup

For each field: Primary Master, Primary Slave, Secondary Master, and Secondary Slave, you can select *Auto* under the TYPE and MODE fields. This will enable auto detection of your IDE hard disk during bootup. This will allow you to change your hard disks (with the power off) and then power on without having to reconfigure your hard disk type. If you use older hard disks that do not support this feature, then you must configure the hard disk in the standard method as described earlier by the “User” option.

NOTE: After the IDE hard disk drive information has been entered into BIOS, new IDE hard disk drives must be partitioned (such as with FDISK) and then formatted before data can be read from and write on. Primary IDE hard disk drives must have its partition set to *active* (also possible with FDISK).

NOTE: SETUP Defaults are noted in parenthesis next to each function heading.

Drive A / Drive B (None)

These fields record the types of floppy disk drives installed in your system. The available options for drives A and B are: *360K, 5.25 in.; 1.2M, 5.25 in.; 720K, 3.5 in.; 1.44M, 3.5 in.; 2.88M, 3.5 in.; None*

To enter the configuration value for a particular drive, highlight its corresponding field and then select the drive type using the <page up>/<page down> or <+>/<-> keys.

Floppy 3 Mode Support (Disabled)

This is the Japanese standard floppy drive. The standard stores 1.2MB in a 3.5inch diskette. This is normally disabled but you may choose from either: *Drive A, Drive B, Both, and Disabled*

Video (EGA/VGA)

Set this field to the type of video display card installed in your system. The options are *EGA/VGA, CGA 40, CGA 80, and MONO* (for Hercules or MDA).

If you are using a VGA or any higher resolution card, choose *EGA/VGA*.

Halt On (All Errors)

This field determines which types of errors will cause the system to halt. Choose from *All Errors; No Errors; All,But Keyboard, All,But Diskette; and All,But Disk/Key*.

4. BIOS SETUP

4.4 BIOS Features Setup

The “BIOS Features Setup” option consists of configuration entries that allow you to improve your system performance, or let you set up some system features according to your preference. Some entries are required by the motherboard’s design to remain in their default settings.



A section at the lower right of the screen displays the control keys you can use. Take note of these keys and their respective uses. If you need information on a particular entry, highlight it and then press <F1>. A pop-up help menu will appear to provide you with the information you need. <F5> loads the last set values, <F6> and <F7> loads the BIOS default values and Setup default values, respectively.

NOTE: SETUP Defaults are noted in parenthesis next to each function heading.

Details of BIOS Features Setup

CPU Internal Core Speed

This function is reserved for future use and is currently disabled.

Boot Virus Detection (Enabled)

This field allows you to set boot virus detection, ensuring a virus-free boot sector. This new antivirus solution is unlike native BIOS tools, which offer limited virus protection typically by write-protecting the partition table. With this new solution, your computer is protected against boot virus threats earlier in the boot cycle, that is, before they have a chance to load into your system. This ensures your computer boots to a clean operating system. The system halts and displays a warning message when it detects a virus. If this occurs, you can either allow the operation to continue or use a virus-free bootable floppy disk to restart and investigate your system. Because of conflicts with new operating systems, for example, during installation of new software, you may have to set this to *Disabled* to prevent write errors.

4. BIOS SETUP

Processor Serial Number (Disabled)

The Processor Serial Number is a unique electronic number that is added to every Pentium III processor to help verify the identity of the user across the Internet. Set this field to *Enabled* when you need increased security for doing business online or e-commerce. Otherwise, set it to *Disabled* for greater anonymity when surfing the Internet. If you are not using a Pentium III processor on the motherboard, you may not make changes to this field.

CPU Level 1 Cache / CPU Level 2 Cache (Enabled)

These fields allow you to choose from the default of *Enabled* or choose *Disabled* to turn on or off the CPU's Level 1 and Level 2 built-in cache.

CPU Level 2 Cache ECC Check (Disabled)

This function controls the ECC check capability in the CPU level 2 cache.

BIOS Update (Enabled)

This functions as an update loader integrated into the BIOS to supply the processor with the required data. The BIOS will load the update on all processors during system bootup in the default position of *Enabled*.

Turbo Mode (Disabled)

Leave on default setting.

Quick Power On Self Test (Enabled)

This field speeds up the Power-On Self Test (POST) routine by skipping retesting a second, third, and fourth time. Setup default setting for this field is *Enabled*. A complete test of the system is done on each test.

HDD Sequence SCSI/IDE First (IDE)

When using both SCSI and IDE hard disk drives, IDE is always the boot disk using drive letter C (default setting of *IDE*). This new feature allows a SCSI hard disk drive to be the boot disk when set to *SCSI*. This allows multiple operating systems to be used on both IDE and SCSI drives or the primary operating system to boot using a SCSI hard disk drive.

Boot Sequence (A,C)

This field determines where the system looks first for an operating system. Options are *A,C*; *C,A*; *A,CDROM,C*; *CDROM,C,A*; *D,A*; *E,A*; *F,A*; *C only*; *LS/ZIP, C*; *LAN,A,C*; and *LAN,C,A*. The setup default setting, *A, C*, is to check first the floppy disk and then the hard disk drive.

Boot Up Floppy Seek (Disabled)

When enabled, the BIOS will seek drive A once.

Floppy Disk Access Control (R/W)

This allows protection of files from the computer system to be copied to floppy disks by allowing the setting of *Read Only* to only allow reads from the floppy disk drive but not writes. The setup default *R/W* allows both reads and writes.

IDE HDD Block Mode Sectors (HDD MAX)

This field enhances hard disk performance by making multi-sector transfers instead of one sector per transfer. Most IDE drives, except older versions, can utilize this feature. Selections are *HDD MAX*, *Disabled*, *2*, *4*, *8*, *16*, and *32*.

4. BIOS SETUP

HDD S.M.A.R.T. capability (Disabled)

This allows the enabling or disabling of the S.M.A.R.T. (Self-Monitoring, Analysis and Reporting Technology) system which utilizes internal hard disk drive monitoring technology. This feature is normally disabled because system resources used in this feature may decrease system performance.

PS/2 Mouse Function Control (Auto)

The default of *Auto* allows the system to detect a PS/2 mouse on bootup. If detected, IRQ12 will be used for the PS/2 mouse. IRQ12 will be reserved for expansion cards if a PS/2 mouse is not detected. *Enabled* will always reserve IRQ12, whether on bootup a PS/2 mouse is detected or not.

OS/2 Onboard Memory > 64M (Disabled)

When using OS/2 operating systems with installed DRAM of greater than 64MB, you need to set this option to *Enabled* otherwise leave this on *Disabled*.

.....

PCI/VGA Palette Snoop (Disabled)

Some display cards that are nonstandard VGA such as graphics accelerators or MPEG Video Cards may not show colors properly. The setting *Enabled* should correct this problem. Otherwise leave this on the setup default setting of *Disabled*.

Video ROM BIOS Shadow (Enabled)

This field allows you to change the video BIOS location from ROM to RAM. Relocating to RAM enhances system performance, as information access is faster than the ROM.

C8000-CBFFF to DC000-DFFFF (Disabled)

These fields are used for shadowing other expansion card ROMs. If you install other expansion cards with ROMs on them, you will need to know which addresses the ROMs use to shadow them specifically. Shadowing a ROM reduces the memory available between 640K and 1024K by the amount used for this purpose.

Boot Up NumLock Status (On)

This field enables users to activate the Number Lock function upon system boot.

Typematic Rate Setting (Disabled)

When enabled, you can set the two typematic controls listed next. Setup default setting is *Disabled*.

Typematic Rate (Chars/Sec) (6)

This field controls the speed at which the system registers repeated keystrokes. Options range from 6 to 30 characters per second. Setup default setting is **6**; other settings are 8, 10, 12, 15, 20, 24, and 30.

Typematic Delay (Msec) (250)

This field sets the time interval for displaying the first and second characters. Four delay rate options are available: 250, 500, 750, and 1000.

Security Option (System)

When you specify a *Supervisor Password* and/or *User Password* (explained later in this section), the Security Option field determines when the system prompts for the password. The default setting is *System*, where the system prompts for the User Password every time you start your system. The other option is *Setup*, where the system goes through its startup routine unless the Setup utility is called, when the system prompts for the Supervisor Password.

4. BIOS SETUP

4.5 Chipset Features Setup

The “Chipset Features Setup” option controls the configuration of the board’s chipset.



NOTE: SETUP Defaults are noted in parenthesis next to each function heading.

Details of Chipset Features Setup

SDRAM Configuration (By SPD)

This sets the optimal timings of settings for items 2–5, depending on the memory modules that you are using. Default setting is *By SPD*, which configures items 2–5 by reading the contents in the SPD (Serial Presence Detect) device. This 8-pin serial EEPROM device stores critical parameter information about the module, such as memory type, size, speed, voltage interface, and module banks.

SDRAM CAS Latency

This controls the latency between SDRAM read command and the time that the data actually becomes available. Leave on default setting.

SDRAM RAS to CAS Delay

This controls the latency between SDRAM active command and the read/write command. Leave on default setting.

SDRAM RAS Precharge Time

This controls the idle clocks after issuing a precharge command to SDRAM. Leave on default setting.

DRAM Idle Timer

This controls the idle clocks before closing an opened SDRAM page. Leave on default setting.

SDRAM MA Wait State (Normal)

This controls the leadoff clocks for CPU read cycles. Leave on default setting.

Snoop Ahead (Enabled)

Enabled will allow PCI streaming. Leave on default setting.

Host Bus Fast Data Ready (Disabled)

Leave on default setting.

4. BIOS SETUP

16-bit I/O Recovery Time (1 BUSCLK) / 8-bit I/O Recovery Time (1 BUSCLK)
Timing for 16-bit and 8-bit ISA cards, respectively. Leave on default setting.

Graphics Aperture Size (64MB)

Memory-mapped, graphics data structures can reside in a Graphics Aperture. Leave on default setting.

Video Memory Cache Mode (UC)

USWC (uncacheable, speculative write combining) is a new cache technology for the video memory of the processor. It can greatly improve the display speed by caching the display data. You must leave this on the default setting of *UC* (uncacheable) if your display card cannot support this feature, otherwise your system may not boot.

PCI 2.1 Support (Enabled)

This function allows you to enable or disable PCI 2.1 features including passive release and delayed transaction. Leave *Enabled* (default setting) for PCI 2.1 compliancy.

Memory Hole At 15M–16M (Disabled)

Enabling this feature reserves 15MB to 16MB memory address space to ISA expansion cards that specifically require this setting. This makes the memory from 15MB and up unavailable to the system. Expansion cards can only access memory up to 16MB. The default is *Disabled*.

DRAM are xx bits wide

If all your DIMMs have ECC (e.g., 8 chips + 1 ECC chip), they are considered 72bits and the following will be displayed:

```
DRAM are 72 bits wide      ESC : Quit          F10+ : Select Item
Data Integrity Mode : ECC  F1  : Help          F10/P10+/- : Modify
                          F5  : Old Values (Shift+F2) : Color
                          F6  : Load BIOS Defaults
                          F7  : Load Setup Defaults
```

If your DIMMs do not have ECC (e.g., 8 chips), they are considered 64 bits and the following will be displayed instead:

```
DRAM are 64 (Not 72) bits wide  ESC : Quit          F10+ : Select Item
Data Integrity Mode : Non-ECC   F1  : Help          F10/P10+/- : Modify
                          F5  : Old Values (Shift+F2) : Color
                          F6  : Load BIOS Defaults
                          F7  : Load Setup Defaults
```

Data Integrity Mode (Non-ECC)

Non-ECC has byte-wise write capability but no provision for protecting data integrity in the memory module array. *EC-Only* data errors are detected but not corrected. *ECC* with hardware scrubbing allows a detection of single-bit and multiple-bit errors and recovery of single-bit errors. (See **2. System Memory**, section III for more information on memory modules.)

Onboard FDC Controller (Enabled)

When *Enabled*, this field allows you to connect your floppy disk drives to the onboard floppy disk drive connector instead of a separate controller card. If you want to use a different controller card to connect the floppy disk drives, set this field to *Disabled*.

4. BIOS SETUP

Onboard FDC Swap A & B (No Swap)

This field allows you to reverse the hardware drive letter assignments of your floppy disk drives. Two options are available: *No Swap* and *Swap AB*. If you want to switch drive letter assignments through the onboard chipset, set this field to *Swap AB*.

Onboard Serial Port 1 (3F8H/IRQ4)

Settings are *3F8H/IRQ4*, *2F8H/IRQ3*, *3E8H/IRQ4*, *2E8H/IRQ10*, and *Disabled* for the onboard serial connector.

Onboard Serial Port 2 (2F8H/IRQ3)

Settings are *3F8H/IRQ4*, *2F8H/IRQ3*, *3E8H/IRQ4*, *2E8H/IRQ10*, and *Disabled* for the onboard serial connector.

Onboard Parallel Port (378H/IRQ7)

This field sets the address of the onboard parallel port connector. You can select either: *3BCH/IRQ 7*, *378H/IRQ 7*, *278H/IRQ 5*, *Disabled*. If you install an I/O card with a parallel port, ensure that there is no conflict in the address assignments. The PC can support up to three parallel ports as long as there are no conflicts for each port.

Parallel Port Mode (ECP+EPP)

This field allows you to set the operation mode of the parallel port. The setting *Normal*, allows normal-speed operation but in one direction only; *EPP* allows bidirectional parallel port operation at maximum speed; *ECP* allows the parallel port to operate in bidirectional mode and at a speed faster than the maximum unidirectional data transfer rate; *ECP+EPP* allows normal speed operation in a two-way mode.

ECP DMA Select (3)

This selection is available only if you select *ECP* or *ECP+EPP* in the **Parallel Port Mode**. Select either DMA Channel *1*, *3*, or *Disable*.

UART2 Use Infrared (Disabled)

When enabled, this field activates the onboard infrared feature and sets the second serial UART to support the infrared module connector on the motherboard. If your system already has a second serial port connected to the onboard COM2 connector, it will no longer work if you enable the infrared feature. By default, this field is set to *Disabled*, which leaves the second serial port UART to support the COM2 serial port connector. See **IrDA-compliant infrared module connector** under section III.

Onboard PCI IDE Enable (Both)

You can select to enable the *primary* IDE channel, *secondary* IDE channel, *both*, or *disable* both channels (for systems with only SCSI drives).

IDE Ultra DMA Mode (Auto)

This field autodetects Ultra DMA capability (for improved transfer speeds and data integrity) for compatible IDE devices. Set to *Disable* to suppress Ultra DMA capability.

IDE 0 Master/Slave PIO/DMA Mode, IDE 1 Master/Slave PIO/DMA Mode (Auto)

Each channel (0 and 1) has both a master and a slave making four IDE devices possible. Because each IDE device may have a different Mode timing (*0*, *1*, *2*, *3*, *4*), it is necessary for these to be independent. The default setting of *Auto* will allow autodetection to ensure optimal performance

4. BIOS SETUP

Video Off Method (DPMS OFF)

This field defines the video off features. The following options are available: *DPMS OFF*, *DPMS Reduce ON*, *Blank Screen*, *V/H SYNC+Blank*, *DPMS Standby*, and *DPMS Suspend*. The DPMS (Display Power Management System) features allow the BIOS to control the video display card if it supports the DPMS feature. *Blank Screen* only blanks the screen (use this for monitors without power management or “green” features. If set up in your system, your screen saver will not display with *Blank Screen* selected). *V/H SYNC+Blank* blanks the screen and turns off vertical and horizontal scanning.

.....

PM Timers

This section controls the time-out settings for the Power Management scheme. The fields included in this section are “HDD Power Down”, which places the hard disk into its lowest power consumption mode, and the “Suspend Mode” which suspends the CPU.

The system automatically “wakes up” from any power saving mode when there is system activity such as when a key is pressed from the keyboard, or when there is activity detected from the enabled IRQ channels.

HDD Power Down (Disable)

Shuts down any IDE hard disk drives in the system after a period of inactivity. This time period is user-configurable to *1–15 Min* or *Disable*. This feature does not affect SCSI hard drives.

Suspend Mode (Disable)

Sets the period of time after which each of these modes activate: *30 sec*, *1 Min*, *2 Min*, *4 Min*, *8 Min*, *20 Min*, *30 Min*, *40 Min*, *1 Hour*, and *Disable*.

.....

Power Up Control

This section determines the ways the system can be controlled when it is started or restarted, when modem activity is detected, or when power to the computer is interrupted and reapplied. The Soft-Off mode refers to powering off the system through a momentary button switch (ATX switch) or through the software as opposed to disconnecting the AC power by way of a rocker switch or other means.

PWR Button < 4 Secs (Soft Off)

When set to *Soft Off*, the ATX switch can be used as a normal system power-off button when pressed for less than 4 seconds. *Suspend* allows the button to have a dual function where pressing less than 4 seconds will place the system in sleep mode. Regardless of the setting, holding the ATX switch for more than 4 seconds will power off the system.

4. BIOS SETUP

PWR Up On Modem Act (Enabled)

This allows either settings of *Enabled* or *Disabled* for powering up the computer (turns the ATX power supply on) when the modem receives a call while the computer is Soft-off. **NOTE:** The computer cannot receive or transmit data until the computer and applications are fully running, thus connection cannot be made on the first try. Turning an external modem off and then back on while the computer is off causes an initialization string that will also cause the system to power on.

AC PWR Loss Restart (Disabled)

This allows you to set whether you want your system to boot up after the power has been interrupted. *Disabled* leaves your system off after reapplying power and *Enabled* boots up your system after reapplying power.

Power Up By Keyboard (Disabled)

Set this field to *Enabled* if you wish to use your PS2 keyboard (by pressing the spacebar) to power up your computer. This feature requires an ATX power supply that can supply at least 300mA on the +5VSB lead. The default is set to [Disabled] because not all computers have the appropriate ATX power supply. Your computer will not power ON if you set this to [Enabled] and do not have the appropriate ATX power supply.

Wake On LAN (Disabled)

This allows you to remotely power up your system through your network by sending a wake-up frame or signal. With this feature, you can remotely upload/download data to/from systems during off-peak hours. *Enabled* sets this feature.

IMPORTANT: This feature requires the optional network interface (see **VII. Network Interface**) and an ATX power supply with at least 720mA +5V standby power.

Automatic Power Up (Disabled)

This allows you to have an unattended or automatic power up of your system. You may configure your system to power up at a certain time of the day by selecting *Everyday*, which will allow you to set the time or at a certain time and day by selecting *By Date*.

.....

Fan Monitor (xxxxRPM)

The onboard hardware monitor is able to detect the Chassis Fan Speed, CPU Fan Speed, and the Power Supply Fan Speed in Rotations Per Minute (RPM). Set to *Ignore* if one of these are not used so that error messages will not be given.

.....

Thermal Monitor (xxxC/xxxF)

The onboard hardware monitor is able to detect the CPU and MB (motherboard) temperatures. Set to *Ignore* only if necessary.

.....

Voltage Monitor (xx.xV)

The onboard hardware monitor is able to detect the voltages put out by the voltage regulators. Set to *Ignore* only if necessary.

NOTE: If any of the monitored items are out of range, an error message will appear: "Hardware Monitor found an error, enter POWER MANAGEMENT SETUP for details". You will then be prompted to "Press **F1** to continue, **DEL** to enter SETUP".

4. BIOS SETUP

4.7 PNP and PCI Setup

The “PNP and PCI Setup” option configures the PCI bus slots. All PCI bus slots on the system use INTA#, thus all installed PCI cards must be set to this value.

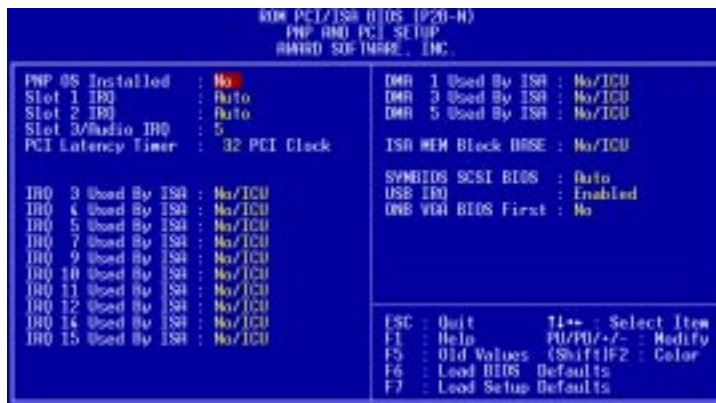

NOTE: SETUP Defaults are noted in parenthesis next to each function heading.

Details of PNP and PCI Setup

PNP OS Installed (No)

This field allows you to use a Plug-and-Play (PnP) operating system to configure the PCI bus slots instead of using the BIOS. Thus interrupts may be reassigned by the OS when *Yes* is selected. When a non-PnP OS is installed or to prevent reassigning of interrupt settings, select the default setting of *No*.

Slot 1 IRQ / Slot 2 IRQ (Auto)

These fields set how IRQ use is determined for each PCI slot. The default setting for each field is *Auto*, which uses auto-routing to determine IRQ use. The other options are manual settings of *NA*, *3*, *4*, *5*, *7*, *9*, *10*, *11*, *12*, *14* or *15* for each slot.

PCI Latency Timer (32 PCI Clock)

The default setting of *32 PCI Clock* enables maximum PCI performance for this motherboard.

IRQ xx Used By ISA (No/ICU)

These fields indicate whether or not the displayed IRQ for each field is being used by a legacy (non-PnP) ISA card. Two options are available: *No/ICU* and *Yes*. The first option, the default value, indicates either that the displayed IRQ is not used or an ISA Configuration Utility (ICU) is being used to determine if an ISA card is using that IRQ. If you install a legacy ISA card that requires a unique IRQ, and you are not using an ICU, you must set the field for that IRQ to *Yes*. For example: If you install a legacy ISA card that requires IRQ 10, then set **IRQ10 Used By ISA** to *Yes*.

.....

4. BIOS SETUP

DMA x Used By ISA (No/ICU)

These fields indicate whether or not the displayed DMA channel for each field is being used by a legacy (non-PnP) ISA card. Available options include: *No/ICU* and *Yes*. The first option, the default setting, indicates either that the displayed DMA channel is not used or an ICU is being used to determine if an ISA card is using that channel. If you install a legacy ISA card that requires a unique DMA channel, and you are not using an ICU, you must set the field for that channel to *Yes*.

ISA MEM Block BASE (No/ICU)

This field allows you to set the base address and block size of a legacy ISA card that uses any memory segment within the C800H and DFFFH address range. If you have such a card, and you are not using an ICU to specify its address range, select a base address from the six available options; the **ISA MEM Block SIZE** field will then appear for selecting the block size. If you have more than one legacy ISA card in your system that requires to use this address range, you can increase the block size to either 8K, 16K, 32K, or 64K. If you are using an ICU to accomplish this task, leave **ISA MEM Block BASE** to its default setting of *No/ICU*.

Symbios SCSI BIOS (Auto)

Auto allows the BIOS to detect whether you have a Symbios SCSI card, if detected the onboard Symbios BIOS will be enabled, if not then it will be disabled. *Disabled* prevents the onboard Symbios BIOS to be enabled so that the external Symbios SCSI card's own BIOS can be used instead. **NOTE:** If your Symbios SCSI card does not have a BIOS, the Symbios SCSI card will not function.

USB IRQ (Enabled)

Enabled reserves an IRQ# for the USB to work, *Disabled* does not allow the USB to have an IRQ# and therefore prevents the USB from functioning. If you are not using any USB devices, you may set this feature to *Disabled* to save an extra IRQ# for expansion cards.

ONB VGA BIOS First (No)

This allows you to select whether you want to use the onboard VGA BIOS as the primary BIOS. *No* allows external VGA cards to take precedent when detected. *Yes* always uses the onboard VGA card's BIOS, even when an external VGA card is installed.

4. BIOS SETUP

4.8 Load BIOS Defaults

The “Load BIOS Defaults” option allows you to load the troubleshooting default values permanently stored in the BIOS ROM. These default settings are non-optimal and disable all high performance features. To load these default settings, highlight “Load BIOS Defaults” on the main screen and then press <Enter>. The system displays a confirmation message on the screen. Press <Y> and then <Enter> to confirm. Press <N> and then <Enter> to abort. This feature does not affect the fields on the Standard CMOS Setup screen.

4.9 Load Setup Defaults

The “Load Setup Defaults” option allows you to load the default values to the system configuration fields. These default values are the optimized configuration settings for the system. To load these default values, highlight “Load Setup Defaults” on the main screen and then press <Enter>. The system displays a confirmation message on the screen. Press <Y> and then <Enter> to confirm. Press <N> and then <Enter> to abort. This feature does not affect the fields on the Standard CMOS Setup screen.

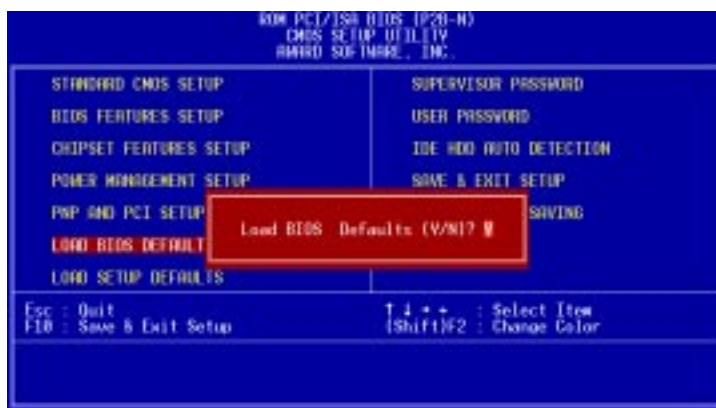

4. BIOS SETUP

4.10 Supervisor and User Password

These two options set the system passwords. “Supervisor Password” sets a password that will be used to protect the system and the Setup utility; “User Password” sets a password that will be used exclusively on the system. By default, the system comes without any passwords. To specify a password, highlight the type you want and then press <Enter>. A password prompt appears on the screen. Taking note that the password is case sensitive, and can be up to 8 alphanumeric characters long, type in your password and then press <Enter>. The system confirms your password by asking you to type it again. After setting a password, the screen automatically reverts to the main screen.

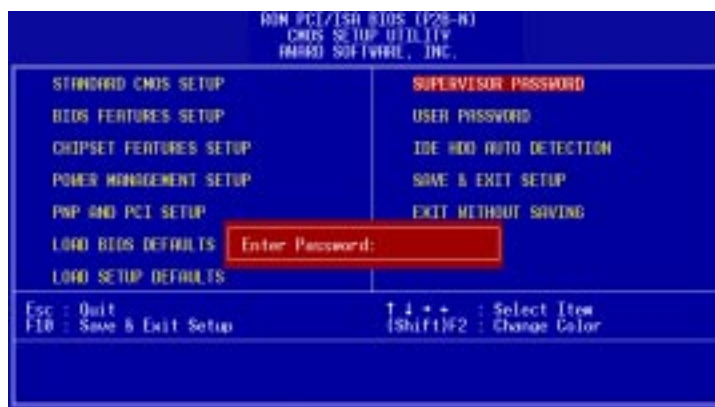

To implement password protection, specify in the “Security Option” field of the BIOS Features Setup screen when the system will prompt for the password. If you want to disable either password, press <Enter> instead of entering a new password when the “Enter Password” prompt appears. A message confirms the password has been disabled.

Forgot the password?

If you forgot the password, you can clear the password by erasing the CMOS Real Time Clock (RTC) RAM. The RAM data containing the password information is powered by the onboard button cell battery. To erase the RTC RAM: (1) Unplug your computer, (2) Short the solder points, (3) Turn ON your computer, (4) Hold down <Delete> during bootup and enter BIOS setup to re-enter user preferences.

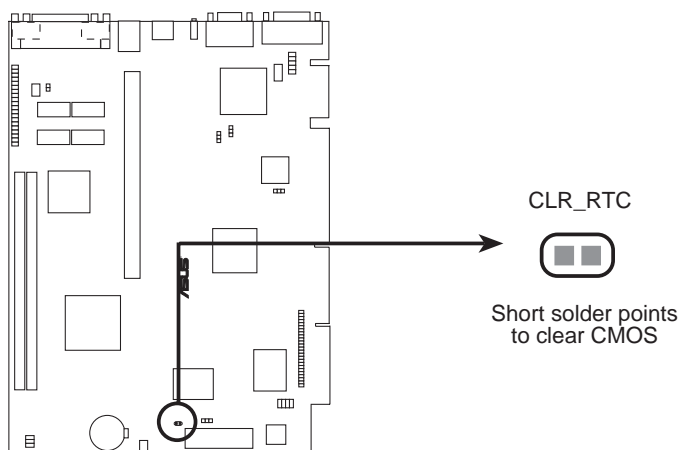

P2B-N Clear RTC RAM

4. BIOS SETUP

4.11 IDE HDD Auto Detection

The “IDE HDD Auto Detection” option detects the parameters of an IDE hard disk drive, and automatically enters them into the Standard CMOS Setup screen.

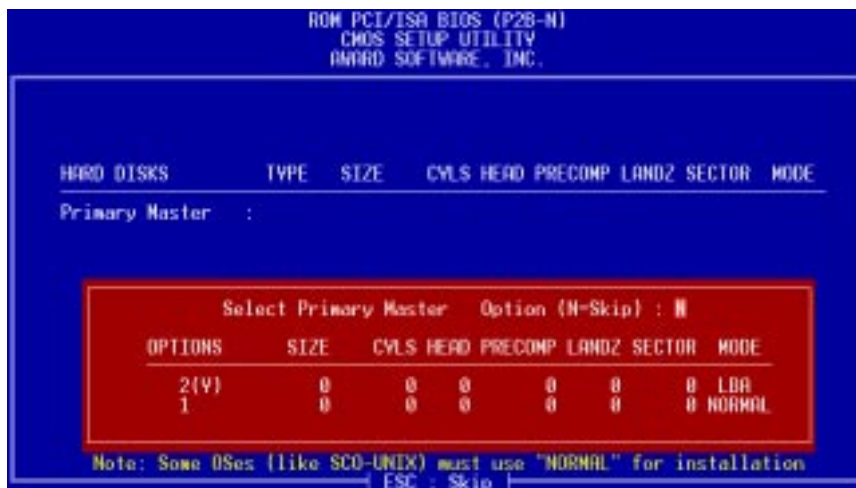

Up to four IDE drives can be detected, with parameters for each listed inside the box. To accept the optimal entries, press <Y> or else select from the numbers displayed under the OPTIONS field (2, 1, 3 in this case); to skip to the next drive, press <N>. If you accept the values, the parameters will appear listed beside the drive letter on the screen. The process then proceeds to the next drive letter. Pressing <N> to skip rather than to accept a set of parameters causes the program to enter zeros after that drive letter.

Remember that if you are using another IDE controller that does not feature Enhanced IDE support for four devices, you can only install two IDE hard disk drives. Your IDE controller must support the Enhanced IDE features in order to use Drive E and Drive F. The onboard PCI IDE controller supports Enhanced IDE, with two connectors for connecting up to four IDE devices. If you want to use another controller that supports four drives, you must disable the onboard IDE controller in the Chipset Features Setup screen.

When auto-detection is completed, the program automatically enters all entries you accepted on the field for that drive in the Standard CMOS Setup screen. Skipped entries are ignored and are not entered in the screen.

If you are auto-detecting a hard disk that supports the LBA mode, three lines will appear in the parameter box. Choose the line that lists LBA for an LBA drive. Do not select Large or Normal.

The auto-detection feature can only detect one set of parameters for a particular IDE hard drive. Some IDE drives can use more than one set. This is not a problem if the drive is new and empty.

4. BIOS SETUP

IMPORTANT: If your hard disk was already formatted on an older previous system, incorrect parameters may be detected. You will need to enter the correct parameters manually or use low-level format if you do not need the data stored on the hard disk.

If the parameters listed differ from the ones used when the disk was formatted, the disk will not be readable. If the auto-detected parameters do not match the ones that should be used for your disk, do not accept them. Press <N> to reject the presented settings and enter the correct ones manually from the Standard CMOS Setup screen.

4.12 Save & Exit Setup

Select this option to save into the CMOS memory all modifications you specified during the current session. To save the configuration changes, highlight the “Save & Exit Setup” option on the main screen, type “Y”, and then press <Enter>.



4.13 Exit Without Saving

Select this option to exit the Setup utility without saving the modifications you specify during the current session. To exit without saving, highlight the “Exit Without Saving” option on the main screen and then press <Enter>.

4. BIOS SETUP

(This page was intentionally left blank.)

5. SOFTWARE SETUP

5.1 Support CD Main Menu (Windows 98)

Inserting the support CD brings up a selection menu described as follows:
(NOTE: CD version and contents are constantly modified without notice.)

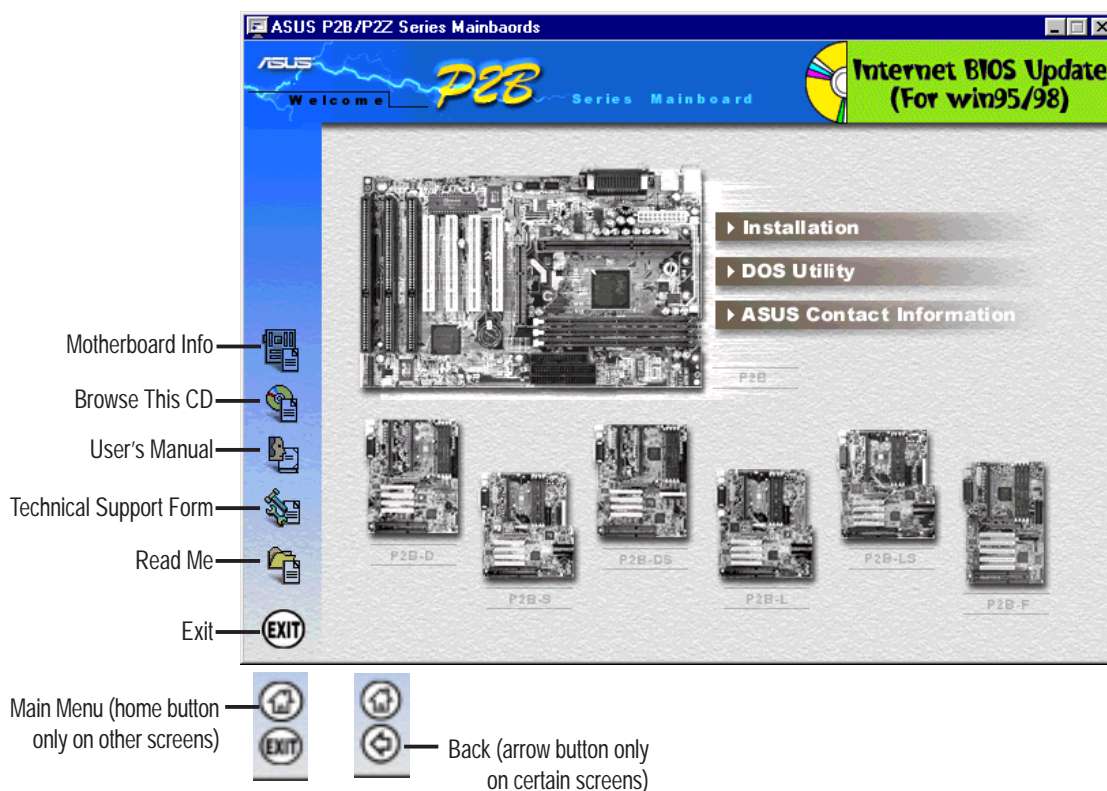

Navigation Button Descriptions

Motherboard Info displays information on your motherboard, BIOS, and CPU.

Browse This CD allows you to see the contents of the ASUS Support CD.

User's Manual displays the motherboard user's manual in pdf format.

Technical Support Form opens up a blank Technical Support Request Form for you to fill and print out when you run into technical difficulties and need technical assistance.

Read Me opens up a file containing additional notes.

Home returns you to the main menu of the support CD. (only on other screens)

Exit allows you to close the support CD.

Back returns you one screen back on the support CD.

5. SOFTWARE SETUP

5.2.1 Installation Submenu



LDCM

Brings up a menu to install software for monitoring the local system and/or PC systems on the network within the same bridge address. (**NOTE:** Will not run with ASUS PC Probe installed.)

ASUS PC Probe

Installs a simple software to monitor your computer's fan, temperature, and voltages. (**NOTE:** Will not run with LDCM installed.)

ASUS LiveUpdate

Installs a program to help you update your BIOS or download a BIOS image file.

Driver

Brings up a menu to install the necessary drivers for your onboard VGA, audio, LAN, and/or audio to work properly. (**NOTE:** This is not available if your motherboard does not have onboard VGA and audio.)

Other

Brings up a menu that allows you to install Adobe Acrobat Reader 3.01 for viewing the LDCM manual and/or Trend PC Cillin, a virus protection software.

5. SOFTWARE SETUP

5.2.2 DOS Utility Submenu



ASUS DMI Configuration Utility

Gives information on using the DMI configuration utility. This utility is located in the DMI folder under the root directory of the support CD.

Flash BIOS Utility DOS Version

Provides information on the Flash BIOS utility. This utility is located in the AFLASH folder under the root directory of the support CD.

5.2.3 ASUS Contact Information



5. SOFTWARE SETUP

5.3 LDCM Local Setup

Insert the Support CD that came with your motherboard into your CD-ROM drive or double-click the CD drive icon in **My Computer** to bring up the setup screen.

NOTE: LDCM will not run if another hardware monitoring utility is installed. To uninstall any program, see *5.8 Uninstalling Programs*.

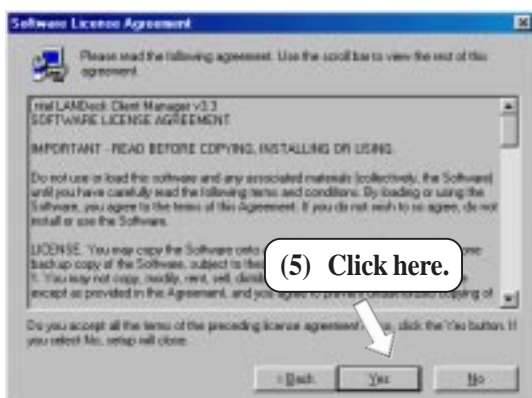
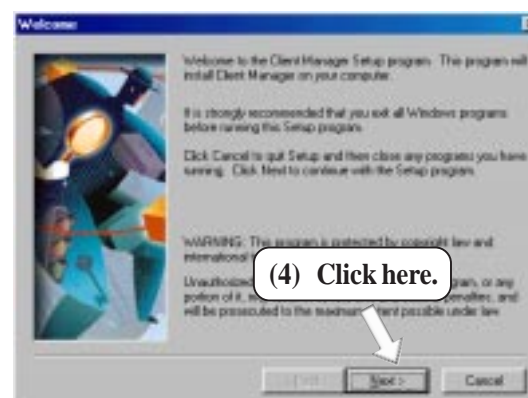
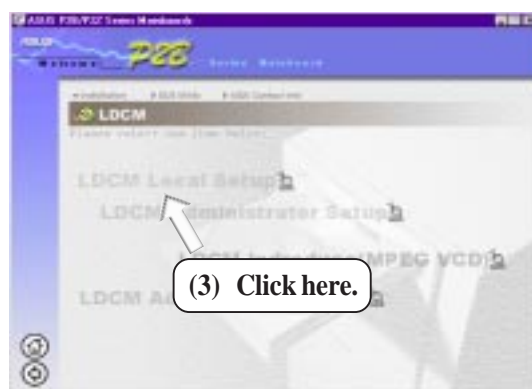

5. SOFTWARE SETUP

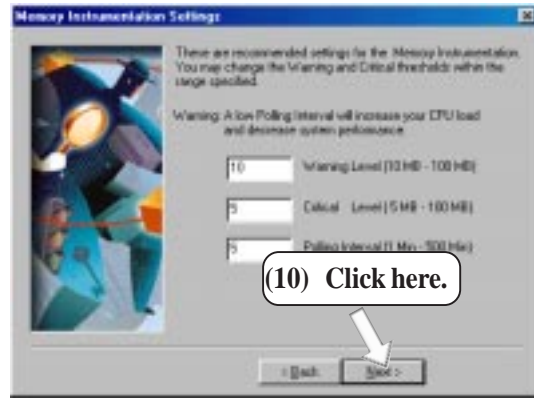
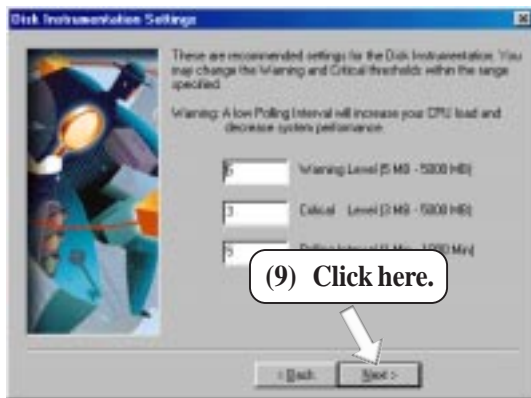

5. SOFTWARE SETUP

5.4 LDCM Administrator Setup

Insert the Support CD that came with your motherboard into your CD-ROM drive or double-click the CD drive icon in **My Computer** to bring up the setup screen.

NOTE: LDCM will not run if another hardware monitoring utility is installed. To uninstall any program, see *5.8 Uninstalling Programs*.

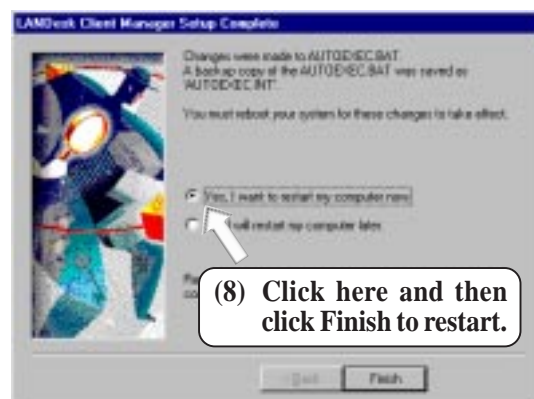
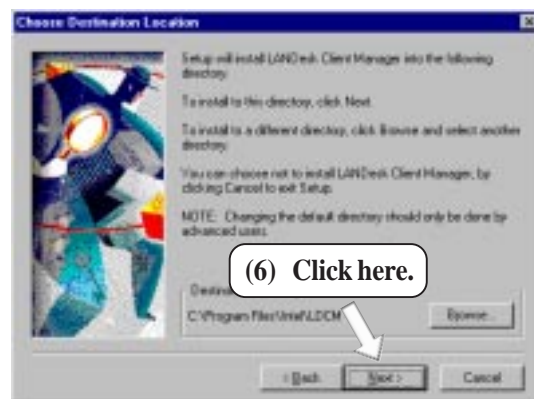
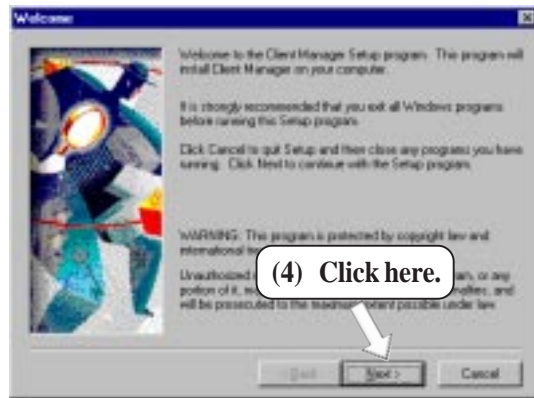

5. SOFTWARE SETUP

5.5 ASUS PC Probe

Insert the Support CD that came with your motherboard into your CD-ROM drive or double-click the CD drive icon in **My Computer** to bring up the setup screen.

NOTE: ASUS PC Probe will not run if another hardware monitoring utility is installed. To uninstall any program, see **5.8 Uninstalling Programs**.

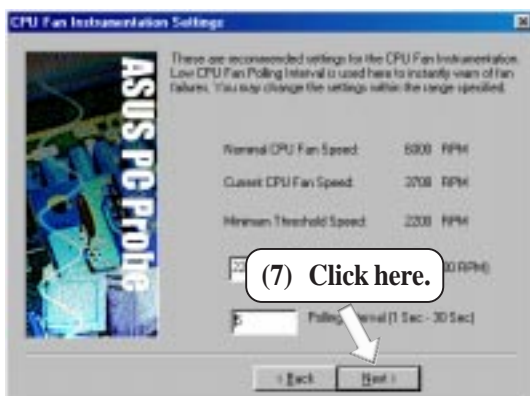
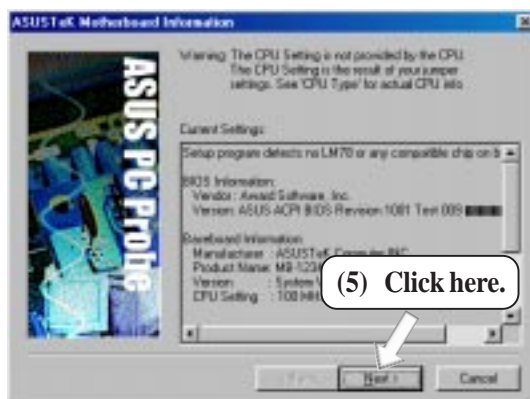

5. SAW SETUP
Windows 98

5. SOFTWARE SETUP

5.6 ASUS LiveUpdate

Insert the Support CD that came with your motherboard into your CD-ROM drive or double-click the CD drive icon in **My Computer** to bring up the setup screen.

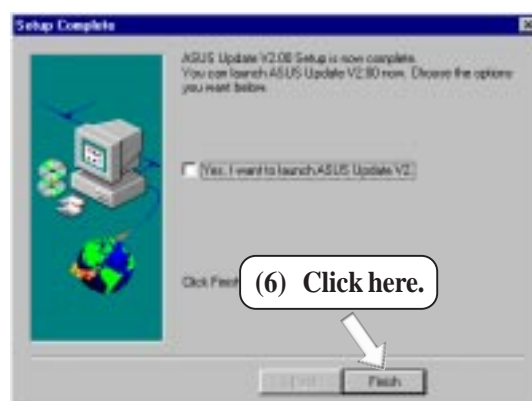
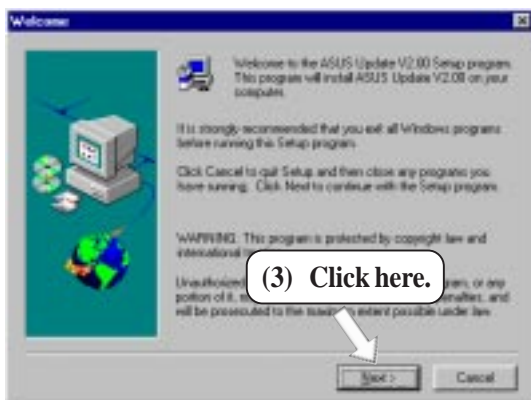

SOFTWARE SETUP

5.6 Driver

5.6.1 Network Driver Setup

Insert the Support CD that came with your motherboard into your CD-ROM drive or double-click the CD drive icon in **My Computer** to bring up the setup screen.

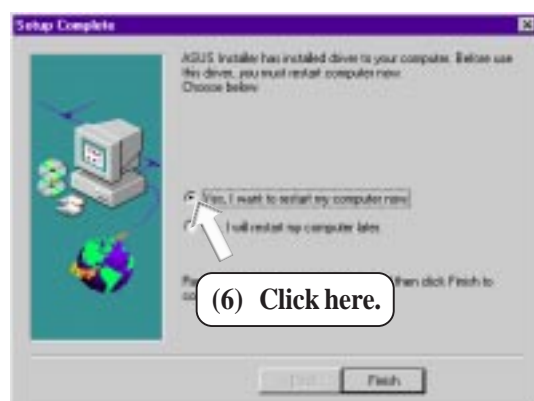
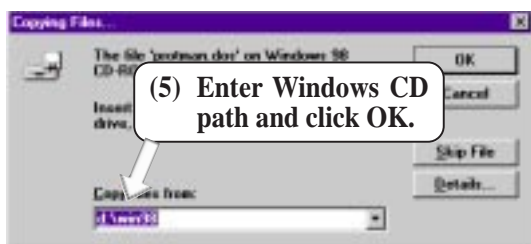
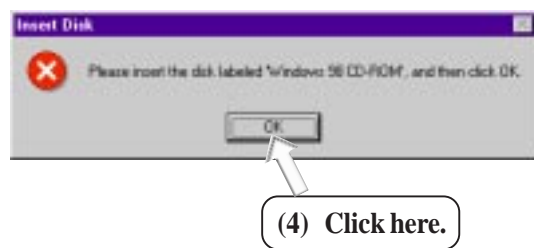

5. SOFTWARE SETUP

5.6.2 VGA Driver Setup

Insert the Support CD that came with your motherboard into your CD-ROM drive or double-click the CD drive icon in **My Computer** to bring up the setup screen.



5. SOFTWARE SETUP

5.6.3 Audio Driver Setup

Insert the Support CD that came with your motherboard into your CD-ROM drive or double-click the CD drive icon in **My Computer** to bring up the setup screen.



5. SOFTWARE SETUP

5.7 Other

5.7.1 ESS Audio Utilities

Insert the Support CD that came with your motherboard into your CD-ROM drive or double-click the CD drive icon in **My Computer** to bring up the setup screen.

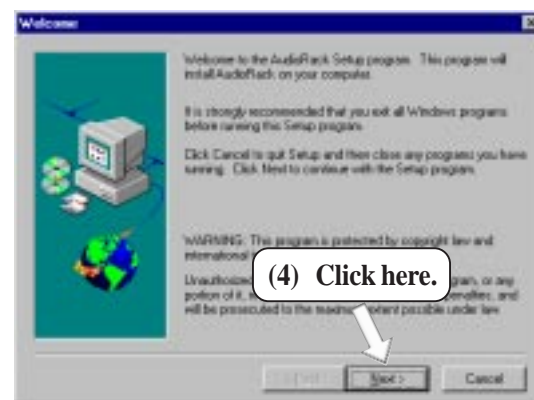

5. SOFTWARE SETUP

5.7.2 ESS Software Wave Table

Insert the Support CD that came with your motherboard into your CD-ROM drive or double-click the CD drive icon in **My Computer** to bring up the setup screen.



5. SOFTWARE SETUP

5.8 Uninstalling Programs

Add/Remove Programs is a basic component within Windows. You may use this function if a program does not provide its own uninstallation program.

(1) Double-click here to open the *Add/Remove Programs Properties* dialog box.

(2) Select the program you wish to remove and click here.

(3) Click here.

5. SOFTWARE SETUP

5.9 DOS and Windows 3.1 Setup for Novell

Automatic configuration

Some computers automatically detect and configure adapters and interfaces while booting. The network interface's IRQ level and I/O memory address of this motherboard are automatically set by the BIOS each time you start your computer.

Start your computer to automatically configure the network interface. Configuration is complete when the DOS prompt appears. You can now continue with the procedure below.

If your computer displays an error while booting, it may require additional steps.

Run Setup to install network drivers

Setup can automatically install NetWare DOS ODI client drivers for you or display a README file with installation instructions for other NOS drivers.

1. If your computer already has network drivers installed, restart the computer without loading them. If the drivers are loaded from the AUTOEXEC.BAT or CONFIG.SYS file, type REM in front of each line that loads a network driver. Or, with DOS 6.x or later press "F5" as DOS starts, to bypass the drivers.
2. Insert the ASUS Configuration and Drivers disk in a floppy drive, switch to that drive, and at the DOS prompt, type "SETUP".
3. If you have another network adapter in your computer, an adapter selection menu appears on the screen. Select the adapter you want by noting the Ethernet address.
4. Select Automatic Setup from the Main menu. Then follow the instructions on the screen. (If you want to test the interface with a responder on the network, see the next procedure.) Setup displays the configuration, then runs a series of diagnostic tests that makes sure the network interface or adapter and network are functioning properly. If Setup finds a problem, it displays the results and some possible solutions.
5. When Setup finishes the tests, you'll see the Install Network Drivers screen.
6. Select the driver you want to install. Setup can install a NetWare client driver for you. If you're installing other drivers, Setup displays a README file with installation instructions.

5. SOFTWARE SETUP

Troubleshooting

If you can't connect to a server, first try the suggestions here, then turn to the Troubleshooting section if necessary.

- Make sure you're using the drivers for this interface. The driver filename contains the letter B (for example, E100BODI.COM).
- If you're replacing an existing adapter, make sure the LINK statement in your NET.CFG is correct for the new interface or adapter. For example, the LINK statement for a NetWare client should be: "LINK DRIVER E100BODI"
- Verify that the frame type in your NET.CFG file matches your network.
- If setting up a server, check your LOAD and BIND statements.
- Test the interface by running diagnostics in Setup. Additional testing is available by using a responder.
- Check the README files.

Responder testing on the network (optional)

Setup can test the interface more thoroughly if you have a responder on the network while running the tests.

1. Go to a computer on the network with any EtherExpress adapter or interface installed (except EtherExpress 32 or EtherExpress 16 MCA).
2. Run the appropriate configuration program for the installed interface and set it up as a responder.
3. Return to the computer with the new adapter or interface. Run Setup and make the new interface the sender. Test the interface.

5.10 Windows NT Server or Workstation

Automatic configuration

Some computers automatically detect and configure adapters or interfaces while booting. The network interface's IRQ level and I/O address are automatically set by the BIOS each time you start your computer.

Start your computer to automatically configure the network interface. Configuration is complete when Windows NT starts or the DOS prompt appears.

If your computer displays an error while booting, it may require additional steps to configure.

Install network drivers - Windows NT Version 4.0 only

After starting Windows NT, you need to install the device drivers. Have the Windows NT CD-ROM disk available for this procedure.

5. SOFTWARE SETUP

NOTE: If you are installing Windows NT 4.0 at this time, click the Start Search button when the network network interface or adapter installation window appears. This allows NT to autodetect the network interface or adapter. You may then skip steps 1 - 4 below.

1. Double-click the Network icon in the Control Panel.
2. Click the **Adapters** tab in the window that appears.
3. Click **Add**. A list of network interface or adapter appears.
4. Select “Intel EtherExpress PRO Adapter” and click **OK**.

Install network drivers - Windows NT Version 3.5x only.

After setting up the network interface and starting Windows NT, you need to install the Intel drivers and test the network interface or adapter.

1. Double-click the Network icon in the Control Panel.
2. Click **Add Adapter**.
3. When the list of adapters appears, scroll to the end of the list and select <Other> Requires disk from manufacturer.
4. Insert the ASUS Configuration and Drivers disk in the A: drive and click **OK**.
5. Select the “Intel EtherExpress PRO Adapter” and click **OK**.
6. Click **OK** in the Network Settings dialog box and remove the installation disk. When prompted, restart Windows NT.

To install multiple network interface or adapters, repeat this procedure for each new network interface or adapter.

Troubleshooting

If Windows NT reports an error or you can't connect to the network, try the suggestions here first, then turn to the Troubleshooting section if necessary.

- Make sure you're using the drivers for this network interface or adapter. Drivers are located on the Windows NT CD-ROM or on the ASUS Drivers and Configuration disk.
- Make sure the driver is loaded and the protocols are bound. Check the Network Bindings dialog box in Windows NT.
- Check the Windows NT Event Viewer for error messages.
- If you are attaching to a NetWare network, check your frame type and verify that NetWare client software has been installed.
- Check with your LAN administrator — you may need to install supplemental networking software.

5. SOFTWARE SETUP

5.11 Windows 95

Automatic Configuration

Some computers automatically detect and configure adapters or interfaces while booting. The network interface's IRQ level and I/O address of this motherboard are automatically set by the BIOS each time you start your computer.

Start your computer to automatically configure the network interface or adapter. Configuration is complete when Windows 95 starts. If your computer displays an error while booting, it may require additional steps to configure.

Install Network Drivers from Diskette

Have your Windows 95 installation CD-ROM or disks available, as Windows 95 prompts for them when you install the new network interface or adapter.

1. After you have set up your motherboard for network use, start Windows 95. The *New Hardware Found* dialog box appears. If this box does not appear and Windows 95 starts normally, you may need to manually add the network interface or adapter.
2. Click "Driver from disk provided by hardware manufacturer," then click **OK**. The *Install From Disk* dialog box appears.
3. Insert the ASUS Configuration and Drivers disk.
4. Specify A:\ (or B:\) as the path, then click **OK**.
5. Follow prompts for any Windows 95 installation disks and restart when prompted. (If you installed from CD-ROM, the installation files are typically located at D:\Win95, where D is your CD-ROM drive.)

After restarting Windows 95, you should be able to connect to your network by double-clicking the Network Neighborhood.

Troubleshooting

If you can't connect to a server or if Windows 95 reports an error after you double-click Network Neighborhood, try the suggestions here first, then the Troubleshooting section if necessary.

- Make sure you're using the drivers that are on the drivers diskette that ships with this network interface or adapter.
- Make sure the driver is loaded and the protocols are bound. Check Device Properties list for trouble indicators (an X or ! symbol).
- Check with your LAN administrator — you may need to install supplemental networking software.

NetWare Server, Client 32, UNIX, OS/2, Banyan, and Other Operating Systems

For these, refer to our online documents. On a DOS computer, view the appropriate README file for information on installing your network driver.

5. SOFTWARE SETUP

5.12 Select Duplex Mode (optional)

Duplexing is a performance option that lets you choose how the network interface or adapter sends and receives data packets over the network. This motherboard's network interface can operate at full duplex only when connected to a full duplex 10BASE-T, 100BASE-TX switching hub, or another full duplex network interface or adapter. To summarize:

- **Auto (requires a full duplex network interface or adapter or switching hub with auto-negotiation capability).** The network interface or adapter negotiates with the hub to send and receive packets at the highest rate. This is the default setting. If the hub does not provide auto-negotiation, the network interface or adapter runs at half duplex.
- **Full duplex (requires a full duplex switching hub or network interface or adapter).** The network interface or adapter can send and receive packets at the same time. This mode can increase network interface or adapter performance capability. If the full duplex hub provides auto-negotiation, the network interface or adapter runs at full duplex. If the full duplex hub does not provide auto-negotiation, you need to set the network interface or adapter duplex mode manually (see following paragraphs)
- **Half duplex.** The network interface or adapter performs one operation at a time; it either sends or receives.

NOTE: If your hub is running at 100 Mbps and half duplex, your potential bandwidth is higher than if you run at 10 Mbps and full duplex.

Manually Configuring for Full Duplex

If your switch supports auto-negotiation with the N-way standard, duplex configuration is automatic and no action is required on your part. However, few switches in the current installed base support auto-negotiation. Check with your network system administrator to verify. Most installations will require manual configuration to change to full duplex.

Configuration is specific to the driver you're loading for your network operating system (NOS), as shown in the following paragraphs. To set up the duplex mode, refer to the section below that corresponds to your operating system. The performance of the network interface or adapter may suffer or your network interface or adapter may not operate if your hub does not support full duplex and you configure the network interface or adapter to full duplex. Leave the network interface or adapter on half duplex if you are not sure what type of hub you are connected to.

DOS ODI, NDIS 2.01 Clients

Edit the NET.CFG or PROTOCOL.INI file. Add keywords to Link Driver section:

```
FORCEDUPLEX 2  
SPEED 100 (or 10 if 10BASE-T)
```

5. SOFTWARE SETUP

NetWare server

In AUTOEXEC.NCF, Load E100B.LAN and add the following statement (you must include the equal sign for servers):

```
FORCEDUPLEX=2  
SPEED=100 (or 10 if 10BASE-T)
```

For more information, see the README file for NetWare servers.

Windows NT

While running Windows NT:

1. From the Control Panel, double-click the Intel PROSet icon.
2. PROSet examines your system and displays the Adapter Setup window.

Windows 95

While running Windows 95:

1. From the Control Panel, double-click the Intel PROSet icon.
2. PROSet examines your system and displays the Adapter Setup window. If you have multiple adapters, click the adapter you are configuring (you can identify it by its Ethernet address). Each adapter must be configured separately.
3. From the window that appears, click **Change**.
4. From the Adapter Setup window, click the menu for Network Speed.
5. Click **100** or **10 Mbps**, depending on your hub speed.
6. Click the menu for Duplex Mode
7. Click **Full**.
8. Click **OK** when finished.
9. Click **OK** to restart Windows 95.

Other operating systems

See the *Adapter Installation and Special Configurations* README file. "Push" Installation for Windows 95

If you are a LAN Administrator setting up server-based push installation of Windows 95 as defined in Microsoft Windows 95 Resource Kit, additional steps are required for this network interface or adapter.

6. SOFTWARE REFERENCE

6.1 ASUS PC Probe

ASUS PC Probe is a convenient utility to continuously monitor your computer system's vital components, such as fan rotations, voltages, and temperatures. It also has a utility that lets you review useful information about your computer, such as hard disk space, memory usage, and CPU type, CPU speed, and internal/external frequencies through the DMI Explorer.

6.1.1 Starting ASUS PC Probe

When ASUS PC Probe starts, a splash screen appears allowing you to select whether to show the screen again when you open PC Probe or not. To bypass this startup screen, clear the **Show up in next execution** check box.

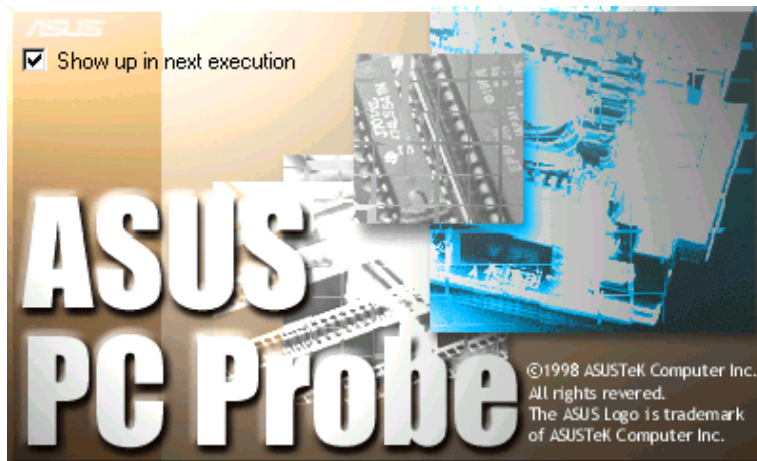

To open **ASUS PC Probe**, click the Windows **Start** button, point to **Programs**, and then **ASUS Utility**, and then click **Probe Vx.xx**.

The PC Probe icon  will appear on the taskbar's system tray indicating that ASUS PC Probe is running. Clicking the icon will allow you to see the status of your PC.

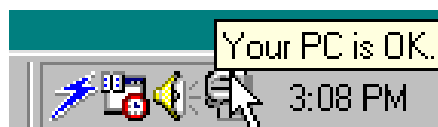

6. SOFTWARE REFERENCE

6.1.2 Using ASUS PC Probe

Monitoring

Monitor Summary

Shows a summary of the items being monitored.



Temperature Monitor

Shows the PC's temperature.

Temperature Warning threshold adjustment
(Move the slider up to increase the threshold level or down to decrease the threshold level)



Fan Monitor

Shows the PC's fan rotation.

Fan Warning threshold adjustment
(Move the slider up to increase the threshold level or down to decrease the threshold level)

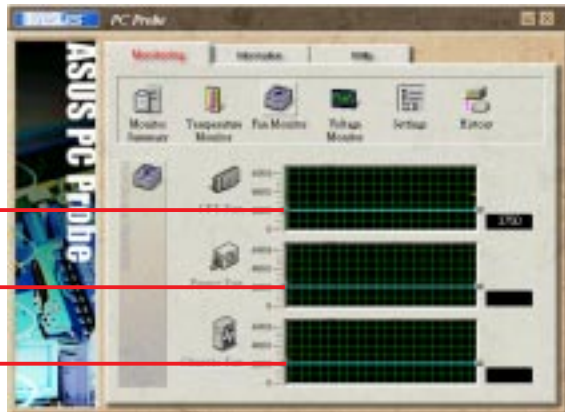

Voltage Monitor

Shows the PC's voltages.

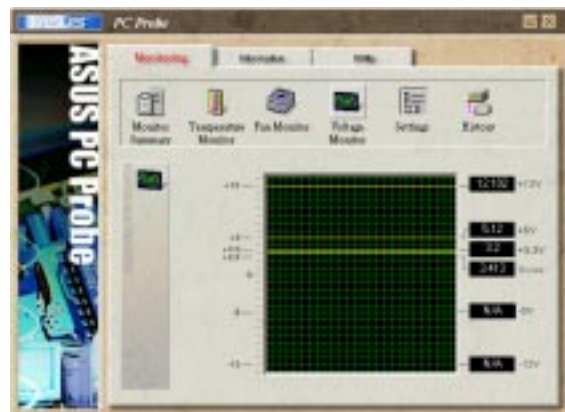

6. SOFTWARE REFERENCE

Settings

Lets you set threshold levels and polling intervals or refresh times of the PC's temperature, fan rotation, and voltages.



History

Lets you record the monitoring activity of a certain component of your PC by date, time, and target history.



Information

Hard Drives

Shows the used and free space of the PC's hard disk drives and the file allocation table or file system used.



Memory

Shows the PC's memory load, memory usage, and paging file usage.



6. SOFTWARE REFERENCE

Device Summary

Shows a summary of devices in your PC.



DMI Explorer

Shows information pertinent to the PC, such as CPU type, CPU speed, and internal/external frequencies, and memory size.



Utility

Lets you run programs outside of the ASUS Probe modules. To run a program, click **Execute Program**. **NOTE:** This feature is currently unavailable.



6. SOFTWARE REFERENCE

6.1.3 ASUS PC Probe Task Bar Icon

Right clicking the PC Probe icon will bring up a menu to open or exit ASUS PC Probe and pause or resume all system monitoring.



When the ASUS PC Probe senses a problem with your PC, portions of the ASUS PC Probe icon changes to red, the PC speaker beeps, and the ASUS PC Probe monitor is displayed.

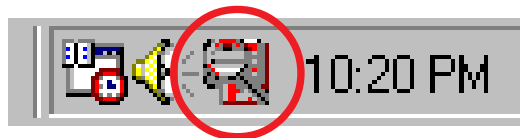

6. SOFTWARE REFERENCE

(This page was intentionally left blank)

6. SOFTWARE REFERENCE

6.2 AudioRack32

The **AudioRack32** enables you to take advantage of your computer's audio capabilities with all of the controls conveniently in one compact space. You can play audio CDs, wave files (in WAV and .AUD formats), and MIDI files (in .MID and .RMI formats). With the multisource Audio Mixer, you can blend these sources with line-in and microphone sources any way you choose. You can then record your creations as wave files and edit them with the Audio Recorder.

The **AudioRack32** has six main parts:

- Command Center—customizes the appearance of the **AudioRack32**.
- 3-D/Tone Controller—gives your computer ambient 3D sound, transmitting any sound played through the **AudioRack32** into a wider arc.
- Audio Mixer—controls the volume and balance of the **AudioRack32** devices.
- Digital Audio Player—plays and records files in the .WAV format.
- MIDI Player—enables you to play MIDI files.
- Compact Disk Player—enables you to play audio CDs on a CD-ROM drive.

In addition, the **AudioRack32** has a miniature mode enabling you to control the **AudioRack32** while using minimal screen space.

The Audio Recorder is a separate application from the **AudioRack32**. It can be used to add effects and edit files recorded with the Digital Audio Player or by the Audio Recorder itself. The Audio Recorder can be launched from the **AudioRack32**'s Digital Audio Player or on its own.







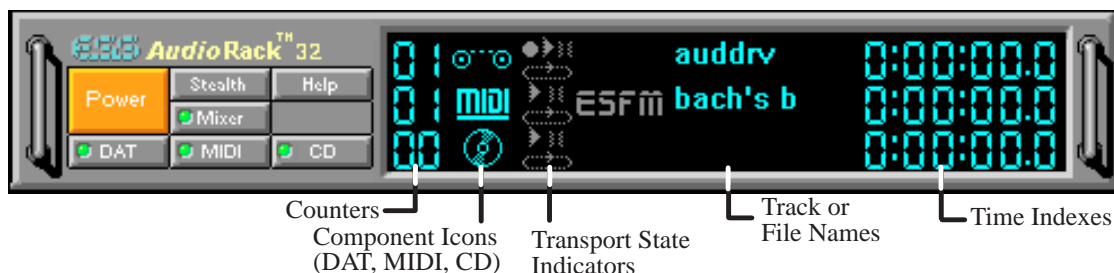

6. SOFTWARE REFERENCE

6.2.1 The Command Center

The Command Center controls which parts of the *AudioRack32* are displayed. You can display or hide any part of the *AudioRack32* you choose, customizing its appearance to suit your needs or desires. It also displays information on the status of the different audio components.



The Command Center Controls

-  closes the *AudioRack32* window.
-  enables the Miniature mode, minimizing the *AudioRack32* display.
-  displays/hides the Digital Audio Player.
-  accesses On-line Help.
-  displays/hides the Compact Disk Player.
-  displays/hides the Audio Mixer.
-  displays/hides the MIDI Player.

The Command Center Display

Counter: shows you which track or file in the playlist the component is playing.

Component Icon: is displayed when the associated component is shown and is not displayed when the component is hidden.

Transport State Indicator: shows the state of a component. It indicates when the component is playing, paused, has the Auto Repeat enabled, or in the case of the Digital Audio Player, is recording.

Track or File Name: shows the name of the current track or file in the playlist.

Time Index: displays the amount of time elapsed for the track or file in hours, minutes, seconds, and tenths of a second.

6. SOFTWARE REFERENCE

6.2.2 The 3-D/Tone Controller

The 3-D/Tone Controller lets you create an atmosphere of a resonant sound environment rather than an audio issuing from a 2D plane. See online help for more information.



The 3-D/Tone Controller Controls

The Spatial Control has four settings:

Max: provides the greatest effect, works best with games.

Mid: works best with most audio CDs and music (default setting).

Min: works best with some audio CDs.

Off: no spatilaization, normal stereo.

NOTE: You should have Spatializer hardware in your audio setup to be able to make full use of the controller functions in *AudioRack*. If you do not have, you may still see the controller, but it will have no effect on your PC's audio.

6.2.3 The Miniature Mode

The Miniature mode is designed to give you full control of the *AudioRack32* while using a minimum of space. You are able to effectively use the *AudioRack32* and still have enough room on your desktop to run other applications. In the Miniature mode, you can play, pause, stop, and control the master volume of the *AudioRack32*.

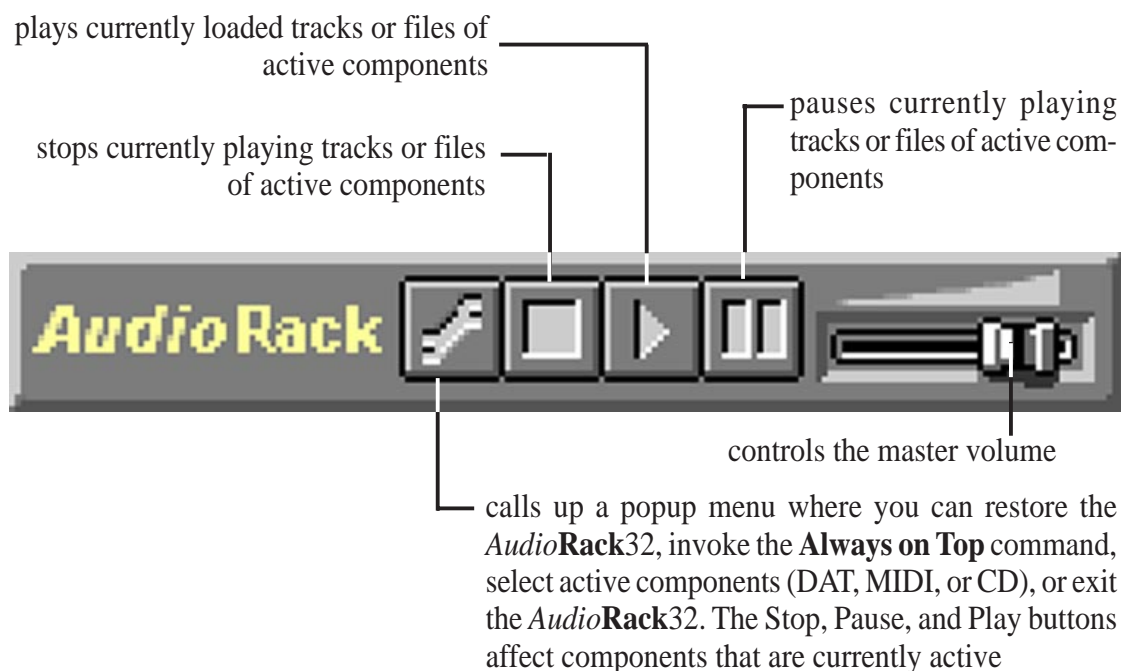

6. SOFTWARE REFERENCE

6.2.4 The Audio Mixer

The Audio Mixer has two modes: Playback mode and Record mode. You can use these two modes to fully control which of your audio sources you are listening to or recording, how loud each of those sources are and how they are balanced. Each audio source has its own module with mute, balance and volume controls.

In addition, the Audio Mixer provides special effects controls for chorus, reverb, treble, bass, and 3-D effects.



The Audio Mixer Controls

The two Playback and Record toggle buttons are used to switch between Playback mode and Record mode.

The Effects toggle button switches the display to the effects panel where you can use the buttons to enable and disable effects and the sliders to control the amount of the effect.

There are a number of audio source modules displayed on the Audio Mixer. The exact number displayed depends on the capabilities of your hardware. Each module has three controls:



a slider to adjust the balance

a slider to adjust the volume

a button for muting

Modules that your hardware may provide for are: Master, Line, Wave, Mic, CD, MIDI, and Aux B.

6. SOFTWARE REFERENCE

6.2.5 The Digital Audio Player

The Digital Audio Player enables you to play, record, and compress sound as .WAV files. In addition, you can play .AUD files. The .WAV files use PCM, which is the Windows' audio file format. The .AUD format uses ESPCM' compression to produce an audio file. Files are written directly to your hard disk as you record, enabling you to record very large files. Your only limitation is the amount of free space on your hard disk. The voice activation feature is useful for recording any kind of intermittent audio. The Digital Audio Player provides a choice of linear PCM (8 or 16 bit) recording. Note that you have additional options using the Audio Recorder, which is invoked by the **Edit** button.



The Digital Audio Player Controls

- starts recording to your hard disk.
- goes to the end of the wave file or to the next file in the current playlist.
- plays the wave file currently loaded.
- enables or disables the Auto Repeat.
- activates or deactivates the Pause
- opens the Audio Recorder window.
- stops the file currently playing.
- opens the Set Playlist dialog box.
- goes back one second in the wave file.
- starts a new file by opening the New Options dialog box.
- goes forward one second in the wave file.
- brings up the Open file dialog box in order to load a file into the Digital Audio Player.
- goes to the beginning of the wave file or to the previous file in the current playlist.
- saves an audio file.

The Digital Audio Player Display

The Level Meter displays the output from the left (top) and right (bottom) channels when a wave file is played.

By clicking on the image of the tape deck, you can display information about the file currently loaded in the Digital Audio Player. The display tells you the file name, size, number of bits per sample, sample rate, and whether the file was recorded in stereo or mono. Click again to return to the image of the tape deck.

audrv.wav
47 Kbytes
16 bit 22 kHz
Mono









6. SOFTWARE REFERENCE

6.2.6 The MIDI Player

The MIDI Player enables you to play MIDI files with the .MID or .RMI file extensions. These MIDI (Musical Instrument Digital Interface) files can be produced by sequencer programs and then played back using the MIDI Player. You can also mix MIDI files with other audio sources. Or you can compile MIDI files in a playlist and play them back in any order you choose.



The MIDI Player Controls

-  plays the MIDI file currently loaded.
-  goes back one file in the playlist.
-  activates/deactivates Pause
-  goes forward one file in the playlist.
-  stops the file currently playing.
-  enables/disables the Auto Repeat.
-  goes back one second in the MIDI file.
-  opens the Set Playlist dialog box.
-  goes forward one second in the MIDI file.

The MIDI Player Display

By clicking on the image of the floppy drive, you can display the length and name of the current MIDI file in the playlist. Click the display to return to the image of the floppy drive.

 The MIDI Player has an indicator to show when you are listening to ESFM. When the ESFM light to the left of the playlist button is lit, the MIDI Player is using ESFM synthesis. ESFM performs superior-quality music synthesis compared to that of traditional FM, producing richer timbre and greater depth of instrument voices. **FM synthesis is a lower quality technology compared with Wave table synthesis. This card supports Wave table synthesis therefore ESFM is not supported on this card.**











6. SOFTWARE REFERENCE

6.2.7 The Compact Disk Player

If you have a CD-ROM drive, you can play audio CDs. Check your hardware manual about setting up CD audio hardware and drivers. The Compact Disk Player uses intelligent CD playlist management: The Compact Disk Player maintains a record of each CD you play. It remembers the last playlist you used with each CD and loads that playlist automatically whenever you insert that CD.



The Compact Disk Player Controls

-  plays the MIDI file currently loaded.
-  goes back one file in the playlist.
-  activates or deactivates the Pause
-  goes forward one file in the playlist.
-  stops the file currently playing.
-  enables or disables the Auto Repeat.
-  goes back one second in the MIDI file.
-  opens the Set Playlist dialog box.
-  goes forward one second in the MIDI file.
-  ejects the CD from the CD-ROM drive.

6. SOFTWARE REFERENCE







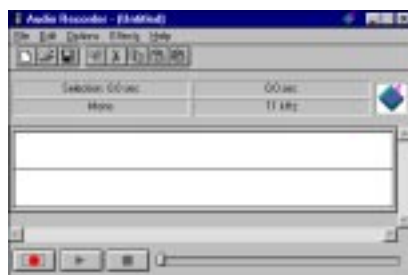





6.2.8 The Audio Recorder

The Audio Recorder enables you to record, compress, store, and play back voice, music, and other sound. It provides settings for sound attributes such as mono/stereo, compression level, and sampling rate. You can use it to embed sound objects in documents created in applications that support object linking and embedding (OLE).

The Audio Recorder's edit, record, and playback capabilities are compatible with the Windows Sound Recorder and other recorders that record and play back in the PCM format. Like the Digital Audio Player, the Audio Recorder can record and play back .WAV and .AUD files. The Audio Recorder allows a choice of compression from low, medium, and high ESPCM and ADPCM.



The Audio Recorder Controls

-  starts a new audio file.
-  inserts the Clipboard audio at the cursor or replaces the selected portion.
-  opens an audio file.
-  mixes the Clipboard audio with the audio beginning at the cursor.
-  saves an audio file.
-  starts recording.
-  reverses the last change you made to the current audio file.
-  plays the currently loaded audio file.
-  removes the selected portion of the audio file and stores it on the Clipboard.
-  stops the file currently playing or recording.
-  copies the selected audio portion to the Clipboard without removing it.
-  determines the cursor position on the waveform.

The Audio Recorder Display



The four text boxes under the tool bar display the length in seconds of the selected part of the currently loaded file, the total length in seconds of the current file, whether the file is in stereo or mono, and the sampling rate in kilohertz.

To the right of the text boxes is a box displaying the icon associated with the particular file. If a file has no icon associated with it, it is given a default icon.

6. SOFTWARE REFERENCE

6.2.9 Release Notes

This information is provided for convenience only. Information here is subject to change without prior notice. View the installation CD for any updated information in Readme text files. The AudioRack also provides detailed online help (click the **Help** button on the “Command Center”)

Disable Eject Button on the CD Player

Under the Windows directory in the file “auddrive.ini”, there is a string “DisableEjectButton=0” under the [cdplayer] section. If you would like to disable EJECT button on the CD player, you can change the value from 0 to 1. You need to close AudioRack and launch it again to make the new settings take effect.

Using AudioRack CD Player as Default CD Player

During installation, you will be asked if you want to use AudioRack CD player as the default CD player. Normally Windows 95 CD player is the default and will automatically run when an audio CD is inserted into the CD-ROM. If you answer “Yes”, the installation program will overwrite the value of the key [HKEY_CLASSES_ROOT]\AudioCD\shell\play\command in the registry. You may switch back to Windows 95 CD player by resetting this key value.

Configuring Playback Mixer

The PCI audio chip offers eight inputs for the playback mixer, including “Line”, “Wave”, “CD”, “Synth”, “Aux A”, “Aux B”, “Mic”, and “Mono In”. AudioRack can only display six of them at a time. You may configure the settings by modifying the file “auddrive.ini” in the Windows directory. Under the section [MixerRak], you can enable or disable the display of each input by setting its corresponding binary value to 1 (enable) or 0 (disable).

6. SOFTWARE REFERENCE

6.3 Display Settings for Windows 95/98

To change resolution, color, and other display properties, either right-click the Windows 95/98 desktop and then choose **Properties**, double-click the **Display** icon in the Control Panel, or right-click the ATI icon in the system tray.

6.3.1 Adjustment Menu

You can adjust the screen output on the monitor from the Adjustment menu. Use the Position and Size arrows to center your screen and make it as large as possible.

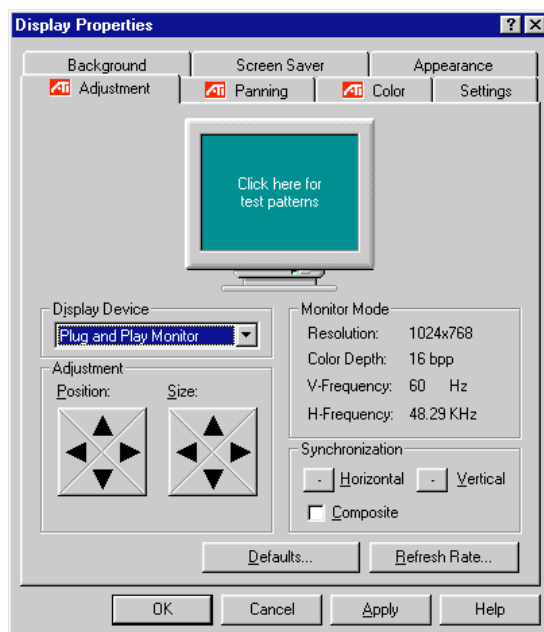

6.3.2 Panning Menu

This allows you to assign hotkeys in the *Value* box for moving your screen up, down, left, right, in, or out in any application. Click **Defaults** to fill in the *Value* box with default values.

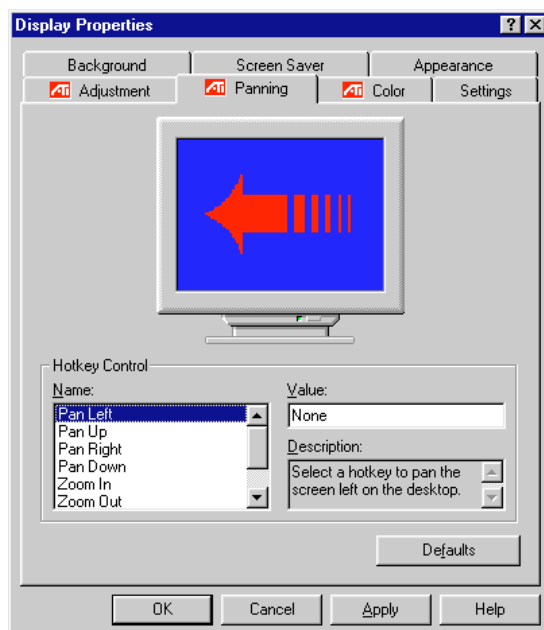

6. SOFTWARE REFERENCE

6.3.3 Color

This allows you to adjust the Gamma level for your monitor and color levels for Red, Green, and Blue. You can save your settings by clicking **Save As** and typing in a file name. This allows you to recall previously saved settings. Click **Defaults** to restore all settings to their defaults.

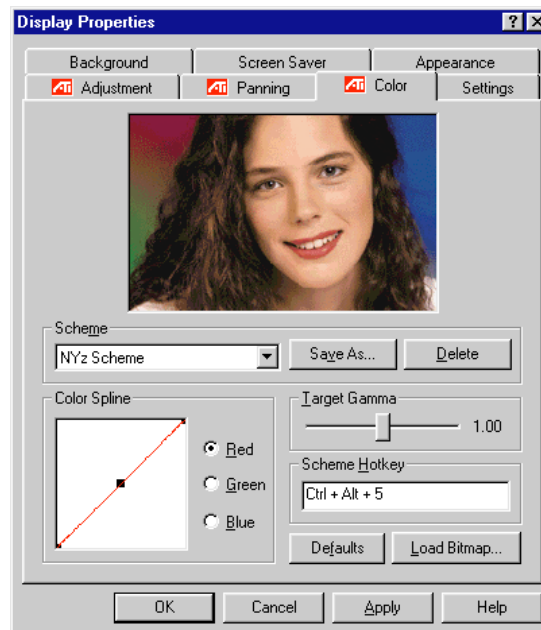

6.3.4 Settings

This allows you to adjust the Color palette, Font size, and Display area. Choose **Center dialog boxes** to keep messages visible, **Enable task bar icon** for easy access to the ATI configuration menus, and **Show settings icon on task bar** for quick resolution changes.

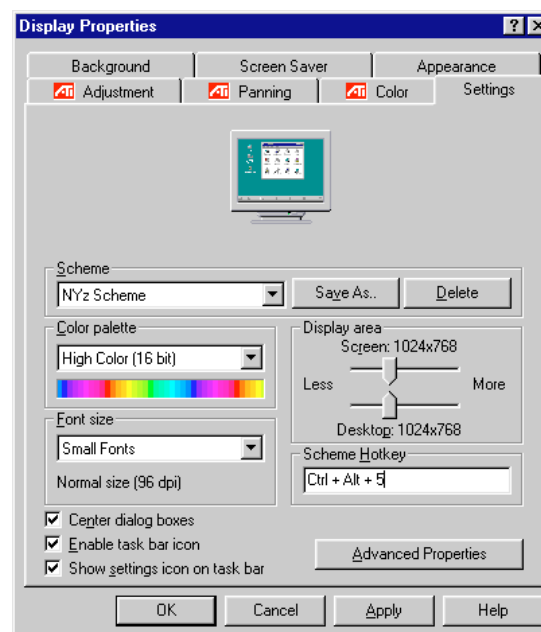

6. SOFTWARE REFERENCE

6.4 Desktop Management Interface (DMI)

6.4.1 Introducing the ASUS DMI Configuration Utility

This motherboard supports DMI within the BIOS level and provides a DMI Configuration Utility to maintain the Management Information Format Database (MIFD). DMI is able to auto-detect and record information pertinent to a computer's system such as the CPU type, CPU speed, and internal/external frequencies, and memory size. The onboard BIOS will detect as many system information as possible and store those collected information in a 4KB block in the motherboard's Flash EPROM and allow the DMI to retrieve data from this database. Unlike other BIOS software, the BIOS on this motherboard uses the same technology implemented for Plug and Play to allow dynamic real-time updating of DMI information versus creating a new BIOS image file and requiring the user to update the whole BIOS. This DMI Configuration Utility also allows the system integrator or end user to add additional information into the MIFD such as serial numbers, housing configurations, and vendor information. Those information not detected by the motherboard BIOS and has to be manually entered through the DMI Configuration Utility and updated into the MIFD. This DMI Configuration Utility provides the same reliability as PnP updating and will prevent the refreshing failures associated with updating the entire BIOS.

6.4.2 Starting the ASUS DMI Configuration Utility

The DMI Configuration Utility (DMICFG2.EXE) must be used in real mode in order for the program to run, the base memory must be at least 180K. Memory managers like HIMEM.SYS (required by windows) must not be installed. You can boot up from a system diskette without AUTOEXEC.BAT and CONFIG.SYS files, "REM" HIMEM.SYS in the CONFIG.SYS, or press <Shift>+<F5> during bootup to bypass your AUTOEXEC.BAT and CONFIG.SYS files.

1. In Windows, copy DMICFG2.EXE to your hard disk drive.
2. Restart your computer and press <Shift>+<F5> during bootup to enter safe mode command prompt.
3. Go to the directory containing DMICFG2.EXE.
4. Type **DMICFG2** and press <Enter> to run.

6. SOFTWARE REFERENCE

6.4.3 Using the ASUS DMI Configuration Utility

NOTE: The following screen displays are provided as examples only and may not reflect the screen contents on your system.

Edit DMI (or delete)



Use the ←→ (left-right) cursors to move the top menu items and the ↑↓ (up-down) cursor to move between the left hand menu items. The bottom of the screen will show the available keys for each screen. Press enter at the menu item to enter the right hand screen for editing. “Edit component” appears on top. The reversed color field is the current cursor position and the blue text are available for editing. The orange text shows auto-detected information and are not available for editing. The blue text “Press [ENTER] for detail” contains a second pop-up menu is available, use the + - (plus-minus) keys to change the settings. Enter to exit *and save*, ESC to exit *and not save*.

If the user has made changes, ESC will prompt you to answer Y or N. Enter Y to go back to the left-hand screen *and save*, enter N to go back to left-hand screen and *not save*. If editing has not been made, ESC will send you back to the left hand menu without any messages.

Notes

A heading, ***** BIOS Auto Detect *****, appears on the right for each menu item on the left side that has been auto detected by the system BIOS.

A heading, ***** User Modified *****, will appear on the right for menu items that have been modified by the user.



6. SOFTWARE REFERENCE

Save MIFD



You can save the MIFD (normally only saved to flash ROM) to a file by entering the drive and path here. If you want to cancel save, you may press ESC and a message “Bad File Name” appears here to show it was not saved.

Load MIFD



You can load the disk file to memory by entering a drive and path and file name here.

Load BIOS Defaults



You can load the BIOS defaults from a MIFD file and can clear all user modified and added data. You must reboot your computer in order for the defaults to be saved back into the Flash BIOS.

7. APPENDIX

7.1 PCI-L101 Fast Ethernet Card

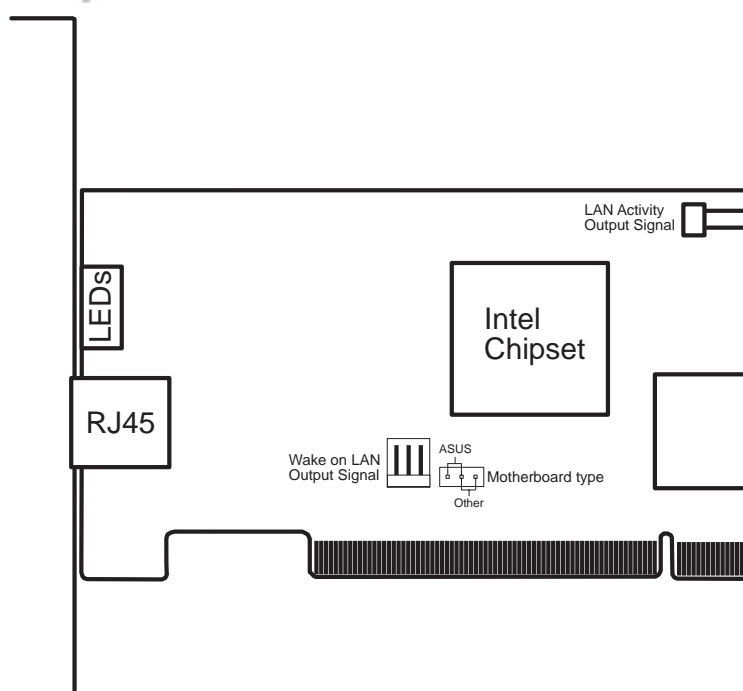
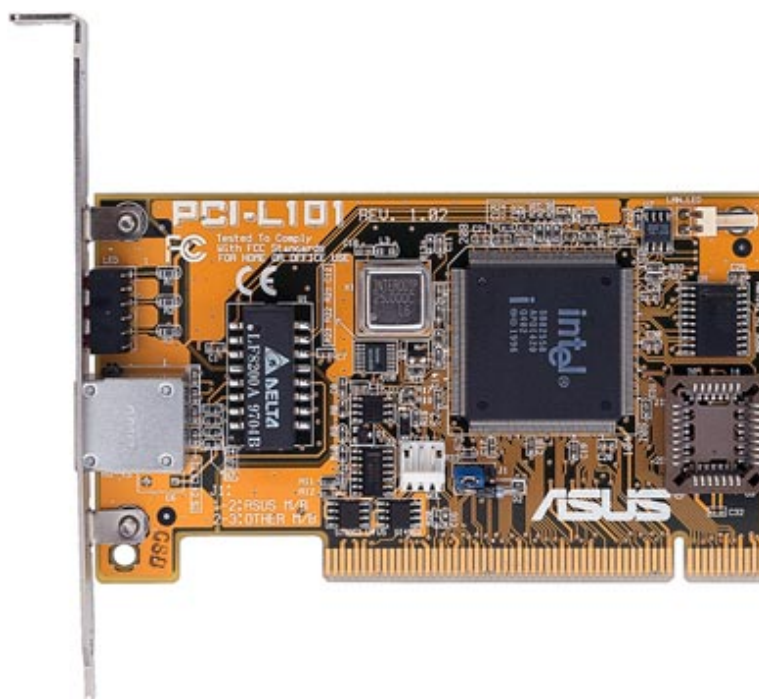

If you are using the ASUS PCI-L101 on an ASUS motherboard, leave the jumper on its default setting of “ASUS.” If you are using another brand of motherboard, set the jumper to “Other.” Connect the Wake on LAN (WOL) output signal to the motherboard’s WOL_CON in order to utilize the wake on LAN feature of the motherboard. Connect the LAN activity output signal (LAN_LED) to the system cabinet’s front panel LAN_LED in order to display the LAN data activity.

7. APPENDIX
ASUS LAN Card

7. APPENDIX

7.1.1 Features

- Intel 82558 Ethernet LAN Controller (Fully integrated 10BASE-T/100BASE-TX)
- Wake-On-LAN Remote Control Function Supported
- PCI Bus Master Complies to PCI Local Bus Rev. 2.1 specifications
- Consists of MAC & PHY (10/100Mbps) interfaces
- Complies to IEEE 802.3 10BASE-T and IEEE 802.3u 100BASE-TX interfaces
- Fully supports 10BASE-T & 100BASE-TX operations through a single RJ45 port
- Supports 32-bit Bus Master Technology / PCI Rev. 2.1
- Enhancements on ACPI & APM
- Adheres to PCI Bus Power Management Interface Rev. 1.0, ACPI Rev. 1.0, and Device Class Power Management Rev. 1.0
- IEEE 802.3u auto-negotiation for 10Mbps/100Mbps Network Data Transfer Rates.
- Provides LED indicators for monitoring network conditions
- Plug and Play

7.1.2 Software Driver Support

- **NetWare ODI Drivers** - Novell Netware 3.x, 4.x, DOS, OS/2 Client
- **NDIS 2.01 Drivers** - Microsoft LAN Manager, Microsoft Windows 3.11, IBM LAN Server
- **NDIS 3.0 Drivers** - Microsoft Windows NT, Microsoft Windows 95, Microsoft Windows 3.11

7.1.3 Question and Answer

Q: What is Wake-On-LAN ?

A: The Wake-On-LAN feature provides the capability to remotely power on systems supporting Wake-On-LAN by simply sending a wake-up frame. With this feature, remotely uploading/downloading data to/from systems during off-peak hours will be feasible.

Q: What can Wake-On-LAN do for you ?

A: Wake-On-LAN is a remote management tool with advantages that can reduce system management workload, provide flexibility to the system administrator's job, and then of course save you time-consuming efforts and costs.

Q: What components does Wake-On-LAN require to be enable?

A: To enable Wake-On-LAN function, your system requires Ethernet LAN adapter card that can activate Wake-On-LAN function, a client with Wake-On-LAN capability, and software such as LDCM Rev. 3.10 or up that can trigger wake-up frame.

7. APPENDIX

7.2 S370 Series CPU Cards

The optional ASUS S370 Series CPU Cards allow Slot 1 motherboards to accept socket 370 processors. The ASUS S370 Series CPU Cards give Slot 1 motherboard owners an inexpensive way to upgrade their Pentium II computers using lower costing socket 370 processors. Since socket 370 processors are based on the Pentium II design, the only difference is the connector and the amount of internal cache within the processor.

The following are pictures of the ASUS S370 Series CPU Cards with black plastic retainers attached to the edge. The retainer fins are used to hold the ASUS S370 Series CPU Cards in place using the motherboard's Slot 1 retention mechanisms.

ASUS S370 CPU Card (standard model)

- Better Support with Full Retainer
- Low Cost

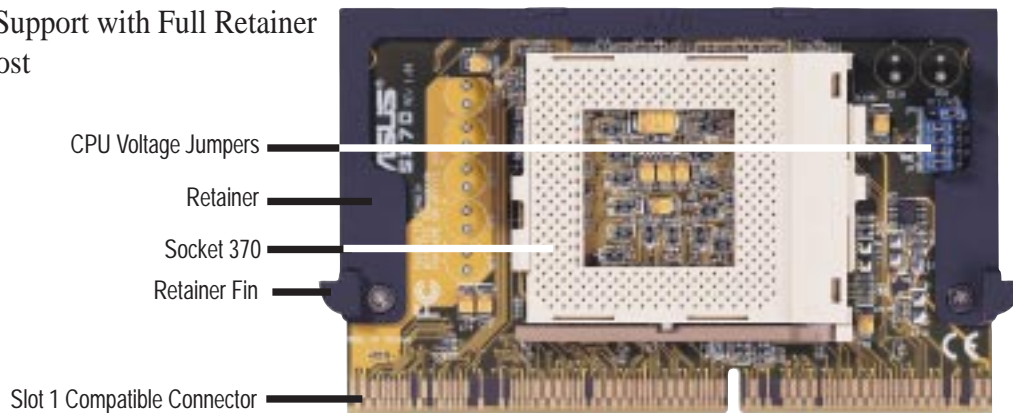

ASUS S370-L CPU Card (for smaller cases)

- Low Profile / Low Cost
- CPU Temperature Sensing (on supported motherboards)

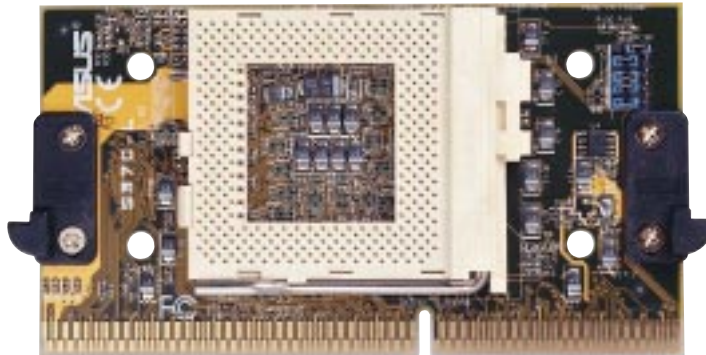

ASUS S370-D CPU Card (performance model)

- Better Support with Full Retainer
- CPU Temperature Sensing (on supported motherboards)
- Better Components

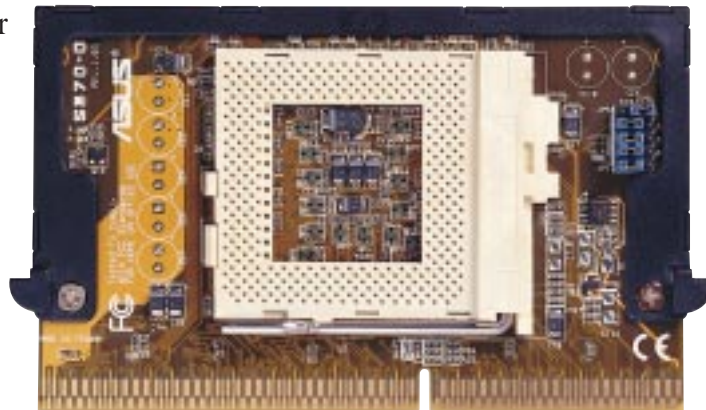

7. APPENDIX

7.2.1 Using the ASUS S370 Series CPU Card

The general procedure for using the ASUS S370 Series CPU Card is as follows:

1. Check the voltage setting for your socket 370 processor using the jumpers on the card if necessary. For current socket 370 processors, the default setting should be used. See the reverse side of the ASUS S370 Series CPU Card or this page for voltage settings.
2. Install the socket 370 processor. Installation of socket 370 processors is exactly like socket 7 processors. Lift the brown lever to 90° to install the processor and lower the brown lever to lock the processor.
3. Insert the ASUS S370 Series CPU Card into Slot 1 on the motherboard. The retainer fin on each side of the ASUS S370 Series CPU Card must catch on the retention mechanism so that it locks in place.
4. Connect the socket 370 processor's fan connector to the motherboard.
5. Make sure that no wires or objects come in contact with the fan.

7.2.2 ASUS S370 Series CPU Card Jumper Settings

The only set of jumpers on the ASUS S370 Series CPU Card is used for setting the voltage sent to the CPU. Setting the CPU voltage is *not* necessary for current socket 370 processors. If required, your socket 370 processor should have its voltage requirement printed on its surface or documentation. If no voltage is indicated or you are not sure, use the "CPU Def." setting as shown below.

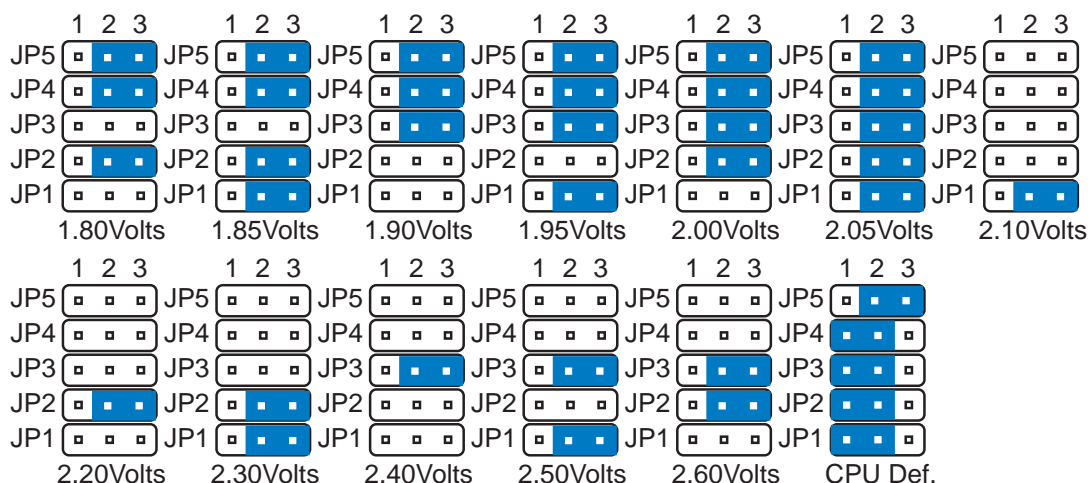

Socket 370 CPU Voltage

WARNING! Exceeding your socket 370 processor's required voltage can damage your processor permanently! Make sure that the jumpers are as shown for "CPU Def." unless otherwise specified before powering ON your motherboard.

7. APPENDIX

7.3 Network Controller

This motherboard features an optional 32-bit 10/100Mbps Ethernet network interface. This interface supports the bus mastering architecture and auto-negotiation feature, which makes it possible to use the common twisted-pair cabling with RJ45 connectors for both 10Mbps and 100Mbps connections. Extensive driver support for commonly-used network systems is also provided.

7.3.1 Features

- Intel 82558 Ethernet LAN Controller (Fully integrated 10BASE-T/100BASE-TX)
- Wake-On-LAN Remote Control Function Supported
- PCI Bus Master Complies to PCI Rev. 2.1
- Consists of MAC & PHY (10/100Mbps) interfaces
- Complies to IEEE 802.3 10BASE-T and IEEE 802.3U 100BASE-TX interfaces
- Fully supports 10BASE-T & 100BASE-TX operations
- Single RJ-45 Connector: Auto-Detection of 10Mbps or 100Mbps Network Data Transfer Rates and Connected Cable Types
- 32 bit Bus Master Technology / PCI Rev. 2.1
- Plug and Play
- Enhancements on ACPI & APM
- Adheres to PCI Bus Power Management Interface Rev. 1.0, ACPI Rev. 1.0, and Device Class Power Management Rev. 1.0

7. APPENDIX

7.3.3 LED Connectors

Link Indicator: This connects to an LED to monitor 10Base-T and 100Base-TX connections. The LED lights to indicate a successful network connection, and remains steady if the connection is stable. If this indicator is off, the cable connection between the hub and the computer may be faulty or the driver configuration may be faulty.

Activity Indicator: This connects to an LED to monitor network activity. The LED lights when there are network packets sent or received through the RJ45 port. The rate of flashing is proportional to the amount of network traffic. If this is off, the computer is not sending or receiving network data.

Speed Indicator: This connects to an LED to monitor connection speed. The LED lights (**On**) when connection is made to a 100Base-TX host. If **Off**, the network connection is operating at 10Mbps.

7.3.4 Network Cable Connection

Twisted Pair Ethernet (TPE) - Connect a single network cable to the RJ45 connector. For 100BASE-TX, your network cable must be category 5 (not category 3), twisted-pair wiring with RJ45 connectors. If you plan on running the interface at 100 Mbps, it must be connected to a 100BASE-TX hub (not a 100BASE-T4 hub). For 10BASE-T, use category 3, 4, or 5 twisted-pair wiring.

7.3.5 Twisted-Pair Cable

The cable used to connect the Ethernet card to a host (generally a Hub) is called a straight-through twisted-pair. The end connectors are called RJ45 connectors, which are not compatible with the standard RJ11 telephone connectors. The illustration shows a connection between a typical Hub and this motherboard's network interface.

Straight-Through Cable

| Hub | Card |
|--------|--------|
| 1 IRD+ | 1 OTD+ |
| 2 IRD- | 2 OTD- |
| 3 OTD+ | 3 IRD+ |
| 6 OTD- | 6 IRD- |

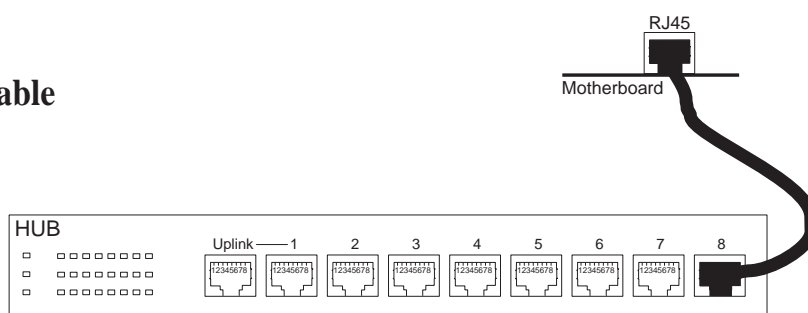

7.3.6 RJ45 Connector

| | |
|--------------|------------------------|
| Pin 1 | Output Transmit Data + |
| Pin 2 | Output Transmit Data - |
| Pin 3 | Input Receive Data + |
| Pin 6 | Input Receive Data - |
| Pins 4,5,7,8 | (Reserved) |

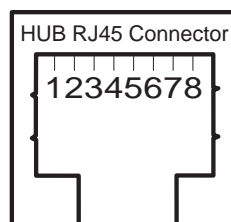

7. APPENDIX

7.3.7 Troubleshooting

If the interface can't connect to the network

Make sure the cable is installed properly.

The network cable must be securely attached at both RJ-45 connections (interface and hub). If the cable is attached but the problem persists, try a different cable. The maximum allowable distance from network interface or adapter or interface to hub is 100 meters.

If you're directly connecting two computers (no hub), use a crossover cable. Most hubs require a straight-through cable, while most switches require a crossover cable (see your hub or switch documentation to verify).

Check the LED lights on the network interface or adapter.

The optional network condition connector module has three diagnostic LEDs. These lights help indicate if there's a problem with the connector, cable, or hub. The table below describes the LEDs.

| LED | Indication | Meaning |
|------------|-----------------------|---|
| LNK | On | The interface and hub have acknowledged a connection; the link between the hub and interface is good. |
| | Off | The cable connection between the hub and interface is faulty; or you have a driver configuration problem. |
| ACT | On or flashing | The interface is sending or receiving network data. The frequency of the flashes varies with the amount of network traffic. |
| | Off | The interface is not sending or receiving network data. |
| SPD | On | Network connection operating at 100 Mbps. |
| | Off | Network connection operating at 10 Mbps. |

Make sure you're using the correct drivers.

Make sure you're using the drivers that come with your motherboard. The driver filename contains the letter B (for example, E100BODI.DOS).

Make sure the hub port and the network interface or adapter have the same duplex setting.

If you configured the network interface for full duplex, make sure the hub port is also configured for full duplex. Setting the wrong duplex mode can degrade performance, cause data loss, or result in lost connections.

7. APPENDIX

Testing the network interface or adapter

Test the network interface or adapter by running Intel diagnostics. For DOS or Windows 3.1 computers, run Setup on the ASUS Configuration and Drivers disk. For Windows NT and Windows 95 run Intel PROSet by double-clicking the Intel PROSet Icon in the Control Panel. Click Help from the main PROSet window to get complete diagnostics information and instructions.

Common problems and solutions

SETUP.EXE reports the network interface or adapter is “Not enabled by BIOS”.

- The PCI BIOS isn't configuring the network interface or adapter correctly. Try the PCI installation tips.

The computer hangs when the drivers are loaded.

- Change the PCI BIOS interrupt settings. See the next page for PCI installation tips.
- If you are using EMM386, it must be version 4.49 or newer (this version ships with MS-DOS 6.22 or newer).

Diagnostics pass, but the connection fails or errors occur.

- At 100 Mbps use category 5 wiring and make sure the network cable is securely attached.
- For NetWare clients, make sure you specify the correct frame type in the NET.CFG file.
- Make sure the duplex mode setting on the network interface or adapter matches the setting on the hub.
- At 100 Mbps, connect to a 100BASE-TX hub only (not T4).

The LNK LED doesn't light.

- Make sure you've loaded the network drivers.
- Check all connections at the network interface or adapter and the hub.
- Try another port on the hub.
- Make sure the duplex mode setting on the network interface or adapter matches the setting on the hub.
- Make sure you have the correct type of cable between the network interface or adapter and the hub. 100 BASE-TX requires two pairs. Some hubs require a cross-over cable while others require a straight-through cable. See the *Cabling* README file for more information on cabling.

The ACT LED doesn't light.

- Make sure you've loaded the correct network drivers.
- The network may be idle. Try accessing a server.
- The network interface or adapter isn't transmitting or receiving data. Try another network interface or adapter.
- May not be using four-pair cable for TX wiring.

7. APPENDIX

The network interface or adapter stopped working when another network interface or adapter was added to the computer.

- Make sure the cable is connected to the motherboard's network interface or RJ45 port.
- Make sure your PCI BIOS is current.
- Make sure the other network interface or adapter supports shared interrupts. Also, make sure your operating system supports shared interrupts — OS/2* doesn't.

The interface stopped working without apparent cause.

- Try reconnecting the cable to the RJ45 port first.
- The network driver files may be corrupt or deleted. Delete and then reinstall the drivers.
- Try another motherboard of the same model.
- Run the diagnostics.

The Wake On LAN feature is not working.

- Make sure the WOL cable is attached and power is applied to the computer.
- Check the BIOS for its WOL setting. Some computers may need to be configured to WOL.
- Make sure the network cable is fully attached to the network interface or adapter.

Link LED does not light when power is connected.

- Make sure WOL cable is attached and power is applied to computer.
- Make sure network cable is attached at both ends.

7. APPENDIX

(This page was intentionally left blank.)

7. APPENDIX

7.4 Glossary

AGP (Accelerated Graphics Port)

An interface specification that enables high-performance 3D graphics on mainstream PCs. AGP offers a higher throughput than PCI by providing the graphics controller with direct access to system memory.

| Bus | Bus Frequency | Bus Speed |
|--------|---------------|-------------|
| PCI | 33MHz | 133MB/s |
| AGP 1X | 66MHz | 200-300MB/s |
| AGP 2X | 133MHz | 528MB/s |
| AGP 4X | 266MHz | 1 GB/s |

AUTOEXEC.BAT

AUTOEXEC.BAT is a special-purpose file that is automatically executed by DOS whenever the computer is turned ON or restarted. This file contains important commands that help configure the system to work with certain software and devices. Windows 95 and later has its own startup files and may not use or may ignore parts of the AUTOEXEC.BAT file.

BIOS (Basic Input/Output System)

BIOS is a set of routines that affect how the computer transfers data between computer components, such as memory, disks, and the display adapter. The BIOS instructions are built into the computer's read-only memory. BIOS parameters can be configured by the user through the BIOS Setup program. The BIOS can be updated using the provided utility to copy a new BIOS file into the EEPROM.

Bit (Binary Digit)

Represents the smallest unit of data used by the computer. A bit can have one of two values: 0 or 1.

Boot

Boot means to start the computer operating system by loading it into system memory. When the manual instructs you to "boot" your system (or computer), it means to turn ON your computer. "Reboot" means to restart your computer. When using Windows 95 or later, selecting "Restart" from "Start | Shut Down..." will reboot your computer.

Bus Master IDE

PIO (Programmable I/O) IDE requires that the CPU be involved in IDE access and waiting for mechanical events. Bus master IDE transfers data to/from the memory without interrupting the CPU. Bus master IDE driver and bus master IDE hard disk drives are required to support bus master IDE mode.

7. APPENDIX

Byte (Binary Term)

One byte is a group of eight contiguous bits. A byte is used to represent a single alphanumeric character, punctuation mark, or other symbol.

COM Port

COM is a logical device name used by to designate the computer serial ports. Pointing devices, modems, and infrared modules can be connected to COM ports. Each COM port is configured to use a different IRQ and address assignment.

CPU (Central Processing Unit)

The CPU, sometimes called “Processor,” actually functions as the “brain” of the computer. It interprets and executes program commands and processes data stored in memory. Currently, there are socket 370 (for Pentium Celeron-PPGA), socket 7 (for Pentium, AMD, Cyrix, IBM), slot 1 (for Pentium II and III), and slot 2 (for Xeon) processors.

Device Driver

A device driver is a special set of instructions that allows the computer’s operating system to communicate with devices such as VGA, audio, ethernet, printer, or modem.

DOS (Disk Operating System)

DOS is the foundation on which all other programs and software applications operate, including Windows. DOS is responsible for allocating system resources such as memory, CPU time, disk space, and access to peripheral devices. For this reason, DOS constitutes the basic interface between you and your computer.

Endian

Endian is a byte order system used in data transfers. In big-endian architectures, the lower addresses are most significant. In little-endian architectures, the higher bytes are most significant. Mainframe computers, such as those by IBM, use a big-endian architecture. Modern PCs use the little-endian system.

Hardware

Hardware is a general term referring to the physical components of a computer system, including peripherals such as printers, modems, and pointing devices.

IDE (Integrated Drive Electronics)

IDE devices integrate the drive control circuitry directly on the drive itself, eliminating the need for a separate adapter card (in the case for SCSI devices). UltraDMA/33 IDE devices can achieve up to 33MB/Sec transfer.

LPT Port (Line Printer Port)

Logical device name reserved by DOS for the computer parallel ports. Each LPT port is configured to use a different IRQ and address assignment.

7. APPENDIX

MMX

A set of 57 new instructions based on a technique called Single Instruction, Multiple Data (SIMD), which is built into the new Intel Pentium PP/MT (P55C) and Pentium II (Klamath) CPU as well as other x86-compatible microprocessors. The MMX instructions are designed to accelerate multimedia and communications applications, such as 3D video, 3D sound, video conference.

PCI Bus (Peripheral Component Interconnect Local Bus)

PCI bus is a specification that defines a 32-bit data bus interface. PCI is a standard widely used by expansion card manufacturers.

Peripherals

Peripherals are devices attached to the computer via I/O ports. Peripheral devices allow your computer to perform an almost limitless variety of specialized tasks.

POST (Power On Self Test)

When you turn on the computer, it will first run through the POST, a series of software-controlled diagnostic tests. The POST checks system memory, the motherboard circuitry, the display, the keyboard, the diskette drive, and other I/O devices.

PS/2 Port

PS/2 ports are based on IBM Micro Channel Architecture. This type of architecture transfers data through a 16-bit or 32-bit bus. A PS/2 mouse and/or keyboard may be used on ATX motherboards.

RAID (Redundant Array of Independent Disks)

RAID can be set up to provide mirroring (for fault tolerance), parity (for data guarding), or striping (for data distribution over several drives for increased performance). A RAID card is required to setup a RAID system.

RAM (Random Access Memory)

There are several different types of RAM such as DRAM (Dynamic RAM), EDO DRAM (Extended Data Output DRAM), SDRAM (Synchronous DRAM).

ROM (Read Only Memory)

ROM is nonvolatile memory used to store permanent programs (called firmware) used in certain computer components. Flash ROM (or EEPROM) can be reprogrammed with new programs (or BIOS).

SCSI (Small Computer System Interface)

High speed parallel interface defined by the X3T9.2 committee of the American National Standards Institute (ANSI) for connecting many peripheral devices.

System Disk

A system disk contains the core file of an operating system and is used to boot up the operating system.

7. APPENDIX

UltraDMA/33

UltraDMA/33 is a new specification to improve IDE transfer rates. Unlike traditional PIO mode, which only uses the rising edge of IDE command signal to transfer data, the DMA/33 uses both rising edge and falling edge. Hence, the data transfer rate is double of the PIO mode 4 or DMA mode 2. (16.6MB/s x2 = 33MB/s).

USB (Universal Serial Bus)

A new 4-pin serial peripheral bus that allows plug and play computer peripherals such as keyboard, mouse, joystick, scanner, printer and modem/ISDN to be automatically configured when they are attached physically without having to install drivers or reboot. With USB, the traditional complex cables from back panel of your PC can be eliminated.

OTHER ASUS PRODUCTS

ASUS[®]

Goes Mobile!

M8300/8200 Series

Thin & Light Convertible Notebook PC

13.3" or 12.1" TFT Color Display
233/266/300/333/366/400+MHz



F7400 Series

Professional Notebook PC

14.1" TFT Color Display
300/333/366/400+MHz
Built-in DVD/MPEG2 Decoder

L7300/7200 Series

All-in-One Compact Notebook PC

13.3" or 12.1" TFT Color Display
300/333/366/400+MHz



OTHER ASUS PRODUCTS

ASUS® Ultra-Fast CD-ROM



- Supports high speed CD-Audio playback
- Supports high speed digital audio extraction
- Supports UltraDMA/33 transfer mode
- Compatible with all CD formats
- Supports multi-read function (CD-R/CD-RW)



| | |
|-----------------------|---|
| Drive Interface Type: | ATAPI/Enhanced IDE supporting PIO mode 4, multi-word DMA mode 2, UltraDMA/33 |
| Disc Formats: | Audio CD, CD-ROM (mode 1 & mode 2), Mixed mode, CD-ROM/XA (mode 2, form 1 & form 2), Video CD, CD-I, Photo CD (single & multi-session), Karaoke CD, CD Extra, I-Trax, CD-R, CD-RW |
| Disk Size: | 8 cm and 12 cm |
| OS Compatibility: | DOS 6.xx, Windows 3.x/95/98, OS/2 Warp, Netware, SCO UNIX |
| Cache Buffer Size: | 128KB |
| Data Transfer Rate: | CD-S500 7500 KBps maximum CD-S450 6750 KBps maximum CD-S400 6000 KBps maximum |
| Access Time: | 75ms |

Free Manuals Download Website

<http://myh66.com>

<http://usermanuals.us>

<http://www.somanuals.com>

<http://www.4manuals.cc>

<http://www.manual-lib.com>

<http://www.404manual.com>

<http://www.luxmanual.com>

<http://aubethermostatmanual.com>

Golf course search by state

<http://golfingnear.com>

Email search by domain

<http://emailbydomain.com>

Auto manuals search

<http://auto.somanuals.com>

TV manuals search

<http://tv.somanuals.com>