

# **ASUS<sup>®</sup>**

## **TS500-E4 Server**

Pedestal/5U Rackmount Server  
User's Manual



E2785

First Edition V1

September 2006

Copyright 2006© ASUSTeK COMPUTER INC. All Rights Reserved.

No part of this manual, including the products and software described in it, may be reproduced, transmitted, transcribed, stored in a retrieval system, or translated into any language in any form or by any means, except documentation kept by the purchaser for backup purposes, without the express written permission of ASUSTeK COMPUTER INC. ("ASUS").

ASUS provides this manual "as is" without warranty of any kind, either express or implied, including but not limited to the implied warranties or conditions of merchantability or fitness for a particular purpose. In no event shall ASUS, its directors, officers, employees, or agents be liable for any indirect, special, incidental, or consequential damages (including damages for loss of profits, loss of business, loss of use or data, interruption of business and the like), even if ASUS has been advised of the possibility of such damages arising from any defect or error in this manual or product.

Specifications and information contained in this manual are furnished for informational use only, and are subject to change at any time without notice, and should not be construed as a commitment by ASUS. ASUS assumes no responsibility or liability for any errors or inaccuracies that may appear in this manual, including the products and software described in it.

Product warranty or service will not be extended if: (1) the product is repaired, modified or altered, unless such repair, modification or alteration is authorized in writing by ASUS; or (2) the serial number of the product is defaced or missing.

Products and corporate names appearing in this manual may or may not be registered trademarks or copyrights of their respective companies, and are used only for identification or explanation and to the owners' benefit, without intent to infringe.

# Contents

Contents .....	iii
Notices .....	viii
Safety information.....	ix
About this guide .....	x
<b>1. Chapter 1: Product Introduction</b>	
1.1 System package contents.....	1-2
1.2 System specifications .....	1-3
1.3 Front panel features.....	1-5
1.4 Rear panel features .....	1-6
1.5 Internal features .....	1-7
1.6 LED information.....	1-9
1.6.1 Front panel LEDs.....	1-9
1.6.2 Rear panel LEDs.....	1-10
<b>2. Chapter 2: Hardware setup</b>	
2.1 Chassis cover .....	2-2
2.1.1 Removing the side cover .....	2-2
2.1.2 Reinstalling the side cover .....	2-3
2.2 Motherboard information.....	2-4
2.3 Central Processing Unit (CPU).....	2-5
2.3.1 Installing the CPU .....	2-5
2.3.2 Installing the CPU heatsink and fan .....	2-8
2.4 System memory .....	2-10
2.4.1 Overview.....	2-10
2.4.2 Memory configurations.....	2-10
2.4.3 Installing a DIMM.....	2-12
2.4.4 Removing a DIMM .....	2-12
2.5 Front panel assembly .....	2-13
2.5.1 Removing the front panel assembly .....	2-13
2.5.2 Reinstalling the front panel assembly.....	2-15
2.6 5.25-inch drives .....	2-16
2.7 Hard disk drives .....	2-19

# Contents

- 2.7.1 Installing a hot-swap SATA/SAS HDD.....2-19
- 2.7.2 Installing an HDD dummy cover.....2-21
- 2.8 Expansion cards ..... 2-22
  - 2.8.1 Installing an expansion card .....2-22
  - 2.8.2 Removing an expansion card .....2-23
- 2.9 Cable connections..... 2-24
  - 2.9.1 Motherboard layouts .....2-24
  - 2.9.2 SATA backplane connections .....2-25
  - 2.9.3 SAS backplane connections.....2-28
- 2.10 Removable components ..... 2-31
  - 2.10.1 Chassis fan .....2-31
  - 2.10.2 HDD blower .....2-33
  - 2.10.3 SATA/SAS backplane .....2-36
  - 2.10.4 MemCool FB-DIMM fan kit ..... 2-38
  - 2.10.5 Floppy disk drive .....2-41
  - 2.10.6 Front I/O board .....2-43
  - 2.10.7 Chassis footpads and roller wheels.....2-45
  - 2.10.8 Power supply unit .....2-47
- 3. Chapter 3: Installation options**
- 3.1 Preparing the system for rack mounting.....3-2
  - 3.1.1 Removing the footpads or roller wheels.....3-2
  - 3.1.2 Removing the top cover .....3-2
  - 3.1.3 Attaching the rack rails .....3-2
- 3.2 Installing ASUS certified CPU heatsink and fan assembly..... 3-3
- 4. Chapter 4: Motherboard information**
- 4.1 Motherboard layouts ..... 4-2
- 4.2 Jumpers..... 4-4
- 4.3 Connectors ..... 4-9
  - 4.3.1 Rear panel connectors.....4-9
  - 4.3.2 Internal connectors.....4-10
- 5. Chapter 5: BIOS information**
- 5.1 Managing and updating your BIOS ..... 5-2
  - 5.1.1 Creating a bootable floppy disk.....5-2

# Contents

5.1.2 Updating the BIOS using the Phoenix Phlash16 Utility .....	5-3
5.1.3 ASUS CrashFree BIOS 2 utility.....	5-4
5.1.4 ASUS Update utility .....	5-6
5.2 BIOS setup program.....	5-9
5.2.1 BIOS menu screen.....	5-10
5.2.2 Menu bar .....	5-10
5.2.3 Legend bar .....	5-11
5.2.4 Menu items.....	5-11
5.2.5 Sub-menu items .....	5-11
5.2.6 Configuration fields .....	5-11
5.2.7 Pop-up window.....	5-12
5.2.8 General help.....	5-12
5.3 Main menu .....	5-13
5.3.1 System Date [Day xx/xx/xxxx].....	5-13
5.3.2 System Time [xx:xx:xx].....	5-13
5.3.3 Floppy A [1.44M, 3.5 in.] .....	5-13
5.3.4 IDE Configuration.....	5-14
5.3.5 IDE Channel 0 Master/Slave; SATA Port 1/2/3/4 .....	5-16
5.3.6 System Information.....	5-17
5.4 Advanced menu.....	5-19
5.4.1 Advanced Processor Options .....	5-19
5.4.2 Chipset Configuration .....	5-21
5.4.3 PCI Configuration.....	5-23
5.4.4 ICH USB Control Sub-Menu .....	5-25
5.4.5 Peripheral Devices Configuration.....	5-26
5.4.6 ACPI Configuration .....	5-28
5.4.7 Power On Configuration .....	5-29
5.4.8 Hardware Monitor.....	5-30
5.5 Server menu.....	5-33
5.5.1 Console Redirection .....	5-33
5.5.2 DMI Event Logging .....	5-35
5.6 Security menu.....	5-36
5.7 Boot menu .....	5-38
5.7.1 Boot Device Priority .....	5-38
5.7.2 Boot Features .....	5-39
5.8 Exit menu.....	5-40

# Contents

## 6. Chapter 6: RAID configuration

- 6.1 Setting up RAID ..... 6-2
  - 6.1.1 RAID definitions .....6-2
  - 6.1.2 Installing hard disk drives.....6-3
  - 6.1.3 Setting the RAID item in BIOS.....6-3
  - 6.1.4 RAID configuration utilities .....6-3
- 6.2 LSI Logic Embedded SATA RAID Setup Utility (Only for PA4 Model)..... 6-4
  - 6.2.1 Creating a RAID 0 or RAID 1 set .....6-5
  - 6.2.2 Creating a RAID 10 set .....6-11
  - 6.2.3 Adding or viewing a RAID configuration .....6-15
  - 6.2.4 Initializing the logical drives.....6-18
  - 6.2.5 Rebuilding failed drives.....6-23
  - 6.2.6 Checking the drives for data consistency .....6-25
  - 6.2.7 Deleting a RAID configuration .....6-28
  - 6.2.8 Selecting the boot drive from a RAID set.....6-29
  - 6.2.9 Enabling the WriteCache .....6-30
- 6.3 Intel® Matrix Storage Manage Option ROM Utility (Only for PA4 model)..... 6-31
  - 6.3.1 Creating a RAID 0 set (Stripe) .....6-32
  - 6.3.2 Creating a RAID 1 set (Mirror).....6-34
  - 6.3.3 Creating a RAID 10 set (Stripe + Mirror) .....6-35
  - 6.3.4 Creating a RAID 5 set (Parity) .....6-36
  - 6.3.5 Deleting a RAID set.....6-37
  - 6.3.6 Resetting disks to Non-RAID.....6-38
  - 6.3.7 Exiting the Intel® Matrix Storage Manager .....6-38
- 6.4 Global Array Manager..... 6-39

## 7. Chapter 7: Driver installation

- 7.1 RAID driver installation..... 7-2
  - 7.1.1 Creating a RAID driver disk .....7-2
  - 7.1.2 Installing the RAID controller driver .....7-3
- 7.2 LAN driver installation..... 7-12
  - 7.2.1 Windows 2000/Server 2003.....7-12
  - 7.2.2 Red Hat/SuSE Linux.....7-16
- 7.3 VGA driver installation..... 7-17

7.3.1 Windows 2000/Server 2003 .....	7-17
<b>Appendix: Reference information</b>	
A.1 670 W single power supply .....	A-2
A.1.1 General description.....	A-2
A.1.2 Specifications .....	A-3
A.2 Simple fixes .....	A-4

# Notices

## Federal Communications Commission Statement

This device complies with Part 15 of the FCC Rules. Operation is subject to the following two conditions:

- This device may not cause harmful interference, and
- This device must accept any interference received including interference that may cause undesired operation.

This equipment has been tested and found to comply with the limits for a Class A digital device, pursuant to Part 15 of the FCC Rules. These limits are designed to provide reasonable protection against harmful interference in a residential installation. This equipment generates, uses and can radiate radio frequency energy and, if not installed and used in accordance with manufacturer's instructions, may cause harmful interference to radio communications. However, there is no guarantee that interference will not occur in a particular installation. If this equipment does cause harmful interference to radio or television reception, which can be determined by turning the equipment off and on, the user is encouraged to try to correct the interference by one or more of the following measures:

- Reorient or relocate the receiving antenna.
- Increase the separation between the equipment and receiver.
- Connect the equipment to an outlet on a circuit different from that to which the receiver is connected.
- Consult the dealer or an experienced radio/TV technician for help.



---

**WARNING!** The use of shielded cables for connection of the monitor to the graphics card is required to assure compliance with FCC regulations. Changes or modifications to this unit not expressly approved by the party responsible for compliance could void the user's authority to operate this equipment.

---

## Canadian Department of Communications Statement

This digital apparatus does not exceed the Class A limits for radio noise emissions from digital apparatus set out in the Radio Interference Regulations of the Canadian Department of Communications.

This Class A digital apparatus complies with Canadian ICES-003.



# Safety information

## Electrical Safety

- Before installing or removing signal cables, ensure that the power cables for the system unit and all attached devices are unplugged.
- To prevent electrical shock hazard, disconnect the power cable from the electrical outlet before relocating the system.
- When adding or removing any additional devices to or from the system, ensure that the power cables for the devices are unplugged before the signal cables are connected. If possible, disconnect all power cables from the existing system before you add a device.
- If the power supply is broken, do not try to fix it by yourself. Contact a qualified service technician or your dealer.

## Operation Safety

- Any mechanical operation on this server must be conducted by certified or experienced engineers.
- Before operating the server, carefully read all the manuals included with the server package.
- Before using the server, make sure all cables are correctly connected and the power cables are not damaged. If any damage is detected, contact your dealer as soon as possible.
- To avoid short circuits, keep paper clips, screws, and staples away from connectors, slots, sockets and circuitry.
- Avoid dust, humidity, and temperature extremes. Place the server on a stable surface.



This product is equipped with a three-wire power cable and plug for the user's safety. Use the power cable with a properly grounded electrical outlet to avoid electrical shock.

### Lithium-Ion Battery Warning

**CAUTION!** Danger of explosion if battery is incorrectly replaced. Replace only with the same or equivalent type recommended by the manufacturer. Dispose of used batteries according to the manufacturer's instructions.

### CD-ROM Drive Safety Warning

**CLASS 1 LASER PRODUCT**

### Heavy System

**CAUTION!** This server system is heavy. Ask for assistance when moving or carrying the system.

# About this guide

## Audience

This user guide is intended for system integrators and experienced users with at least basic knowledge of configuring a server.

## Contents

This guide contains the following parts:

### 1. Chapter 1: Product Introduction

This chapter describes the general features of the server, including sections on front panel and rear panel specifications.

### 2. Chapter 2: Hardware setup

This chapter lists the hardware setup procedures that you have to perform when installing or removing system components.

### 3. Chapter 3: Installation options

This chapter describes how to install optional components into the barebone server.

### 4. Chapter 4: Motherboard information

This chapter gives information about the motherboard that comes with the server. This chapter includes the motherboard layout, jumper settings, and connector locations.

### 5. Chapter 5: BIOS information

This chapter tells how to change system settings through the BIOS Setup menus and describes the BIOS parameters.

### 6. Chapter 6: RAID configuration

This chapter provides information on how to configure your hard disk drives as RAID sets.

### 7. Chapter 7: Driver installation

This chapter provides information on how to create a RAID set and how to install the drivers for system components. This chapter also describes the software applications that the barebone server supports.

### 8. Appendix: Reference information

This section provides information about the power supply unit and a troubleshooting guide for solving common problems when using the barebone server.

# About this guide

## Audience

This user guide is intended for system integrators and experienced users with at least basic knowledge of configuring a server.

## Conventions

To make sure that you perform certain tasks properly, take note of the following symbols used throughout this manual.



---

**WARNING:** Information to prevent injury to yourself when trying to complete a task.

---



---

**CAUTION:** Information to prevent damage to the components when trying to complete a task.

---



---

**IMPORTANT:** Instructions that you **MUST** follow to complete a task.

---



---

**NOTE:** Tips and information to aid in completing a task.

---

## References

Refer to the following sources for additional information, and for product and software updates.

### 1. ASUS Server Web-based Management (ASWM) user guide

This manual tells how to set up and use the proprietary ASUS server management utility.

### 2. ASUS websites

The ASUS websites worldwide provide updated information for all ASUS hardware and software products. Refer to the ASUS contact information.



# Chapter 1

This chapter describes the general features of the chassis kit. It includes sections on front panel and rear panel specifications.



# 1.1 System package contents

Check your system package for the following items.

Item Description	Configuration	
	PA4	PX4
1) ASUS T30 pedestal 5U rackmount chassis with:		
ASUS DSBV-D motherboard	•	•
670 W single power supply	•	•
SATA backplane board	•	
SAS* backplane board		•
SAS control card		•
SATA Cable (4 pcs.)	•	
SAS Cable (1 pcs.)		•
CD-ROM or DVD-ROM drive	•	•
Floppy disk drive	•	•
Chassis fan	•	•
HDD blower	•	•
MemCool FB-DIMM fan kit	•	•
Hot-swap HDD trays (including HDD screws)	•	•
Chassis roller wheels (4 sets)	•	•
Front I/O board	•	•
SMBus cable	•	•
Dummy Covers (2 pcs.)	•	•
Parallel port cable (1 pcs)	•	•
2) AC power cable		
3) System screws and cables		
4) System keys ( 2 pcs.)		
5) Bundled CDs		
TS500-E4 support CD with ASWM**	•	•
Computer Associates eTrust anti-virus CD	•	•
SAS/RAID control card drivers CD with user guide		•
6) Documentation		
ASUS TS500-E4 user guide	•	•
ASUS ASWM 2.0 user guide	•	•
7) Optional items		
ASUS AK25 rackmount rail kit	•	•
ASUS certified heatsink and fan assembly	•	•

\* Serial-Attached SCSI

\*\* ASUS System Web-based Management



Contact your dealer immediately if any of the items is damaged or missing.

## 1.2 System specifications

The ASUS TS500-E4 is a pedestal/5U barebone server system featuring the ASUS DSBV-D motherboard. The server supports dual Intel LGA771 Xeon processors with EM64T technology, plus other latest technologies through the chipsets onboard.

Chassis	Pedestal/Rackmount 5U
Motherboard	ASUS DSBV-D
Chipset	North Bridge: Intel® 5000V MCH South Bridge: Intel® 6321ESB ICH
CPU	Supports Dual LGA771 sockets Intel® Xeon processors Supports Dual-Core Xeon Dempsey1066/Woodcrest1333/ Clovertown1066 processor Supports 667/1066/1333MHz FSB(Front Sied Bus)
Memory	6 x DDRII Fully Buffer DIMM (FBDIMM) sockets support ECC DDRII-667/533 MHz memory modules Supports 512MB up to 24GB system memory
LAN	2 x Gigabit LAN (Intel® 82563EB PCI-E Gigabit LAN controller)
VGA	ATI ES1000 VGA controller Supports 32MB display memory
Storage	4 x Hot-Swap SATA2(PA4 & PX4 Model)/SAS(PX4 Model Only) HDDs bay 3 x 5.25" Drive bay, 1 x 1.44MB FDD bay
RAID	Intel® 6321ESB ICH controller supports(PA4 Model Only): - Intel Matrix Storage (Windows) support RAID 0, RAID 1, RAID 0+1, RAID5(S/W) - LSI MegaRAID(Linux/Windows) support RAID 0, RAID 1, RAID 0+1 LSI SA3442X-R HBA supports(PX4 Model Only): - RAID 0, RAID 1 and RAID 1E
Expansion slots	1 x 32-bit/33MHz/5V PCI slot 3 x 64-bit/133/100MHz 3V PCI-X slots 1 x PCI-Express x16 slot (x8 link) 1 x PCI-Express x8 slot ( x4 link) 1 x SO-DIMM for ASUS ASMB3-SOL Management Board (Optional)
Front panel	4 x 3.5-inch hot-swappable SAS/SATA-II HDD bays 1 x optical drive 2 x USB 2.0 ports Power switch Reset switch LEDs: Power, HDD access, message Drive LEDs: Status, activity

(continued on the next page)

Rear panel	1 x PS/2 keyboard port 1 x PS/2 mouse port 1 x Serial port 1 x VGA port 2 x USB 2.0 ports 2 x RJ-45 ports (with LEDs) 1 x Power connector
Management	ASUS Server Web-based Management (ASWM)
Hardware support	SM-Bus, ASMB3 supports IMIP 2.0 LAN management card
Hardware monitors	Voltage, temperature, and fan speed monitoring Automatic System Restart (ASR) feature
Power supply	670W single power supply, 100V~240V, 50Hz~60Hz
Dimensions	431 mm (H) x 220mm (W) x 510mm (D)

Specifications are subject to change without notice.



## 1.3 Front panel features

The barebone server displays a simple and stylish front panel with easily accessible features.

The drive bays, power and reset buttons, LED indicators, optical drive, floppy drive, and USB 2.0 ports are located on the front panel. For future installation of 5.25-inch devices, two drive bays are available.



# 1.4 Rear panel features

The rear panel includes a slot for the motherboard rear I/O ports, expansion slots, a chassis lock and intrusion switch, a vent for the system fan, and power supply module.

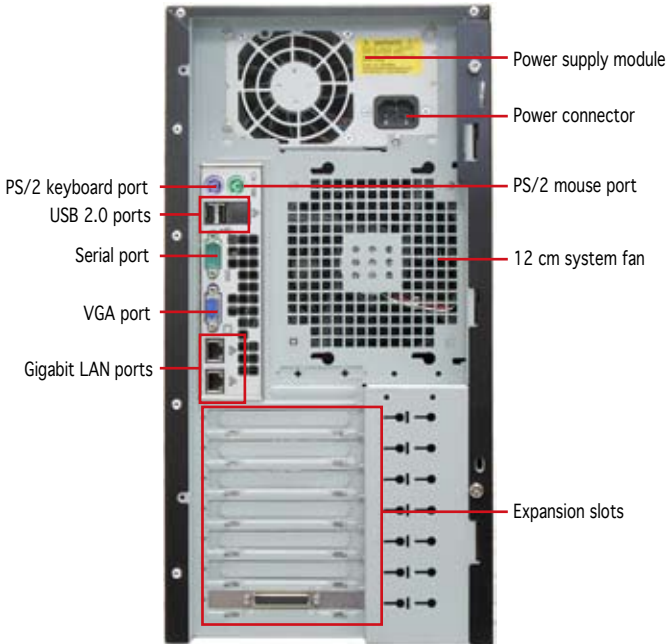

## 1.5 Internal features

The barebone server system includes the basic components as shown. The photo below shows the TS500-E4 with the disk blower installed.

### PA4 (4 hot-swap SATA configuration)



- |                             |                                      |
|-----------------------------|--------------------------------------|
| 1. Power supply unit        | 6. Optical drive                     |
| 2. Chassis fan              | 7. 2 x5.25-inch drive bays           |
| 3. ASUS DSBV-D Motherboard  | 8. HDD blower(HDD drive cage inside) |
| 4. Chassis intrusion switch | 9. SATA2 backplane(PA4 Model Only)   |
| 5. Expansion card locks     | 10. Front I/O board                  |

## PX4 (4 hot-swap SAS configuration)

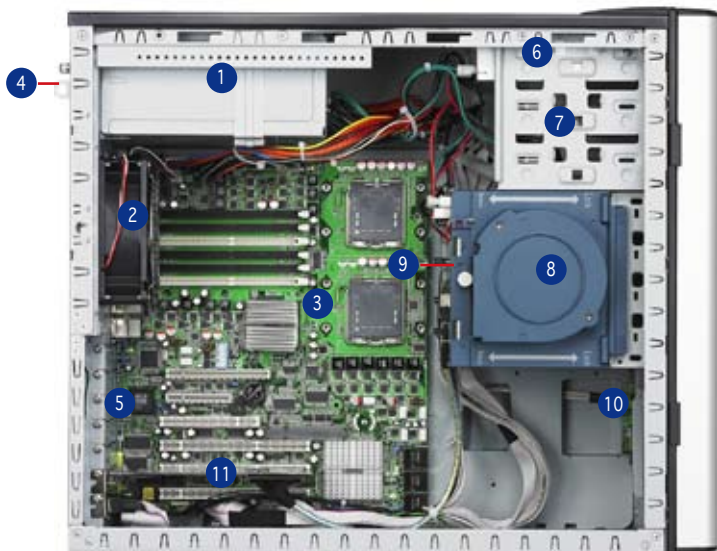

- |                             |                                      |
|-----------------------------|--------------------------------------|
| 1. Power supply unit        | 7. 2 x 5.25-inch drive bays          |
| 2. Chassis fan              | 8. HDD blower(HDD drive cage inside) |
| 3. ASUS DSBV-D Motherboard  | 9. SAS backplane(PX4 Model Only)     |
| 4. Chassis intrusion switch | 10. Front I/O board                  |
| 5. Expansion card locks     | 11. SAS control card                 |
| 6. Optical drive            |                                      |

# 1.6 LED information

## 1.6.1 Front panel LEDs

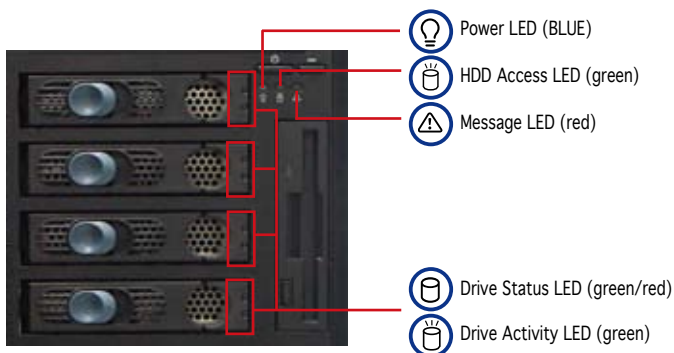

LED	ICON	Display status	Description
<b>System</b>			
Power LED		ON Blinking	System power ON System is in suspend mode
HDD Access LED		OFF Blinking	No activity Read/write data into the HDD
Message LED		OFF Blinking	System is normal ; no incoming event ASWM detects a HW monitor event
<b>Hard disk drives</b>			
Drive Status LED		Green  Red Green/Red - Blinking	Bridge board connected to backplane Installed HDD is in good condition HDD failure (PX4 model only) HDD rebuilding using the RAID card (PX4 model only)
Drive Activity LED		Blinking	Read/write data into the HDD (PX4 model only)



The Power, HDD Access, and Message LEDs are visible even if the system front bezel is closed.

## 1.6.2 Rear panel LEDs

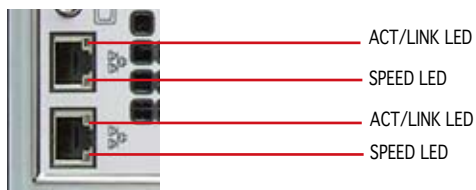

ACT/LINK LED		SPEED LED	
Status	Description	Status	Description
OFF	No link	OFF	10Mbps connection
Green	Linked	Orange	100Mbps connection
Blinking	Data activity	Green	1000Mbps connection

# Chapter 2

This chapter lists the hardware setup procedures that you have to perform when installing or removing system components.



## 2.1 Chassis cover

The chassis features a “screwless design” that allows convenient assembly and disassembly. You can simply push or slide mechanical bolts and locks to remove the cover.

### 2.1.1 Removing the side cover

1. Remove the two screws that secure the cover to the chassis.

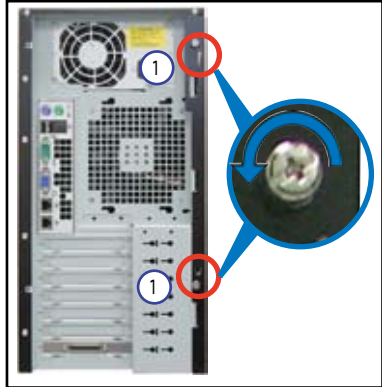

2. Slide the side cover for about half an inch toward the rear until it is disengaged from the chassis.
3. Carefully lift the cover and set it aside.



### Viewing the internal structure

Without the side cover, the internal structure and installed components of the barebone server vary depending on the model you purchased. Refer to section “1.5 Internal features” for the different model configurations.

Perform the procedures in the succeeding sections to install the CPU, system memory, disk drives, and expansion cards; replace fans and power supply; and connect the system cables.





You may need to remove some of the installed components to access the DIMM sockets and internal connectors. Refer to section “2.10 Removable components” for instructions.

## 2.1.2 Reinstalling the side cover

To reinstall the side cover:

1. Match and insert the upper hooks and lower sliding edge of the cover to the corresponding chassis holes and edge.
2. Slide the cover toward the front until it snaps in place.

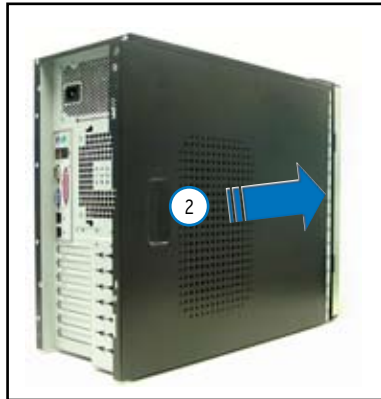

3. Drive in the two screws you removed earlier to secure the side cover.

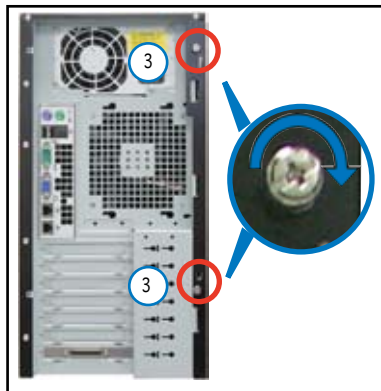

## 2.2 Motherboard information

The barbone server comes with the DSBV-D motherboard already installed. The motherboard is secured to the chassis by six (6) screws as indicated by the circles in the illustration below.



Refer to "Chapter 4 Motherboard information" for detailed information on the motherboard.

Place this side towards the rear of the chassis

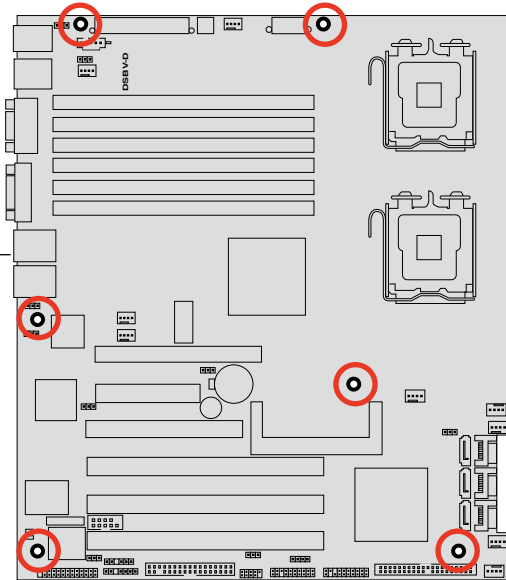

Make sure to unplug the chassis power cord before installing or removing the motherboard. Failure to do so can cause you physical injury and damage motherboard components!

## 2.3 Central Processing Unit (CPU)

The motherboard comes with a surface mount LGA771 socket designed for the Intel® Xeon® Dual Core processor.



- Your boxed Intel® Xeon® LGA771 processor package should come with installation instructions for the CPU and heatsink. If the instructions in this section do not match the CPU documentation, follow the latter.
- Upon purchase of the motherboard, make sure that the PnP cap is on the socket and the socket contacts are not bent. Contact your retailer immediately if the PnP cap is missing, or if you see any damage to the PnP cap/socket contacts/motherboard components. ASUS will shoulder the cost of repair only if the damage is shipment/transit-related.
- Keep the cap after installing the motherboard. ASUS will process Return Merchandise Authorization (RMA) requests only if the motherboard comes with the cap on the LGA771 socket.
- The product warranty does not cover damage to the socket contacts resulting from incorrect CPU installation/removal, or misplacement/loss/incorrect removal of the PnP cap.

### 2.3.1 Installing the CPU

To install a CPU:

1. Locate the CPU socket on the motherboard.

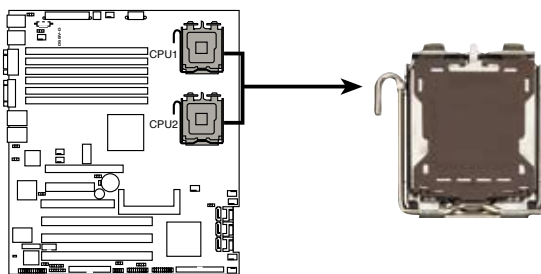

**DSBV-D CPU LGA771**



Before installing the CPU, make sure that the socket box is facing towards you and the load lever is on your left.

2. Press the load lever with your thumb (A), then move it to the left (B) until it is released from the retention tab.

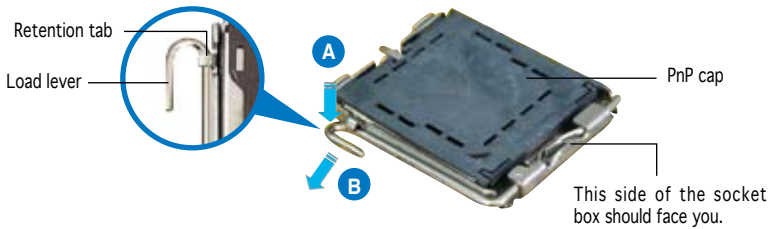

To prevent damage to the socket pins, do not remove the PnP cap unless you are installing a CPU.

3. Lift the load lever in the direction of the arrow to a 135° angle.

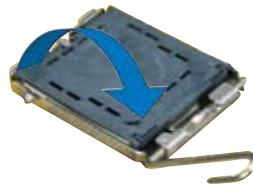

4. Lift the load plate with your thumb and forefinger to a 100° angle (A), then push the PnP cap from the load plate window to remove (B).

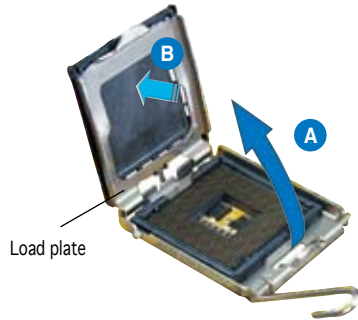

5. Position the CPU over the socket, making sure that the gold triangle is on the bottom-left corner of the socket. The socket alignment key should fit into the CPU notch.

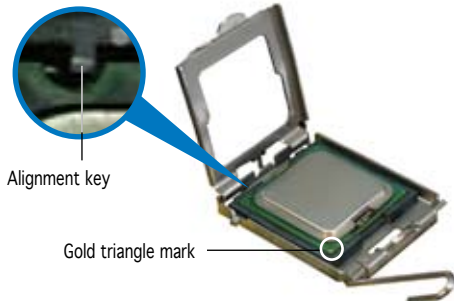

6. Close the load plate (A), then push the load lever (B) until it snaps into the retention tab.

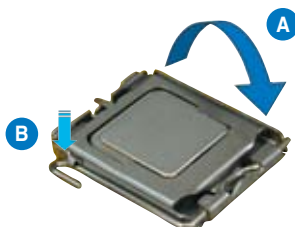

The CPU fits in only one correct orientation. DO NOT force the CPU into the socket to prevent bending the connectors on the socket and damaging the CPU!

## Notes on Intel® Hyper-Threading Technology



- This motherboard supports Intel® Xeon™ CPUs in the 771-land package with Hyper-Threading Technology.
- Hyper-Threading Technology is supported by Intel® 5000 series CPU only. 5100 series DO NOT support Hyper-Threading.
- Hyper-Threading Technology is supported under Windows® XP/2003 Server and Linux 2.4.x (kernel) and later versions only. Under Linux, use the Hyper-Threading compiler to compile the code. If you are using any other operating systems, disable the Hyper-Threading Technology item in the BIOS to ensure system stability and performance.
- Installing Windows® 2003 Server or later version is recommended.
- Make sure to enable the Hyper-Threading Technology item in BIOS before installing a supported operating system.
- For more information on Hyper-Threading Technology, visit [www.intel.com/info/hyperthreading](http://www.intel.com/info/hyperthreading).

To use the Hyper-Threading Technology on this motherboard:

1. Install an Intel® Xeon™ CPU that supports Hyper-Threading Technology.
2. Power up the system and enter the BIOS Setup (see Chapter 5: BIOS information). Under the Advanced Menu, make sure that the item Hyper-Threading Technology is set to Enabled. The item appears only if you installed a CPU that supports Hyper-Threading Technology.
3. Reboot the computer.

## 2.3.2 Installing the CPU heatsink and fan

The Intel® Xeon™ processors require an Intel certified or ASUS qualified heatsink and fan assembly to ensure optimum thermal condition and performance.

When you buy a boxed Intel CPU, the package includes the heatsink, fan, retention brackets, screws, thermal grease, installation manual, and other items that are necessary for CPU installation.



- Make sure that you have applied the thermal grease to the top of the CPU before installing the heatsink and fan.
- Refer to the installation manual that came with the CPU package for details on heatsink/fan assembly and installation.
- For installation instruction of optional ASUS qualified CPU heatsink and fan assembly, refer to section 3.2.

CPU heatsink (top view)



CPU heatsink (bottom view)

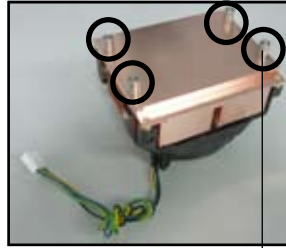

Heatsink screw



Before installing the CPU heatsinks, ensure that the jumpers DIP\_SW1 are set correctly depending on the pin definition of your CPU fan cables. Refer to page 4-8 for information on these jumpers.

To install the CPU heatsink and fan:

1. Place the heatsink on top of the installed CPU, making sure that the four screws on the heatsink align with the nuts on the support plate.

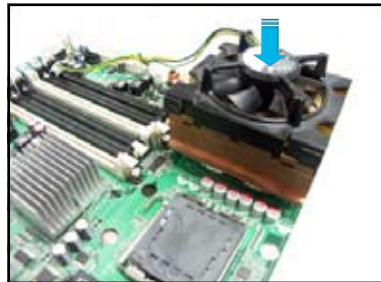

2. Use a Phillips screwdriver to tighten the four heatsink screws in a diagonal sequence.

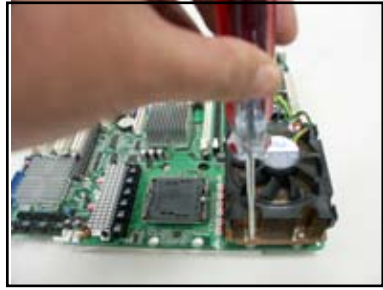

3. Connect the fan cable to the 4-pin connector labeled CPU\_FAN1.



Do not forget to connect the CPU fan cable! Hardware monitoring errors may occur if you fail to plug this connector.

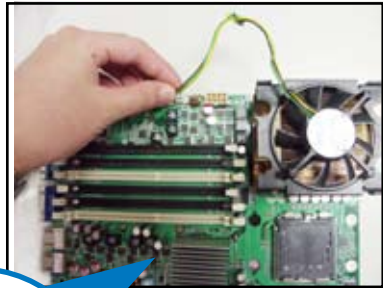

CPU\_FAN1  
connector

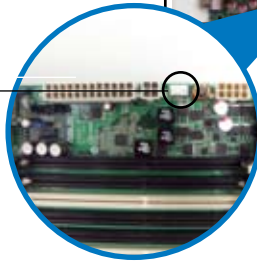

4. Repeat steps 1 to 3 to install the other heatsink if you have installed a second CPU, then connect the fan cable to the 4-pin connector labeled CPU\_FAN2.

## 2.4 System memory

### 2.4.1 Overview

The motherboard comes with six fully-buffered DIMM (FB-DIMM) sockets to support 240-pin FB-DIMM modules. An FB-DIMM module has a different pin-out from DDR2 DIMMs so you cannot install DDR2 DIMMs on an FB-DIMM socket. Note that an FB-DIMM socket has an Advanced Memory Buffer (AMB) chip that allows memory-to-CPU connection at gigabit speed.

The figure illustrates the location of the FB-DIMM sockets:

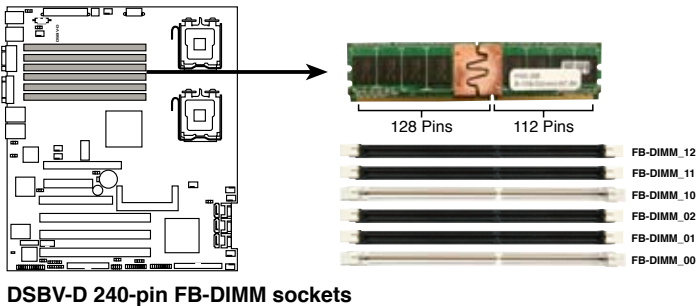

### 2.4.2 Memory configurations

You may install 256 MB, 512 MB, 1 GB, 2 GB, and 4 GB registered ECC FB-DIMMs into the DIMM sockets.



- For optimum compatibility, we recommend that you obtain memory modules from the same vendor. Refer to the Qualified Vendors List on the ASUS web site.
- This motherboard does not support memory modules made up of 128 Mb chips or double-rank x16 memory modules.
- If you are installing only one memory module, install into the white socket labeled DIMM\_00. Installing into any other socket will not work.



## Rank population

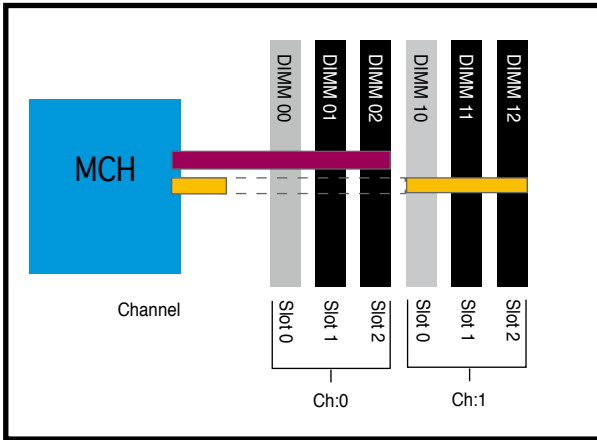

### DIMM installation reference table

No. of DIMMs	Slot/s to use
1	DIMM_00
2	DIMM_00, DIMM_10
4	DIMM_00, DIMM_01, DIMM_10, DIMM_11
6	DIMM_00, DIMM_01, DIMM_02, DIMM_10, DIMM_11, DIMM_12



- DIMMs in pair means two DIMMs with the same configuration.
- For better performance, same configuration DIMMs should be installed on the same slot number for each channel. For example, you may install the same type of DIMMs in DIMM\_00, and DIMM\_10.

## 2.4.3 Installing a DIMM



Make sure to unplug the power supply before adding or removing DIMMs or other system components. Failure to do so may cause severe damage to both the motherboard and the components.



Before accessing the DIMM sockets, you have to remove the FB-DIMM fan kit. Refer to section "2.10 Removable components" for instructions.

To install a DIMM:

1. Unlock a DIMM socket by pressing the retaining clips outward.
2. Align a DIMM on the socket such that the notch on the DIMM matches the break on the socket.
3. Firmly insert the DIMM into the socket until the retaining clips snap back in place and the DIMM is properly seated.

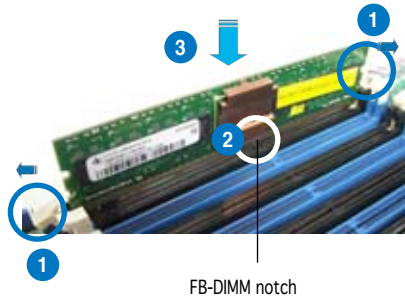

- A FB-DIMM is keyed with a notch so that it fits in only one direction. Do not force a DIMM into a socket to avoid damaging the DIMM.
- The sockets do not support DDR/DDR2 DIMMs. DO NOT install DDR/DDR2 DIMMs to the FB-DIMM sockets.

## 2.4.4 Removing a DIMM

To remove a DIMM:

1. Simultaneously press the retaining clips outward to unlock the DIMM.



Support the DIMM lightly with your fingers when pressing the retaining clips. The DIMM might get damaged when it flips out with extra force.

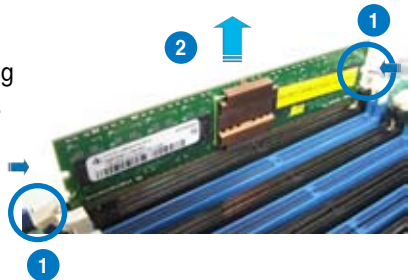

2. Remove the DIMM from the socket.

## 2.5 Front panel assembly

### 2.5.1 Removing the front panel assembly



Before you can install a 5.25-inch drive, you should first remove the front panel assembly (front bezel and front panel cover). The front panel assembly is attached to the chassis through three hooked tabs on the left side and four hinge-like tabs on the right side.

To remove the front panel assembly:

1. Locate the four hooked tabs on the chassis side rail.
2. Press each lock tab to release the front panel from the chassis.

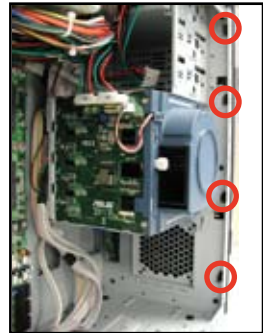

3. Pull and swing the left edge of the front panel outward.



4. Unhook the hinge-like tabs from the holes on the right side of the front panel to completely detach the front panel assembly from the chassis.



---

Do not use too much force when removing the front panel assembly.

---

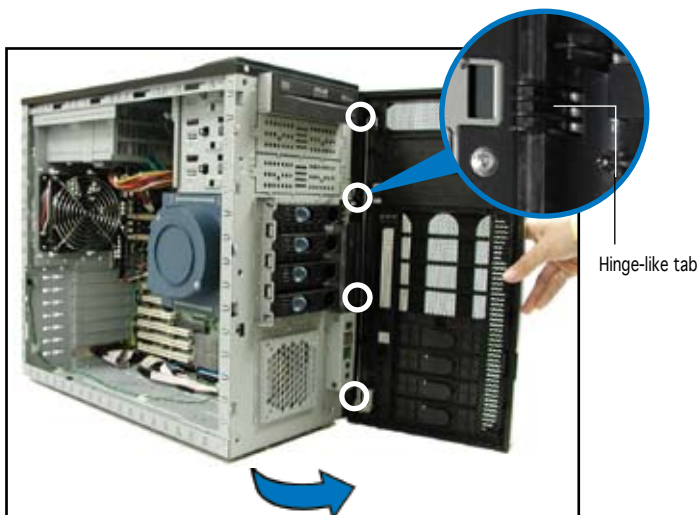

## 2.5.2 Reinstalling the front panel assembly

To reinstall the front panel assembly (front bezel and front panel cover):

1. Insert the four hinge-like tabs to the holes on the right edge of the chassis.
2. Swing the front panel to the left and fit the four (4) hooked tabs to the left side of the chassis until the tabs snap back in place.

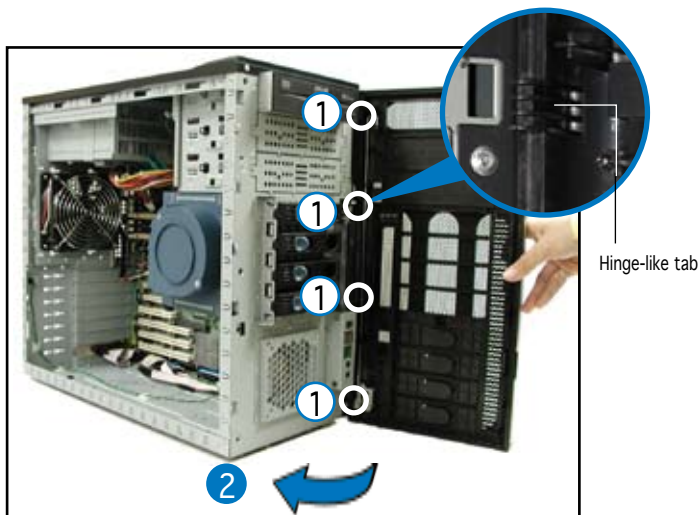

## 2.6 5.25-inch drives



If you have previously used and powered up the system, and that it may be connected to an AC power source, make sure to unplug the power cable before installing or removing any system components. Failure to do so may cause damage to the motherboard and other system components!

Three 5.25-inch drive bays are located on the upper front part of the chassis. An optical drive that comes standard with the system package occupies the uppermost bay (labeled 1). The two lower bays (labeled 2 and 3) are available for additional 5.25-inch devices.



To install a 5.25-inch drive:

1. Use a Phillips (cross) screwdriver to remove the screws that secure the metal cover of the bay where you want to install the drive.

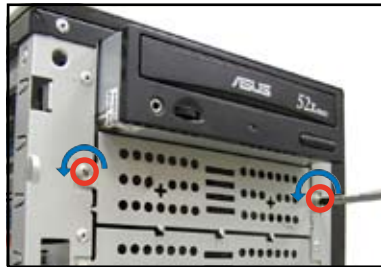

2. Insert the optical drive into the 5.25-inch drive bay.



3. Make sure that the drive and bay hole align as shown. When in place, the drive protrudes about an inch from the front panel.



4. Secure the drive with a screw.



5. Connect the IDE cable to the IDE connector on the back of the drive.
6. Connect a 4-pin plug from the power supply to the power connector on the back of the drive.

IDE cable



Power plug

7. On the front panel assembly, detach the plastic bay cover opposite the 5.25-inch drive that you installed by pressing the two hooked tabs on each side of the bay cover.

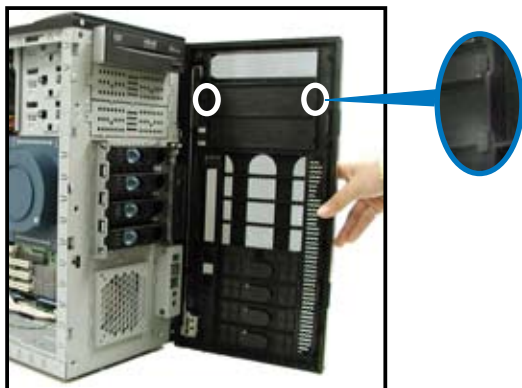

8. Reinstall the front panel assembly when done. Refer to section “2.5.2 Reinstalling the front panel assembly” for instructions.



## 2.7 Hard disk drives

### 2.7.1 Installing a hot-swap SATA/SAS HDD

Follow the instructions in this section to install a hot-swap SATA (PA4 & PX4 model) or SAS (PX4 model) hard disk drive (HDD).

1. Open the front bezel to access the hot-swap drive trays.
2. Release a drive tray by pushing the spring lock to the right, then pulling the tray lever outward. The drive tray ejects slightly after you pull out the lever.



3. Firmly hold the tray lever and pull the drive tray out of the bay.

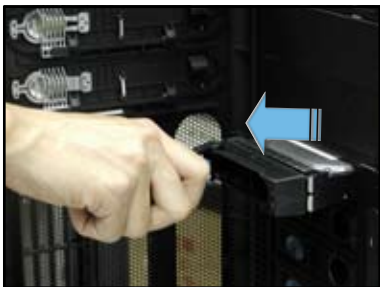

4. An empty drive tray requires a metal bracket for support. Use a Phillips (cross) screwdriver to remove the bracket when you are ready to install a hard disk in the drive tray.

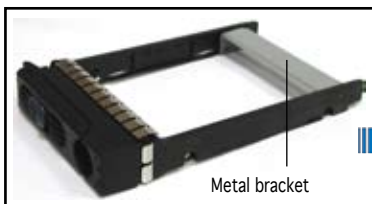

5. Place a SATA or SAS hard disk to the drive tray, and secure it with four screws.



6. Carefully insert drive tray and push it all the way to the depth of the bay until just a small fraction of the tray edge protrudes.

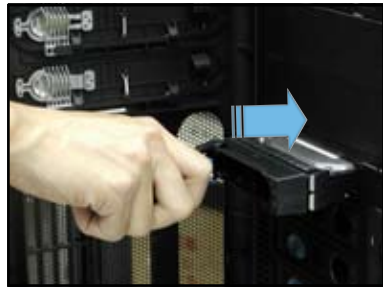

7. Push the tray lever until it clicks, and secures the drive tray in place. The drive tray is correctly placed when its front edge aligns with the bay edge.



## 2.7.2 Installing an HDD dummy cover

The HDD dummy covers come pre-installed on the front panel bezel. In case you removed the covers, follow these steps to re-install them.

To install an HDD dummy cover:

1. From the inside of the front panel assembly, insert the flat end of a dummy cover into the slot as shown. The end with the hook tab should be close to the front panel LEDs.



Flat end

2. Press the dummy cover into the slot opening until the hook tab clicks in place.

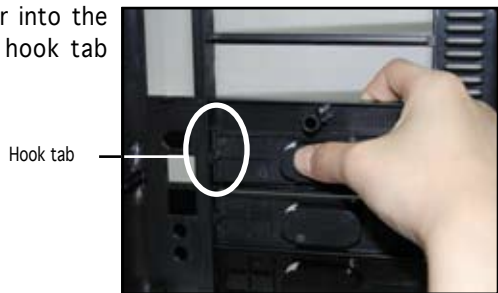

3. When installed, the dummy cover appears as shown.



## 2.8 Expansion cards

Refer to this section when installing expansion cards.



Make sure to unplug the power cord before installing or removing expansion cards. Failure to do so may cause physical injury, and damage to the card and motherboard components!

### 2.8.1 Installing an expansion card

To install an expansion card:

1. Lay the chassis on its side.
2. Locate the metal bracket opposite the slot you want to use.  
Remove the screw that secures the metal bracket to the chassis. Set aside the metal bracket for future use.

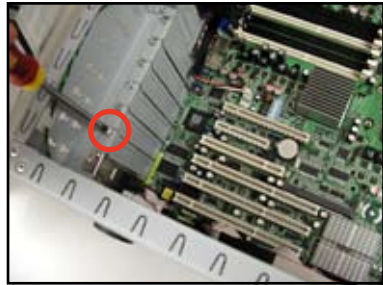

3. Align the card golden fingers to the slot and its metal bracket to the slot opening on the chassis.
4. Press the card firmly until it is properly seated on the slot.

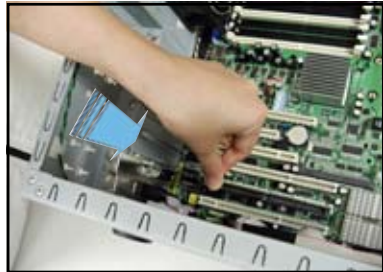

5. Secure the card to the chassis with the bracket screw you removed earlier.

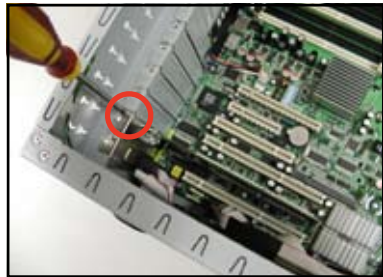

## 2.8.2 Removing an expansion card

To remove an expansion card:

1. Remove the screw that secures the card to the chassis.

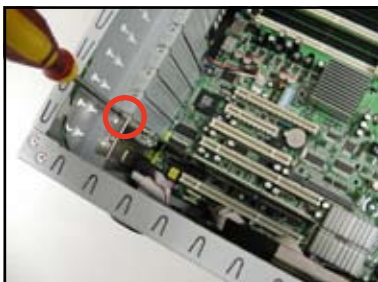

2. Carefully remove the card from the slot.

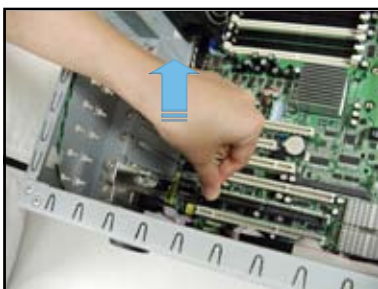

3. Reinstall the metal bracket and secure it to the chassis with the screw that you removed earlier.



## 2.9 Cable connections



- The bundled system cables are pre-connected before shipment. You do not need to disconnect these cables unless you will remove pre-installed components to install additional devices.
- Refer to Chapter 4 for detailed information on the connectors.

### 2.9.1 Motherboard layouts

#### DSBV-D

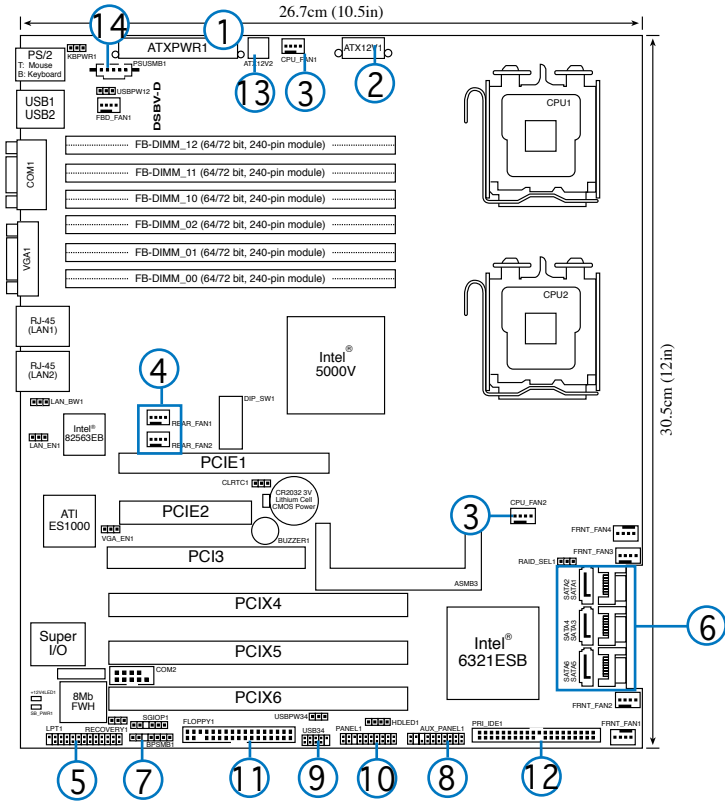

#### Standard cables connected to the motherboard

- |                               |                                 |
|-------------------------------|---------------------------------|
| 1. 24-pin ATX power           | 8. Auxiliary panel cable        |
| 2. 8-pin 12V power            | 9. Front USB cable              |
| 3. CPU fan 1/2                | 10. Front panel cable           |
| 4. Rear fan 1/2               | 11. Floppy disk drive           |
| 5. Parallel port module cable | 12. Primary IDE cable           |
| 6. Serial ATA connectors      | 13. 4-pin 12V power             |
| 7. SBus connector             | 14. Power supply SBus connector |

## 2.9.2 SATA backplane connections

### (in PA4 model only)

A SATA backplane comes pre-installed in the TS500-E4/PA4 model. The SATA backplane has four 22-pin SATA connectors to support Serial ATA hard disk drives. The backplane design incorporates a hot swap feature to allow easy connection or removal of SATA hard disks. The LEDs on the backplane connect to the front panel LEDs to indicate HDD status. See section “1.6 LED information” for details.

### Front side

The front side of the SATA backplane faces the front panel when installed. This side includes four SATA connectors for the hot swap drive trays.

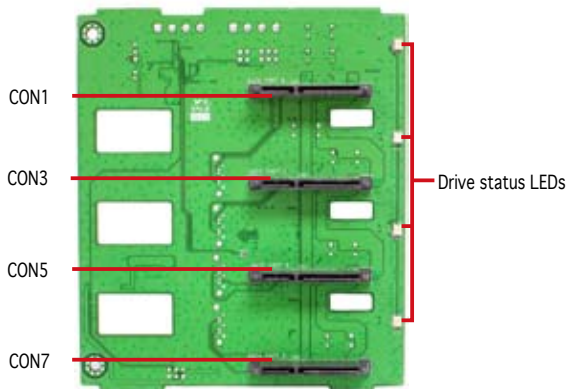

Each SATA connector is labeled (CON1, CON3, CON5, CON7) so you can easily determine their counterpart connectors at the back side of the backplane. Refer to the table for reference.

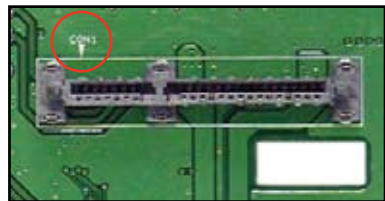

HDD Device	Front side connector	Back side connector
HDD 1	CON1	CON2
HDD 2	CON3	CON4
HDD 3	CON5	CON6
HDD 4	CON7	CON8

## Back side

The back side of SATA backplane faces the rear panel when installed. This side includes the power connectors, SATA interfaces for the motherboard Serial ATA connectors or the SATA/RAID card, an HDD fan connector, and SMBus connectors.

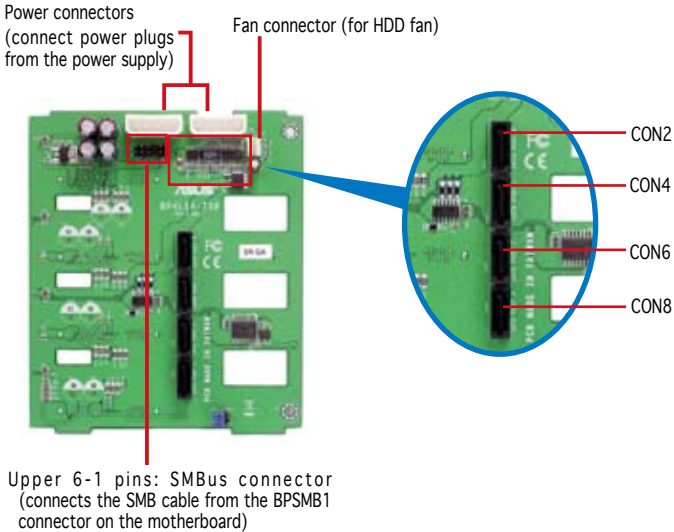

The back side SATA connectors are attached to the motherboard SATA connectors via the supplied SATA cables. Refer to the illustration below for the location of the SATA connectors. Refer to the table on the right for the default SATA cable connections.

Backplane ID	Connected to (on motherboard)	Controlled by
CON2	SATA1	Intel® 6321ESB
CON4	SATA2	Intel® 6321ESB
CON6	SATA3	Intel® 6321ESB
CON8	SATA4	Intel® 6321ESB

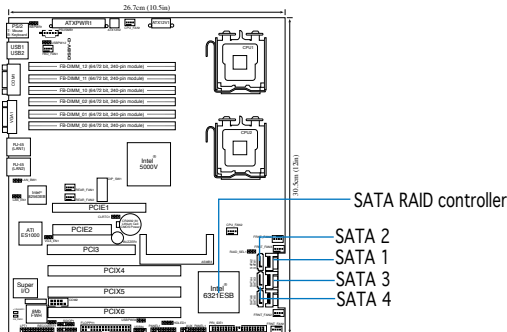



## SATA backplane jumper settings and HDD ID assignments

The 6-pin jumper J3 allows you to define your desired SATA configuration. The picture below shows the location of jumper J3 with pins 1-3 and 2-4 shorted.

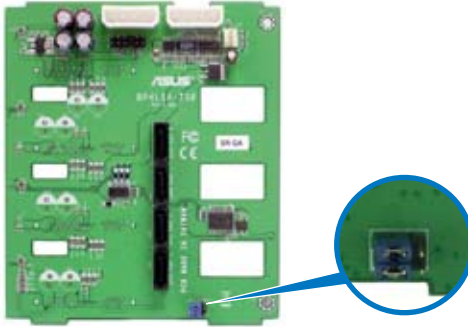

Refer to the table for the jumper settings and the appropriate ID# for each SATA HDD bay.

J3 setting (1-3 shorted, 2-4 shorted)	
Device	SATA ID #
Drive Bay 1	ID0
Drive Bay 2	ID1
Drive Bay 3	ID2
Drive Bay 4	ID3

## 2.9.3 SAS backplane connections

### (in PX4 model only)

A SAS backplane comes pre-installed in the TS500-E4/PX4 model. The SAS backplane has four 29-pin SAS connectors to support SAS hard disks. The backplane design incorporates a hot swap feature to allow easy connection or removal of SAS hard disks. The LEDs on the backplane connect to the front panel LEDs to indicate HDD access, HDD failure, thermal failure, or fan failure. See section “1.6 LED information.”

### Front side

The front side of the SAS backplane faces the front panel when installed. This side includes four SAS connectors for the hot swap drive trays.

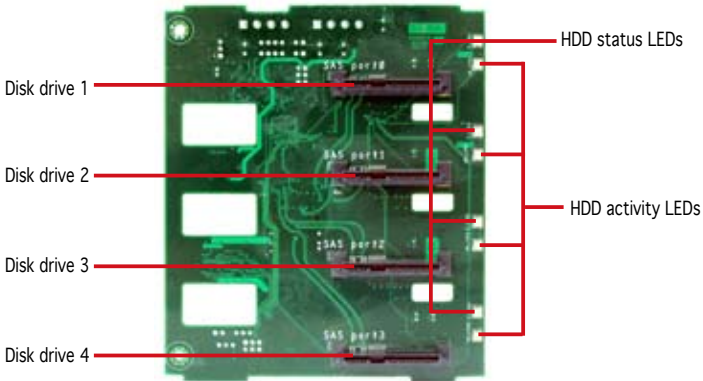

## Back side

The back side of SAS backplane faces the rear panel when installed. This side includes the power connectors, SAS interfaces for the motherboard SAS connector or the SAS control card, an HDD fan connector, and SMBus connectors.

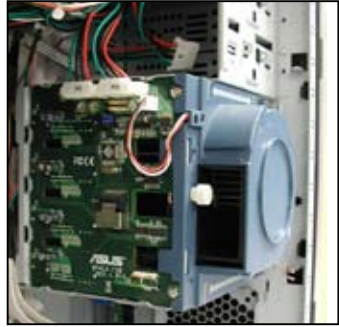

- the SAS interface of the backplane connects to a SAS/RAID card.

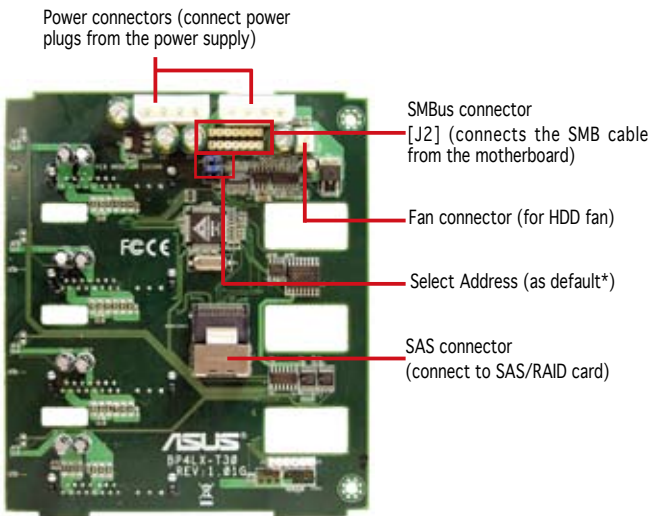

\* Select Address - You do not have to change these jumpers. Please keep the jumpers as default.

## Connect to SAS/RAID card

1. Connect the SAS cable to the SAS control card.

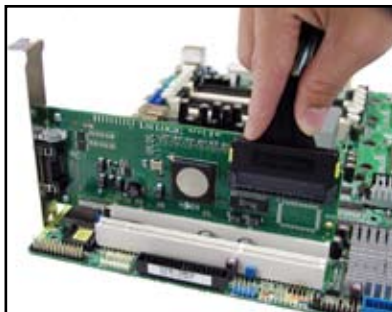

2. Then connect another side of the SAS cable to the SAS backplane.



3. The picture shows the SAS backplane connects to SAS control card.



- For more detailed instruction about the SAS/RAID card, refer to its user guide.
- The pictures of the SAS/RAID card above illustrate the LSI SAS3442X-R card only.

## 2.10 Removable components

You may need to remove previously installed system components when installing or removing system devices, or when you need to replace defective components. This section tells how to remove the following components:

1. Chassis fan
2. HDD blowers
3. SATA/SAS backplanes
4. MemCool FB-DIMM fan kit
5. Floppy disk drive module
6. Front I/O board
7. Chassis footpads and roller wheels
8. Power supply unit

### 2.10.1 Chassis fan

To remove the chassis fan:

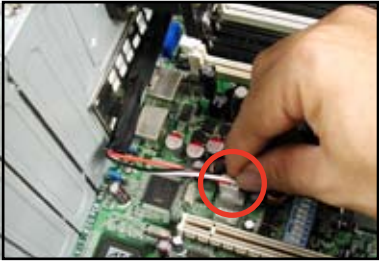
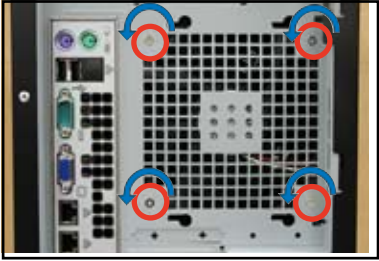
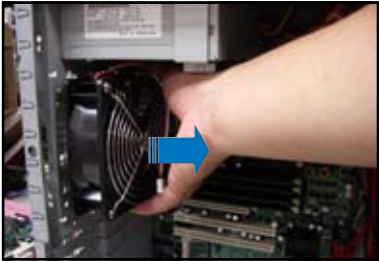
1. Unplug the chassis fan cable from the REAR\_FAN1 connector on the motherboard.
2. Locate the four screws that secure the fan to the chassis.
3. Remove the four screws while carefully supporting the chassis fan with your free hand to prevent it from falling off. Set the screws aside.
4. Carefully remove the chassis fan.

5. Remove the four screws that secure the metal shroud to the fan. Set the screws aside.

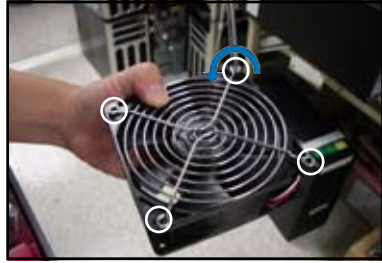

To reinstall the chassis fan:

1. Drive in the four screws you removed earlier into the fan screw holes to secure the metal shroud to the fan.

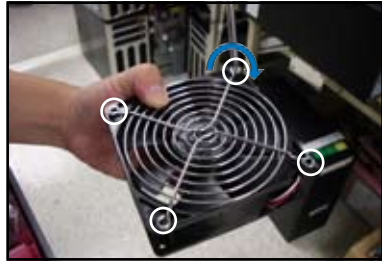

1. Align the chassis fan holes to the screw holes on the chassis.

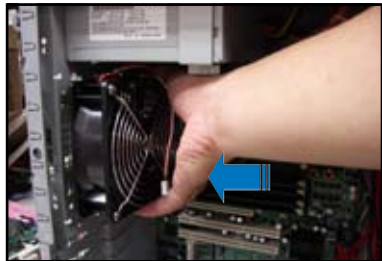

2. Drive in the four screws you removed earlier to secure the fan to the chassis.

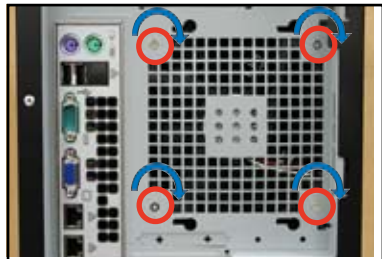

3. Plug the chassis fan cable to the connector on the motherboard.

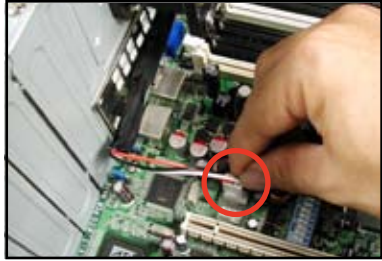

## 2.10.2 HDD blower

To remove the HDD blower:

1. Remove the side cover. Refer to section “2.1.1 Removing the side cover” for instructions.
2. Disconnect the 3-pin fan cable from the fan connector on the backplane.

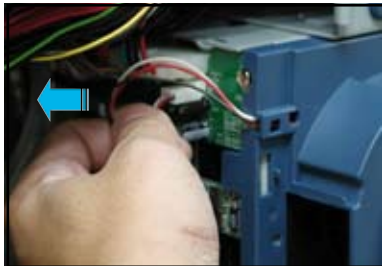

3. Loosen the thumb screw that secures the HDD blower case to the chassis.



4. Firmly grip the blower case as shown, then slide it out of the chassis in the direction of the arrow until the tabs are released from the holes of the HDD cage.

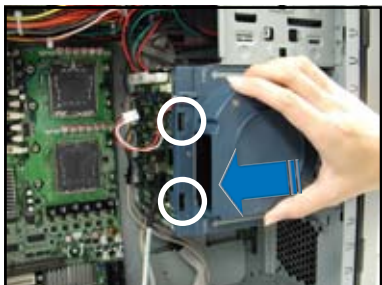



5. Remove the two screws on the blower case using a Phillips screwdriver. Set the screws aside.



6. Remove the blower from the case.

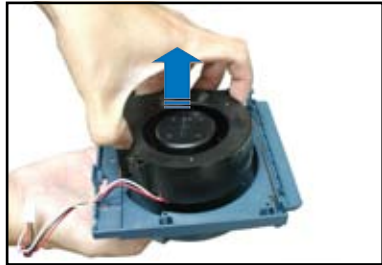

To reinstall the HDD blower:

1. Replace the blower into the case.



2. Secure the blower to the case with the two screws you removed earlier.





- Slide in the blower case as shown, making sure the tabs fit into the holes on the HDD cage.

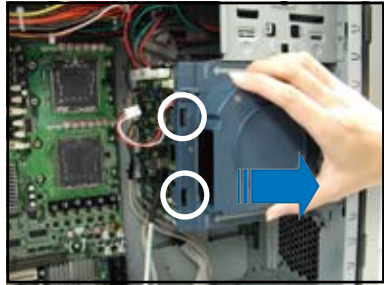

- Drive in the thumb screw to secure the HDD blower case.

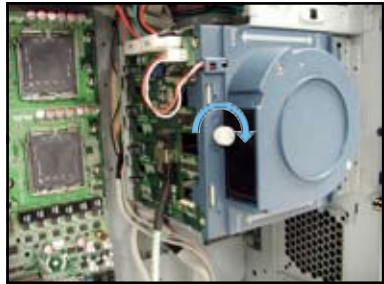

- Connect the 3-pin fan cable to the fan connector on the backplane.

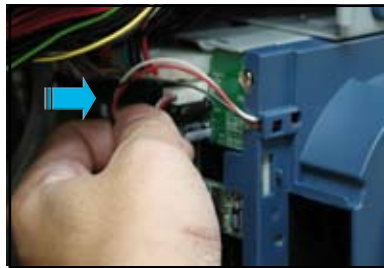

### 2.10.3 SATA/SAS backplane

To remove the SATA/SAS backplane:

1. Remove the HDD blower case. Refer to section “2.10.2 HDD blowers” for instructions.
2. Disconnect all cables from the SATA/SAS backplane.



When disconnecting a cable, hold and firmly pull the cable plug. DO NOT pull the cable itself. Doing so may damage the cable!



3. From the inner edge, push the backplane outward so that the outer edge protrudes slightly from the slot.
4. From the outer edge, firmly hold the backplane and carefully slide it out.

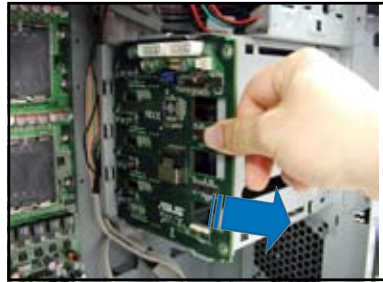

To reinstall a SATA/SAS backplane:

1. Position the backplane into its slot with the component side facing the rear panel, and the power connectors on top.
2. Align the backplane with the rail-like dents on the slot to ensure that it fits securely.

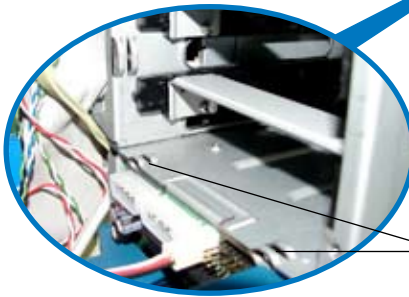

Rail-like dents

3. Slide the backplane into the slot until it fits. If correctly installed, the outer edge of the backplane aligns with the corner of the drive cage.
4. Connect the appropriate cables to the backplane. Refer to sections “2.9.2 SATA backplane connections” and “2.9.3 SAS backplane connections” for details.

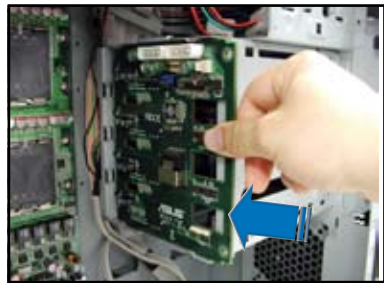

## 2.10.4 MemCool FB-DIMM fan kit

The FB-DIMMs generate heat during continued operation. The ASUS patent MemCool FB-DIMM fan is to ensure optimum thermal condition and performance.

To remove the MemCool FB-DIMM fan kit:

1. Unplug the fan cable from the FBD\_FAN1 connector on the motherboard.

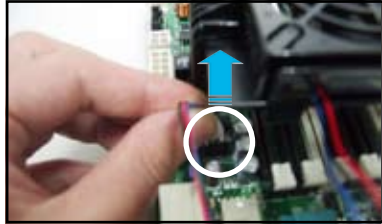

2. Grip the top cover clamps until the top cover hooks are released, then carefully lift the top cover while supporting the fan base with your free hand.

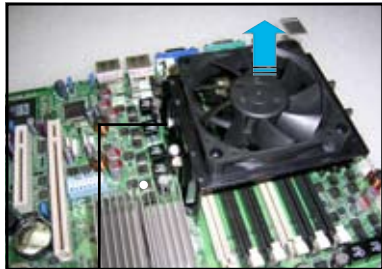

Top cover clamp

3. Carefully lift the fan base.

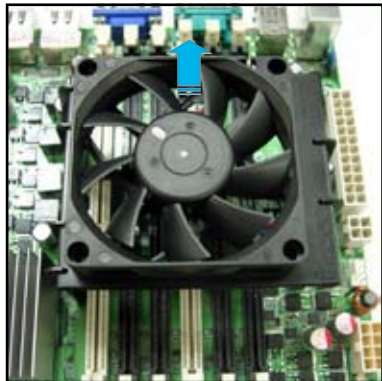

To reinstall the MemCool FB-DIMM fan kit:

1. Locate the three FB-DIMM fan holes on the motherboard.

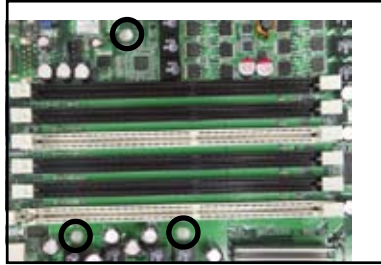

2. Disengage the fan top cover from the fan base. You can do this by firmly gripping the top cover by the clamps to release the hooks, then pull up the top cover carefully until it separates from the fan base.



Do not remove the fan from the fan base.

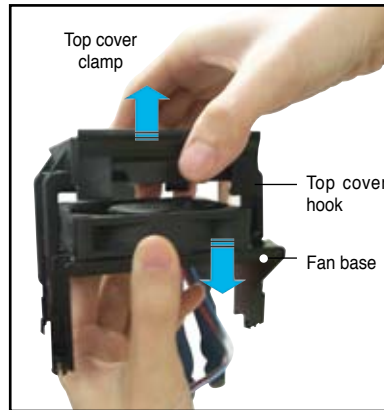

3. Position the fan base over the DIMMs, and insert the fan base legs into the FB-DIMM holes until the legs are securely in place.

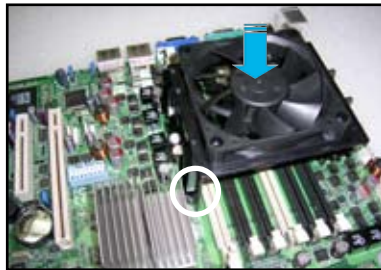

For instructional purposes only, no FB-DIMM is installed on any of the slots.

4. Position top cover over the fan base. Insert the top cover legs into the slot on the fan base legs. Push down carefully until the legs are securely in place and the top cover hooks snap in place.

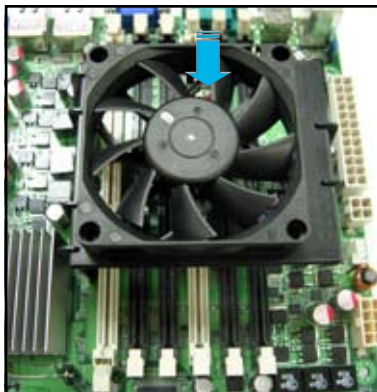

---

Make sure the cables pass through the notch on the fan base as shown.

---



5. Connect the fan cable to the black 4-pin connector labeled FBD\_FAN1.

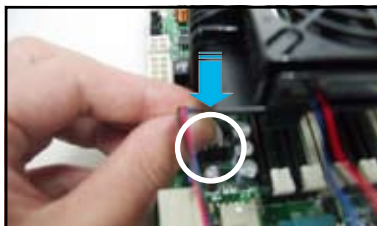

## 2.10.5 Floppy disk drive



You need to remove the front panel assembly before you can remove the floppy disk drive. Refer to section “2.5.1 Removing the front panel assembly” for instructions.

To remove the floppy disk drive:

1. Remove the screw that secures the drive to the chassis.



2. Carefully pull out the drive from the chassis until you see the cables connected to the drive.



3. Disconnect the floppy disk cable and power cable from the drive to completely release the drive.





To reinstall a floppy disk drive:

1. Position the floppy drive vertically with the eject button on the left side (close to the HDDs).
2. Connect the drive signal cable and power cable.

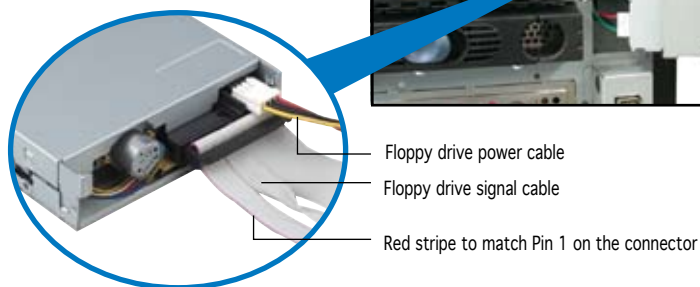

3. Carefully push the drive into the bay until the drive cage fits the front edge of the bay.



4. Secure the drive cage with a screw.





## 2.10.6 Front I/O board



You need to remove the front panel assembly before you can remove the front I/O board. Refer to section “2.5.1 Removing the front panel assembly” for instructions.

To remove the front I/O board:

1. Remove the screw that secures the front I/O board bracket to the front panel.



2. Carefully pull out the bracket until you see the cables connected to the I/O board.
3. Disconnect all the cables from the I/O board.



4. Remove the screw that secures the I/O board to the bracket.

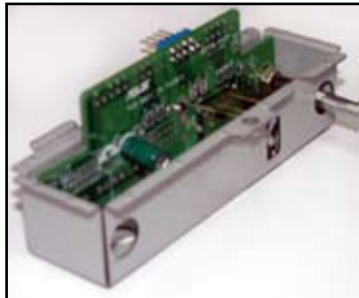

To reinstall the front I/O board:

1. Place the I/O board in the bracket, component side up. Secure the front I/O board to the bracket with a screw.



2. Position the I/O board into the bay with the component side to the left (close to the HDDs). Connect the I/O cables to the connectors on the back of the I/O board.

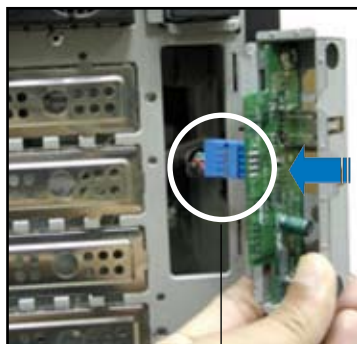

USB 2.0 connector

3. Insert the I/O board into the bay until the bracket fits the front edge of the bay.
4. Secure the I/O board bracket with a screw.



## 2.10.7 Chassis footpads and roller wheels

The barebone server system is shipped with four footpads attached to the bottom of the chassis for stability. You need to remove these footpads if:

- if you want to replace the footpads with the bundled roller wheels
- you wish to install the system to a rack  
(Refer to “Chapter 3 Installation options” of this user guide, and to the “Rackmount Kit” user guide for instructions)

To remove the footpads:

1. Lay the system chassis on its side.
2. Use a flat screwdriver to flip out the top layer of a footpad.



3. Remove the footpad by rotating it counterclockwise.



4. Repeat steps 2 and 3 to remove the other three footpads.

For convenient transport, install the roller wheels the came with the system package. Each wheel has a brake lock to stabilize the chassis in place.

To install the chassis wheels:

1. Lay the chassis in its side.
2. Locate the designated screw holes for each of the four wheel sets. Take note of the numbers alongside each hole when placing screws.

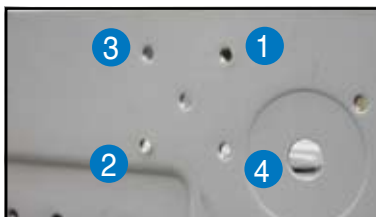

3. Secure each wheel to the bottom of the chassis using four screws.
4. Repeat steps 2 and 3 to install the other three wheels.



---

Remove the chassis roller wheels if you wish to mount the system to a rack.

---

To remove the chassis wheels:

1. Lay the system chassis on its side.
2. Use a Phillips screwdriver to remove the screws that secure the wheels to the bottom of the chassis.
3. Repeat step 2 to remove the other three roller wheels.



## 2.10.8 Power supply unit

Refer to this section when removing or installing a power supply unit to the barebone system.



You MUST disconnect all power cable plugs from the motherboard and other installed devices before removing the power supply unit.

The picture below shows the motherboard and device connectors where the power plugs are connected. Refer to the Appendix at the end of this document for the power supply specifications.

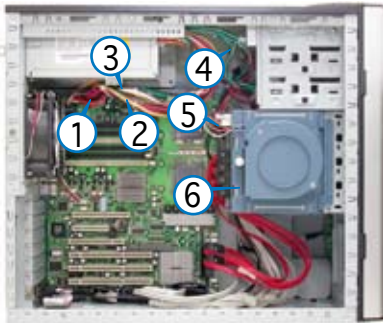

### Model PA4

1. 24-pin ATX (motherboard power connector)
2. 4-pin +12V (motherboard power connector, hidden behind the cables)
3. 8-pin +12V (motherboard power)
4. 4-pin plug (optical drive)
5. 2 x 4-pin plugs (SATA backplane)
6. 4-pin plug (floppy disk drive, hidden behind the backplane)

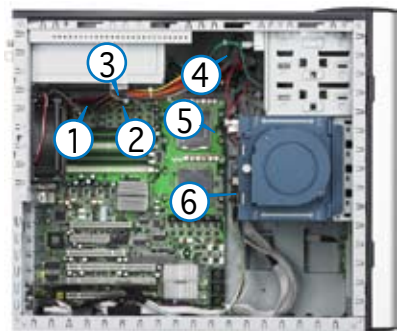

### Model PX4

1. 24-pin ATX (motherboard power connector)
2. 4-pin +12V (motherboard power connector, hidden behind the cables)
3. 8-pin +12V (motherboard power)
4. 4-pin plug (optical drive)
5. 2 x 4-pin plugs (SAS backplane)
6. 4-pin plug (floppy disk drive, hidden behind the backplane)



Make sure to unplug ALL power cables from the system devices before removing the power supply unit.

To remove the power supply unit (PSU):

1. Remove the chassis cover. Refer to section “2.1.1 Removing the side cover.”
2. Lay the chassis on a flat, stable surface.
3. Locate the four screws on the rear panel. Remove the screws and set them aside.

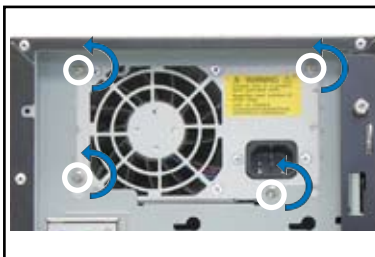

4. Locate and remove the screws that secure the PSU bracket to the chassis.

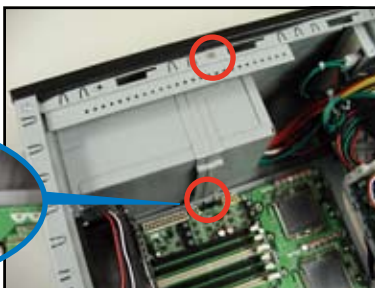

5. Slide the bracket in the direction of the arrow and remove it from the chassis.



6. Carefully slide the PSU in the direction of the arrow until it disengages from the chassis.

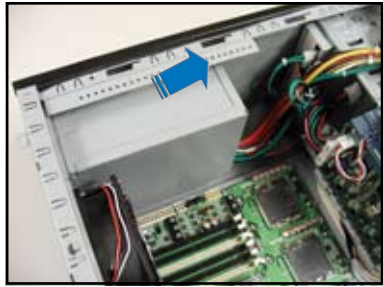

To reinstall the power supply unit:

1. Carefully slide the PSU in the direction of the arrow.

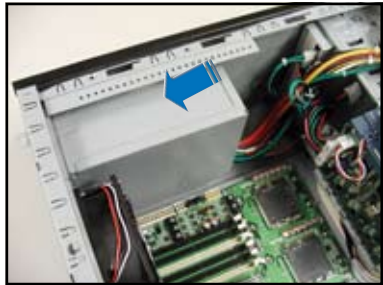

2. Secure the PSU to the chassis with the four screws you removed earlier.

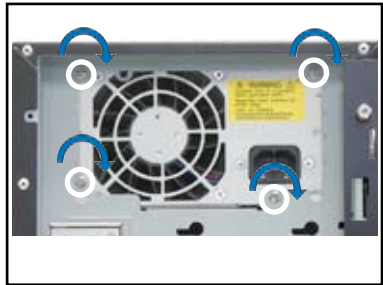

3. Slide in the PSU bracket.



4. Align the screw holes.

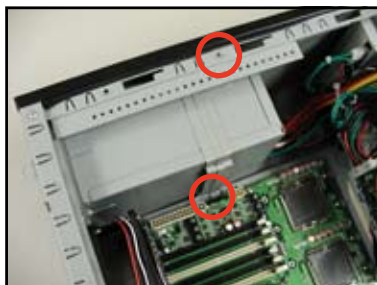

5. Secure the bracket with screws you removed earlier.

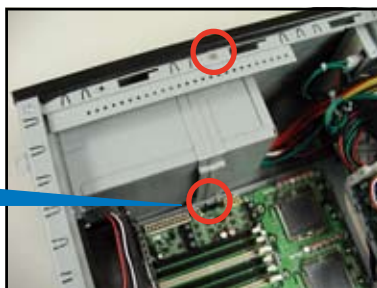



# Chapter 3

This chapter describes how to install optional components into the barebone server.



ASUS TS500-E4

Download from [Www.Somanuals.com](http://Www.Somanuals.com). All Manuals Search And Download.

# Installation option



The items required for the optional configurations described in this chapter are not included in the standard barebone system package. These items are purchased separately.

## 3.1 Preparing the system for rack mounting

### 3.1.1 Removing the footpads or roller wheels

Refer to section “2.10.7 Chassis footpads and roller wheels” for instructions on removing the footpads or roller wheels.

### 3.1.2 Removing the top cover

To remove the top cover:

1. Remove the chassis cover. Refer to section “2.1.1 Removing the side cover.”
2. Remove the front panel assembly. Refer to section “2.5.1 Removing the front panel assembly.”
3. Carefully slide out protruding portion of the top cover as shown.



4. Locate two round mylars on top cover.
5. Carefully remove each mylar using a sharp, flat object such as the edge of a cutter.



### 3.1.3 Attaching the rack rails

Refer to the installation guide that came with the Rackmount Rail Kit for instructions on how to attach the rails and on the barebone server system and the corresponding rails on the industrial rack.

## 3.2 Installing ASUS certified CPU heatsink and fan assembly

To install the CPU heatsink and fan:

1. Place the heatsink on top of installed CPU, making sure that the fan face to front and the four screws on the heatsink align.

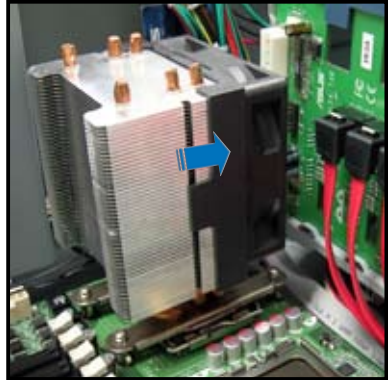

2. Use a Philips screwdriver to tighten the four heatsink screws in a diagonal sequence.



3. Connect the fan cable to the 4-pin connector labeled CPU\_FAN1.



Do not forget to connect the CPU fan cable! Hardware monitoring errors may occur if you fail to plug this connector.

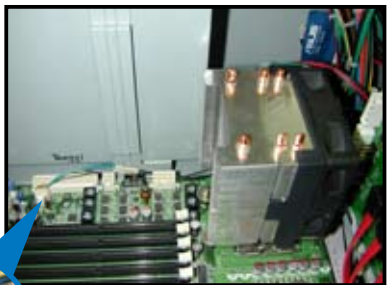

CPU\_FAN1  
connector

4. Repeat steps 1 to 3 to install the other heatsink if you have installed a second CPU, then connect the fan cable to the 4-pin connector labeled CPU\_FAN2.



# Chapter 4

This chapter gives information about the motherboard that comes with the server. This chapter includes the motherboard layout, jumper settings, and connector locations.



# 4.1 Motherboard layouts

## DSBV-D model

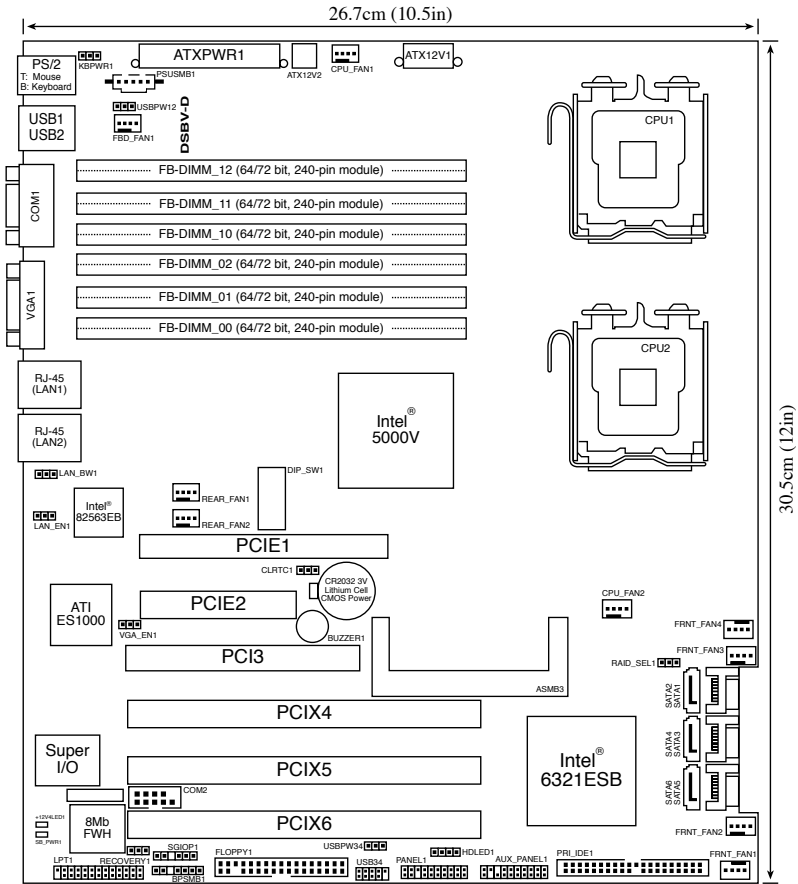

## Layout contents

Slots/Sockets	Page
1.CPU sockets	4-2
2.FB-DIMM sockets	4-2
3.PCI/PCI-X slots	4-2
4.DDR2 SODIMM socket	4-2
5.PCI Express x8 slot	4-2
6.PCI Express x16 slot	4-2

Jumpers	Page
1.Clear RTC RAM (CLRTC1)	4-4
2.LAN bandwidth setting (3-pin LAN_BW1)	4-5
3.USB device wake-up (3-pin USBPW12, USBPW34)	4-6
4.Keyboard power (3-pin KBPWR1)	4-6
5.VGA controller setting (3-pin VGA_EN1)	4-6
6.LAN controller setting (3-pin LAN1_EN1)	4-7
7.Intel® 6321ESB SATA port S/W RAID setting (3-pin RAID_SEL1)	4-7
8.Force BIOS recovery setting (3-pin RECOVERY1)	4-8
9.DIP Switches (DIP_SW1)	4-8

Rear panel connectors	Page
1.PS/2 mouse port (green)	4-9
2.PS/2 keyboard port (purple)	4-9
3.USB 2.0 ports 1 and 2	4-9
4.Serial (COM1) port	4-9
5.Video Graphics Adapter port	4-9
6. LAN (RJ-45) ports	4-9

Internal connectors	Page
1. Floppy disk drive connector (34-1 pin FLOPPY1)	4-10
2. IDE connectors (40-1 pin PRL_IDE)	4-10
3. Serial ATA connectors (7-pin SATA1, SATA2, SATA3, SATA4, SATA5, SATA6)	4-11
4. Hard disk activity LED connector (4-pin HDLED)	4-11
5. USB connectors (10-1 pin USB34)	4-12
6. Serial port connector (10-1 pin COM2)	4-12
7. CPU and ststem fan connectors (4-pin CPU_FAN1/2, REAR_FAN1/2, FRNT_FAN1/2/3/4, FBD_FAN1)	4-13
8. Power supply SMBus connector (5-pin PSUSMB1)	4-13
9. SSI power connectors (24-pin ATXPWR1, 8-pin ATX12V1, 4-pin ATX12V2)	4-14
10. Parallel port connector (26-1 pin LPT1)	4-15
11. Backplane SMBus connector (7-1 pin BPSMB1)	4-15
12. Serial General Purpose Input/Output connector (6-1 pin SGPO1)	4-16
13. System panel connector (20-1 pin PANEL1)	4-17
14. System panel auxiliary connector (20-2 pin AUX_PANEL1)	4-18

## 4.2 Jumpers

### 1. Clear RTC RAM (CLRRTC1)

This jumper allows you to clear the Real Time Clock (RTC) RAM in CMOS. You can clear the CMOS memory of date, time, and system setup parameters by erasing the CMOS RTC RAM data. The onboard button cell battery powers the RAM data in CMOS, which include system setup information such as system passwords.

To erase the RTC RAM:

1. Turn OFF the computer and unplug the power cord.
2. Remove the onboard battery.
3. Move the jumper cap from pins 1-2 (default) to pins 2-3. Keep the cap on pins 2-3 for about 5~10 seconds, then move the cap back to pins 1-2.
4. Reinstall the battery.
5. Plug the power cord and turn ON the computer.
6. Hold down the <Del> key during the boot process and enter BIOS setup to re-enter data.



Except when clearing the RTC RAM, never remove the cap on CLRRTC1 jumper default position. Removing the cap will cause system boot failure!

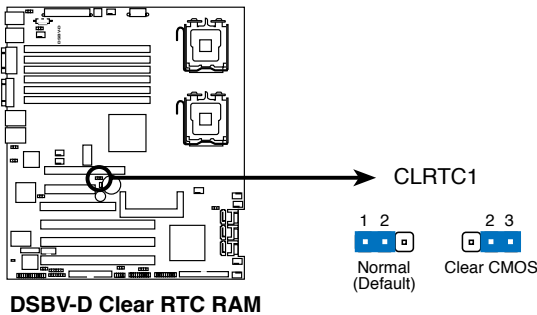



## 2. LAN bandwidth setting (3-pin LAN\_BW1)

This jumper allows you to set the LAN bandwidth setting for more efficient IP load distribution.

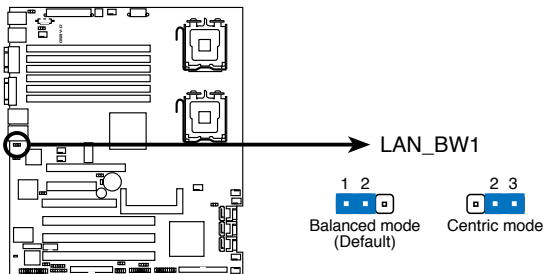

### DSBV-D LAN bandwidth setting

## 3. USB device wake-up (3-pin USBPW12, USBPW34)

Set these jumpers to +5V to wake up the computer from S1 sleep mode (CPU stopped, DRAM refreshed, system running in low power mode) using the connected USB devices. Set to +5VSB to wake up from S4 sleep mode (no power to CPU, DRAM in slow refresh, power supply in reduced power mode).

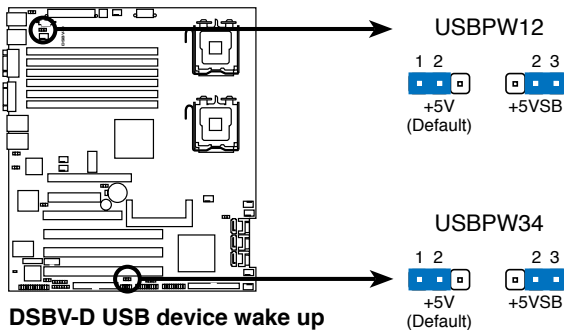

### DSBV-D USB device wake up



- The USB device wake-up feature requires a power supply that can provide 500mA on the +5VSB lead for each USB port; otherwise, the system will not power up.
- If you are using Windows® 2000, you need to install Service Pack 4 to wake up the system from S4 sleep mode.
- The total current consumed must NOT exceed the power supply capability (+5VSB) whether under normal condition or in sleep mode.

#### 4. Keyboard power (3-pin KBPWR1)

This jumper allows you to enable or disable the keyboard wake-up feature. Set this jumper to pins 2-3 (+5VSB) to wake up the computer when you press a key on the keyboard (the default is the Space Bar). This feature requires an ATX power supply that can supply at least 1A on the +5VSB lead, and a corresponding setting in the BIOS.

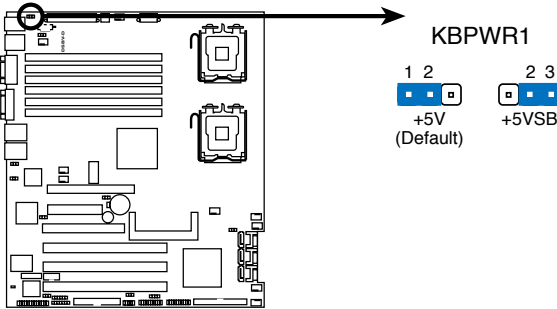

**DSBV-D Keyboard power setting**

#### 5. VGA controller setting (3-pin VGA\_EN1)

These jumpers allow you to enable or disable the onboard VGA controller. Set to pins 1-2 to activate the VGA feature.

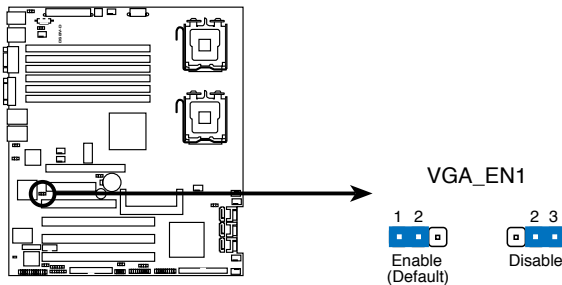

**DSBV-D VGA setting**

6. LAN controller setting (3-pin LAN\_EN1)

This jumper allows you to enable or disable the onboard Intel® 82563EB Gigabit LAN controller. Set to pins 1-2 to activate the Gigabit LAN feature.

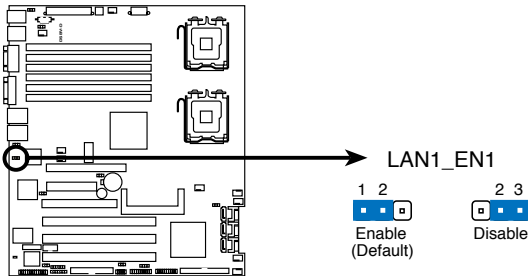

**DSBV-D LAN1\_EN setting**

7. Intel® 6321ESB SATA port S/W RAID setting (3-pin RAID\_SEL1)  
(PA4 model only)

This jumper allows you to select the Serial ATA RAID configuration utility to use when you create disk arrays. Both utilities are supported by the Intel® 6321ESB. Place the jumper caps on pins 1-2 if you want to use the LSI MegaRAID Serial ATA RAID utility (default); otherwise, place the jumper caps on pins 2-3 to use the Intel® Matrix Storage Manager (IMSM).

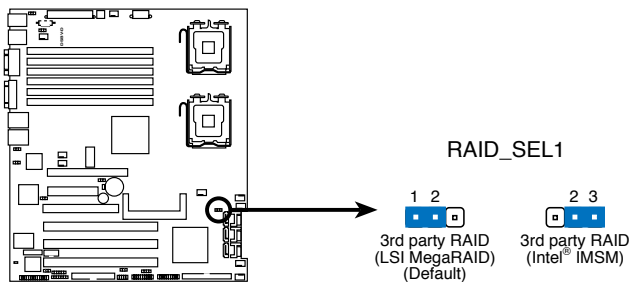

**DSBV-D 6321ESB SATA port S/W RAID setting**

8. Force BIOS recovery setting (3-pin RECOVERY1)

This jumper allows you to quickly update or recover the BIOS settings when it becomes corrupted.

To update the BIOS:

- 1.Prepare a floppy disk that contains the latest BIOS for the motherboard and the Phoenix Phlash16 utility. Make sure you download the correct BIOS for your motherboard model.
- 2.Set the jumper to pins 2-3.
- 3.Insert the floppy disk then turn on the system to update the BIOS.
- 4.Shut down the system.
- 5.Set the jumper back to pins 1-2.
- 6.Turn on the system.

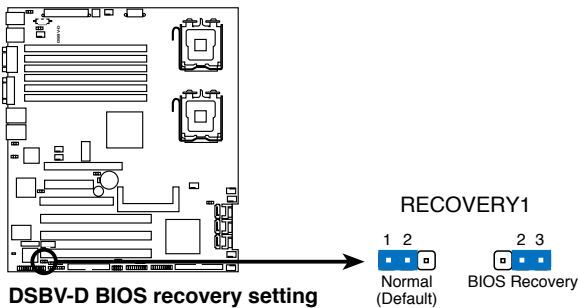

9. DIP switches (DIP\_SW1)

This switch allows you to set up the fan connections. Set the switch to ON if you are using a 4-pin fan (PWM fan) cable plug, or to OFF if you are using a 3-pin (DC fan) plug.

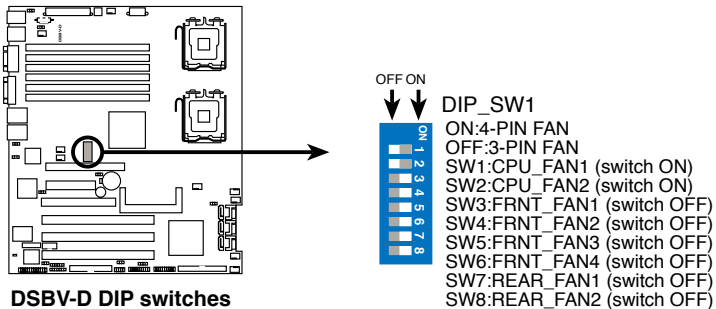

## 4.3 Connectors

### 4.3.1 Rear panel connectors

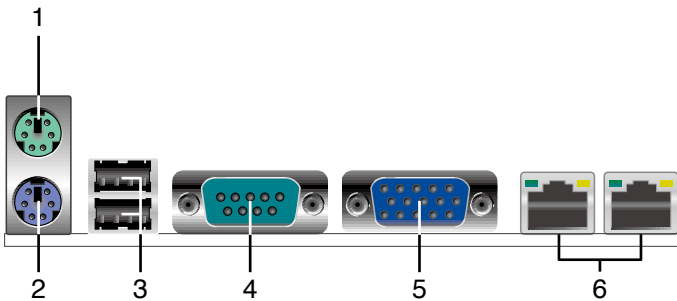

1. PS/2 mouse port (green). This port is for a PS/2 mouse.
2. PS/2 keyboard port (purple). This port is for a PS/2 keyboard.
3. USB 2.0 ports 1 and 2. These two 4-pin Universal Serial Bus (USB) ports are available for connecting USB 2.0 devices.
4. Serial (COM1) port. This 9-pin communication port is for pointing devices or other serial devices.
5. Video Graphics Adapter port. This port is for a VGA monitor or other VGA-compatible devices.
6. LAN (RJ-45) ports. These ports allow Gigabit connection to a Local Area Network (LAN) through a network hub. Refer to the table below for the LAN port LED indications.

#### LAN port LED indications

ACT/LINK LED		SPEED LED	
Status	Description	Status	Description
OFF	No link	OFF	10 Mbps connection
GREEN	Linked	ORANGE	100 Mbps connection
BLINKING	Data activity	GREEN	1000 Mbps connection

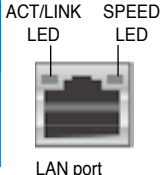

ACT/LINK LED      SPEED LED

LAN port

### 4.3.2 Internal connectors

#### 1. Floppy disk drive connector (34-1 pin FLOPPY1)

This connector is for the provided floppy disk drive (FDD) signal cable. Insert one end of the cable to this connector, then connect the other end to the signal connector at the back of the floppy disk drive.



Pin 5 on the connector is removed to prevent incorrect cable connection when using a FDD cable with a covered Pin 5.

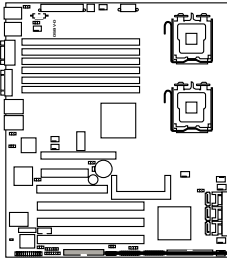

**DSBV-D Floppy disk drive connector**



**FLOPPY1**  
**NOTE:** Orient the red markings on the floppy ribbon cable to PIN 1.

#### 2. IDE connector (40-1 pin PRI\_IDE)

This connector is for an Ultra DMA 100/66 signal cable. The Ultra DMA 100/66 signal cable has three connectors: a blue connector for the primary IDE connector on the motherboard, a black connector for an Ultra DMA 100/66 IDE slave device (optical drive/hard disk drive), and a gray connector for an Ultra DMA 100/66 IDE master device (hard disk drive). If you install two hard disk drives, you must configure the second drive as a slave device by setting its jumper accordingly. Refer to the hard disk documentation for the jumper settings.



- Pin 20 on the IDE connector is removed to match the covered hole on the Ultra DMA cable connector. This prevents incorrect insertion when you connect the IDE cable.
- Use the 80-conductor IDE cable for Ultra DMA 100/66 IDE devices.

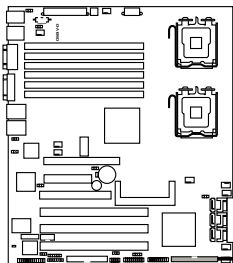

**DSBV-D IDE connector**



**PRI\_IDE1**  
**NOTE:** Orient the red markings (usually zigzag) on the IDE ribbon cable to PIN 1.

3. Serial ATA connectors (7-pin SATA1, SATA2, SATA3, SATA4, SATA5, SATA6) ( PA4 model only )

These connectors are for the Serial ATA signal cables for Serial ATA hard disk drives.

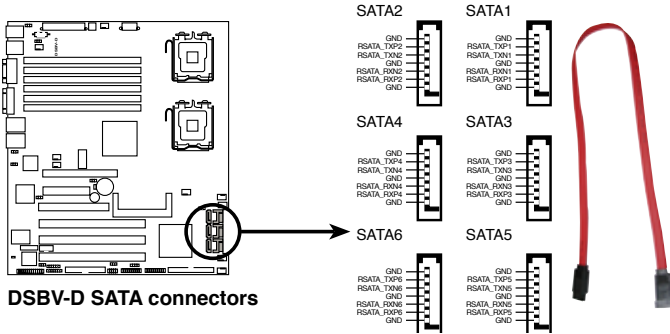

Only connects SATA1, SATA2, SATA3 , and SATA4 are working in TS500-E4/PA4 model.

4. Hard disk activity LED connector (4-pin HDLED1)

This connector is used to connect to a hard disk drive active LED connector on the SCSI or RAID card.

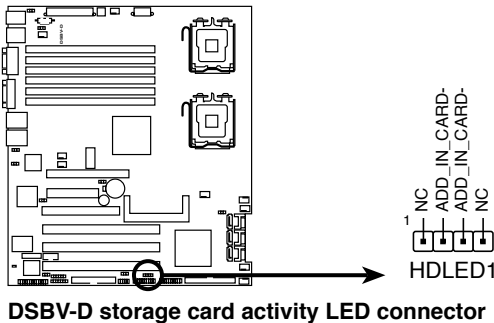

5. USB connector (10-1 pin USB34)

This connector is for USB 2.0 ports. Connect the USB cable to this connector and another USB connector on the front I/O board. This USB connector complies with USB 2.0 specification that supports up to 480 Mbps connection speed.

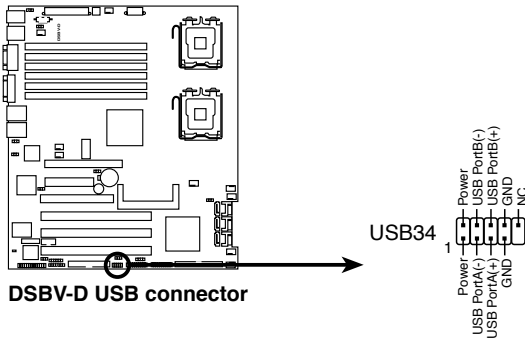

6. Serial port connector (10-1 pin COM2)

This connector is for a serial (COM) port. Connect the serial port module cable to this connector, then install the module to a slot opening at the back of the system chassis.

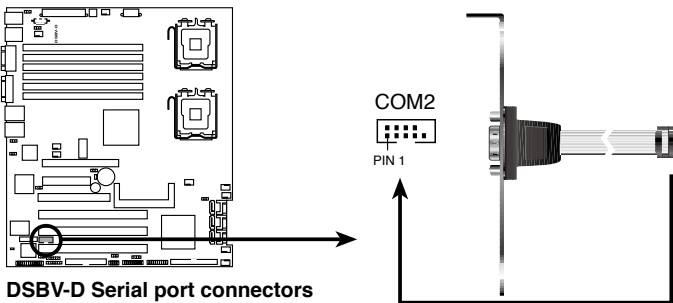

The serial port module is purchased separately.



7. CPU and system fan connectors (4-pin CPU\_FAN1/2, REAR\_FAN1/2, FRNT\_FAN1/2/3/4, FBD\_FAN1)

The fan connectors support cooling fans of 350 mA ~ 740 mA (8.88 W max.) or a total of 2.1 A ~ 4.44 A (53.28 W max.) at +12V. Connect the fan cables to the fan connectors on the motherboard, making sure that the black wire of each cable matches the ground pin of the connector.



Do not forget to connect the fan cables to the fan connectors. Insufficient air flow inside the system may damage the motherboard components. These are not jumpers! Do not place jumper caps on the fan connectors!

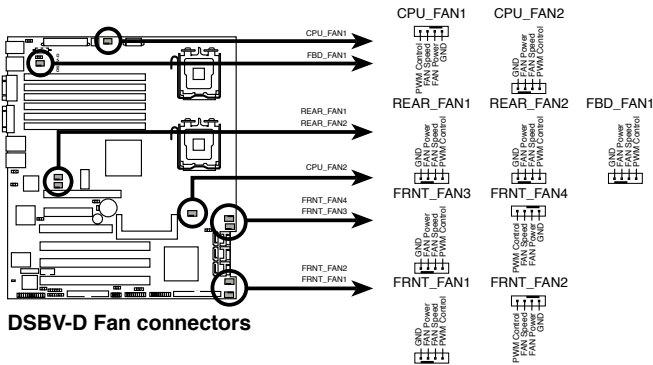

8. Power supply SMBus connector (5-pin PSUSMB1)

This connector is for the power supply SMB cable, if your power supply supports the SMBus function.

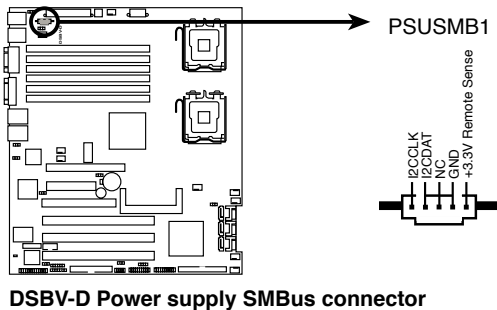

## 9. SSI power connectors (24-pin ATXPWR1, 8-pin ATX12V1, 4-pin ATX12V2)

These connectors are for SSI power supply plugs. The power supply plugs are designed to fit these connectors in only one orientation. Find the proper orientation and push down firmly until the connectors completely fit.



- For a fully configured system, we recommend that you use an SSI 12 V-compliant power supply unit (PSU) for LGA771-socket Intel® Xeon Dual Core processors (Bensley platform).
- Do not forget to connect the 24+8+4-pin power plugs; otherwise, the system will not boot up.
- Use of a PSU with a higher power output is recommended when configuring a system with more power consuming devices. The system may become unstable or may not boot up if the power is inadequate.
- You must install a PSU with a higher power rating if you intend to install additional devices.

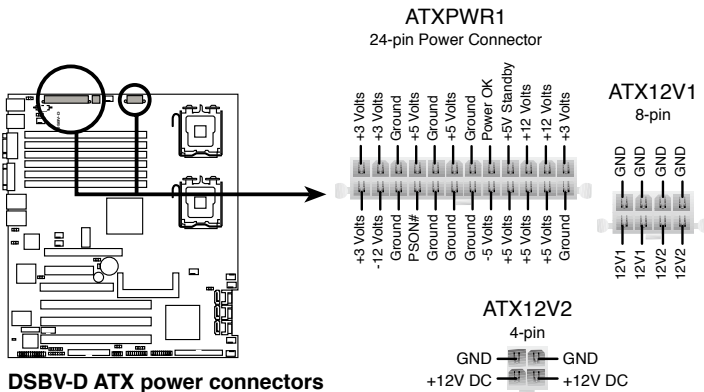

10.Parallel port connector (26-1 pin LPT1)

This connector is for a parallel port. Connect the parallel port module cable to this connector, then install the module to a slot opening at the back of the system chassis.

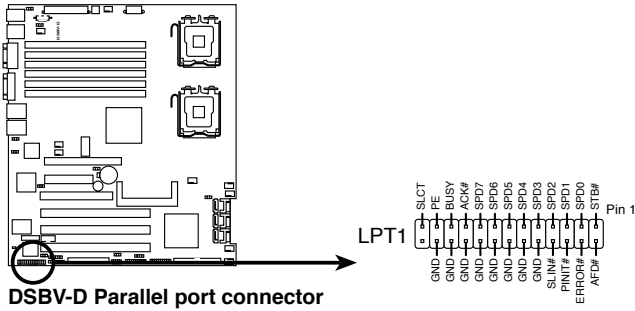

11.Backplane SMBus connector (7-1 pin BPSMB1)

This connector allows you to connect SMBus (System Management Bus) devices. Devices communicate with an SMBus host and/or other SMBus devices using the SMBus interface.

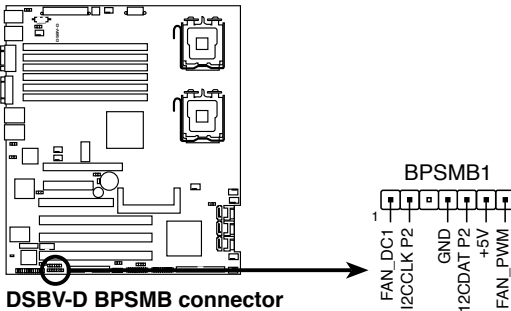

## 12. Serial General Purpose Input/Output connector (6-1 pin SGPIO1)

This connector is used to the SGPIO peripherals for the LSI MegaRAID SATA LED.

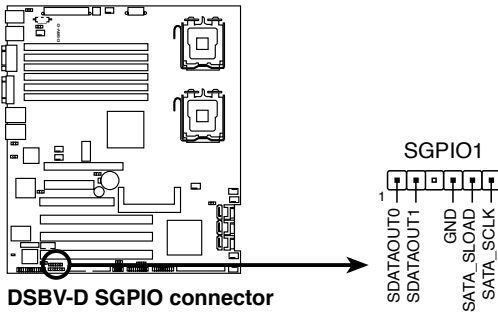

### 13. System panel connector (20-1 pin PANEL1)

This connector supports several chassis-mounted functions.



The system panel connector is color-coded for easy connection.

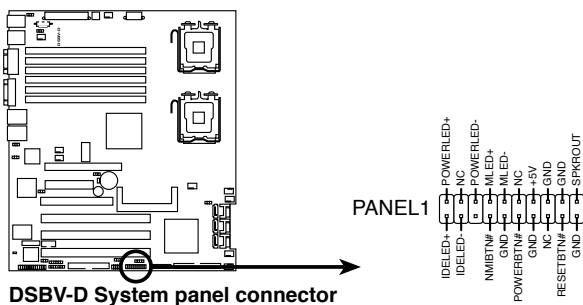

- **System power LED (Green 3-pin PLED)**  
This 3-pin connector is for the system power LED. Connect the chassis power LED cable to this connector. The system power LED lights up when you turn on the system power, and blinks when the system is in sleep mode.
- **Hard disk drive activity LED (Red 2-pin IDE\_LED)**  
This 2-pin connector is for the HDD Activity LED. Connect the HDD Activity LED cable to this connector. The IDE LED lights up or flashes when data is read from or written to the HDD.
- **System warning speaker (Orange 4-pin SPEAKER)**  
This 4-pin connector is for the chassis-mounted system warning speaker. The speaker allows you to hear system beeps and warnings.
- **ATX power button/soft-off button (Yellow 2-pin PWRSW)**  
This connector is for the system power button. Pressing the power button turns the system on or puts the system in sleep or soft-off mode depending on the BIOS settings. Pressing the power switch for more than four seconds while the system is ON turns the system OFF.
- **Reset button (Blue 2-pin RESET)**  
This 2-pin connector is for the chassis-mounted reset button for system reboot without turning off the system power.

#### 14. System panel auxiliary connector (20-2 pin AUX\_PANEL1)

This connector is for additional front panel features including front panel SMB, locator LED and switch, chassis intrusion, and LAN LEDs.

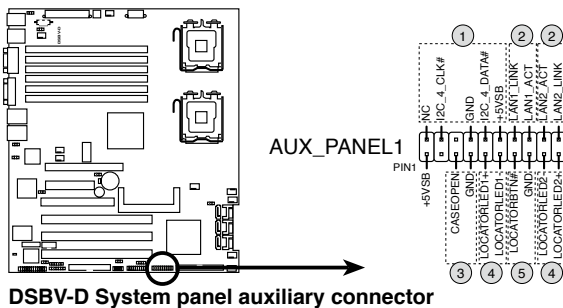

#### 1. Front panel SMB (6-1 pin FPSMB)

These leads connect the front panel SMBus cable.

#### 2. LAN activity LED (2-pin LAN1\_LED, LAN2\_LED)

These leads are for Gigabit LAN activity LEDs on the front panel.

#### 3. Chassis intrusion (2 pin CHASSIS)

These leads are for the intrusion detection feature for chassis with intrusion sensor or microswitch. When you remove any chassis component, the sensor triggers and sends a high-level signal to these leads to record a chassis intrusion event.

#### 4. Locator LED (6-pin LOCATOR)

These leads are for the locator switch and LED on the front panel.

#### 5. Locator LED (6-pin LOCATOR)

These leads are for the locator switch and LED on the front panel.

# Chapter 5

This chapter tells hoe to change the system settings through the BIOS Setup menus. Detailed descriptions of the BIOS parameters are also provided.



## 5.1 Managing and updating your BIOS

The following utilities allow you to manage and update the motherboard Basic Input/Output System (BIOS) setup.

1. Phoenix Phlash16 BIOS Flash Utility (Updates the BIOS in DOS mode using a bootable floppy disk.)
2. ASUS CrashFree BIOS 2 (Updates the BIOS using a bootable floppy disk or the motherboard support CD when the BIOS file fails or gets corrupted.)
3. ASUS Update (Updates the BIOS in Windows® environment.)

Refer to the corresponding sections for details on these utilities.



---

Save a copy of the original motherboard BIOS file to a bootable floppy disk in case you need to restore the BIOS in the future. Copy the original motherboard BIOS using the ASUS Update or Phoenix Phlash16 BIOS utilities. Refer to page 5-3 for details.

---

### 5.1.1 Creating a bootable floppy disk

1. Do either one of the following to create a bootable floppy disk.

DOS environment

- a. Insert a 1.44MB floppy disk into the drive.
- b. At the DOS prompt, type `format A:/S` then press <Enter>.

Windows® XP environment

- a. Insert a 1.44 MB floppy disk to the floppy disk drive.
- b. Click Start from the Windows® desktop, then select My Computer.
- c. Select the 3 1/2 Floppy Drive icon.
- d. Click File from the menu, then select Format. A Format 3 1/2 Floppy Disk window appears.
- e. Select Create an MS-DOS startup disk from the format options field, then click Start.ss

Windows® 2000 environment

To create a set of boot disks for Windows® 2000:

- a. Insert a formatted, high density 1.44 MB floppy disk into the drive.
- b. Insert the Windows® 2000 CD to the optical drive.



- c. Click Start, then select Run.
  - d. From the Open field, type  
D:\bootdisk\makeboot a:  
assuming that D: is your optical drive.
  - e. Press <Enter>, then follow screen instructions to continue.
2. Copy the original or the latest motherboard BIOS file to the bootable floppy disk.

## 5.1.2 Updating the BIOS using the Phoenix Phlash16 Utility

The Basic Input/Output System (BIOS) can be updated using the Phoenix Phlash16 Utility. Follow these instructions to update the BIOS using this utility.

1. Download the latest BIOS file from the ASUS web site. Rename the file to BIOS.WPH. Save the file to a floppy disk.



---

Make sure you copy the correct BIOS file for the specific model of your motherboard. Save only the updated BIOS file in the floppy disk to avoid loading the wrong BIOS file.

---

2. Copy the Phoenix Phlash16 (plash16.exe) utility from the Software folder of the support CD to the floppy disk with the latest BIOS file.
3. Boot the system in DOS mode using the bootable floppy disk you created earlier.
4. When the A:> appears, replace the bootable floppy disk with the floppy disk containing the new BIOS file and the Phoenix Phlash16 Utility.
5. At the prompt, type the following command string:  
plash16 /mode=3 BIOS.WPH.
6. The Phoenix Phlash16 Utility automatically updates the BIOS.



---

Do not turn off or reset the system during the flashing process!

---

7. Restart the system after the utility completes the updating process. Make sure you remove the floppy disk from the drive

### 5.1.3 ASUS CrashFree BIOS 2 utility

The ASUS CrashFree BIOS 2 is an auto recovery tool that allows you to restore the BIOS file when it fails or gets corrupted during the updating process. You can update a corrupted BIOS file using the motherboard support CD and a floppy disk.



Prepare the motherboard support CD and a floppy disk before using this utility.

#### Recovering the BIOS from a floppy disk

To recover the BIOS from a floppy disk:

1. Insert the blank floppy disk to a PC, then boot from the support CD; the screen will show several optional items.
2. Select the item “ Create the emergent BIOS Recovery diskette”.

#### For PA4 model

```
A) FreeDOS command prompt
B) Create INTEL 6321 MATRIX STORAGE MANAGER for Windows 32 bit Driver Disk.
   (Also support AHCI.)
C) Create INTEL 6321 MATRIX STORAGE MANAGER for Windows 64 bit Driver Disk.
   (Also support AHCI.)
D) Create INTEL 6321 LSI MegaRAID for Win2k Driver Disk
E) Create INTEL 6321 LSI MegaRAID for WinXP/Win2k3 32 bit Driver Disk
F) Create INTEL 6321 LSI MegaRAID for WinXP/Win2k3 64 bit Driver Disk
G) Create the emergent BIOS Recovery diskette
H) ESB2 ASF firmware update
Please choose A TO H:
```

#### For PX4 model

```
A) FreeDOS command prompt
B) Create the emergent BIOS Recovery diskette
C) Flash Phoenix BIOS for TS500-E4/PX4 system
D) ESB2 ASF Firmware update
E) Write TS500-E4/PX4 FRU
Please choose A TO E:
```

3. After the floppy disk is created, put this disk in the floppy disk drive, then turn on the machine.
4. The utility displays the following message and automatically checks the floppy for the recovery information.

```
RN50 DDR1 A21 BIOS
```

5. When found, the utility reads the BIOS file and starts flashing the corrupted BIOS file.

```

Phoenix Phlash16 Utility Version 1.6.1.9
Copyright (c) Phoenix Technologies Ltd., 2005

Performing the following function

▶ Load Image File          BIOS.WPH
Verify interface information
Backup system BIOS ROM
Check flash memory type(s)
Flash memory block:
  Save block
  Restore block
  Zero out block
  Erase block
  Program block
  Verify block
Flash programming complete

30% Read in ██████████

```

Identifying flash memory part type 00:00:00 (18)



DO NOT shut down or reset the system while updating the BIOS! Doing so can cause system boot failure!

- When the utility completes the updating process, a message appears, informing you that the flash memory has been programmed successfully.

```

Phoenix Phlash16 Utility Version 1.6.1.9

Phoenix Phlash16 Status
Flash memory has been successfully programmed

PRESS ANY KEY TO RESTART THE SYSTEM
If the system does not restart
TURN THE POWER OFF, THEN ON

Flash memory block:
  Save block
  Restore block .....
  Zero out block .....
  Erase block  ~~~~~
  Program block  ~~~~~
  Verify block  ~~~~~
▶ Flash programming complete

Flash part: SST49LF008A DeviceID: 5a Mfr. ID: bf
Ready to restart the system 00:00:00 (1E)

```

7. Press the power button for more than four seconds to turn off the system.



---

The recovered BIOS may not be the latest BIOS version for this motherboard. Visit the ASUS website ([www.asus.com](http://www.asus.com)) to download the latest BIOS file.

---

### 5.1.4 ASUS Update utility

The ASUS Update is a utility that allows you to manage, save, and update the motherboard BIOS in Windows® environment. The ASUS Update utility allows you to:

- Save the current BIOS file
- Download the latest BIOS file from the Internet
- Update the BIOS from an updated BIOS file
- Update the BIOS directly from the Internet, and
- View the BIOS version information.

This utility is available in the support CD that comes with the motherboard package.



---

ASUS Update requires an Internet connection either through a network or an Internet Service Provider (ISP).

---

### Installing ASUS Update

To install ASUS Update:

1. Place the support CD in the optical drive. The Drivers menu appears.
2. Click the Utilities tab, then click Install ASUS Update VX.XX.XX.
3. The ASUS Update utility is copied to your system.



---

Quit all Windows® applications before you update the BIOS using this utility.

---

## Updating the BIOS through the Internet

To update the BIOS through the Internet:

1. Launch the ASUS Update utility from the Windows® desktop by clicking Start > Programs > ASUS > ASUSUpdate > ASUSUpdate. The ASUS Update main window appears.



2. Select Update BIOS from the Internet option from the drop-down menu, then click Next.
3. Select the ASUS FTP site nearest you to avoid network traffic, or click Auto Select. Click Next.

4. From the FTP site, select the BIOS version that you wish to download. Click Next.
5. Follow the screen instructions to complete the update process.



The ASUS Update utility is capable of updating itself through the Internet. Always update the utility to avail all its features.



### Updating the BIOS through a BIOS file

To update the BIOS through a BIOS file:

1. Launch the ASUS Update utility from the Windows® desktop by clicking Start > Programs > ASUS > ASUSUpdate > ASUSUpdate. The ASUS Update main window appears.
2. Select Update BIOS from a file option from the drop-down menu, then click Next.



3. Locate the BIOS file from the Open window, then click Save.
4. Follow the screen instructions to complete the update process.

## 5.2 BIOS setup program

This motherboard supports a programmable Low-Pin Count (LPC) chip that you can update using the provided utility described in section “5.1 Managing and updating your BIOS.”

Use the BIOS Setup program when you are installing a motherboard, reconfiguring your system, or prompted to “Run Setup.” This section explains how to configure your system using this utility.

Even if you are not prompted to use the Setup program, you can change the configuration of your computer in the future. For example, you can enable the security password feature or change the power management settings. This requires you to reconfigure your system using the BIOS Setup program so that the computer can recognize these changes and record them in the CMOS RAM of the LPC chip.

The LPC chip on the motherboard stores the Setup utility. When you start up the computer, the system provides you with the opportunity to run this program. Press <Del> during the Power-On Self-Test (POST) to enter the Setup utility; otherwise, POST continues with its test routines.

If you wish to enter Setup after POST, restart the system by pressing <Ctrl+Alt+Delete>, or by pressing the reset button on the system chassis. You can also restart by turning the system off and then back on. Do this last option only if the first two failed.

The Setup program is designed to make it as easy to use as possible. Being a menu-driven program, it lets you scroll through the various sub-menus and make your selections from the available options using the navigation keys.



- 
- The default BIOS settings for this motherboard apply for most conditions to ensure optimum performance. If the system becomes unstable after changing any BIOS settings, load the default settings to ensure system compatibility and stability. Select the Load Default Settings item under the Exit Menu. See section “5.8 Exit Menu.”
  - The BIOS setup screens shown in this section are for reference purposes only, and may not exactly match what you see on your screen.
  - Visit the ASUS website ([www.asus.com](http://www.asus.com)) to download the latest BIOS file for this motherboard.
-

## 5.2.1 BIOS menu screen

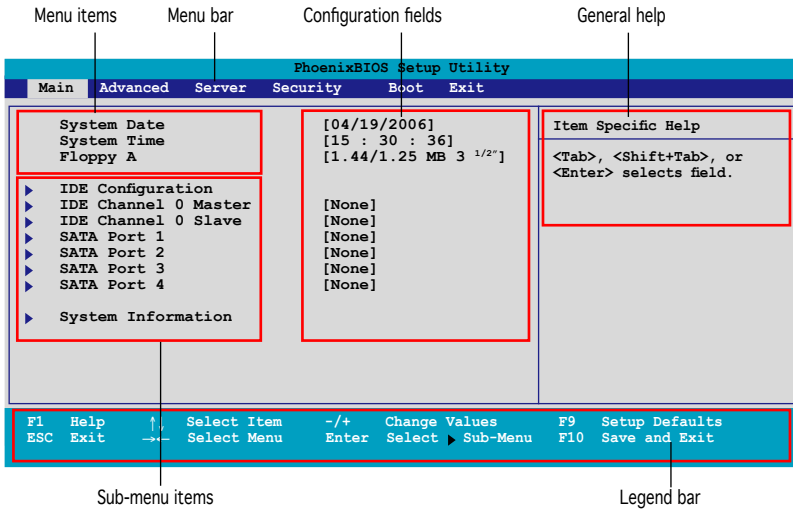

## 5.2.2 Menu bar

The menu bar on top of the screen has the following main items:

- Main For changing the basic system configuration
- Advanced For changing the advanced system settings
- Server For changing the advanced server settings
- Security For changing the security settings
- Boot For changing the system boot configuration
- Exit For selecting the exit options and loading default settings

To select an item on the menu bar, press the right or left arrow key on the keyboard until the desired item is highlighted.



### 5.2.3 Legend bar

At the bottom of the Setup screen is a legend bar. The keys in the legend bar allow you to navigate through the various setup menus. The following table lists the keys found in the legend bar with their corresponding functions.

Navigation Key	Function
<F1>	Displays the General Help screen
<F9>	Loads setup default values
<Esc>	Exits the BIOS setup or returns to the main menu from a sub-menu
Left or Right arrow	Selects the menu item to the left or right
Up or Down arrow	Moves the highlight up or down between fields
Page Down or - (minus)	Scrolls backward through the values for the highlighted field
Page Up or + (plus)	Scrolls forward through the values for the highlighted field
<Enter>	Brings up a selection menu for the highlighted field
<F10>	Saves changes and exit

### 5.2.4 Menu items

The highlighted item on the menu bar displays the specific items for that menu. For example, selecting Main shows the Main menu items.

The other items (Advanced, Power, Boot, and Exit) on the menu bar have their respective menu items.

### 5.2.5 Sub-menu items

A solid triangle before each item on any menu screen means that the item has a sub-menu. To display the sub-menu, select the item and press <Enter>.

### 5.2.6 Configuration fields

These fields show the values for the menu items. If an item is user-configurable, you can change the value of the field opposite the item. You cannot select an item that is not user-configurable.

A configurable field is enclosed in brackets, and is highlighted when selected. To change the value of a field, select it then press <Enter> to display a list of options. Refer to “5.2.7 Pop-up window.”

## 5.2.7 Pop-up window

Select a menu item then press <Enter> to display a pop-up window with the configuration options for that item.

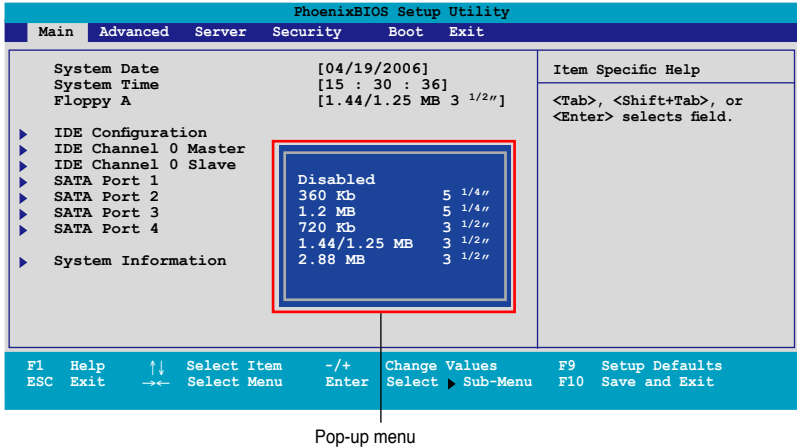

## 5.2.8 General help

At the top right corner of the menu screen is a brief description of the selected item.

## 5.3 Main menu

When you enter the BIOS Setup program, the Main menu screen appears, giving you an overview of the basic system information.



Refer to section “5.2.1 BIOS menu screen” for information on the menu screen items and how to navigate through them.

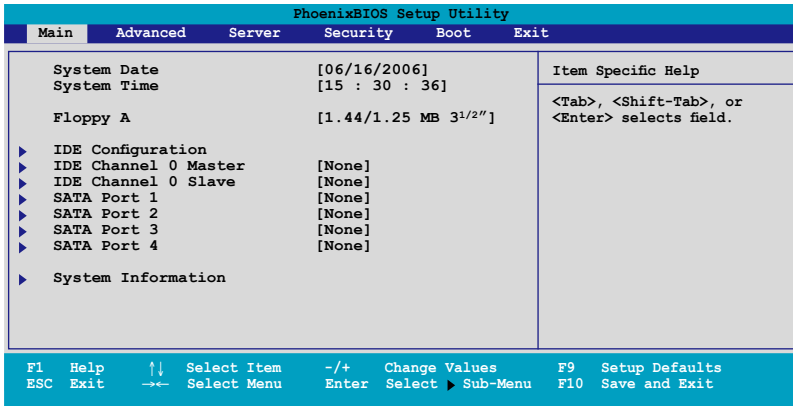

### 5.3.1 System Date [Day xx/xx/xxxx]

Allows you to set the system date.

### 5.3.2 System Time [xx:xx:xx]

Allows you to set the system time.

### 5.3.3 Floppy A [1.44/1.25 MB 3 1/2'']

Sets the type of floppy drive installed. Configuration options: [Disabled] [360 Kb 5 1/4''] [1.2 MB 5 1/4''] [720 Kb 3 1/2''] [1.44/1.25 MB 3 1/2''] [2.88 MB 3 1/2'']

## 5.3.4 IDE Configuration

PhoenixBIOS Setup Utility					
Main					
IDE Configuration				Item Specific Help	
Fixed disk boot sector: [Normal]				Write protects boot sector on hard disk to protect against viruses.	
▶ S-ATA Configuration					
F1	Help	↑↓	Select Item	-/+	Change Values
ESC	Exit	→←	Select Menu	Enter	Select ▶ Sub-Menu
F9	Setup Defaults			F10	Save and Exit

### Fixed disk boot sector [Normal]

Setting this item to [Write Protect] prevents write access to the boot sector on the hard disk to protect against viruses. The default setting [Normal] allows write access. Configuration options: [Normal] [Write Protect]

### S-ATA Configuration

PhoenixBIOS Setup Utility					
Main					
S-ATA Configuration				Item Specific Help	
Parallel ATA				[Enabled]	
Serial ATA				[Enabled]	
SATA Controller Mode Option				[Enhanced]	
SATA RAID Enable				[Disabled]	
SATA AHCI Enable				[Disabled]	
				Enable the PATA	
F1	Help	↑↓	Select Item	-/+	Change Values
ESC	Exit	→←	Select Menu	Enter	Select ▶ Sub-Menu
F9	Setup Defaults			F10	Save and Exit

### Parallel ATA [Enabled]

Allows you to enable or disable the parallel ATA function. Configuration options: [Disabled] [Enabled]

## Serial ATA [Enabled]

Allows you to enable or disable the Serial ATA function. Configuration options: [Disabled] [Enabled]

### SATA Controller Mode Option [Enhanced]

Allows selection of the Serial ATA operation mode depending on the operating system (OS) that you installed. When you set this item to Enhanced Mode, Serial ATA and Parallel ATA devices are auto-detected and placed in native IDE mode. Set to Enhanced Mode if you are using native OS, such as Windows® 2000/XP. When you set this item to Compatible Mode, Serial ATA and Parallel ATA devices are auto-detected and placed in legacy mode. Configuration options: [Compatible] [Enhanced]



---

The following items appear only if you set the SATA Controller Mode Option item to [Enhanced].

---

### SATA RAID Enable [Disabled]

Allows you to enable or disable the Serial ATA RAID function. Configuration options: [Disabled] [Enabled]

### SATA AHCI Enable [Disabled]

Allows you to enable or disable the Serial ATA AHCI function. Configuration options: [Disabled] [Enabled]



- 
- AHCI mode item will support only under Windows environment.
  - Due to the driver limitation, you will not find any SATA driver if you install Fedora core 4.
-

## 5.3.5 IDE Channel 0 Master/Slave; SATA Port 1/2/3/4

PhoenixBIOS Setup Utility	
Main	
IDE Channel 0 Master	Item Specific Help
Type: [Auto]	User = you enter Parameters of hard-disk driver installed at this connection.
Multi-Sector Transfers [Disabled]	Auto = autotypes hard-disk drive installed here.
LBA Mode Control [Disabled]	CD-ROM = a CD-ROM drive is installed here.
32-Bit I/O [Disabled]	ATAPI Removable = removable disk drive is installed here.
Transfer Mode [Standard]	
Ultra DMA Mode [Disabled]	
F1 Help    ↑↓ Select Item    -/+ Change Values    F9 Setup Defaults	
ESC Exit    →← Select Menu    Enter Select    ▶ Sub-Menu    F10 Save and Exit	

### Type [Auto]

Selects the type of IDE drive. Setting to Auto allows automatic selection of the appropriate IDE device type. Select [CD-ROM] if you are specifically configuring a CD-ROM drive. Select [ATAPI Removable] if your device is either a ZIP, LS-120, or MO drive. Select [User] to manually enter the parameters of the device. Configuration options: [Auto] [User] [Other ATAPI] [IDE Removable] [CD-ROM] [ATAPI Removable]



- Except for 32-Bit I/O item, the following items become user-configurable when the Type item is not set to [Auto].
- For items that have no sub-menu, you have to use -/+ for values changing.

### Multi-Sector Transfers [Disabled]

Enables or disables data multi-sectors transfers. When set to 2~16 Sectors, the data transfer from and to the device occurs multiple sectors at a time if the device supports multi-sector transfer feature. When set to [Disabled], the data transfer from and to the device occurs one sector at a time. Configuration options: [Disabled] [2 Sectors] [4 Sectors] [8 Sectors] [16 Sectors]r

### LBA Mode Control [Disabled]

Enables or disables the LBA mode. Setting to Enabled enables the LBA mode if the device supports this mode, and if the device was not previously formatted with LBA mode disabled. Configuration options: [Disabled] [Enabled]

### 32-Bit I/O [Disabled]

Enables or disables 32-bit data transfer. Configuration options: [Disabled] [Enabled]

### Transfer Mode [Standard]

Allows you to select the method for the data transferring if the hard disk supports this feature. Configuration options: [Standard] [Fast PIO 1] [Fast PIO 2] [Fast PIO 3] [Fast PIO 4] [FPIO 3 / DMA 1] [FPIO 4 / DMA2]

### Ultra DMA Mode [Disabled]

When this item is set to [Mode 0-5], the UDMA capability allows improved transfer speeds and data integrity for supported IDE devices. Configuration options: [Disabled] [Mode 0] [Mode 1] [Mode 2] [Mode 3] [Mode 4] [Mode 5]

## 5.3.6 System Information

This menu gives you an overview of the general system specifications. The BIOS automatically detects the items in this menu.

PhoenixBIOS Setup Utility		
Main		
System Information		Item Specific Help
Model Name	ASUS DSBV-D	The detailed information for CPUs
Model ID	8032A0	
ASUS BIOS Version	1001	
Date	07/14/2006	
▶ Processor Information		
▶ System Memory Information		
F1 Help	↑↓ Select Item	-/+ Change Values
ESC Exit	← Select Menu	Enter Select ▶ Sub-Menu
		F9 Setup Defaults
		F10 Save and Exit



The items in this menu are non-user configurable.

### Model Name/Model ID

Displays the ASUS internal model information.

### ASUS BIOS

Displays the BIOS revision and build date.

## Processor Information

Displays the auto-detected CPU specification.

PhoenixBIOS Setup Utility			
Main			
Processor Information		Item Specific Help	
<pre> *** CPU1 : Brand      Intel(R) Xeon(TM) CPU 2.83GHz Speed      2.800GHz Ratio      Actual 17 Max 17 Cache      L1/32 KB L2/4096 KB ID/uCode   0F64h/02h           </pre>		<p>All items on this menu cannot be modified in user mode. If any items require changes, please consult your system Supervisor.</p>	
F1	Help	↑↓	Select Item
ESC	Exit	→←	Select Menu
-/+	Change Values	Enter	Select
▶	Sub-Menu		
F9	Setup Defaults		
F10	Save and Exit		

## System Memory Information

Displays the auto-detected system memory information.

PhoenixBIOS Setup Utility			
Main			
System Memory Information		Item Specific Help	
<pre> Speed      : DDR2 533 Total Memory: 1024MB DIMM_00--  1024MB, AMB Temperature: 18 DIMM_01--  None DIMM_02--  None DIMM_10--  None DIMM_11--  None DIMM_12--  None           </pre>		<p>All items on this menu cannot be modified in user mode. If any items require changes, please consult your system Supervisor.</p>	
F1	Help	↑↓	Select Item
ESC	Exit	→←	Select Menu
-/+	Change Values	Enter	Select
▶	Sub-Menu		
F9	Setup Defaults		
F10	Save and Exit		



## 5.4 Advanced menu

The Advanced menu items allow you to change the settings for the CPU and other system devices.



Take caution when changing the settings of the Advanced menu items. Incorrect field values can cause the system to malfunction.

PhoenixBIOS Setup Utility	
Main	Advanced
WARNING: Setting wrong value in below sections may cause system to malfunction.	
<ul style="list-style-type: none"> <li>▶ Advanced Processor Options</li> <li>▶ Chipset Configuration</li> <li>▶ PCI Configuration</li> <li>▶ ICH USB Control Sub-Menu</li> <li>▶ Peripheral Devices Configuration</li> <li>▶ ACPI Configuration</li> <li>▶ Power On Configuration</li> <li>▶ Hardware Monitor</li> </ul>	Item Specific Help Options for CPU

### 5.4.1 Advanced Processor Options For Xeon 5000 Series CPU

PhoenixBIOS Setup Utility			
Advanced			
Advanced Processor Options		Item Specific Help	
Multiprocessor Specification	[1.4]	Configures the MP Specification revision level. Some operating systems will require 1.1 for compatibility reasons.	
Frequency Ratio	[Default]		
Hyperthreading:	[Enabled]		
Intel(R) Virtualization Technology	[Enabled]		
Machine Checking	[Enabled]		
Fast String Operations	[Enabled]		
Compatible FPU Code	[Disabled]		
Split Lock operations	[Enabled]		
Cl Enhanced Mode	[Enabled]		
No Execute Mode Mem Protection	[Enabled]		
Adjacent Cache Line Prefetch	[Enabled]		
Set Max Ext CPUID = 3	[Disabled]		
Echo TPR	[Disabled]		
F1 Help	↑↓ Select Item	-/+ Change Values	F9 Setup Defaults
ESC Exit	→← Select Menu	Enter Select	F10 Save and Exit
		▶ Sub-Menu	

### For Xeon 5100 Series CPU

PhoenixBIOS Setup Utility			
Advanced			
Advanced Processor Options		Item Specific Help	
Multiprocessor Specification	[1.4]	Configures the MP Specification revision level. Some operating systems will require 1.1 for compatibility reasons.	
Numbers of Stop Grant	[Per Core]		
Intel(R) Virtualization Technology	[Enabled]		
Machine Checking	[Enabled]		
Fast String Operations	[Enabled]		
Compatible FPU Code	[Disabled]		
Split Lock operations	[Enabled]		
Cl Enhanced Mode	[Enabled]		
No Execute Mode Mem Protection	[Enabled]		
Adjacent Cache Line Prefetch	[Enabled]		
Set Max Ext CPUID = 3	[Disabled]		
Echo TPR	[Disabled]		
F1 Help	↑↓ Select Item		-/+ Change Values
ESC Exit	→← Select Menu	Enter Select	F10 Save and Exit
		▶ Sub-Menu	

Scroll down to display the following item:

Advanced Processor Options				Item Specific Help	
Discrete MTRR Allocation		[Disabled]			
Intel EIST support:		[Enabled]			
F1 Help	↑↓	Select Item	-/+	Change Values	F9 Setup Defaults
ESC Exit	←→	Select Menu	Enter	Select ▶ Sub-Menu	F10 Save and Exit

## Multiprocessor Specification [1.4]

Allows you to configure the MP Specification revision level. Configuration options: [1.1] [1.4]



The following screens appear when you install Intel® Xeon 5000 series CPU.

## Frequency Ratio [Default]

Allows you to select the processor frequency ratio. Configuration options: [Default] [X 12] [X 13] [X 14] [X 15] [X 16] [X 17]

## Hyperthreading [Enabled]

Allows you to enable or disable the Intel® Hyper-Threading Technology feature. Configuration options: [Disabled] [Enabled]



The following screens appear when you install Intel® Xeon 5100 series CPU.

## Numbers of Stop Grant [Per Core]

Allows you to select the numbers of stop grant. Configuration options: [Single] [Per Core]



The following screens appear when you install either Intel® Xeon 5000 and 5100 series CPUs.

## Intel(R) Virtualization Technology [Enabled]

Configuration options: [Disabled] [Enabled]

## Machine Checking [Enabled]

Configuration options: [Disabled] [Enabled]

## Fast String Operations [Enabled]

Configuration options: [Disabled] [Enabled]

## Compatible FPU Code [Disabled]

Configuration options: [Disabled] [Enabled]

## Split Lock operations [Enabled]

Configuration options: [Disabled] [Enabled]

## C1 Enhanced Mode [Enabled]

Allows you to enable or disable C1E mode. In C1E mode, the CPU power consumption is lower when idle. Configuration options: [Disabled] [Enabled]

## Echo TPR [Disabled]

Configuration options: [Disabled] [Enabled]

## Discrete MTRR Allocation [Disabled]

Configuration options: [Disabled] [Enabled]

## Intel EIST support [Enabled]

Enables or disables EIST support. Configuration options: [Disabled] [Enabled]

## No Execute Mode Mem Protection [Enabled]

Configuration options: [Disabled] [Enabled]

## Adjacent Cache Line Prefetch [Enabled]

Configuration options: [Disabled] [Enabled]

## Set Max Ext CPUID = 3 [Disabled]

Enable this item to boot legacy operating systems that cannot support CPUs with extended CPUID functions. Configuration options: [Disabled] [Enabled]

## 5.4.2 Chipset Configuration

This menu shows the chipset configuration settings. Select an item then press <Enter> to display a pop-up menu with the configuration options.

PhoenixBIOS Setup Utility			
Advanced			
Chipset Configuration		Item Specific Help	
Crystal Beach Configure Enable	[Enabled]	Enable Configuration/ Memory mapped accesses to the Crystal Beach Configuration space located in Device 8, Fn 0, and Fn 1.	
SERR Signal Condition	[Single Bit]		
Demand Scrub Enable	[Enabled]		
Patrol Scrub Enable	[Enabled]		
4GB PCI Hole Granularity	[256 MB]		
Memory Branch Mode	[Interleave]		
Branch 0 Rank Interleave	[4:1]		
Branch 0 Rank Sparing	[Disabled]		
Enhanced x8 Detection	[Enabled]		
Force ITK Config Clocking	[Disabled]		
FBDIMM(s) Thermal Throttling	[Open Loop]		
Open Loop Type	[Best Performan]		
Environment Temperature	[025 °C]		
F1 Help	↑↓ Select Item	-/+ Change Values	F9 Setup Defaults
ESC Exit	→← Select Menu	Enter Select	F10 Save and Exit
		▶ Sub-Menu	

Scroll down to display the following item:

Temperature Rise	[025 °C]		
FBDIMM(S) Air Flow	[2.0]		
F1 Help	↑↓ Select Item	-/+ Change Values	F9 Setup Defaults
ESC Exit	→← Select Menu	Enter Select	F10 Save and Exit
		▶ Sub-Menu	

### **Crystal Beach Configure Enable [Enabled]**

Allows you to enable or disable the Configuration/Memory mapped accesses to the Crystal Beach Configuration space located in Device 8, Fn 0, and Fn 1. Configuration options: [Disabled] [Enabled]

### **SERR Signal Condition [Single Bit]**

Allows you to select the ECC error that the SERR# asserts. Configuration options: [None] [Single Bit] [Multiple Bit] [Both]

### **Demand Scrub Enable [Enabled]**

Enables or disables the Demand Scrubbing. Configuration options: [Disabled] [Enabled]

### **Patrol Scrub Enable [Enabled]**

Enables or disables the Patrol Scrubbing. Configuration options: [Disabled] [Enabled]

### **4GB PCI Hole Granularity [256 MB]**

Allows you to select the granularity of the PCI hole for PCI resource. Configuration options: [256 MB] [512 MB] [1.0 GB] [2.0 GB]

### **Memory Branch Mode [Interleave]**

Allows you to select the memory branch mode. Configuration options: [Sequential] [Interleave] [Mirror] [Single channel 0]

### **Branch 0 Rank Interleave [4:1]**

Allows you to select the Branch 0 Rank Interleave. Configuration options: [1:1] [2:1] [4:1]

### **Branch 0 Rank Sparing [Disabled]**

Allows you to enable or disable the Branch 0 rank/DIMM Sparing feature. Configuration options: [Disabled] [Enabled]

### **Enhanced x8 Detection [Enabled]**

Allows you to enable or disable the enhanced x8 DRAM UC error detection. Configuration options: [Disabled] [Enabled]

### **Force ITK Config Clocking [Disabled]**

Allows you to enable or disable the FBD configuration for ITK test suite. Configuration options: [Disabled] [Enabled]

### **FBDIMM(s) Thermal Throttling [Open Loop]**

Allows you to disable or set the thermal throttling control. Configuration options: [Open Loop] [Close Loop] [ASUS MemCool Fan] [Disabled]

### **Open Loop Type [Best Performance]**

Allows you to select the Open Loop Type. Configuration options: [Best Performance] [Best Acoustic] [User Define]

## 5.4.3 PCI Configuration

This menu shows the PCI configuration settings. Select an item then press <Enter> to display the configuration options.

PhoenixBIOS Setup Utility		
Advanced		
PCI Configuration		Item Specific Help
Reset Configuration Data	[No]	Select 'Yes' if you want to clear the Extended System Configuration Data (ESCD) area.
Plug & Play OS	[No]	
Palette Snooping	[Disabled]	
▶ PCI Device, Slot #1		
▶ PCI Device, Slot #2		
▶ PCI Device, Slot #3		
▶ PCI Device, Slot #4		
▶ PCI Device, Slot #5		
▶ PCI Device, Slot #6		
F1 Help	↑↓ Select Item	-/+ Change Values
ESC Exit	→← Select Menu	Enter Select ▶ Sub-Menu
		F9 Setup Defaults
		F10 Save and Exit

### Reset Configuration Data [No]

This item allows you to clear the Extended System Configuration Data (ESCD) area. Configuration options: [No] [Yes]

### Plug & Play O/S [No]

When set to [No], BIOS configures all the devices in the system. When set to [Yes] and if you install a Plug and Play operating system, the operating system configures the Plug and Play devices not required for boot. Configuration options: [No] [Yes]

### Palette Snooping [Disabled]

When set to [Enabled], the palette snooping feature informs the PCI devices that an ISA graphics device is installed in the system so that the latter can function correctly. Configuration options: [Disabled] [Enabled]

## PCI Device, Slot #1~6

Allows you to configure the specific PCI devices.

PhoenixBIOS Setup Utility							
Advanced							
PCI Device, Slot #1				Item Specific Help			
Optional ROM Scan: [Enabled]				Initialize device expansion ROM			
F1	Help	↑↓	Select Item	-/+	Change Values	F9	Setup Defaults
ESC	Exit	→←	Select Menu	Enter	Select Sub-Menu	F10	Save and Exit

### Optional ROM Scan [Enabled]

Allows you to enable or disable the device expansion ROM.  
Configuration options: [Enabled] [Disabled]

## 5.4.4 ICH USB Control Sub-Menu

The items in this menu allow you to display the USB configuration settings. Select an item then press <Enter> to display the configuration options.

PhoenixBIOS Setup Utility	
Advanced	
ICH USB Control Sub-Menu	Item Specific Help
USB Function [Enabled]	Enable USB host controller.
USB 2.0 Controller [Enabled]	
Legacy USB Support: [Enabled]	

F1 Help    ↑↓ Select Item    -/+ Change Values    F9 Setup Defaults  
ESC Exit    →← Select Menu    Enter Select Sub-Menu    F10 Save and Exit

### USB Function [Enabled]

Allows you to enable the USB host controller. Configuration options: [Disabled] [Enabled]



The following items appear only if you enable the USB Function item.

### USB 2.0 Controller [Enabled]

Allows you to enable or disable the USB 2.0 controller. Setting this item to [Enabled] allows the built-in high speed USB support in the BIOS to turn on automatically when you install high speed USB devices. Configuration options: [Disabled] [Enabled]

### Legacy USB Support [Enabled]

Allows you to enable or disable support for USB devices on legacy operating systems (OS). Setting to [Enabled] allows the system to detect the presence of USB devices at startup. If detected, the USB controller legacy mode is enabled. If no USB device is detected, the legacy USB support is disabled. Configuration options: [Disabled] [Enabled]

## 5.4.5 Peripheral Devices Configuration

This menu shows the peripheral devices configuration settings. Select an item then press <Enter> to display the configuration options.

PhoenixBIOS Setup Utility		
Advanced		
Peripheral Devices Configuration		Item Specific Help
COM1 Port:	[Enabled]	Configure serial port A using option:
Base I/O address:	[3F8]	
Interrupt:	[IRQ 4]	[Disabled]
COM2 Port:	[Enabled]	No configuration
Mode:	[Normal]	[Enabled]
Base I/O address:	[2F8]	User configuration
Interrupt:	[IRQ 3]	[Auto]
Parallel port:	[Enabled]	BIOS or OS chooses configuration
Base I/O address:	[378]	[OS Controlled]
Interrupt:	[IRQ 7]	Displayed when controlled OS
Mode:	[ECP]	
DMA channel	[DMA 3]	
Floppy disk controller	[Enabled]	

F1 Help	↑↓ Select Item	-/+ Change Values	F9 Setup Defaults
ESC Exit	→← Select Menu	Enter Select ▶ Sub-Menu	F10 Save and Exit

### COM1 Port [Enabled]

Allows you to configure serial port A. Configuration options: [Disabled] [Enabled] [Auto]

Base I/O address [3F8]

Allows you to select the base I/O address for serial port A. Configuration options: [3F8] [2F8] [3E8] [2E8]

Interrupt [IRQ 4]

Allows you to set the interrupt for serial port A. Configuration options: [IRQ 3] [IRQ 4]

### COM2 Port [Enabled]

Allows you to configure serial port B. Configuration options: [Disabled] [Enabled] [Auto]

Mode [Normal]

Allows you to set the mode for serial port B. Configuration options: [Normal] [IR] [ASK-IR]

### Base I/O address [2F8]

Allows you to select the base I/O address for serial port B. Configuration options: [3F8] [2F8] [3E8] [2E8]



### Interrupt [IRQ 3]

Allows you to set the interrupt for serial port B. Configuration options: [IRQ 3] [IRQ 4]

### **Parallel port [Enabled]**

Allows you to configure the parallel port. Configuration options: [Disabled] [Enabled] [Auto]

### **Base I/O address [378]**

Allows you to select the base I/O address for the parallel port. Configuration options: [378] [278] [3BC]

### Interrupt [IRQ 7]

Allows you to set the interrupt for the parallel port. Configuration options: [IRQ 5] [IRQ 7]

### Mode [ECP]

Allows you to set the mode for the parallel port. Configuration options: [Output only] [Bi-directional] [EPP] [ECP]

### DMA channel [DMA 3]

Allows you to set the DMA channel for the parallel port. Configuration options: [DMA 1] [DMA 3]

### **Floppy disk controller [Enabled]**

Allows you to configure the floppy disk controller. Configuration options: [Disabled] [Enabled] [Auto]

## 5.4.6 ACPI Configuration

This menu shows the Advanced Configuration and Power Interface (ACPI) configuration settings. Select an item then press <Enter> to display the configuration options.

PhoenixBIOS Setup Utility		
Advanced		
ACPI Configuration		Item Specific Help
ACPI Version Features	[ACPI v1.0]	Enable RSDP pointers to 64-bit Fixed System Description Tables.
Headless Mode	[Disabled]	
ACPI EMS Support	[Disabled]	

F1 Help    ↑↓ Select Item    -/+ Change Values    F9 Setup Defaults  
ESC Exit    →← Select Menu    Enter Select    F10 Save and Exit

### ACPI Version Features [ACPI v1.0]

Allows you to enable RSDP pointers to 64-bit fixed system description tables. Configuration options: [ACPI v1.0] [ACPI v2.0] [ACPI v3.0]

### Headless Mode [Disabled]

Allows you to enable or disable the headless operation mode through ACPI. Configuration options: [Disabled] [Enabled]

### ACPI EMS Support [Disabled]

Allows you to enable or disable the ACPI EMS support. Configuration options: [Disabled] [Enabled]

## 5.4.7 Power On Configuration

This menu shows the power configuration settings. Select an item then press <Enter> to display the configuration options.

PhoenixBIOS Setup Utility	
Advanced	
Power On Configuration	Item Specific Help
Restore on AC Power Loss [Last State]	Configures the system state after recovering from power failure.
Power On By PS/2 Keyboard [Disabled]	
Power On By PS/2 Mouse [Disabled]	
Power On By PME# [Disabled]	
Power-On By RTC Alarm [Disabled]	

F1 Help    ↑↓ Select Item    -/+ Change Values    F9 Setup Defaults  
ESC Exit    →← Select Menu    Enter Select    ▶ Sub-Menu    F10 Save and Exit

### Restore on AC Power Loss [Last State]

When set to [Power Off], the system goes into “off state” after an AC power interruption. When set to [Power On], the system turns on automatically after a power interruption. When set to [Last State], the system goes into whatever was the system state (on or off) before the power interruption. Configuration options: [Power Off] [Power On] [Last State]

### Power Up By PS/2 Keyboard [Disabled]

Allows you to use specific keys on the PS/2 keyboard to turn on the system. This feature requires an ATX power supply that provides at least 1A on the +5VSB lead. Configuration options: [Enabled] [Disabled]

### Power Up By PS/2 Mouse [Disabled]

When set to [Enabled], this parameter allows you to use the PS/2 mouse to turn on the system. This feature requires an ATX power supply that provides at least 1A on the +5VSB lead. Configuration options: [Enabled] [Disabled]

### Power On By PME# [Disabled]

Allows you to enable or disable the PME and onboard LAN to generate a wake-up event. Configuration options: [Disabled] [Enabled]

### Power On By RTC Alarm [Disabled]

Allows you to enable or disable RTC to generate a wake-up event. Configuration options: [Disabled] [Enabled]



The following items appear only if you enable the Power On By RTC Alarm item.

### RTC Alarm Date [0]

To set the date of alarm, highlight this item and press <Enter> to display a date chart. Press <+> or <-> to change scroll through the options, then press <Enter> when done. The default setting [0] is equivalent to everyday alarm. Configuration options: [0] [1] ~ [31]

### RTC Alarm Date [00 : 00 : 00]

To set the time of alarm:

1. Press <+> or <-> to set the desired value.
2. Use the left/right arrow key or press <Tab> to move to the next field.
3. Press <Enter> when done.

## 5.4.8 Hardware Monitor

This menu shows the hardware monitor configuration settings. Select an item then press <Enter> to display the configuration options.



The following screens appear when you install Intel® 5000 series CPU.

PhoenixBIOS Setup Utility					
Advanced					
Hardware Monitor					Item Specific Help
CPU1 Domain 0 Temperature	39°C/102°F				Full fan speed will be started when the temperature reaches the selected target value.
CPU1 Domain 1 Temperature	29°C/84°F				
CPU2 Domain 0 Temperature	0°C/32°F				
CPU2 Domain 1 Temperature	0°C/32°F				
SYSTEM1 Temperature	39°C/102°F				
SYSTEM2 Temperature	29°C/84°F				
CPU_FAN1 Speed	2925 RPM				
CPU_FAN2 Speed	N/A				
FRN_FAN1 Speed	N/A				
FRN_FAN2 Speed	N/A				
FRN_FAN3 Speed	N/A				
FRN_FAN4 Speed	N/A				
REAR_FAN1 Speed	N/A				
REAR_FAN2 Speed	N/A				
Smart Fan Control	[Smart Fan II]				
F1 Help	↑↓ Select Item	-/+ Change Values	F9 Setup Defaults		
ESC Exit	→← Select Menu	Enter Select	▶ Sub-Menu	F10 Save and Exit	

Scroll down to display more items:

PhoenixBIOS Setup Utility			
Advanced			
Hardware Monitor			Item Specific Help
CPU1 Domain 0 Target Temperature	[075]		Full fan speed will be started when the temperature reaches the selected target value.
CPU1 Domain 1 Target Temperature	[075]		
CPU2 Domain 0 Target Temperature	[075]		
CPU2 Domain 1 Target Temperature	[075]		
SYSTEM1 Target Temperature	[060°C]		
SYSTEM2 Target Temperature	[060°C]		
FBD_FAN1 Speed	N/A		
VCORE0 Voltage	1.25 V		
VCORE1 Voltage	1.25 V		
VTT	1.21 V		
+1.5V	1.56 V		
+1.8V	1.79 V		
+3V	3.28 V		
+12V	11.91 V		
+5V	4.87 V		
+5VSB	4.96 V		
VBAT	3.10 V		
F1 Help	↑↓ Select Item	-/+ Change Values	F9 Setup Defaults
ESC Exit	→← Select Menu	Enter Select ▶ Sub-Menu	F10 Save and Exit



The following screens appear when you install Intel® 5100 series CPU.

PhoenixBIOS Setup Utility			
Advanced			
Hardware Monitor			Item Specific Help
CPU1 Throttle Temperature Margin	39°C/102°F		Full fan speed will be started when the temperature reaches the selected target value.
CPU2 Throttle Temperature Margin	29°C/84°F		
SYSTEM1 Temperature	39°C/102°F		
SYSTEM2 Temperature	29°C/84°F		
CPU_FAN1 Speed	2925 RPM		
CPU_FAN2 Speed	N/A		
FRN_FAN1 Speed	N/A		
FRN_FAN2 Speed	N/A		
FRN_FAN3 Speed	N/A		
FRN_FAN4 Speed	N/A		
REAR_FAN1 Speed	N/A		
REAR_FAN2 Speed	N/A		
Smart Fan Control	[Smart Fan II]		
F1 Help	↑↓ Select Item	-/+ Change Values	F9 Setup Defaults
ESC Exit	→← Select Menu	Enter Select ▶ Sub-Menu	F10 Save and Exit

Scroll down to display more items:

PhoenixBIOS Setup Utility			
Advanced			Item Specific Help
Hardware Monitor			Item Specific Help
CPU1 Throttle Temperature Margin	[060]		Full fan speed will be started when the temperature reaches the selected target value.
CPU2 Throttle Temperature Margin	[060]		
SYSTEM1 Target Temperature	[050]		
SYSTEM2 Target Temperature	[050]		
FBD_FAN1 Speed	N/A		
VCORE0 Voltage	1.25 V		
VCORE1 Voltage	1.25 V		
VTT	1.21 V		
+1.5V	1.56 V		
+1.8V	1.79 V		
+3V	3.28 V		
+12V	11.91 V		
+5V	4.87 V		
+5VSB	4.96 V		
VBAT	3.10 V		

F1 Help	↑↓ Select Item	-/+ Change Values	F9 Setup Defaults
ESC Exit	←→ Select Menu	Enter Select ▶ Sub-Menu	F10 Save and Exit

### **CPU1/2 Domain 0/1 Temperature (CPU1/2 Throttle Temperature Margin), SYSTEM1/2 Temperature, CPU\_FAN1/2 Speed, FRN\_FAN1/2/3/4 Speed, REAR\_FAN1/2 Speed**

These fields show the auto-detected values and are not user-configurable. If no fan is installed, the field shows 0 RPM.

### **Smart Fan Control [Smart Fan II]**

Allows you to disable or configure the Smart Fan feature. Configuration options: [Disabled] [Smart Fan] [Smart Fan II]

### **CPU1/2 Domain 0/1 Target Temperature (CPU1/2 Throttle Temperature Margin)**

Allows you to set the target CPU temperature at which the CPU fan will start running if the fan is not yet turned on. Configuration options: [54]~[76]

### **SYSTEM1/2 Target Temperature**

Allows you to set the target system temperature at which the system fan will start running if the fan is not yet turned on. Configuration options: [39]~[60]

### **FBD\_FAN1 Speed, VCORE0/1 Voltage, VTT, +1.5V, +1.8V, +3V, +12V, +5V, +5VSB, VBAT**

These fields show the auto-detected values and are not user-configurable.

# 5.5 Server menu

This Server menu items allow you to customize the server features.

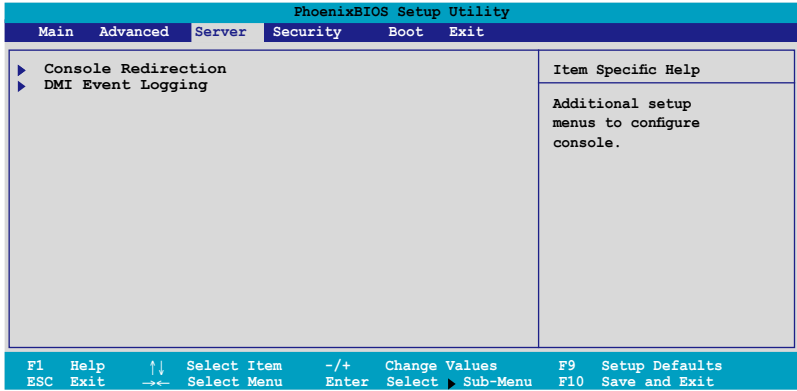

## 5.5.1 Console Redirection

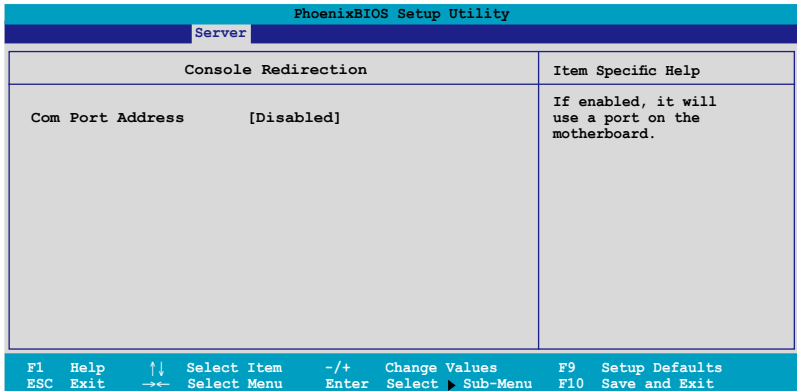

### Com Port Address [Disabled]

Allows you to disable or select the COM port to use. Configuration options: [Disabled] [On-board COM A] [On-board COM B]



---

The following items appear only if you set the Com Port Address item to [On-board COM A] or [On-board COM B].

---

### **Baud Rate [115.2K]**

Allows you to enable the specified baud rate. Configuration options: [300] [1200] [2400] [9600] [19.2K] [38.4K] [57.6K] [115.2K]

### **Console Type [PC-ANSI, 7bit]**

Allows you to enable the specified console type. Configuration options: [VT100] [VT100, 8bit] [PC-ANSI, 7bit] [PC ANSI] [VT100+] [VT-UTF8] [ASCII]

### **Flow Control [CTS/RTS]**

Allows you to select the flow control for console redirection. Configuration options: [None] [XON/XOFF] [CTS/RTS]

### **Console connection [Direct]**

Allows you to select the console connection. [Direct] indicates that the console is connected directed to the system. [Via modem] indicates that a modem is used to connect. Configuration options: [Direct] [Via modem]

### **Continue C.R. after POST [Off]**

Set this item to [On] if you want console redirection to continue after the operating system has loaded. Configuration options: [Off] [On]

### **# of video pages to support [1]**

Allows you to set the number of video pages to allocate for console redirection when the video hardware is not available. Press <-> or <+> to set the value, or enter the value using the numeric keypad. Configuration options: [1] ~ [8]



## 5.5.2 DMI Event Logging

PhoenixBIOS Setup Utility		
Server		
DMI Event Logging		Item Specific Help
Event log validity	valid	View the contents of the DMI event log.
Event log capacity	Space Available	
View DMI event log	[Enter]	
Event Logging	[Enabled]	
ECC Event Logging	[Enabled]	
Mark DMI events as read	[Enter]	
Clear all DMI event logs	[No]	

F1 Help    ↑↓ Select Item    -/+ Change Values    F9 Setup Defaults  
ESC Exit    →← Select Menu    Enter Select    ▶ Sub-Menu    F10 Save and Exit

### Event log validity, Event log capacity

Displays the auto-detected system information.

### View DMI event log [Enter]

Press <Enter> to view the contents of the DMI event log.

### Event Logging [Enabled]

Enables or disables to allow logging of DMI events. Configuration options: [Disabled] [Enabled]

### ECC Event Logging [Enabled]

Enables or disables to allow logging of ECC events. Configuration options: [Disabled] [Enabled]

### Mark DMI events as read [Enter]

Enter to mark all DMI events in the event log as read.

### Clear all DMI event logs [No]

Allows you to keep or clear the DMI event log after rebooting. Configuration options: [No] [Yes]

# 5.6 Security menu

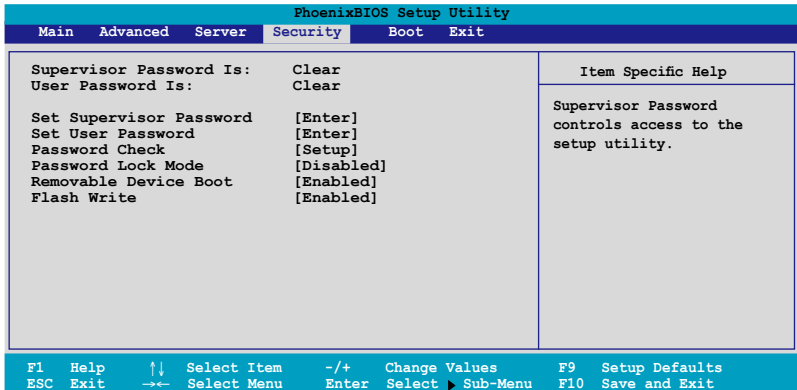

## Supervisor Password Is [Clear]

## User Password Is [Clear]

These fields allow you to set passwords:

To set a password:

1. Select an item then press <Enter>.
2. Type in a password using a combination of a maximum of eight (8) alpha-numeric characters, then press <Enter>.
3. When prompted, confirm the password by typing the exact characters again, then press <Enter>. The password field setting is changed to Set.

To clear the password:

1. Select the item Set Supervisor Password or Set User Password, depending on which password you want to clear. Press <Enter>.

The following message appears:

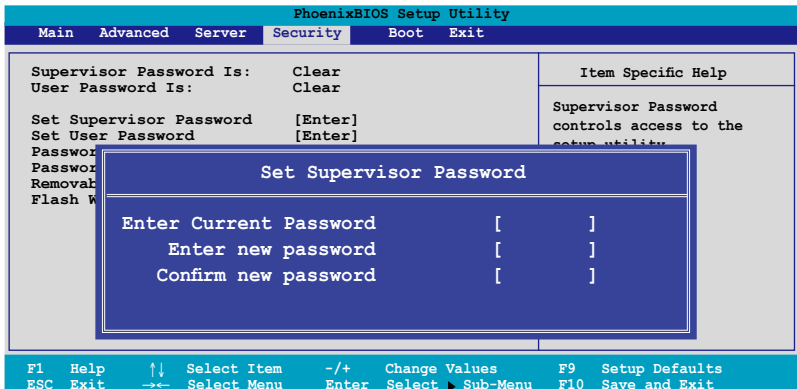

2. In the Enter current password field, type in your current password. Press <Enter>.
3. The cursor moves to the next field, Enter new password. Press <Enter>. Do not type anything in this field.
4. The cursor moves to the next field, Confirm new password. Press <Enter>. Do not type anything in this field.
5. When the confirmation message "Password has been changed" appears, press <Enter>.  
The display returns to the Security menu. Note that the password field on top is changed to Clear.

#### A note about passwords

The Supervisor password is required to enter the BIOS Setup program preventing unauthorized access. The User password is required to boot the system preventing unauthorized use.

#### Forgot your password?

If you forget your password, you can clear it by erasing the CMOS Real Time Clock (RTC) RAM. The RAM data containing the password information is powered by the onboard button cell battery. If you need to erase the CMOS RAM, refer to section "4.2 Jumpers" for instructions.

### **Password Check [Setup]**

This field requires you to enter the password before entering the BIOS setup or the system. Select [Setup] to require the password before entering the BIOS Setup. Select [System] to require the password before entering the system. Configuration options: [Setup] [Always]

### **Password Lock Mode [Enabled]**

When set to [Enabled], the keyboard is locked and the user has no privilege to launch the BIOS setup utility when installing adapter cards during option ROM initialization. Configuration options: [Disabled] [Enabled]

### **Removable Device Boot [Enabled]**

Allows you to enable or disable booting from a legacy floppy, USB floppy, or IDE optical drive. Configuration options: [Disabled] [Enabled]

### **Flash Write [Enabled]**

Set this item to [Disabled] to write-protect the BIOS flash memory. Configuration options: [Disabled] [Enabled]

# 5.7 Boot menu

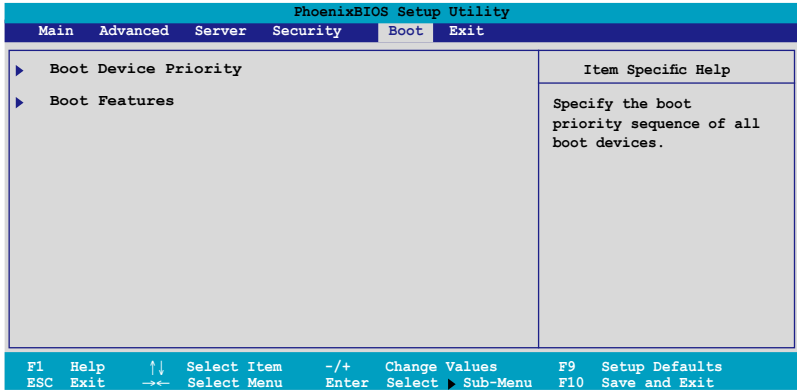

## 5.7.1 Boot Device Priority

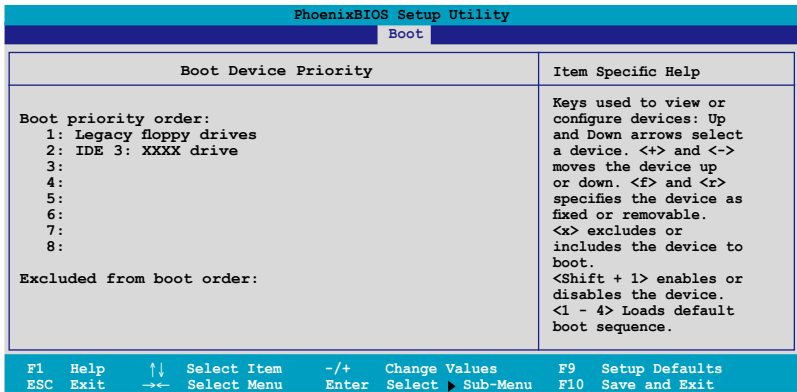

Refer to the following table for keys assigned to configure devices.

Key/s	Use this key to...
<Up arrow> / <Down arrow>	select a device.
<+> / <->	move the device up or down.
<f> / <r>	specify the device as fixed or removable.
<x>	exclude or include the device to boot.
<Shift + 1>	enable or disable the device.
<1 - 4>	load default boot sequence.

## 5.7.2 Boot Features

PhoenixBIOS Setup Utility		
		Boot
Boot Features		Item Specific Help
Quick Boot	[Enabled]	Allows the BIOS to skip certain tests while booting. This will decrease the time needed to boot the system.
Full Logo Display	[Enabled]	
Bootup Num-Lock	[On]	
PS/2 Mouse	[Auto Detect]	
Summary screen:	[Enabled]	
POST Errors	[Enabled]	
SETUP prompt	[Enabled]	
Interrupt 19 Capture	[Enabled]	

F1 Help	↑↓ Select Item	-/+ Change Values	F9 Setup Defaults
ESC Exit	→← Select Menu	Enter Select	F10 Save and Exit
		▶ Sub-Menu	

### Quick Boot [Enabled]

Enabling this item allows the BIOS to skip some power on self tests (POST) while booting to decrease the time needed to boot the system. When set to [Disabled], BIOS performs all the POST items. Configuration options: [Disabled] [Enabled]

### Full Logo Display [Enabled]

Allows you to enable or disable the full screen logo display feature. Configuration options: [Disabled] [Enabled]

### Bootup Num-Lock [On]

Allows you to select the power-on state for the NumLock. Configuration options: [Auto] [On] [Off]

### PS/2 Mouse [Auto Detect]

Allows you to enable or disable support for PS/2 mouse. Configuration options: [Disabled] [Enabled] [Auto Detect]

### Summary screen: [Enabled]

When this item is enabled, the system configuration is displayed during POST. Configuration options: [Disabled] [Enabled]

### POST Errors [Enabled]

When set to Enabled, the system waits for the F1 key to be pressed when error occurs. Configuration options: [Disabled] [Enabled]

## SETUP prompt [Enabled]

When this item is set to Enabled, the system displays the message “Press DEL to run Setup” during POST. Configuration options: [Disabled] [Enabled]

## Interrupt 19 Capture [Enabled]

When set to [Enabled], this function allows the option ROMs to trap Interrupt 19. Configuration options: [Disabled] [Enabled]

# 5.8 Exit menu

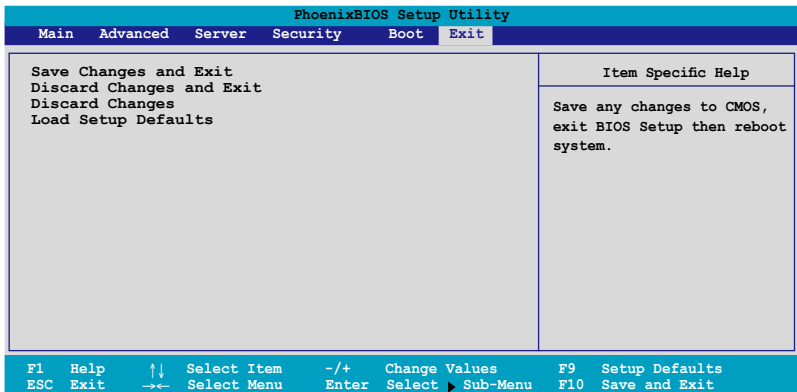

### Save Changes and Exit

Select this option then press <Enter>, or simply press <F10>, to save your changes to CMOS before exiting the Setup utility.

When a confirmation window appears:

- select [Yes], then press <Enter> to save and exit.
- select [No], then press <Enter>, or simply press <Esc>, to cancel the command and return to the Exit menu.

### Discard Changes and Exit

Select this option then press <Enter> if you wish to exit the Setup utility without saving your changes.

When a confirmation window appears:

- select [Yes], then press <Enter> to discard your changes and exit.
- select [No], then press <Enter>, or simply press <Esc>, to cancel the command and return to the Exit menu.

## **Discard Changes**

Select this option to discard the changes that you made, and restore the previously saved values.

When a confirmation window appears:

- select [Yes], then press <Enter> to discard any changes and load the previously saved values.
- select [No], then press <Enter>, or simply press <Esc>, to cancel the command and return to the Exit menu.

## **Load Setup Defaults**

Select this option then press <Enter>, or simply press <F9>, to load the optimized values for each of the Setup menu items.

When a confirmation window appears:

- select [Yes], then press <Enter> to load the default values.
- select [No], then press <Enter>, or simply press <Esc>, to cancel the command and return to the Exit menu.

A series of 26 horizontal lines for writing.



# Chapter 6

This chapter provides instructions for setting up, creating and configuring RAID sets using the available utilities.



# RAID Configuration

## 6.1 Setting up RAID

The Intel® 6321ESB Southbridge chip comes with the LSI Logic Embedded SATA RAID Utility and the Intel® Matrix Storage Manager. These utilities support SATA hard disk drives and allow creation of RAID 0, RAID 1, RAID 0+1, or RAID 5 (Intel® Matrix Storage Manager only) configuration.



---

This chapter provides instructions for TS500-E4/PA4 model only. For TS500-E4/PX4, refer to the SAS/RAID card user guide which may be contained in its driver CD.

---

### 6.1.1 RAID definitions

RAID 0 (Data striping) optimizes two identical hard disk drives to read and write data in parallel, interleaved stacks. Two hard disks perform the same work as a single drive but at a sustained data transfer rate, double that of a single disk alone, thus improving data access and storage. Use of two new identical hard disk drives is required for this setup.

RAID 1 (Data mirroring) copies and maintains an identical image of data from one drive to a second drive. If one drive fails, the disk array management software directs all applications to the surviving drive as it contains a complete copy of the data in the other drive. This RAID configuration provides data protection and increases fault tolerance to the entire system. Use two new drives or use an existing drive and a new drive for this setup. The new drive must be of the same size or larger than the existing drive.

RAID 5 stripes both data and parity information across three or more hard disk drives. Among the advantages of RAID 5 configuration include better HDD performance, fault tolerance, and higher storage capacity. The RAID 5 configuration is best suited for transaction processing, relational database applications, enterprise resource planning, and other business systems. Use a minimum of three identical hard disk drives for this setup.

RAID 0+1 is data striping and data mirroring combined without parity (redundancy data) having to be calculated and written. With the RAID 0+1 configuration you get all the benefits of both RAID 0 and RAID 1 configurations. Use four new hard disk drives or use an existing drive and three new drives for this setup.



---

If you want to boot the system from a hard disk drive included in a created RAID set, copy first the RAID driver from the support CD to a floppy disk before you install an operating system to the selected hard disk drive.

---

## 6.1.2 Installing hard disk drives

The motherboard supports Serial ATA for RAID set configuration. For optimal performance, install identical drives of the same model and capacity when creating a disk array.

To install the SATA hard disks for RAID configuration:

1. Install the SATA hard disks into the drive bays following the instructions in the system user guide.
2. Connect a SATA signal cable to the signal connector at the back of each drive and to the SATA connector on the motherboard.
3. Connect a SATA power cable to the power connector on each drive.

## 6.1.3 Setting the RAID item in BIOS

You must set the RAID item in the BIOS Setup before you can create a RAID set from SATA hard disk drives attached to the SATA connectors supported by the Intel® 6321ESB Southbridge chip. To do this:

1. Enter the BIOS Setup during POST.
2. Go to the Main Menu > IDE Configuration > S-ATA Configuration, then press <Enter>.
3. Set the SATA Controller Mode Option item to [Enhanced], then press <Enter>.
4. Set the SATA RAID Enable item to [Enabled].
5. Save your changes, then exit the BIOS Setup.



---

Refer to Chapter 5 for details on entering and navigating through the BIOS Setup.

---

## 6.1.4 RAID configuration utilities

Depending on the RAID connectors that you use, you can create a RAID set using the utilities embedded in each RAID controller. For example, use the LSI Logic Embedded SATA RAID Setup Utility or the Intel® Matrix Storage Technology if you installed Serial ATA hard disk drives on the Serial ATA connectors supported by the Intel® 6321ESB Southbridge.

Refer to the succeeding sections for details on how to use each RAID configuration utility.

## 6.2 LSI Logic Embedded SATA RAID Setup Utility (Only for PA4 Model)

The LSI Logic Embedded SATA RAID Setup Utility allows you to create RAID 0, RAID 1, or RAID 10 set(s) from SATA hard disk drives connected to the SATA connectors supported by the motherboard Southbridge chip.

To enter the LSI Logic Embedded SATA RAID Setup Utility:

1. Turn on the system after installing all the SATA hard disk drives.
2. During POST, the LSI Logic Embedded SATA RAID Setup Utility automatically detects the installed SATA hard disk drives and displays any existing RAID set(s). Press <Ctrl> + <M> to enter the utility.

```
LSI Logic Embedded SATA RAID BIOS Version 5.4.05091647R
(c)2004 Copyright LSI Logic Corporation. All Rights Reserved.

LSI Logic Embedded SATA RAID Found at PCI Bus No:00 Dev No:1F
Scanning for Port 0 ... Responding: HD5722512A.S0B0 11780MB IDMA 5
Scanning for Port 1 ... Responding: HD5722512A.S0B0 11780MB IDMA 5

0! Logical drive(s) Configured.
Array# Mode Stripe Size No.Of Stripes DriveSize Status
00 Reliability 64KB(128 Sectors) 02 114376MB Online

Press Ctrl-M to run LSI Logic Embedded SATA RAID Setup Utility.
```



The LSI Logic Embedded SATA RAID auto configures to RAID 1 when the SATA to RAID Mode is enabled.

3. The utility main window appears. Use the arrow keys to select an option from the Management Menu, then press <Enter>. Refer to the Management Menu descriptions on the next page.

At the bottom of the screen is the legend box. The keys on the legend box allow you to navigate through the setup menu options or execute commands. The keys on the legend box vary according to the menu level.

Menu	Description
Configure	Allows you to create RAID 0 or RAID 1 set using the Easy Configuration or the New Configuration command. This menu also allows you to view, add, or clear RAID configurations or select the boot drive
Initialize Objects	Allows you to initialize the logical drives of a created RAID set
Rebuild	Allows you to initialize logical drives or change the logical drive parameters
Check Consistency	Allows you to rebuild failed drives
	Allows you to check the data consistency of the logical drives of a created RAID set

## 6.2.1 Creating a RAID 0 or RAID 1 set

The LSI Logic Embedded SATA RAID Setup Utility allows you to create a RAID 0 or RAID 1 set using two types of configurations: Easy and New.

In Easy Configuration, the logical drive parameters are set automatically including the size and stripe size (RAID 1 only).

In New Configuration, you manually set the logical drive parameters and assign the set size and stripe size (RAID 1 only).

### Using Easy Configuration

To create a RAID set using the Easy Configuration option:

1. From the utility main menu, highlight Configure, then press <Enter>.
2. Use the arrow keys to select Easy Configuration, then press <Enter>.



- The ARRAY SELECTION MENU displays the available drives connected to the SATA ports. Select the drives you want to include in the RAID set, then press <SpaceBar>. When selected, the drive indicator changes from READY to ONLIN A[X]-[Y], where X is the array number, and Y is the drive number.



The information of the selected hard disk drive displays at the bottom of the screen.

- Select all the drives required for the RAID set, then press <Enter>. The configurable array appears on screen.

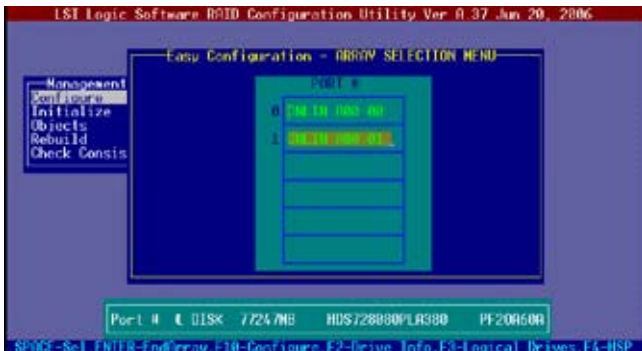

5. Press <F10>, select the configurable array, then press <SpaceBar>.

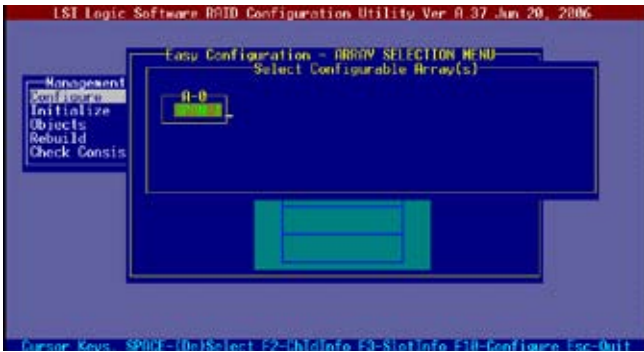

Press <F10> again, the logical drive information appears including a Logical Drive menu that allows you to change the logical drive parameters.



6. Select RAID from the Logical Drive menu, then press <Enter>.
7. Select the RAID level from the menu, then press <Enter>.



You need at least two identical hard disk drives when creating a RAID 1 set.



8. When creating a RAID 1 set, select DWC from the Logical Drive menu, then press <Enter>.  
When creating a RAID 0 set, proceed to step 10.
9. Select On to enable the Disk Write Cache setting, then press <Enter>.

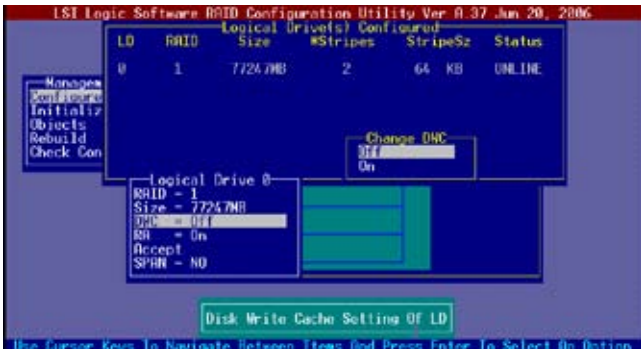

Enabling DWC can improve the performance, but with the risk of data loss.



- When finished setting the selected logical drive configuration, select Accept from the menu, then press <Enter>.

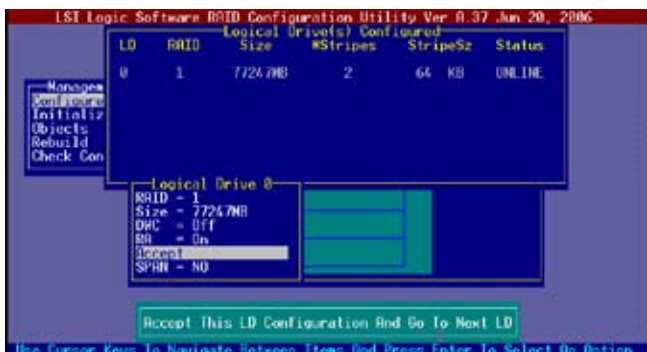

- When finished setting the selected logical drive configuration, select Accept from the menu, then press <Enter>.
- Follow steps 5 to 10 to configure additional logical drives.
- When prompted, save the configuration, then press <Esc> to return to the Management Menu.



## Using New Configuration



When a RAID set is already existing, using the New Configuration command erases the existing RAID configuration data. If you do not want to delete the existing RAID set, use the View/Add Configuration command to view or create another RAID configuration.

To create a RAID set using the New Configuration option:

1. From the utility main menu, highlight Configure, then press <Enter>.
2. Use the arrow keys to select New Configuration, then press <Enter>.



3. Follow steps 3 to 7 of the previous section.
4. Select Size from the Logical Drive menu, then press <Enter>.
5. Key-in the desired logical drive size, then press <Enter>.

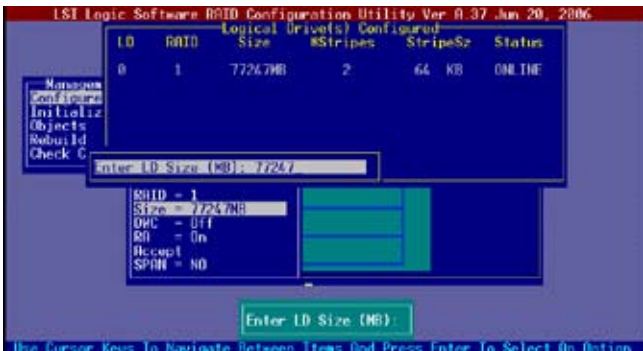

6. Follow steps 8 to 13 of the previous section to create the RAID set.

## 6.2.2 Creating a RAID 10 set

You can create a RAID 10 set using four identical hard disk drives.

To create a RAID 10 set using the Easy Configuration option:

1. From the utility main menu, highlight Configure, then press <Enter>.
2. Use the arrow keys to select Easy Configuration, then press <Enter>.



3. The ARRAY SELECTION MENU displays the available drives connected to the SATA ports. Select the drive(s) you want to include in the RAID set, then press <SpaceBar>. When selected, the drive indicator changes from READY to ONLIN A[X]-[Y], where X is the array number, and Y is

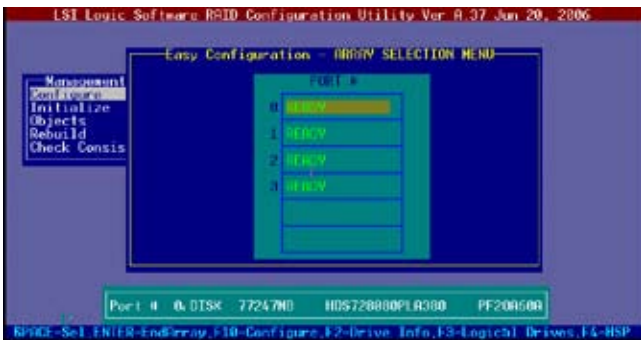

The information of the selected hard disk drive displays at the bottom of the screen.

4. Select all the drives required for the RAID 10 set, then press <Enter>. The configurable array appears on screen.

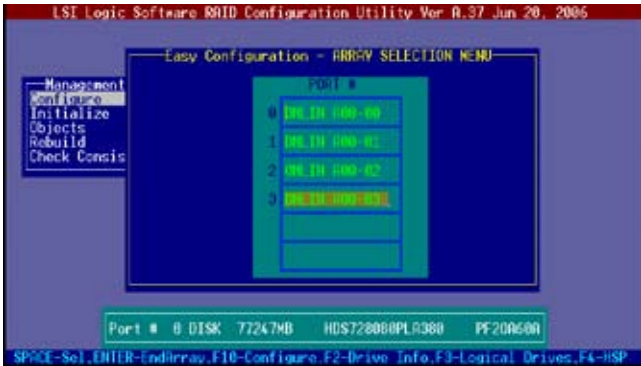

5. Press <F10>, select the configurable array, then press <SpaceBar>.



Press <F10> again, the logical drive information appears including a Logical Drive menu that allows you to change the logical drive parameters.

6. Select RAID from the Logical Drive menu, then press <Enter>.
7. Select RAID 10 from the menu, then press <Enter>.



You need at least four identical hard disk drives when creating a RAID 10 set.

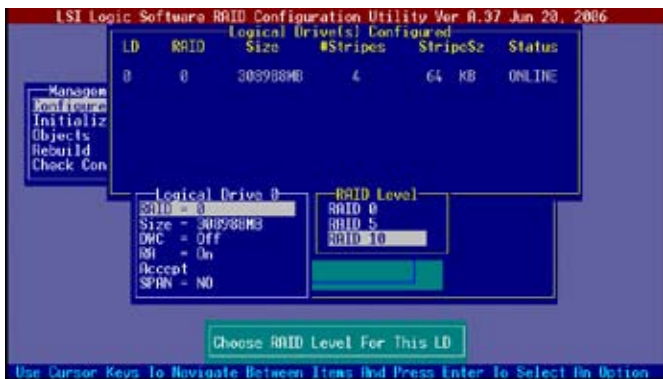

8. Select DWC from the Logical Drive menu, then press <Enter>.
9. Select On to enable the Disk Write Cache setting, then press <Enter>.

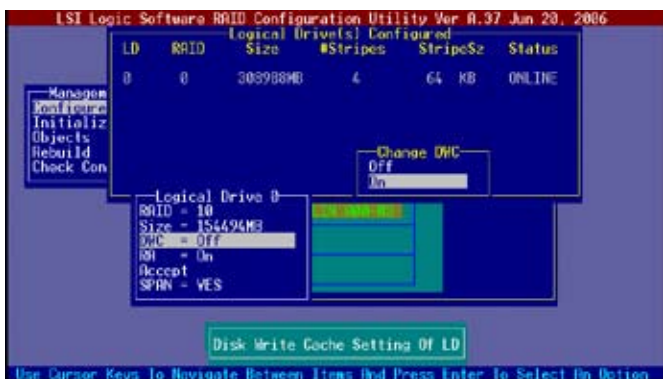

10. When finished setting the selected logical drive configuration, select Accept from the menu, then press <Enter>.

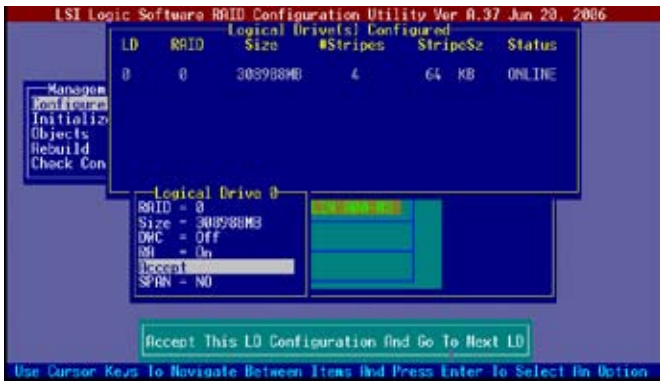

11. When prompted, save the configuration, then press <Esc> to return to the Management Menu.



## 6.2.3 Adding or viewing a RAID configuration

You can add a new RAID configuration or view an existing configuration using the View/Add Configuration command.

### Adding a new RAID configuration

To add a new RAID configuration:

1. From the Management Menu, highlight Configure, then press <Enter>.
2. Use the arrow keys to select View/Add Configuration, then press <Enter>.



3. The ARRAY SELECTION MENU displays the available drives connected to the SATA ports. Select the drive(s) you want to include in the RAID set, then press <SpaceBar>. When selected, the drive indicator changes from READY to ONLIN A[X]-[Y], where X is the array number, and Y is the drive number.

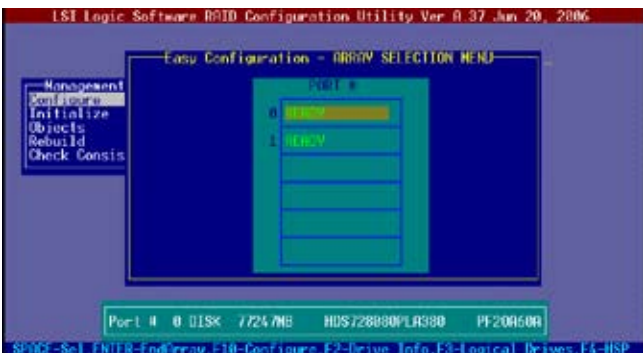

The information of the selected hard disk drive displays at the bottom of the screen.

4. Select all the drives required for the RAID set, then press <Enter>. The configurable array appears on screen.

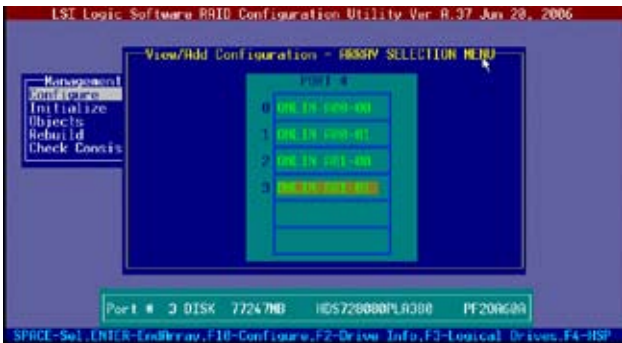

5. Press <F10>, select the configurable array, then press <SpaceBar>.

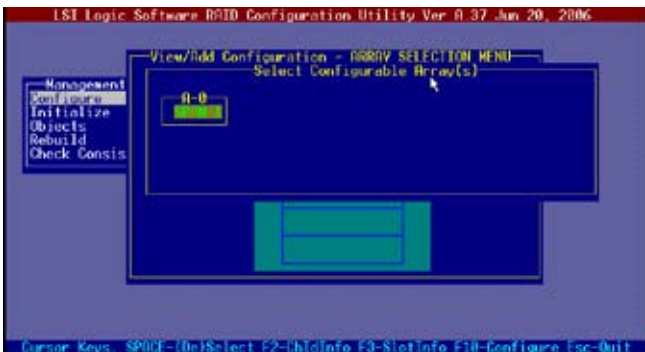

6. Press <F10> again, and select RAID from the Logical Drive menu, then press <Enter>.

7. Select the RAID level from the menu, then press <Enter>.

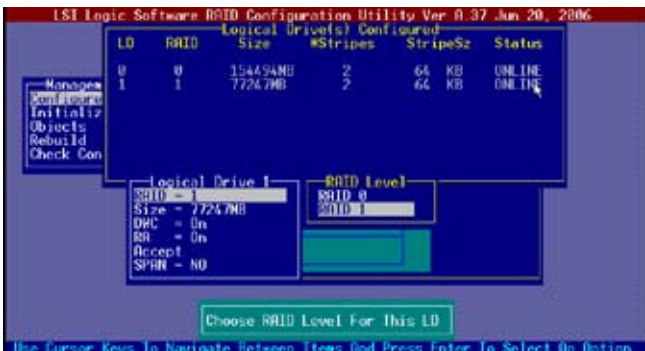



8. Follow steps 8 to 12 of the Creating a RAID set: Using Easy Configuration section.
9. When prompted, save the configuration, then press <Esc> to return to the Management Menu.



9. Follow steps 8 to 13 of the Creating a RAID set: Using Easy Configuration section to add the new RAID configuration.

## 6.2.4 Initializing the logical drives

After creating the RAID set(s), you must initialize the logical drives. You may initialize the logical drives of a RAID set(s) using the Initialize or Objects command on the Management Menu.

### Using the Initialize command

To initialize the logical drive using the Initialize command:

1. From the Management Menu, highlight Initialize, then press <Enter>.



2. The screen displays the available RAID set(s) and prompts you to select the logical drive to initialize. Use the arrow keys to select the logical drive from the Logical Drive selection, then press <Enter>.



- When prompted, press the <SpaceBar> to select Yes from the Initialize? dialog box, then press <Enter>. You may also press <F10> to initialize the drive without confirmation.

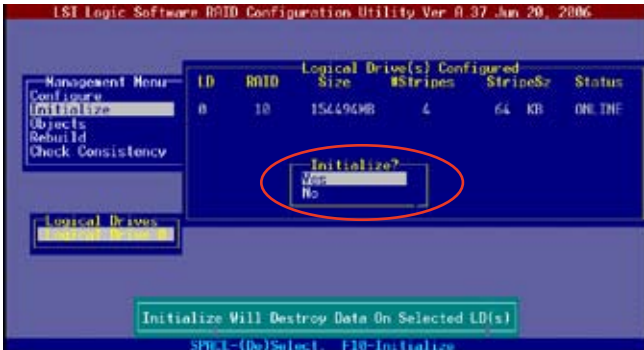

Initializing a logical drive(s) erases all data on the drive.

- A progress bar appears on screen. If desired, press <Esc> to abort initialization.



- When initialization is completed, press <Esc>.



## Using the Objects command

To initialize the logical drives using the Objects command:

- From the Management Menu, highlight Objects, then press <Enter>.



2. Select Logical Drive from the Objects sub-menu, then press <Enter>.

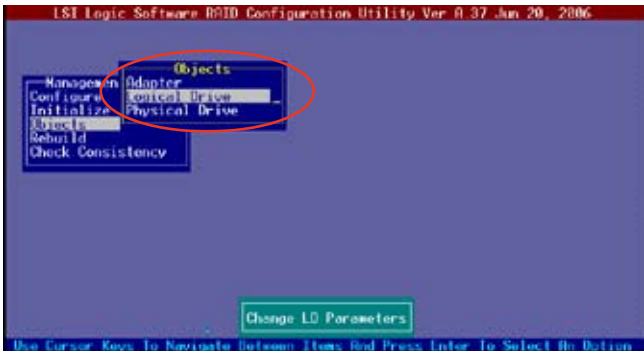

3. Select the logical drive to initialize from the Logical Drives sub-menu, then press <Enter>.



4. Select Initialize from the pop-up menu, then press <Enter> to start initialization.

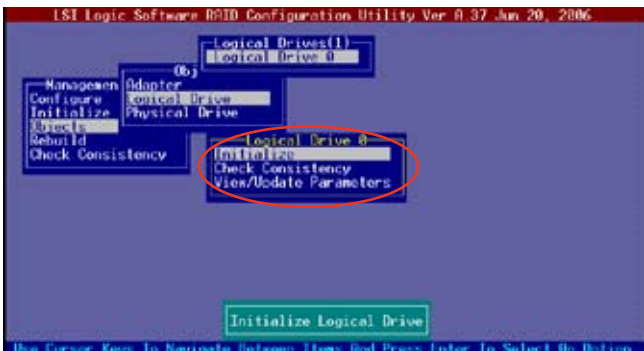

5. When prompted, press the <SpaceBar> to select Yes from the Initialize? dialog box, then press <Enter>. You may also press <F10> to initialize the drive without confirmation.

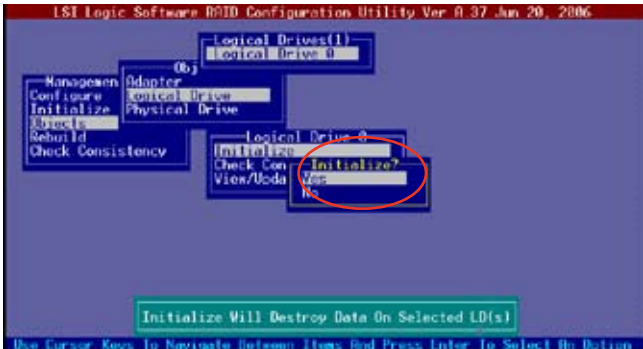

6. A progress bar appears on screen. If desired, press <Esc> to abort initialization.



7. When initialization is completed, press <Esc>.



## 6.2.5 Rebuilding failed drives

You can manually rebuild failed hard disk drives using the Rebuild command in the Management Menu.

To rebuild a failed hard disk drive:

1. From the Management Menu, highlight Rebuild, then press <Enter>.



2. The PHYSICAL DRIVES SELECTION MENU displays the available drives connected to the SATA ports. Select the drive you want to rebuild, then press <SpaceBar>.



3. After selecting the drive to rebuild, press <F10>. The indicator for the selected drive now shows RBLD.



4. When prompted, press <Y> to to rebuild the drive.

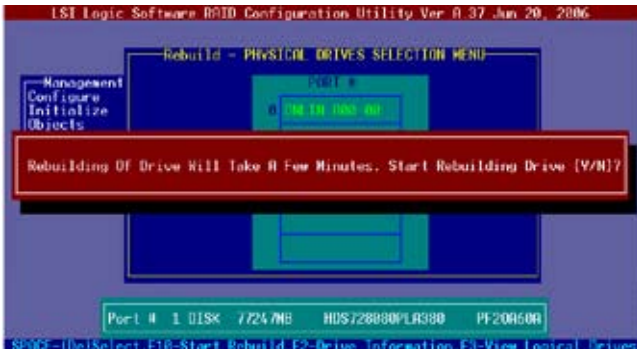

5. When rebuild is complete, press any key to continue.



## 6.2.6 Checking the drives for data consistency

You can check and verify the accuracy of data redundancy in the selected logical drive. The utility can automatically detect and/or detect and correct any differences in data redundancy depending on the selected option in the Objects > Adapter menu.



The Check Consistency command is available only for logical drives included in a RAID 1 set.

### Using the Check Consistency

To check data consistency using the Check Consistency command:

1. From the Management Menu, select Check Consistency, then press <Enter>.



2. The screen displays the available RAID set(s) and prompts you to select the logical drive to check. Use the arrow keys to select the logical drive from the Logical Drive selection, then press <Enter>.



- When prompted, press the <SpaceBar> to select Yes from the Consistency Check dialog box, then press <Enter>. You may also press <F10> to check the drive consistency.

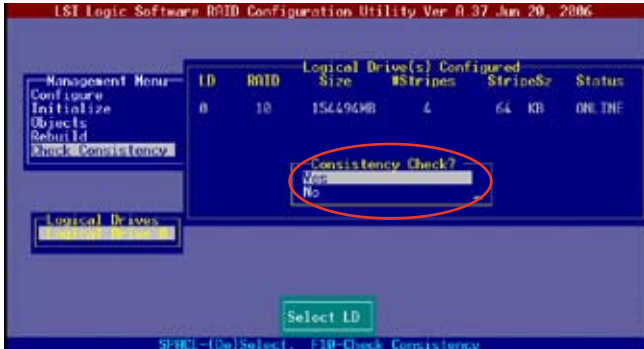

A progress bar appears on screen.



- While checking the disk consistency, press <Esc> to display the following options.
  - Stop - Stops the consistency check. The utility stores the percentage of disk checked, When you restart checking, it continues from the last percentage completed rather than from zero percent.
  - Continue - Continues the consistency check.
  - Abort - Aborts the consistency check. When you restart checking, it continues from zero percent.
- When checking is complete, press any key to continue.

## Using the Objects command

To check data consistency using the Objects command:

1. From the Management Menu, select Objects, then select Logical Drive from the menu.
2. Use the arrow keys to select the logical drive you want to check, then press <Enter>.
3. Select Check Consistency from the pop-up menu, then press <Enter>.
4. When prompted, press <Y> to to check the drive.
5. When checking is complete, press any key to continue.

## 6.2.7 Deleting a RAID configuration

To delete a RAID configuration:

1. From the Management Menu, select Configure > Clear Configuration, then press <Enter>.



2. When prompted, press the <SpaceBar> to select Yes from the Clear Configuration? dialog box, then press <Enter>.



The utility clears the current array.

3. Press any key to continue.

## 6.2.8 Selecting the boot drive from a RAID set

You must have created a new RAID configuration before you can select the boot drive from a RAID set. Refer to the Creating a RAID set: Using New Configuration section for details.

To select the boot drive from a RAID set:

1. From the Management Menu, select Configure > Select Boot Drive, then press <Enter>.



2. When prompted, press the <SpaceBar> to select the bootable logical drive from the list, then press <Enter>.



3. The logical drive is selected as boot drive. Press any key to continue.

## 6.2.9 Enabling the WriteCache

You may enable the RAID controller's WriteCache option to improve the data transmission performance.



When you enable WriteCache, you may lose data when a power interruption occurs while transmitting or exchanging data among the drives.

To enable WriteCache:

1. From the Management Menu, select Objects > Adapter, then press <Enter> to display the adapter properties.
2. Select WriteCache, then press <Enter> to turn the option On (enabled).



3. When finished, press any key to continue.

## 6.3 Intel® Matrix Storage Manage Option ROM Utility (Only for PA4 model)

The Intel® Matrix Storage Manager Option ROM utility allows you to create RAID 0, RAID 1, RAID 0+1, and RAID 5 set(s) from Serial ATA hard disk drives.

To enter the Intel® Matrix Storage Manager Option ROM Utility:

1. Turn on the system after installing all Serial ATA hard disk drives.
2. During POST, press <Ctrl+I> to display the utility main menu.

```
Intel(R) Matrix Storage Manager Option ROM v5.0.0.1032 ESB2 wRAID5
Copyright (C) 2003-05 Intel Corporation. All Rights Reserved.

[ MAIN MENU ]

1. Create RAID Volume
2. Delete RAID Volume
3. Reset Disks to Non-RAID
4. Exit

[ DISK/VOLUME INFORMATION ]

RAID Volumes:
None defined.

Physical Disks:
Port      Drive Model      Serial #      Size      Type/Status (Vol ID)
0         XXXXXXXXXXXX    XXXXXXXXX   XX.XXGB   Non-RAID Disk
1         XXXXXXXXXXXX    XXXXXXXXX   XX.XXGB   Non-RAID Disk
2         XXXXXXXXXXXX    XXXXXXXXX   XX.XXGB   Non-RAID Disk
3         XXXXXXXXXXXX    XXXXXXXXX   XX.XXGB   Non-RAID Disk

[↑↓]-Select      [ESC]-Exit      [ENTER]-Select Menu
```

The navigation keys at the bottom of the screen allow you to move through the menus and select the menu options.



The RAID BIOS setup screens shown in this section are for reference only and may not exactly match the items on your screen.

### 6.3.1 Creating a RAID 0 set (Stripe)

To create a RAID 0 set:

1. From the utility main menu, select 1. Create RAID Volume, then press <Enter>. This screen appears.

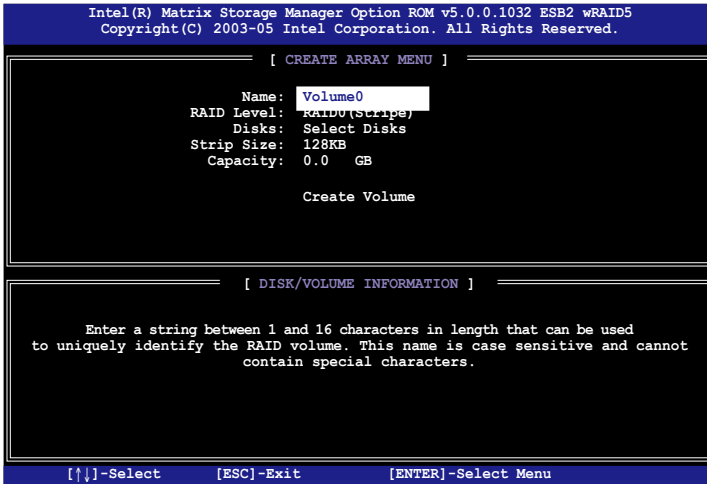

2. Enter a name for the RAID 0 set, then press <Enter>.
3. Highlight RAID Level, press the up/down arrow key to select RAID 0 (Stripe), then press <Enter>.
4. Highlight the Disks item, then press <Enter> to select the hard disk drives you want to include in the RAID set. The SELECT DISKS screen appears.

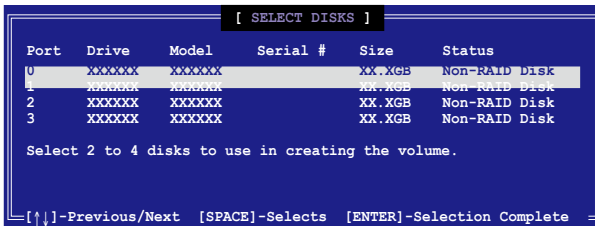

5. Use the up/down arrow key to highlight a drive, then press <Space> to select. A small triangle marks the selected drive. Press <Enter> after completing your selection.



6. Use the up/down arrow key to select the stripe size for the RAID 0 array, then press <Enter>. The available stripe size values range from 4 KB to 128 KB. The default stripe size is 128 KB.



---

A lower stripe size is recommended for server systems. A higher stripe size is recommended for multimedia computer systems used mainly for audio and video editing.

---

7. Highlight the Capacity item, enter the desired RAID volume capacity, then press <Enter>. The default value indicates the maximum allowed capacity.
8. When the Create Volume item is highlighted, press <Enter>. A warning message appears.

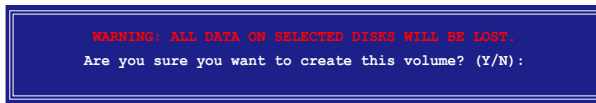

9. Press <Y> to create the RAID volume and return to the main menu, or <N> to go back to the Create Array menu.

## 6.3.2 Creating a RAID 1 set (Mirror)

To create a RAID 1 set:

1. From the utility main menu, select 1. Create RAID Volume, then press <Enter>. This screen appears.



2. Enter a name for the RAID 1 set, then press <Enter>.
3. Highlight RAID Level, press the up/down arrow key to select IRAID 1 (Mirror), then press <Enter>.
4. Follow steps 4 to 5 and 7 to 9 of the previous section to create the RAID 1 set.

### 6.3.3 Creating a RAID 10 set (Stripe + Mirror)

To create a RAID 10 set:

1. From the utility main menu, select 1. Create RAID Volume, then press <Enter>. This screen appears.

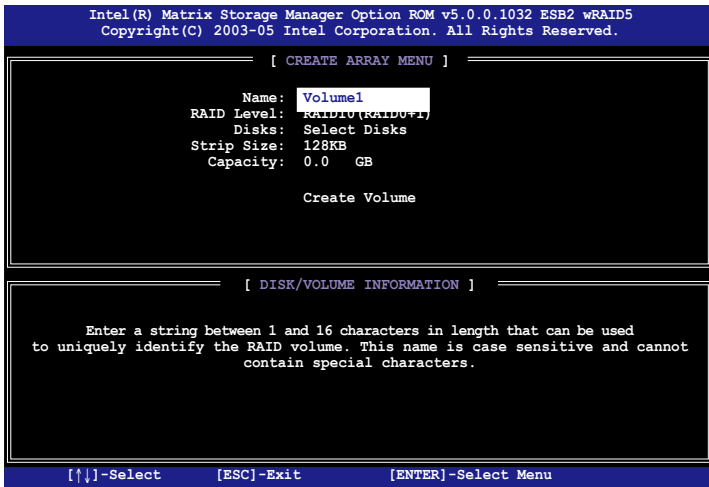

2. Enter a name for the RAID 10 set, then press <Enter>.
3. Highlight RAID Level, press the up/down arrow key to select IRAID 10 (RAID0+1), then press <Enter>.
4. Follow steps 4 to 9 of section "5.3.1 Creating a RAID 0 set (striped)" to create the RAID 10 set.

## 6.3.4 Creating a RAID 5 set (Parity)

To create a RAID 5 set:

1. From the utility main menu, select 1. Create RAID Volume, then press <Enter>. This screen appears.

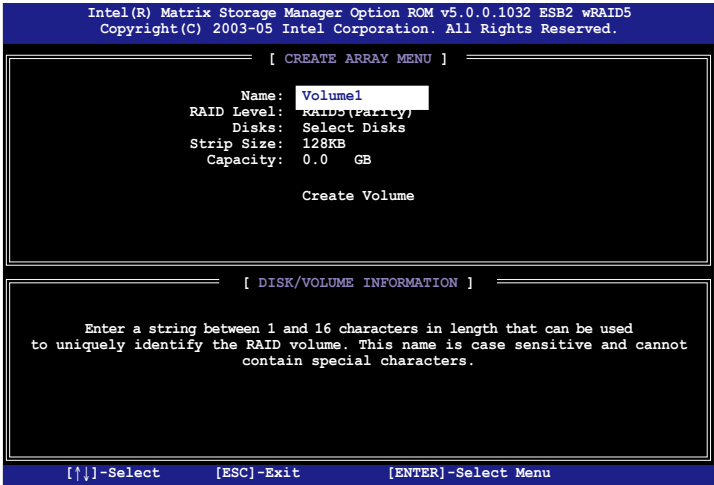

2. Enter a name for the RAID 10 set, then press <Enter>.
3. Highlight RAID Level, press the up/down arrow key to select IRAID 10 (RAID0+1), then press <Enter>.
4. Follow steps 4 to 9 of section “5.3.1 Creating a RAID 0 set (striped)” to create the RAID 5 set.

## 6.3.5 Deleting a RAID set



Take caution when deleting a RAID set. You will lose all data on the hard disk drives when you delete a RAID set.

To delete a RAID set:

1. From the utility main menu, select 2. Delete RAID Volume, then press <Enter> to display this screen.

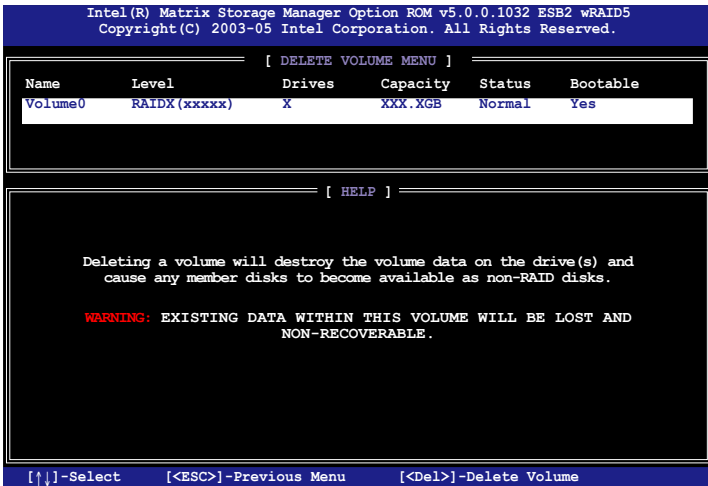

2. Use the up/down arrow key to select the RAID set you want to delete, then press <Del>. This window appears.

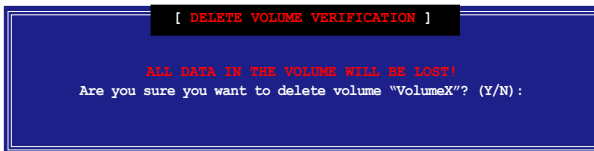

3. Press <Y> to delete the RAID set and return to the utility main menu; otherwise, press <N> to return to the Delete Volume menu.

## 6.3.6 Resetting disks to Non-RAID



Take caution before you reset a RAID volume hard disk drive to non-RAID. Resetting a RAID volume hard disk drive deletes all internal RAID structure on the drive.

To reset a RAID set hard disk drive:

1. From the utility main menu, select 3. Reset Disks to Non-RAID, then press <Enter> to display this screen.

```
[ RESET RAID DATA ]

Resetting RAID data will remove internal RAID structures
from the selected RAID disks. By removing these structures,
the drive will revert back to a non-RAID disk.

WARNING: Resetting a disk causes all data on the disk to be lost.

Port   Drive Model      Serial #          Size    Status
-----
1      XXXXXXXXXXXX     XXXXXXXX         XX.XGB  Member Disk

Select the disks that should be reset.

[↑↓]-Previous/Next [SPACE]-Selects [ENTER]-Selection Complete
```

2. Use the up/down arrow key to highlight the RAID set drive you want to reset, then press <Space> to select.
3. Press <Enter> to reset the RAID set drive. A confirmation message appears.
4. Press <Y> to reset the drive or press <N> to return to the utility main menu.
5. Follow steps 2 to 4 to select and reset other RAID set drives.

## 6.3.7 Exiting the Intel® Matrix Storage Manager

To exit the utility:

1. From the utility main menu, select 4. Exit, then press <Enter>. This window appears.

```
[ CONFIRM EXIT ]

Are you sure you want to exit? (Y/N):
```

2. Press <Y> to exit or press <N> to return to the utility main menu.

## 6.4 Global Array Manager

You may also create a RAID set(s) in Windows® operating environment using the Global Array Manager (GAM) application. The GAM application is available from the motherboard support CD.



---

Refer to the GAM user guide in the motherboard support CD for details.

---





# Chapter 7

This chapter provides information on RAID configurations, RAID driver installation, and LAN driver installation for this motherboard.



ASUS TS500-E4

Download from [Www.Somanuals.com](http://Www.Somanuals.com). All Manuals Search And Download.

# Driver Installation

# 7.1 RAID driver installation

After creating the RAID sets for your server system, you are now ready to install an operating system to the independent hard disk drive or bootable array. This part provides instructions on how to install the RAID controller drivers during OS installation.



This chapter provides instructions for TS500-E4/PA4 model only. For TS500-E4/PX4, refer to the SAS/RAID card user guide which may be contained in its driver CD.

## 7.1.1 Create a RAID driver disk (PA4 model)



You may have to use another system to create the RAID driver disk from the system/motherboard support CD or from the Internet.

A floppy disk with the RAID driver is required when installing Windows® 2000/XP or Red Hat® Enterprise ver. 3.0/SuSE operating system on a hard disk drive that is included in a RAID set. You can create a RAID driver disk in DOS (using the Makedisk application in the support CD).

To create a RAID driver disk in DOS environment:

1. Place the motherboard support CD in the optical drive.
2. Restart the computer, then enter the BIOS Setup.
3. Select the optical drive as the first boot priority to boot from the support CD. Save your changes, then exit the BIOS Setup.
4. Restart the computer.
5. Press any key when prompted to boot from CD.

```
Loading FreeDOS FAT KERNEL GO!  
Press any key to boot from CDROM...
```

The Makedisk menu appears.

### For PA4 model

```
A) FreeDOS command prompt  
B) Create INTEL 6321 MATRIX STORAGE MANAGER for Windows 32 bit Driver Disk.  
   (Also support AHCI.)  
C) Create INTEL 6321 MATRIX STORAGE MANAGER for Windows 64 bit Driver Disk.  
   (Also support AHCI.)  
D) Create INTEL 6321 LSI MegaRAID for Win2k Driver Disk  
E) Create INTEL 6321 LSI MegaRAID for WinXP/Win2k3 32 bit Driver Disk  
F) Create INTEL 6321 LSI MegaRAID for WinXP/Win2k3 64 bit Driver Disk  
G) Create the emergent BIOS Recovery diskette  
H) ESB2 ASF firmware update  
Please choose A TO H:
```

## For PX4 model

```
A) FreeDOS command prompt
B) Create the emergent BIOS Recovery diskette
C) Flash Phoenix BIOS for TS500-E4/PX4 system
D) ESB2 ASF Firmware update
E) Write TS500-E4/PX4 FRU
Please choose A TO E:
```

6. Place a blank, high-density floppy disk to the floppy disk drive, then select the type of RAID driver disk you want to create by typing the number before the option
7. Press <Enter>.
8. Follow screen instructions to create the driver disk.



---

For systems with Red Hat® Enterprise versions that are not listed in the Makedisk menu, explore the support CD and copy the RAID driver disk from the following path: For Intel® 6321 LSI MegaRAID: \Drivers\6321 LSI MegaRAID\Driver\Linux\megaswr-drvr-bin.tgz

---

## 7.1.2 Installing the RAID controller driver

### Windows® 2000/2003 Server OS

#### During Windows® 2000/2003 Server OS installation

To install the RAID controller driver when installing Windows® 2000/2003 Server OS:

1. Boot the computer using the Windows® 2000/2003 Server installation CD. The Windows® 2000/2003 Setup starts.

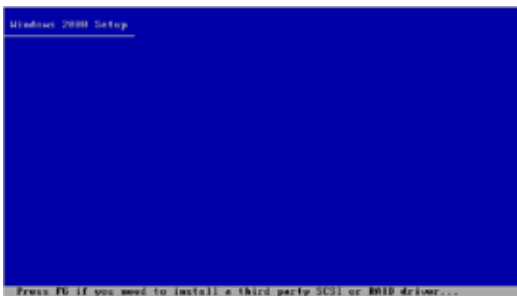

2. Press <F6> when the message “Press F6 if you need to install a third party SCSI or RAID driver...” appears at the bottom of the screen.
3. When prompted, press <S> to specify an additional device.

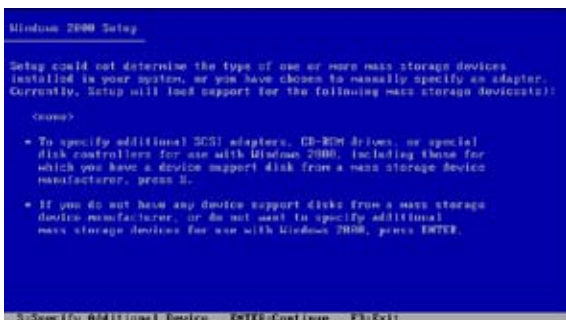

4. Insert the RAID driver disk you created earlier to the floppy disk drive, then press <Enter>.

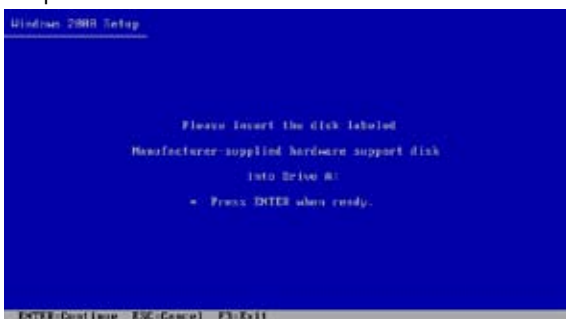

5. Select the RAID controller driver from the list, then press <Enter>.

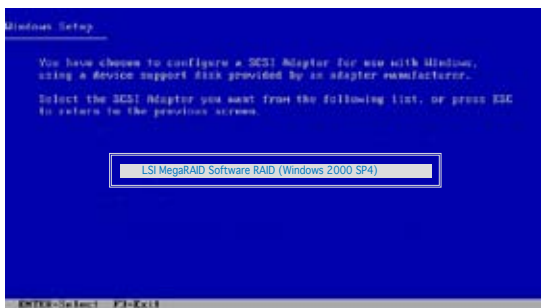

- For Intel® 6321ESB LSI Logic Embedded SATA RAID Driver, select Intel LSI Logic Embedded SATA RAID (DSBV-D).
6. The Windows® 2000/2003 Setup loads the RAID controller drivers from the RAID driver disk. When prompted, press <Enter> to continue installation.
  7. Setup then proceeds with the OS installation. Follow screen instructions to continue.





## Red Hat® Enterprise ver. 3.0

To install the Intel® ESB2E LSI Logic Embedded SATA RAID controller driver when installing Red Hat® Enterprise ver. 3.0 OS:

1. Boot the system from the Red Hat® Installation CD.



2. At the boot:, type `linux dd`, then press <Enter>.

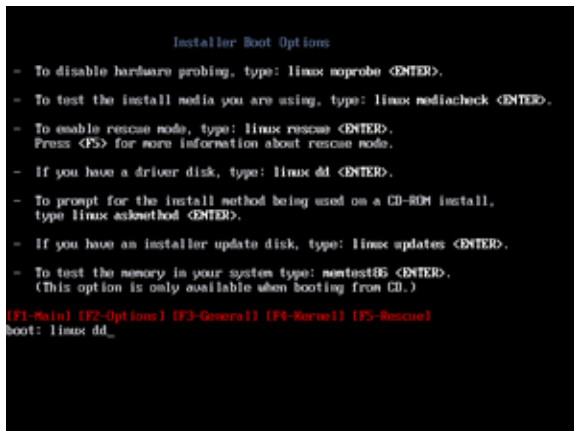

3. Select Yes using the <Tab> key when asked if you have the driver disk. Press <Enter>

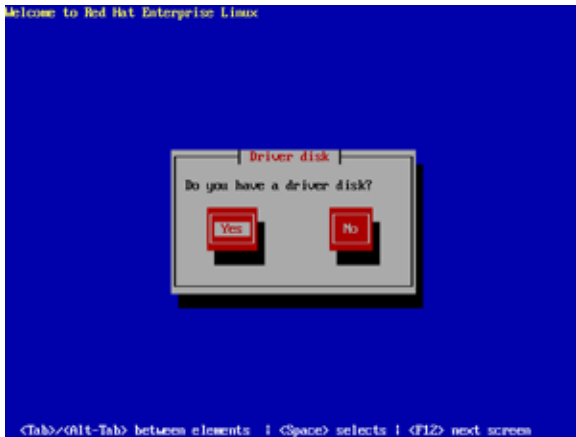

4. Select fd0 using the <Tab> key when asked to select the driver disk source. Press <Tab> to move the cursor to OK, then press <Enter>.

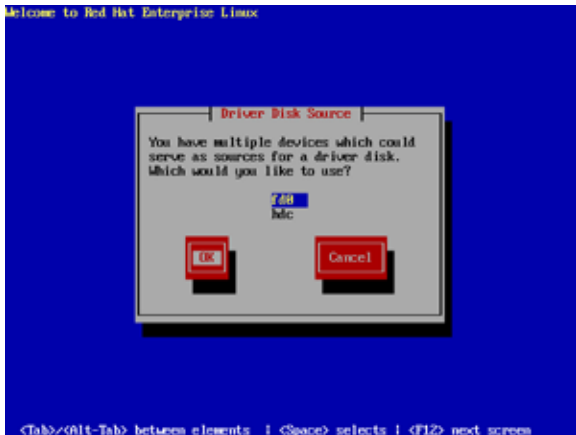



5. When prompted, insert the Red Hat® Enterprise ver. 3.0 RAID driver disk to the floppy disk drive, select OK, then press <Enter>.

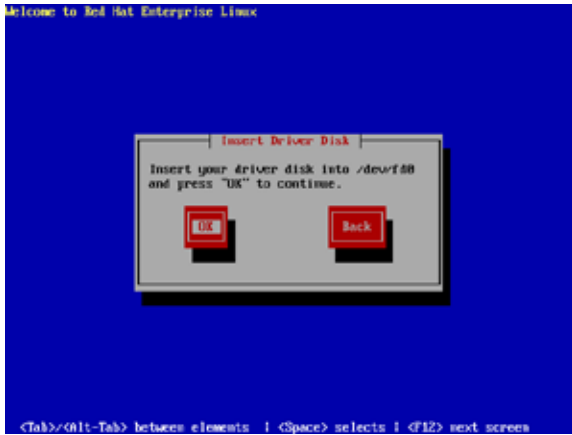

The drivers for the RAID controller are installed to the system.

6. Follow screen instructions to continue the OS installation.

## SuSE Linux

To install the RAID controller driver when installing SuSE Linux OS:

1. Boot the system from the SuSE Installation CD.
2. Select Installation from the Boot Options menu, then press <Enter>.

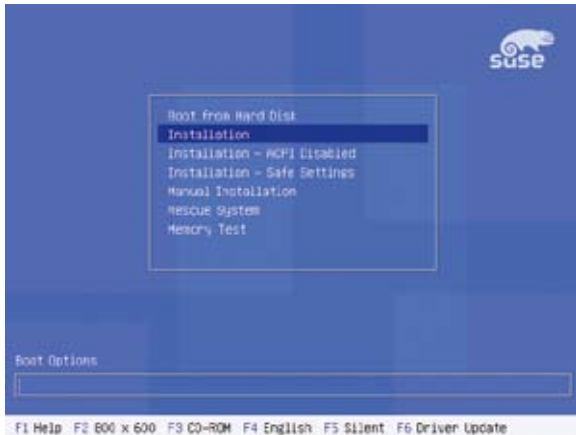

3. A message instructs you to prepare the RAID driver disk. Press <F6>.

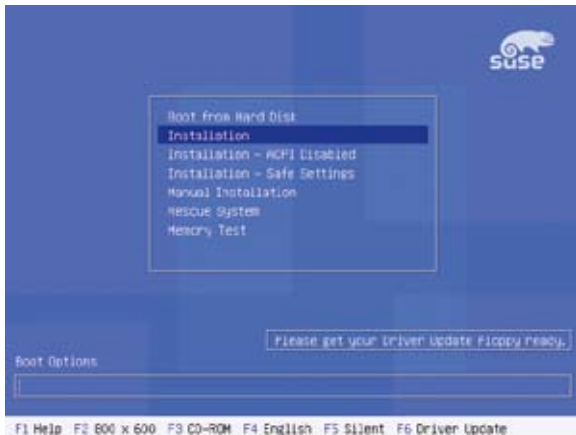

- When prompted, insert the RAID driver disk to the floppy disk drive, then press <Enter>.



- When prompted, select the floppy disk drive (fd0) as the driver update medium, select OK, then press <Enter>.

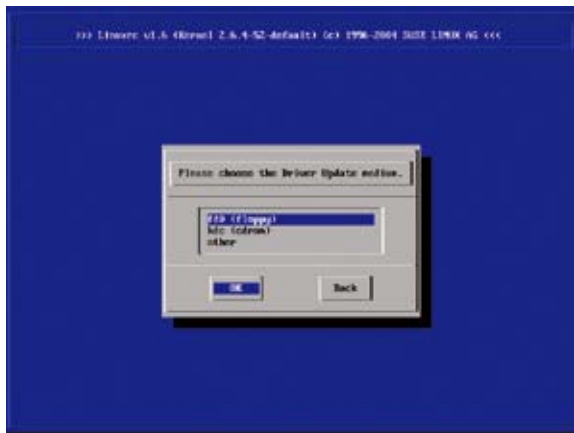

The drivers for the RAID controller are installed to the system.

## 7.2 LAN driver installation

This section provides the instructions on how to install Intel® Gigabit LAN controller drivers.

### 7.2.1 Windows 2000/Server 2003

To install the Intel® Gigabit LAN controller driver on a Windows® 2000/Server 2003 OS:

1. Restart the computer, and then log on with Administrator privileges.
2. Insert the motherboard/system support CD to the optical drive. The CD automatically displays the Drivers menu if Autorun is enabled in your computer.
  - Windows® automatically detects the LAN controllers and displays a window. Click Cancel to close this window.
  - If Autorun is NOT enabled in your computer, browse the contents of the support CD to locate the file AUTORUN.EXE from the \Drivers\Intel82563EB folder. Double-click the AUTORUN.EXE and follow step 4 to run the installation.
3. Click the Intel® PRO/1000 EB Network Connection option.



4. Click the Install Drivers option to begin installation.



5. Click Next button when the Intel® PRO Network Connections - InstallShield Wizard window appears.



6. Select the “I accept the terms in the license agreement” and then click the Next button.



7. Press the Complete and click Next button to fully install the driver, Intel® PROSet for Windows Device Manager and Advanced Networking Services.



8. Follow the screen instructions to complete installation.

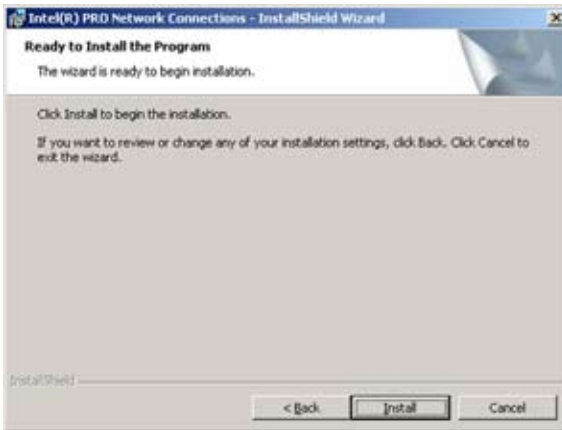

## 7.2.2 Red Hat/SuSE Linux

Follow these instructions when installing the Intel® LAN controller base driver for the in Red Hat® and SuSE Linux operating system.

Before installing the LAN driver:

Before installing the LAN driver, you must install the kernel development application. To install the kernel development:

1. Insert the Linux OS installation CD Disk 1 to the optical drive.
2. Double click “Application” > “System setting” > “Add / Remove application”.
3. Select “Kernel Development” from the Development Tools.
4. Follow the later steps and add different CDs according to the instructions displayed.

Building the driver from the TAR file:

1. Insert the motherboard/system support CD to the optical drive and mount the optional drive in the Linux platform.
2. Copy the base driver tar file from the motherboard/system support CD to the directory of your local hard disk. The name format of driver file is “e1000-<Version>.tar.gz”.

For example: the file name of driver version 7.0.38 is “e1000-7.0.38.tar.gz”.

- The Intel® LAN driver for Linux OS is located in:

    \Drivers\INTEL 82563EB\PRO1000\LINUX

3. Untar or unzip the archive.  
tar zxf e1000-x.x.x.tar.gz
4. Change to the driver src directory.  
cd e1000-x.x.x/src/
5. Use the command “makeinstall” to compile the driver module.  
makeinstall
6. After reboot the system, please refer to Linux distribution documentation to configure the network protocol and IP address.



## 7.3 VGA driver installation

This section provides instructions on how to install the ATI® ES1000 Video Graphics Adapter (VGA) driver.

### 7.3.1 Windows 2000/Server 2003

You need to manually install the ATI® ES1000 VGA driver on a Windows 2000 / Server 2003 operating system. To install the ATI® ES1000 VGA driver:

1. Restart the computer, then log on with Administrator privileges.
2. Insert the motherboard/system support CD to the optical drive. The support CD automatically displays the Drivers menu if Autorun is enabled in your computer.

The Drivers menu if Autorun is enabled in your computer.





3. Click the item ATI ES1000 from the menu.

4. The ATI Software window appears. Follow the screen instructions to complete installation.

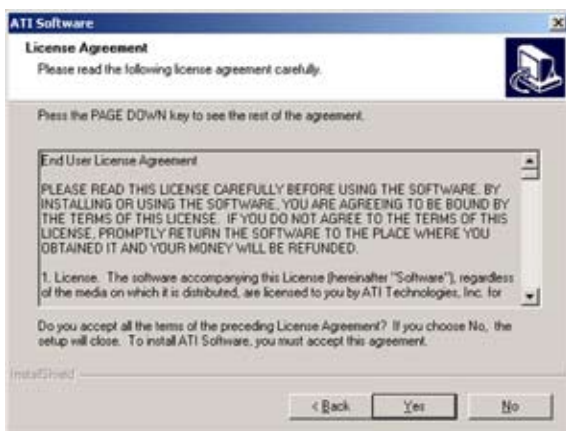

5. Select Yes to accept the terms of the License Agreement and continue the process.



6. Press the  button to activate quick installation.

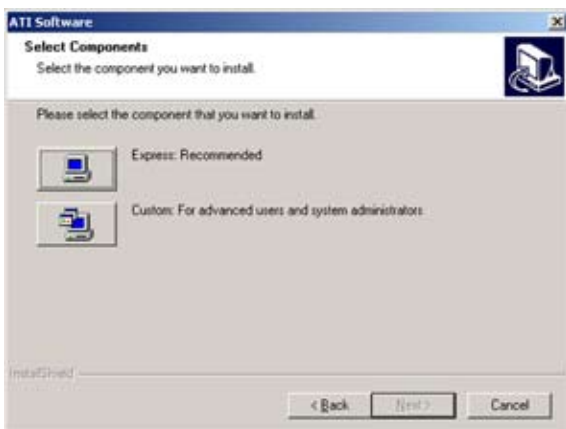

7. After completing the installation, restart the computer.





# Appendix

This section provides information about the power supply unit and a troubleshooting guide for solving common problems when using the barebone server.



ASUS TS500-E4

Download from [Www.Somanuals.com](http://Www.Somanuals.com). All Manuals Search And Download.

# Reference info

## A.1 670 W single power supply

### A.1.1 General description

The 670 W SSI-type single power supply with universal AC input includes PFC and ATX-compliant output cables and connectors. The power supply has 10 plugs labeled P1 to P10. Take note of the devices to which you should connect the plugs.



P9	Motherboard 4-pin +12V power connector
P5	Floppy disk drive
P10	Power SMBus connector
P1	Motherboard 24-pin ATX power connector
P2	Motherboard 8-pin +12V power connector
P7	Peripheral device (available)
P8	Peripheral device (available)
P6	Peripheral device (available);optical drive
P3	Connect to the SAS/SATA backplane
P4	Connect to the SAS/SATA backplane

## A.1.2 Specifications

### Input Characteristics

Input Voltage Range

Normal Range 110 to 127 V ~ 12 A

Auto Range 200 to 240 V ~ 7 A

Input Frequency Range 50 Hz to 60 Hz

### DC Output characteristics

Output Voltage	Max (A)	Peak (A)
+3.33V	24	
+5V	30	
+12V <sup>1</sup>	16	18
+12V <sup>2</sup>	16	18
+12V <sup>3</sup>	16	18
+12V <sup>4</sup>	16	18
-12V	0.5	
+5VSB	3.0	



1. Maximum continuous load on the combined 12V output shall not exceed 48A.
2. Peak load on the combined 12V output shall not exceed 52A.

## A.2 Simple fixes



Some problems that you may encounter are not due to defects on the system or the components. These problems only requires simple troubleshooting actions that you can perform by yourself.

Problem	Action
The power LED on the server or on the monitor do not light up	<ol style="list-style-type: none"><li>1. Check if the power cable is properly connected to the power connector in the system rear panel.</li><li>2. Make sure that the power cables are connected to a grounded power outlet.</li><li>3. Press the power button to make sure that the system is turned on.</li></ol>
The keyboard does not work	Check if the keyboard cable is properly connected to the PS/2 keyboard port.
The mouse does not work	Check if the mouse cable is properly connected to the mouse port.
The system does not perform power-on self tests (POST) after it was turned on	<ol style="list-style-type: none"><li>1. Check the memory modules and make sure you installed the DIMMs the system supports.</li><li>2. Make sure that the DIMMs are properly installed on the sockets.</li></ol>



Problem	Action
The system continuously beeps after it was turned on	<ol style="list-style-type: none"><li>1. Check the memory modules and make sure you installed supported DIMMs.</li><li>2. Make sure that the DIMMs are properly installed on the sockets.</li></ol>
The message “Non-system disk or disk error” appears	<ol style="list-style-type: none"><li>1. Check if a bootable HDD is active.</li><li>2. Check if the HDDs are properly installed.</li></ol>
Network connection not available	<ol style="list-style-type: none"><li>1. Make sure that the network cable is connected to the LAN port on the rear panel.</li><li>2. Make sure that you have installed the LAN drivers from the support CD.</li></ol>



## Free Manuals Download Website

<http://myh66.com>

<http://usermanuals.us>

<http://www.somanuals.com>

<http://www.4manuals.cc>

<http://www.manual-lib.com>

<http://www.404manual.com>

<http://www.luxmanual.com>

<http://aubethermostatmanual.com>

Golf course search by state

<http://golfingnear.com>

Email search by domain

<http://emailbydomain.com>

Auto manuals search

<http://auto.somanuals.com>

TV manuals search

<http://tv.somanuals.com>