



RS300-E8 Series

RS300-E8-PS4

RS300-E8-RS4

*1U Rackmount Server
User Guide*



E8115

First Edition

March 2013

Copyright © 2013 ASUSTeK COMPUTER INC. All Rights Reserved.

No part of this manual, including the products and software described in it, may be reproduced, transmitted, transcribed, stored in a retrieval system, or translated into any language in any form or by any means, except documentation kept by the purchaser for backup purposes, without the express written permission of ASUSTeK COMPUTER INC. ("ASUS").

ASUS provides this manual "as is" without warranty of any kind, either express or implied, including but not limited to the implied warranties or conditions of merchantability or fitness for a particular purpose. In no event shall ASUS, its directors, officers, employees, or agents be liable for any indirect, special, incidental, or consequential damages (including damages for loss of profits, loss of business, loss of use or data, interruption of business and the like), even if ASUS has been advised of the possibility of such damages arising from any defect or error in this manual or product.

Specifications and information contained in this manual are furnished for informational use only, and are subject to change at any time without notice, and should not be construed as a commitment by ASUS. ASUS assumes no responsibility or liability for any errors or inaccuracies that may appear in this manual, including the products and software described in it.

Product warranty or service will not be extended if: (1) the product is repaired, modified or altered, unless such repair, modification or alteration is authorized in writing by ASUS; or (2) the serial number of the product is defaced or missing.

Products and corporate names appearing in this manual may or may not be registered trademarks or copyrights of their respective companies, and are used only for identification or explanation and to the owners' benefit, without intent to infringe.

Contents

Notices	vii
REACH	vii
Safety information	viii
Australia statement notice.....	ix
About this guide	x
Chapter 1: Product introduction	
1.1 System package contents	1-2
1.2 Serial number label	1-3
1.3 System specifications	1-4
1.4 Front panel features	1-6
1.5 Rear panel features	1-7
1.6 Internal features	1-8
1.7 LED information	1-9
1.7.1 Front panel LEDs.....	1-9
1.7.2 LAN (RJ-45) LEDs	1-10
1.7.3 HDD status LED.....	1-10
Chapter 2: Hardware setup	
2.1 Chassis cover	2-2
2.2 Central Processing Unit (CPU)	2-3
2.2.1 Installing the CPU	2-3
2.2.2 Installing the CPU heatsink and airduct.....	2-6
2.3 System memory	2-8
2.3.1 Overview	2-8
2.3.2 Memory Configurations.....	2-8
2.3.3 Installing a DIMM	2-9
2.4 Hard disk drives	2-10
2.5 Expansion slot	2-12
2.5.1 Installing an expansion card to the riser card bracket... 2-12	
2.5.2 Configuring an expansion card	2-14
2.6 Cable connections	2-15
2.7 SATA/SAS backplane cabling	2-16

Contents

- 2.8 Removable/optional components..... 2-17**
 - 2.8.1 System fans 2-17
 - 2.8.2 Installing ASUS PIKE RAID card (optional) 2-18
 - 2.8.3 Installing ASMB7 series management board (optional) 2-20
 - 2.8.4 Installing the SSD cage (optional)..... 2-21

- Chapter 3: Installation options**
 - 3.1 Friction Rail Kit Installation Guide 3-2**
 - 3.1.1 Attaching the fixing latches to the server 3-2
 - 3.2 Installing optional ball-bearing rail kit items 3-5**
 - 3.2.1 Attaching the rails to the server 3-5
 - 3.2.2 Attaching the rack rails..... 3-6
 - 3.2.3 Mounting the server to the rack 3-7

- Chapter 4: Motherboard Info**
 - 4.1 Motherboard layout..... 4-2**
 - 4.2 Jumpers 4-4**
 - 4.3 Internal connectors..... 4-7**
 - 4.4 Internal LEDs 4-19**

- Chapter 5: BIOS setup**
 - 5.1 Managing and updating your BIOS 5-2**
 - 5.1.1 ASUS CrashFree BIOS 3 utility 5-2
 - 5.1.2 ASUS EzFlash Utility 5-3
 - 5.1.3 BUPDATER utility..... 5-4
 - 5.2 BIOS setup program 5-6**
 - 5.2.1 BIOS menu screen..... 5-7
 - 5.2.2 Menu bar..... 5-7
 - 5.2.3 Menu items 5-8
 - 5.2.4 Submenu items 5-8
 - 5.2.5 Navigation keys..... 5-8
 - 5.2.6 General help 5-8
 - 5.2.7 Configuration fields 5-8
 - 5.2.8 Pop-up window 5-8
 - 5.2.9 Scroll bar..... 5-8

Contents

5.3	Main menu	5-9
5.3.1	System Date	5-9
5.3.2	System Time	5-9
5.4	Advanced menu	5-10
5.4.1	CPU Configuration	5-11
5.4.2	PCH-IO Configuration	5-14
5.4.3	SATA Configuration	5-15
5.4.4	System Agent (SA) Configuration	5-16
5.4.5	PCI Subsystem Settings	5-18
5.4.6	USB Configuration	5-20
5.4.7	TPM	5-21
5.4.8	ACPI Settings.....	5-21
5.4.9	WHEA Support.....	5-22
5.4.10	NCT6779D Super IO Configuration	5-22
5.4.11	Intel Server Platform Services	5-23
5.4.12	Onboard LAN Configuration.....	5-24
5.4.13	MIO Card Configuration	5-24
5.4.14	Serial Port Console Redirection.....	5-25
5.4.15	Runtime Error Logging Support	5-27
5.4.16	APM	5-27
5.4.17	Network Stack.....	5-28
5.4.18	Intel RC Drivers Version Detail	5-28
5.5	Event Logs menu	5-29
5.6	Boot menu	5-30
5.7	Monitor menu	5-33
5.8	Security	5-34
5.9	Tool menu	5-37
5.10	Exit menu	5-37

Contents

Chapter 6: RAID configuration

6.1	Setting up RAID	6-2
6.1.1	RAID definitions	6-2
6.1.2	Installing hard disk drives.....	6-3
6.1.3	Setting Jumpers.....	6-3
6.1.4	Setting the RAID mode in BIOS.....	6-3
6.1.5	RAID configuration utilities.....	6-3
6.2	Intel® Rapid Storage Technology enterprise	
	SATA Option ROM Utility	6-4
6.2.1	Creating a RAID set.....	6-5
6.2.2	Deleting a RAID set	6-7
6.2.3	Resetting disks to Non-RAID	6-8
6.2.4	Exiting the Intel® Rapid Storage Technology enterprise SATA Option ROM utility	6-9
6.2.5	Rebuilding the RAID	6-9
6.2.6	Setting the Boot array in the BIOS Setup Utility.....	6-11
6.3	Intel® Rapid Storage Technology enterprise (Windows)	6-12
6.3.1	Creating a RAID set.....	6-13
6.3.2	Changing a Volume Type.....	6-15
6.3.3	Deleting a volume	6-16
6.3.4	Preferences.....	6-17

Chapter 7: Driver installation

7.1	RAID driver installation	7-2
7.1.1	Creating a RAID driver disk	7-2
7.1.2	Installing the RAID controller driver	7-4
7.2	Management applications and utilities installation	7-6
7.3	Running the Support DVD	7-6
7.4	Installing the LAN driver	7-14
7.5	Installing the VGA driver	7-19
	ASUS contact information	A-1

Notices

Federal Communications Commission Statement

This device complies with Part 15 of the FCC Rules. Operation is subject to the following two conditions:

- This device may not cause harmful interference, and
- This device must accept any interference received including interference that may cause undesired operation.

This equipment has been tested and found to comply with the limits for a Class B digital device, pursuant to Part 15 of the FCC Rules. These limits are designed to provide reasonable protection against harmful interference in a residential installation. This equipment generates, uses and can radiate radio frequency energy and, if not installed and used in accordance with manufacturer's instructions, may cause harmful interference to radio communications. However, there is no guarantee that interference will not occur in a particular installation. If this equipment does cause harmful interference to radio or television reception, which can be determined by turning the equipment off and on, the user is encouraged to try to correct the interference by one or more of the following measures:

- Reorient or relocate the receiving antenna.
- Increase the separation between the equipment and receiver.
- Connect the equipment to an outlet on a circuit different from that to which the receiver is connected.
- Consult the dealer or an experienced radio/TV technician for help.



WARNING! The use of shielded cables for connection of the monitor to the graphics card is required to assure compliance with FCC regulations. Changes or modifications to this unit not expressly approved by the party responsible for compliance could void the user's authority to operate this equipment.

Canadian Department of Communications Statement

This digital apparatus does not exceed the Class A limits for radio noise emissions from digital apparatus set out in the Radio Interference Regulations of the Canadian Department of Communications.

This Class A digital apparatus complies with Canadian ICES-003.

REACH

Complying with the REACH (Registration, Evaluation, Authorization, and Restriction of Chemicals) regulatory framework, we publish the chemical substances in our products at ASUS REACH website at <http://csr.asus.com/english/REACH.htm>.

Safety information

Electrical Safety

- Before installing or removing signal cables, ensure that the power cables for the system unit and all attached devices are unplugged.
- To prevent electrical shock hazard, disconnect the power cable from the electrical outlet before relocating the system.
- When adding or removing any additional devices to or from the system, ensure that the power cables for the devices are unplugged before the signal cables are connected. If possible, disconnect all power cables from the existing system before you add a device.
- If the power supply is broken, do not try to fix it by yourself. Contact a qualified service technician or your dealer.

Operation Safety

- Any mechanical operation on this server must be conducted by certified or experienced engineers.
- Before operating the server, carefully read all the manuals included with the server package.
- Before using the server, ensure all cables are correctly connected and the power cables are not damaged. If any damage is detected, contact your dealer as soon as possible.
- To avoid short circuits, keep paper clips, screws, and staples away from connectors, slots, sockets and circuitry.
- Avoid dust, humidity, and temperature extremes. Place the server on a stable surface.



This product is equipped with a three-wire power cable and plug for the user's safety. Use the power cable with a properly grounded electrical outlet to avoid electrical shock.

Lithium-Ion Battery Warning

CAUTION! Danger of explosion if battery is incorrectly replaced. Replace only with the same or equivalent type recommended by the manufacturer. Dispose of used batteries according to the manufacturer's instructions.

CD-ROM Drive Safety Warning

CLASS 1 LASER PRODUCT

Heavy System

CAUTION! This server system is heavy. Ask for assistance when moving or carrying the system.



DO NOT throw the motherboard in municipal waste. This product has been designed to enable proper reuse of parts and recycling. This symbol of the crossed out wheeled bin indicates that the product (electrical and electronic equipment) should not be placed in municipal waste. Check local regulations for disposal of electronic products.



DO NOT throw the mercury-containing button cell battery in municipal waste. This symbol of the crossed out wheeled bin indicates that the battery should not be placed in municipal waste.

Australia statement notice

From 1 January 2012 updated warranties apply to all ASUS products, consistent with the Australian Consumer Law. For the latest product warranty details please visit <http://support.asus.com>. Our goods come with guarantees that cannot be excluded under the Australian Consumer Law. You are entitled to a replacement or refund for a major failure and compensation for any other reasonably foreseeable loss or damage. You are also entitled to have the goods repaired or replaced if the goods fail to be of acceptable quality and the failure does not amount to a major failure.

If you require assistance please call ASUS Customer Service 1300 2787 88 or visit us at <http://support.asus.com>

About this guide

Audience

This user guide is intended for system integrators, and experienced users with at least basic knowledge of configuring a server.

Contents

This guide contains the following parts:

1. Chapter 1: Product introduction

This chapter describes the general features of the server, including sections on front panel and rear panel specifications.

2. Chapter 2: Hardware setup

This chapter lists the hardware setup procedures that you have to perform when installing or removing system components.

3. Chapter 3: Installation options

This chapter describes how to install optional components into the barebone server.

4. Chapter 4: Motherboard information

This chapter gives information about the motherboard that comes with the server. This chapter includes the motherboard layout, jumper settings, and connector locations.

5. Chapter 5: BIOS information

This chapter tells how to change system settings through the BIOS Setup menus and describes the BIOS parameters.

6. Chapter 6: RAID configuration

This chapter tells how to change system settings through the BIOS Setup menus. Detailed descriptions of the BIOS parameters are also provided.

7. Chapter 7: Driver installation

This chapter provides instructions for installing the necessary drivers for different system components.

Conventions

To ensure that you perform certain tasks properly, take note of the following symbols used throughout this manual.



DANGER/WARNING: Information to prevent injury to yourself when trying to complete a task.



CAUTION: Information to prevent damage to the components when trying to complete a task.



IMPORTANT: Instructions that you **MUST** follow to complete a task.



NOTE: Tips and additional information to help you complete a task.

Typography

Bold text

Indicates a menu or an item to select.

Italics

Used to emphasize a word or a phrase.

<Key>

Keys enclosed in the less-than and greater-than sign means that you must press the enclosed key.

Example: <Enter> means that you must press the Enter or Return key.

<Key1>+<Key2>+<Key3>

If you must press two or more keys simultaneously, the key names are linked with a plus sign (+).

Example: <Ctrl>+<Alt>+

Command

Means that you must type the command exactly as shown, then supply the required item or value enclosed in brackets.

Example: At the DOS prompt, type the command line: `format A:/S`

References

Refer to the following sources for additional information, and for product and software updates.

1. **ASUS Server Web-based Management (ASWM) user guide**

This manual tells how to set up and use the proprietary ASUS server management utility.

2. **ASUS websites**

The ASUS websites worldwide provide updated information for all ASUS hardware and software products. Refer to the ASUS contact information.

Chapter 1

This chapter describes the general features of the chassis kit. It includes sections on front panel and rear panel specifications.

Product introduction

1.1 System package contents

Check your system package for the following items.

Model Name	RS300-E8-PS4, RS300-E8-RS4
Chassis	ASUS R10E 1U Rackmount Chassis
Motherboard	ASUS P9D-C/4L Server Board
Component	1 x 400W Single Power Supply (RS300-E8-PS4) 1 x 450W Redundant Power Supply (RS300-E8-RS4) 4 x Hot-swap 3.5" HDD trays 1 x SAS/SATA Backplane (BP4LX-R10A) 1 x PCI Riser Card (RE16LE8R-R10A) 1 x Front I/O Board (FPB-R20D) 4 x System Fans (40mm x 28mm)
Accessories	1 x RS300-E8 Series User's Guide 1 x ASWM* User's Guide 1 x ASMB7 User's Guide (if ASMB7-iKVM is selected) 1 x RS300-E8 Series Support DVD 1 x ASWM* DVD 1 x ASMB7 DVD (if ASMB7-iKVM is selected) 1 x Bag of Screws 1 x AC Power Cable (RS300-E8-PS4) 2 x AC Power Cable (RS300-E8-RS4)
Optional Items	1 x CPU Heatsink ASUS ASMB7-iKVM Remote management card DVD-ROM/DVD-RW Second 450W Redundant Power Supply Module (RS300-E8-RS4) 1 x Friction Rail Kit

*ASUS System Web-based Management



If any of the above items is damaged or missing, contact your retailer.

1.2 Serial number label

Before requesting support from the ASUS Technical Support team, you must take note of the product's serial number containing 14 characters such as xxS0xxxxxxxxxx shown as the figure below. With the correct serial number of the product, ASUS Technical Support team members can then offer a quicker and satisfying solution to your problems.



1.3 System specifications

The ASUS RS300-E8 Series is a 1U barebone server system featuring the ASUS P9D-C/4L Server Board. The server supports Intel® LGA1150 Intel® Xeon® E3-1200 Processor v3 plus other latest technologies through the chipsets onboard.

Model Name	RS300-E8-PS4,	RS300-E8-RS4
Processor Support / System Bus	1 x Socket LGA1150 Intel® Xeon® Processor E3-1200 v3 Family	
Core Logic	Intel® C224 Chipset	
Memory	Total Slots	4 (2 Channels)
	Capacity	Maximum up to 32GB (UDIMM)
	Memory Type	DDR3 1333/1600 ECC UDIMM
	Memory Size	2GB, 4GB, 8GB (UDIMM)
Expansion Slots (follow SSI Location #)	Total PCI/PCI-E Slots	2
	Slot Type	1 x PCI-E x16 (x8 Gen3 link) (Full-Height/HL)) 1 x PCI-E x8 (x4 Gen3 link) (Full-Height/HL)
	Additional Slot 1	1 x PIKE Slot for Storage enhancement
Storage	SATA Controller	Intel® C224: - 2 x SATA 3Gb/s ports - 4 x SATA 6Gb/s ports - Intel® Rapid Storage Technology Enterprise (RSTe) supports software RAID 0, 1, 10, & 5 (Windows®)
	SAS Controller	Optional kits: ASUS PIKE 2008 8-port SAS 6G RAID Card ASUS PIKE 2108-32PD 8-port SAS 6G RAID Card ASUS PIKE 2308 8-port SAS 6G RAID Card
HDD Bays	I = internal A or S = hot-swappable	4 x Hot-swap 3.5 in. HDD Bays 2 x SSD Bays (Optional)
Networking	LAN	4 x Intel® I210 + 1 x Management LAN
Graphic	VGA	Aspeed AST2300 32MB

(continued on the next page)

Model Name		RS300-E8-PS4	RS300-E8-RS4
Onboard I/O Connectors		1 x External Serial Port 5 x RJ-45 ports (1 for ASMB7-iKVM) 4 x USB 3.0 ports (Front x 2, Rear x 2) 2 x USB 2.0 ports (Rear x 2) 2 x VGA port (Front x 1, Rear x 1) 1 x Internal A-Type USB Port 1 x PS/2 keyboard/mouse combo port	
OS Support		Windows® Server 2012 Windows® 8 64-bit Windows® Server 2008 Enterprise SP2 64-bit Windows® Server 2008 Enterprise R2 SP1 64-bit RedHat® Enterprise Linux AS 5.8/6.3 U8 64-bit Centos 5.8/6.2/6.3 64-bit (Subject to change without any notice)	
Management Solution	Software	ASWM Enterprise	
	Out of Band Remote Management	Optional ASMB7-iKVM for KVM-over-IP	
Dimension (HH x WW x DD)		615mm x 444mm x 43.4mm	
Net Weight Kg (CPU, DRAM & HDD not included)		16 Kg	
Power Supply		Single 400W 80PLUS Gold Power Supply	1+1 Redundant 450W 80PLUS Gold Power Supply
Power Rating		100-240VAC, 6.3-3A, 60-50Hz, Class I	100-127/200-240Vac, 8/4A, 47-63Hz, Class I
Environment		Operating temperature: 10°C – 40°C Non operation temperature: -40°C – 70°C Non operation humidity: 20% – 90% (Non condensing)	

*Specifications are subject to change without notice.

1.4 Front panel features

The barebone server displays a simple yet stylish front panel with easily accessible features. The power and reset buttons, LED indicators, and USB port for each Node are located on the front panel.



Refer to section 1.7.1 **Front panel LEDs** for the LED descriptions.

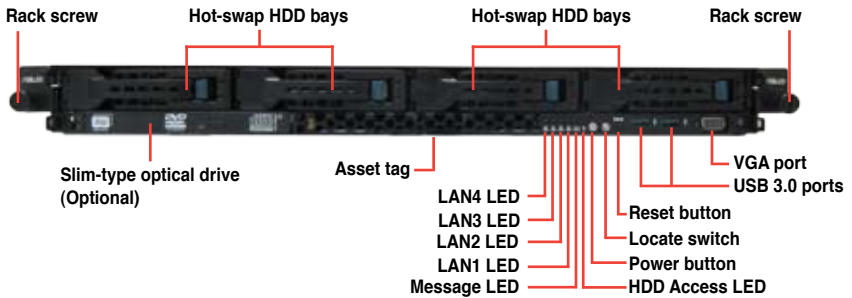

Turn off the system power and detach the power supply before removing or replacing any system component.

Asset tag

The Asset tag is a simple but useful device that is conveniently located on the front panel of the server that you can pull out or easily slide back in. It has a piece of paper that allows you to write down important information about the server.



1.5 Rear panel features

The rear panel includes the expansion slots, system power sockets, and rear fans. The I/O shields with openings for the rear panel connectors on the motherboard are also placed in the rear panel.



The ports for the USB, VGA, and Gigabit LANs do not appear on the rear panel if the motherboards are not present.

RS300-E8-RS4

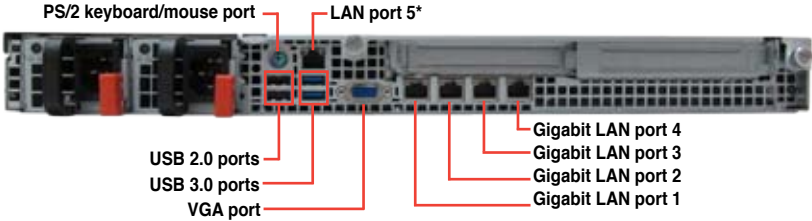

RS300-E8-PS4

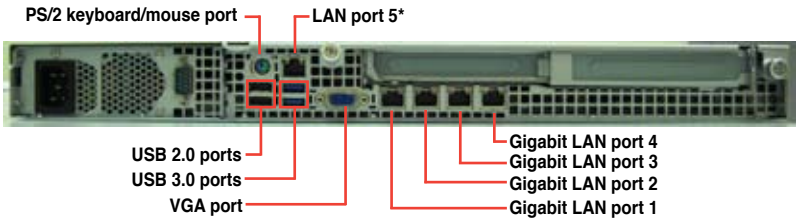

* This port is for ASUS ASMB7-iKVM controller card only.

1.6 Internal features

The barebone server includes the basic components as shown.

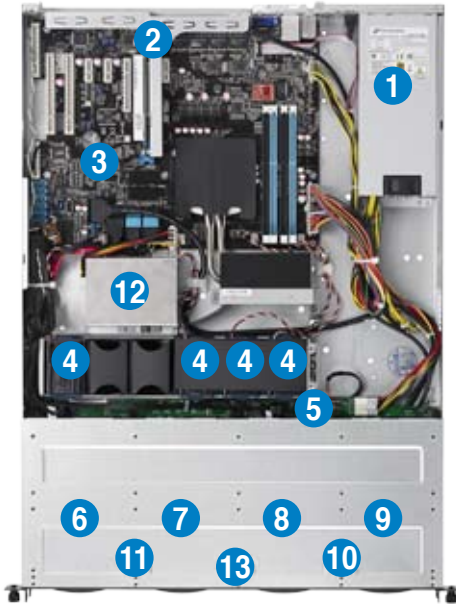

1. Power supply and power fan
2. PCI Express slot Riser Card
3. ASUS P9D-C/4L Server Boards
4. System fans
5. SAS / SATA backplane (hidden)
6. HDD tray 1—Connect to SATA1 port
7. HDD tray 2—Connect to SATA2 port
8. HDD tray 3—Connect to SATA3 port
9. HDD tray 4—Connect to SATA4 port
10. Front I/O boards (hidden)
11. Slim-type optical drive
12. SSD Cage (Optional)
13. Asset Tag



Turn off the system power and detach the power supply before removing or replacing any system component.



The barebone server does not include a floppy disk drive. Connect a USB floppy disk drive to any of the USB ports on the front or rear panel if you need to use a floppy disk.

***WARNING**
HAZARDOUS MOVING PARTS
KEEP FINGERS AND OTHER BODY PARTS AWAY

1.7 LED information

1.7.1 Front panel LEDs



LED	Icon	Display status	Description
Power LED		ON	System power ON
HDD Access LED		OFF	No activity
		Blinking	Read/write data into the HDD
Message LED		OFF	System is normal; no incoming event
		ON	1. Without ASMB7-iKVM installed: CPU over-heated 2. With ASMB7-iKVM installed: a hardware monitor event is indicated
LAN LEDs		OFF	No LAN connection
		Blinking	LAN is transmitting or receiving data
		ON	LAN connection is present
Location LED		ON	Location switched is pressed.
		OFF	Normal status. (Press the location switch again to turn off.)

1.7.2 LAN (RJ-45) LEDs



ACT/LINK LED		SPEED LED	
Status	Description	Status	Description
OFF	No link	OFF	10 Mbps connection
GREEN	Linked	ORANGE	100 Mbps connection
BLINKING	Data activity	GREEN	1 Gbps connection

1.7.3 HDD status LED

HDD status LED



SATA HDD LED	Description
GREEN	This installed Serial ATA HDD is in good condition
OFF	HDD failure or no HDD is installed

Chapter 2

This chapter lists the hardware setup procedures that you have to perform when installing or removing system components.

Hardware setup

2.1 Chassis cover

Removing the rear cover

1. Locate and remove the front side screws.

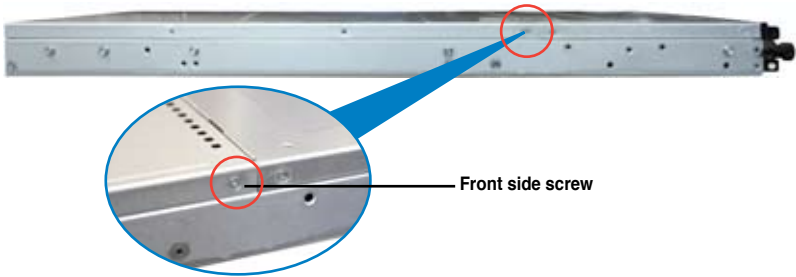

2. Loosen the two thumbscrews on the rear panel to release the rear cover from the chassis.

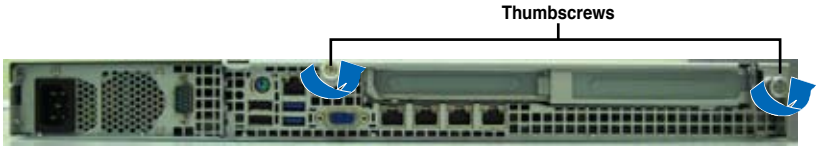

3. Firmly hold the cover and slide it toward the rear panel for about half an inch until it is disengaged from the chassis.
4. Lift the cover from the chassis.
5. To recover the rear cover, reverse step 1 to 4.



A protection film is pre-attached to the system cover before shipping. Please remove the protection film before turning on the system for proper heat dissipation.



2.2 Central Processing Unit (CPU)

The motherboard comes with a surface mount LGA 1150 Socket designed for the Intel® Sandy Bridge and Ivy Bridge series processors.



Ensure that all power cables are unplugged before installing the CPU.



- Upon purchase of the motherboard, ensure that the PnP cap is on the socket and the socket contacts are not bent. Contact your retailer immediately if the PnP cap is missing, or if you see any damage to the PnP cap/socket contacts/motherboard components. ASUS shoulders the repair cost only if the damage is shipment/transit-related.
- Keep the cap after installing the motherboard. ASUS will process Return Merchandise Authorization (RMA) requests only if the motherboard comes with the cap on the LGA 1150 socket.
- The product warranty does not cover damage to the socket contacts resulting from incorrect CPU installation/removal, or misplacement/loss/incorrect removal of the PnP cap.

2.2.1 Installing the CPU

To install a CPU

1. Locate the CPU socket on the motherboard.

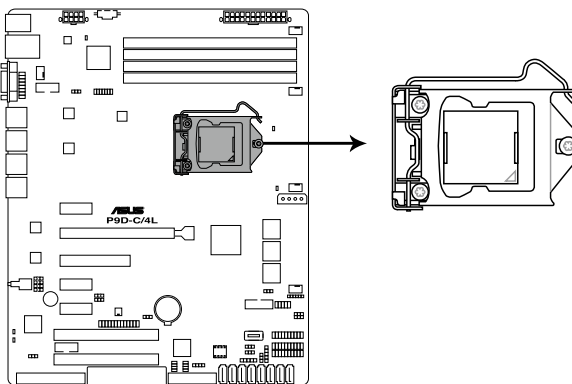

P9D-C/4L CPU LGA1150



Before installing the CPU, ensure that the socket box is facing toward you and the load lever is on your right.

2. Press the load lever with your thumb (A), then move it to the right (B) until it is released from the retention tab.



Do not remove the PnP cap yet from the CPU socket. Doing so may bend the pins of the socket.

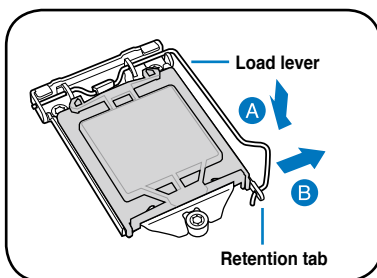

3. Lift the load lever until the load plate is completely lifted.

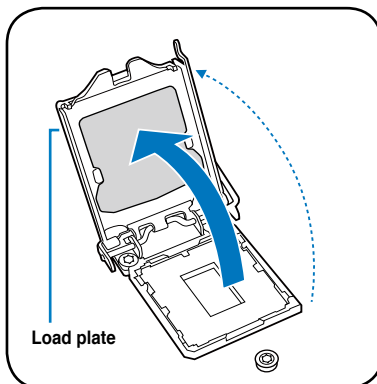

4. Position the CPU above the socket, ensuring that the gold triangle mark is on the bottom-left corner of the socket, then fit the CPU notches to the socket's alignment keys.



The CPU fits in only one orientation. DO NOT force the CPU into the socket to prevent bending the pins on the socket and damaging the CPU.

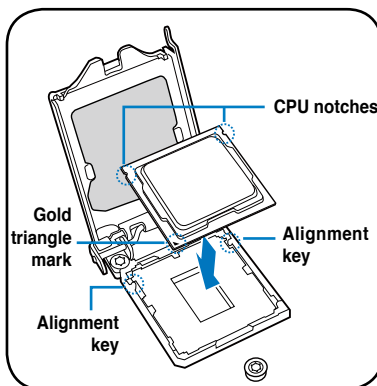

5. Close the load plate (A), ensuring that the front edge of the load plate slides under the retention lock (B) then push down the load lever (C).

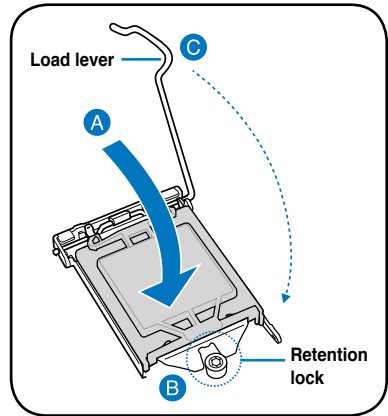

6. Insert the load lever under the retention tab to remove the PnP cap from the CPU socket.

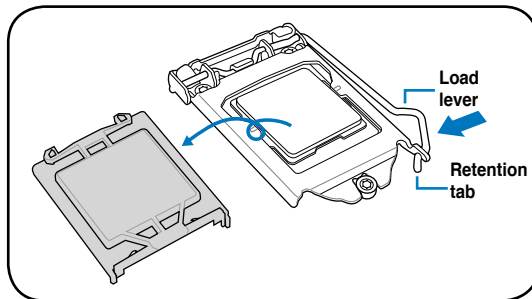

7. Apply some Thermal Interface Material to the exposed area of the CPU that the heatsink will be in contact with, ensuring that it is evenly spread in a thin layer.



Some heatsinks come with pre-applied Thermal Interface Material. If so, skip this step.



The Thermal Interface Material is toxic and inedible. DO NOT eat it. If it gets into your eyes or touches your skin, wash it off immediately and seek professional medical help.

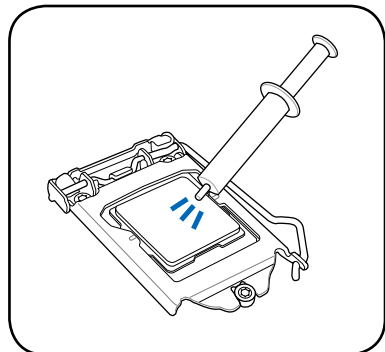

2.2.2 Installing the CPU heatsink and airduct

To install the CPU heatsink

1. Remove the protection sticker on the back of the CPU heatsink.



2. Place the heatsink on top of the installed CPU, ensuring that the four fasteners match the holes on the motherboard.

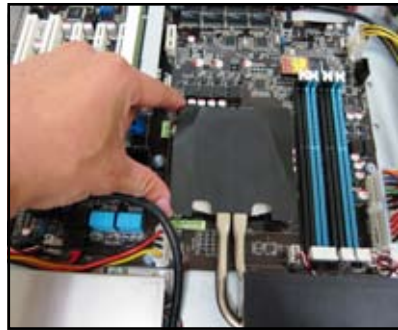

3. Twist each of the four screws with a Philips (cross) screwdriver just enough to attach the heatsink to the motherboard. When the four screws are attached, tighten them one by one to completely secure the heatsink.

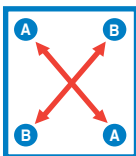
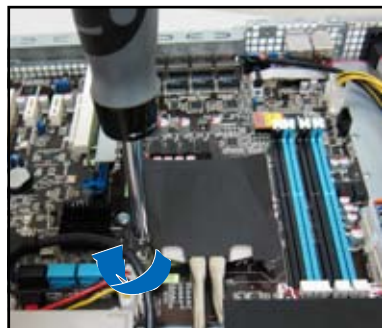

- Tighten the four heatsink screws in a diagonal sequence.
- Do not remove the mylar on the heatsink.

4. Secure the heat pipe and air duct to the server with two screws.

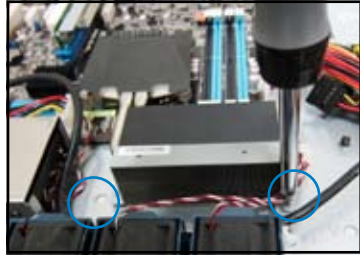

5. Insert the two tips of the system fan mylar into the CPU heatsink, as shown in the right figure.

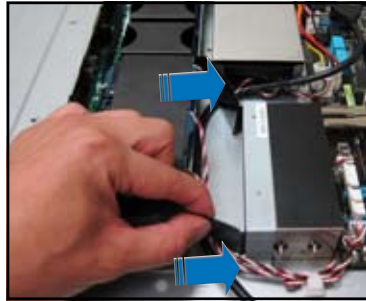

2.3 System memory

2.3.1 Overview

The motherboard comes with six (6) Double Data Rate 3 (DDR3) Dual Inline Memory Modules (DIMM) sockets.

The figure illustrates the location of the DDR3 DIMM sockets:

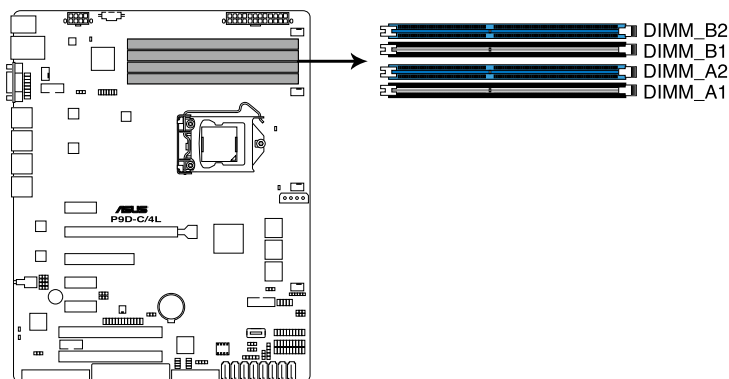

P9D-C Series 240-pin DDR3 DIMM sockets

2.3.2 Memory Configurations

You may install 2GB, 4GB and 8GB Unbuffered with ECC DDR3 DIMMs into the DIMM sockets using the memory configurations in this section.

UDIMM				
DIMM Slot Per Channel	DIMM Populated per Channel	DIMM Type	Speed	Rank per DIMM
2	1	Unbuffered DDR3 ECC	1333/1600	Single Rank, Dual Rank
2	2	Unbuffered DDR3 ECC	1333/1600	Single Rank, Dual Rank



- Always install DIMMs with the same CAS latency. For optimum compatibility, it is recommended that you obtain memory modules from the same vendor.
- Start installing the DIMMs in slots A2 and B2 (Blue).

2.3.3 Installing a DIMM

1. Unlock a DIMM socket by pressing the retaining clip outward.
2. Align a DIMM on the socket such that the notch on the DIMM matches the DIMM slot key on the socket.

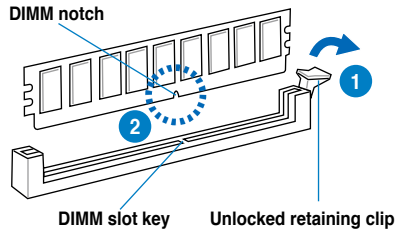

A DIMM is keyed with a notch so that it fits in only one direction. DO NOT force a DIMM into a socket in the wrong direction to avoid damaging the DIMM.

3. Hold the DIMM by both of its ends then insert the DIMM vertically into the socket. Apply force to both ends of the DIMM simultaneously until the retaining clip snaps back into place and the DIMM cannot be pushed in any further to ensure proper sitting of the DIMM.

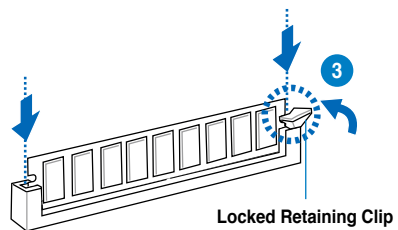

Always insert the DIMM into the socket vertically to prevent DIMM notch damage.



- To install two or more DIMMs, refer to the user guide bundled in the motherboard package.
- Refer to the user guide for qualified vendor lists of the memory modules.

Removing a DIMM from a single clip DIMM socket

1. Press the retaining clip outward to unlock the DIMM.
2. Remove the DIMM from the socket.

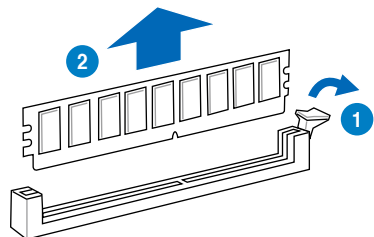

Support the DIMM lightly with your fingers when pressing the retaining clips. The DIMM might get damaged when it flips out with extra force.

2.4 Hard disk drives

The system supports four hot-swap SATAIII/SAS hard disk drives and two SATAII hard disk drives. The hard disk drive installed on the drive tray connects to the motherboard SATA/SAS ports via the SATA/SAS backplane.

To install a hot-swap SATA/SAS HDD

1. Release a drive tray by pushing the spring lock to the right, then pulling the tray lever outward. The drive tray ejects slightly after you pull out the lever.

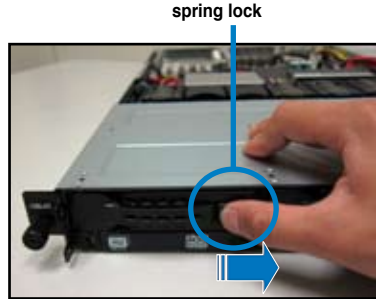

2. Firmly hold the tray lever and pull the drive tray out of the bay.



3. Take note of the drive tray holes. Each side has three holes to fit different types of hard disk drives. Use two screws on each side to secure the hard disk drive.



4. Place a SATA/SAS hard disk drive on the tray, then secure it with four screws.



5. Carefully insert the drive tray and push it all the way to the depth of the bay until just a small fraction of the tray edge protrudes.



When installed, the SATA/SAS connector on the drive connects to the SATA/SAS interface on the backplane.

6. Push the tray lever until it clicks, and secures the drive tray in place. The drive tray is correctly placed when its front edge aligns with the bay edge.
7. Repeat steps 1 to 6 if you wish to install a second SATA/SAS drive.



2.5 Expansion slot

2.5.1 Installing an expansion card to the riser card bracket

The barebone server comes with a riser card bracket. You need to remove the bracket if you want to install PCI Express x8 or x16 expansion cards.

To install a PCI Express x8 or x16 card:

1. Firmly hold the riser card bracket, then pull it up to detach it from the PCI Express x16 slot on the motherboard.

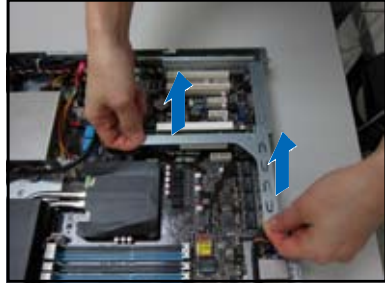

2. Place the riser card bracket on a flat and stable surface, then remove the screw from the slot bay.



3. Install a PCI Express x8 or x16 card to the bracket as shown, then secure the card with a screw.

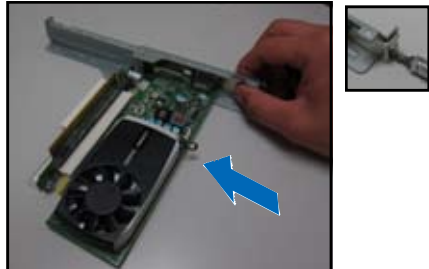

4. Repeat the previous steps to Install another PCI Express x8 or x16 card if needed.

To reinstall the riser card bracket:

1. Align the riser card bracket with the cards to the PCI Express x16 slot on the motherboard.
2. Press the riser card bracket until the golden connectors completely fit the slot and the bracket aligns with the rear panel.
3. Connect the cable(s) to the card, if applicable.

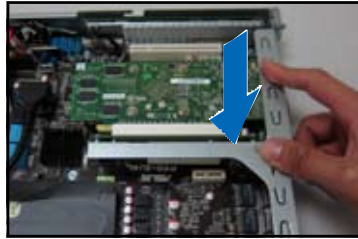

2.5.2 Configuring an expansion card

After installing the expansion card, configure the it by adjusting the software settings.

1. Turn on the system and change the necessary BIOS settings, if any. See Chapter 5 for information on BIOS setup.
2. Assign an IRQ to the card. Refer to the following tables.
3. Install the software drivers for the expansion card.

Standard Interrupt assignments

IRQ	Priority	Standard function
0	1	System Timer
1	2	Keyboard Controller
2	-	Programmable Interrupt
3*	11	Communications Port (COM2)
4*	12	Communications Port (COM1)
5*	13	--
6	14	Floppy Disk Controller
7*	15	--
8	3	System CMOS/Real Time Clock
9*	4	ACPI Mode when used
10*	5	IRQ Holder for PCI Steering
11*	6	IRQ Holder for PCI Steering
12*	7	PS/2 Compatible Mouse Port
13	8	Numeric Data Processor
14*	9	Primary IDE Channel
15*	10	Secondary IDE Channel

* These IRQs are usually available for ISA or PCI devices.

2.6 Cable connections



- The bundled system cables are pre-connected before shipment. You do not need to disconnect these cables unless you will remove pre-installed components to install additional devices.
- Refer to Chapter 4 for detailed information on the connectors.

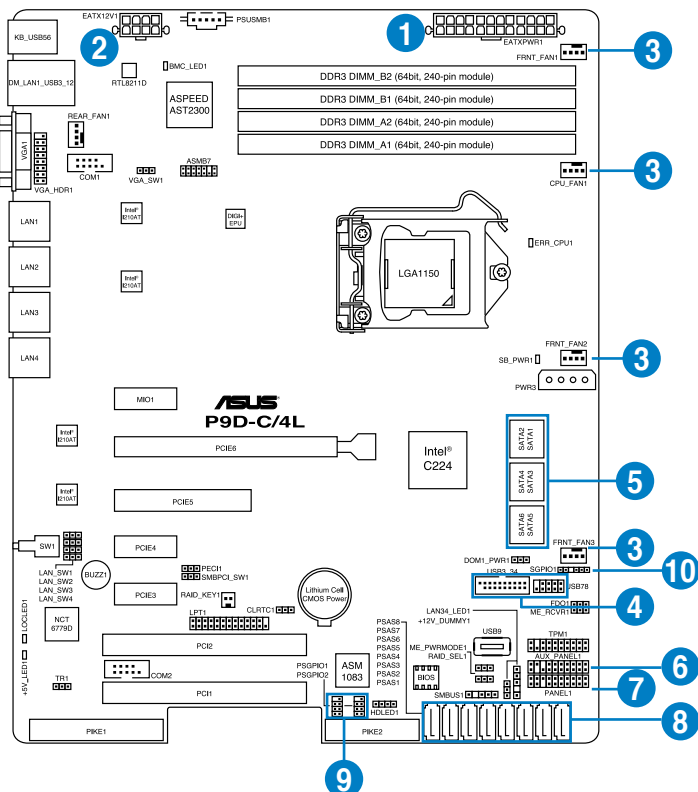

Standard cables connected to the motherboard

- 24-pin ATX power connector (from power supply to motherboard)
- 8-pin 12V power connector (from power supply to motherboard)
- System fan connector (from system fan to motherboard)
- USB connector (from motherboard to front I/O board)
- SATA connectors (system default; from motherboard to SATA/SAS backplane)
- System auxiliary panel connector (from motherboard to front I/O board)
- System panel connector (from motherboard to front I/O board)
- SAS connectors (for ASUS PIKE only; from motherboard to SATA/SAS backplane)
- PIKE Serial General Purpose Input/Output connectors
- Serial General Purpose Input/Output connectors

2.7 SATA/SAS backplane cabling

RS300-E8-RS4



RS300-E8-PS4

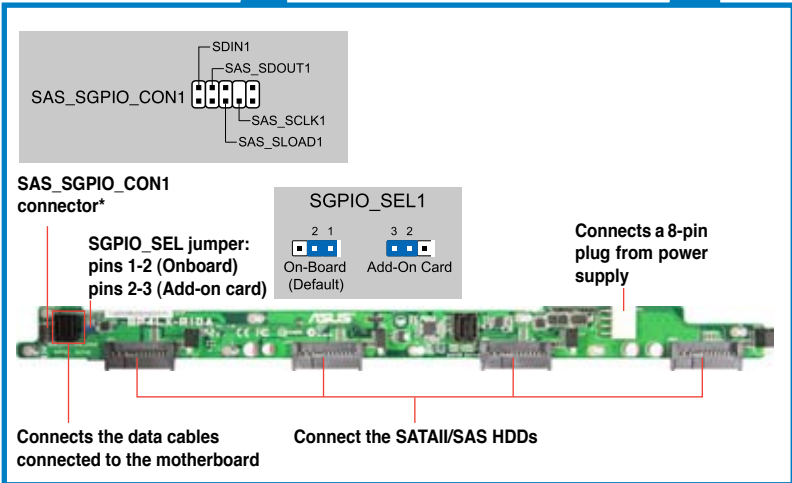

* For PIKE RAID solution, ensure to connect SAS_SGPIO_CON1 to support PIKE card SAS RAID function.

2.8 Removable/optional components

You may need to remove previously installed system components when installing or removing system devices. Or you may need to install the optional components into the system. This section tells how to remove/install the following components:

1. System fans
2. ASUS PIKE RAID card (optional)
3. ASUS ASMB7-iKVM (optional)
4. SSD cage (optional)



Ensure that the system is turned off before removing any components.

2.8.1 System fans

To uninstall the system fans:

1. Disconnect the system fan cable from the fan connector on the motherboard.

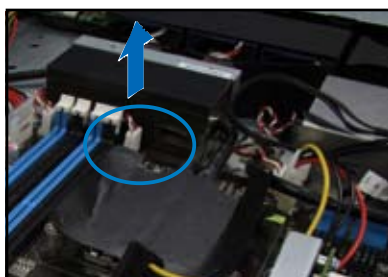

2. Lift the fan, then set aside.
3. Repeat steps 1 to 2 to uninstall the other system fans.

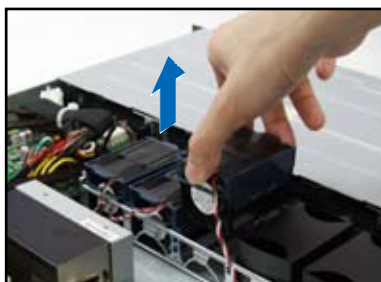

To reinstall the system fans

1. Insert the fan to the fan cage. The airflow directional arrow on the fan side should point towards the system rear panel.
2. Connect the system fan cable to the fan connector on the motherboard.

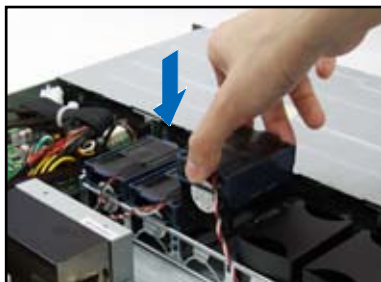

2.8.2 Installing ASUS PIKE RAID card (optional)

Follow the steps below to install an optional ASUS RAID card on your motherboard.

1. Locate the PIKE RAID card slot on the motherboard.



2. Align the golden fingers of the RAID card with the PIKE RAID card slot.

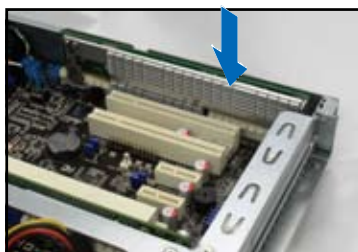

3. Insert the RAID card into the PIKE RAID card slot. Ensure that it is completely seated on the PIKE RAID card slot.

4. Remove the SATA/SAS cables from the onboard SATA1–4 connectors.

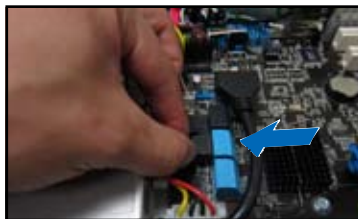

5. Connect the SATA/SAS cables to the onboard SAS1-4 connectors (blue).



6. Move the **SGPIO_SEL1** jumper on the SATA/SAS backplane to 2-3.

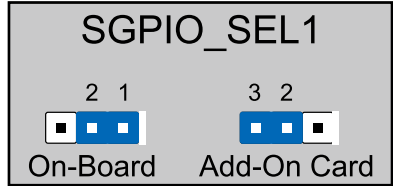

2.8.3 Installing ASMB7 series management board (optional)

Follow the steps below to install an optional ASMB7 series management board on your motherboard.

1. Locate the ASMB7 header on the motherboard.



2. Orient and press the ASMB7 management card in place.



3. Insert the LAN cable plug to the LAN port 5 (dedicated LAN) or LAN port 1 (shared LAN) for server management.

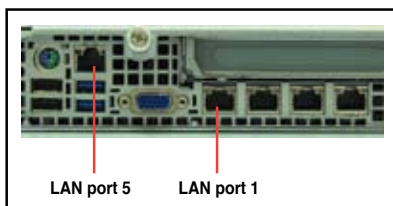

2.8.4 Installing the SSD cage (optional)

Follow the steps below to install the optional SSD cage on your server module.

1. Remove the three screws on the side of the SSD cage.
2. Lift the SSD cage and set aside.



2. With the SSD cage resting on a flat surface, insert the SSD card into the SSD cage.



- The SS Card fits in one orientation only.
- You can place two SSD cards into the SSD cage.



3. Secure the SSD card into the SSD cage with the bundled screws.



4. Connect the SATA power cable and the SATA connector to the SSD card.

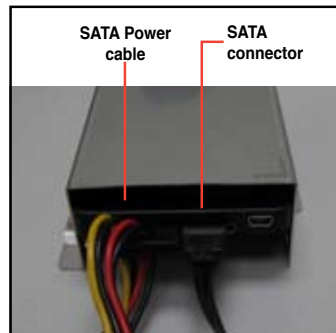

5. Secure the SSD cage to the server module using the bundled screws.



6. Connect the SATA cable connector to the onboard SATA connectors



7. Connect the Power cable to the connector on the motherboard.



Chapter 3

This chapter describes how to install the optional components and devices into the barebone server.

Installation options

3.1 Friction Rail Kit Installation Guide

Your friction rail kit package contains:

- One pair of rack rails
- One pair of fixing latches
- 4 latch screws, 4 rail screws and 4 rail washers (2 more for each buffer)

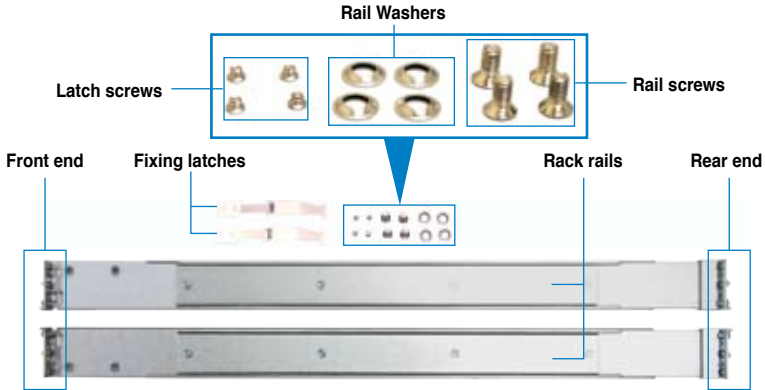

3.1.1 Attaching the fixing latches to the server

1. Secure the two fixing latches to the two sides of the server with the four latch screws.



The locations of the screw holes vary with different server models. Refer to your server user manual for details.



2. Select a 1U space on the rack where you want to install the rack rail. A 1U space consists of three square mounting holes with two thin lips on the top and the bottom, as shown in the right figure.
3. Adjust the rack rail to fit the depth of the rack.

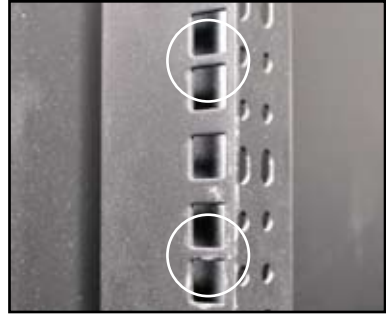

4. From inside the rack, place the rear rail hook on the bottom thin lip of the rear mounting hole, and then place the front rail hook on the bottom thin lip of the front mounting hole, as shown in the right figure.



5. Secure the front and rear ends of the rail with two rack screws and washers.
6. Repeat step 3 to 5 to attach the rack rail on the other side of the rack.



7. When mounting the server to the rack, ensure to include the side knots on the two sides of the server in the rack rail holders, as shown in the right figure.



Do not install the rail kit in the following situation:



DO NOT place the rail hook on a thick lip of the mounting hole.



DO NOT install the rail to the outer side of the server rack.

Chapter 4

This chapter includes the motherboard layout and brief descriptions of the jumpers and internal connectors.

Motherboard Info

4.1 Motherboard layout

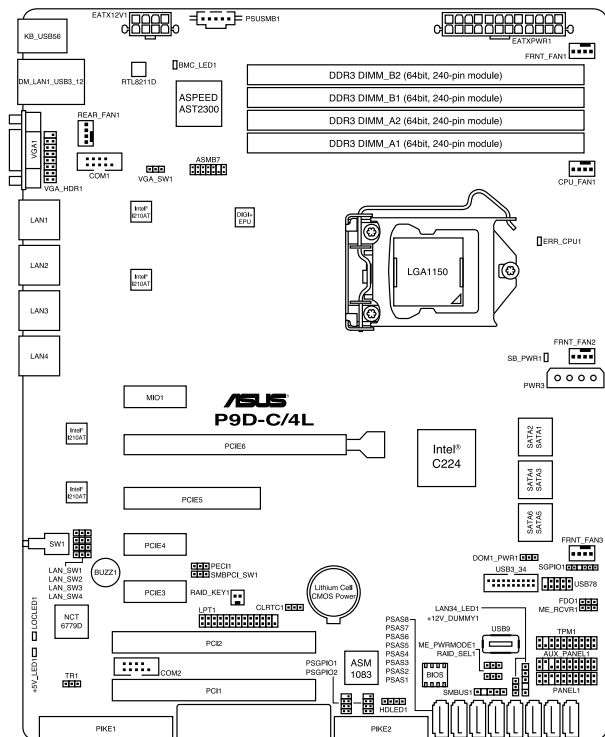

Layout contents

Jumpers		Page
1.	Clear RTC RAM (CLRTC1)	4-4
2.	VGA controller setting (3-pin VGA_SW1)	4-5
3.	LAN controller setting (3-pin LAN_SW1, LAN_SW2, LAN_SW3, LAN_SW4)	4-5
4.	RAID configuration utility selection (3-pin RAID_SEL1)	4-6
5.	Platform Environmental Control Interface (PECI) Setting (3-pin PECI1)	4-6

Internal connectors		Page
1.	Serial ATA 6.0/3.0 Gbps connector (7-pin 6Gbps SATA1, SATA2, SATA3, SATA4 [Light Blue]) (7-pin 3Gbps SATA5, SATA6 [Black])	4-7
2.	PSAS connectors (7-pin PSAS1, PSAS2, PSAS3, PSAS4, PSAS5, PSAS6, PSAS7, PSAS8 [Blue])	4-8
3.	Hard disk activity LED connector (4-pin HDLED1)	4-9
5.	USB 2.0 connector (10-1 pin USB78; A-Type USB9)	4-9
6.	USB 3.0 connector (20-1 pin USB3_34)	4-10
7.	Thermal sensor cable connectors (3-pin TR1)	4-10
8.	CPU, front, and rear fan connectors (4-pin CPU_FAN1, FRNT_FAN1, FRNT_FAN2, FRNT_FAN3, REAR_FAN1)	4-11
9.	Serial General Purpose Input/Output connector (6-1 pin SGPIO1) PIKE Serial General Purpose Input/Output connectors (8-1 pin PSGPIO1, PSGPIO2)	4-12
9.	Serial port connectors (10-1 pin COM1/COM2)	4-13
10.	Power Supply SMBus connector (5-pin PSUSMB1)	4-13
11.	Trusted Platform Module connector (20-1 pin TPM1)	4-14
12.	SATA DOM power connector (4-pin PWR3)	4-14
13.	LAN34_LED connector (5-pin LAN34_LED1)	4-15
14.	Parallel port connector (26-1 pin LPT1)	4-15
15.	VGA connector (16-1 pin VGA_HDR1)	4-16
16.	ATX power connectors (24-pin EATXPWR1, 8-pin EATX12V1)	4-17
17.	System panel connector (20-1 pin PANEL1)	4-18
18.	Auxiliary panel connector (20-2 pin AUX_PANEL1)	4-19

Onboard LEDs		Page
1.	Standby Power LED (SB_PWR1)	4-20
2.	Baseboard Management Controller LED (BMC_LED1)	4-20
3.	CPU Warning LED (ERR_CPU1)	4-21
4.	Power LED (+5V_LED1)	4-21
5.	Location LED (LOCLED1)	4-22

4.2 Jumpers

1. Clear RTC RAM (3-pin CLRTC1)

This jumper allows you to clear the Real Time Clock (RTC) RAM in CMOS. You can clear the CMOS memory of date, time, and system setup parameters by erasing the CMOS RTC RAM data. The onboard button cell battery powers the RAM data in CMOS, which include system setup information such as system passwords.

To erase the RTC RAM:

1. Turn OFF the computer and unplug the power cord.
2. Move the jumper cap from pins 1–2 (default) to pins 2–3. Keep the cap on pins 2–3 for about 5–10 seconds, then move the cap back to pins 1–2.
3. Plug the power cord and turn ON the computer.
4. Hold down the key during the boot process and enter BIOS setup to re-enter data.



Except when clearing the RTC RAM, never remove the cap on CLRTC jumper default position. Removing the cap will cause system boot failure!



If the steps above do not help, remove the onboard battery and move the jumper again to clear the CMOS RTC RAM data. After the CMOS clearance, reinstall the battery.

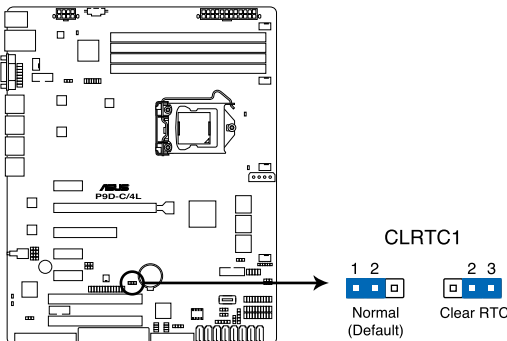

P9D-C Series Clear RTC RAM

2. VGA controller setting (3-pin VGA_SW1)

This jumper allows you to enable or disable the onboard VGA controller. Set to pins 1–2 to activate the VGA feature.

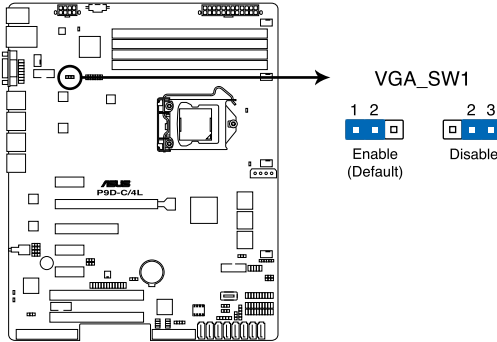

P9D-C Series VGA setting

3. LAN controller setting (3-pin LAN_SW1, LAN_SW2, LAN_SW3, LAN_SW4)

These jumpers allow you to enable or disable the onboard Intel® I210AT Gigabit LAN controllers. Set to pins 1-2 to activate the Gigabit LAN feature.

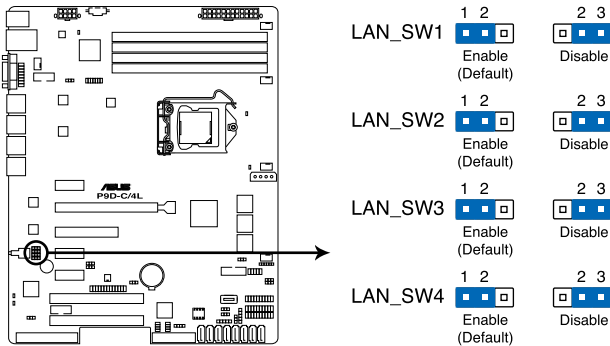

P9D-C Series LAN setting

4. RAID configuration utility selection (3-pin RAID_SEL1)

This jumper allows you to select the RAID configuration utility to use when you create disk arrays. Place the jumper caps over pins 2–3 to use the Intel® Rapid Storage Technology.

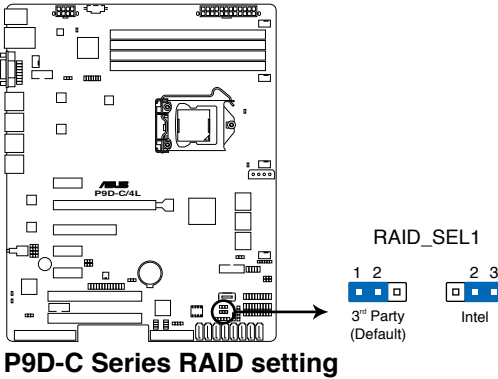

5. Platform Environmental Control Interface Setting (3-pin PECE1)

When an ASMB7-iKVM is installed, set these to pins 2-3 for correct sensor information of the Platform Environmental Control Interface (PECE). Set to pins 1-2 if ASMB7-iKVM is not installed.

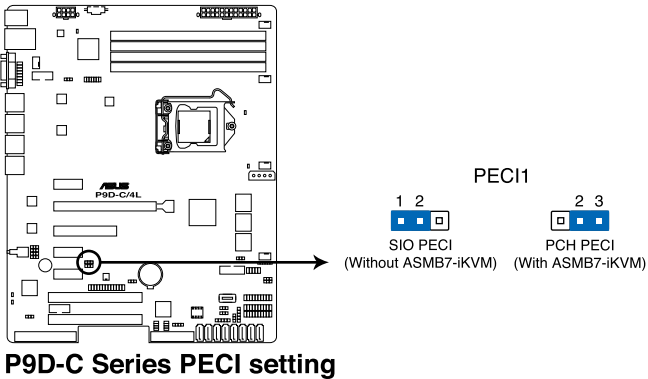

4.3 Internal connectors

1. Serial ATA 6.0/3.0 Gbps connectors

(7-pin 6Gbps SATA1, SATA2, SATA3, SATA4 [Light Blue])

(7-pin 3Gbps SATA5, SATA6 [Black])

Supported by the Intel® C224 chipset, these connectors are for the Serial ATA signal cables for Serial ATA hard disk drives that allows up to 6Gbps of data transfer rate.

If you installed Serial ATA hard disk drives, you can create a RAID 0, RAID 1, RAID 10, or RAID 5 configuration.

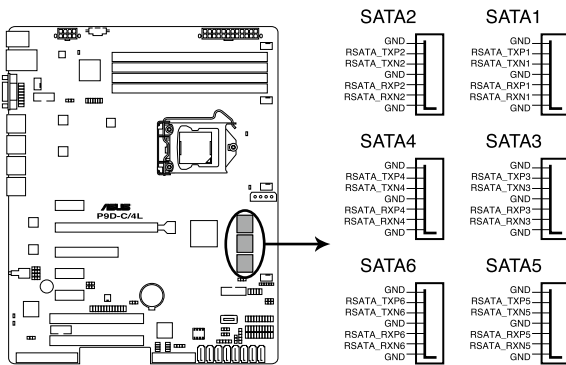

P9D-C Series SATA connectors

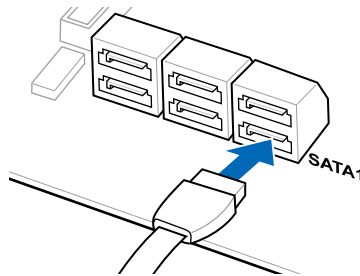

The actual data transfer rate depends on the speed of Serial ATA hard disks installed.

2. PSAS connectors

(7-pin PSAS1, PSAS2, PSAS3, PSAS4, PSAS5, PSAS6, PSAS7, PSAS8 [Light Blue])

This motherboard comes with eight (8) PIKE Serial Attached SCSI (PSAS) connectors that supports both Serial Attached SCSI (SAS) and Serial ATA (SATA). Each connector supports one device.



- These connectors function only when you install a PIKE RAID card.
- Connect the SAS hard disk drives to PSAS connectors 1–8 (blue) when installing a PIKE RAID card.

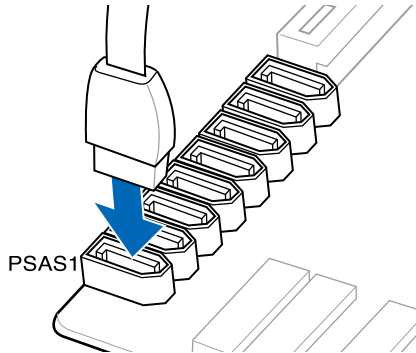
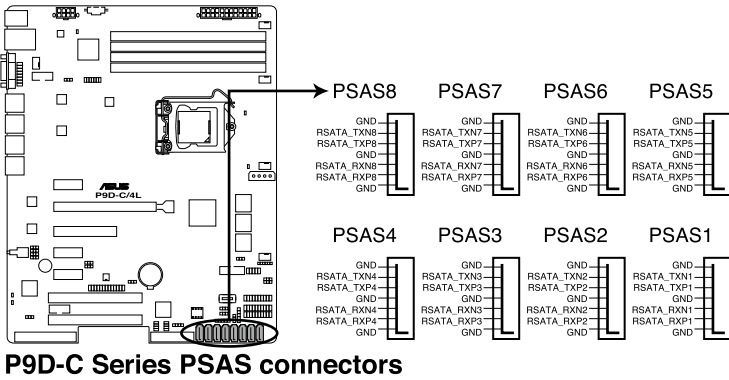

3. Hard disk activity LED connector (4-pin HDLED1)

This LED connector is for the storage add-on card cable connected to the SATA or SAS add-on card. The read or write activities of any device connected to the SATA or SAS add-on card causes the front panel LED to light up.

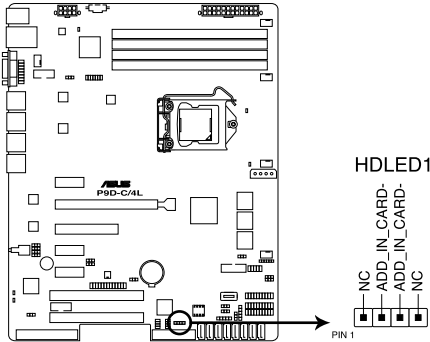

P9D-C Series Storage card activity LED connector

4. USB 2.0 connector (10-1 pin USB78; A-Type USB9)

These connectors are for USB 2.0 ports. Connect the USB module cables to these connectors. These USB connectors comply with USB 2.0 specification that supports up to 480 Mbps connection speed.

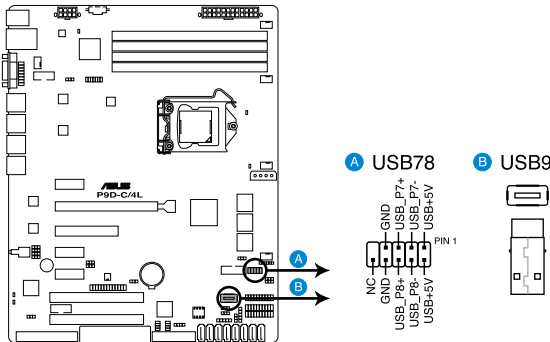

P9D-C Series USB 2.0 connectors

5. USB 3.0 connector (20-pin USB3_34)

These connectors allow you to connect a USB 3.0 module for additional USB 3.0 front or rear panel ports. With an installed USB 3.0 module, you can enjoy all the benefits of USB 3.0 including faster data transfer speeds of up to 5Gbps, faster charging time for USB-chargeable devices, optimized power efficiency, and backward compatibility with USB 2.0.

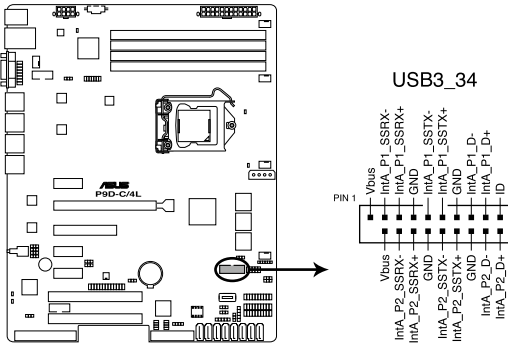

P9D-C Series USB 3.0 connector

6. Thermal sensor cable connectors (3-pin TR1)

This connector allows you to connect a Thermal sensor cable that is used for monitoring temperature. Connect the Thermal sensor cable to the connector and place its probe to the device that you want to monitor.

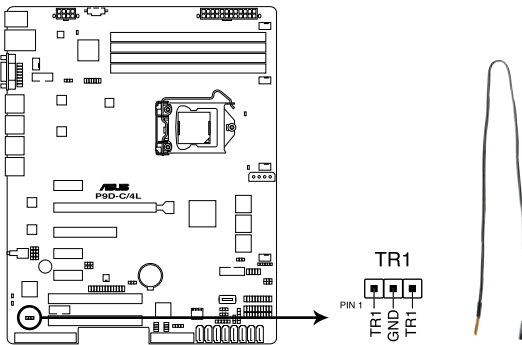

P9D-C Series Thermal sensor cable connector

7. CPU, front, and rear fan connectors

(4-pin CPU_FAN1, FRNT_FAN1, FRNT_FAN2, FRNT_FAN3, REAR_FAN1)

The fan connectors support cooling fans. Connect the fan cables to the fan connectors on the motherboard, ensuring that the black wire of each cable matches the ground pin of the connector.



- DO NOT forget to connect the fan cables to the fan connectors. Insufficient air flow inside the system may damage the motherboard components.
- These are not jumpers! DO NOT place jumper caps on the fan connectors!
- All connectors feature the ASUS Smart Fan technology.

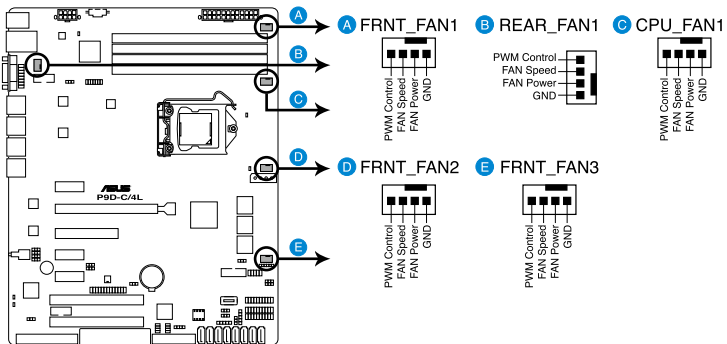

P9D-C Series FAN connectors

8. Serial General Purpose Input/Output connector (6-1 pin SGPIO1)

The SGPIO 1 connectors are used for the Intel Rapid Storage Technology Enterprise SGPIO interface that controls the LED pattern generation, device information, and general purpose data.

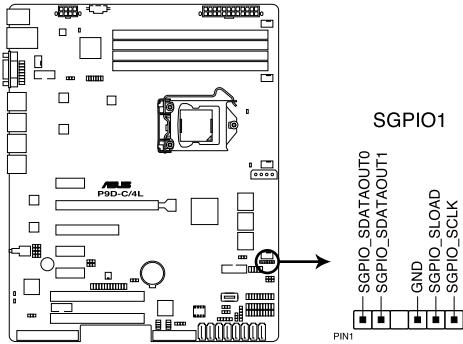

P9D-C Series SGPIO connector



The PSGPIO 1 and PSGPIO 2 connectors only functions when you install an ASUS PIKE RAID card.

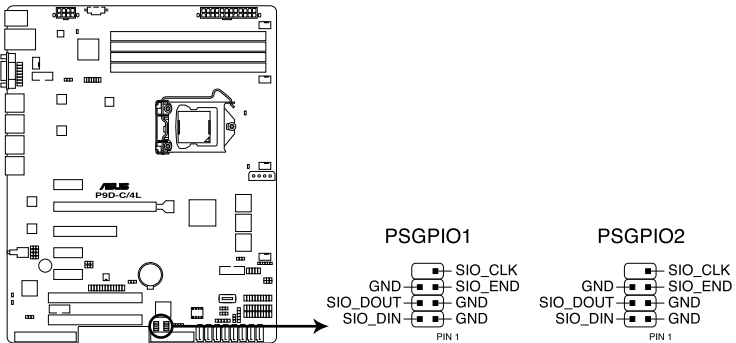

P9D-C Series PSGPIO1/2 connectors

9. Serial port connectors (10-1 pin COM1/COM2)

These connectors are for the serial COM ports. Connect the serial port module cable to one of these connectors, then install the module to a slot opening at the back of the system chassis.

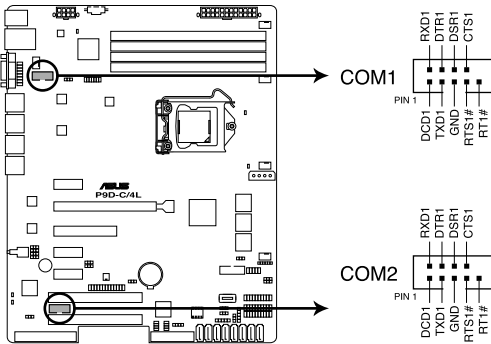

P9D-C Series Serial port connectors

10. Power Supply SMBus connector (5-pin PSUSMB1)

This connector allows you to connect SMBus (System Management Bus) to the power supply unit to read PSU information. Devices communicate with an SMBus host and/or other SMBus devices using the SMBus interface.

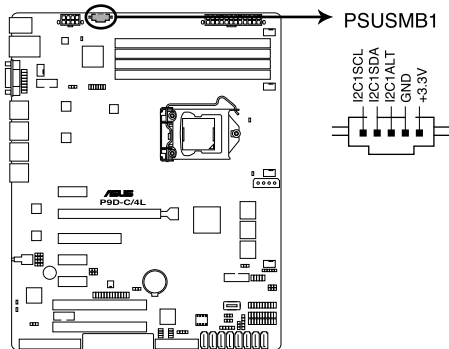

P9D-C Series Power supply SMBus connector



This connector functions only when you install the ASUS ASMB7.

11. Trusted Platform Module connector (20-1 pin TPM1)

This connector supports a Trusted Platform Module (TPM) system, which can securely store keys, digital certificates, passwords, and data. A TPM system also helps enhance network security, protects digital identities, and ensures platform integrity.

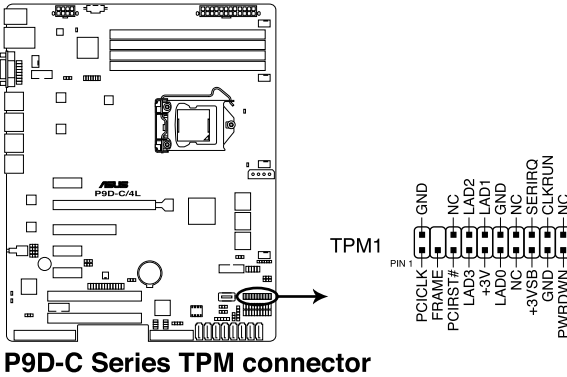

12. SATA DOM power connector (4-pin PWR3)

This 4-pin connector is for 5V power of a certain SATA DOM (Disk on Module) device when using an appropriate cable.

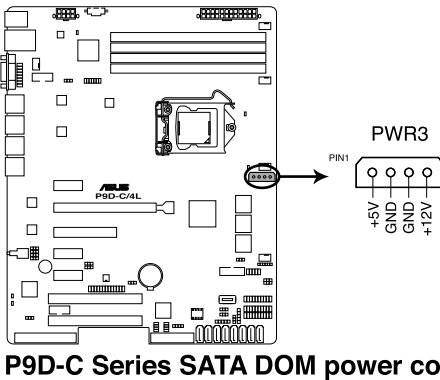

- The SATA DOM power connector is for output power only. It has a maximum output current of 1A.
- Ensure that the power of the SATA DOM device that you will use is less than 1A.

15. VGA connector (16-1 pin VGA_HDR1)

This connector supports the VGA High Dynamic-Range interface.

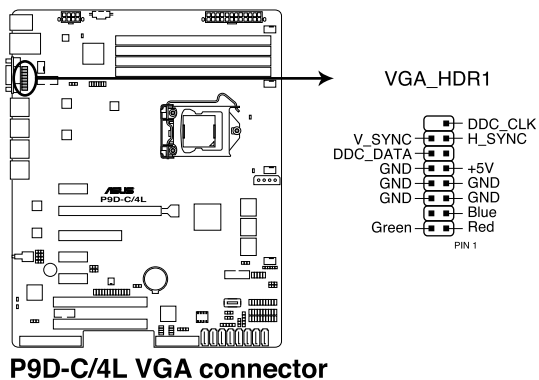

16. ATX power connectors (24-pin EATXPWR1, 8-pin EATX12V1)

These connectors are for the ATX power supply plugs. The power supply plugs are designed to fit these connectors in only one orientation. Find the proper orientation and push down firmly until the connectors completely fit.



- DO NOT forget to connect the 24-pin and the 8-pin power plugs otherwise the system will not boot up.
- Use of a power supply unit (PSU) with a higher power output is recommended when configuring a system with more power-consuming devices. The system may become unstable or may not boot up if the power is inadequate.
- This motherboard supports ATX2.0 PSU or later version.
- Ensure that your PSU can provide at least the minimum power required by your system.

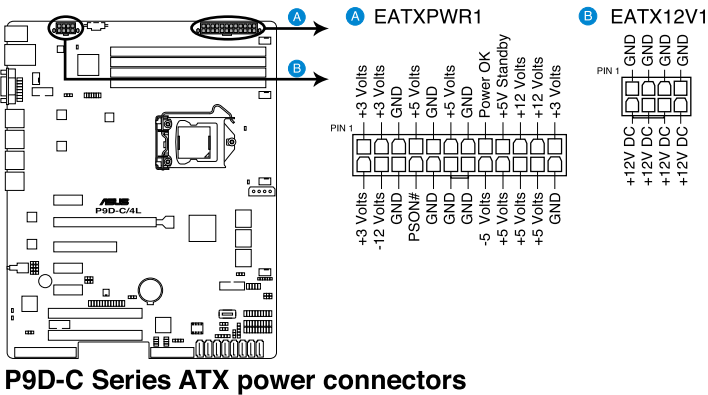

17. System panel connector (20-1 pin PANEL1)

This connector supports several chassis-mounted functions.

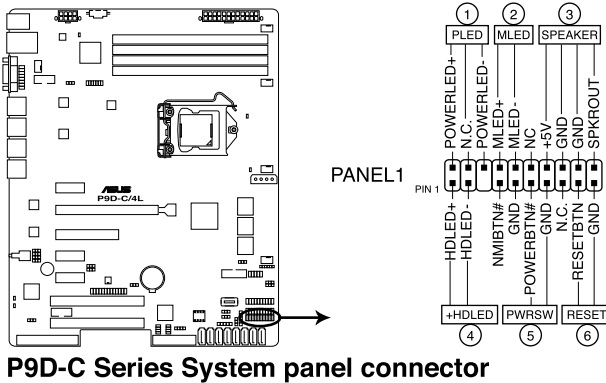

P9D-C Series System panel connector

1. System power LED (3-pin PLED)

This 3-pin connector is for the system power LED. Connect the chassis power LED cable to this connector. The system power LED lights up when you turn on the system power, and blinks when the system is in sleep mode.

2. Message LED (2-pin MLED)

This 2-pin connector is for the message LED cable that connects to the front message LED. The message LED is controlled by Hardware monitor to indicate an abnormal event occurrence.

3. System warning speaker (4-pin SPEAKER)

This 4-pin connector is for the chassis-mounted system warning speaker. The speaker allows you to hear system beeps and warnings.

4. Hard disk drive activity LED (2-pin +HDLED)

This 2-pin connector is for the HDD Activity LED. Connect the HDD Activity LED cable to this connector. The IDE LED lights up or flashes when data is read from or written to the HDD.

5. Power button/soft-off button (2-pin PWRSW)

This connector is for the system power button. Pressing the power button turns the system on or puts the system in sleep or soft-off mode depending on the BIOS settings. Pressing the power switch for more than four seconds while the system is ON turns the system OFF.

6. Reset button (2-pin RESET)

This 2-pin connector is for the chassis-mounted reset button for system reboot without turning off the system power.

18. Auxiliary panel connector (20-2 pin AUX_PANEL1)

This connector is for additional front panel features including front panel SMB, Locator LED and switch, chassis intrusion, and LAN LEDs.

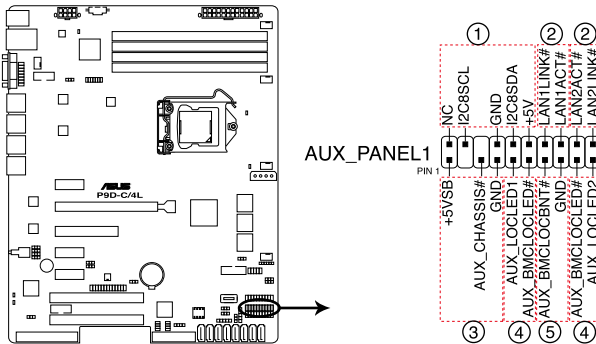

P9D-C Series Auxiliary panel connector

1. Front panel SMB (6-1 pin FPSMB)

These leads connect the front panel SMBus cable.

2. LAN activity LED (2-pin LAN1LINK and 2-pin LAN2LINK)

These leads are for Gigabit LAN activity LEDs on the front panel.

3. Chassis intrusion (4-1 pin AUX_CHASSIS)

These leads are for the intrusion detection feature for chassis with intrusion sensor or microswitch. When you remove any chassis component, the sensor triggers and sends a high-level signal to these leads to record a chassis intrusion event. The default setting is short CASEOPEN and GND pin by jumper cap to disable the function.

4. Locator LED (2-pin AUX_LOCLE1 and 2-pin AUX_LOCLE2)

These leads are for the Locator LED1 and LED2 on the front panel. Connect the Locator LED cables to these 2-pin connector. The LEDs will light up when the Locator button is pressed.

5. Locator Button/Switch (2-pin AUX_BMCLOCBNT)

These leads are for the locator button on the front panel. This button queries the state of the system locator.

4.4 Internal LEDs

1. Standby Power LED (SB_PWR1)

The motherboard comes with a standby power LED. The green LED lights up to indicate that the system is ON, in sleep mode, or in soft-off mode. This is a reminder that you should shut down the system and unplug the power cable before removing or plugging in any motherboard component. The illustration below shows the location of the onboard LED.

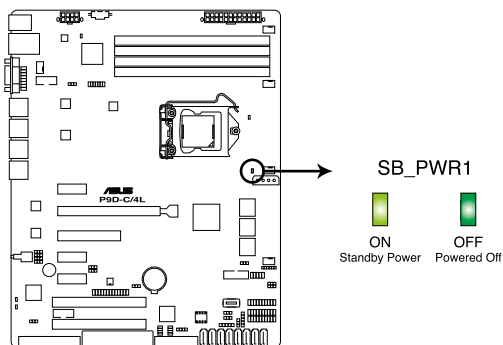

P9D-C Series Standby Power LED

2. Baseboard Management Controller LED (BMC_LED1)

The green heartbeat LED blinks per second to indicate that the ASMB7 is working normally. The BMC LED works with the ASUS ASMB7 management device and indicates its initiation status. When the PSU is plugged and the system is OFF, ASUS ASMB7 management device starts system initiation for about one (1) minute. The BMC LED blinks after system initiation finishes.

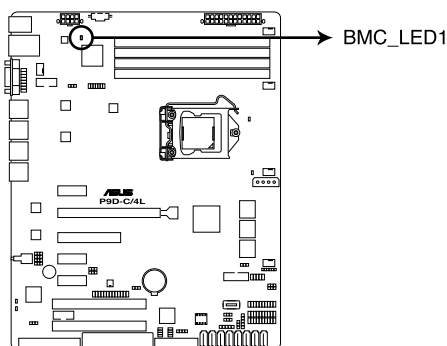

P9D-C Series BMC LED



- The heartbeat LED functions only when you install the ASUS ASMB7 Management card.
- Everytime after the AC power is replugged, you have to wait for about 60 seconds for the system to power up.

3. CPU Warning LED (ERR_CPU1)

The CPU warning LED lights up to indicate that a CPU error or failure has occurred.

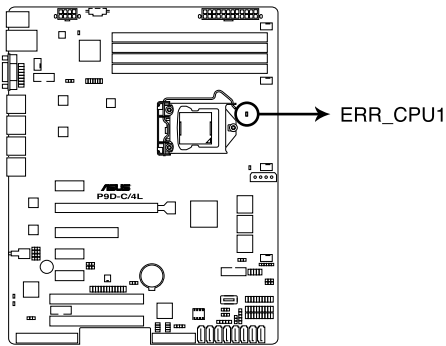

P9D-C Series ERR CPU LED



The warning LED functions only when you install the ASUS ASMB7 Management card.

4. Power LED (+5V_LED1)

This LED lights up when the Power-on button is pressed and the system is on.

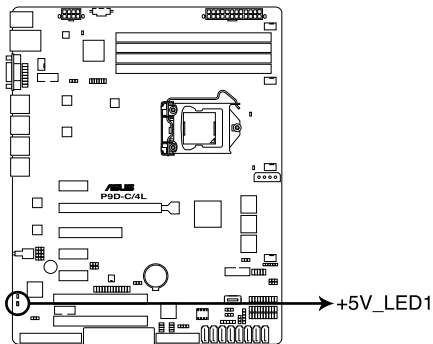

P9D-C Series +5V Power LED

5. Location LED (LOCLED1)

The Location LED is an onboard LED that lights up when the Location Button on the front panel is pressed. This LED helps you visually locate the server among other servers especially when you are located at the back of the server rack.

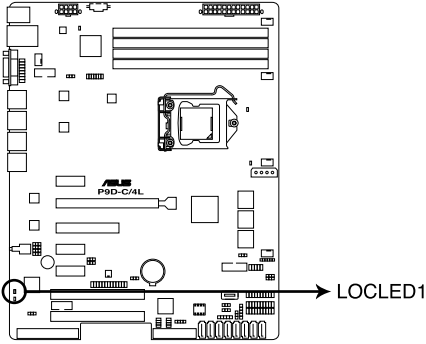

P9D-C Series Location LED

Chapter 5

This chapter tells how to change the system settings through the BIOS Setup menus. Detailed descriptions of the BIOS parameters are also provided.

BIOS setup

5.1 Managing and updating your BIOS

The following utilities allow you to manage and update the motherboard Basic Input/Output System (BIOS) setup:

1. **ASUS CrashFree BIOS 3**

To recover the BIOS using a bootable USB flash disk drive when the BIOS file fails or gets corrupted.

2. **ASUS EzFlash**

Updates the BIOS using a USB flash disk.

3. **BUPDATER**

Updates the BIOS in DOS mode using a bootable USB flash disk drive.

Refer to the corresponding sections for details on these utilities.



Save a copy of the original motherboard BIOS file to a bootable USB flash disk drive in case you need to restore the BIOS in the future. Copy the original motherboard BIOS using the BUPDATER utility.

5.1.1 **ASUS CrashFree BIOS 3 utility**

The ASUS CrashFree BIOS 3 is an auto recovery tool that allows you to restore the BIOS file when it fails or gets corrupted during the updating process. You can update a corrupted BIOS file using a USB flash drive that contains the updated BIOS file.



Prepare a USB flash drive containing the updated motherboard BIOS before using this utility.

Recovering the BIOS from a USB flash drive

To recover the BIOS from a USB flash drive:

1. Insert the USB flash drive with the original or updated BIOS file to one USB port on the system.
2. The utility will automatically recover the BIOS. It resets the system when the BIOS recovery finished.



DO NOT shut down or reset the system while recovering the BIOS! Doing so would cause system boot failure!



The recovered BIOS may not be the latest BIOS version for this motherboard. Visit the ASUS website at www.asus.com to download the latest BIOS file.

5.1.2 ASUS EzFlash Utility

The ASUS EzFlash Utility feature allows you to update the BIOS without having to use a DOS-based utility.



Before you start using this utility, download the latest BIOS from the ASUS website at www.asus.com.



The succeeding BIOS screens are for reference only. The actual BIOS screen displays may not be the same as shown.

To update the BIOS using EzFlash Utility:

1. Insert the USB flash disk that contains the latest BIOS file to the USB port.
2. Enter the BIOS setup program. Go to the Tool menu to select ASUS EzFlash Utility and press <Enter> to enable it.

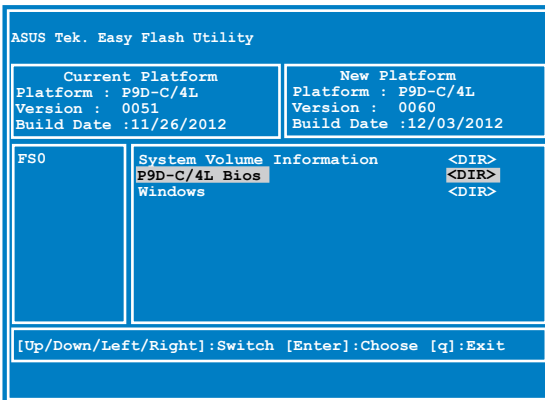

3. Press <Tab> to switch to the Drive field.
4. Press the Up/Down arrow keys to find the USB flash disk that contains the latest BIOS then press <Enter>.
5. Press <Tab> to switch to the Folder Info field.
6. Press the Up/Down arrow keys to find the BIOS file then press <Enter>.
7. Reboot the system when the update process is done.

7. Reboot the system when the update process is done.



- This function can support devices such as a USB flash disk with FAT 32/16 format and single partition only.
- DO NOT shut down or reset the system while updating the BIOS to prevent system boot failure!



Ensure to load the BIOS default settings to ensure system compatibility and stability. Press <F5> and select **Yes** to load the BIOS default settings.

5.1.3 BUPDATER utility



The succeeding BIOS screens are for reference only. The actual BIOS screen displays may not be the same as shown.

The BUPDATER utility allows you to update the BIOS file in DOS environment using a bootable USB flash disk drive with the updated BIOS file.

Updating the BIOS file

To update the BIOS file using the BUPDATER utility:

1. Visit the ASUS website at www.asus.com and download the latest BIOS file for the motherboard. Save the BIOS file to a bootable USB flash disk drive.
2. Download the BUPDATER utility (BUPDATER.exe) from the ASUS support website at support.asus.com to the bootable USB flash disk drive you created earlier.
3. Boot the system in DOS mode, then at the prompt, type:

BUPDATER /i[filename].CAP

where [filename] is the latest or the original BIOS file on the bootable USB flash disk drive, then press <Enter>.

```
A: \>BUPDATER /i[file name]CAP
```

The utility verifies the file, then starts updating the BIOS file.

```
ASUSTek BIOS Update for DOS V1.06 (09/08/04)
FLASH TYPE: MXIC 25L1605A
Current ROM          Update ROM
BOARD: F9D-C/4L     BOARD: F9D-C/4L
VER: 0201           VER: 0202
DATE: 12/01/2013   DATE: 12/09/2013
PATH:
WARNING! Do not turn off power during flash BIOS
Note
Writing BIOS:
```



DO NOT shut down or reset the system while updating the BIOS to prevent system boot failure!

The utility returns to the DOS prompt after the BIOS update process is completed.

4. Reboot the system from the hard disk drive.

```
The BIOS update is finished! Please restart your system.
c:\>
```

5.2 BIOS setup program

This motherboard supports a programmable firmware chip that you can update using the provided utility described in section 5.1 Managing and updating your BIOS.

Use the BIOS Setup program when you are installing a motherboard, reconfiguring your system, or prompted to “Run Setup.” This section explains how to configure your system using this utility.

Even if you are not prompted to use the Setup program, you can change the configuration of your computer in the future. For example, you can enable the security password feature or change the power management settings. This requires you to reconfigure your system using the BIOS Setup program so that the computer can recognize these changes and record them in the CMOS RAM of the firmware chip.

The firmware chip on the motherboard stores the Setup utility. When you start up the computer, the system provides you with the opportunity to run this program. Press during the Power-On Self-Test (POST) to enter the Setup utility; otherwise, POST continues with its test routines.

If you wish to enter Setup after POST, restart the system by pressing <Ctrl>+<Alt>+<Delete>, or by pressing the reset button on the system chassis. You can also restart by turning the system off and then back on. Do this last option only if the first two failed.

The Setup program is designed to make it as easy to use as possible. Being a menu-driven program, it lets you scroll through the various sub-menus and make your selections from the available options using the navigation keys.



-
- The default BIOS settings for this motherboard apply for most conditions to ensure optimum performance. If the system becomes unstable after changing any BIOS settings, load the default settings to ensure system compatibility and stability. Press <F5> and select Yes to load the BIOS default settings.
 - The BIOS setup screens shown in this section are for reference purposes only, and may not exactly match what you see on your screen.
 - Visit the ASUS website (www.asus.com) to download the latest BIOS file for this motherboard.
-

5.2.1 BIOS menu screen

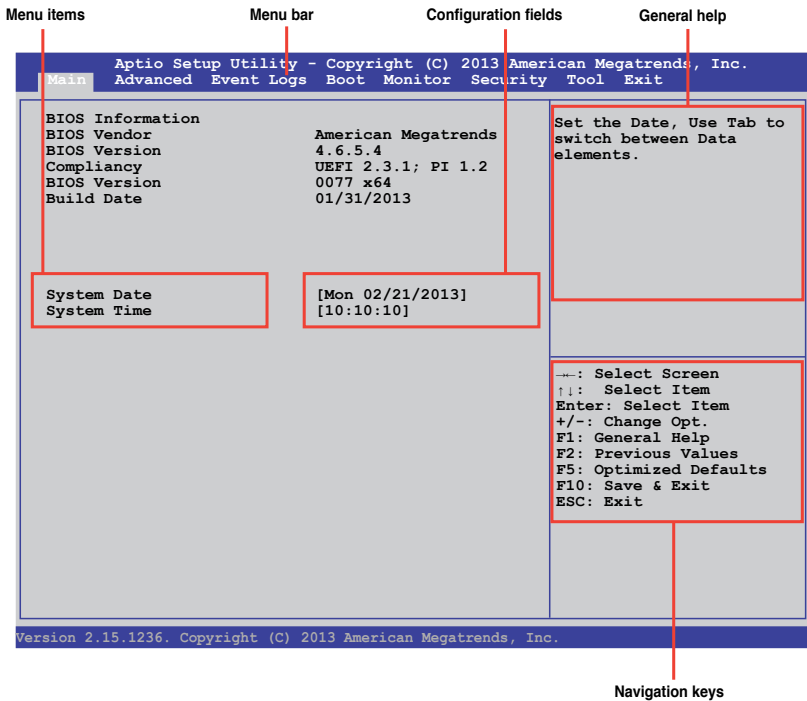

5.2.2 Menu bar

The menu bar on top of the screen has the following main items:

- | | |
|------------|--|
| Main | For changing the basic system configuration |
| Advanced | For changing the advanced system settings |
| Event Logs | For changing the event log settings |
| Boot | For changing the system boot configuration |
| Monitor | For displaying the system temperature, power status, and changing the fan settings |
| Security | For changing the security settings |
| Tool | For configuring options for special functions |
| Exit | For selecting the exit options |

To select an item on the menu bar, press the right or left arrow key on the keyboard until the desired item is highlighted.

5.2.3 Menu items

The highlighted item on the menu bar displays the specific items for that menu. For example, selecting Main shows the Main menu items. The other items (Advanced, Event Logs, Boot, Monitor, Security, Tool, and Exit) on the menu bar have their respective menu items.

5.2.4 Submenu items

A solid triangle before each item on any menu screen means that the item has a submenu. To display the submenu, select the item and press <Enter>.

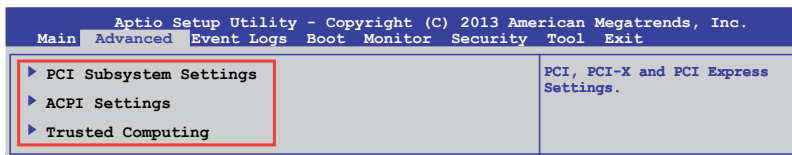

5.2.5 Navigation keys

At the bottom right corner of a menu screen are the navigation keys for the BIOS setup program. Use the navigation keys to select items in the menu and change the settings.

5.2.6 General help

At the top right corner of the menu screen is a brief description of the selected item.

5.2.7 Configuration fields

These fields show the values for the menu items. If an item is user-configurable, you can change the value of the field opposite the item. You cannot select an item that is not user-configurable. A configurable field is enclosed in brackets, and is highlighted when selected. To change the value of a field, select it and press <Enter> to display a list of options.

5.2.8 Pop-up window

Select a menu item and press <Enter> to display a pop-up window with the configuration options for that item.

5.2.9 Scroll bar

A scroll bar appears on the right side of a menu screen when there are items that do not fit on the screen. Press the Up/Down arrow keys or <Page Up> /<Page Down> keys to display the other items on the screen.

5.3 Main menu

When you enter the BIOS Setup program, the Main menu screen appears. The Main menu provides you an overview of the basic system information, and allows you to set the system date and time.

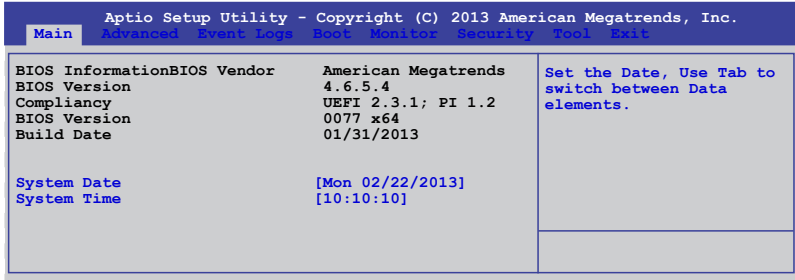

5.3.1 System Date

Allows you to set the system date to [Day mm/dd/yyyy].

Where:

Day = Day of the week

mm = month (numeric value)

dd = day (numeric value)

yyyy = year (numeric value)

5.3.2 System Time

Allows you to set the system time to [hh/mm/ss].

Where:

hh = hour (numeric value)

mm = minutes (numeric value)

ss = seconds (numeric value)

5.4 Advanced menu

The Advanced menu items allow you to change the settings for the CPU and other system devices.



Take caution when changing the settings of the Advanced menu items. Incorrect field values can cause the system to malfunction.

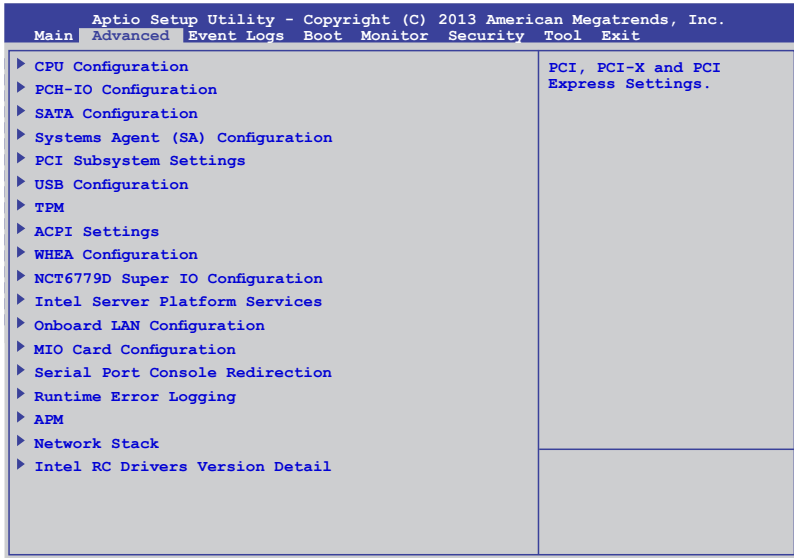

5.4.1 CPU Configuration

The items in this menu show the CPU-related information that the BIOS automatically detects. Some items may not appear if your CPU does not support the related functions.

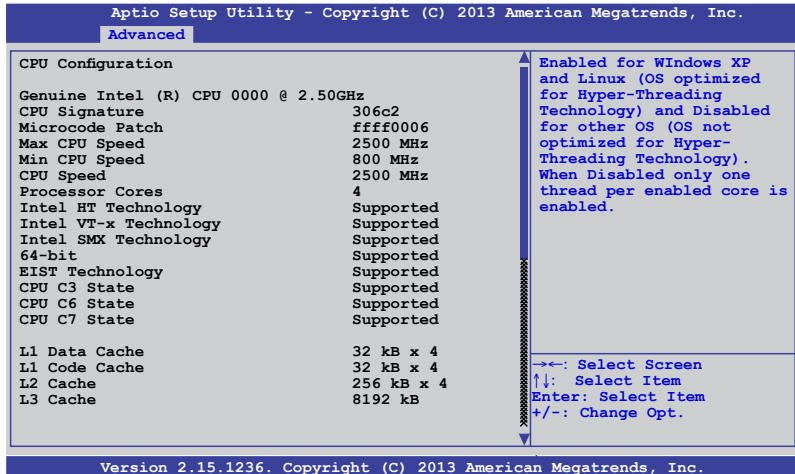

Aptio Setup Utility - Copyright (C) 2013 American Megatrends, Inc.
Advanced

CPU Configuration	
Genuine Intel (R) CPU 0000 @ 2.50GHz	
CPU Signature	306c2
Microcode Patch	ffff0006
Max CPU Speed	2500 MHz
Min CPU Speed	800 MHz
CPU Speed	2500 MHz
Processor Cores	4
Intel HT Technology	Supported
Intel VT-x Technology	Supported
Intel SMX Technology	Supported
64-bit	Supported
EIST Technology	Supported
CPU C3 State	Supported
CPU C6 State	Supported
CPU C7 State	Supported
L1 Data Cache	32 kB x 4
L1 Code Cache	32 kB x 4
L2 Cache	256 kB x 4
L3 Cache	8192 kB

Enabled for Windows XP and Linux (OS optimized for Hyper-Threading Technology) and Disabled for other OS (OS not optimized for Hyper-Threading Technology). When Disabled only one thread per enabled core is enabled.

←: Select Screen
↑↓: Select Item
Enter: Select Item
+/-: Change Opt.

Version 2.15.1236. Copyright (C) 2013 American Megatrends, Inc.

Navigate to the second page of the screen to see the rest of items in this menu by pressing the Up or Down arrow keys.



To quickly go to the last item of the second page, press the **Page Down** button. Press the **Page Up** button to go back to the first item in the first page.

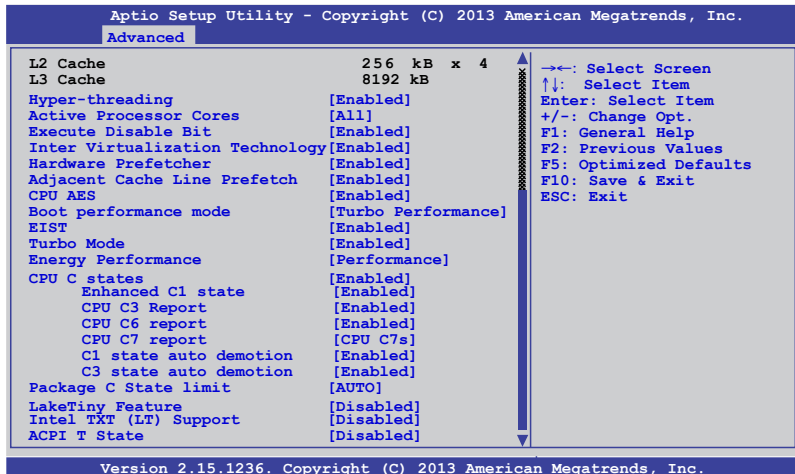

Aptio Setup Utility - Copyright (C) 2013 American Megatrends, Inc.
Advanced

L2 Cache	256 kB x 4
L3 Cache	8192 kB
Hyper-threading	[Enabled]
Active Processor Cores	[All]
Execute Disable Bit	[Enabled]
Inter Virtualization Technology	[Enabled]
Hardware Prefetcher	[Enabled]
Adjacent Cache Line Prefetch	[Enabled]
CPU AES	[Enabled]
Boot performance mode	[Turbo Performance]
EIST	[Enabled]
Turbo Mode	[Enabled]
Energy Performance	[Performance]
CPU C states	[Enabled]
Enhanced C1 state	[Enabled]
CPU C3 Report	[Enabled]
CPU C6 report	[Enabled]
CPU C7 report	[CPU C7s]
C1 state auto demotion	[Enabled]
C3 state auto demotion	[Enabled]
Package C State limit	[AUTO]
LakeTiny Feature	[Disabled]
Intel TXT (LT) Support	[Disabled]
ACPI T State	[Disabled]

←: Select Screen
↑↓: Select Item
Enter: Select Item
+/-: Change Opt.
F1: General Help
F2: Previous Values
F5: Optimized Defaults
F10: Save & Exit
ESC: Exit

Version 2.15.1236. Copyright (C) 2013 American Megatrends, Inc.

Hyper-threading [Enabled]

Allows you to enable or disable the Intel Hyper-Threading Technology function.
Configuration options: [Enabled] [Disabled]

Active Processor Cores [All]

Allows you to choose the number of CPU cores to activate in each processor package.
Configuration options: [All] [1] [2] [3]

Execute Disable Bit [Enabled]

Allows you to enable or disable the XD feature that can prevent certain classes of malicious buffer overflow attacks when combined with a supporting OS. Configuration options:
[Enabled][Disabled]

Intel Virtualization Technology [Enabled]

Allows you to utilize the additional hardware capabilities provided by Vanderpool Technology.
Configuration options: [Enabled] [Disabled]

Hardware Prefetcher [Enabled]

Allows you to enable or disable the Mid Level Cache (L2) streamer. Configuration options:
[Enabled] [Disabled]

Adjacent Cache Line Prefetch [Enabled]

Allows you to enable or disable the Mid Level Cache (L2) prefetching of adjacent cache lines.
Configuration options: [Enabled] [Disabled]

CPU AES [Enabled]

Allows you to enable or disable the CPU Advance Encryption Standard instructions.
Configuration options: [Disabled] [Enabled]

Boot performance mode [Turbo Performance]

This item allows you to select the performance state that the BIOS will set before OS handoff.
Configuration options: [Max Non-Turbo Performance] [Max Battery] [Turbo Performance]

EIST [Enabled]

Allows you to enable or disable the Enhanced Intel SpeedStep Technology (EIST).
Configuration options: [Enabled] [Disabled]

Turbo Mode [Enabled]

This item appears only when you set the EIST item to [Enabled]. This allows you to enable or disable the Intel® Turbo Mode Technology.
Configuration options: [Enabled] [Disabled]

Energy Performance [Performance]

Allows you to optimize between performance and power savings. Configuration options:
[Performance] [Balanced Performance] [Balanced Energy] [Energy Efficient]

CPU C states [Enabled]

Allows you to enable or disable the CPU C states. Configuration options: [Enabled] [Disabled]



This following items appears only when you set the CPU C states to [Enabled].

Enhanced C1 State [Enabled]

This item allows you to enable or disable the Enhanced C1 state. Configuration options: [Enabled] [Disabled]

CPU C3 Report [Enabled]

Allows you to enable or disable the CPU C3 report to OS. Configuration options: [Enabled] [Disabled]

CPU C6 Report [Enabled]

Allows you to enable or disable the CPU C6 report to OS. Configuration options: [Disabled] [Enabled]

CPU C7 Report [CPU C7s]

Allows you to enable or disable the CPU C7 report to OS. Configuration options: [Disabled] [CPU C7] [CPU C7s]

C1 state auto demotion [Enabled]

Allows you to enable or disable the demotion of the C3/C6/C7 request to C1 based on uncore auto-demote information. Configuration options: [Disabled] [Enabled]

C3 state auto demotion [Enabled]

Allows you to enable or disable the demotion of the C6/C7 request to C3 based on uncore auto-demote information. Configuration options: [Disabled] [Enabled]

Package C State limit [AUTO]

Allows you set the Package C State limit to AUTO. Configuration options: [C0/C1] [C2] [C3] [C6] [C7] [C7s] [AUTO]

LakeTiny Feature [Disabled]

Allows you enable or disable LakeTiny for C state configuration. Configuration options: [Disabled] [Enabled]

Intel TXT (LT) Support [Disabled]

Allows you to enable or disable the Intel TXT (LT) support. Configuration options: [Disabled] [Enabled]

ACPI T State [Disabled]

Allows you to enable or disable the ACPI T state. Configuration options: [Disabled] [Enabled]

5.4.2 PCH-IO Configuration

Allows you to configure PCH parameters.

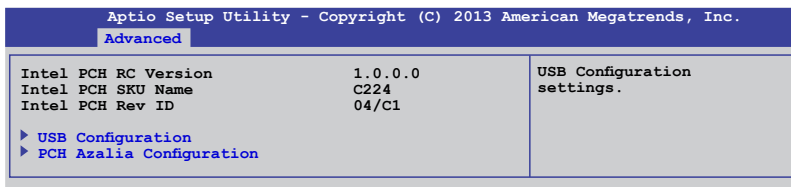

USB Configuration

Allows you to set the USB Configuration settings.

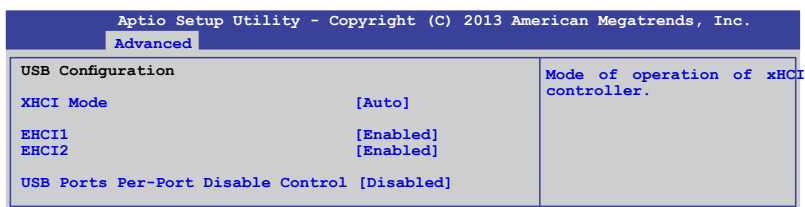

XHCI Mode [Auto]

Allows you to set the mode of operation of the xHCI controller. Configuration options: [Auto] [Enabled] [Disabled]

EHCI1 / EHCI2 [Enabled]

Allows you to control the USB EHCI (USB 2.0) functions. One EHCI controller must always be enabled. Configuration options: [Disabled] [Enabled]

USB Ports Per-Port Disable Control [Disabled]

Allows you to control the disabling of the USB ports (0-13). Configuration options: [Disabled] [Enabled]

USB Port #0-#13 Disable [Enabled]

This items only appears when you set the USB Ports Per-Port Disable Control to [Enabled] This item allows you to control the disabling of each of the USB ports (0-13). Configuration options: [Disabled] [Enabled]

PCH Azalia Configuration

Allows you to control the detection of the Azalia device. Configuration options:

[Auto] [Disabled]

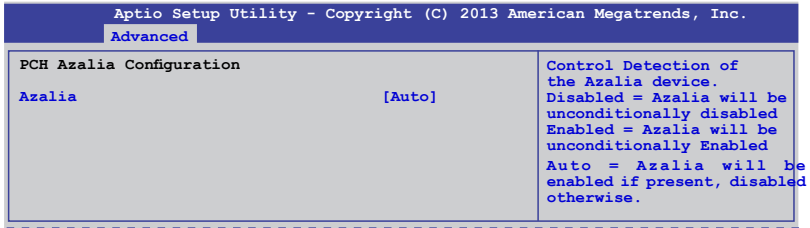

5.4.3 SATA Configuration

While entering Setup, the BIOS automatically detects the presence of SATA devices. The SATA Port items show Not Present if no SATA device is installed to the corresponding SATA port.

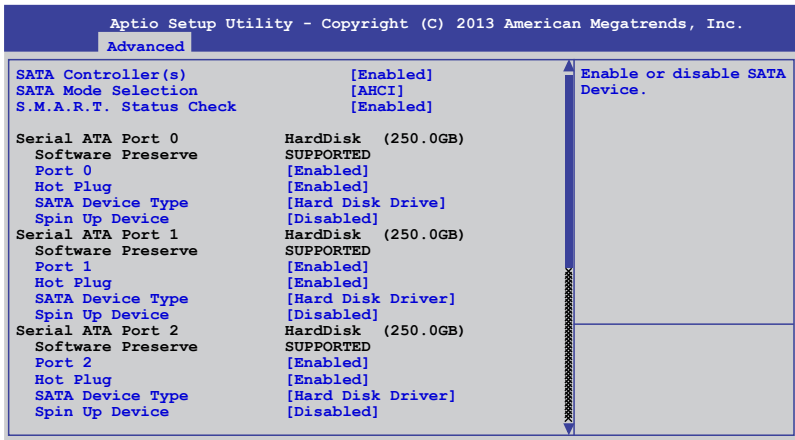

SATA Controller(s) [Enabled]

This allows you to enable or disable the SATA Device. Configuration options: [Enabled] [Disabled]

SATA Mode Selection [AHCI]

This allows you to choose how SATA controller(s) should operate. Configuration options: [AHCI] [IDE] [RAID]

S.M.A.R.T. Status Check [Enabled]

Self-Monitoring, Analysis, and Reporting Technology (S.M.A.R.T.) is a monitor system. When read/write of your hard disk errors occur, this feature allows the hard disk to report warning messages during the POST. Configuration options: [Enabled] [Disabled]

Compatible Mode [Disabled]

This item only appears when you set the SATA Mode Selection to [IDE]. This item allows you to enable or disable the Compatible mode. Configuration options: [Disabled] [Enabled]

Aptio Setup Utility - Copyright (C) 2013 American Megatrends, Inc.		
Advanced		
SATA Controller(s)	[Enabled]	Determines how SATA controller(s) operate.
SATA Mode Selection	[IDE]	
Compatible Mode	[Disabled]	
S.M.A.R.T. Status Check	[Enabled]	
Serial SATA Port 0	HardDisk (250.0GB)	
Software Preserve	SUPPORTED	
Serial SATA Port 1	HardDisk (250.0GB)	
Software Preserve	SUPPORTED	
Serial SATA Port 2	HardDisk (250.0GB)	
Software Preserve	SUPPORTED	
Serial SATA Port 3	HardDisk (250.0GB)	
Software Preserve	SUPPORTED	
Serial SATA Port 4	HardDisk (250.0GB)	
Software Preserve	SUPPORTED	
Serial SATA Port 5	ASUS DVD-E8 ATAPI	
Software Preserve	SUPPORTED	

5.4.4 System Agent (SA) Configuration

This allows you to change System Agent parameters.

Aptio Setup Utility - Copyright (C) 2013 American Megatrends, Inc.		
Advanced		
System Agent Bridge Name	Haswell	Check to enable VT-d function on MCH.
System Agent RC Version	1.0.0.0	
VT-d Capability	Supported	
VT-d	[Enabled]	
Enable NB Card	[Disabled]	
BDAT ACPI Table Support	[Disabled]	
VGA Priority	[Offboard]	
▶ Memory Configuration		

VT-d [Enabled]

This allows you enable or disable the VT-d function on MCH. Configuration options: [Enabled] [Disabled]

Enable NB CRID [Disabled]

This allows you enable or disable the NB CRID WorkAround. Configuration options: [Enabled] [Disabled]

BDAT ACPI Table Support [Disabled]

This allows you enable or disable the support for the BDAT ACPI table. Configuration options: [Enabled] [Disabled]

VGA Priority [Offboard]

This allows you to prioritize between the onboard and offboard video device to be found. Configuration options: [Onboard] [Offboard]

Memory Configuration

This allows you to change memory information settings.

Aptio Setup Utility - Copyright (C) 2013 American Megatrends, Inc.	
Advanced	
Memory Information	Maximum Memory Frequency Selections in MHz.
Memory RC Version	1.0.0.0
Memory Frequency	1067 MHz
Usage Memory	1024 MB (DDR3)
DIMM_A1	Not Present
DIMM_A2	1024 MB (DDR3)
DIMM_A3	Not Present
DIMM_A4	Not Present
CAS Latency (tCL)	7
Minimum delay time	
CAS to RAS (tRCDmin)	7
Row Precharge (tRPmin)	7
Active to Precharge (tRASmin)	20
Memory Frequency Limiter	[Auto]
ECC Support	[Enabled]
Memory Scrambler	[Enabled]
Memory Remap	[Enabled]
GDXC Support	[Disabled]

Memory Frequency Limiter [Auto]

This allows you to set the memory frequency in MHz. Configuration options: [Auto] [1333] [1600]

ECC Support [Enabled]

This allows you to enable or disable the DDR ECC support. Configuration options: [Enabled] [Disabled]

Memory Scrambler [Enabled]

This allows you to enable or disable the Memory Scrambler support. Configuration options: [Enabled] [Disabled]

Memory Remap [Enabled]

This allows you to enable or disable the Memory Remap above 4G. Configuration options: [Enabled] [Disabled]

GDXC Support [Disabled]

This allows you to enable or disable the GDXC feature. Configuration options: [Enabled] [Disabled]

5.4.5 PCI Subsystem Settings

Allows you to configure PCI, PCI-X, and PCI Express Settings.

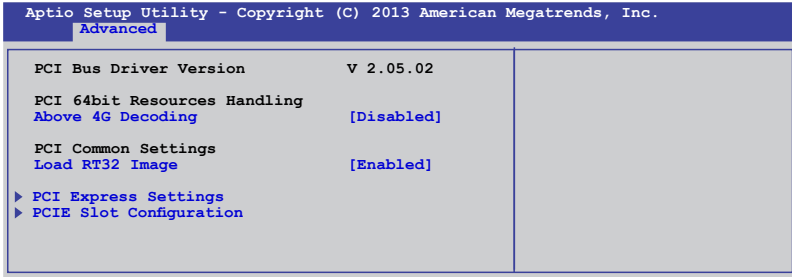

Above 4G Decoding [Disabled]

This item allows you to enable or disable 64-bit capable devices to be decoded in above 4G Address Space if your system supports 64-bit PCI decoding. Configuration Options: [Disabled][Enabled]

Load RT32 Image [Enabled]

Allows you to enable or disable the RT32 Image Loading. Configuration Options: [Disabled][Enabled]

PCI Express Settings

Allows you to change the settings of the PCI Express Devices.

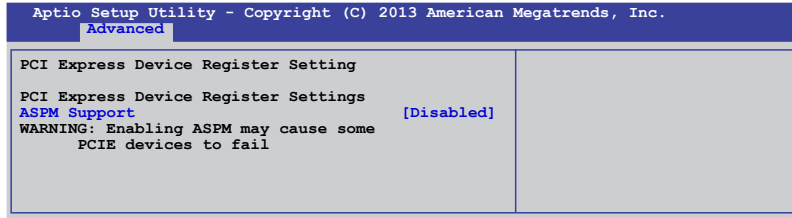

ASPM Support [Disabled]

This item allows you to enable or disable support to Active State Power Management (ASPM). ASPM is a power management protocol that is used to extend battery life. Configuration options:

- [Disabled] Disables ASPM
- [Auto] BIOS auto configure
- [Force L0s] Force all links to L0s State

PCIe Slot Configuration

Allows you to perform PCIe slot configurations.

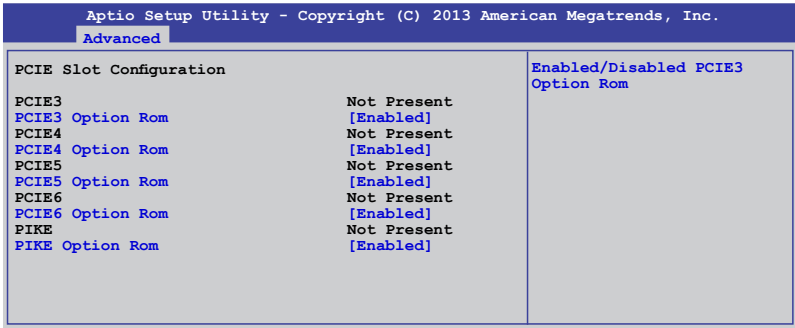

PCIe Option Rom 3 - 6 [Enabled]

Allows you to enable or disable the PCIe slots. Configuration Options: [Disabled][Enabled]

PIKE Option Rom [Enabled]

Allows you to enable or disable the PIKE Option Rom. Configuration Options: [Disabled][Enabled]

5.4.6 USB Configuration

This allows you to make changes on the configuration settings of the USB.

Aptio Setup Utility - Copyright (C) 2013 American Megatrends, Inc.	
Advanced	
USB Configuration	Enables Legacy USB support. AUTO option disables legacy support if no USB devices are connected. DISABLE option will keep USB devices available only for EFI applications.
USB Devices 1 mouse, 2 Hubs	
Legacy USB Support	[Enabled]
USB3.0 Support	[Enabled]
XHCI Hand-off	[Enabled]
EHCI Hand-off	[Disabled]
USB Mass Storage Driver Support	[Enabled]
Port 60/64 Emulation	[Enabled]
USB hardware delays and time-outs:	
USB transfer time-out	[20 sec]
Device reset time-out	[20 sec]
Device power-up delay	[Auto]



The USB Devices item shows the auto-detected values. If no USB device is detected, the item shows None.

Legacy USB Support [Enabled]

Allows you to enable or disable the support for legacy USB devices. Setting to [Auto] allows the system to detect the presence of USB devices at startup. If detected, the USB controller legacy mode is enabled. If no USB device is detected, the legacy USB support is disabled. Configuration options: [Disabled] [Enabled] [Auto]

USB3.0 Support [Enabled]

Enables or disables the USB3.0 (XHCI) controller support. Configuration options: [Disabled] [Enabled]

XHCI Hand-off [Enabled]

This functions as a workaround for OSes without XHCI hand-off support. Configuration options: [Disabled] [Enabled]

EHCI Hand-off [Enabled]

This functions as a workaround for OSes without EHCI hand-off support. Configuration options: [Disabled] [Enabled]

USB Mass Storage Driver Support [Enabled]

This allows you to enable or disable the USB Mass Storage driver support. Configuration options: [Disabled] [Enabled]

Port 60/64 Emulation [Enabled]

This allows you to enable the I/O port 60h/64h emulation support. This should be enabled for the complete USB keyboard legacy support for non-USB aware OSes. Configuration options: [Disabled] [Enabled]

USB transfer time-out [20 sec]

Allows you to select the USB transfer time-out value. Configuration options:
[1 sec] [5 sec] [10 sec] [20 sec]

Device reset time-out [20 sec]

Allows you to select the USB device reset time-out value. Configuration options:
[10 sec] [20 sec] [30 sec] [40 sec]

Device power-up delay [Auto]

This allows you to set the maximum time the device will take before it properly reports itself to the Host Controller. Configuration options: [Auto] [Manual]

5.4.7 TPM

Aptio Setup Utility - Copyright (C) 2013 American Megatrends, Inc.		
Advanced		
Configuration		
TPM Support	[Disable]	Enables or Disables BIOS support for security device.O.S. will not show Security Device. TCG EFI protocol and INT1A interface will not be available.
Current Status Information		
NO Security Device Found		

Security Device Support [Disabled]

Allows you to enable or disable BIOS support for security devices. Configuration options: [Disabled] [Enabled]

5.4.8 ACPI Settings

Aptio Setup Utility - Copyright (C) 2013 American Megatrends, Inc.		
Advanced		
ACPI Settings		
Enable Hibernation	[Enabled]	Enables or Disables System ability to Hibernate (OS/S4 Sleep State). This option may not be effective with some OS.
ACPI Sleep State	[Both S1 and S3 available...]	

Enable Hibernation [Enabled]

Allows you to enable or disable the Hibernation feature (OS/S4 sleep state). Configuration options: [Disabled] [Enabled]

ACPI Sleep State [Both S1 and S3 available for OS to choose from]

Allows you to set the ACPI Sleep state. Configuration options: [Suspend Disabled] [S1 only (CPU Stop Clock)] [S3 only (Suspend to RAM)] [Both S1 and S3 available for OS to choose from]

5.4.9 WHEA Support

Aptio Setup Utility - Copyright (C) 2013 American Megatrends, Inc.		
Advanced		
WHEA Support	[Enabled]	Enables or disable Windows Hardware Error Architecture.

WHEA [Enabled]

Allows you to enable or disable the Windows® Hardware Error Architecture (WHEA) support. Configuration options: [Disabled] [Enabled]

5.4.10 NCT6779D Super IO Configuration

Aptio Setup Utility - Copyright (C) 2013 American Megatrends, Inc.	
Advanced	
NCT6779D Super IO Configuration	Set Parameters of Serial Port 1 (COM1)
▶ Serial Port 1 Configuration	
▶ Serial Port 2 Configuration	
▶ Parallel Port Configuration	

Serial Port 1/2 Configuration

The sub-items in this menu allows you to set the parameters of the Serial Port 1 (COM1) and the Serial Port 2 (COM2).

Serial Port [Enabled]

Allows you to enable or disable the serial port (COM 1/2). Configuration options: [Enabled] [Disabled]

Change Settings [Auto]

This item only appears when you set the Serial Port to [Enabled]. This item allows you to select the serial port base address. Configuration options:

[Auto]

[IO=3F8h; IRQ=4]

[IO=3F8h; IRQ=3, 4, 5, 6, 7, 10, 11, 12]

[IO=2F8h; IRQ=3, 4, 5, 6, 7, 10, 11, 12]

[IO=3E8h; IRQ=3, 4, 5, 6, 7, 10, 11, 12]

[IO=2E8h; IRQ=3, 4, 5, 6, 7, 10, 11, 12]

[IO=2E8h; IRQ=3, 4, 5, 6, 7, 10, 11, 12]

Parallel Port Configuration

The sub-items in this menu allow you to set the parallel port configuration.

Parallel Port [Enabled]

Allows you to enable or disable the parallel port (LPT/LPTE). Configuration options: [Enabled] [Disabled]

Change Settings [Auto]

Allows you to select the optimal setting for the super IO device.

Configuration options: [Auto] [IO=378h; IRQ=5] [IO=378h; IRQ=5, 6, 7, 10, 11, 12] [IO=278h; IRQ=5, 6, 7, 10, 11, 12] [IO=3BCh; IRQ=5, 6, 7, 10, 11, 12]

Device Mode [STD Printer Mode]

Allows you to select the printer port mode. Configuration options: [STD Printer mode] [SPP Mode] [EPP-1.9 and SPP Mode] [EPP-1.7 and SPP Mode] [ECP Mode] [ECP and EPP 1.9 Mode] [ECP and EPP 1.7 Mode]

5.4.11 Intel Server Platform Services

This item displays the information of the Intel Server Platform Services configured in the system.

Aptio Setup Utility - Copyright (C) 2013 American Megatrends, Inc.	
Advanced	
Intel Server Platform Services Configuration	
ME BIOS Interface Ver :	1.0
SPS Version	3.0.4.162
ME FW Status Value :	0xf0345
ME FW State :	SPS ME FW Active
ME FW Operation State :	M0 without UMA
ME FW Error Code :	No Error
ME NM FW Status Value :	0x8000001
BIOS Booting Mode :	Power Optimized Mode
Cores Disabled :	0
ME FW SKU Information :	Node Manager
End-of-POST Status :	EOP disabled in POST

5.4.12 Onboard LAN Configuration

This allows you to change the enable or disable the onboard LAN.

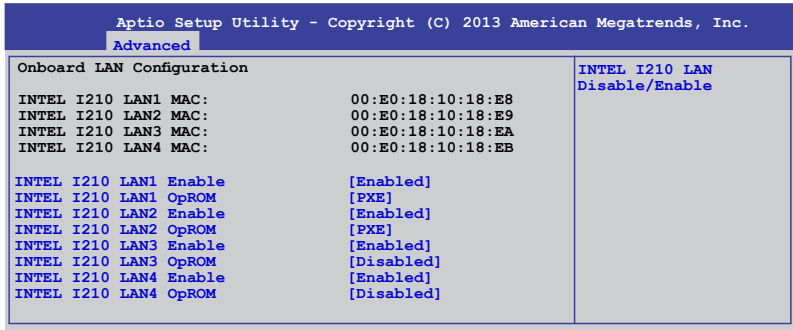

INTEL I210 LAN1 - LAN4 Enable [Enabled]

Allows you to enable or disable the INTEL I210 LAN function in the system. Configuration Options: [Enabled] [Disabled]

INTEL I210 LAN1/LAN2 OpROM [PXE], INTEL I210 LAN3/LAN4 OpROM [Disabled]

Allows you to launch the Intel I210 LAN OpROM. Configuration options: [Disabled] [PXE] [iSCSI]

5.4.13 MIO Card Configuration

This item allows you to set MIO Card configuration settings.

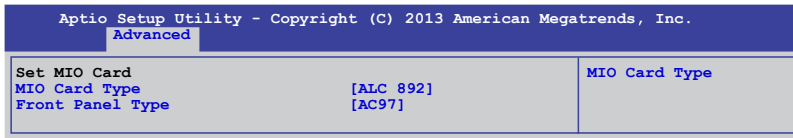

Front Panel Type [AC97]

Allows you to select the front Panel type of the MIO. Configuration options: [AC97] [HD]

5.4.14 Serial Port Console Redirection

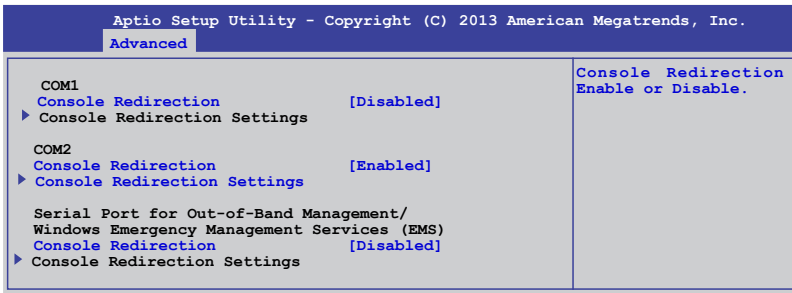

COM1/COM2 Console Redirection [Disabled/Enabled]

Allows you to enable or disable the console redirection feature. Configuration options: [Disabled] [Enabled]



The **Console Redirection Settings** becomes configurable when **Console Redirection** is set to [Enabled].

COM1/COM2 Console Redirection Settings

The settings specify how the host computer and the remote computer (which the user is using) will exchange data. Both computers should have the same or compatible settings.

Terminal Type [VT-UTF8]

Allows you to set the terminal type.

[VT100]	ASCII char set.
[VT100+]	Extends VT100 to support color, function keys, among others
[VT-UTF8]	Uses UTF8 encoding to map Unicode chars onto 1 or more bytes
[ANSI]	Extended ASCII char set

Bits per second [57600]

Selects serial port transmission speed. The speed must be matched on the other side. Long or noisy lines may require lower speeds. Configuration options: [9600] [19200] [38400] [57600] [115200]

Data Bits [8]

Allows you to set the data bits. Configuration options: [7] [8]

Parity [None]

Allows you to select the parity bit. A parity bit is sent with the data bits to detect transmission errors. Configuration options: [None] [Even] [Odd] [Mark] [Space]

Stop Bits [1]

Stop bits indicate the end of a serial data packet. (A start bit indicates the beginning.) The standard setting is 1 stop bit. Communication with slow devices may require more than 1 stop bit. Configuration options: [1] [2]

Flow Control [Hardware RTS/CTS]

Flow control can prevent data loss from buffer overflow. When sending data, if the receiving buffers are full, a “stop” signal can be sent to stop the data flow. Once the buffers are empty, a “start” signal can be sent to re-start the flow. Hardware flow control uses two wires to send start/stop signals. Configuration options: [None] [Hardware RTS/CTS]

VT -UTF8 Combo Key Support [Enabled]

This allows you to enable the VT -UTF8 Combination Key Support for ANSI/VT100 terminals. Configuration options: [Disabled] [Enabled]

Recorder Mode [Disabled]

This allows you to enable or disable the Recorded mode to capture Terminal data. Configuration options: [Disabled] [Enabled]

Resolution 100x31 [Enabled]

This allows you to enable or disable the extended terminal resolution. Configuration options: [Disabled] [Enabled]

Legacy OS Redirection Resolution [80x24]

This allows you to set the number of rows and columns supported on the Legacy OS. Configuration options: [80x24] [80x25]

Putty Keypad [VT100]

This allows you to select the FunctionKey and Keypad on Putty. Configuration options: [VT100] [LINUX] [XTERMR6] [SCO] [ESCN] [VT400]

Redirection After BIOS POST [Bootloader]

This setting allows you to specify if Bootloader is selected than Legacy console redirection. Configuration options: [Always Enable] [Bootloader]

5.4.15 Runtime Error Logging Support

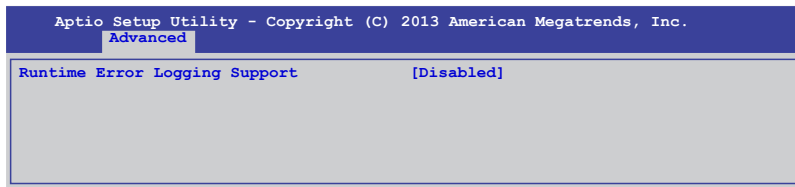

Runtime Error Logging Support [Disabled]

Allows you to enable or disable the Runtime Error Logging Support. Configuration options: [Disabled] [Enabled]

5.4.16 APM

Allows you to configure the Advance Power Management (APM) settings.

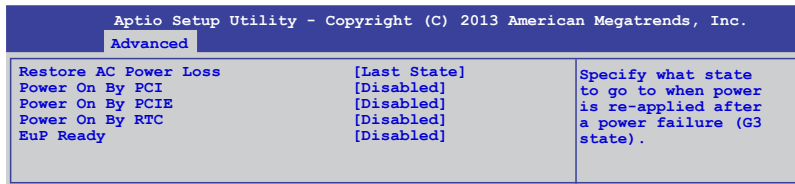

Restore AC Power Loss [Last State]

Allows you to set the state the system will go to after an AC power loss. Configuration options: [Power Off] [Power On] [Last State]

Power On By PCI [Disabled]

You can use this option to enable or disable the Wake-on-LAN feature of the Intel® LAN. Configuration options: [Disabled] [Enabled]

Power On By PCIE [Disabled]

This allows you to enable or disable the PCIE devices to generate a wake event. Configuration options: [Disabled] [Enabled]

Power On By RTC [Disabled]

This item allows you to enable or disable RTC to generate a wake event. When set to [Enabled], the items RTC Alarm Date (Days) and Hour/Minute/Second becomes user-configurable where you can set values.

EuP Ready [Disabled]

This item allows you to switch off some power at S5 to get the system ready for EuP requirement. Configuration options: [Enabled] [Disabled]

5.4.17 Network Stack

Aptio Setup Utility - Copyright (C) 2013 American Megatrends, Inc.		
Advanced		
Network stack	[Disable]	Enable/Disable the network stack (Pxe and UEFI)

Network stack [Disable]

Enables or disables the network stack feature. Configuration options: [Disable] [Enable]

5.4.18 Intel RC Drivers Version Detail

This item displays the Version String for the Intel RC Drivers.

Aptio Setup Utility - Copyright (C) 2013 American Megatrends, Inc.		
Advanced		
Intel CPU RC Version	1.0.0.0	
Memory RC Version	1.0.0.0	
Intel SA RC Version	1.0.0.0	
Intel PCH RC Version	1.0.0.0	

5.5 Event Logs menu

The Event Logs menu items allow you to change the event log settings and view the system event logs.

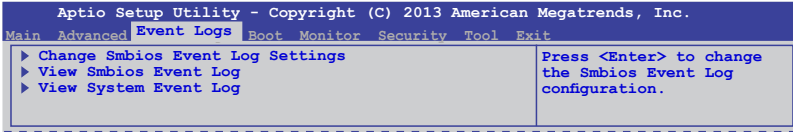

Change Smbios Event Log Settings

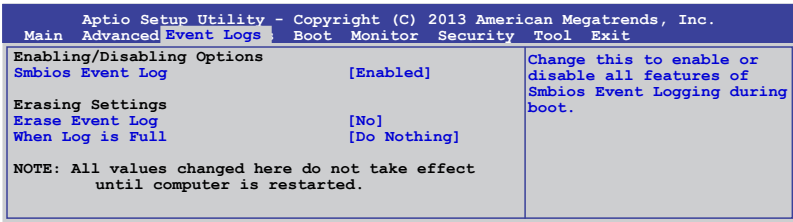

Smbios Event Log [Enabled]

Allows you to enable or disable all features of Smbios event logging during boot. Configuration options: [Disabled] [Enabled]

Erase Event Log [No]

This item only appears when Smbios Event Log is set to [Enabled]. This item allows you to select the options for erasing Smbios event log. Configuration options: [No] [Yes, Next reset] [Yes, Every reset]

When Log is Full [Do Nothing]

This item only appears when Smbios Event Log is set to [Enabled]. This item allows you to select the options for reaction when the event logs are full. Configuration options: [Do Nothing] [Erase Immediately]

5.6 Boot menu

The items in Boot menu allows you to change the options on how the system will boot.

Aptio Setup Utility - Copyright (C) 2013 American Megatrends, Inc.		
Main Advanced Event Logs Boot Monitor Security Tool Exit		
Boot Configuration		
Setup Prompt Timeout	1	Number of seconds to wait for setup activation key. 65535(0xFFFF) means indefinite waiting.
Bootup NumLock State	[On]	
Full Screen Logo	[Enabled]	
CSM16 Module Version	07.69	
GateA20 Active	[Upon Request]	
Option ROM Messages	[Force BIOS]	
INT19 Trap Response	[Immediate]	
Boot Device Seeking	[Endless PXE]	
Boot Option Priorities		
Boot Option #1	[P0: DVD]	
Boot Option #2	[P4: Harddisk 2.50G]	
Boot Option #3	[Windows Boot Man..]	
Network Device BBS Priorities		
Hard Drive BBS Priorities		
▶ CSM parameters		

Setup Prompt Timeout [xx]

This item allows you to adjust the number of seconds to wait for setup activation key. Use the <+> and <-> keys to specify the values.

Bootup NumLock State [On]

Allows you to select the power-on state for the NumLock. Configuration options: [Off] [On]

Full Screen Logo [Enabled]

Allows you to enable or disable the full screen logo display feature. Configuration options: [Disabled] [Enabled].



Set the Full Screen Logo to [Enabled] to use the ASUS MyLogo2™ feature.

GateA20 Active [Upon Request]

This item is useful when any RT code is execute above 1MB. When set to [Upon Request], the GA20 can be disabled using BIOS services. When set to [Always], disabling of GA20 is not allowed. Configuration options: [Upon Request] [Always].

Option ROM Messages [Force BIOS]

Allows you to set the display mode for Option ROM. Configuration options: [Force BIOS] [Keep Current]

INT19 Trap Response [Immediate]

This item allows you to set the BIOS reaction on INT19 trapping by Option ROM.
Configuration options: [Immediate] [Postponed]

Boot Device Seeking [Endless PXE]

This allows you to enable the Boot Device Seeking option. Configuration options:
[Endless PXE] Continuously seek remote boot image until boot image is found or the operation is aborted <Ctrl>+<Alt>+ is pressed by the user).

[Normal] Seek remote boot image once then stop.

Boot Option Priorities

These items specify the boot device priority sequence from the available devices. The number of device items that appears on the screen depends on the number of devices installed in the system.



-
- To select the boot device during system startup, press <F8> when ASUS Logo appears.
 - To access Windows® OS in Safe Mode, do any of the following:
 - Press <F5> when ASUS Logo appears.
 - Press <F8> after POST.
-

Network Device BBS Priorities / Hard Drive BBS Priorities

This allows you to set the order of the legacy devices in this group.

CSM Parameters

This allows you to set OpROM execution, boot options filter, and other OpROM settings.

Aptio Setup Utility - Copyright (C) 2013 American Megatrends, Inc.		
Main Advanced Event Logs Boot Monitor Security Tool Exit		
Launch CSM	[Enabled]	This option controls if CSM will be launched.
Boot Option filter	[Legacy only]	
Launch PXE OpROM policy	[Legacy only]	
Launch Storage OpRom policy	[Legacy only]	
Launch Video OpRom policy	[Legacy only]	
Other PCI device ROM priority	[Legacy OpROM]	

Launch CSM [Enabled]

This option allows you to enable or disable the launch of CSM. Configuration options: [Disabled] [Enabled]

Boot Option filter [Legacy only]

This option allows you to control what devices the system can boot to. Configuration options: [UEFI and Legacy] [Legacy only] [UEFI only]

Launch PXE OpROM policy [Legacy only]

This option allows you to control the execution of UEFI and Legacy PXE OpROM. Configuration options: [Do not launch] [UEFI only] [Legacy only] [Legacy first] [UEFI first]

Launch Storage OpROM policy [Legacy only]

This option allows you to control the execution of UEFI and Legacy Storage OpROM. Configuration options: [Do not launch] [UEFI only] [Legacy only] [Legacy first] [UEFI first]

Launch Video OpROM policy [Legacy only]

This option allows you to control the execution of UEFI and Legacy Storage OpROM. Configuration options: [Do not launch] [UEFI only] [Legacy only] [Legacy first] [UEFI first]

Other PCI device ROM priority [Legacy OpROM]

This option allows you to control the execution of UEFI and Legacy Storage OpROM. Configuration options: [UEFI OpROM] [Legacy OpROM]

5.7 Monitor menu

The Monitor menu displays the system temperature/power status, and allows you to change the fan settings.

Aptio Setup Utility - Copyright (C) 2013 American Megatrends, Inc.							
Main	Advanced	Event Logs	Boot	Monitor	Security	Tool	Exit
CPU Temperature	:	+58°C/ +162°F				Whisper/Generic/High/	
MB Temperature	:	+52°C/ +151°F				Speed/Full Speed	
TR1 Temperature	:	N/A					
CPU_FAN1 Speed	:	1054 RPM					
REAR_FAN1 Speed	:	N/A					
FRNT_FAN1 Speed	:	N/A					
FRNT_FAN2 Speed	:	N/A					
FRNT_FAN3 Speed	:	N/A					
VCORE1	:	+1.800 V					
+12V	:	+12.288 V					
+5V	:	+5.040 V					
+VDDQ	:	+1.504 V					
+3VSB	:	+3.408 V					
+3.3V	:	+1.296 V					
VBAT	:	+3.344 V					
FAN Speed Control		[Generic Mode]					

CPU/MB/TR1 Temperature [xxx°C/xxx°F]

The onboard hardware monitor automatically detects and displays the CPU and motherboard component temperatures.

CPU_FAN1 Speed; FRNT_FAN1–3 Speed; REAR_FAN1 Speed [xxxx RPM] or [Ignore] / [N/A]

The onboard hardware monitor automatically detects and displays the speed of CPU fans, front fans, and rear fan in rotations per minute (RPM). If the fan is not connected to the motherboard, the field shows N/A.

VCORE1 Voltage: +12V, +5V, +VDDQ, +3VSB, +3.3V, and VBAT

The onboard hardware monitor automatically detects the voltage output through the onboard voltage regulators.

Fan Speed Control [Generic Mode]

Allows you to configure the ASUS Smart Fan feature that smartly adjusts the fan speeds for more efficient system operation. Configuration options:

[Low Speed Mode] [Generic Mode] [High Speed Mode] [Full Speed Mode]

5.8 Security

This menu allows a new password to be created or a current password to be changed. The menu also enables or disables the Secure Boot state and lets the user configure the System Mode state.

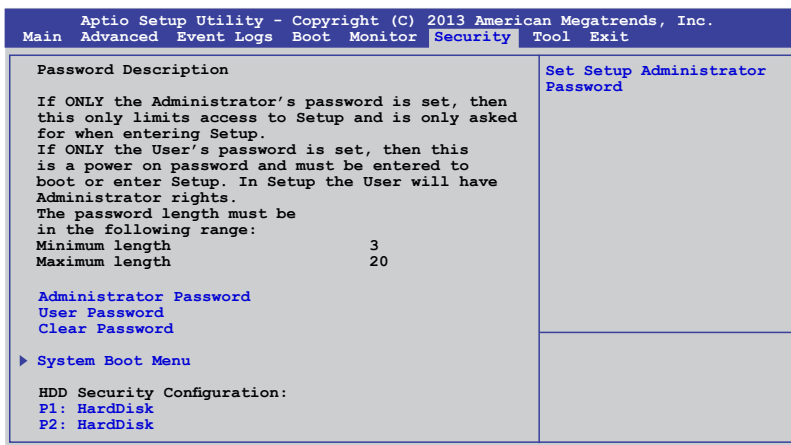

Administrator Password

To set an administrator password:

1. Select the Administrator Password item and press <Enter>.
2. From the Create New Password box, key in a password, then press <Enter>.
3. Confirm the password when prompted.

To change an administrator password:

1. Select the Administrator Password item and press <Enter>.
2. From the Enter Current Password box, key in the current password, then press <Enter>.
3. From the Create New Password box, key in a new password, then press <Enter>.
4. Confirm the password when prompted.



To clear the administrator password, follow the same steps as in changing an administrator password, but press <Enter> when prompted to create/confirm the password.

User Password

To set a user password:

1. Select the User Password item and press <Enter>.
2. From the Create New Password box, key in a password, then press <Enter>.
3. Confirm the password when prompted.

To change a user password:

1. Select the User Password item and press <Enter>.
2. From the Enter Current Password box, key in the current password, then press <Enter>.
3. From the Create New Password box, key in a new password, then press <Enter>.
4. Confirm the password when prompted.

To clear a user password:

1. Select the Clear User Password item and press <Enter>.
2. Select Yes from the Warning message window then press <Enter>.

Secure Boot Menu

This item allows you to customize the Secure Boot settings.

Aptio Setup Utility - Copyright (C) 2013 American Megatrends, Inc.		
Security		
Platform Mode	Setup	Secure Boot flow control.
Secure Boot	Disabled	Secure Boot can be enabled only when Platform Key (PK) is enrolled and Platform is operating in User mode.
Secure Boot Control	[Enabled]	
Secure Boot Mode	[Standard]	
▶ Image Execution Policy		
▶ Key Management		

Secure Boot Control [Enabled]

This item allows you to enable or disable the Secure Boot flow control. Configuration options: [Disabled] [Enabled]

Secure Boot Mode [Standard]

This item allows you to select the mode of the Secure boot to change Execution policy and Secure Boot Key management. Configuration options: [Standard] [Custom]

Image Execution Policy

This item only appears when you set the Secure Boot Mode to [Custom]. This allows you to manage the Image Policy on Security Violation.

Aptio Setup Utility - Copyright (C) 2013 American Megatrends, Inc.						
Main	Advanced	Event Logs	Boot Monitor	Security	Tool	Exit
Interval FV				[Always Execute]	Image Execution Policy	
Option ROM				[Deny Execute]	per device path on	
Removable Media				[Deny Execute]	Security Violation.	
Fixed Media				[Deny Execute]		

Internal FV [Always Execute]

Configuration options: [Always Execute]

Option ROM/Removable Media/Fixed Media [Deny Execute]

Configuration options: [Always Execute] [Always Deny] [Allow Execute] [Defer Execute] [Deny Execute] [Query User]

Key Management

This item only appears when you set the Secure Boot Mode to [Custom]. This allows you to modify Secure Boot variables and set Key Management page.

Aptio Setup Utility - Copyright (C) 2013 American Megatrends, Inc.						
Main	Advanced	Event Logs	Boot Monitor	Security	Tool	Exit
Factory Default Key Provisioning [Disabled]				Install Factory default Secure Boot Keys when System is in Setup Mode		
▶ Install All Factory Default Keys						
Platform Key (PK)				NOT INSTALLED		
▶ Set new PK						
▶ Delete PK						
Key Exchange Key Database (KEK)				NOT INSTALLED		
▶ Set new KEK						
▶ Delete KEK						
▶ Append Var to KEK						
Authorized Signature Database (DB)				NOT INSTALLED		
▶ Set new DB						
▶ Delete DB						
▶ Append Var to DB						
Forbidden Signature Database (DBX)				NOT INSTALLED		
▶ Set new DBX						
▶ Delete DBX						
▶ Append Var to DBX						

Factory Default Key Provisioning [Disabled]

Configuration options: [Disabled] [Enabled]

Install All Factory Default Keys

This item will ask you if you want to Install Factory Default secure variables. Select Yes if you want to load the default secure variables, otherwise select No.

Platform Key (PK)/Key Exchange Key Database (KEK)/Authorized Signature Database (DB)/ Forbidden Signature Database (DBX)

Configuration options: [Set New] [Delete] [Append]

5.9 Tool menu

The Tool menu items allow you to configure options for special functions. Select an item then press <Enter> to display the submenu.

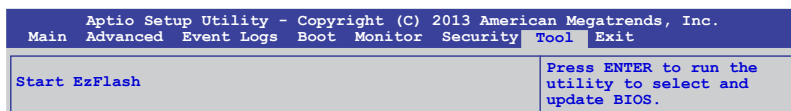

Start EzFlash utility

Allows you to run the Start EzFlash utility. For more information, see section 4.1.2 ASUS EzFlash utility.

5.10 Exit menu

The Exit menu items allow you to save or discard your changes to the BIOS items.

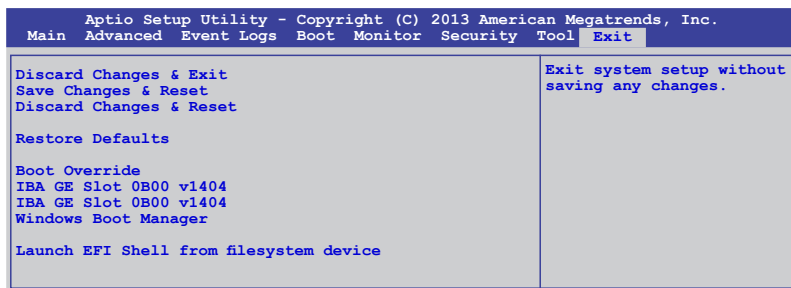

Pressing <Esc> does not immediately exit this menu. Select one of the options from this menu or <F10> from the legend bar to exit.

Discard Changes & Exit

This option allows you to exit the Setup program without saving your changes. When you select this option or if you press <Esc>, a confirmation window appears. Select Yes to discard changes and exit.

Save Changes & Reset

Once you are finished making your selections, choose this option from the Exit menu to ensure the values you selected are saved. When you select this option or if you press <F10>, a confirmation window appears. Select Yes to save changes and exit.

Discard Changes & Reset

This option allows you to reset without saving your changes. When you select this option or if you press <ENTER>, a confirmation window appears. Select Yes to discard changes and reset.

Restore Defaults

This option allows you restore or load the default values for all the setup options. When you select this option or if you press <ENTER>, a confirmation window appears. Select Yes to apply the default values or press <Esc> to exit.

Launch EFI Shell from filesystem device

This option allows you to launch the EFI Shell application (shellx64.efi) from one of the available filesystem devices. Select Yes to proceed, or No to cancel, and then press <Enter>.

Chapter 6

This chapter provides instructions for setting up, creating and configuring RAID sets using the available utilities.

RAID configuration

6.1 Setting up RAID

The motherboard comes with the Intel® C224 controller that supports the Intel® **Rapid Storage Technology enterprise Option ROM Utility** with RAID 0, RAID 1, RAID 10, and RAID 5 support (for Windows® OS only).

6.1.1 RAID definitions

RAID 0 (Data striping) optimizes two identical hard disk drives to read and write data in parallel, interleaved stacks. Two hard disks perform the same work as a single drive but at a sustained data transfer rate, double that of a single disk alone, thus improving data access and storage. Use of two new identical hard disk drives is required for this setup.

RAID 1 (Data mirroring) copies and maintains an identical image of data from one drive to a second drive. If one drive fails, the disk array management software directs all applications to the surviving drive as it contains a complete copy of the data in the other drive. This RAID configuration provides data protection and increases fault tolerance to the entire system. Use two new drives or use an existing drive and a new drive for this setup. The new drive must be of the same size or larger than the existing drive.

RAID 10 is data striping and data mirroring combined without parity (redundancy data) having to be calculated and written. With the RAID 10 configuration you get all the benefits of both RAID 0 and RAID 1 configurations. Use four new hard disk drives or use an existing drive and three new drives for this setup.

RAID 5 stripes both data and parity information across three or more hard disk drives. Among the advantages of RAID 5 configuration include better HDD performance, fault tolerance, and higher storage capacity. The RAID 5 configuration is best suited for transaction processing, relational database applications, enterprise resource planning, and other business systems. Use a minimum of three identical hard disk drives for this setup.



If you want to boot the system from a hard disk drive included in a created RAID set, copy first the RAID driver from the support DVD to a floppy disk before you install an operating system to the selected hard disk drive.

6.1.2 Installing hard disk drives

The motherboard supports Serial ATA for RAID set configuration. For optimal performance, install identical drives of the same model and capacity when creating a disk array.

To install the SATA hard disks for RAID configuration:

1. Install the SATA hard disks into the drive bays following the instructions in the system user guide.
2. Connect a SATA signal cable to the signal connector at the back of each drive and to the SATA connector on the motherboard.
3. Connect a SATA power cable to the power connector on each drive.

6.1.3 Setting Jumpers



Ensure to turn off power before setting the jumpers on the motherboard.

You must set the jumper settings of your motherboard to activate the embedded **Intel® Rapid Storage Technology enterprise SATA Option ROM Utility**.

To set the jumper settings for **Intel® Rapid Storage Technology enterprise SATA Option ROM Utility**, set the 3-pin RAID_SEL1 jumper to pins 2-3.

For more information about the jumper settings of 3-pin RAID_SEL1, you may refer to the **RAID configuration utility** section on page 2-27.

6.1.4 Setting the RAID mode in BIOS

You must set the RAID mode in the BIOS Setup to be able to launch the RAID utilities before you can create a RAID set from the SATA hard disk drives attached to the SATA connectors supported by Intel® C224 chipset.

To do this:

1. Enter the BIOS Setup during POST.
2. Go to the **Advanced Menu > SATA Configuration**, then press <Enter>.
3. Set **SATA Mode** to [RAID].
4. Press <F10> to save your changes and exit the BIOS Setup.



Refer to **Chapter 4** for details on entering and navigating through the BIOS Setup.

6.1.5 RAID configuration utilities

Depending on the RAID connectors that you use, you can create a RAID set using the utilities embedded in each RAID controller. For example, use the **Intel® Rapid Storage Technology enterprise SATA Option ROM Utility** if you installed Serial ATA hard disk drives on the Serial ATA connectors supported by the Intel® C224 chipset.

6.2 Intel® Rapid Storage Technology enterprise SATA Option ROM Utility

The Intel® Rapid Storage Technology enterprise SATA Option ROM utility allows you to create

RAID 0, RAID 1, RAID 10 (RAID 1+0), and RAID 5 set(s) from Serial ATA hard disk drives that are connected to the Serial ATA connectors supported by the Southbridge.



Before you proceed, ensure that you have installed the Serial ATA hard disk drives, have set the correct jumper settings of the motherboard, and have set the correct SATA mode in the BIOS setup. You can refer to sections **5.1.2 Installing hard disk drives**, **5.1.3 Setting Jumpers**, and **5.1.4 Setting the RAID mode in BIOS** for more information.

To launch the Intel® Rapid Storage Technology enterprise SATA Option ROM utility:

1. Turn on the system.
2. During POST, press <Ctrl>+<I> to display the utility main menu.

```
Intel(R) Rapid Storage Technology enterprise - SATA Option ROM - 3.6.0.1023
Copyright(C) 2003-12 Intel Corporation. All Rights Reserved.

[ MAIN MENU ]
1. Create RAID Volume
2. Delete RAID Volume
3. Reset Disks to Non-RAID
4. Exit

[ DISK/VOLUME INFORMATION ]

RAID Volumes:
None defined.

Physical Disks:
ID Drive Model Serial # Size Type/Status (Vol ID)
0 ST3300656SS HWS00000991753TR 279.3GB Non-RAID Disk
1 ST3300656SS 37VN00009846RAJ1 279.3GB Non-RAID Disk
2 ST3300656SS 397600009846UEDY 279.3GB Non-RAID Disk
3 ST3300656SS GWC50000991756G6 279.3GB Non-RAID Disk

[↑↓]-Select [ESC]-Exit [ENTER]-Select Menu
```

The navigation keys at the bottom of the screen allow you to move through the menus and select the menu options.



The RAID BIOS setup screens shown in this section are for reference only and may not exactly match the items on your screen.

6.2.1 Creating a RAID set

To create a RAID set:

1. From the utility main menu, select **1. Create RAID Volume** and press <Enter>.
2. Key in a name for the RAID set from the following screen and press <Enter>.

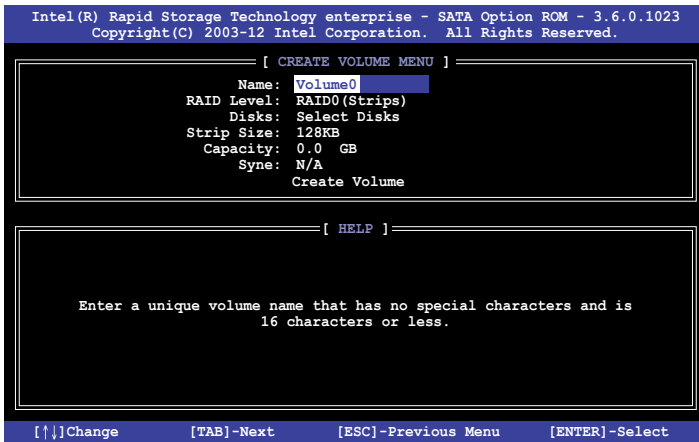

3. Press the up/down arrow keys to select a RAID Level that you wish to create then press <Enter>.
4. From the **Disks** item field, press <Enter> to select the hard disk drives that you want to include in the RAID set.

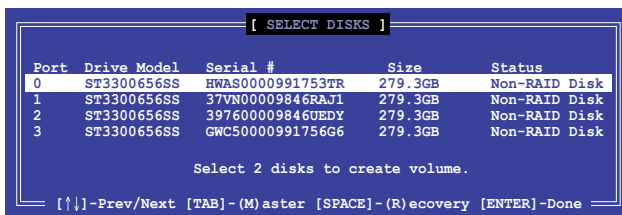

5. Use the up/down arrow keys to move the selection bar then press <Space> to select a disk. A small triangle before the Port number marks the selected drive. Press <Enter> when you are done.

6. Use the up/down arrow keys to select the stripe size for the RAID array (for RAID 0, 10 and 5 only) then press <Enter>. The available stripe size values range from 4 KB to 128 KB. The following are typical values:
RAID 0: 128KB
RAID 10: 64KB
RAID 5: 64KB



We recommend a lower stripe size for server systems, and a higher stripe size for multimedia computer systems used mainly for audio and video editing.

7. In the Capacity field item, key in the RAID volume capacity that you want to use and press <Enter>. The default value indicates the maximum allowed capacity.
8. Press <Enter> to start creating the RAID volume.
9. From the following warning message, press <Y> to create the RAID volume and return to the main menu, or press <N> to go back to the CREATE VOLUME menu



6.2.2 Deleting a RAID set



Take caution when deleting a RAID set. You will lose all data on the hard disk drives when you delete a RAID set.

To delete a RAID set:

1. From the utility main menu, select **2. Delete RAID Volume** and press <Enter>.
2. From the Delete Volume Menu, press the up/down arrow keys to select the RAID set you want to delete then press .

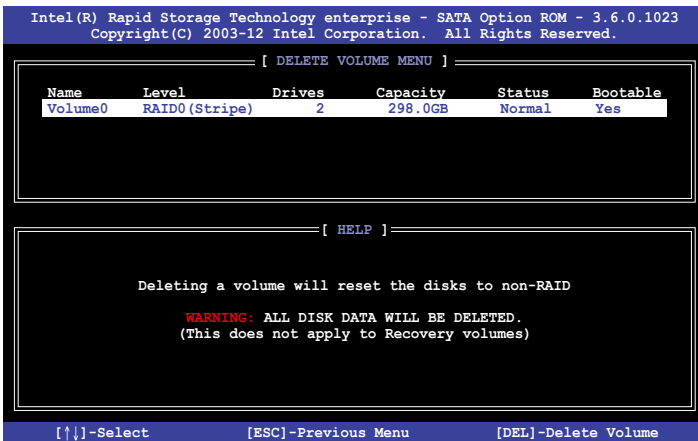

3. From the following warning message, press <Y> to delete the RAID set and return to the utility main menu, or press <N> to return to the **DELETE VOLUME** menu.

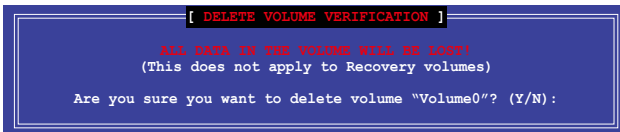

6.2.3 Resetting disks to Non-RAID



Take caution before you reset a RAID volume hard disk drive to non-RAID. Resetting a RAID volume hard disk drive deletes all internal RAID structure on the drive.

To reset a RAID set hard disk drive:

1. From the utility main menu, select **3. Reset Disks to Non-RAID** and press <Enter>.
2. Press the up/down arrow keys to select the drive(s) or disks of the RAID set you want to reset, then press <Space>. A small triangle before the Port number marks the selected drive. Press <Enter> when you are done.

```
[ RESET RAID DATA ]
Resetting RAID disk will remove its RAID structures
and revert it to a non-RAID disk.
WARNING: Resetting a disk removes all data on the disk to be lost.
(This does not apply to Recovery volumes)
Port  Drive Model  Serial #          Size      Status
 0  ST3300656SS  HWAS0000991753TR  279.3GB  Member Disk
 1  ST3300656SS  37VN00009846RAJ1  279.3GB  Member Disk
Select the disks that should be reset.
[↑↓]-Previous/Next [SPACE]-Selects [ENTER]-Selection Complete
```

3. Press <Y> in the confirmation window to reset the drive(s) or press <N> to return to the utility main menu.

6.2.4 Exiting the Intel® Rapid Storage Technology enterprise SATA Option ROM utility

To exit the utility:

1. From the utility main menu, select 4. Exit then press <Enter>.
2. From the following warning message, press <Y> to exit or press <N> to return to the utility main menu.

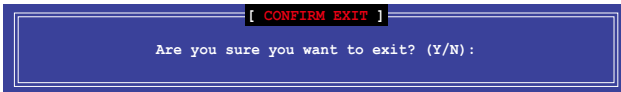

6.2.5 Rebuilding the RAID



This option is only for the RAID 1 set.

Rebuilding the RAID with other non-RAID disk

If any of the SATA hard disk drives included in the RAID 1 array failed, the system displays the status of the RAID volume as “Degraded” during POST. You can rebuild the RAID array with other installed non-RAID disks.

To rebuild the RAID with other non-RAID disk:

1. During POST, press <Ctrl>+<I> at the prompt to enter the Intel Rapid Storage Technology option ROM utility.
2. If there is a non-RAID SATA Hard Disk available, the utility will prompt you to rebuild the RAID. Press the up/down arrow keys to select the destination disk then Press <Enter> to start the rebuilding process or press <ESC> to exit.

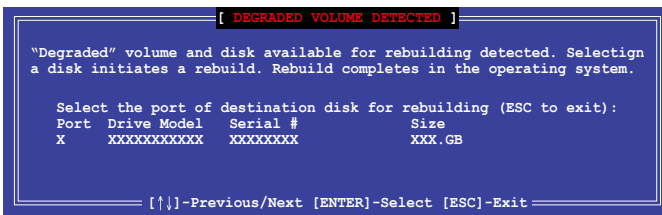

Select a destination disk with the same size as the original hard disk.

- The utility immediately starts rebuilding after the disk is selected. The status of the degraded RAID volume is changed to **“Rebuild”**.

```

Intel(R) Rapid Storage Technology enterprise - SATA Option ROM - 3.6.0.1023
Copyright(C) 2003-12 Intel Corporation. All Rights Reserved.

[ MAIN MENU ]
1. Create RAID Volume
2. Delete RAID Volume
3. Reset Disks to Non-RAID
4. Exit

[ DISK/VOLUME INFORMATION ]

RAID Volumes:
ID Name Level1 Strip Size Status Bootable
1 Volume0 RAID1(Mirror) N/A 149.0GB Rebuild Yes

Physical Devices:
Port Drive Model Serial # Size Type/Status (Vol ID)
1 ST3160812AS 9LS0F4HL 149.0GB Member Disk(0)
2 ST3160812AS 3LS0JYL8 149.0GB Member Disk(0)

Volumes with "Rebuild" status will be rebuilt within the operating system.

[↑↓]-Select [ESC]-Exit [ENTER]-Select Menu

```

- Exit Intel Rapid Storage Technology and reboot the system.
- Select **Start > Programs > Intel Rapid Storage > Intel Rapid Storage Console** or click the **Intel Rapid Storage Technology** tray icon to load the Intel Rapid Storage Manager utility.
- From the **View** menu, select **Advanced Mode** to display the details of the Intel Rapid Storage Console.
- From the **Volumes view** option, select **RAID volume** to view the rebuilding status. When finished, the status is changed to **“Normal”**.

Rebuilding the RAID with a new hard disk

If any of the SATA hard disk drives included in the RAID array failed, the system displays the status of the RAID volume as “Degraded” during POST. You may replace the disk drive and rebuild the RAID array.

To rebuild the RAID with a new hard disk:

- Remove the failed SATA hard disk and install a new SATA hard disk of the same specification into the same SATA Port.



Select a destination disk with the same size as the original hard disk.

- Reboot the system then follow the steps in section **Rebuilding the RAID with other non-RAID disk**.

6.2.6 Setting the Boot array in the BIOS Setup Utility

You can set the boot priority sequence in the BIOS for your RAID arrays when creating multi-RAID using the Intel® Rapid Storage Technology enterprise SATA Option ROM utility.

To set the boot array in the BIOS:



Set at least one of the arrays bootable to boot from the hard disk.

1. Reboot the system and press to enter the BIOS setup utility during POST.
2. Go to the **Boot** menu and select the boot option priority.
3. Use up/down arrow keys to select the boot priority and press <Enter>. See the **Boot menu** section of Chapter 4 for more details.
4. From the **Exit** menu, select **Save Changes & Exit**, then press <Enter>.

6.3 Intel® Rapid Storage Technology enterprise (Windows)

The Intel® Rapid Storage Technology enterprise allows you to create RAID 0, RAID 1, RAID 10 (RAID 1+0), and RAID 5 set(s) from Serial ATA hard disk drives that are connected to the Serial ATA connectors supported by the Southbridge.



You need to manually install the Intel® Rapid Storage Technology enterprise utility on a Windows® operating system. Please refer to the installation instructions in Chapter 6.

To enter the Intel® Rapid Storage Technology enterprise utility under Windows operating system:

1. Turn on the system to windows desktop.
2. Click the **Intel® Rapid Storage Technology enterprise** icon to display the main menu.

Your storage system is configured for data protection, increased performance and optimal data storage capacity. You can create additional volumes to further optimize your storage system.

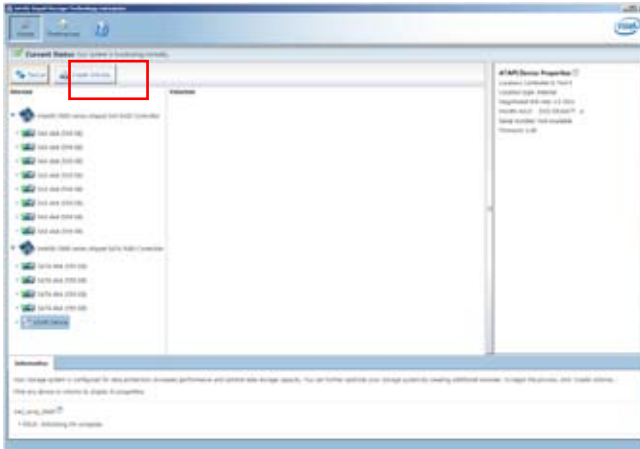

You can click **Rescan** to re-scan any attached hard disks.

6.3.1 Creating a RAID set

To create a RAID set:

1. From the utility main menu, select **Create Volume** and select volume type.
2. Click **Next**.

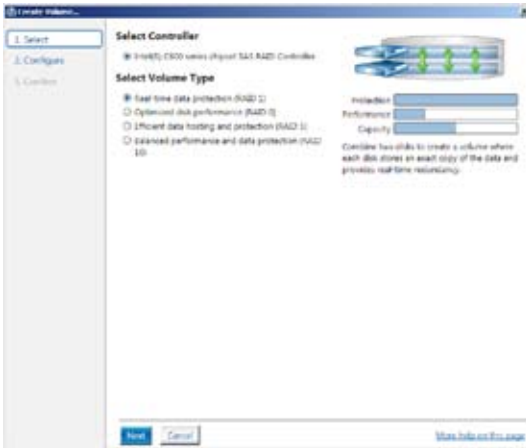

3. Enter a name for the RAID set, then select the array disks.
4. Select **Volume Size** tab, you can drag the bar to decide the volume size.
5. Click **Next**.



- If you do not want to keep the data on one of the selected disks, select **NO** when prompted.
- If you want to **Enable volume write-back cache** or **Initialize volume**, click **Advanced**.

6.3.2 Changing a Volume Type

To change the volume type in **Volume Properties**:

1. Click the SATA array items you want to change in **Volumes** field.
2. From the **Volume Properties** field, select **Type:RAID 1 Change type**.

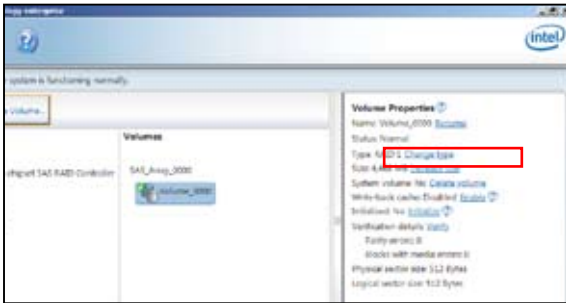

3. You can change the **Name**, **Select the new volume type**, and **Select additional disks to include in the new volume** if needed.
4. Select the **Data stripe size** for the RAID array (for RAID 0, 10 and 5 only), and click **OK**. The available stripe size values range from 4 KB to 128 KB. The following are typical values:

RAID 0: 128KB

RAID 10: 64KB

RAID 5: 64KB

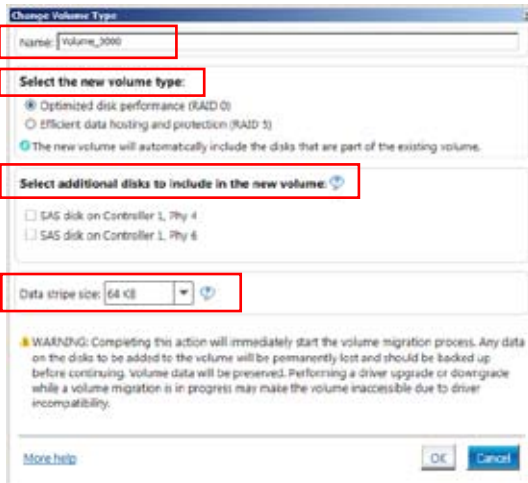

We recommend a lower stripe size for server systems, and a higher stripe size for multimedia computer systems used mainly for audio and video editing.

6.3.3 Deleting a volume



Be cautious when deleting a volume. You will lose all data on the hard disk drives. Before you proceed, ensure that you back up all your important data from your hard drives.

To delete a volume:

1. From the utility main menu, select the volume (exp. Volume_0000) in **Volumes** field you want to delete.

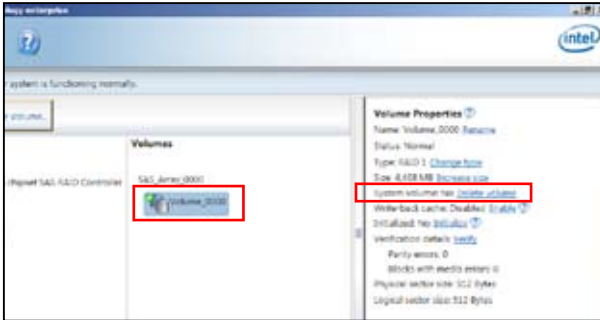

2. Select **Delete volume** in **Volume Properties** field. The following screen appears.



3. Click **Yes** to delete the volume and return to the utility main menu, or click **No** to return to the main menu.

6.3.4 Preferences

System Preferences

Allow you to set to show the notification area icon and show system information, warning, or errors here.

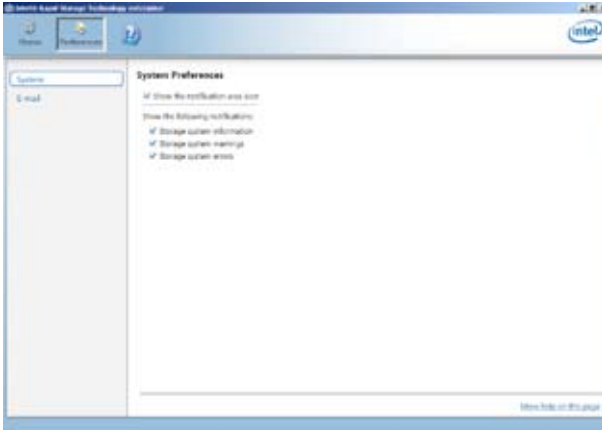

E-Mail Preferences

Allow you to set to sent e-mail of the following events:

- Storage system information
- Storage system warnings
- Storage system errors



Chapter 7

This chapter provides instructions for installing the necessary drivers for different system components.

Driver installation

7.1 RAID driver installation

After creating the RAID sets for your server system, you are now ready to install an operating system to the independent hard disk drive or bootable array. This part provides the instructions on how to install the RAID controller drivers during OS installation.

7.1.1 Creating a RAID driver disk



The system does not include a floppy drive. You have to use a USB floppy drive when creating a SATA RAID driver disk.



If you have created RAID sets with the LSI Software RAID configuration utility, the boot priority of the SATA optical disk drive has to be manually adjusted. Otherwise, the system will not boot from the connected SATA ODD.

A floppy disk with the RAID driver is required when installing Windows® or Red Hat® Enterprise operating system on a hard disk drive that is included in a RAID set. You can create a RAID driver disk in DOS (using the Makedisk application in the support DVD).

To create a RAID driver disk in DOS environment:

1. Place the motherboard support DVD in the optical drive.
2. Restart the computer.
3. Enter the BIOS Setup.
4. Select the optical drive as the first boot priority to boot from the support DVD. Save your changes.
5. Exit the BIOS Setup and restart the computer.
The following Makedisk menu appears.
6. Select the **C22x INTEL RAID Driver** and press <Enter> to go to the sub-menu.



7. From the Makedisk sub-menu, use the Up or Down arrow keys to select the driver and press <Enter> to create the RAID driver disk.

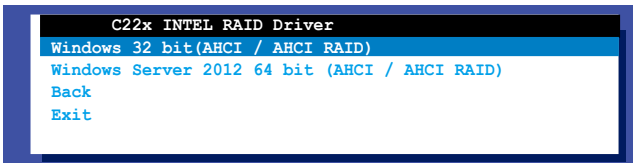

8. Select **YES** from the following warning message then press <Enter>.



9. On the following **Important** message, select **YES** if an ASMB7 is installed, otherwise select NO, then press <Enter>.

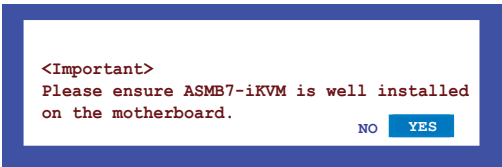

10. Insert the formatted diskette into the disk drive and press <Enter>. The system writes the image to the disk.
11. Press any key to continue when prompted.
The Create Driver Diskette Menu appears after the creation of the diskette is finished.

To create a RAID driver disk in Windows® environment:

1. Start Windows®.
2. Place the motherboard support DVD into the optical drive.
3. Go to the **Make disk** menu, then select the type of RAID driver disk you want to create.
4. Insert a floppy disk into the USB floppy disk drive.
5. Follow succeeding screen instructions to complete the process.



Write-protect the floppy disk to avoid computer virus infection.

7.1.2 Installing the RAID controller driver

During Windows® Server 2008 OS installation

To install the RAID controller driver when installing Windows® Server 2008 OS

1. Boot the computer using the Windows® Server 2008 OS installation disc. Follow the screen instructions to start installing Windows Server 2008.



3. Click **Load Driver**.

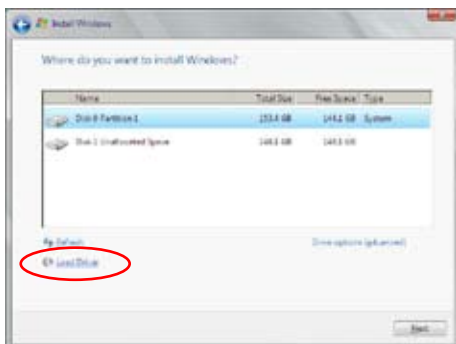

4. A message appears, reminding you to insert the installation media containing the driver of the RAID controller driver. If you have only one optical drive installed in your system, eject the Windows OS installation disc and replace with the motherboard Support DVD into the optical drive. Click **Browse** to continue.



5. Locate the driver in the corresponding folder of the Support DVD, and then click **OK** to continue.
6. Select the RAID controller driver you need from the list and click **Next**.
7. When the system finishes loading the RAID driver, replace the motherboard Support DVD with the Windows Server installation disc. Select the drive to install Windows and click **Next**.

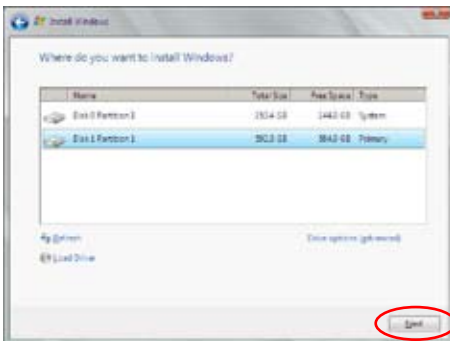

8. Setup then proceeds with the OS installation. Follow screen instructions to continue.

7.2 Management applications and utilities installation

The support DVD that is bundled with your motherboard contains drivers, management applications, and utilities that you can install to maximize the features of your motherboard.



1. The contents of the support DVD are subject to change at any time without notice. Visit the ASUS website (www.asus.com) for the latest updates on software and utilities.
2. The support DVD is supported on Windows® Server 2008 R2 and Windows® Server 2012.

7.3 Running the Support DVD

When you place the support DVD into the optical drive, the DVD automatically displays the main screen if Autorun is enabled in your computer. By default, the Drivers tab is displayed.



If Autorun is NOT enabled in your computer, browse the contents of the support DVD to locate the file ASSETUP.EXE from the BIN folder. Double-click the ASSETUP.EXE to run the support DVD.

The main screen of the Support DVD contains the following tabs:

1. Drivers
2. Utilities
3. MakeDisk
4. Manual
5. Contact



The main screen of the Support DVD looks exactly the same on the Windows® Server 2008 R2 and on the Windows® Server 2012 Operating System (OS).

7.3.1 Drivers menu tab

The Drivers Menu shows the available device drivers if the system detects installed devices. Install the necessary drivers to activate the devices.



7.3.2 Utilities menu tab

The Utilities menu displays the software applications and utilities that the motherboard supports.



7.3.3 MakeDisk menu tab

The MakeDisk menu contains items to create the Intel RAID driver disks.



You have to press the arrow down button in the lower part of the screen to view the remaining items of the MakeDisk menu.



7.3.4 Manual menu

The Manual menu provides the link to the Broadcom NetXtreme II Network Adapter user guide.



You need an internet browser installed in your OS to view the User Guide.



7.3.5 Contact information menu

The Contact menu displays the ASUS contact information, e-mail addresses, and useful links if you need more information or technical support for your



7.3.6 Installing the Intel® Chipset device Software driver

This section provides the instructions on how to install the Intel® chipset device software on the system.

You need to manually install the Intel® chipset device software on a Windows® Operating System.

To install the Intel® chipset device software on Windows® Server 2008 R2:

1. Restart the computer.
2. Log with **Administrator** privileges.
3. Insert the Motherboard Support DVD to the optical drive.

The support DVD automatically displays the **Drivers** menu if Autorun is enabled in your computer.



If Autorun is NOT enabled in your computer, browse the contents of the support DVD to locate the file **ASSETUP.EXE** from the **BIN** folder. Double-click the **ASSETUP.EXE** to run the support DVD.

4. Click **Intel® Chipset Device Software** from the Drivers menu to start the installation.

- From the **Intel® Chipset Device Software**, click **Next** to start the installation.



- In the **License Agreement** window, click **Yes** to continue.



- Read the Readme File information and click **Next** to continue.



8. Click **Install** in the **Windows Security** window.



The Windows Security window may appear more than once and you may have to click **Install** several times to continue with the installation.

9. When the installation of files is finish, click **Next**.



10. When prompted to restart the computer, select **Yes, I want to restart this computer now** then click **Finish** to complete the installation.



To install the Intel® Chipset device software on Windows® Server 2012:

1. Restart the computer.
2. Log with **Administrator** privileges.
3. Insert the Motherboard Support DVD to the optical drive.

The support DVD automatically displays the **Drivers** menu if Autorun is enabled in your computer.



If Autorun is NOT enabled in your computer, browse the contents of the support DVD to locate the file **ASSETUP.EXE** from the **BIN** folder. Double-click the **ASSETUP.EXE** to run the support DVD.

4. Click **Intel® Chipset Device Software** from the Drivers menu to start the installation.
5. From the **Intel® Chipset Device Software**, click **Next**.



6. In the **License Agreement** window, click **Yes** to continue the process.



7. Read the Readme File information and click **Next** to continue.



8. When the loading of files is finished, click **Finish** to complete the installation.



7.4 Installing the LAN driver

This section provides the instructions on how to install the **Intel® Network Connections Software** drivers on the system.

You need to manually install the LAN controller driver on a Windows® operating system.

To install the **LAN** controller device on Windows® Server 2008 R2:

1. Restart the computer.
2. Log with **Administrator** privileges.
3. Insert the Motherboard Support DVD to the optical drive.

The support DVD automatically displays the **Drivers** menu if Autorun is enabled in your computer.



If Autorun is NOT enabled in your computer, browse the contents of the support DVD to locate the file **ASSETUP.EXE** from the **BIN** folder. Double-click the **ASSETUP.EXE** to run the support DVD.

4. Click **Intel® Network Connections Software** on the **Drivers** menu to start the installation.



5. From the **Intel® Network Connections** window, click **Install Drivers and Software**.



6. Click **Next** in the **Welcome to the InstallShield Wizard for Intel(R) Network Connections**.



7. Toggle **I accept the terms** in the **license agreement** then click **Next** in the **License Agreement** window.



8. Select the drivers you want to install in the **Setup Options** window and click **Next**.

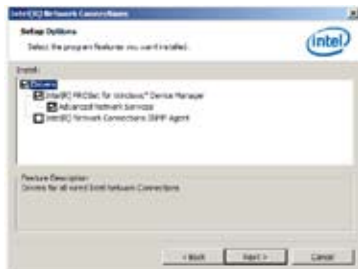

9. From the **Ready to Install the Program** window, click **Install**.



10. Click **Yes** when the **Microsoft Management Console** dialog box appears.



The **Microsoft Management Console** dialog box appears when the system detects open or running applications that needs to be closed. You have to terminate open or running applications specified in the dialog box to proceed with the installation.

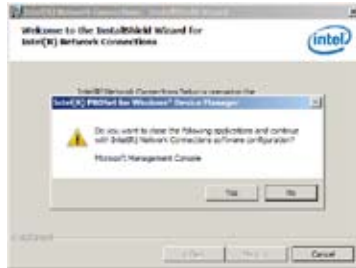

11. When the loading of drivers is finish, click **Finish** to complete the installation.



To install the **LAN** controller device on Windows® Server 2012:

1. Restart the computer.
2. Log with **Administrator** privileges.
3. Insert the Motherboard Support DVD to the optical drive.

The support DVD automatically displays the **Drivers** menu if Autorun is enabled in your computer.



If Autorun is NOT enabled in your computer, browse the contents of the support DVD to locate the file **ASSETUP.EXE** from the **BIN** folder. Double-click the **ASSETUP.EXE** to run the support DVD.

4. Click **Intel® Network Connections Software** on the **Drivers** menu to start the installation.

- From the **Intel® Network Connections** window, click **Install Drivers and Software**.



- Click **Next** in the **Welcome to the InstallShield Wizard for Intel(R) Network Connections** window.



- Select the drivers you want to install in the **Setup Options** window and click **Next**.



- Click **Install** to continue.



- When the the installation of files is finish, click **Finish** to complete the installation.



7.5 Installing the VGA driver

This section provides the instructions on how to install the **ASPEED Video Graphics Adapter (VGA)** driver.

You need to manually install the **ASPEED Video Graphics Adapter (VGA)** driver on a Windows® operating system.

To install the **ASPEED VGA** driver on Windows® Server 2008 R2:

1. Restart the computer.
2. Log with **Administrator** privileges.
3. Insert the Motherboard Support DVD to the optical drive.

The support DVD automatically displays the **Drivers** menu if Autorun is enabled in your computer.



If Autorun is NOT enabled in your computer, browse the contents of the support DVD to locate the file **ASSETUP.EXE** from the **BIN** folder. Double-click the **ASSETUP.EXE** to run the support DVD.

The Main menu of the Support DVD appears.

4. Click **ASPEED AST2300/AST1300 Display Driver** on the **Drivers** menu to start the installation.



5. Toggle I accept the terms in the license agreement and click Next in the License Agreement window.



10. When prompted to restart the computer, click **Yes**.



To install the **ASPEED VGA** driver on Windows® Server 2012:

1. Restart the computer.
2. Log with **Administrator** privileges.
3. Insert the Motherboard Support DVD to the optical drive.
The support DVD automatically displays the **Drivers** menu if Autorun is enabled in your computer.



If Autorun is NOT enabled in your computer, browse the contents of the support DVD to locate the file **ASSETUP.EXE** from the **BIN** folder. Double-click the **ASSETUP.EXE** to run the support DVD.

4. Click **ASPEED AST2300/AST1300 Display Driver** on the **Drivers** menu to start the installation.
5. Click **OK** in the Driver Information window.



Wait for the loading of drivers to finish.

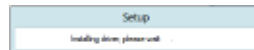

6. Click **OK** to complete the installation.



7.6 Installing the Intel® C22x MEI NULL HECI

This section provides the instructions on how to install the Intel® C22x MEI NULL HECI driver on the motherboard.

To install the **Intel® C22x MEI NULL HECI** driver in Windows:

1. Restart the computer.
2. Log on with **Administrator** privileges.
3. Insert the motherboard/system support DVD to the optical drive.



If Autorun is NOT enabled in your computer, browse the contents of the support DVD to locate the file **ASSETUP.EXE** from the **BIN** folder. Double-click the **ASSETUP.EXE** to run the support DVD.

4. Click **Intel® C22x MEI NULL HECI** on the **Drivers** menu of the main screen to start the installation.



5. The **Welcome to the Setup Program** window appears. Click **Next**.



- Click **Yes** in the **License Agreement** window to continue with the installation.



- Click **NEXT** when the installation of driver is complete.



- Click **Finish** to complete the installation.



7.7 Installing the Intel® I210 Gigabit

This section provides the instructions on how to install the Intel® I210 Gigabit Adapter driver on the system.

To install the Intel® I210 Gigabit Adapter driver on Windows® Server 2008 R2:

1. Restart the computer.
2. Log on with **Administrator** privileges.
3. Insert the motherboard/system support DVD to the optical drive.



If Autorun is NOT enabled in your computer, browse the contents of the support DVD to locate the file **ASSETUP.EXE** from the **BIN** folder. Double-click the **ASSETUP.EXE** to run the support DVD.

4. Click **Intel® I210 Gigabit Adapter Driver** in the **Drivers** menu of the main screen to start the installation.



5. Click **Next** to continue.



6. Toggle **Modify** then click **Next** in the **Program Maintenance** window.



7. Select the options you want to install then click **Next** to continue.

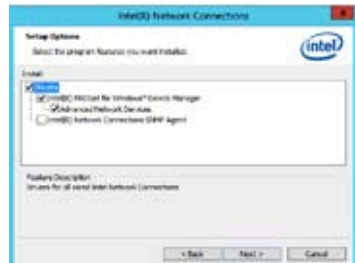

8. Click **Install** in the **Ready to Modify the Program** window to begin with the loading of the selected options.



9. When the the installation of files is complete, click **Finish**.



To install the **Intel® I210 Gigabit Adapter** driver on Windows® Server 2012:

1. Restart the computer.
2. Log on with **Administrator** privileges.
3. Insert the motherboard/system support DVD to the optical drive.



If Autorun is NOT enabled in your computer, browse the contents of the support DVD to locate the file **ASSETUP.EXE** from the **BIN** folder. Double-click the **ASSETUP.EXE** to run the support DVD.

4. Click **Intel® I210 Gigabit Adapter Driver** in the **Drivers** menu of the main screen to start the installation.
5. Click **Next** to continue.



6. Toggle **Modify** then click **Next** in the **Program Maintenance** window.



7. Select the options you want to install then click **Next** to continue.

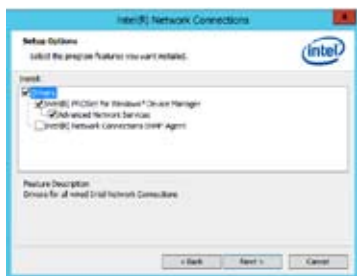

- In the **Ready to Modify the Program** window, click **Install** to load the options you selected.

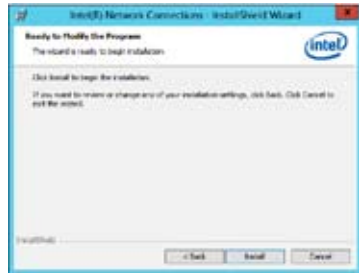

- When the the installation of files is complete, click **Finish**.



ASUS contact information

ASUSTeK COMPUTER INC.

Address 15 Li-Te Road, Peitou, Taipei, Taiwan 11259
Telephone +886-2-2894-3447
Fax +886-2-2890-7798
E-mail info@asus.com.tw
Web site <http://www.asus.com.tw>

Technical Support

Telephone +86-21-38429911
Fax +86-21-58668722 ext: 9101
Online Support <http://support.asus.com/techserv/techserv.aspx>

ASUSTeK COMPUTER INC. (Taiwan)

Address 15 Li-Te Road, Peitou, Taipei, Taiwan 11259
Telephone +886-2-2894-3447
Fax +886-2-2890-7798
E-mail info@asus.com.tw
Web site <http://www.asus.com.tw>

Technical Support

Telephone +886-2-2894-3447 (0800-093-456)
Online Support <http://support.asus.com/techserv/techserv.aspx>

ASUSTeK COMPUTER INC. (China)

Address No.508, Chungong Road, Xinzhuang Industrial Zone,
Minhang District, Shanghai, China.
Telephone +86-21-5442-1616
Fax +86-21-5442-0099
Web site <http://www.asus.com.cn>

Technical Support

Telephone +86-21-3407-4610 (800-820-6655)
Online Support <http://support.asus.com/techserv/techserv.aspx>

ASUS contact information

ASUS COMPUTER INTERNATIONAL (America)

Address 800 Corporate Way, Fremont, CA 94539, USA
Fax +1-510-608-4555
Web site <http://usa.asus.com>

Technical Support

Support fax +1-812-284-0883
General support +1-812-282-2787
Online support <http://support.asus.com/techserv/techserv.aspx>

ASUS COMPUTER GmbH (Germany and Austria)

Address Harkort Str. 21-23, D-40880 Ratingen, Germany
Fax +49-2102-959911
Web site <http://www.asus.de>
Online contact <http://www.asus.de/sales>

Technical Support

Telephone +49-1805-010923
Support Fax +49-2102-959911
Online support <http://support.asus.com/techserv/techserv.aspx>

ASUS Czech Service s.r.o. (Europe)

Address Na Rovince 887, 720 00 Ostrava – Hrabová, Czech
Republic
Telephone +420-596766888
Web site <http://www.asus.cz>

Technical Support

Telephone +420-596-766-891
Fax +420-596-766-329
E-mail advance.rma.eu@asus.com
Online Support <http://support.asus.com/techserv/techserv.aspx>

ASUS contact information

ASUS Holland BV (The Netherlands)

Address Marconistraat 2, 7825GD EMMEN, The Netherlands
Web site <http://www.asus.com>

Technical Support

Telephone +31-(0)591-5-70292
Fax +31-(0)591-666853
E-mail advance.rma.eu@asus.com
Online Support <http://support.asus.com/techserv/techserv.aspx>

ASUS Polska Sp. z o.o. (Poland)

Address Ul. Postępu 6, 02-676 Warszawa, Poland
Web site <http://pl.asus.com>

Technical Support

Telephone +48-225718033
Online Support <http://support.asus.com/techserv/techserv.aspx>

ASK-Service (Russia and CIS)

Address г.Москва, ул. Орджоникидзе, д.10, Россия
Telephone (495) 640-32-75
Web site <http://ru.asus.com>

Technical Support

Telephone 008-800-100-ASUS (008-800-100-2787)
Online Support <http://vip.asus.com/eservice/techserv.aspx?SLanguage=ru>

Free Manuals Download Website

<http://myh66.com>

<http://usermanuals.us>

<http://www.somanuals.com>

<http://www.4manuals.cc>

<http://www.manual-lib.com>

<http://www.404manual.com>

<http://www.luxmanual.com>

<http://aubethermostatmanual.com>

Golf course search by state

<http://golfingnear.com>

Email search by domain

<http://emailbydomain.com>

Auto manuals search

<http://auto.somanuals.com>

TV manuals search

<http://tv.somanuals.com>