

# ASUS Desktop PC M51BC User Manual

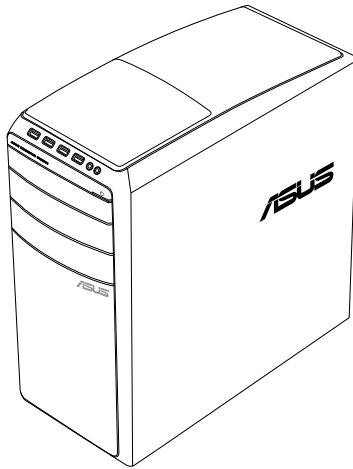

E8855

Second Edition V2

Nov. 2013

**Copyright © 2013 ASUSTeK Computer Inc. All Rights Reserved.**

No part of this manual, including the products and software described in it, may be reproduced, transmitted, transcribed, stored in a retrieval system, or translated into any language in any form or by any means, except documentation kept by the purchaser for backup purposes, without the express written permission of ASUSTeK Computer Inc. ("ASUS").

Product warranty or service will not be extended if: (1) the product is repaired, modified or altered, unless such repair, modification or alteration is authorized in writing by ASUS; or (2) the serial number of the product is defaced or missing.

ASUS PROVIDES THIS MANUAL "AS IS" WITHOUT WARRANTY OF ANY KIND, EITHER EXPRESS OR IMPLIED, INCLUDING BUT NOT LIMITED TO THE IMPLIED WARRANTIES OR CONDITIONS OF MERCHANTABILITY OR FITNESS FOR A PARTICULAR PURPOSE. IN NO EVENT SHALL ASUS, ITS DIRECTORS, OFFICERS, EMPLOYEES OR AGENTS BE LIABLE FOR ANY INDIRECT, SPECIAL, INCIDENTAL, OR CONSEQUENTIAL DAMAGES (INCLUDING DAMAGES FOR LOSS OF PROFITS, LOSS OF BUSINESS, LOSS OF USE OR DATA, INTERRUPTION OF BUSINESS AND THE LIKE), EVEN IF ASUS HAS BEEN ADVISED OF THE POSSIBILITY OF SUCH DAMAGES ARISING FROM ANY DEFECT OR ERROR IN THIS MANUAL OR PRODUCT.

SPECIFICATIONS AND INFORMATION CONTAINED IN THIS MANUAL ARE FURNISHED FOR INFORMATIONAL USE ONLY, AND ARE SUBJECT TO CHANGE AT ANY TIME WITHOUT NOTICE, AND SHOULD NOT BE CONSTRUED AS A COMMITMENT BY ASUS. ASUS ASSUMES NO RESPONSIBILITY OR LIABILITY FOR ANY ERRORS OR INACCURACIES THAT MAY APPEAR IN THIS MANUAL, INCLUDING THE PRODUCTS AND SOFTWARE DESCRIBED IN IT.

Products and corporate names appearing in this manual may or may not be registered trademarks or copyrights of their respective companies, and are used only for identification or explanation and to the owners' benefit, without intent to infringe.

# Contents

|                                      |    |
|--------------------------------------|----|
| Notices .....                        | 5  |
| Safety information.....              | 8  |
| Conventions used in this guide.....  | 9  |
| Where to find more information ..... | 9  |
| Package contents.....                | 10 |

## **Chapter 1: Getting started**

|                                    |    |
|------------------------------------|----|
| Welcome!.....                      | 11 |
| Getting to know your computer..... | 11 |
| Setting up your computer.....      | 16 |
| Turning your computer ON/OFF ..... | 18 |

## **Chapter 2: Using Windows® 7**

|  |    |
|--|----|
| Starting for the first time.....       | 19 |
| Using Windows® 7 desktop.....          | 20 |
| Managing your files and folders.....   | 22 |
| Restoring your system settings.....    | 24 |
| Protecting your computer.....          | 25 |
| Getting Windows® Help and Support..... | 26 |

## **Chapter 3: Using Windows® 8**

|                                       |    |
|---------------------------------------|----|
| Starting for the first time.....      | 27 |
| Using the Windows® UI.....            | 28 |
| Working with Windows® apps .....      | 31 |
| Other keyboard shortcuts .....        | 36 |
| Turning your Desktop PC OFF .....     | 37 |
| Putting your Desktop PC to sleep..... | 37 |
| Entering the BIOS Setup .....         | 38 |

## **Chapter 4: Connecting devices to your computer**

|   |    |
|---|----|
| Connecting a USB storage device.....        | 39 |
| Connecting microphone and speakers .....    | 40 |
| Connecting multiple external displays ..... | 44 |
| Connecting an HDTV.....                     | 47 |

# Contents

## **Chapter 5: Using your computer**

|   |    |
|---|----|
| Proper posture when using your Desktop PC.....    | 49 |
| Using the memory card reader .....                | 50 |
| Using the optical drive .....                     | 51 |
| Using the keyboard (on selected models only)..... | 52 |

## **Chapter 6: Connecting to the Internet**

|   |    |
|---|----|
| Wired connection.....                           | 53 |
| Wi-Fi connection (on selected models only)..... | 61 |

## **Chapter 7: Using the utilities**

|   |    |
|---|----|
| ASUS AI Suite II.....                     | 65 |
| ASUS Smart Cooling System (optional)..... | 72 |
| Recovering your system.....               | 74 |

## **Chapter 8: Troubleshooting**

|                               |    |
|-------------------------------|----|
| Troubleshooting.....          | 79 |
| ASUS contact information..... | 87 |

## Notices

### ASUS Recycling/Takeback Services

ASUS recycling and takeback programs come from our commitment to the highest standards for protecting our environment. We believe in providing solutions for you to be able to responsibly recycle our products, batteries, other components, as well as the packaging materials. Please go to <http://csr.asus.com/english/Takeback.htm> for the detailed recycling information in different regions.

### REACH

Complying with the REACH (Registration, Evaluation, Authorisation, and Restriction of Chemicals) regulatory framework, we published the chemical substances in our products at ASUS REACH website at <http://csr.asus.com/english/REACH.htm>

### Federal Communications Commission Statement

This device complies with Part 15 of the FCC Rules. Operation is subject to the following two conditions:

- This device may not cause harmful interference; and
- This device must accept any interference received including interference that may cause undesired operation.

This equipment has been tested and found to comply with the limits for a Class B digital device, pursuant to Part 15 of the FCC Rules. These limits are designed to provide reasonable protection against harmful interference in a residential installation. This equipment generates, uses and can radiate radio frequency energy and, if not installed and used in accordance with manufacturer's instructions, may cause harmful interference to radio communications. However, there is no guarantee that interference will not occur in a particular installation. If this equipment does cause harmful interference to radio or television reception, which can be determined by turning the equipment off and on, the user is encouraged to try to correct the interference by one or more of the following measures:

- Reorient or relocate the receiving antenna.
- Increase the separation between the equipment and receiver.
- Connect the equipment to an outlet on a circuit different from that to which the receiver is connected.
- Consult the dealer or an experienced radio/TV technician for help.



The use of shielded cables for connection of the monitor to the graphics card is required to assure compliance with FCC regulations. Changes or modifications to this unit not expressly approved by the party responsible for compliance could void the user's authority to operate this equipment.

#### *Lithium-Ion Battery Warning*

**CAUTION:** Danger of explosion if battery is incorrectly replaced. Replace only with the same or equivalent type recommended by the manufacturer. Dispose of used batteries according to the manufacturer's instructions.

### Avertissement relatif aux batteries Lithium-Ion

**MISE EN GARDE** : Danger d'explosion si la pile n'est pas remplacée correctement. Remplacer uniquement avec une pile de type semblable ou équivalent, recommandée par le fabricant. Mettez au rebut les batteries usagées conformément aux instructions du fabricant.

## IC: Canadian Compliance Statement

Complies with the Canadian ICES-003 Class B specifications. This device complies with RSS 210 of Industry Canada. This Class B device meets all the requirements of the Canadian interference-causing equipment regulations.

This device complies with Industry Canada license exempt RSS standard(s). Operation is subject to the following two conditions: this device may not cause interference, and (2) this device must accept any interference, including interference that may cause undesired operation of the device.

Cet appareil numérique de la Classe B est conforme à la norme NMB-003 du Canada.

Cet appareil numérique de la Classe B respecte toutes les exigences du Règlement sur le matériel brouilleur du Canada.

Cet appareil est conforme aux normes CNR exemptes de licence d'Industrie Canada. Le fonctionnement est soumis aux deux conditions suivantes.

(1) cet appareil ne doit pas provoquer d'interférences et

(2) cet appareil doit accepter toute interférence, y compris celles susceptibles de provoquer un fonctionnement non souhaité de l'appareil.

## Canadian Department of Communications Statement

This digital apparatus does not exceed the Class B limits for radio noise emissions from digital apparatus set out in the Radio Interference Regulations of the Canadian Department of Communications.

This class B digital apparatus complies with Canadian ICES-003.

## VCCI: Japan Compliance Statement

### VCCI Class B Statement

#### 情報処理装置等電波障害自主規制について

この装置は、情報処理装置等電波障害自主規制協議会（VCCI）の基準に基づくクラスB情報技術装置です。この装置は家庭環境で使用することを目的としていますが、この装置がラジオやテレビジョン受信機に近接して使用されると、受信障害を引き起こすことがあります。

取扱説明書に従って正しい取り扱いをして下さい。

## KC: Korea Warning Statement

B급 기기 (가정용 방송통신기자재)

이 기기는 가정용(B급) 전자파적합기기로서 주로 가정에서 사용하는 것을 목적으로 하며, 모든 지역에서 사용할 수 있습니다.

\*당해 무선설비는 전파혼신 가능성이 있으므로 인명안전과 관련된 서비스는 할 수 없습니다.

## RF Equipment Notices

### CE: European Community Compliance Statement

The equipment complies with the RF Exposure Requirement 1999/519/EC, Council Recommendation of 12 July 1999 on the limitation of exposure of the general public to electromagnetic fields (0–300 GHz). This wireless device complies with the R&TTE Directive.

### Wireless Radio Use

This device is restricted to indoor use when operating in the 5.15 to 5.25 GHz frequency band.

### Exposure to Radio Frequency Energy

The radiated output power of the Wi-Fi technology is below the FCC radio frequency exposure limits. Nevertheless, it is advised to use the wireless equipment in such a manner that the potential for human contact during normal operation is minimized.

### FCC Bluetooth Wireless Compliance

The antenna used with this transmitter must not be colocated or operated in conjunction with any other antenna or transmitter subject to the conditions of the FCC Grant.

### Bluetooth Industry Canada Statement

This Class B device meets all requirements of the Canadian interference-causing equipment regulations.

Cet appareil numérique de la Class B respecte toutes les exigences du Règlement sur le matériel brouilleur du Canada.

### BSMI: Taiwan Wireless Statement

#### 無線設備的警告聲明

經型式認證合格之低功率射頻電機，非經許可，公司、商號或使用者均不得擅自變更射頻、加大功率或變更原設計之特性及功能。低功率射頻電機之使用不得影響飛航安全及干擾合法通信；經發現有干擾現象時，應立即停用，並改善至無干擾時方得繼續使用。前項合法通信指依電信法規定作業之無線通信。低功率射頻電機須忍受合法通信或工業、科學及醫療用電波輻射性電機設備之干擾。

於 5.25GHz 至 5.35GHz 區域內操作之  
無線設備的警告聲明

工作頻率 5.250 ~ 5.350GHz 該频段限於室內使用。

### Japan RF Equipment Statement

この製品は、周波数帯域5.15～5.35GHzで動作しているときは、室内においてのみ使用可能です。

### KC (RF Equipment)

대한민국 규정 및 준수

방통위 고시에 따른 고지사항

해당 무선설비는 운용 중 전파혼신 가능성이 있음,

이 기기는 인명안전과 관련된 서비스에 사용할 수 없습니다.

## Safety information



---

Disconnect the AC power and peripherals before cleaning. Wipe the Desktop PC using a clean cellulose sponge or chamois cloth dampened with solution of nonabrasive detergent and a few drops of warm water then remove any extra moisture with a dry cloth.

---

- **DO NOT** place on uneven or unstable work surfaces. Seek servicing if the casing has been damaged.
- **DO NOT** expose to dirty or dusty environments. **DO NOT** operate during a gas leak.
- **DO NOT** place or drop objects on top and do not shove any foreign objects into the Desktop PC.
- **DO NOT** expose to strong magnetic or electrical fields.
- **DO NOT** expose to or use near liquids, rain, or moisture. **DO NOT** use the modem during electrical storms.
- Battery safety warning: **DO NOT** throw the battery in fire. **DO NOT** short circuit the contacts. **DO NOT** disassemble the battery.
- Use this product in environments with ambient temperatures between 0°C (32°F) and 35°C (95°F).
- **DO NOT** cover the vents on the Desktop PC to prevent the system from getting overheated.
- **DO NOT** use damaged power cords, accessories, or other peripherals.
- To prevent electrical shock hazard, disconnect the power cable from the electrical outlet before relocating the system.
- Seek professional assistance before using an adapter or extension cord. These devices could interrupt the grounding circuit.
- Ensure that your power supply is set to the correct voltage in your area. If you are not sure about the voltage of the electrical outlet you are using, contact your local power company.
- If the power supply is broken, do not try to fix it by yourself. Contact a qualified service technician or your retailer.



## Conventions used in this guide

To ensure that you perform certain tasks properly, take note of the following symbols used throughout this manual.



**DANGER/WARNING:** Information to prevent injury to yourself when trying to complete a task.



**CAUTION:** Information to prevent damage to the components when trying to complete a task.



**IMPORTANT:** Instructions that you **MUST** follow to complete a task.



**NOTE:** Tips and additional information to help you complete a task.

## Where to find more information

Refer to the following sources for additional information and for product and software updates.

### ASUS websites

The ASUS website provides updated information on ASUS hardware and software products. Refer to the ASUS website [www.asus.com](http://www.asus.com).







### ASUS Local Technical Support

Visit ASUS website at <http://support.asus.com/contact> for the contact information of local Technical Support Engineer.

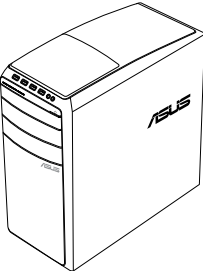

- 
- The user manual is located in the following folder in your Desktop PC:
  - C:\Program Files(X86)\ASUS\Manual
-

## Package contents

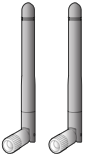
|   |   |   |
|---|---|---|
|  |  |   |
| ASUS Desktop PC   | Keyboard x1   |   |
|  |  |  |
| Mouse x1  | Power cord x1   | DVD/SDVD/RDVD x1 (optional)   |
|  |  |  |
| Installation Guide x1   | Warranty card x1  | Antenna x 1 (optional)<br>Antennas x 2 (optional)                                 |



- If any of the above items are damaged or missing, contact your retailer.
- The illustrated items above are for reference only. Actual product specifications may vary with different models.

# Chapter 1

## Getting started

### Welcome!

Thank you for purchasing the ASUS M51BC Desktop PC!

The ASUS M51BC Desktop PC provides cutting-edge performance, uncompromised reliability, and user-centric utilities. All these values are encapsulated in a stunningly futuristic and stylish system casing.



---

Read the ASUS Warranty Card before setting up your ASUS Desktop PC.

---

### Getting to know your computer



---

Illustrations are for reference only. The ports and their locations, and the chassis color vary with different models.

---

### Front panel

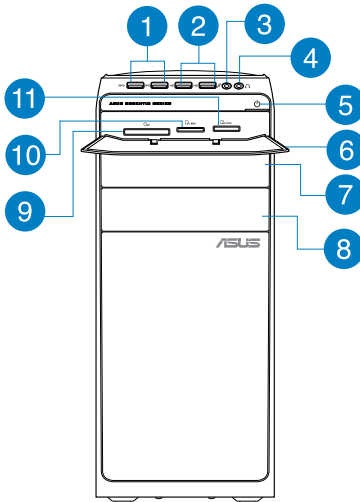

- 1 **USB 3.0 ports.** These Universal Serial Bus 3.0 (USB 3.0) ports connect to USB 3.0 devices such as a mouse, printer, scanner, camera, PDA, and others.



- 
- DO NOT connect a keyboard / mouse to any USB 3.0 port when installing Windows® operating system.
  - Due to USB 3.0 controller limitation, USB 3.0 devices can only be used under Windows® OS environment and after the USB 3.0 driver installation.
  - USB 3.0 devices can only be used as data storage only.
  - We strongly recommend that you connect USB 3.0 devices to USB 3.0 ports for faster and better performance for your USB 3.0 devices.
- 

- 2 **USB 2.0 ports.** These Universal Serial Bus 2.0 (USB 2.0) ports connect to USB 2.0 devices such as a mouse, printer, scanner, camera, PDA, and others.

- 3 **Microphone port.** This port connects to a microphone.

- 4 **Headphone port.** This port connects to a headphone or speaker. Supported by ASUS Audio Wizard.

- 5 **Power button.** Press this button to turn on your computer.

- 6 **Card readers' cover.** Open this cover to display the card reader slots.

- 7 **Optical disk drive bay.** There is an optical disk drive in this bay.

- 8 **Optical disk drive bay (empty).** Allows you to install an additional optical disk drive in this bay.

- 9 **CompactFlash® / Microdrive™ card slot.** Insert a CompactFlash® / Microdrive™ card into this slot.

- 10 **Secure Digital™ / MultiMediaCard slot.** Insert a Secure Digital™ / MultiMediaCard card into this slot.

- 11 **Memory Stick™ / Memory Stick Pro™ card slot.** Insert a Memory Stick™ / Memory Stick Pro™ card into this slot.

## Rear panel

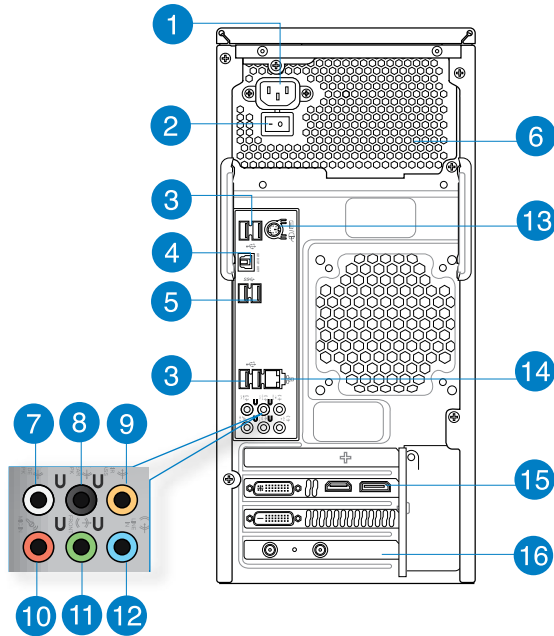

- 1 **Power connector.** Plug the power cord to this connector.



**RATING:** 115Vac/220-230Vac, 7A/4A, 60/50Hz.

- 2 **Power switch.** Switch to turn ON/OFF the power supply to your computer.
- 3 **USB 2.0 ports.** These Universal Serial Bus 2.0 (USB 2.0) ports connect to USB 2.0 devices such as a mouse, printer, scanner, camera, PDA, and others.
- 4 **Optical S/PDIF\_OUT port.** This port connects to an external audio output device via an optical S/PDIF cable.
- 5 **USB 3.0 ports.** These Universal Serial Bus 3.0 (USB 3.0) ports connect to USB 3.0 devices such as a mouse, printer, scanner, camera, PDA, and others.



- DO NOT connect a keyboard / mouse to any USB 3.0 port when installing Windows® operating system.
- Due to USB 3.0 controller limitation, USB 3.0 devices can only be used under Windows® OS environment and after the USB 3.0 driver installation.
- USB 3.0 devices can only be used as data storage only.
- We strongly recommend that you connect USB 3.0 devices to USB 3.0 ports for faster and better performance for your USB 3.0 devices.

- 6 Air vents.** These vents allow air ventilation.
- 7 Side Speaker Out port (gray).** This port connects to the side speakers in an 8-channel audio configuration.
- 8 Rear Speaker Out port (black).** This port connects to the rear speakers in a 4, 6, and 8-channel audio configuration.
- 9 Center/Subwoofer port (orange).** This port connects to the center/subwoofer speakers.
- 10 Microphone port (pink).** This port connects to a microphone.
- 11 Line Out port (lime).** This port connects to a headphone or speaker. In a 4, 6, or 8-channel configuration, the function of this port becomes Front Speaker Out.
- 12 Line In port (light blue).** This port connects to a tape, CD, DVD player, or other audio sources.



Refer to the audio configuration table below for the function of the audio ports in a 2, 4, 6, or 8-channel configuration.

### Audio 2, 4, 6, or 8-channel configuration

| Port       | Headset 2-channel | 4-channel         | 6-channel         | 8-channel         |
|------------|-------------------|-------------------|-------------------|-------------------|
| Light Blue | Line In           | Line In           | Line In           | Line In           |
| Lime       | Line Out          | Front Speaker Out | Front Speaker Out | Front Speaker Out |
| Pink       | Mic In            | Mic In            | Mic In            | Mic In            |
| Orange     | –                 | –                 | Center/Subwoofer  | Center/Subwoofer  |
| Black      | –                 | Rear Speaker Out  | Rear Speaker Out  | Rear Speaker Out  |
| Gray       | –                 | –                 | –                 | Side Speaker Out  |

- 13 **PS/2 Keyboard / Mouse Combo port (purple).** This port is for a PS/2 keyboard or mouse.
- 14 **LAN (RJ-45) port.** This port allows Gigabit connection to a Local Area Network (LAN) through a network hub.

**LAN port LED indications**

| Activity/Link LED |               | Speed LED |                    |
|-------------------|---------------|-----------|--------------------|
| Status            | Description   | Status    | Description        |
| OFF               | No link       | OFF       | 10Mbps connection  |
| ORANGE            | Linked        | ORANGE    | 100Mbps connection |
| BLINKING          | Data activity | GREEN     | 1Gbps connection   |

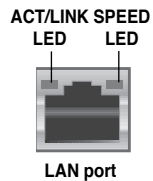

- 15 **ASUS Graphics Card (on selected models only).** The display output ports on this optional ASUS Graphics Card may vary with different models.
- 16 **ASUS WLAN Card (on selected models only).** This optional WLAN card allows your computer to connect to a wireless network.



DO NOT block the air vents on the chassis. Always provide proper ventilation for your computer.

## Setting up your computer

This section guides you through connecting the main hardware devices, such as the external monitor, keyboard, mouse, and power cord, to your computer.

### Connecting an external monitor

#### Using the ASUS Graphics Card (on selected models only)

Connect your monitor to the display output port on the discrete ASUS Graphics Card.

#### To connect an external monitor using the ASUS Graphics Card:

1. Connect a monitor to a display output port on the ASUS Graphics Card.
2. Plug the monitor to a power source.



The display output ports on the ASUS Graphics Card may vary with different models.

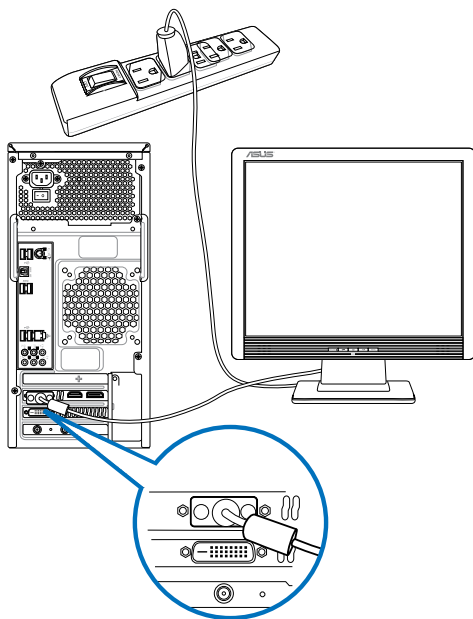

- If your computer comes with an ASUS Graphics Card, the graphics card is set as the primary display device in the BIOS. Hence, connect your monitor to a display output port on the graphics card.
- To connect multiple external monitors to your computer, refer to **Connecting multiple external monitors** in Chapter 4 of this user manual for details.



## Connecting a USB keyboard and a USB mouse

Connect a USB keyboard and a USB mouse to the USB ports on the rear panel of your computer.

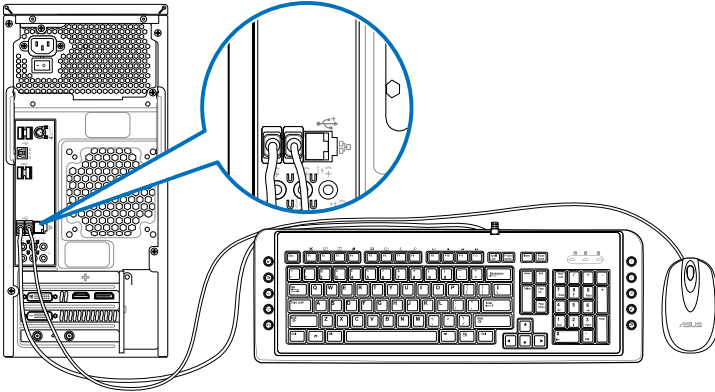

Connect your USB keyboard and USB mouse to the USB 2.0 ports.

## Connecting the power cord

Connect one end of the power cord to the power connector on the rear panel of your computer and the other end to a power source.

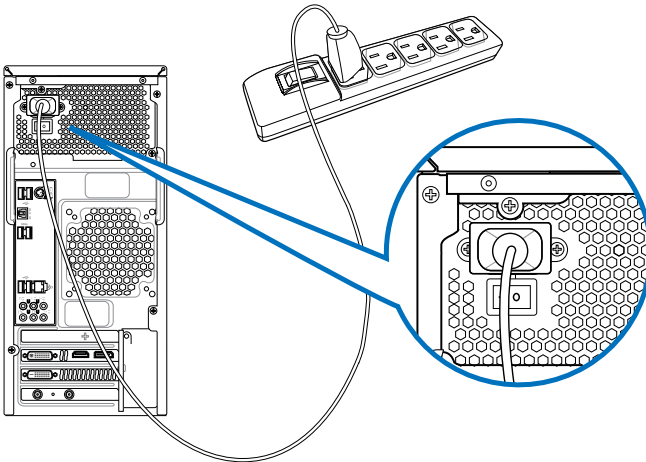

## Turning your computer ON/OFF

This section describes how to turn on/off your computer after setting up your computer.

### Turning your computer ON

To turn your computer ON:

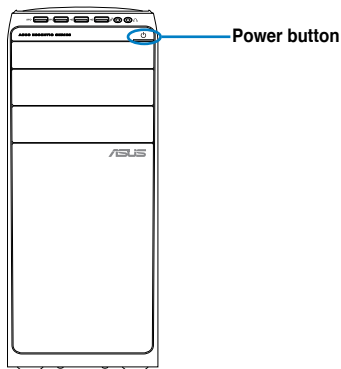

1. Turn on the power switch.
2. Turn your monitor ON.
3. Press the power button on your computer.



4. Wait until the operating system loads automatically.

### Turning your computer OFF

To turn your computer OFF on Windows® 7:

1. Close all running applications.
2. Click  on the Windows® desktop.
3. Click  to shut down the operating system.



---

For details on shutting down your Desktop PC on Windows® 8, refer to the section **Turning your Desktop PC OFF** in Chapter 3.

---

# Chapter 2

## Using Windows® 7

### Starting for the first time

When you start your computer for the first time, a series of screens appear to guide you in configuring the basic settings of your Windows® 7 operating system.

#### To start for the first time:

1. Turn your computer on. Wait for a few minutes until the **Set Up Windows** screen appears.
2. From dropdown list, select your language, then click **Next**.
3. From the dropdown lists, select your **Country or region**, **Time and currency**, and **Keyboard layout**, then click **Next**.
4. Key in unique names for the **user name** and **computer name**, then click **Next**.
5. Key in the necessary information to set up your password, then click **Next**. You may also click **Next** to skip this step without entering any information.



---

If you want to set up a password for your account later, refer to the section **Setting up a user account and password** in this chapter.

---

6. Carefully read the license terms. Tick **I accept the license terms** and click **Next**.
7. Select **Use recommended settings** or **Install important updates only** to set up the security settings for your computer. To skip this step, select **Ask me later**.
8. Review your date and time settings. Click **Next**. The system loads the new settings and restarts. You may now start using your computer.

## Using Windows® 7 desktop



---

Click the Start icon  > **Help and Support** to obtain more information about Windows® 7.

---

### Using the Start menu

The Start menu gives you access to programs, utilities, and other useful items on your computer. It also provides you with more information about Windows 7 through its **Help and Support** feature.

### Launching items from the Start menu

**To launch items from the Start menu:**

1. From the Windows® taskbar, click the Start icon .
2. From the Start menu, select the item that you want to launch.



---

You may pin programs that you want constantly displayed on the Start menu. For more details, refer to the section **Pinning programs on the Start menu or taskbar** on this chapter.

---

### Using the Getting Started item

The **Getting Started** item on the Start menu contains information about some basic tasks such as personalizing Windows®, adding new users, and transferring files to help you to familiarize yourself with using Windows® 7.

**To use the Getting Started item:**

1. From the Windows® taskbar, click the Start icon  to launch the Start menu.
2. Select **Getting Started**. The list of available tasks appears.
3. Select the task that you want to do.

### Using the taskbar

The taskbar allows you to launch and manage programs or items installed on your computer.

### Launching a program from the taskbar

**To launch a program from the taskbar:**

- From the Windows® taskbar, click an icon to launch it. Click the icon again to hide the program.



---

You may pin programs that you want constantly displayed on the taskbar. For more details, refer to the section **Pinning programs on the Start menu or taskbar** on this chapter.

---

## Pinning items on the jumplists

When you right-click an icon on the taskbar, a jumplist launches to provide you with quick access to the program's or item's related links. You may pin items on the jumplist such as favorite websites, often-visited folders or drives, or recently played media files.

### To pin items to the jumplist:

1. From the taskbar, right-click an icon.
2. From the jumplist, right-click the item that you want to pin, then select **Pin to this list**.

## Unpinning items from the jumplist

### To unpin items from the jumplist:

1. From the taskbar, right-click an icon.
2. From the jumplist, right-click the item that you want to remove from the jumplist, then select **Unpin from this list**.

## Pinning programs on the Start menu or taskbar

### To pin programs on the Start menu or taskbar:

1. From the Windows® taskbar, click the Start icon  to launch the Start menu.
2. Right-click the item that you want to pin on the Start menu or taskbar.
3. Select **Pin to Taskbar** or **Pin to Start menu**.





---

You may also right-click on the icon of a running program on the taskbar, then select **Pin this program to taskbar**.

---

## Unpinning programs from the Start menu

### To unpin programs from the Start menu:

1. From the Windows® taskbar, click the Start icon  to launch the Start menu.
2. From the Start menu, right-click the program that you want to unpin, then select **Remove from this list**.



## Unpinning programs from the taskbar

### To unpin programs from the taskbar:

1. From the taskbar, right-click the program that you want to remove from the taskbar, then select **Unpin this program from taskbar**.

## Using the notification area

By default, the notification area shows these three icons:

|   |  |
|---|--|
|  | <p><b>Action Center notification</b></p> <p>Click this icon to display all the alert messages/notifications and launch the Windows® Action Center.</p> |
|  | <p><b>Network connection</b></p> <p>This icon displays the connection status and signal strength of the wired or wireless network connection.</p>      |
|  | <p><b>Volume</b></p> <p>Click this icon to adjust the volume.</p>  |

### Displaying an alert notification

**To display an alert notification:**

- Click the Notification icon , then click the message to open it.



---

For more details, refer to the section **Using Windows® Action Center** in this chapter.

---

### Customizing icons and notifications

You may choose to display or hide the icons and notifications on the taskbar or on the notification area.

**To customize icons and notifications:**

1. From the notification area, click on the arrow icon .
2. Click **Customize**.
3. From the dropdown list, select the behaviors for the icons or items that you want to customize.

## Managing your files and folders

### Using Windows® Explorer

Windows® Explorer allows you to view, manage, and organize your files and folders.

#### Launching Windows® Explorer

**To launch Windows Explorer:**

1. From the Windows® taskbar, click the Start icon  to launch the Start menu.
2. Click **Computer** to launch Windows Explorer.

## Exploring files and folders

### To explore files and folders:

1. Launch Windows® Explorer.
2. From the navigation or view pane, browse for the location of your data.
3. From the breadcrumb bar, click the arrow to display the contents of the drive or folder.

## Customizing the file/folder view

### To customize the file/folder view:

1. Launch Windows Explorer.
2. From the navigation pane, select the location of your data.
3. From the toolbar, click the View icon .
4. From the View menu, move the slider to select how you want to view the file/folder.



---

You may also right-click anywhere on the View pane, click **View**, and select the view type that you want.

---

## Arranging your files

### To arrange your files:

1. Launch Windows Explorer.
2. From the **Arrange by** field, click to display the dropdown list.
3. Select your preferred arrangement type.

## Sorting your files

### To sort your files:

1. Launch Windows Explorer.
2. Right-click anywhere on the View pane.
3. From the menu that appears, select **Sort by**, then select your preferred sorting type.

## Grouping your files

### To group your files:

1. Launch Windows Explorer.
2. Right-click anywhere on the View pane.
3. From the menu that appears, select **Group by**, then select your preferred grouping type.

## Adding a new folder

### To add a new folder:

1. Launch Windows Explorer.
2. From the toolbar, click **New folder**.
3. Key in a name for the new folder.



---

You may also right-click anywhere on the View pane, click **New > Folder**.

---

## Backing up your files

### Setting up a backup

#### To set up a backup:

1. Click  > **All Programs > Maintenance > Backup and Restore**.
2. Click **Set up backup**. Click **Next**.
3. Select your backup destination. Click **Next**.
4. Select **Let Windows choose (recommended)** or **Let me choose as your backup mode**.



---

If you select **Let Windows choose**, Windows will not back up your programs, FAT-formatted files, Recycle Bin files, or temporary files that are 1GB or more.

---

5. Follow the onscreen instructions to finish the process.

## Restoring your system settings

The Windows® System Restore feature creates a restore point where the computer's system settings are stored at certain time and date. It allows you to restore or undo changes to your computer's system settings without affecting your personal data.

### To restore your system:

1. Close all running applications.
2. Click  > **All Programs > Accessories > System Tools > System Restore**.
3. Follow the onscreen instructions to complete the process.



## Protecting your computer

### Using Windows® 7 Action Center

Windows® 7 Action Center provides you with alert notifications, security information, system maintenance information, and the option to automatically troubleshoot and fix some common computer problems.



---

You may customize the notifications. For more details, refer to the previous section **Customizing icons and notifications** in this chapter.

---

### Launching Windows® 7 Action Center

To launch Windows® 7 Action Center:

1. To launch Windows® 7 Action Center, click the Notification icon , then click **Open Action Center**.
2. From Windows® 7 Action Center, click the task that you want to do.

### Using Windows® Update

Windows Update allows you to check and install the latest updates to enhance the security and performance of your computer.

### Launching Windows® Update

To launch Windows® Update:

1. From the Windows® taskbar, click the Start icon  to launch the Start menu.
2. Select **All Programs > Windows Update**.
3. From the Windows® Update screen, click the task that you want to do.

### Setting up a user account and password

You may create user accounts and passwords for people who will use your computer.

### Setting up a user account

To set up a user account:

1. From the Windows® taskbar, click  > **Getting Started > Add new users**.
2. Select **Manage another account**.
3. Select **Create a new account**.
4. Key in the name of the new user.
5. Select either **Standard user** or **Administrator** as the user type.
6. When done, click **Create Account**.

## Setting up a user's password

### To set up a user's password:

1. Select the user that you would like to set a password.
2. Select **Create a password**.
3. Key in a password and confirm it. Key in your password's hint.
4. When done, click **Create password**.

## Activating the anti-virus software

Trend Micro Internet Security is pre-installed on your computer. It is a third-party anti-virus software protecting your computer from virus. It is purchased separately. You have a 30-day trial period after activating it.

### To activate Trend Micro Internet Security:

1. Run the Trend Micro Internet Security application.
2. Carefully read the license terms. Click **Agree & Activate**.
3. Input your e-mail address and select your location. Click **Next**.
4. Click Finish to complete the activation.

## Getting Windows® Help and Support

Windows® Help and Support provides you with guides and answers in using the applications in Windows® 7 platform.

To launch Windows® Help and Support, click  > **Help and Support**.



---

Ensure that you are connected to the Internet to obtain the latest Windows® online help.

---

# Chapter 3

## Using Windows® 8

### Starting for the first time

When you start your computer for the first time, a series of screens appear to guide you in configuring the basic settings of your Windows® 8 operating system.

#### To start for the first time:

1. Turn your computer on. Wait for a few minutes until the setup screen appears.
2. Carefully read the license terms. Tick **I accept the license terms for using Windows** and click **Accept**.
3. Follow the next onscreen instructions to configure the following basic items:
  - Personalize
  - Settings
4. Once you are done configuring the basic items, the Windows® 8 video tutorial appears. Watch this tutorial to learn more about Windows® 8 functionalities.



---

For details on using Windows® 8, refer to the next sections.

---

## Using the Windows® UI

The Windows® User Interface (UI) is the tile-based display used in Windows® 8. It includes the following features you can use while working on your Desktop PC.

### Start screen

The Start screen appears after successfully signing in to your user account. It helps organize all the programs and applications you need in just one place.

You can press the Windows key  to launch the Start screen from any apps.

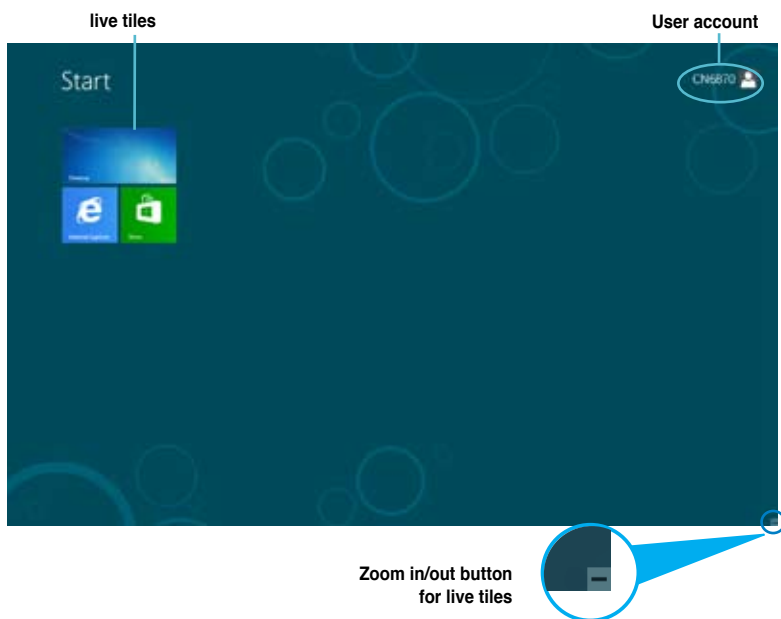

### Windows® apps

These are apps pinned on the Start screen and displayed on tiled-format for easy access.



---

A screen resolution of 1024 x 768 pixels or higher is required to run Windows® apps.

---



---

Some apps require signing in to your Microsoft account before they are fully launched.

---

## Hotspots

Onscreen hotspots allow you to launch programs and access the settings of your Desktop PC. The functions in these hotspots can be activated using your mouse.

### Hotspots on a running app

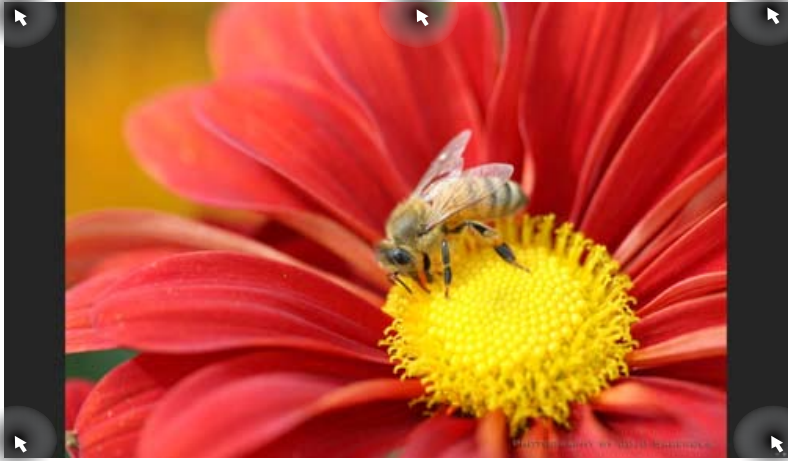

### Hotspots on the Start screen

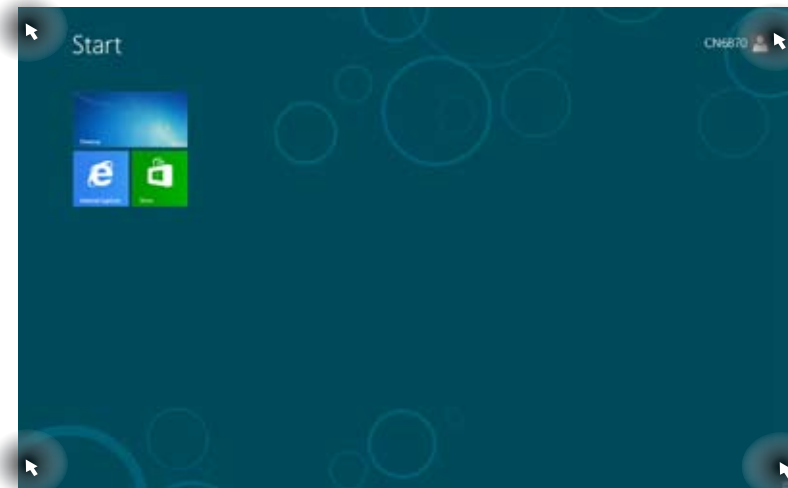

Refer to the next page for the Hotspots' functions.

| Hotspot                      | Action  |
|------------------------------|---|
| upper left corner            | <p>Hover your mouse pointer then click on the recent app's thumbnail to go back to that app.</p> <p>Move your mouse pointer down to display all the running apps.</p>   |
| lower left corner            | <p><b>From a running app screen:</b><br/>Hover your mouse pointer then click on the Start screen's thumbnail to go back to the Start screen.</p> <p><b>NOTE:</b> You can also press the Windows key  on your keyboard to go back to the Start screen.</p> <p><b>From the Start screen:</b><br/>Hover your mouse pointer then click on the recent app's thumbnail to go back to that app.</p> |
| top                          | <p>Hover your mouse pointer until it changes to a hand icon. Drag then drop the app to a new location.</p> <p><b>NOTE:</b> This hotspot function only works on a running app or when you want to use the Snap feature. For more details, refer to <b>Snap feature</b> under <b>Working with Windows® apps</b>.</p>  |
| upper and lower right corner | <p>Hover your mouse pointer to launch the Charms bar.</p>   |

## Working with Windows® apps

Use your Desktop PC's keyboard or mouse to launch and customize your apps.

### Launching apps

- Position your mouse pointer on an app then left-click once to launch it.
- Press <Tab> twice then use the arrow keys to browse through the apps. Press <Enter> to launch your selected app.

### Customizing apps

You can move, resize, or unpin apps from the Start screen using the following steps.

- To move an app, drag and drop the app to a new location.

### Resizing apps

Right-click the app to activate its settings bar then click **Smaller**.

### Unpinning apps

To unpin an app from the Start screen, right-click on the app to activate its settings bar then click **Unpin from Start**.

### Closing apps

- Move your mouse pointer on the top side of the launched app then wait for the pointer to change to a hand icon.
- Drag then drop the app to the bottom of the screen to close it.
- From the running app's screen, press <Alt> + <F4>.

## Accessing the All Apps screen

From the All Apps screen, you can configure an apps settings or pin an app to the Start screen or to the Desktop mode taskbar.

## Launching the All Apps screen

Right-click on the Start screen or press  + <Z>, and click the All Apps icon.

## Pinning an app on the Start screen

1. Launch the All Apps screen.
2. From the All Apps screen, right-click an app to display its settings bar.
3. From the settings bar, click **Pin to Start**.



## Charms bar

The Charms bar is a toolbar that can be triggered on the right side of your screen. It consists of several tools that allow you to share applications and provide quick access for customizing the settings of your Desktop PC.



Charms bar

## Launching the Charms bar



When called out, the Charms bar initially appears as a set of white icons. The image above shows how the Charms bar looks like once activated.

Use your Desktop PC's mouse or keyboard to launch the Charms bar.

- Move your mouse pointer on the upper or lower right corner of the screen.
- Press  + <C>.

## Inside the Charms bar

---



### Search

This tool allows you to look for files, applications, or programs in your Desktop PC.



### Share

This tool allows you to share applications via social networking sites or email.



### Start

This tool reverts the display back to the Start screen. From the Start screen, you can also use this to revert back to a recently opened app.



### Devices

This tool allows you to access and share files with the devices attached to your Desktop PC such as an external display or printer.



### Settings

This tool allows you to access the PC settings of your Desktop PC.

---

## Snap feature

The Snap feature displays two apps side-by-side, allowing you to work or switch between apps.



A screen resolution of at least 1366 x 768 pixels is required to use the Snap feature.



Snap bar

## Using Snap



### To use Snap:

1. Use your Desktop PC's mouse or keyboard to activate Snap onscreen.

#### Using your mouse















- a) Click on an app to launch it.
- b) Hover the mouse pointer on the top side of your screen.
- c) Once the pointer changes to a hand icon, drag and drop the app to the right or left side of the display panel.





#### Using your keyboard

- Launch an app then press  + < . > to activate the Snap bar. The first app would automatically be placed in the smaller display area.
2. Launch another app. This second app will automatically appear in the bigger display area.
  3. To switch between apps, press  + <J>.

## Other keyboard shortcuts

Using your keyboard, you can also use the following shortcuts to help you launch applications and navigate Windows® 8.

|   |   |
|---|---|
|          | Switches between the Start screen and the last running app. |
|  + <D>   | Launches the desktop.                                       |
|  + <E>   | Launches the Computer window on the desktop.                |
|  + <F>   | Opens the File search pane.                                 |
|  + <H>   | Opens the Share pane.                                       |
|  + <I>   | Opens the Settings pane.                                    |
|  + <K>   | Opens the Devices pane.                                     |
|  + <L>   | Activates the Lock screen.                                  |
|  + <M>   | Minimizes the Internet Explorer window.                     |
|  + <P>   | Opens the Second screen pane.                               |
|  + <Q>  | Opens the Apps search pane.                                 |
|  + <R> | Opens the Run window.                                       |
|  + <U> | Opens Ease of Access Center.                                |
|  + <W> | Opens the Settings search pane.                             |
|  + <X> | Opens a menu box of Windows tools                           |

|  |  |
|--|--|
|  + <+>      | Launches the magnifier and zooms in your screen. |
|  + <->      | Zooms out your screen.                           |
|  + <,>      | Allows you to peek at the desktop.               |
|  + <Enter>  | Opens the Narrator Settings.                     |
|  + <Prt Sc> | Enables the print screen function.               |

## Turning your Desktop PC OFF

### To turn your Desktop PC OFF:

Do any of the following to shut down your Desktop PC:

- From the Charms bar, click **Settings** > **Power** > **Shut down** to do a normal shutdown.
- From the login screen, click **Power** > **Shutdown**.
- If your Desktop PC is unresponsive, press and hold the power button for at least four (4) seconds until your Desktop PC turns off.

## Putting your Desktop PC to sleep

To put your Desktop PC on Sleep mode, press the Power button once.

## Entering the BIOS Setup

BIOS (Basic Input and Output System) stores system hardware settings that are needed for system startup in the Desktop PC.

In normal circumstances, the default BIOS settings apply to most conditions to ensure optimal performance. Do not change the default BIOS settings except in the following circumstances:

- An error message appears on the screen during the system bootup and requests you to run the BIOS Setup.
- You have installed a new system component that requires further BIOS settings or update.



---

Inappropriate BIOS settings may result to instability or boot failure. We strongly recommend that you change the BIOS settings only with the help of a trained service personnel.

---

### Quickly enter the BIOS

Windows® 8 boot time is quite fast, so we developed the following ways for you to quickly access the BIOS:

- Press the power button for at least four seconds to shut down your Desktop PC, then press the power button again to turn your Desktop PC back on, and press <Del> during POST.
- When your Desktop PC is off, disconnect the power cord from your Desktop PC's power connector. Reconnect the power cord and press the power button to turn on your Desktop PC. Press <Del> during POST.



---

POST (Power-On Self Test) is a series of software controlled diagnostic tests that run when you turn on your Desktop PC.

---

# Chapter 4

## Connecting devices to your computer

### Connecting a USB storage device

This desktop PC provides USB 2.0/1.1 and USB 3.0 ports on both the front and rear panels. The USB ports allow you to connect USB devices such as storage devices.

#### To connect a USB storage device:

- Insert the USB storage device to your computer.

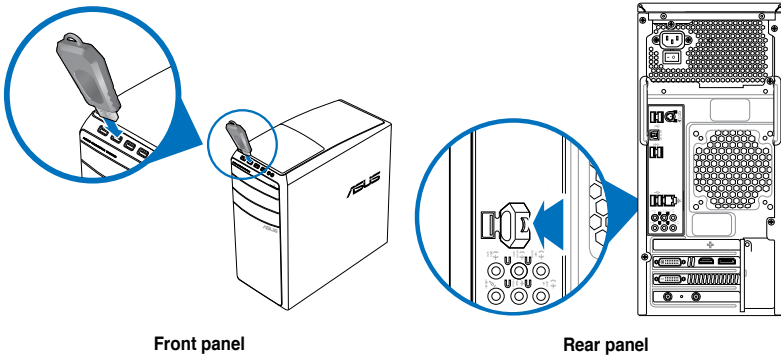

#### To remove a USB storage device on Windows® 7:

1. Click  from the Windows notification area on your computer, then click **Eject USB2.0 FlashDisk** or **Eject USB3.0 FlashDisk** if you are using the USB3.0 flash drive or USB3.0-compatible devices.
2. When the **Safe to Remove Hardware** message pops up, remove the USB storage device from your computer.

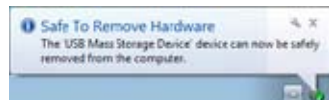
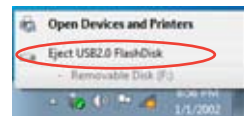

### To remove a USB storage device on Windows® 8:

1. From the Start screen, click **Desktop** to launch the Desktop Mode.
2. Click  from the taskbar, then click **Eject [Name of USB Drive]**.
3. When the **Safe to Remove Hardware** message pops up, remove the USB storage device from your computer.

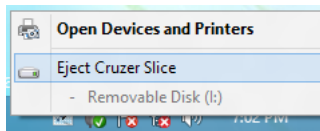

DO NOT remove a USB storage device when data transfer is in progress. Doing so may cause data loss or damage the USB storage device.

## Connecting microphone and speakers

This desktop PC comes with microphone ports and speaker ports on both the front and rear panels. The audio I/O ports located on the rear panel allow you to connect 2-channel, 4-channel, 6-channel, and 8-channel stereo speakers.

### Connecting Headphone and Mic

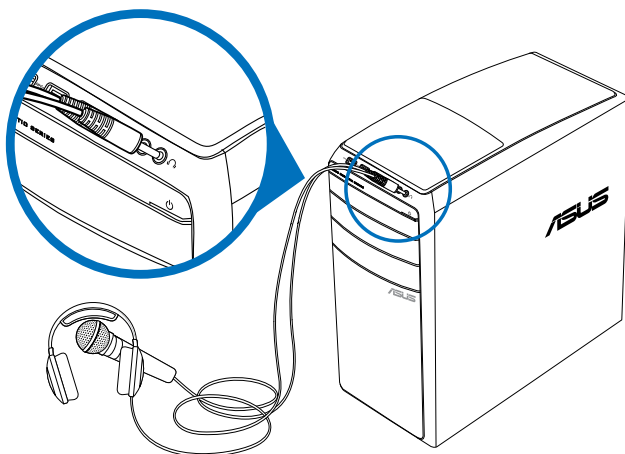



**Connecting 2.1-channel Speakers**

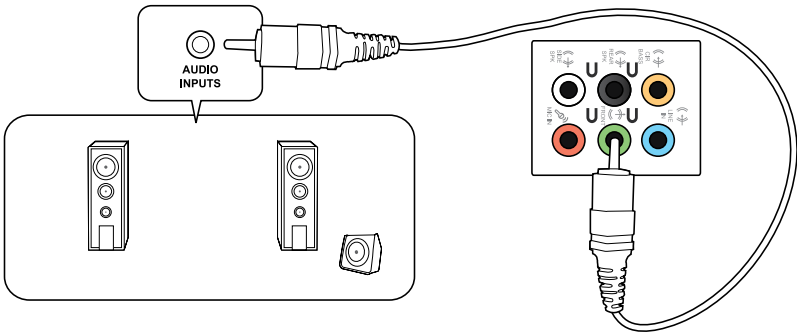

**Connecting 4.1-channel Speakers**

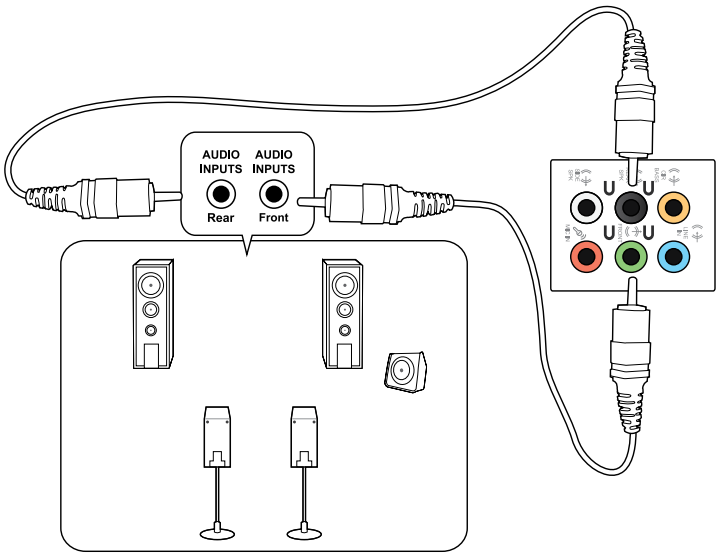

## Connecting 6-channel Speakers

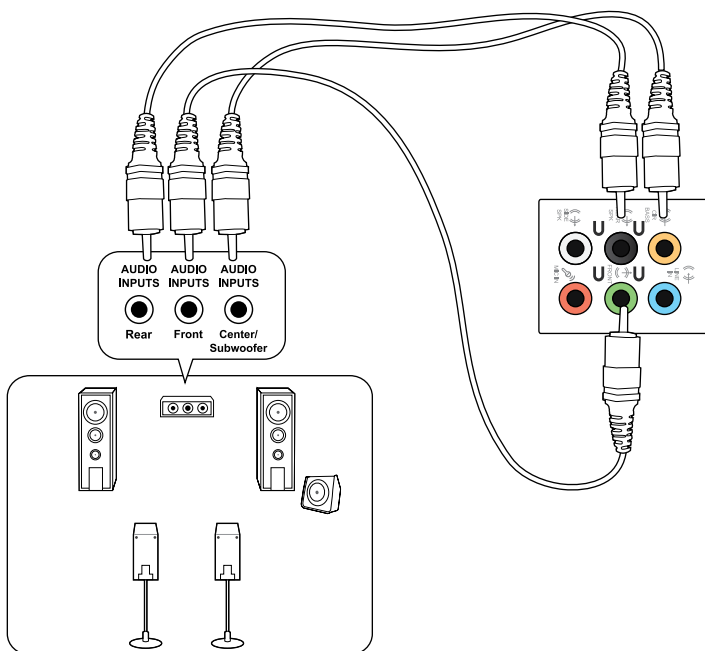

## Connecting 8-channel Speakers

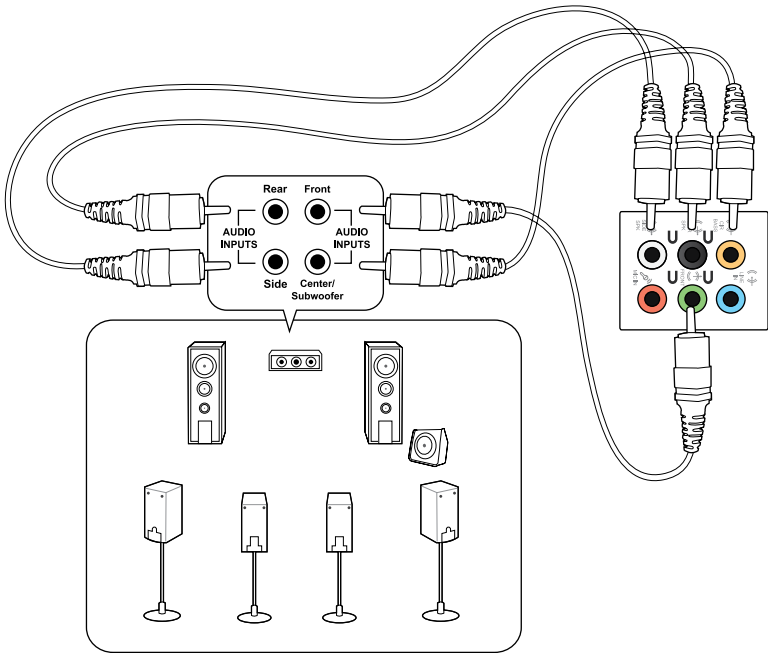

## Connecting multiple external displays

Your desktop PC may come with VGA, HDMI, or DVI ports and allows you to connect multiple external displays.



---

When a graphics card is installed in your computer, connect the monitors on the output ports of the graphics card.

---

### Setting up multiple displays

When using multiple monitors, you are allowed to set display modes. You can use the additional monitor as a duplicate of your main display, or as an extension to enlarge your Windows desktop.

#### To set up multiple displays:

1. Turn off your computer.
2. Connect the two monitors to your computer and connect the power cords to the monitors. Refer to **Setting up your computer** section in Chapter 1 for details on how to connect a monitor to your computer.

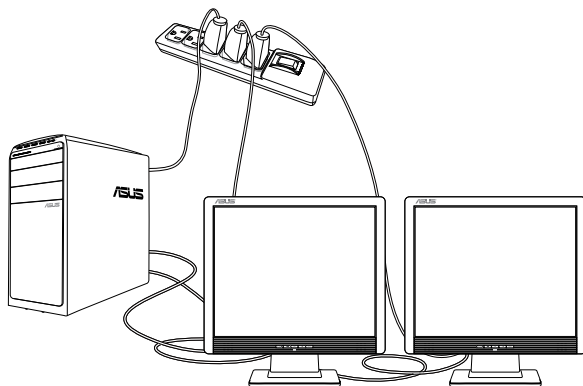

---

For some graphic cards, only the monitor that is set to be the primary display has display during POST. The dual display function works only under Windows.

---

3. Turn on your computer.
4. Do any of the following to open the **Screen Resolution** setting screen:

#### **On Windows® 7:**

- Click  > **Control Panel > Appearance and Personalization > Display > Change display settings.**
- Right click anywhere on your Windows desktop. When the pop-up menu appears, click **Personalize > Display > Change display settings.**

#### **On Windows® 8:**

##### ***From the Start screen***

- a) Launch the All Apps screen and pin Control Panel on the Start screen.



---

For details, refer to **Pinning an app on the Start screen** from the section **Working with Windows® apps.**

---

- b) From the Control Panel, click **Adjust screen resolution** under **Appearance and Personalization.**

##### ***From the Desktop mode screen***

- a) Launch the Desktop mode from the Start screen.
  - b) Right click anywhere on your Desktop mode screen. When the pop-up menu appears, click **Personalize > Display > Change display settings.**
5. Select the display mode from the **Multiple displays:** drop-down list.

#### **On Windows® 7:**

- **Duplicate these displays:** Select this option to use the additional monitor as a duplicate of your main display.
- **Extend these displays:** Select this option to use the additional monitor as an extension display. This increases your desktop space.
- **Show desktop only on 1 / 2:** Select this option to show desktop only on monitor 1 or monitor 2.
- **Remove this display:** Select this options to remove the selected display.

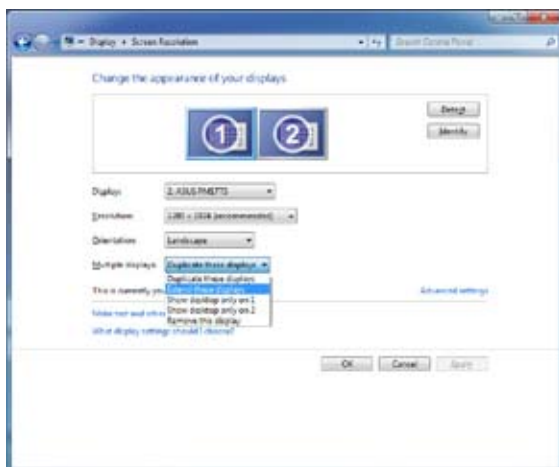

### On Windows® 8:

- **Duplicate these displays:** Select this option to use the additional monitor as a duplicate of your main display.
  - **Extend these displays:** Select this option to use the additional monitor as an extension display. This increases your desktop space.
  - **Show desktop only on 1 / 2:** Select this option to show desktop only on monitor 1 or monitor 2.



6. Click **Apply** or **OK**. Then click **Keep Changes** on the confirmation message.

## Connecting an HDTV

Connect a High Definition TV (HDTV) to the HDMI port of your computer.



- You need an HDMI cable to connect the HDTV and the computer. The HDMI cable is purchased separately.
- To get the best display performance, ensure that your HDMI cable is less than 15 meters.

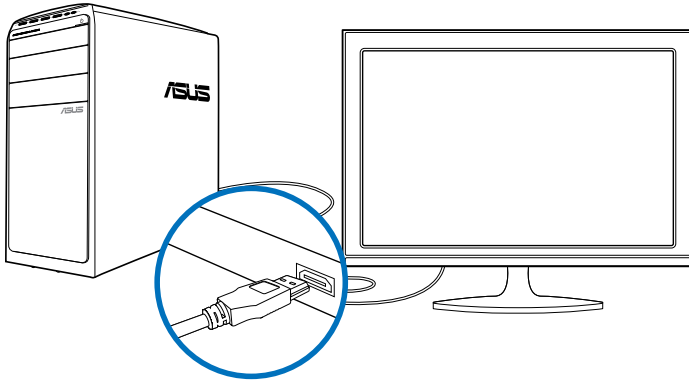





# Chapter 5

## Using your computer

### Proper posture when using your Desktop PC

When using your Desktop PC, maintaining the proper posture is necessary to prevent strain to your wrists, hands, and other joints or muscles. This section provides you with tips on avoiding physical discomfort and possible injury while using and fully enjoying your Desktop PC.



#### To maintain the proper posture:

- Position your computer chair to make sure that your elbows are at or slightly above the keyboard to get a comfortable typing position.
- Adjust the height of your chair to make sure that your knees are slightly higher than your hips to relax the backs of your thighs. If necessary, use a footrest to raise the level of your knees.
- Adjust the back of your chair so that the base of your spine is firmly supported and angled slightly backward.
- Sit upright with your knees, elbows and hips at an approximately 90° angle when you are at the PC.
- Place the monitor directly in front of you, and turn the top of the monitor screen even with your eye level so that your eyes look slightly downward.
- Keep the mouse close to the keyboard, and if necessary, use a wrist rest for support to reduce the pressure on your wrists while typing.
- Use your Desktop PC in a comfortably-lit area, and keep it away from sources of glare such as windows and straight sunlight.
- Take regular mini-breaks from using your Desktop PC.

## Using the memory card reader

Digital cameras and other digital imaging devices use memory cards to store digital picture or media files. The built-in memory card reader on the front panel of your system allows you to read from and write to different memory card drives.

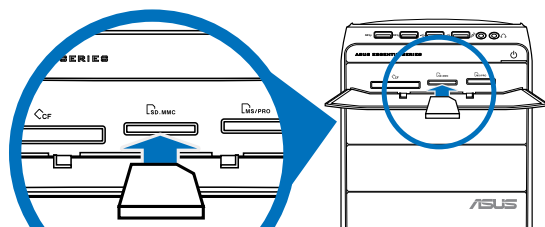

### To use the memory card:

1. Insert the memory card into the card slot.



- A memory card is keyed so that it fits in only one direction. **DO NOT** force a card into a slot to avoid damaging the card.
- You can place media in one or more of the card slots and use each media independently. Place only one memory card in a slot at one time.

2. Select a program from the AutoPlay window to access your files.



- On Windows® 7, if AutoPlay is NOT enabled in your computer, click Windows® 7 **Start** button on the taskbar, click **Computer**, and then double-click the memory card icon to access the data on it.
- On Windows® 8, if AutoPlay is NOT enabled in your computer, hover your mouse pointer over the lower left corner of Windows® desktop then right-click on the Start screen's thumbnail. From the popup menu, click **File Explorer**, and then double-click the memory card icon to access the data on it.
- Each card slot has its own drive icon which is displayed on the **Computer** screen.

3. When finished, right-click the memory card drive icon on the **Computer** screen, click **Eject**, and then remove the card.



On Windows® 8, hover your mouse pointer over the lower left corner of Windows® desktop then right-click on the Start screen's thumbnail. From the popup menu, click **File Explorer** to open the **Computer** screen.



Never remove cards while or immediately after reading, copying, formatting, or deleting data on the card or else data loss may occur.



To prevent data loss, use "Safely Remove Hardware and Eject Media" in the Windows® notification area before removing the memory card.

## Using the optical drive

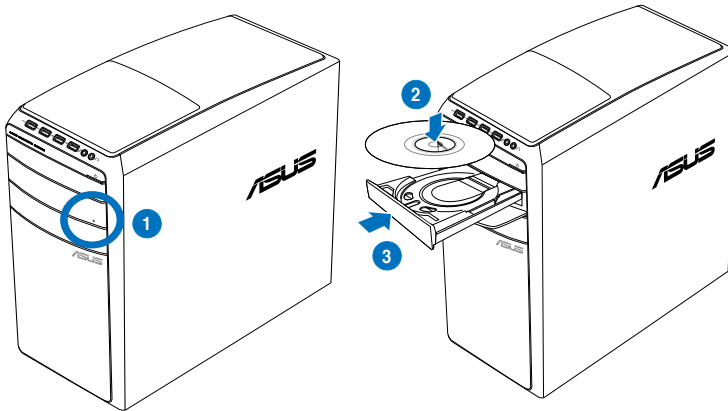

### Inserting an optical disc

#### To insert an optical disc:

1. While your system is on, press the eject button below the drive bay cover to open the tray.
2. Place the disc to the optical drive with the label side facing up.
3. Push the tray to close it.
4. Select a program from the AutoPlay window to access your files.



If AutoPlay is NOT enabled in your computer, to access the data on an optical disc:

- On Windows® 7, click the **Start > Computer**, and double-click the CD/DVD drive icon.
- On Windows® 8, hover your mouse pointer over the lower left corner of Windows® desktop then right-click on the Start screen's thumbnail. From the popup menu, click **File Explorer**, and then double-click the CD/DVD drive icon.

### Removing an optical disc

#### To remove an optical disc:

1. While the system is on, do either of the following to eject the tray:
  - Press the eject button below the drive bay cover.
  - Right-click the CD/DVD drive icon on the **Computer** screen, and click **Eject**.



To open the **Computer** screen on Windows® 8, hover your mouse pointer over the lower left corner of Windows® desktop then right-click on the Start screen's thumbnail. From the popup menu, click **File Explorer** to open the **Computer** screen.

2. Remove the disc from the disc tray.

## Using the keyboard (on selected models only)



The keyboard varies with models. The illustrations on this section are for reference only.

### ASUS KB34211 modern wired keyboard

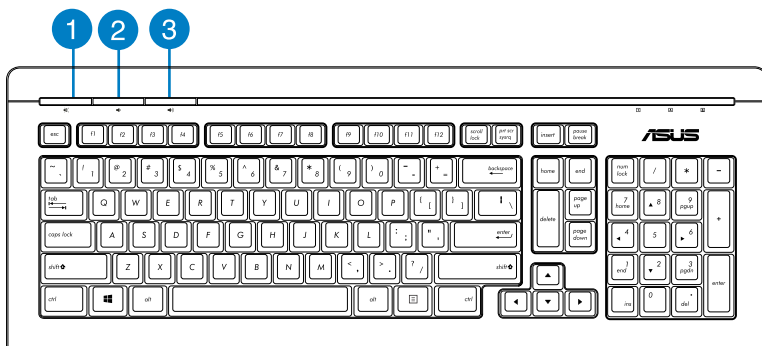

| Hot keys | Description                          |
|----------|--------------------------------------|
| 1        | Turns the volume's mute mode on/off. |
| 2        | Decreases the system volume.         |
| 3        | Increases the system volume.         |

### ASUS PK1100 keyboard

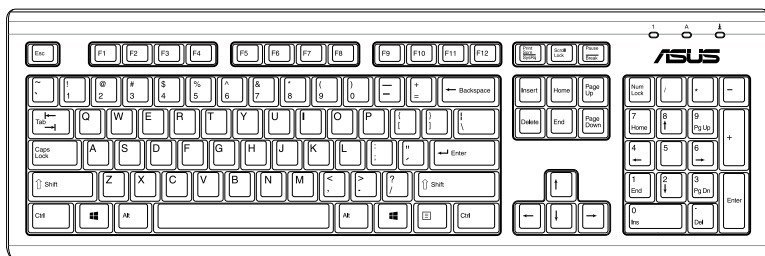

# Chapter 6

## Connecting to the Internet

### Wired connection

Use an RJ-45 cable to connect your computer to a DSL/cable modem or a local area network (LAN).

#### Connecting via a DSL/cable modem

To connect via a DSL/cable modem:

1. Set up your DSL/cable modem.



---

Refer to the documentation that came with your DSL/cable modem.

---

2. Connect one end of an RJ-45 cable to the LAN (RJ-45) port on the rear panel of your computer and the other end to a DSL/cable modem.

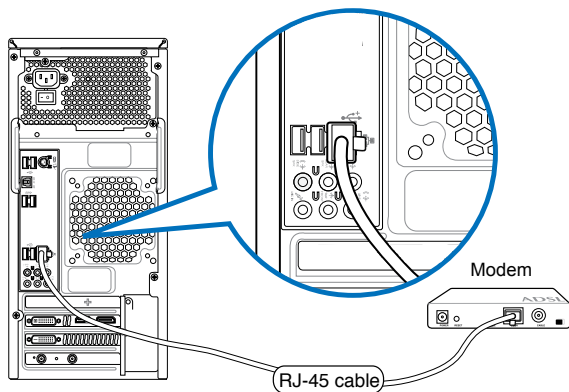

3. Turn on the DSL/cable modem and your computer.
4. Configure the necessary Internet connection settings.



- 
- For more details, refer to the section **Configuring the network connection**.
  - Contact your Internet Service Provider (ISP) for details or assistance in setting up your Internet connection.
-

## Connecting via a local area network (LAN)

### To connect via a LAN:

1. Connect one end of an RJ-45 cable to the LAN (RJ-45) port on the rear panel of your computer and the other end to your LAN.

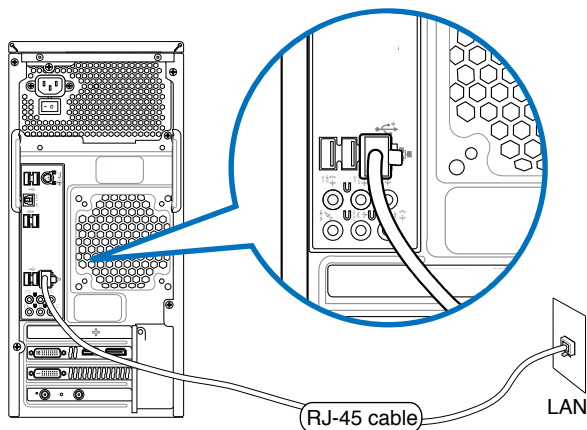

2. Turn on your computer.
3. Configure the necessary Internet connection settings.



- 
- For more details, refer to the section **Configuring the network connection**.
  - Contact your Internet Service Provider (ISP) for details or assistance in setting up your Internet connection.
-

## Configuring the network connection

### Configuration options on Windows® 7

#### Configuring a dynamic IP/PPPoE network connection

To configure a dynamic IP/PPPoE network connection:

1. Go to **Start > Control Panel > Network and Sharing Center**.
2. From the Network and Sharing Center screen, click **Change Adapter settings**.
3. Right-click on your LAN and select **Properties**.



4. Select **Internet Protocol Version 4 (TCP/IPv4)**, then click **Properties**.
5. Select **Obtain an IP address automatically** if you want the IP settings to be assigned automatically. Otherwise, select **Use the following IP address:** and key in **IP address** and **Subnet mask**.
6. Select **Obtain DNS server address automatically** if you want the DNS server settings to be assigned automatically. Otherwise, select **Use the following DNS server addresses:** and key in the **Preferred and Alternate DNS server**.
7. Click **OK** when done.





Continue to the next steps if you are using PPPoE connection.

8. Return to the **Network and Sharing Center** and then click **Set up a new connection or network**.

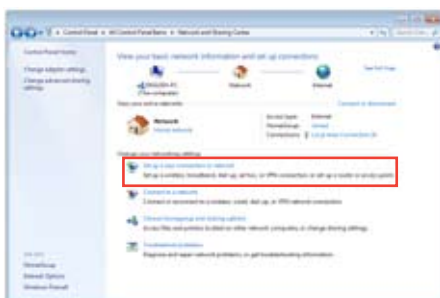

9. Select **Connect to the Internet** and click **Next**.

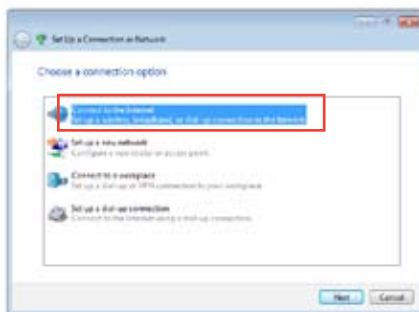

10. Select **Broadband (PPPoE)** and click **Next**.





11. Enter your User name and, Password, and Connection name. Click **Connect**.
12. Click **Close** to finish the configuration.
13. Click the network icon in the taskbar and click the connection you just created.
14. Enter your user name and password. Click **Connect** to connect to the Internet.

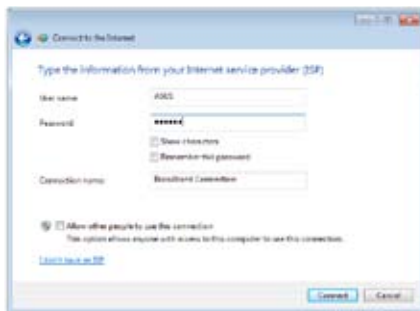

## Configuring a static IP network connection

To configure a static IP network connection :

1. Repeat steps 1 to 4 of the previous section.
2. Click **Use the following IP address**.
3. Enter the IP address, Subnet mask and Gateway from your service provider.
4. If needed, enter the preferred DNS Server address and alternative address.
5. When done, click **OK**.





## Configuration options on Windows® 8

### Configuring a dynamic IP/PPPoE network connection

To configure a dynamic IP/PPPoE network connection:

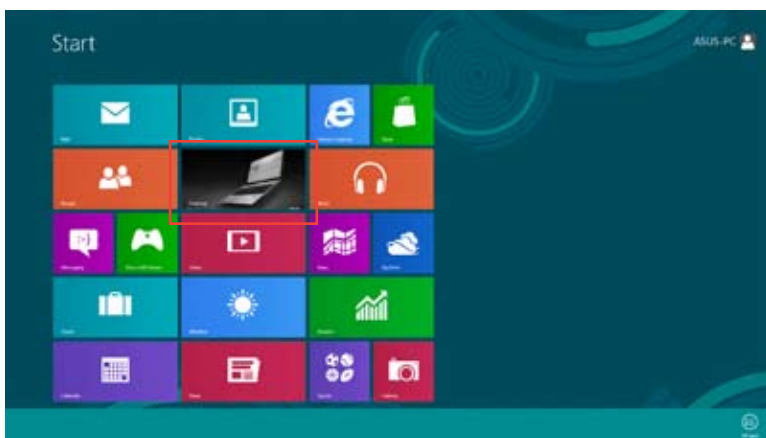
1. From the Start screen, click **Desktop** to launch the Desktop mode.



2. From the Windows® taskbar, right-click the network icon  and click **Open Network and Sharing Center**.
3. From the Open Network and Sharing Center screen, click **Change Adapter settings**.
4. Right-click on your LAN and select **Properties**.
5. Click **Internet Protocol Version 4(TCP/IPv4)** and click **Properties**.

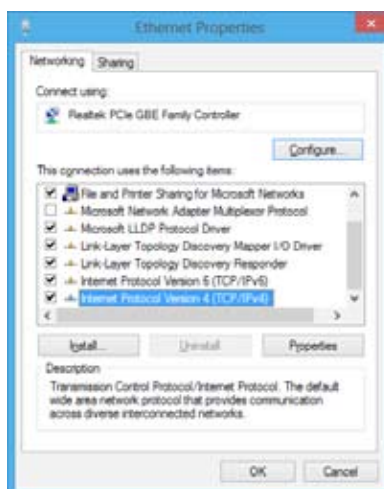

- Click **Obtain an IP address automatically** and click **OK**.



Continue to the next steps if you are using PPPoE connection.

- Return to the **Network and Sharing Center** and then click **Set up a new connection or network**.



- Select **Connect to the Internet** and click **Next**.

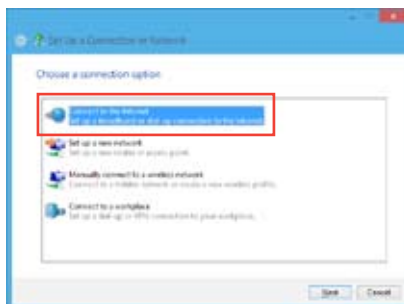

9. Select **Broadband (PPPoE)** and click **Next**.

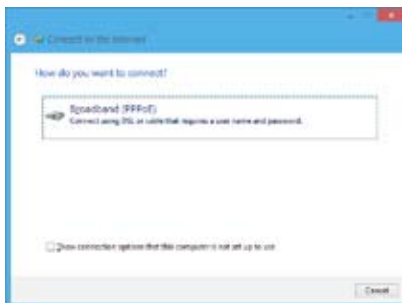

10. Enter your User name and, Password, and Connection name. Click **Connect**.
11. Click **Close** to finish the configuration.
12. Click the network icon in the taskbar and click the connection you just created.
13. Enter your user name and password. Click **Connect** to connect to the Internet.



## Configuring a static IP network connection

To configure a static IP network connection:

1. Repeat steps 1 to 4 of the previous section.
2. Click **Use the following IP address**.
3. Enter the IP address, Subnet mask and Gateway from your service provider.
4. If needed, enter the preferred DNS Server address and alternative address.
5. When done, click **OK**.



## Wi-Fi connection (on selected models only)

Connect your computer to the Internet through a wireless connection.



---

To establish a Wi-Fi connection, you need to connect to a wireless access point (AP).

---

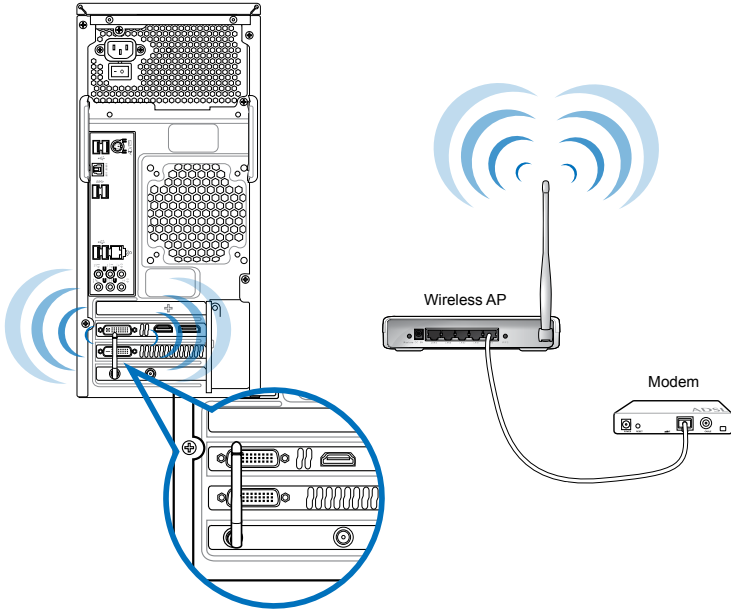



- 
- To increase the range and sensitivity of the wireless radio signal, connect the external antennas to the antenna connectors on the ASUS WLAN Card.
  - Place the antennas on the top of your computer for the best wireless performance.
  - The external antennas are optional items.
-

## Connecting to a Wi-Fi network

### Windows® 7

#### To connect to a Wi-Fi network:

1. Click the network icon  in the notification area to display the available wireless networks.
2. Select the wireless network that you want to connect to, then click **Connect**.
3. You may need to key in the network security key for a secured wireless network, then click **OK**.
4. Wait while your computer is connecting to the wireless network.
5. The wireless connection is established successfully. The connection status is displayed and the network icon displays the connected  status.

### Windows® 8

#### To connect to a Wi-Fi network:

1. Do any of the following to launch the **Charms bar** from the Start screen or from any application mode:
  - a) Hover your mouse pointer on the upper or lower right of the screen.
  - b) On your keyboard, press  + <C>.



2. From the Charms bar, select **Settings** and click the network icon
3. Select the network that you want to connect to from the list.
4. Click **Connect**.







# Chapter 7

## Using the utilities



The Support DVD and Recovery DVD may not be included in the package. For more details on the recovery options in Windows® 8, refer to **Recovering your system** in this chapter.

### ASUS AI Suite II

ASUS AI Suite II is an all-in-one interface that integrates several ASUS utilities and allows users to launch and operate these utilities simultaneously.



This utility is pre-installed on some models. For models without an operating system, follow the steps below to install this utility.

### Using AI Suite II

AI Suite II automatically starts when you enter the Windows® operating system. The AI Suite II icon appears in the Windows® notification area. Click the icon to open the AI Suite II main menu bar.

Click each button to select and launch a utility, to monitor the system, to update the motherboard BIOS, to display the system information, and to customize the settings of AI Suite II.

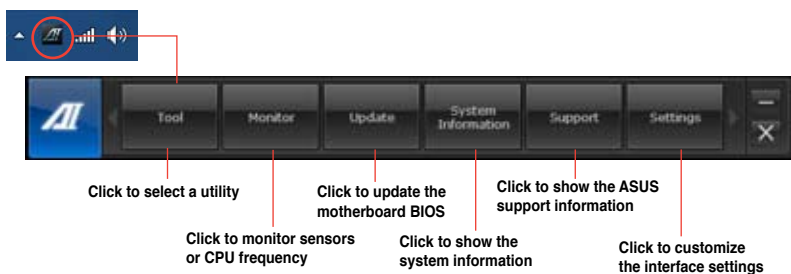

- The applications in the Tool menu vary with models.
- The screenshots of AI Suite II in this user manual are for reference only. The actual screenshots vary with models.

## The Tool menu

The **Tool** menu includes the EPU, Probe II, and Sensor Recorder panels.

### Launching and configuring EPU

EPU is an energy-efficient tool that provides you with a total power-saving solution. It detects the current loading and intelligently adjusts the power usage in real-time. When you select the Auto mode, the system changes modes automatically according to the current system status. It allows you to customize each mode through configuring the settings such as CPU frequency, vCore Voltage, and Fan Control.

#### To launch EPU:

- Click **Tool > EPU** on the AI Suite II main menu bar.

The screenshot shows the ASUS EPU utility interface. At the top, there are three system operating modes: **Auto** (selected), **High performance**, and **Max. power saving**. Below these are various settings like **Transparency**, **Performance**, **Conservation**, **Reliability**, and **Energy Saved**. A central pentagon icon is labeled "Advanced settings for each mode". At the bottom, there are navigation buttons: **Tool**, **Monitor**, **Update**, **System Information**, **Support**, and **Settings**.

Callouts and annotations include:

- Multiple system operating modes**: Points to the top mode selection area.
- Displays the following message if no VGA power saving engine is detected.**: Points to a small error dialog box that says "Warning: The VGA detected. Please install a compatible VGA card or recheck and update the VGA driver for better performance. For the list of compatible VGA cards, please visit: http://www.asus.com/monitoring\_utilities/epu/faq/faq\_vga.html".
- The items lighting up means power saving engine is activated**: Points to the CPU, GPU, and RAM icons in the EPU Status window, which are highlighted in blue.
- Displays the amount of CO2 reduced**: Points to the "Reduced CO2 Extension" value of 0.500 mg.
- \*Shifts between the display of Total and Current CO2 reduced**: Points to the "Total Started" and "From EPU Installation" sections.
- Displays the current CPU power**: Points to the "Current CPU Power" value of 3.25 Watts.
- Advanced settings for each mode**: Points to the central pentagon icon.
- Displays the system properties of each mode**: Points to the bottom navigation bar.



- \* Select **From EPU Installation** to show the CO2 that has been reduced since you installed EPU.
- \* Select **From the Last Reset** to show the total CO2 that has been reduced since you click the Clear button **Clear**.

## Launching and configuring Probe II

Probe II is a utility that monitors the computer's vital components, and detects and alerts you of any problem with these components. Probe II senses fan rotations, CPU temperature, and system voltages, among others. With this utility, you are assured that your computer is always at a healthy operating condition.

### To launch Probe II:

- Click **Tool > Probe II** on the AI Suite II main menu bar.

### To configure Probe II:

- Click the **Voltage/Temperature/Fan Speed** tabs to activate the sensors or to adjust the sensor threshold values.
- The **Preference** tab allows you to customize the time interval of sensor alerts, or change the temperature unit.

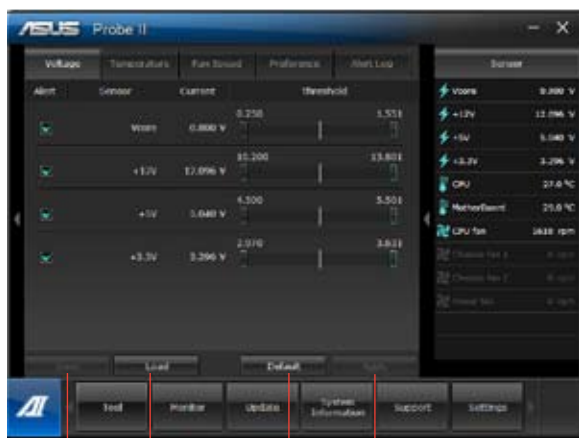

Saves your configuration

Loads your saved configuration

Loads the default threshold values for each sensor

Applies your changes

## Launching and configuring Sensor Recorder

Sensor Recorder allows you to monitor the changes in the system voltage, temperature, and fan speed, as well as recording the changes.

### To launch Sensor Recorder:

- Click **Tool > Sensor Recorder** on the AI Suite II main menu bar.

### To configure Sensor Recorder:

- Click the **Voltage/Temperature/Fan Speed** tabs and select the sensors that you want to monitor.
- The **History Record** tab allows you to record the changes in the sensors that you enable.

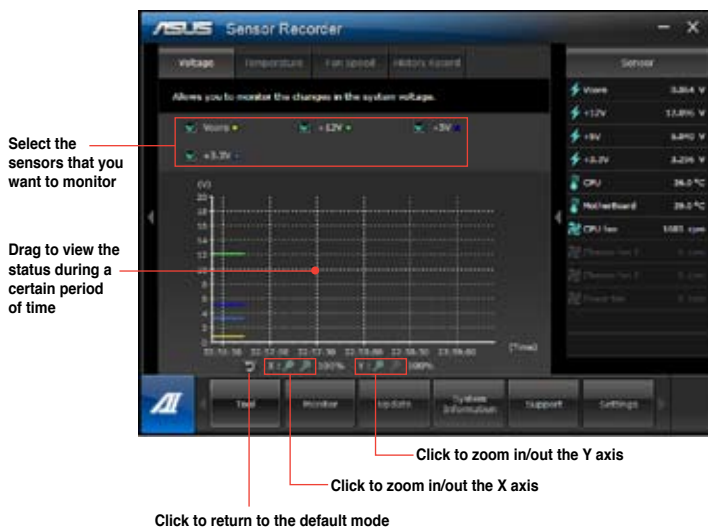

## The Monitor menu

The **Monitor** menu includes the Sensor and CPU Frequency panels.

### Launching Sensor

The Sensor panel displays the current value of a system sensor such as fan rotation, CPU temperature, and voltages.

#### To launch Sensor:

- Click **Monitor > Sensor** on the AI Suite II main menu bar.

### Launching CPU Frequency

The CPU Frequency panel displays the current CPU frequency and CPU usage.

#### To launch CPU frequency:

- Click **Monitor > CPU Frequency** on the AI Suite II main menu bar.

## The Update menu

The Update menu allows you to update the motherboard BIOS and the BIOS boot logo with the ASUS designed update utilities.

### ASUS Update

The ASUS Update is a utility that allows you to manage, save, and update the motherboard BIOS in Windows® OS. The ASUS Update utility allows you to update the BIOS directly from the Internet, download the latest BIOS file from the Internet, update the BIOS from an updated BIOS file, save the current BIOS file or view the BIOS version information.

#### Updating the BIOS through the Internet

##### To update the BIOS through the Internet:

1. From the ASUS Update screen, select **Update BIOS from Internet**, then click **Next**.
2. Select the ASUS FTP site nearest you to avoid network traffic.  
Tick the two items if you want to enable the BIOS downgradable and Auto-BIOS backup functions.
3. Select the BIOS version that you want to download, then click **Next**.  
When no updated version is detected, a message is displayed informing you that there is no new BIOS file from the BIOS server.
4. Click **Yes** if you want to change the boot logo, which is the image appearing on screen during the Power-On Self-Tests (POST). Otherwise, click **No**.
5. Follow the onscreen instructions to complete the update process.

## Updating the BIOS through a BIOS file

To update the BIOS through a BIOS file:

1. From the ASUS Update screen, select **Update BIOS from file**, then click **Next**.
2. Locate the BIOS file from the Open window, click **Open**, and click **Next**.
3. Click **Yes** if you want to change the boot logo, which is the image appearing on screen during the Power-On Self-Tests (POST). Otherwise, click **No**.
4. Follow the onscreen instructions to complete the update process.

### MyLogo

ASUS MyLogo allows you to customize the boot logo. The boot logo is the image that appears on screen during the Power-On Self-Tests (POST). ASUS MyLogo allows you to:

- Change the current BIOS boot logo of your motherboard
- Change the boot logo of a downloaded BIOS file and update this BIOS to your motherboard
- Change the boot logo of a downloaded BIOS file without updating this BIOS to your motherboard



---

Ensure that the BIOS item Full Screen Logo is set to [Enabled] to display the boot logo.

---

### Changing the BIOS boot logo

1. From the AI Suite II main menu bar, click **Update > MyLogo**.
2. Select any of these three options, then click **Next**:
  - Change the BIOS boot logo of my motherboard
  - Change the boot logo of a downloaded BIOS file and update this BIOS to my motherboard
  - Change the boot logo of a downloaded BIOS file (But do not update this BIOS to my motherboard)



---

Before using the last two options, ensure that you download a BIOS file to your computer using ASUS Update.

---

3. Locate the picture file that you want to use as the boot logo (and the downloaded BIOS if required) and then click **Next**.
4. Move the **Resolution** slider or click **Auto Tune** for the system to automatically adjust the screen resolution.
5. Click the **Bootling Preview** button to preview the way the picture is displayed during the POST. Left-click the mouse to return to the setting screen.
6. Click **Next** when the adjustment is finished.
7. Click **Flash** and follow the onscreen instructions to complete the process.

## The System Information screen

The System Information screen displays the information about the motherboard, CPU, and memory slots.

- Click the **MB** tab to see the details on the motherboard manufacturer, product name, version, and BIOS.
- Click the **CPU** tab to see the details on the processor and the Cache.
- Click the **Memory** tab and then select the memory slot to see the details on the memory module installed on the corresponding slot.
- Click the **Disk** tab and then select each disk to see the details on it.

## The Support screen

The Support screen displays the information about the ASUS website, technical support website, download support website, or contact information.

## The Settings screen

The Settings screen allows you to customize the main menu bar settings and the interface's skin.

- Application allows you to select the application that you want to enable.
- Bar allows you to modify the bar setting,
- Skin allows you to customize the interface's contrast, brightness, saturation, hue, and gamma.

## ASUS Smart Cooling System (optional)



ASUS Smart Cooling System is an optional feature on selected models and may be purchased separately.

### Configuring the UEFI BIOS models

ASUS Smart Cooling System maintains the internal system components through its air circulation after each system boot up. Follow these steps to configure this feature:

1. Enter the BIOS Setup program.



For details, refer to the section **Entering the BIOS Setup** in Chapter 2.



2. Click **Exit/Advanced Mode** on the right upper corner of the screen, and then select **Advanced Mode**. From the menu bar of the **Advanced Mode** screen, select **Monitor**.





- From the **Monitor** menu, select **Clean Level** and press <Enter> to display its configuration options.



- Select your preferred option from **Clean Level's** four configuration options:
  - **Disable:** Disables the fan system and the fan operates under the Q-Fan settings.
  - **Silent:** 40% of the fan's performance (poor performance but low noise)
  - **Optimal:** 70% of the fan's performance (standard setting).
  - **Performance:** Fan's full performance (best performance but noisy)
- Press <F10> and click **Yes** to save your settings. The system automatically reboots to finish the setup process.



During the system reboot, the Power LED flashes to indicate that the dust extraction fan rotates in reverse to remove the dust from the internal system components.

## Recovering your system

### Recovery options on Windows® 7

#### Using the system recovery partition

The system recovery partition quickly restores your Desktop PC's software to its original working state. Before using the system recovery partition, copy your data files (such as Outlook PST files) to USB storage devices or to a network drive and make note of any customized configuration settings (such as network settings).

#### About the system recovery partition

The system recovery partition is a reserved space on your hard disk drive used to restore the operating system, drivers, and utilities installed on your Desktop PC at the factory.



---

DO NOT delete the system recovery partition, which is the partition without volume label on Disk 0. The system recovery partition is created at the factory and cannot be restored if deleted. Take your Desktop PC to an authorized ASUS service center if you have problems with the recovery process.

---

#### Using the system recovery partition:

1. Press <F9> during bootup.
2. Highlight Windows Setup [EMS Enabled] and press <Enter>.
3. From the Recover system to a partition screen, click <Next>.
4. Follow the onscreen instructions to complete the recovery process.



---

Visit the ASUS website at [www.asus.com](http://www.asus.com) for updated drivers and utilities.

---

#### Using the Recovery DVD (on selected models)



---

Remove the external hard disk drive before performing system recovery on your Desktop PC. According to Microsoft, you may lose important data because of setting up Windows on the wrong disk drive or formatting the incorrect drive partition.

---

#### To use the Recovery DVD:

1. Insert the Recovery DVD into the optical drive. Your Desktop PC needs to be powered ON.
2. Restart the Desktop PC and press <F8> on bootup and select the optical drive (may be labeled as "CD/DVD") and press <Enter> to boot from the Recovery DVD.
3. Select OK to start to restore the image.

4. Select OK to confirm the system recovery.



---

Restoring will overwrite your hard drive. Ensure to back up all your important data before the system recovery.

---

5. Follow the onscreen instructions to complete the recovery process.



---

DO NOT remove the Recovery disc, unless instructed to do so, during the recovery process or else your partitions will be unusable.

---



---

Visit the ASUS website at [www.asus.com](http://www.asus.com) for updated drivers and utilities.

---

## Recovery options on Windows® 8

### Resetting your PC

The **Reset your PC** option restores your PC to its factory default settings.



---

Back up all your data before using this option.

---

#### To reset your PC:

1. Press <F9> during bootup.
2. From the screen, click **Troubleshoot**.
3. Select **Reset your PC**.
4. Click **Next**.
5. Select **Only the drive where the Windows is installed**.
6. Select **Just remove my files**.
7. Click **Reset**.



- The F9 recovery function is not applicable for downgrade versions of Windows® 8. Refer to the **Removing everything and reinstalling Windows** section for details on doing recovery inside Windows® 8. In case your operating system fails, use the bundled recovery DVD to reinstall your system.
  - Ensure that all data are backed up before doing a full recovery of your operating system to avoid losing important files.
- 



---

Download the multi-language versions of this notice from the ASUS Support site at <http://support.asus.com>

---

## To reset your PC by using Recovery DVD:



- 
- Back up all your data before using this option.
  - Disconnect all external hard disk drives before performing system recovery on your Desktop PC to avoid restoring Windows on the wrong partition or drive.
- 

1. Press **<F8>** during bootup.
2. Insert the Recovery DVD into the optical drive. On the End-User License Agreement (EULA) screen, click **Accept**.
3. Select **Reset your PC**.
4. Click **Next**.
5. Select **Only the drive where the Windows is installed**.
6. Select **Just remove my files**.
7. Click **Reset**.

## Recovering from a system image file

You can create a USB recovery drive and use this to recover your PC's settings.

## Creating a USB recovery drive



---

The USB storage device must have at least 16GB available space.

---



---

All files on your USB storage device will be permanently deleted during the process. Before you proceed, ensure that you back up all your important data.

---

## To create a USB recovery drive:

1. Launch the Control Panel from the All Apps screen.



For details, refer to Launching the **All Apps screen** under **Working with Windows® apps**.

2. From the Control Panel's System and Security, click **Find and fix problems**.
3. Click **Recovery > Create a recovery drive**.
4. Click **Copy the recovery partition from the PC to the recovery drive**, and then click **Next**.



5. Select the USB storage device where you want to copy the recovery files.
6. Click **Next**.



7. Click **Create**. Wait for a while for the process to complete.
8. When the process is completed, click **Finish**.

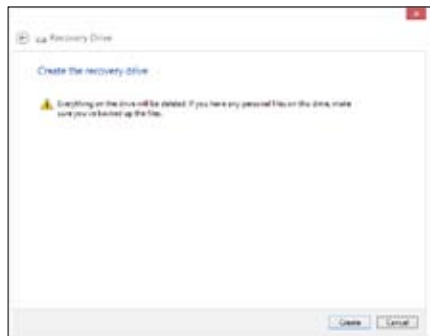

## Removing everything and reinstalling Windows

Restoring your PC to its original factory settings can be done using the Remove everything and reinstall option in PC Settings. Refer to the steps below to use this option.



Back up all your data before using this option.



This process may take a while to complete.

1. Launch the **Charms bar**.
2. Click **Settings > Change PC Settings > General**.
3. Scroll down to view the **Remove everything and reinstall Windows** option. Under this option, click **Get Started**.

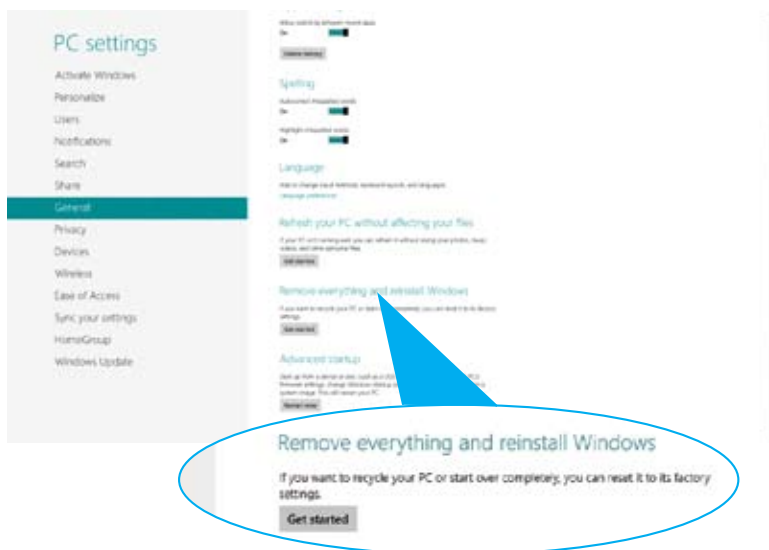

4. Follow the onscreen instructions to complete the reinstallation and reset process.

# Chapter 8

## Troubleshooting

### Troubleshooting

This chapter presents some problems you might encounter and the possible solutions.

? *My computer cannot be powered on and the power LED on the front panel does not light up.*

- Check if your computer is properly connected.
- Check if the wall outlet is functioning.
- Check if the Power Supply Unit is switched on. Refer to the section **Turning your computer ON/OFF** in Chapter 1.

? *My computer hangs.*

- Do the following to close the programs that are not responding:
  1. Simultaneously press <Alt> + <Ctrl> + <Delete> keys on the keyboard, then click **Task Manager**.
  2. Do the following based on the operating system:
    - On Windows® 7:**
      - a) Click **Applications** tab.
      - b) Select the program that is not responding, then click **End Task**.
    - On Windows® 8:**

Under **Task Manager** in the **Processes** tab, select the program that is not responding, then click **End Task**.
- If the keyboard is not responding, press and hold the Power button on the top of your chassis until the computer shuts down. Then press the Power button to turn it on.

? *I cannot connect to a wireless network using the ASUS WLAN Card (on selected models only)?*

- Ensure that you enter the correct network security key for the wireless network you want to connect to.
- Connect the external antennas (optional) to the antenna connectors on the ASUS WLAN Card and place the antennas on the top of your computer chassis for the best wireless performance.

**? *The arrow keys on the number key pad are not working.***

Check if the Number Lock LED is off. When the Number Lock LED is on, the keys on the number key pad are used to input numbers only. Press the Number Lock key to turn the LED off if you want to use the arrow keys on the number key pad.

**? *No display on the monitor.***

- Check if the monitor is powered on.
- Ensure that your monitor is properly connected to the video output port on your computer.
- If your computer comes with a discrete graphics card, ensure that you connect your monitor to a video output port on the discrete graphics card.
- Check if any of the pins on the monitor video connector is bent. If you discover bent pins, replace the monitor video connector cable.
- Check if your monitor is plugged to a power source properly.
- Refer to the documentation that came with your monitor for more troubleshooting information.

**? *When using multiple monitors, only one monitor has display.***

- Ensure that the both monitors are powered on.
- During POST, only the monitor connected to the VGA port has display. The dual display function works only under Windows.
- When a graphics card is installed on your computer, ensure that you connect the monitors to the output port on the graphics card.
- Check if the multiple displays settings are correct.

**? *My computer cannot detect my USB storage device.***

- The first time you connect your USB storage device to your computer, Windows automatically installs a driver for it. Wait for a while and go to My Computer to check if the USB storage device is detected.
- Connect your USB storage device to another computer to test if the USB storage device is broken or malfunctions.



? *I want to restore or undo changes to my computer's system settings without affecting my personal files or data.*

**On Windows® 7:**

The Windows® System Restore feature allows you to restore or undo changes to your computer's system settings without affecting your personal data such as documents or photos. For more details, refer to the section **Restoring your system** in Chapter 2.

**On Windows® 8:**

You can use Windows® 8 **Refresh everything without affecting your files** recovery option to restore or undo changes to your computer's system settings without affecting your personal data such as documents or photos. To use this recovery option, click **Settings > Change PC Settings > General** from the Charms bar, select **Refresh everything without affecting your files**, and click **Get Started**.

? *The picture on the HDTV is distorted.*

- It is caused by the different resolutions of your monitor and your HDTV. Adjust the screen resolution to fit your HDTV. To change the screen resolution:

On Windows® 7:

1. Do any of the following to open the **Screen Resolution** setting screen:
  - Click  > **Control Panel > Appearance and Personalization > Display > Change display settings**.
  - Right click anywhere on your Windows desktop. When the pop-up menu appears, click **Personalize > Display > Change display settings**.
2. Adjust the resolution. Refer to the documentation came with your HDTV for the resolution.
3. Click **Apply** or **OK**. Then click **Keep Changes** on the confirmation message.

On Windows® 8:

Do any of the following to open the **Screen Resolution** setting screen:

From the Start screen

- a) Launch the All Apps screen and pin Control Panel on the Start screen.



---

For details, refer to **Pinning an app on the Start screen** from the section **Working with Windows® apps**.





---

- b) From the Control Panel, click **Adjust screen resolution** under **Appearance and Personalization**.

From the Desktop Mode screen

- a) Launch the Desktop Mode from the Start screen.
- b) Right click anywhere on your Desktop Mode screen. When the pop-up menu appears, click **Personalize > Display > Change display settings**.



### ? *My speakers produce no sound.*

- Ensure that you connect your speakers to the Line out port (lime) on the front panel or the rear panel.
- Check if your speak is connected to an electrical source and turned on.
- Adjust your speakers' volume.
- Ensure that your computer's system sounds are not Muted.
  - If it is muted, the volume icon is displayed as . To enable the system sounds, click  from the Windows notification area, then click .
  - If it is not muted, click  and drag the slider to adjust the volume.
- Connect your speakers to another computer to test if the speakers arer working properly.

### ? *The DVD drive cannot read a disc.*

- Check if the disc is placed with the label side facing up.
- Check if the disc is centered in the tray, especially for the discs with non-standard size or shape.
- Check if the disc is scratched or damaged.

### ? *The DVD drive eject button is not responding.*

1. On Windows® 7, click  > **Computer**.  
On Windows® 8, hover your mouse pointer over the lower left corner of Windows® desktop then right-click on the Start Screen's thumbnail. From the popup menu, click **File Explorer** to open the **Computer** screen.
2. Right-click , then click **Eject** from the menu.

## Power

| Problem                                  | Possible Cause  | Action  |
|--|---|---|
| No power<br>(The power indicator is off) | Incorrect power voltage                               | <ul style="list-style-type: none"><li>• Set your computer's power voltage switch to your area's power requirements.</li><li>• Adjust the voltage settings. Ensure that the power cord is unplugged from the power outlet.</li></ul> |
|  | Your computer is not turned on.                       | Press the power key on the front panel to ensure that your computer is turned on.   |
|  | Your computer's power cord is not properly connected. | <ul style="list-style-type: none"><li>• Ensure that the power cord is properly connected.</li><li>• Use other compatible power cord.</li></ul>  |
|  | PSU (Power supply unit) problems                      | Contact the ASUS Service Center about installing another PSU on your computer.  |

## Display

| Problem  | Possible Cause  | Action   |
|--|---|--|
| No display output after turning the computer on (Black screen) | The signal cable is not connected to the correct VGA port on your computer. | <ul style="list-style-type: none"> <li>• Connect the signal cable to the correct display port (onboard VGA or discrete VGA port).</li> <li>• If you are using a discrete VGA card, connect the signal cable to the discrete VGA port.</li> </ul> |
|  | Signal cable problems   | Try connecting to another monitor.   |

## LAN

| Problem                    | Possible Cause  | Action   |
|----------------------------|---|--|
| Cannot access the Internet | The LAN cable is not connected.                             | Connect the LAN cable to your computer.  |
|                            | LAN cable problems  | Ensure the LAN LED is on. If not, try another LAN cable. If it still does not work, contact the ASUS service center. |
|                            | Your computer is not properly connected to a router or hub. | Ensure that your computer is properly connected to a router or hub.  |
|                            | Network settings  | Contact your Internet Service Provider (ISP) for the correct LAN settings.   |
|                            | Problems caused by the anti-virus software                  | Close the anti-virus software.   |
|                            | Driver problems   | Reinstall the LAN driver   |

## Audio

| Problem  | Possible Cause                                       | Action   |
|----------|--|--|
| No Audio | Speaker or headphone is connected to the wrong port. | <ul style="list-style-type: none"> <li>Refer to your computer's user manual for the correct port.</li> <li>Disconnect and reconnect the speaker to your computer.</li> </ul> |
|          | Speaker or headphone does not work.                  | Try using another speaker or headphone.  |
|          | The front and back audio ports do not work.          | Try both the front and back audio ports. If one port failed, check if the port is set to multi-channel.  |
|          | Driver problems                                      | Reinstall the audio driver   |

## System

| Problem                            | Possible Cause   | Action   |
|------------------------------------|--|--|
| System speed is too slow           | Too many programs are running.                         | Close some of the programs.  |
|                                    | Computer virus attack                                  | <ul style="list-style-type: none"> <li>Use an anti-virus software to scan for viruses and repair your computer.</li> <li>Reinstall the operating system.</li> </ul>  |
| The system often hangs or freezes. | Hard disk drive failure                                | <ul style="list-style-type: none"> <li>Send the damaged hard disk drive to ASUS Service Center for servicing.</li> <li>Replace with a new hard disk drive.</li> </ul>  |
|                                    | Memory module problems                                 | <ul style="list-style-type: none"> <li>Replace with compatible memory modules.</li> <li>Remove the extra memory modules that you have installed, then try again.</li> <li>Contact the ASUS Service Center for assistance.</li> </ul> |
|                                    | There is not enough air ventilation for your computer. | Move your computer to an area with better air flow.  |
|                                    | Incompatible softwares are installed.                  | Reinstall the OS and reinstall compatible softwares.   |

## CPU

| Problem  | Possible Cause  | Action  |
|--|---|---|
| Too noisy right after turning on the computer. | Your computer is booting up.                          | It is normal. The fan runs on its full speed when the computer is powering on. The fan slows down after entering the OS.  |
|  | The BIOS settings have been changed.                  | Restore the BIOS to its default settings.   |
|  | Old BIOS version                                      | Update the BIOS to the latest version. Visit the ASUS Support site at <a href="http://support.asus.com">http://support.asus.com</a> to download the latest BIOS versions.   |
| Computer is too noisy when in use.             | The CPU fan has been replaced.                        | Ensure that you are using a compatible or ASUS-recommended CPU fan.   |
|  | There is not enough air ventilation for the computer. | Ensure that your computer is working in an area with good air flow.   |
|  | The system temperature is too high.                   | <ul style="list-style-type: none"> <li>• Update the BIOS.</li> <li>• If you know how to reinstall the motherboard, try to clean the inner space of the chassis.</li> <li>• Contact the ASUS Service Center for assistance.</li> </ul> |



If the problem still persists, refer to your Desktop PC's warranty card and contact the ASUS Service Center. Visit the ASUS Support site at <http://support.asus.com> for the service center information.

## ASUS contact information

### ASUSTeK COMPUTER INC.

|           |   |
|-----------|---|
| Address   | 15 Li-Te Road, Peitou, Taipei, Taiwan 11259 |
| Telephone | +886-2-2894-3447                            |
| Fax       | +886-2-2890-7798                            |
| E-mail    | info@asus.com.tw                            |
| Web site  | www.asus.com.tw                             |

#### *Technical Support*

|                |                  |
|----------------|------------------|
| Telephone      | +86-21-38429911  |
| Online support | support.asus.com |

### ASUS COMPUTER INTERNATIONAL (America)

|           |   |
|-----------|---|
| Address   | 800 Corporate Way, Fremont, CA 94539, USA |
| Telephone | +1-510-739-3777                           |
| Fax       | +1-510-608-4555                           |
| Web site  | usa.asus.com                              |

#### *Technical Support*

|                |                  |
|----------------|------------------|
| Telephone      | +1-812-282-2787  |
| Support fax    | +1-812-284-0883  |
| Online support | support.asus.com |

### ASUS COMPUTER GmbH (Germany and Austria)

|                |   |
|----------------|---|
| Address        | Harkort Str. 21-23, D-40880 Ratingen, Germany |
| Fax            | +49-2102-959931                               |
| Web site       | www.asus/de                                   |
| Online contact | eu-rma.asus.com/sales                         |

#### *Technical Support*

|                                     |                  |
|-------------------------------------|------------------|
| Telephone (Component)               | +49-2102-5789555 |
| Telephone (System/Notebook/Eee/LCD) | +49-2102-5789557 |
| Support Fax                         | +49-2102-959911  |
| Online support                      | support.asus.com |

## Free Manuals Download Website

<http://myh66.com>

<http://usermanuals.us>

<http://www.somanuals.com>

<http://www.4manuals.cc>

<http://www.manual-lib.com>

<http://www.404manual.com>

<http://www.luxmanual.com>

<http://aubethermostatmanual.com>

Golf course search by state

<http://golfingnear.com>

Email search by domain

<http://emailbydomain.com>

Auto manuals search

<http://auto.somanuals.com>

TV manuals search

<http://tv.somanuals.com>