

User Manual

8x8 VGA Matrix Switcher over CAT5 with Stereo Audio AT-VGA88M-SR

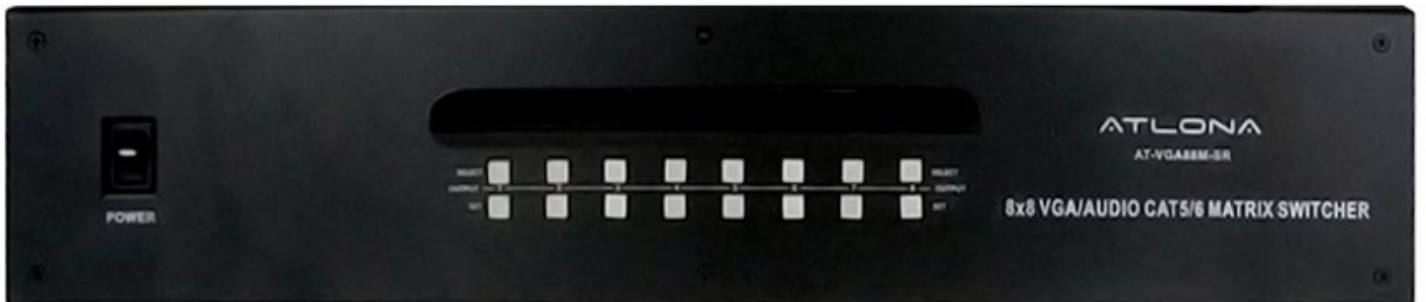

TABLE OF CONTENTS

1. Introduction	2
2. Package Contents	2
3. Features	2
4. Specification	3
5. Panel Descriptions	4
5.1 Front Panel	4
5.2 Rear Panel	4
6. Remote Control	6
7. RS-232 Protocol Commands	7
7.1. Power Off Mode	7
7.2. Front Panel Lock	8
7.3. Unit Reset	8
8. Connection Diagram	9
9. Safety Information	10
10. Warranty	11
11. Atlona Product Registration	12

INTRODUCTION

Atlona Technologies' AT-VGA88M-SR is one of the most innovative VGA Matrix Switchers with Stereo Audio on the market. The AT-VGA88M-SR has 8 individual VGA (RGBHV) inputs with Stereo Audio and 8 individual CAT5 outputs. The matrix switch can route any input to any output. This unit is ideal for connecting sources such as computer, Set Top Boxes, and Satellite Receivers to desired displays over CAT5 cable such as HDTV, LCDs, Plasma Monitors, and Video Projectors. Selection of inputs can be achieved manually through the front panel, through infrared remote control, or RS232 control. 8 receiver units are included to distribute the VGA signal up to 1000ft over CAT5 cable.

PACKAGE CONTENTS

- AT-VGA88M-SR unit
- Operating Instructions
- IR Remote Controller
- 19 inch rack mounts brackets
- RS232 package
- 8 CAT5 Receiver modules
- Power Supply 12V DC, Universal Type 50/60Hz, 100~230 VAC

FEATURES

- Supports 8 x inputs VGA and Stereo Audio to 8 x CAT5 outputs Matrix Switcher
- Output Signals: supported via CAT5-CAT6 cable to VGA Monitor displays
- Supported HDTV Resolutions 480p/720p/1080i/1080p
- Supported VESA Resolution: VGA(640 X 480)/SVGA (800 X 600)/XGA(1024 X768)/SXGA(1280 X 1024)/ UXGA(1600 X1200) / 1920x1200 (WUXGA)
- RS232 serial interface
- Compatible with all VGA Video Monitors, Plasma displays and Projectors
- Control Options:
 - RS-232
 - Manual controlled by front panel button
 - IR remote control
- Support desktop with ear mount and 19 inch rack
- Receiver modules extend AV signal up to 300m (1000ft)



SPECIFICATIONS

Type of Switcher	8 inputs to 8 outputs, VGA (RGBHV) with Stereo Audio Matrix Switcher
Input ports	VGA (RGBHV) 1x HD-15p VGA Female connector
Output Ports	Stereo Audio, 1x 3.5mm Female Jack
CAT5	VGA (RGBHV) & Audio thru 1x RJ45 CAT5 connector
Video Bandwidth	325MHz (-3db), 200mVp-p
Video Supported	High resolution formats up to 1920x1200 (WUXGA)
Audio Supported	Stereo Audio
Low crosstalk	-83 db@5MHz
Control	IR remote, select buttons on the front panel & RS232
RS 232 Control	RS232 serial interface
Gain control	60MHz 0.1 db gain flatness
Chassis Material	Metal thin=1mm
Safety Approvals	CE, FCC, RoHS(2002/95/EC)
Dimensions (LWH)	19" x 7.87" x 3.46" (482mm x 200mm x 88mm)
Power Supply	DC12V / 2A (consumption 1.6A Max) Use Universal Switch Type 50/60Hz, 100~230 VAC
Shipping Weight	3.95 Kgs / 6.58 lb

RECEIVER UNIT SPECIFICATIONS

Type of CAT5	Receiver(RX)
Type of Signal	VGA(RGBHV) & Stereo Audio connectors
Video Bandwidth	225Mhz, -3Db large signal bandwidth 450Mhz, - 3Db small signal bandwidth
Output balance error	-60db @50Mhz
High isolation	between Amplifier 80db@10Mhz
Audio-in impedance	10 Ohms
Audio Frequency response	20 HZ to 20KHz, +/-1db
Safety Approval	CE, FCC, VCCI & RoHS(2002/95/EC)
Dimension	2.76" x 2.6" x 1.15" (70mm x 66mm x 29.1mm)
Power Supply	DC12V/0.42A



PANEL DESCRIPTION

1. Front Panel

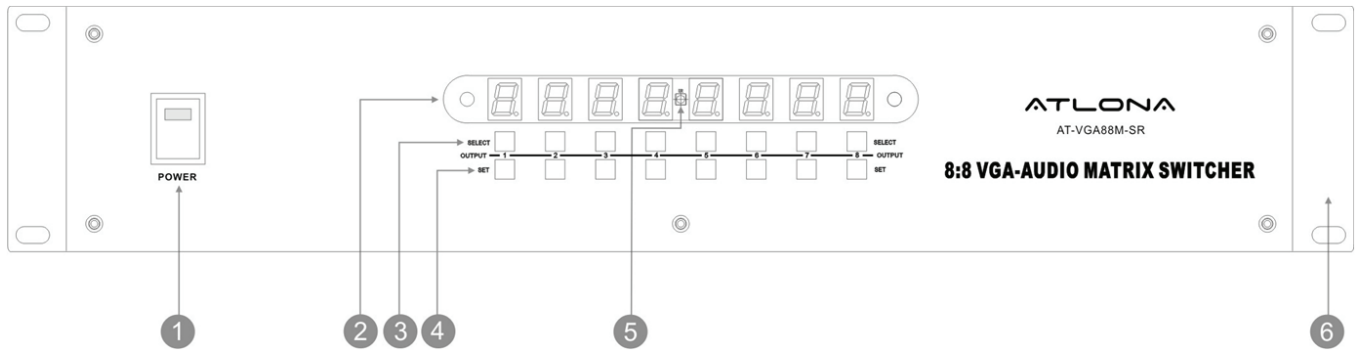

1. **POWER SWITCH:** The power switch turns the unit ON and OFF. The LED illuminates red when the switcher is power ON
2. **INPUT LED DISPLAY:** Input channel readout matches numbered outputs marked directly below.
3. **INPUT SELECT BUTTONS:** Input selection buttons are provided for each output.
4. **SET BUTTONS:** Sets selected source.
5. **IR SENSOR:** The IR sensor receives IR commands from the remote control.
6. **19 INCH RACK MOUNT BRACKETS:** 19 inch 2U

2. Rear Panel

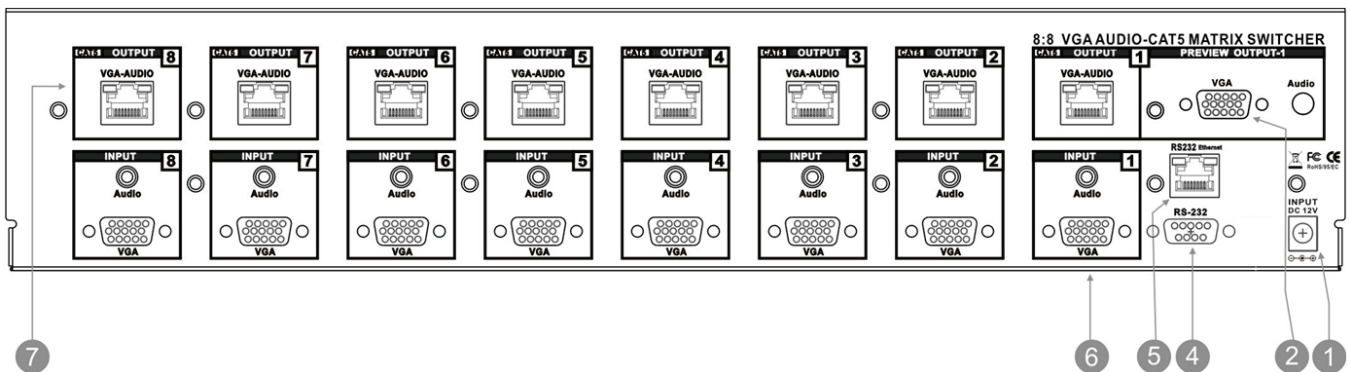

1.DC POWER INPUT.

Power Jack:



- DC Jack - inner OD \varnothing 2.1mm (+)
- Outside OD \varnothing 5.5mm (GND)
- Power input - 12V DC, 3A



2. PREVIEW OUTPUT #1

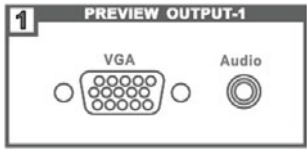

VGA (RGBHV) Via 1x HD-15p connectors
Preview Output #1 VGA & Audio local monitoring. Stereo Audio thru 1x 3.5mm port.

4. RS232 Connection.

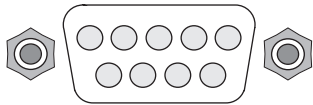

DB-9pin Female connector
RS 232 control port to allow for interfacing to a PC, Such as a computer or touch panel control, to the switcher via this DB-9pin Female connector for serial RS-232 control.

5. RS 232 Over Ethernet.

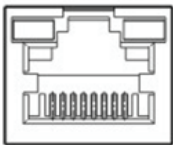

Connect RS232 serial interface via Ethernet control
RS232 Ethernet

6. INPUTS 1-8 VGA-RGBHV-AUDIO.

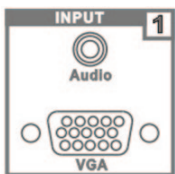

VGA (RGBHV) 1x HD-15p connector
Stereo Audio 1x 3.5mm ear phone jack connector
Connect VGA(RGBHV) & Stereo Audio to 8x CAT5 outputs of the matrix switcher.
VGA & Stereo Audio inputs :
- VGA (RGBHV), 1x HD-15p Connectors
- Stereo Audio, 1x 3.5mm ear phone jack

7. CAT5 OUTPUTS (VGA+AUDIO)

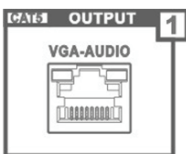

Extend VGA (RGBHV) signal thru CAT5 cable to VGA displays including audio.
Output 1~8 CAT5 port signals:
- CAT5 VGA (RGBHV) + Audio



REMOTE CONTROL

IR CODES :

POWER ON : 00FF 04FB
POWER OFF : 00FF 05FA

INPUT#1 / OUTPUT#1 : 01FE 31CE
INPUT#1 / OUTPUT#2 : 01FE 32CD
INPUT#1 / OUTPUT#3 : 01FE 33CC
INPUT#1 / OUTPUT#4 : 01FE 34CB
INPUT#1 / OUTPUT#5 : 01FE 35CA
INPUT#1 / OUTPUT#6 : 01FE 36C9
INPUT#1 / OUTPUT#7 : 01FE 37C8
INPUT#1 / OUTPUT#8 : 01FE 38C7
INPUT#2 / OUTPUT#1 : 02FD 31CE
INPUT#2 / OUTPUT#2 : 02FD 32CD
INPUT#2 / OUTPUT#3 : 02FD 33CC
INPUT#2 / OUTPUT#4 : 02FD 34CB
INPUT#2 / OUTPUT#5 : 02FD 35CA
INPUT#2 / OUTPUT#6 : 02FD 36C9
INPUT#2 / OUTPUT#7 : 02FD 37C8
INPUT#2 / OUTPUT#8 : 02FD 38C7
INPUT#4 / OUTPUT#1 : 04FB 31CE
INPUT#4 / OUTPUT#2 : 04FB 32CD
INPUT#4 / OUTPUT#3 : 04FB 33CC
INPUT#4 / OUTPUT#4 : 04FB 34CB
INPUT#4 / OUTPUT#5 : 04FB 35CA
INPUT#4 / OUTPUT#6 : 04FB 36C9
INPUT#4 / OUTPUT#7 : 04FB 37C8
INPUT#4 / OUTPUT#8 : 04FB 38C7
INPUT#3 / OUTPUT#1 : 03FC 31CE
INPUT#3 / OUTPUT#2 : 03FC 32CD
INPUT#3 / OUTPUT#3 : 03FC 33CC
INPUT#3 / OUTPUT#4 : 03FC 34CB
INPUT#3 / OUTPUT#5 : 03FC 35CA
INPUT#3 / OUTPUT#6 : 03FC 36C9
INPUT#3 / OUTPUT#7 : 03FC 37C8
INPUT#3 / OUTPUT#8 : 03FC 38C7



1.2. SWITCH POWER ON or OFF.

Controller with a separate power ON and OFF

3. INPUTS 1-8 : VGA DISPLAYS INPUT SELECTION

Input - 1 : CAT5 connect to VGA+Audio Display / Monitor

Input - 2 : CAT5 connect to VGA+Audio Display / Monitor

Input - 3 : CAT5 connect to VGA+Audio Display / Monitor

Input - 4 : CAT5 connect to VGA+Audio Display / Monitor

Input - 5 : CAT5 connect to VGA+Audio Display / Monitor

Input - 6 : CAT5 connect to VGA+Audio Display / Monitor

Input - 7 : CAT5 connect to VGA+Audio Display / Monitor

Input - 8 : CAT5 connect to VGA+Audio Display / Monitor

4. OUTPUTS 1-8 : VGA SOURCES OUTPUT

Output -1 : VGA-1 VGA+Audio Signal from source device

Output -2 : VGA-2 VGA+Audio Signal from source device

Output -3 : VGA-3 VGA+Audio Signal from source device

Output -4 : VGA-4 VGA+Audio Signal from source device

Output -5 : VGA-5 VGA+Audio Signal from source device

Output -6 : VGA-6 VGA+Audio Signal from source device

Output -7 : VGA-7 VGA+Audio Signal from source device

Output -8 : VGA-8 VGA+Audio Signal from source device

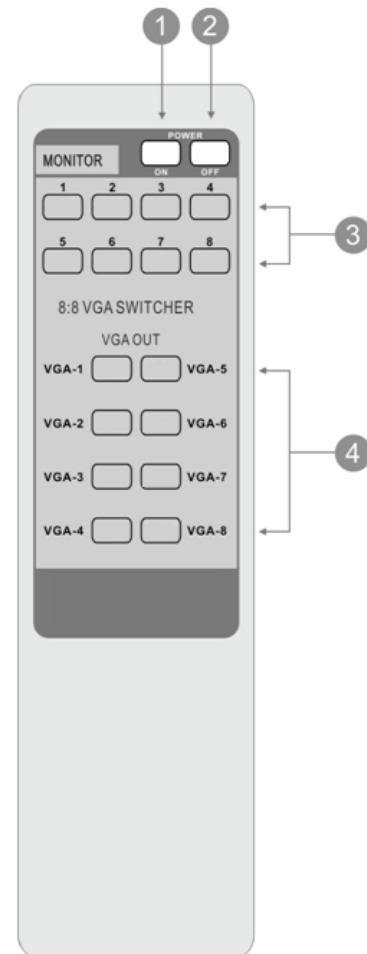



RS-232 PROTOCOL COMMANDS

Baud Rate : 9600 bps, Data Bit :8 bits, Parity : None, Stop Bit :1 bit

- Each command is terminated with a Carriage Return
- Each feedback is terminated with a Carriage Return
- Code entry is CASE SENSITIVE.
- Do not insert spaces between letter/number code entries.

Note1: Feedback for a command repeats the original command.

Example, if x1\$ is a command, the feedback is the same and if the command is x2\$, the feedback would also be x2\$.

Note2: If command fails, the feedback should be "Command FAILED".

Command	Description	Feedback
PWON	Power ON	PWON
PWOFF	Power OFF	PWOFF
All#	Reset all input signals to matching output. (Input 1 to Output 1, Input 2 to Output 2, etc...)	All#
x1\$	Switch OFF specified output channel [1]. If Output channel is 2 the command would be x2\$	x1\$
x1AVx2	Switch specified input to output. If input is 5 and output is 3, then command would be x5AVx3	x1AVx2
x1AVx2,x3,x4	Switch specified input to multiple outputs. If input is 5 and outputs are 6, 7, 8, then the command would be x5AVx6,x7,x8	x1AVx2,x3,x4
Statusx1	Display input currently routed to specified output. Example Statusx1 is asking what input is currently being routed to Output # 1	x7AVx1
Status	Display current routing for all inputs and outputs	x1AVx1, x2AVx2, x3AVx4, x5AVx8, ...
Save[Y]	Save the current routing to a preset command [Y]. [Y] ranges from 0 to 9	Save2
Recall[Y]	Recall the preset command [Y]. [Y] ranges from 0 to 9	Recall2
Clear[Y]	Clear the preset command [Y]. [Y] ranges from 0 to 9	Clear2
Mreset	Reset device to manufacture default	Mreset



CONNECTION DIAGRAM

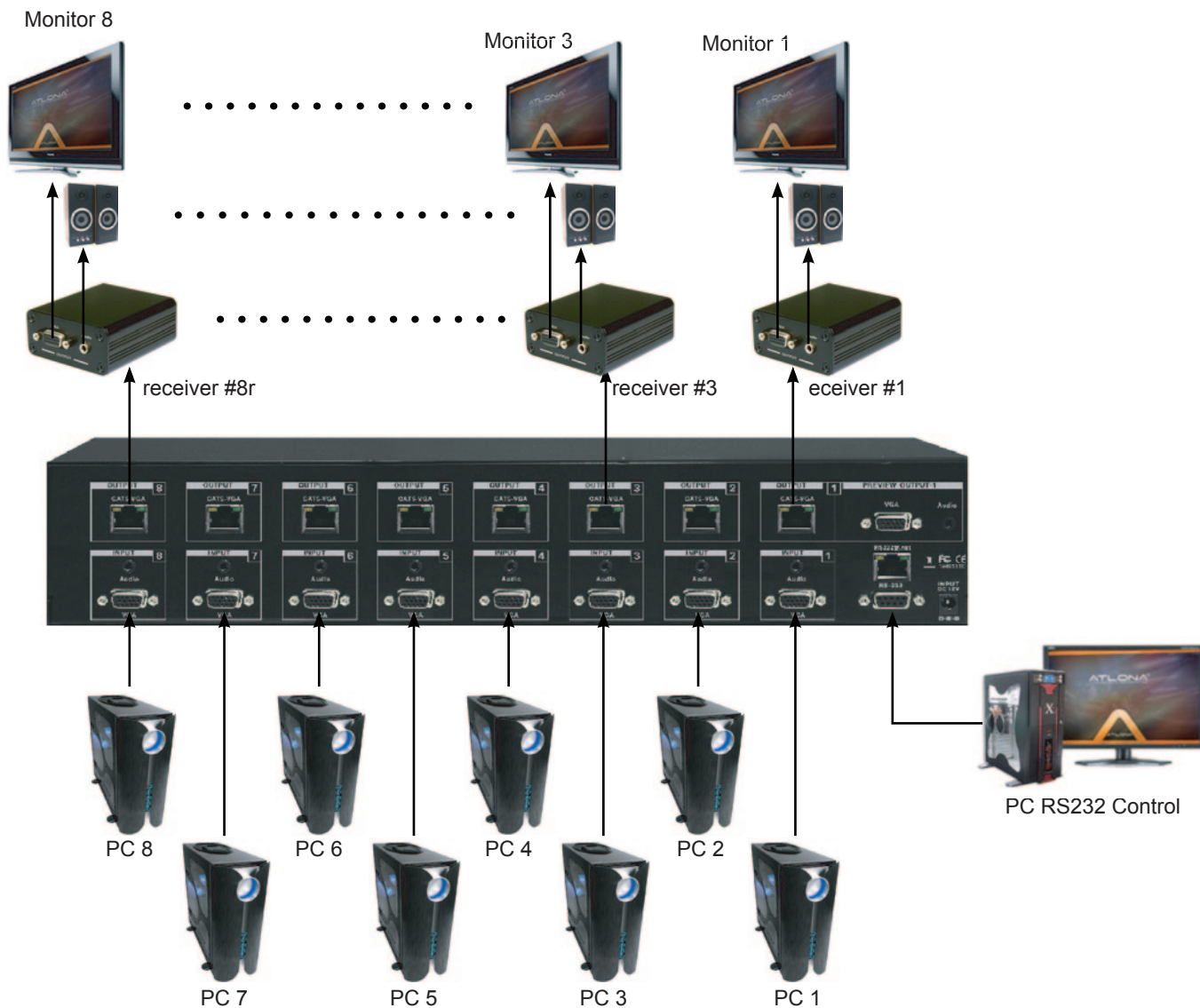

SAFETY INFORMATION

Safeguards



To reduce the risk of electric shock, do not expose this product to rain or moisture



Do not modify the wall plug. Doing so will void the warranty and safety features.



If the wall plug does not fit into your local power socket, hire an electrician to replace your obsolete socket.



This equipment should be installed near the socket outlet and the device should be easily accessible in the case it requires disconnection.

Precautions

FCC regulations state that any unauthorized changes or modifications to this equipment, not expressly approved by the manufacturer, could void the user's authority to operate this equipment.

Operate this product using only the included external power supply. Use of other power supplies could impair performance, damage the product, or cause fires.

In the event of an electrostatic discharge this device may automatically turn off. If this occurs, unplug the device and plug it back in.

Protect and route power cords so they will not be stepped on or pinched by anything placed on or against them. Be especially careful of plug-ins or cord exit points from this product.

Avoid excessive humidity, sudden temperature changes or temperature extremes.

Keep this product away from wet locations such as bathtubs, sinks, laundries, wet basements, fish tanks, and swimming pools.

Use only accessories recommended by Atlona to avoid fire, shock, or other hazards.

Unplug the product before cleaning. Use a damp cloth for cleaning and not cleaning fluid or aerosols. Such products could enter the unit and cause damage, fire, or electric shock. Some substances may also mar the finish of the product.

Never open, remove unit panels, or make any adjustments not described in this manual. Attempting to do so could expose you to dangerous electrical shock or other hazards. It may also cause damage to your AT-VGA88M-SR. Opening the product will void the warranty.

Do not attempt to service the unit. Disconnect the product and contact your authorized Atlona reseller or contact Atlona directly.

WARRANTY

Limited Warranty

Atlona Technologies warrants that (a) its products (the AT-VGA88M-SR) will perform substantially in accordance with the accompanying written materials for a period of 3 years from the date of receipt and (b) that the product will be free from defects in materials and workmanship under normal use and service for a period of 3 years. In the event applicable law imposes any implied warranties, the implied warranty period is limited to 3 years from the date of receipt. Some jurisdictions do not allow such limitations on duration of an implied warranty, so the above limitation may not apply to customers that fall within those areas.

Customer Remedies

Atlona Technologies' and its suppliers' entire liability and Customer's exclusive remedy shall be, at Atlona Technologies' decision, either return of the price paid for the product, repair, or replacement of the product that does not meet this Limited Warranty and which is returned to Atlona Technologies with a copy of the Customer's receipt. This Limited Warranty is void if failure of the product has resulted from accident, abuse, misapplication, or natural occurrence. In example but not limited to: power surges (electrical storms, local power outage), dropping the product (or items on the product), contact with fluids, and physical misconduct (i.e. kicking or punching). Any replacement product will be warranted for the remainder of the original warranty period.

No other warranties

To the maximum extent permitted by applicable law, Atlona Technologies and its suppliers disclaim all other warranties, either expressed or implied, including, but not limited to, implied warranties of merchantability and fitness for a particular purpose, with regard to the product and any related written materials. This Limited Warranty gives customer specific legal rights. Customers may have other rights depending on the jurisdiction.

No liability for damages

To the maximum extent permitted by applicable law, in no event shall Atlona Technologies or its suppliers be liable for any damages arising out of the use of or inability to use this product, even if Atlona Technologies has been advised of the possibility of such damages. Such damages include but are not limited to: special, incidental, consequential, or indirect damages for personal injury, loss of business profits, business interruption, loss of business information, or any other pecuniary loss. Atlona Technologies' and its suppliers' entire liability under any provision of this agreement shall be limited to the amount actually paid by you for the product. Some Jurisdictions do not allow the exclusion or limitation of liability for consequential or incidental damage. The above limitations may not apply to you in such jurisdictional cases.

ATLONA PRODUCT REGISTRATION

Thank you for purchasing this Atlona product. - We hope you enjoy it and will take an extra few moments to register your new purchase.

Registration creates an ownership record if your product is lost or stolen and helps ensure you'll receive notification of performance issues and firmware updates.

At Atlona, we respect and protect your privacy, assuring you that your registration information is completely secure. Atlona product registration is completely voluntary and failure to register will not diminish your limited warranty rights.

To register go to: <http://www.atlona.com/registration>

Free Manuals Download Website

<http://myh66.com>

<http://usermanuals.us>

<http://www.somanuals.com>

<http://www.4manuals.cc>

<http://www.manual-lib.com>

<http://www.404manual.com>

<http://www.luxmanual.com>

<http://aubethermostatmanual.com>

Golf course search by state

<http://golfingnear.com>

Email search by domain

<http://emailbydomain.com>

Auto manuals search

<http://auto.somanuals.com>

TV manuals search

<http://tv.somanuals.com>