
AVR2070: Route Under MAC (RUM) with IPv6 and 6LoWPAN

Features

- A FREE 802.15.4 networking solution
 - Multi-hop Route Under MAC (RUM)
 - All Atmel IEEE 802.15.4™ transceivers supported
 - Many AVR® microcontrollers supported
- Completely Customizable Firmware
 - Ready to use as the basis for a wireless product
 - Standalone MAC data layer for small memory footprint
 - Optional IPv6/6LoWPAN Interface layer provides worldwide wireless connectivity over the IPv6 internet

1 Introduction

Wireless Sensor Networks (WSN) have become a low power, low cost means for communicating data between sensor devices dispersed over an area. Many of these applications call for small embedded wireless networking solutions to substantially reduce the cost of all required components. Atmel®'s Route Under MAC (RUM) with support for IPv6 and 6LoWPAN is a highly flexible stack solution for these low cost applications. Providing Internet Protocol (IP) over low power, low data rate wireless transceivers enables immediate interoperability with existing wired networks. With an IPv6 foundation, each wireless node on the network can be given a worldwide unique IPv6 address and directly communicate with any other IPv6 device in the world without the need for any translation or a complex gateway.

Free to Atmel customers, the Atmel RUM/6LoWPAN networking stack proves to be a ready and cost-effective solution for Wireless Sensor Networks.



AVR®
MCU Wireless
Solutions

Application Note

Rev. 8240B-AVR-06/09



2 Stack Architecture

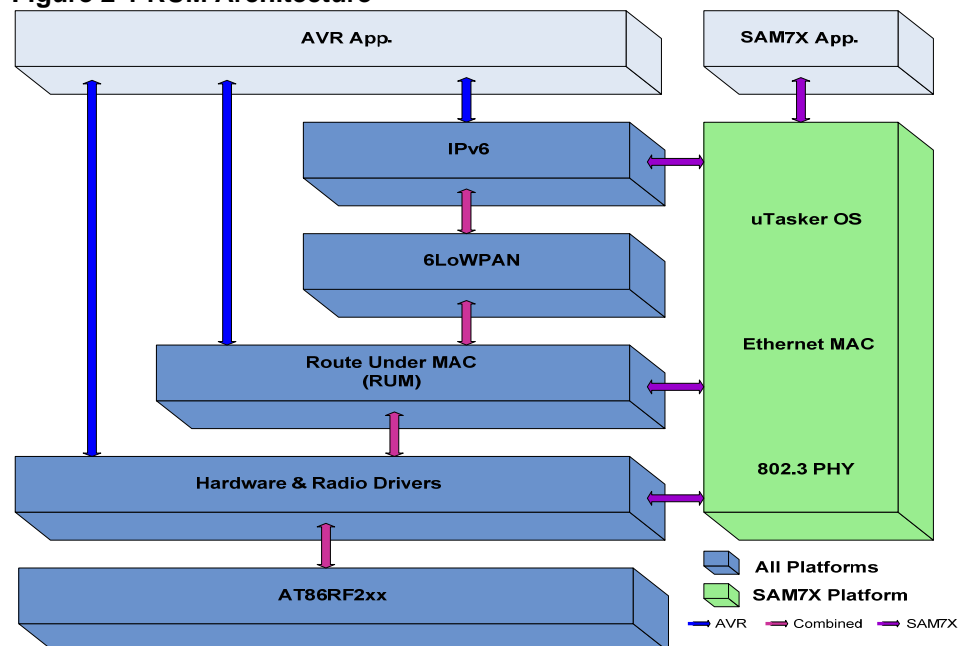
Route Under Mac (RUM) is a small 802.15.4 protocol developed by Atmel. This protocol routes packets at the MAC layer, as opposed to the application or IPv6 layer, which would be a route over scheme. The *under* comes from the fact that routing is done at a low level. This has a number of advantages:

- Routers and end nodes can be simpler, and therefore less expensive. These nodes manage almost no routing information.
- The coordinator knows all pertinent information about every node in its PAN, which means special “guessing” routing algorithms are not needed.
- Higher level code does not have to be concerned with routing, and has only to send a packet to a destination address.

The main components of the stack include RUM, and IPv6 / 6LoWPAN. The complete stack features the following highlights:

- **Small object size.** A minimal build, with only RUM and a tiny example application, is about 6KB for an AVR end node.
- **Self-forming network.** Nodes power up, find a network, and associate to it.
- **Self-healing network.** Nodes re-associate upon a failure to communicate.
- **Multi-hop routing.** Nodes can be multiple hops away from the coordinator.
- **Source Code Included.** Free for use and free to modify if used with Atmel hardware.
- Designed to be a **base platform** for customer applications.
- **Very configurable**, with the ability to add or remove features at compile time. Features include 6LoWPAN frames, end node sleeping, and a terminal mode.
- **Portable** to almost any Atmel processor.

Figure 2-1 RUM Architecture

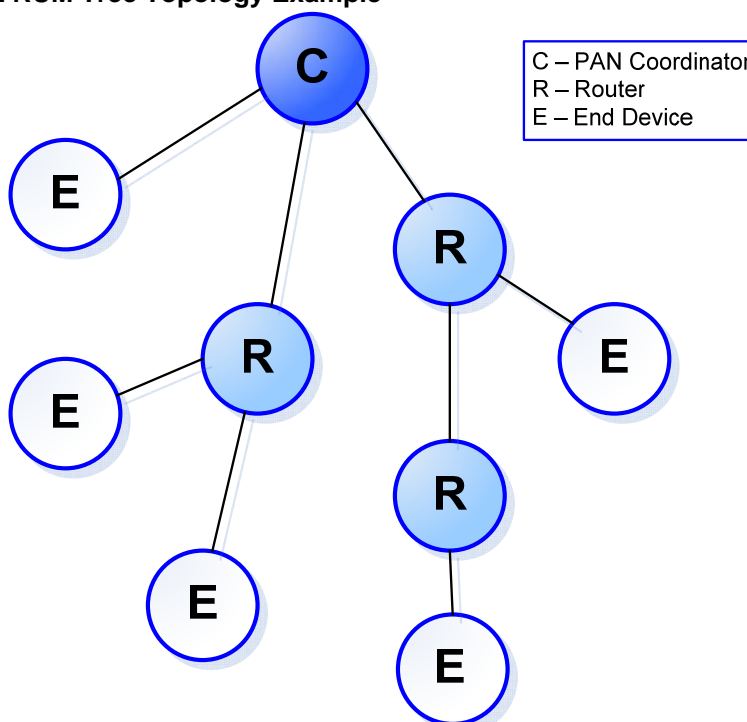


2.1 Overview of RUM

A RUM network is constructed around a coordinator. The coordinator is the only node that keeps any state information about the network, so that the other nodes do not have to store any network information. This allows for low cost hardware for both routers and end-nodes which comprise the bulk of the network. A router can act as a multi-hop intermediary for other nodes, while an end node can attach to a network, but cannot associate child nodes. Any node is usable as a data node or actuator.

The network is organized as a tree, with the coordinator having a number of associated nodes as children, and router nodes having their own associated children as well. Each node has exactly one parent, which is also the node's link to every other part of the network.

Figure 2-2 RUM Tree Topology Example



Appendix A contains a detailed description of the RUM protocol.

2.2 Overview of IPv6 and 6LoWPAN

The features of IPv6 and 6LoWPAN allow the RUM coordinator to act as an edge router in the worldwide network. The full functionality of these features are best utilized on the AT91SAM7X-EK development kit which provides an Ethernet connection. This application setup is described in section 4.

Any wireless node connected to the coordinator/edge router will obtain a unique IPv6 address based on its RUM short address. Depending on the application, the wireless node can then report sensor data directly to the coordinator/edge router, some other server or IPv6 addressable device via the IPv6 internet connection. This node can also receive commands when necessary based on application software.

More details about the interaction between RUM/6LoWPAN can be found in Appendix C.





2.3 Supported Hardware Platforms

The RUM software distributed with this application note can run on a variety of platforms. The PLATFORM keyword defines several parameters about a board. An example of these parameters is:

- Which microcontroller is present on the platform board?
- How the microcontroller is connected to the transceiver – which radio pins connect to which port pins on the microcontroller.
- Any ADC connections to the microcontroller.
- Any LED and switch connections to the microcontroller.
- Which band the board uses – 2.4GHz, 928MHz, 868MHz or 783MHz.

See the documentation included with the source code for implementation details.

2.3.1 AT91SAM7X-EK

The Atmel AT91SAM7X-EK evaluation kit can be purchased from a local Atmel distributor. This evaluation kit embeds an AT91SAM7X256 microcontroller which contains an Ethernet peripheral. By obtaining any of the AT86RF2xx transceivers, the platform can be assembled to operate as a RUM coordinator and/or IPv6 edge router.

This platform is further discussed in section 4.

2.3.2 Raven

The ATAVRRZRAVEN is the official development kit for the AT86RF230. The kit contains two Raven boards (with LCD and joystick interface), and one Raven USB stick.

The Raven platform has two microcontrollers – one for the radio and one for the Raven user interface. The RUM software lives in the ATmega1284P microcontroller, and the user interface software – supplied with RUM – lives in the ATmega3290P microcontroller.

The user interface is not required – RUM can work as a coordinator, router, or end node without a user interface on the Raven.

To debug RUM on Raven, two miniature 10-pin headers (supplied with RZRAVEN) must be soldered to the board so that the programming tool can be plugged in. The JTAGICE mkII and AVRISP programming tools can each program the Raven board.

The batteries on Raven are not sufficient to run continuously while debugging, so an external 3V supply is recommended. Two AAA batteries make a suitable supply for debugging if no bench supply is available.

The two processors communicate to each other using serial ports. There is an extra serial port on the ATmega1284P microcontroller that is dedicated to the DEBUG function. However, external wires must be added to access this port, and the signal levels are at low logic levels, not the high voltage levels required to drive a computer's serial port.

More information about the Raven board can be found in application note AVR2016.

2.3.3 Raven USB

This is the USB stick that comes with the ATAVRRZRAVEN kit. This board has an AT90USB1287 microcontroller, which includes a built-in USB interface. Building for the RAVENUSB platform includes the driver code for the CDC-USB interface.

The Raven USB board requires that a miniature 10-pin header (supplied with RZRAVEN) must be soldered in for connection to the JTAG debugging port. The JTAGICE MKII programmer will program the Raven USB board. There is not an ISP programming header available on the USB stick.

The Raven USB stick can work as a coordinator, router, end node or sniffer with a CDC-USB interface.

More information about the Raven USB board can be found in application notes AVR2002 and AVR2016.

2.3.4 ZigBit / ZigBit900

These two platforms are small radio modules containing a radio (either AT86RF230 for the ZigBit™, or an AT86RF212 for the ZigBit900) and an ATmega1281V microcontroller.





3 AVR RUM Quickstart

In order to operate the RUM demo application, make sure one of the platforms described in this document has been selected, or that a custom platform has been properly defined in the `hal_avr.h` file. Also the use of an Atmel JTAGICE mkII or AVRISP programmer will be required to program the target microcontroller.

After the target platforms and the programming tools required have been gathered, setup the software necessary for development. For Windows® users, AVR Studio® along with the free WinAVR tool chain can be used and downloaded free from www.atmel.com and www.sourceforge.net. For Linux® users, the tools have to be installed and run individually.

3.1 Source Code

The RUM source code that accompanies this Application Note is spread out over several directories. The core RUM files are located in the `rum_src` directory, and all of the other directories support the uTasker operating system, which is only used with the SAM7X version of RUM.

For AVR nodes, only the `rum_src` directory is needed.

3.2 Compiling RUM

RUM has been written to work with the AVR version of the GCC compiler. AVR Studio will compile and debug the RUM software. Alternatively for Linux, a RUM application can be compiled and debugged using `avr-gcc` and other free tools.

Within the `rum_src` directory, there are three AVR Studio project files that will compile for the appropriate device of choice. There is also a Makefile that can be used with command line tools as well. These projects have all been pre-configured with default compile flags described in the table 3-1 below.

3.2.1 Compile-time Options

Rum is a very configurable protocol stack. Using a few compile-time flags, RUM can be configured to run in a minimal amount of flash (less than 6K), or it can be configured to that handle 6LoWPAN packets, serve data on a periodic basis, and sleeps between readings. In AVR Studio, the compile-time flags described in table 3-1 are entered into the Project Options dialog box. This process is shown in figures 3-1 and 3-2.

Note:

In order to compile a small flash image size for an End Node device, the linker needs to be configured to remove any standard libraries like `printf` and floating point libraries. AVR Studio linker options can be found in the Custom Options tab of the Project options as shown in figure 3-2. The [Linker Options] selection is located in the file list of the left window pane. Linux users can adjust the Makefile to remove these libraries from the command line.

Figure 3-1 AVR Studio RUM Project Options

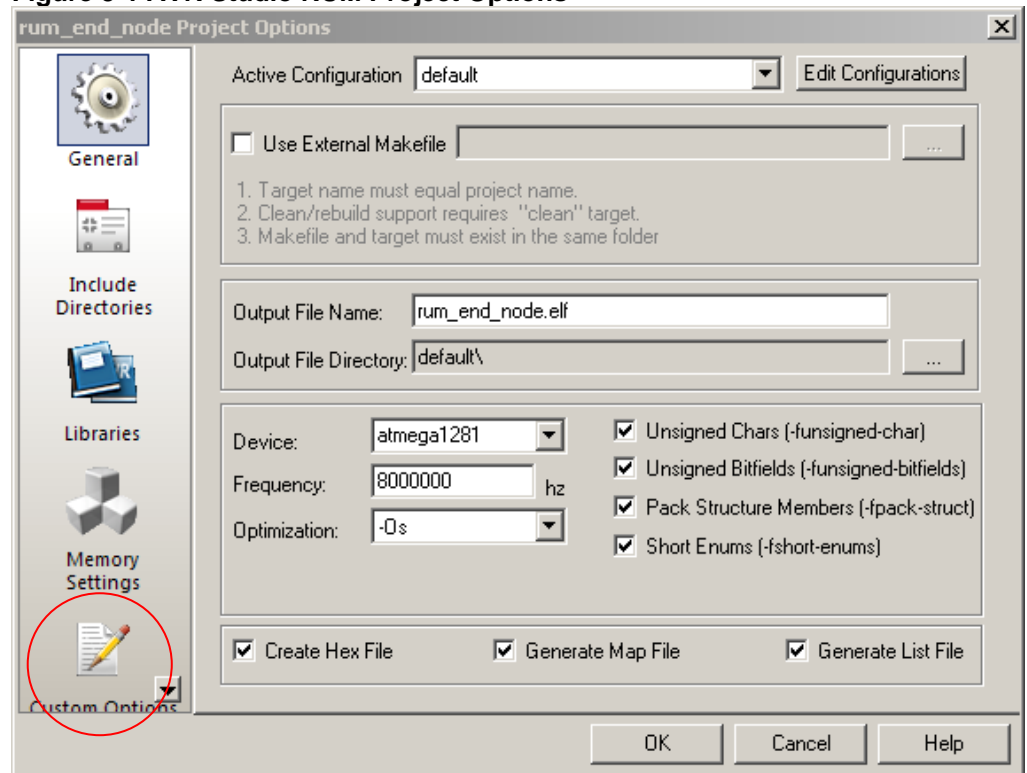
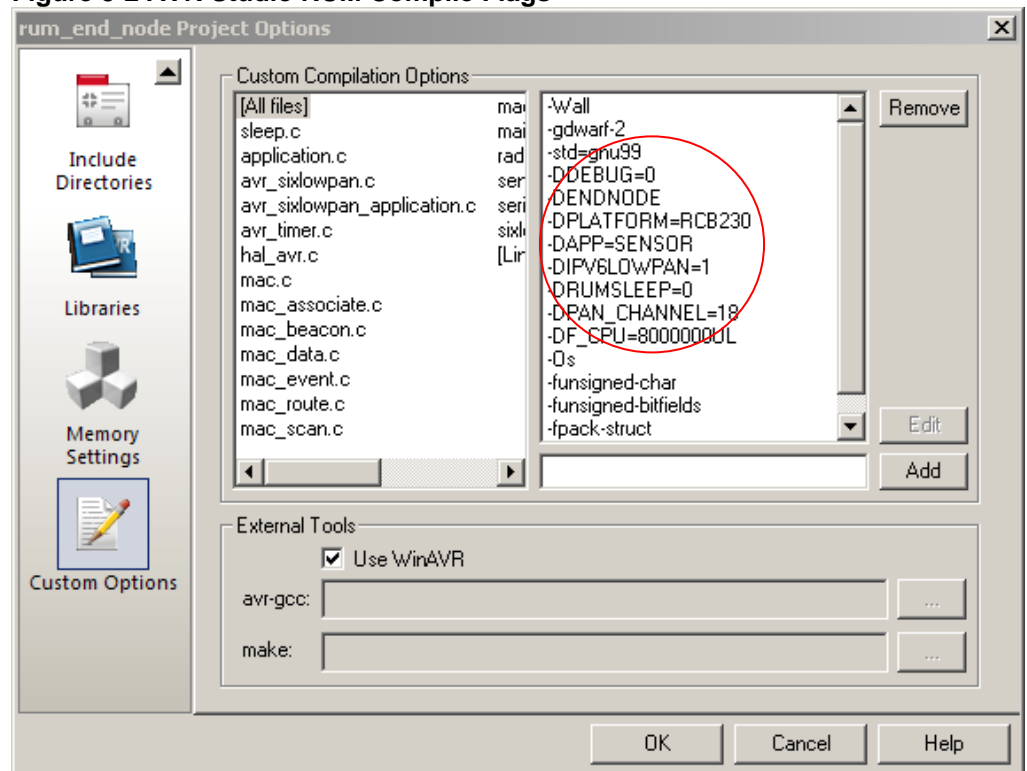


Figure 3-2 AVR Studio RUM Compile Flags





For command line operation using `avr-gcc`, options should be passed on the command line as define (-D) options, such as:

```
avr-gcc -mmcu=atmega1281 -DF_CPU=800000UL -DPLATFORM=RAVEN -o radio.o  
radio.c (etc.)
```

Here is a list of available compile-time flags:

Table 3-1 Compile Time Flags

Option Name	Possible values	Meaning
PLATFORM	RAVEN RAVENUSB ZIGBIT9 ZIGBIT24	Build RUM to work with the given platform. This option can set other options, such as the band the radio operates in (700/800/900MHz or 2.4GHz). Note: Not required for the ARM version of RUM. Set PLATFORM to 0.
COORDNODE	Undefined or 1	Set this variable to cause the node to be a coordinator node. Note: The ARM version of RUM assumes only a coordinator node.
ROUTERNODE	Undefined or 1	Set this variable to cause the node to be a router node.
ENDNODE	Undefined or 1	Set this variable to cause the node to be an end node.
APP	0 (No application) SENSOR IPSO	Compiles in (or leaves out) the sensor application. New applications can be added to the list.
DEBUG	0 1	When DEBUG is set to 1, debugging messages can be sent out the debug port. Also, a simple terminal interface is available in debugging mode (Not all platforms support this with hardware). Note: The definition of SERIAL or OTA_DEBUG must be used in order to use the DEBUG flag.
DEMO	0 1	In demo mode, a node joining the network chooses to associate to the node with the best signal (RSSI). This allows demonstrating multi-hop functionality in a small area. In non-demo mode, a new node chooses its parent based on (in order): 1. Best LQI (Link Quality Indication) 2. Lowest number of hops to coordinator 3. Best RSSI.
RUMSLEEP	0 1	Sleep mode enables the ENDNODE to sleep. If the sensor app (APP=SENSOR) is also compiled in, then the node will sleep between consecutive sensor readings. Note: Coordinators and routers do not sleep, but the RUMSLEEP flag includes code to wake up end nodes and put them to sleep.
WDOG_SLEEP	0 1	Setups the Watchdog timer to act as the timing source for the sleeping operation. Note: If set to 0, sleeping relies on an external 32.768KHz crystal.

Option Name	Possible values	Meaning
IPV6LOWPAN	0 1	Compiles in 6LoWPAN functionality, which gives each node in the network a world-unique IPV6 address, and formats packets according to RFC4944. Without this option, smaller RUM-only frames are used.
SENSOR_TYPE	0 (None) SENSOR_RANDOM_T SENSOR_RANDOM_H SENSOR_THERMIST	Configures the sensor application (APP=SENSOR) to collect data from the given sensor type. SENSOR_RANDOM_T/_H uses a random number generator to create variable temp/humidity data. SENSOR_THERMIST reads a simple thermistor from the AVR's ADC. Note: Not all platforms support this with hardware. SENSOR_TYPE does not apply to the ARM version of RUM.
PAN_CHANNEL	1-4 (700MHz) 0-10 (800/900Mhz) 11-26 (2.4GHz)	Sets the operating channel to a static channel if specified. Leaving PAN_CHANNEL undefined will cause a coordinator node to scan all channels to select a quiet free channel, and will cause router/end nodes to scan all channels to find a network to join. Note: If CHINA_MODE=1, then 700MHz channels are enabled.
PAN_ID	0x0000 - 0xFFFF	Sets a static PAN_ID for the specified network. Otherwise a random PAN_ID will be selected. Note: A static PAN_ID is required for the IPv6 addresses in the demo. See Appendix C.
BAND	BAND2400 BAND900	The BAND flag specifies which radio band to use. For AVR targets, this parameter is fixed for each PLATFORM to its correct value, and should not be directly passed to the compiler as a parameter. For the ARM target, this parameter can be passed as a compile-time option, or directly set in hal_arm.h.
CHINA_MODE	0 1	Sets the use of 700MHz operation for the China band. Note: This mode is only available when using the AT86RF212 (BAND=BAND900).
DATA_RATE_212	BPSK-40	Can be changed to any of the supported operating modes of the RF212. Note: If using CHINA_MODE, the selected data rate is O-QPSK RC 250.
CAL	0 1	Enables the calibration feature with the SENSOR application.
VLP	0 1	This will allow a Very Low Power device to sleep between frame protocol operations (scan, associate, etc) to save power.
SERIAL	0 1	Used with DEBUG to send debug messages to a serial port.
OTA_DEBUG	0 1	Used with DEBUG to send debug messages over the air to the coordinator for processing.





3.3 Build Sizes

This section shows various build sizes using different compile flags described from Table 3-1.

Table 3-2 Various Build Sizes for AVR and ARM

	Coordinator	Router	End Node
Raven USB Coordinator IPv6 off DEBUG on Sensor App SLEEP on	25332 bytes FLASH 4811 bytes SRAM		
Raven - all features IPv6 on DEBUG off Sensor App SLEEP on	(Cannot build IPv6 coordinator on AVR target)	21138 bytes FLASH 1901 bytes SRAM	19280 bytes FLASH 1356 bytes SRAM
Raven without Ipv6 IPv6 off DEBUG off Sensor App SLEEP on	13354 bytes FLASH 2377 bytes SRAM	15218 bytes Flash 1093 bytes SRAM	13208 bytes FLASH 548 bytes SRAM
Raven Minimal Size All options off RUM network only	8864 bytes FLASH 1875 bytes SRAM	7984 bytes FLASH 568 bytes SRAM	5716 bytes FLASH 412 bytes SRAM
SAM7X Coordinator IPv6 on DEBUG on Sensor App SLEEP on	102K bytes FLASH 17K bytes SRAM		

3.4 Fuse settings

The fuses for the AVR platforms vary on the target microcontroller. These fuse settings have been listed below for the appropriate platforms. These fuse settings can be entered into the target of choice using AVR Studio or AVR Dude for command line operation.

Raven (1284p): **0xFE; 0x91; 0xE2**
Raven LCD (3290p): **0xFE; 0x91; 0xE2**
Raven USB: **0xFB; 0x99; 0xDE**
ZigBit/ZigBit900: **0xFE; 0x91; 0xE2**

4 AT91SAM7X-EK RUM Quickstart

The Atmel RUM protocol is integrated to run on the AT91SAM7X-EK board which contains an AT91SAM7X256 microcontroller. Additionally, the IPv6/6LoWPAN layers can be compiled in. Compiling in the IPv6 layer will allow the SAM7X platform to act as an IPv6 Edge Router in addition to an 802.15.4 PAN Coordinator. Furthermore, the SAM7X platform supports all the Atmel 802.15.4 transceivers: AT86RF230, AT86RF231 and AT86RF212.

The PAN Coordinator performs the classical functions defined in section 5.3 of the IEEE 802.15.4-2006 specification. It will start and maintain a non-beaconing network. The edge router functionality will route IPv6 network traffic to the appropriate end and router nodes based on their specific IPv6 addresses. The RUM protocol implementation differs slightly from the IEEE 802.15.4 standard. Please have a look at the documentation of the Route Under MAC (RUM) Protocol described in Appendix A.

The SAM7X provides multiple interfaces for users to interact with the 802.15.4 wireless network. Among these are RS232, USB, telnet and simple direct web interface. The remainder of this section will describe the implementation of low level drivers, radio drivers, timers, uTasker RTOS integration and web interfaces.

4.1 uTasker RTOS

To jump start development and provide a solid foundation for ARM operation, the uTasker RTOS was chosen to build upon. uTasker is not a pre-emptive type RTOS, rather it is a task-event-state driven type. A task was created called *RUM Task* that is responsible for processing radio events as well as timer events associated with the radio protocol. For a complete description of the uTasker RTOS visit www.utasker.com.

In addition to RUM, IPv6, and 6LoWPAN, a FAT file system has been integrated into the uTasker system. For more details see www.efsl.be and the Doxygen documentation. RUM and IPv6 are described accordingly within this document.

Most of the RUM application code to interact with the uTasker RTOS is located in:

- `rumtask.[c/h]`
- `arm_app.[c/h]`

Most of the RUM stack shares the same code base between the SAM7X and the AVR microcontroller platforms. There are, however, specific files that only pertain to the ARM build or the AVR build. Low level files specific to the SAM7X build are:

- `arm_timer.[c/h]`
- `arm_timer_event.[c/h]`
- `hal_arm.[c/h]`

Additional modifications are:

- Enabling a telnet and a user menu interface.
- IPv6 and 6LoWPAN
- The *EFSL* FAT file system

See section 3.3 for specific build size of uTasker and RUM compiled for the SAM7X.





4.1.1 uTasker Patches

Since uTasker is a licensed RTOS, only a binary image has been provided for demonstration purposes. If access to the uTasker source code is required, a license can be acquired via www.utasker.com. uTasker offers excellent licensing programs at no or minimal cost.

With a license to uTasker, the source code can be patched to implement the RUM architecture. These modifications add support for the RUM system and user interaction. For instance, a user interface or menu system allows the user to change the operating channel and other radio values. The code modifications can be found in these files:

Application Level:

- application.c
- application.h
- config.h
- TaskConfig.h
- app_hw_sam7x.h
- debug.c
- webInterface.c
- types.h

Stack Level:

- Tty_drv.c
- driver.h
- Ethernet.c
- ppp.c

Since uTasker is provided in source code form, patch files have been produced for all modifications needed to implement RUM with uTasker. To implement the patch files the following procedure should be followed.

1. Download and Install WinAVR from www.sourceforge.net which provides the patch.exe program needed to patch the uTasker project with RUM source.
2. Open the uTasker OS source code package (only available with a uTasker license from www.utasker.com).
3. Be sure to download uTasker SP4 and apply the service pack to the original uTasker OS source files. (Explained on uTasker website - simple copy and replace files to apply service pack)
4. After the service pack has been installed, locate the upatch.bat and utasker-patch files in the \patch folder within the source download package.
5. Copy these files to the same directory containing the uTasker OS with SP4 (eg. C:\project\... should contain these two files plus uTasker directory).
6. Using Windows Explorer, double click the .bat file to patch the uTasker source for use with RUM. **Note:** Only run this patch procedure once.

This project should now include the original uTasker OS, SP4, and RUM patch files. A test compile can now be tried using the IDE of choice. Appendix D explains two common IDE's that can be configured to compile uTasker with RUM support.

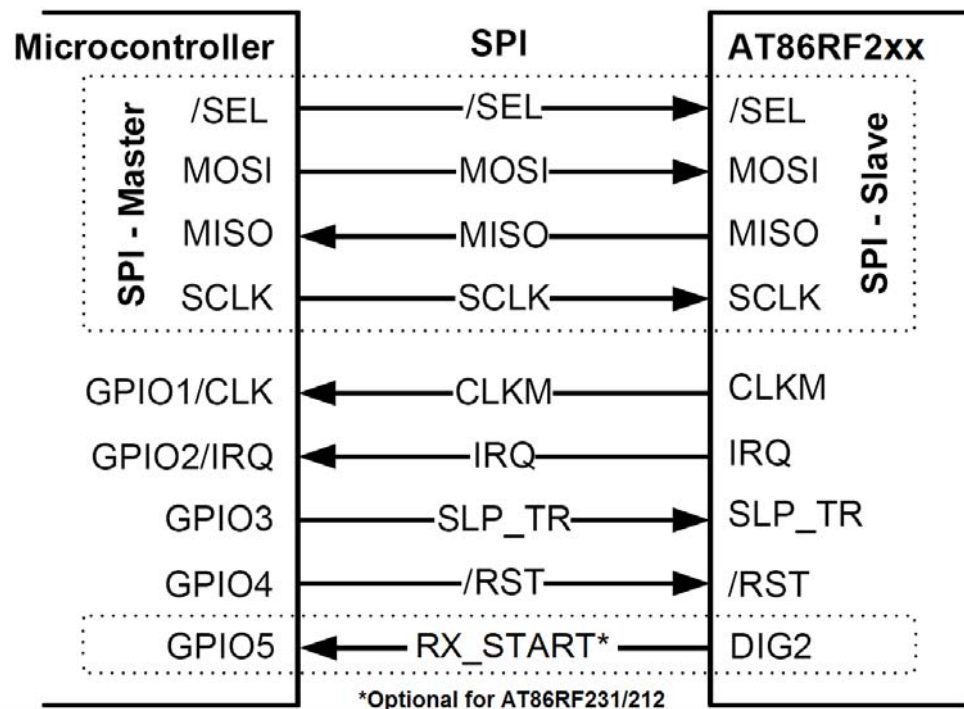
4.2 Radio Interface

The radio interface is composed of two parts - hardware and firmware. The hardware is generally a radio board with physical connections to a microcontroller with the firmware to manage the interface between the two.

4.2.1 Hardware

In order to connect one of the AT86RF2xx transceivers to the microcontroller of choice, the following diagram shows the generic connections needed to interface the two parts.

Figure 4-2-1 Microcontroller to Transceiver Connections



There are various evaluation boards available that provide standalone transceiver evaluation which provide header pins for easy connection to the AT91SAM7X-EK board. See Appendix E for examples of connecting various evaluation boards.

This section highlights the required connections for the SAM7X and any one of the three transceivers. Using the above generic connections, the AT91SAM7X-EK board provides many GPIO pins for connection of the transceiver of choice. The table below shows one method of connecting the two devices together with SPI1 and GPIO.

Table 4-2-1 AT91SAM7X-EK Connections

TRX Pin	SAM7X MCU Pin	Port	Port Function
MISO	56	PA24	SPI1_MISO
MOSI	55	PA23	SPI1_MOSI





TRX Pin	SAM7X MCU Pin	Port	Port Function
SCK	50	PA22	SPI1_SPCK
SEL	49	PA21	SPI1_NPCS0
IRQ	80	PA30	IRQ0
CLKM	70	PB24	TIOB0
SLEEP_TR	13	PA8	PA8
RST	14	PA9	PA9

4.2.2 Firmware

The low level driver code is located in two files:

```
hal_arm.c  
hal_arm.h
```

These files initialize SPI-1 and the discreet IO. Additionally, these files implement handler functions that the remainder of the code uses to interact with the radio. For instance, radio interaction is accomplished through functions such as

```
hal_frame_read and hal_frame_write
```

for receiving and transmitting a frame over the air. Other functions such as

```
hal_register_read and hal_register_write
```

allow access to radio control registers. Please refer to the detailed documentation produced as a result of the integrated Doxygen comments in each source file. The radio registers are fully described in the files *at86rf212_registermap.h* and *at86rf23x_registermap.h*.

4.3 Serial Interfaces

By default, none of the serial interfaces are enabled. Possible serial interfaces are USB and RS232. (There are two RS232 COM ports on the SAM7X board.) The telnet interface provides more than adequate user capabilities without the hassle of configuring a serial interface such as Hyperterminal.

uTasker provides built in serial IO capabilities for RS232 and USB. To enable serial IO for terminal interaction by the user the following defines can be enabled in *config.h*:

```
#define USB_INTERFACE  
#define SERIAL_INTERFACE
```

The baud rate parameters for the RS232 port are:

- 19,200 BAUD
- 8N1

To use the USB connection on a PC running Microsoft Windows, a Windows USB driver must be installed. This USB driver is titled *uTaskerAtmelVirtualCOM.inf* and can be downloaded from the uTasker website site at www.utasker.com/software/softwareV1.3.html and complete documentation can be found at www.utasker.com/docs/uTasker/uTaskerV1.3_USB_Demo.PDF. However,

the source code and precompiled code have USB disabled. Due to limitations on the SAM7X board, if a reset is necessary, the USB cable must be removed and any open USB terminal sessions closed and then the board can be reconnected and the USB terminal session restarted.

4.4 Network Interfaces

uTasker also supports a telnet interface through the RJ45 network connector. The telnet interface is nearly identical to the serial interface. It offers the same menu selections and utilizes the default IP address of 192.168.1.125. This address can be changed with the "I" menu selection. The network interface also provides the connection for the on board simple web server.

Figure 4-4-1 shows an example menu interface. The complete menu commands are fully described in Table 5-1.

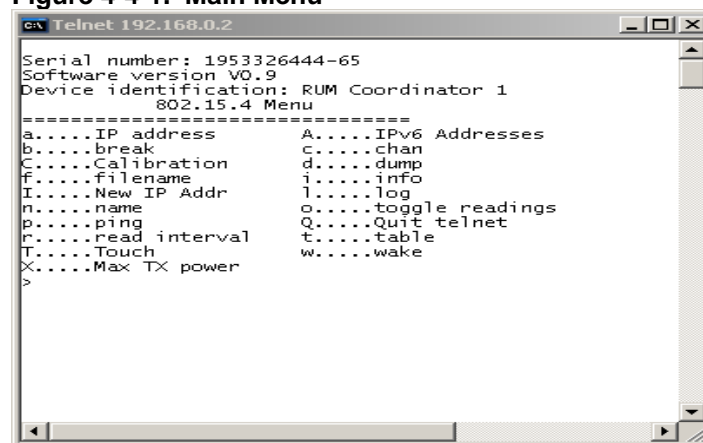
To access the telnet interface, the RJ45 cable can be connected directly to the PC's network interface card or to a hub/router.

Note:

If connecting a PC directly to the SAM7X, the Network Interface Card (NIC) on the computer will need to be configured to communicate on the same IP subnet as the SAM7X.

To start the telnet session simply type "telnet 192.168.1.125" at the DOS prompt and press enter. Alternately, on a Linux machine, type "telnet -e / 192.168.1.125" at the terminal prompt and press enter. The "-e /" defines the escape character. Once the telnet session is started, type "/" and a telnet prompt will appear "telnet>". Type "mode line" and press enter twice to return to the SAM7X telnet session. The "mode line" command forces the Linux telnet session to echo characters typed by the user to the telnet screen.

Figure 4-4-1. Main Menu



4.5 AT91SAM-ICE

The ARM[®] is programmed via the AT91SAM-ICE JTAG adapter, see the web site: www.atmel.com/dyn/products/tools_card.asp?tool_id=3892 for more information on this device. For Linux based systems the CrossConnect JTAG device is recommended, see the web site: www.rowley.co.uk/arm/CrossConnect.htm for more information on this device.





Note:

The SAM-ICE™ JTAG adapter does not work for Linux based systems running the Rowley Crossworks IDE.

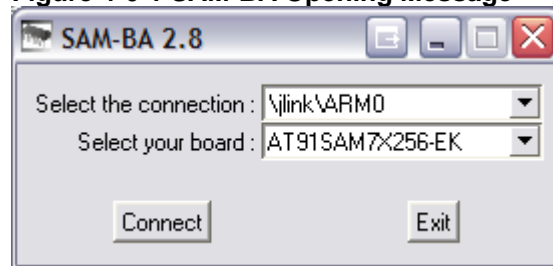
4.6 Loading the Program

In order to load the uTasker RUM demo, the AT91SAM-ICE comes with a SAM-BA® programmer GUI interface. This needs to be installed on the local PC that is directly connected to SAM-ICE JTAG device. The software can also be downloaded from www.segger.com/download_jlink.html. Various methods to program the AT91SAM7X-EK target have been explained in Appendix D, but his method only describes the SAM-BA method.

The SAM-ICE JTAG should first be connected to the USB port of the local PC. This USB driver can be found with the SAM-BA download package. Provided the SAM-BA package has been extracted to the local PC, the USB driver should be installed automatically.

Once the SAM-BA v2.8 program has been successfully installed, open the program and see the image shown in figure 4-6-1.

Figure 4-6-1 SAM-BA Opening Message



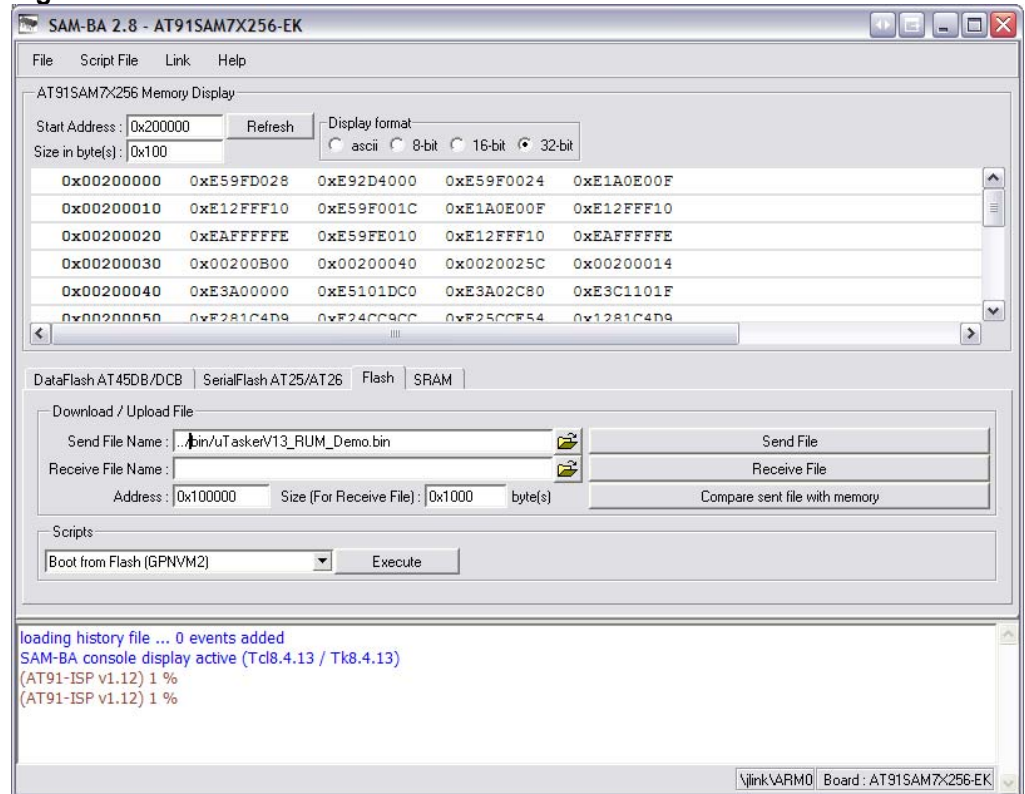
This pop-up window allows the selection of the SAM-ICE JTAG device connected to the local PC. Click the “Connect” button to continue.

The next screen allows for the uTasker RUM demo .bin image to be selected for programming into the AT91SAM7X256. The .bin file can be found in the *bin* folder of the source code package.

Note:

The FLASH tab is selected as the image needs to be loaded into the flash location of the AT91SAM7X256. Be sure the FLASH address is set to 0x100000.

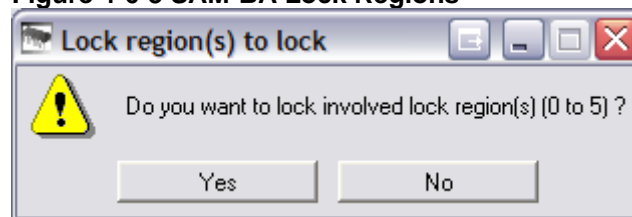
Figure 4-6-2 SAM-BA File Selection



Once the image has been selected in the "Send File Name" field, connect the SAM-ICE JTAG unit to the AT91SAM7X-EK development board. Power on the target and press the "Send File" button.

The programmer will begin communication with the AT91SAM7X-EK board and a lock region message should pop-up shown in figure 4-6-3.

Figure 4-6-3 SAM-BA Lock Regions



Simply select the "No" button to begin programming. Upon completion of programming the target, the SAM-BA interface can be closed which will disconnect the SAM-ICE JTAG programmer from the AT91SAM7X-EK board causing a RESET. The uTasker RUM demo should initialize and begin flashing the DS1 LED on board the evaluation kit at a rate of ~ twice per second.

4.7 Simple Web Interface

In order to connect to the simple web interface, the webpages must first be loaded into the SAM7X via FTP. In the source code package, locate the *web_pages* folder and notice the simple webpage files. If running Windows, open and run the Copy_all.bat file to initiate the FTP transfer. This can be manually done for command line operation.





Once the webpages are transferred, the default IP address of 192.168.1.125 must be entered into the selected internet browser of choice to show the main webserver page.

The simple web interface provides a quick and easy method for allowing the user to find IPv6 address of the *edge router* (SAM7X) as well as the IPv6 addresses of the connected nodes (provided the devices had code compiled with IPV6LOWPAN=1). Additionally, a node can be pinged via its short address. Simply enter the hexadecimal address into the ping address box and click the ping button.

Figures 4-7-1 and 4-7-2 show both pages of the simple web interface.

Figure 4-7-1 Simple Webserver Main Page

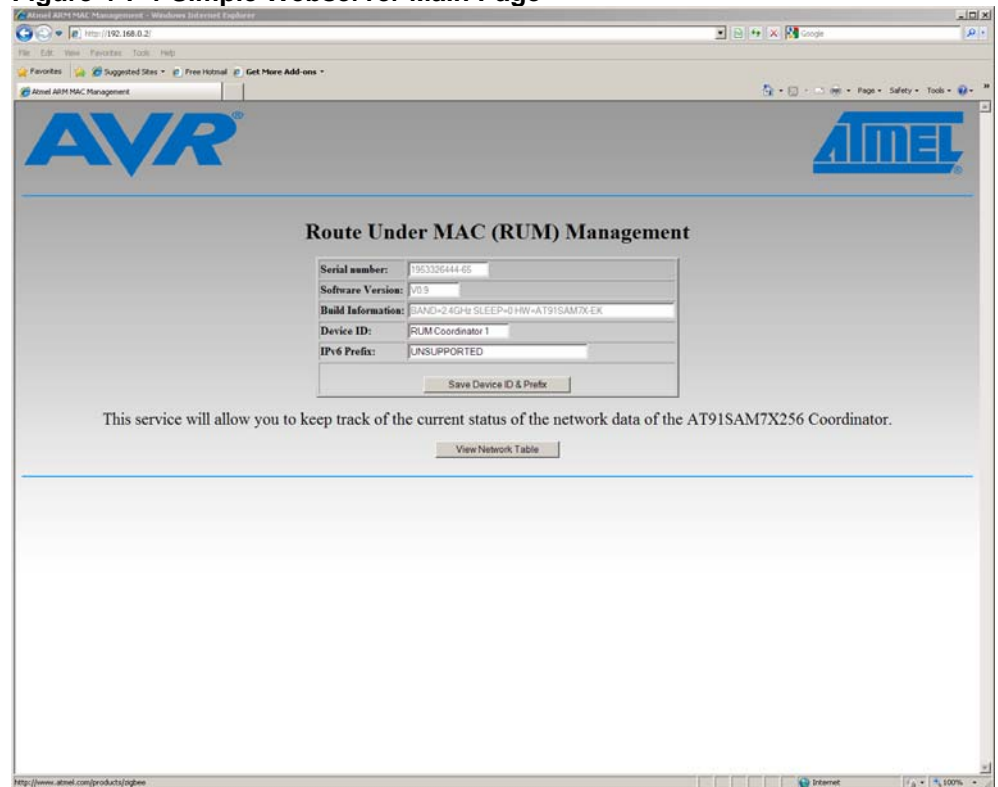
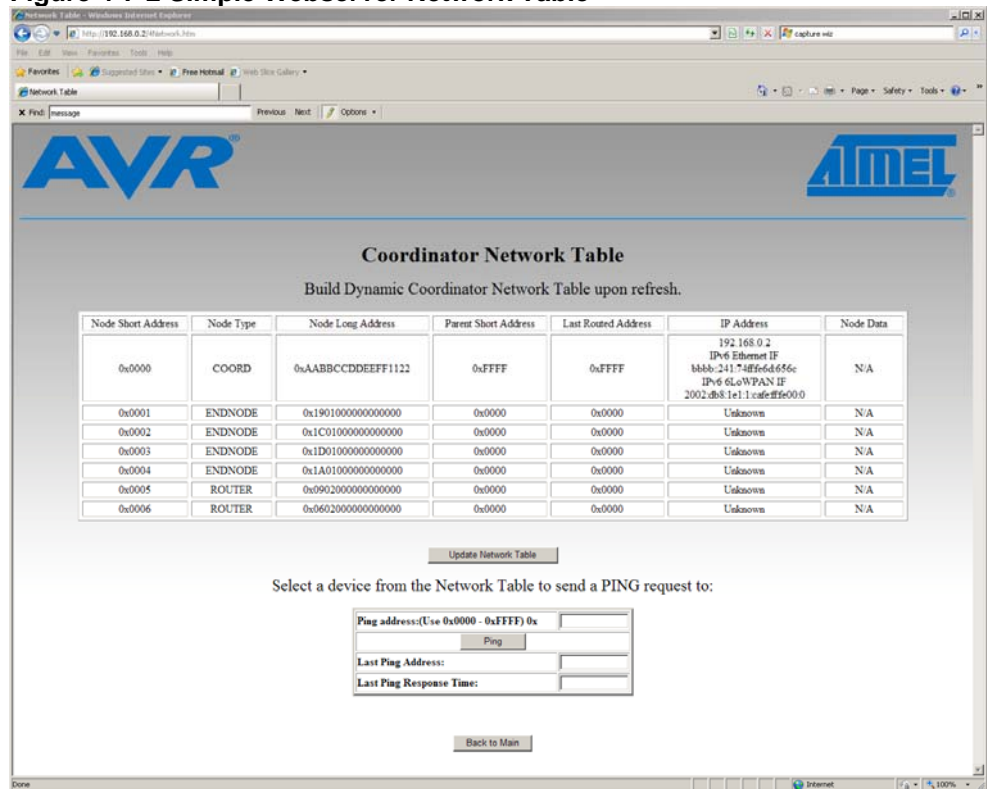


Figure 4-7-2 Simple Webserver Network Table



4.8 SD File Handling

The maximum size of SD card is 2 GB. The card should be formatted as FAT32. Note that the SD file handling is rudimentary. Users needing more advanced file handling can adapt the system as source code is available. See the files in the directory path “../utasker/Applications/uTaskerV1.3/efsl/”. This file system was adapted from www.efsl.be please refer to the originators for comprehensive details.

For the RUM demo described in the next section, it is recommended to initialize (reset) the SAM7X with the SD card inserted. This will allow the EFSL to properly initialize the data logging feature. In Table 5-1, the SD card handling commands are described to demo operation.





5 Running the RUM Demo

Now that all the platforms have been properly configured with RUM, operating the RUM demo without IPv6 is described in this section. It is assumed there is only one PAN Coordinator per network and the PAN Coordinator can be either the AT91SAM7X-EK board with radio interface, or another small AVR 8-bit based platform described in section 2 (see Appendix E for third-party platforms).

Note:

If an AVR based platform is selected, there is no Ethernet interface directly supported, just the optional serial interface. Therefore, any Telnet and Webserver communication will not be available for network control.

5.1 Operation

A PAN Coordinator will start a network by first locating a clear channel to begin operations on. The PAN Coordinator will select a random PAN_ID, unless a static one has been defined during compile time, and will begin accepting association requests from router and end nodes. This mechanism is very similar to that described in section 5.3 of the IEEE 802.15.4-2006 specification.

5.1.1 Network Formation

The network formed by the RUM protocol is a non-beaconing network. After the PAN Coordinator has selected a channel to operate on, other nodes can begin to join the network. The PAN Coordinator will issue beacons in response to beacon requests. When a node wishes to join the network, it will send an association request to the PAN Coordinator and the PAN Coordinator will respond with an association response. From this, the node will retrieve its own short address. For more details about the RUM protocol, see Appendix A.

5.1.2 Application Interface

The typical user interface to a running system with the SAM7X is the telnet menu described in table 5-1. If an AVR platform is used as the PAN Coordinator, a different menu is available via a serial interface described in table 5-2. The simple web server will show a simple network table and allow the user to ping a specific node.

In order to communicate with the SAM7X telnet menu via the default IP address, see section 4.4 for a description on how to configure the SAM7X and the local PC.

5.1.3 Main Menu

The telnet and serial menu selections are meant to be self descriptive however a more detailed description is offered here.

Note:

Many of these are only available with the compile flag APP=SENSOR. Also, for the ARM some of these require the compile flag IPV6LOWPAN=1.

Table 5-1 ARM Telnet Menu Commands

ASCII Command	Description
a (lowercase)	IP Address. This is the current IPv4 address of the SAM7X.
A (uppercase)	IPv6 Address. This is the IPv6 address that has been self configured or configured as a result of connecting to a true IPv6 router.
b	Break. This allows the user to stop collecting data to the SD card.
c (lowercase)	Channel. This allows the user to change the operating channel.
C (uppercase)	Calibrate. Allows the user to calibrate the end node both single and double set points.
d	Dump. This shows the current content of the radio control registers.
f	Filename. This allows the user to set a new file name for data collection on the SD card.
i (lowercase)	Info. This provides a quick display of current radio settings including, PANID, Channel, Short Address, etc.
I (uppercase i)	New IP address. This allows the user to set a new IPv4 address. Once entered the old one will no longer respond.
l (lowercase L)	Log. This will resume data collection to the SD card. It is the corollary to the "b" command.
n	Name. Allows the user to set the name of a node – 11 characters max.
o	Toggle node readings. Nodes report sensor readings on a periodic basis (if APP=1). This allows readings to be displayed as they are received. Does not affect collecting data to SD card.
p	Ping. Ping a user selected node.
Q	Quit. Quit the telnet session.
r	Read interval. Allows the user to alter the interval at which the end or router nodes will report data to the PAN Coordinator.
t (lowercase)	Table. Display a table of nodes and their relationships.
T (uppercase)	Touch. Provides a method to either ping or change the interval of all nodes on the network.
w	Wake. If a node has been loaded with code that allows sleep (SLEEP=1) then it must be woken up before it can respond to commands such as "r".
X	Max power. The PAN Coordinator is set to transmit at the lowest power setting in demo mode. This turns up the transmit power to +3dBm for the RF230 and the RF231. The Max power setting for the RF212 is +8dBm for 900MHz operation and +5dBm for 700MHz operation.



Table 5-2 AVR Serial Menu Commands

ASCII Command	Description
T	Touch. Ping or send a Reading (asks for 'p' or 'r' & interval time).
c	Channel. This allows the user to change the operating channel.
d	Dump. This shows the current content of the radio control registers.
i	Info. This provides a quick display of current radio settings including, PANID, Channel, Short Address, etc.
n	Name. Allows the user to set the name of a node – 11 characters max.
p (lowercase)	Ping. Ping a user selected node.
P (uppercase)	Pause. Pause or un-pause serial display (stop serial input).
r	Read interval. Allows the user to alter the interval at which the end or router nodes will report data to the PAN Coordinator.
t	Table. Display a table of nodes and their relationships.
s	Stream Mode. This will stream ASCII data between any two nodes in the network provided each device has a serial connection to a host PC. Note: <i>This only works for AVR based devices</i>
w	Wake. If a node has been loaded with code that allows sleep (SLEEP=1) then it must be woken up before it can respond to commands such as "r".

6 Running the IPv6 Demo

This demo requires the AT91SAM7X-EK to be used as the PAN Coordinator, due to the Ethernet interface available on the board. The demo is separated into four parts. The first is the 'ping' demo which simply verifies IPv6 network connectivity. The next is the 'UDP' demo which demonstrates remote control of a node. The example sensor application used in section 5 will then be run on IPv6. Finally a TFTP client will be used to load new code onto an end node using IPv6. In these simple demos sleeping will be disabled. Enabling sleep modes will be discussed later.

Familiarity of using the RUM network is required to fully understand these demos. In particular the demo in section 5 should have been followed, verifying the webserver on the coordinator (SAM7X) board can be reached.

In the 6LoWPAN world, the board which connects the 802.15.4 low-power wireless network to the real IPv6 network, be it either Ethernet or WiFi, is called the "edge router". It lives at the edge of the 6LoWPAN network and connects it to the other IPv6 network. In this network the edge router is the PAN coordinator, or SAM7X board.

This demo may be used with full IPv6 internet connectivity if available. This is not required to access the nodes from the local network; it is only required to access the nodes from outside the local network.

The PAN coordinator board and AVR boards must be compiled with 6LoWPAN support enabled. This is set by defining the IPV6LOWPAN macro to '1' at build time on both the ARM and AVR.

6.1 Computer/Network Setup

The demo will require IPv6 support on the host computer. If using Windows XP, type the following at a command prompt to enable IPv6 support:

```
ipv6 install
```

If using Windows Vista®, or any Linux distribution with a kernel 2.24.0 or newer, IPv6 is already supported and enabled.

User interface and debug capabilities are provided through the telnet interface described in section 4.4.

6.2 Ping Demo

Power the coordinator on, with the AVR nodes off. Navigate to the IPv4 address of the webserver on the SAM7X board, and view the *Network Table*. There the IPv6 addresses for each interface will be shown. The board obtains the IPv6 prefix for the Ethernet interface from another IPv6 router if one is detected. If no router is detected, the hard-coded default prefix of 2001:db8:1e1:0::/64 is used and the board advertises itself as the default router.

Note

Since this device becomes the default router, ALL IPv6 traffic on the IPv6 network may be sent to it. However the device cannot actually route this traffic, as it only has a connection to the 6LoWPAN network. If only the 6LoWPAN network is being accessed this is fine; however, if other IPv6 connectivity is requested this will break the network. To avoid this, the SAM7X does NOT advertise itself as a default router when another IPv6 router is detected on the network.





If an IP address for the Ethernet side is not seen, this means an IPv6 router was discovered on the network. However the router is NOT advertising a prefix using stateless auto configuration. Router advertisements must either be disabled on the router, or set the router to allow stateless auto configuration.

The IPv6 prefix for the 6LoWPAN side (aka: 802.15.4 radio) is obtained from the setting on the first webpage. The prefix always has a 64-bit length, and the AVR nodes will acquire this prefix automatically. It may take up to 30 seconds after the board boots for the IPv6 address of the 6LoWPAN side to show up. Refresh the *Network Table* to check if the address is valid yet.

Note

If another IPv6 router is on the network, it must be manually configured to forward any packets destined for the 6LoWPAN network to the SAM7X board. On a Linux-based router the command to run would be:

```
ip -6 route add 2001:db8:1e1:1::/64 via  
2001:db8:1e1:0:1af0:9fff:fee5:18f2
```

This will forward any traffic destined to the 2001:db8:1e1:1::/64 prefix (the RUM IPv6 6LoWPAN prefix) to the IPv6 address of the ethernet interface on the SAM7X board.

Connectivity of the coordinator board should now be tested. At a command prompt, ping the coordinator board's Ethernet address, where the IP address is the one printed on the debug port or on the website. For example:

```
ping6 2001:db8:1e1:0:1af0:9fff:fee5:18f2
```

There should be several ping replies. If not, double-check the IP address of the Ethernet port printed in the debug message or on the IPv4 website.

Next, attempt to ping the 6LoWPAN address of the coordinator board. This proves that the local computer will be able to see wireless nodes. For example:

```
ping6 2001:db8:1e1:1:e789:ff:fe00:0
```

Note that the 6LoWPAN addresses may change on every reboot of the board. The addresses are based on the PAN_ID, which can either be set to a fixed value or set to randomly change. If fixed IPv6 addresses are desired, set the macro PAN_ID to the desired PAN_ID when building. For example setting PAN_ID=0xe789 would give an IP address like above.

Note

If pinging the Ethernet interface is successful but pinging the 6LoWPAN interface fails, most likely there is an IPv6 router on the network which has not been properly configured to forward packets to the edge router board. A rule must be manually inserted into the routing tables that forwards any packets destined for the 6LoWPAN network to the IPv6 address of the Ethernet interface on the edge router.

Finally, the association and pinging of a node can be tested. To do so turn on a node, and check it associates in the IPv4 website. It should appear in the network list, and its IPv6 address will also appear. If no IPv6 address appears, most likely the node does not have IPv6 support enabled.

Then try to ping the node:

```
ping6 2001:db8:1e1:1:baad:ff:fe00:1
```

Several ping replies should be seen, along with an LED blink for each ping on the node. This validates that the 6LoWPAN / IPv6 network is working as expected.

6.3 Using the 6LoWPAN / IPv6 Code on End Nodes

The 6LoWPAN / IPv6 API is documented using the Doxygen documentation system. What follows is an overview of how the example application works, and is not the full API documentation. Refer to Appendix C for the entire API documentation.

The code is designed primarily to pass data around using the UDP protocol. The user application can send data to any arbitrary IP address, or the user can respond to an incoming UDP packet.

A user function is called when a UDP packet is received by the node. The user is told the source port, the destination port, the pointer to memory where the payload is stored, and the size of the payload. To send data back to the device, the user simply replaces the payload with what they wish to send, and returns how much data they have placed in the payload. The stack will automatically send this message back to the source IP address, with the destination and source ports swapped. Since most UDP-based protocols function this way, implementation is made quick and easy.

If more control is required, functions to create an arbitrary UDP packet are provided. Also provided are functions for generating ICMP echo requests destined to any arbitrary address. The stack will automatically respond to any incoming echo requests with an echo response.

6.4 IPSO App Example

The IPSO App demo showcases a wireless sensor reporting system. It uses UDP and allows simple control of end nodes. Running the demo will require the 'netcat6' program, which should come with most Linux distributions. This can be checked by attempting to run the 'nc6' command.

To run the demo, the AVR devices must be built with APP set to 'IPSO' in addition to IPv6 being enabled. The ping demo should still work, and provides a good sanity check.

Note:

To communicate with other IPv6 nodes outside the local network, a native IPv6 connection, or IPv6 tunnel end point, is required. A tunnel can be created by using a tunnel broker such as Hurricane Electric (www.he.net).

Windows users can find copies of netcat6.exe available online at www.sphinx-soft.com/tools/index.html.

Netcat6 is used to simply send and receive raw packets; in this case it is being used for UDP. By typing any ASCII character and pressing enter results in a UDP packet being sent with whatever was typed as the payload. For example, if a user typed 'hello' and pressed enter, then netcat6 will send a UDP packet with the payload as 6 bytes: 0x68, 0x65, 0x65, 0x6C, 0x6F, 0x0A. This is ASCII for "hello" followed by a new-line. If the node responds by sending "Hi There" in ASCII, that will be printed back to the first node.

This allows simple communication with a node without the need for special software. Communication with a node operates like a wireless serial port. The only difference is the node is physically located across the world, and not connected to a local computer with a wire.





The IPSO demo has two parts to it. The first part is an interactive control to allow polling of the sensor and configuration tasks. The second part is to have the sensor automatically send data to a central server.

The wireless sensor node listens on three UDP ports, their use is as follows:

Table 6-4-1. UDP Ports

Port	Description
61616	The sensor will listen for requests on this port
61617	The sensor will listen for data from other nodes on this port
61618	The sensor will listen for administrative commands on this port

Tip

If both the destination and source ports are in the range 0xF0B0 to 0xF0BF (61616 – 61631), 6LoWPAN can compress the destination and source ports, saving four bytes of transmitted data.

The acceptable commands on each port are listed in the next sections.

6.4.1 Commands on Port 61616

The node will accept the following commands on port 61616, and all commands must end with either a line-feed, or carriage-return line-feed combination (<LF> or <CR><LF>).

Table 6-4-2. UDP Commands on Port 61616

Command	Description
T	Get the current temperature. Return value will be 'T22.5' for example for a 22.5 C temperature.
H	Get the current humidity. Return value will be 'H13' for example for 13% humidity.
L	Get the current light reading, from 0-100. Return value would be 'H50' for example.
A	Get the status of the LED. Either 'A0' to indicate LED is off, or 'A1' to indicate LED is on.
A1	Turn the LED on. No return value.
A0	Turn the LED off. No return value.

Unknown commands will result in a return value of the byte 0xFF followed by the unknown command.

As an example connect to the node with netcat6 on port 61616. For these examples <enter> means to press enter, and anything that is underlined is a response back from the node.

```
C:\> nc6 -u 2001:db8:1e1:1:baad:ff:fe00:1 61616 <enter>
T<enter>
T22.5
H<enter>
H50
```

```
A<enter>
A0
A1<enter>
A<enter>
A1
HTL<enter>
H50T22.5L50
A0A<enter>
A0
```

This also demonstrates how multiple commands could be sent at once. The sensor always sends its packets back to the source port specified in the original packet.

Note

If a response is not received, try sending either the 'A1' or 'A0' command to turn on and off the LED. If the LED responds, the node is receiving the message, but the response is not being passed back. Running Wireshark on the interface may provide some useful information, such as if the UDP response packet has an incorrect checksum.

6.4.2 Commands on Port 61618

This is the administrative port, and allows control of various settings in the device. The commands which can be sent are shown in the following table, and must also end with either a <LF> or <CR><LF> combination.

Table 6-4-3. UDP Commands on Port 61618

Command	Description
S2001:0db8:01e1:0000:459D:00ff:fe29:bcf5	Set the server IP address to 2001:db8:1e1::459d:ff:fe29:bcf5
Ds	Set the destination IP of the button press to the server address (aka: what was stored with 'S')
D2001:0db8:01e1:0001:baad:00ff:fe00:0002	Set the destination IP of the button press to the IP 2001:db8:1e1:1:baad:ff:fe00:2
BST22.5	Send the string 'T22.5' to the IP specified with 'D' when the button is pressed.
BP	Send an ICMP echo request (ping) to the node specified with 'D' when the button is pressed
H	Remotely simulate a button press
G	Get the last message received by this node, typically in response to the action occurring on the button press.
C	Clear the last message received by this node.

All commands except for 'G' will be acknowledged with an 'OK' from the wireless sensor.





When setting an IP address, the full IP address must be specified with all zeros present. If the address is short any bytes, the node will respond "length error".

The 'server address' is the IP address which the node automatically sends readings to. The 'button press address' is the IP address which the node sends a certain message to only when the button is pressed.

The 'G' command returns a timestamp in front of the last received message. This timestamp is in milliseconds, and is a 16-bit value. Hence there will be a range of 0 – 65536, after which point the timestamp will overflow back to zero.

As a simple first example, a wireless node will be setup to ping the connected computer. This assumes the computer's IPv6 address is 2001:db8:1e1::459d:ff:fe29:bcf5.

```
C:\> nc6 -u 2001:db8:1e1:1:baad:ff:fe00:1 61618 <enter>
D2001:0db8:01e1:0000:459d:00ff:fe29:bcf5 <enter>
OK
BP <Enter>
OK
H <enter>
OK
G <enter>
[10293] Ping took 13 mS
```

Note that when the 'H' command is issued, this is no different from just hitting the button on the node.

Next let's assume there was another node on the network, and the first node wanted to query the temperature on the second node. The following commands would cause the first node to send the 'T' command to the second node whenever the button is pressed. The 'G' command is then used to receive the data the second node sent the first.

```
C:\> nc6 -u 2001:db8:1e1:1:baad:ff:fe00:1 61618 <enter>
D2001:0db8:01e1:0001:baad:00ff:fe00:0002 <enter>
OK
BST <Enter>
OK
H <enter>
OK
G <enter>
[12313] T22.3
```

6.5 Sensor App Example

The RUM example described in section 5 uses the RUM networking layer to pass messages around. This allows end nodes to communicate with the coordinator to exchange sensor readings, calibration data, etc. With IPv6 support enabled however, these messages can then be passed along an IPv6 link instead.

By passing the messages over an IPv6 link, it does not matter if the sensors communicate directly with the coordinator or with some other computer. As well multiple sensor networks could report to a single coordinator device, even if that coordinator is physically located far away from the other networks. The communication is done using UDP, with a port-number of 61619.

To run this demo, simply compile the AVR end-nodes with APP set to 'SENSOR' and IPv6 enabled. To the end-user it should work exactly the same as the demo in section 5.

The current release of the code always sends the periodic data to the coordinator. This is set up in the `sixlowpan_sensorSendPer()` function, where the line:

```
sixlowpan_hc01_udp_setup_iplocal(DEFAULT_COORD_ADDR);
```

This could be changed to send to a global IP address instead. Currently any incoming data will have a response sent to the source IP address, be on-link or not.

6.6 TFTP Bootloading

The IPv6 example also includes the ability to reload the device's code over the air. Note that this only works when less than half of the FLASH is used – the AVR uses half the FLASH to temporarily store the binary. Once the entire binary is received, it then copies the binary from the upper half of FLASH to the lower half.

This effectively limits the bootloading operations to devices with the ATmega1281 or ATmega1284 parts, such as the ZigBit or RZRAVEN.

To use this feature, use any TFTP client that supports both IPv6 and the Blocksize option (RFC2348). 'TFTP Turbo' version 4.2 or later supports both of these, and is available at <http://corporate.weird-solutions.com/products/tftp-turbo> for both Linux and Windows.

Since this 6LoWPAN layer does not support fragmentation, it is important to limit packet size. For this reason the block size must be specified as 64 bytes. In addition, the file name to load should be as short as possible since the file name will be transmitted. If a long path is included in the file name, this may also be transmitted and cause the message to not be passed over the 802.15.4 network.

The default AVR makefile will generate a file with the `.noboot.bin` suffix. This file has the bootloader code removed, since that section cannot be reprogrammed. This also saves some space, since the entire memory does not need to be transferred.

Assuming the binary is either copied to the TFTP Turbo directory, or the TFTP Turbo directory is in the PATH, the following could be run to bootload the node 2003:db8:1e1:1:baad:ff:fe00:1 with the `ENDrum.noboot.bin` file:

```
tftppcc -p --blksize 64 2001:db8:1e1:1:baad:ff:fe00:1
ENDrum.noboot.bin
```

There may be messages about incorrect ACKs or timeouts. However if the transfer completes, the file was successfully transferred to the AVR end-node. It will automatically reflash the contents of the AVR after receiving the last packet, and then reset the AVR.

If sleeping is enabled, the node will be forced awake during the TFTP bootloading process. This ensures the transfer occurs at the maximum available speed. If the node has Very Low Power (VLP) enabled however, the node is not forced awake as it may have insufficient power for a constant wake. Instead the sleep cycle is changed to a much faster rate – the current code changes to a 200 mS sleep cycle. This allows bootloading to occur at an acceptable rate while still keeping a lower average power draw.





6.7 Sleeping Nodes

A node that spends much its time asleep is good for battery life, but makes IP connectivity harder. If a node only wakes up every 5 minutes, attempting to ping the node will either fail or have a very long latency. The 6LoWPAN sleeping system contains an extension of the RUM sleeping system. The RUM sleep system provides a method to buffer some packets to a sleeping node. The RUM sleep system will buffer packets if memory is available, but does not guarantee a message will be delivered to a sleeping node. The 6LoWPAN sleep system extends this to guarantee buffering of a special 'wake' command to an end node.

To communicate with a sleeping node, simply send messages to that node. When the node awakes the message should be delivered to it, provided sufficient memory was available to buffer the request. Since a node has a message delivered to it immediately when it awakes, it does not need to spend much time awake and hence saves considerable power.

A node can also be forced awake. To use this simply send the 'w' character to port 61618. This specific request is stored by the edge router. When the node awakes the original 'w' message it passed on to the end node. This transmits to the end node the IP address and UDP source port of the requesting computer. The end node will process the 'w' message, announcing to requesting computer it is now awake. The current code sends back the string 'awake' to the requesting computer. The node will then stay awake for a configurable timeout period where the default is seven seconds. If no activity is detected in seven seconds, the node goes back to sleep.

Both the timeout period and the node polling interval are configurable. A short timeout and long polling interval means the node is spending the minimum amount of time awake, and will have the best battery consumption.

The time between the node waking up and checking if it has new data is the 'SIXLOWPAN_PERIODIC_TIME' variable. The time is defined in tenths of a second, and has a minimum value of 1/10th of a second. For example the following would set a 2-second period:

```
SIXLOWPAN_PERIODIC_TIME = 20;
```

The amount of time the node waits before going back to sleep is set by the SIXLOWPAN_TIMEOUT_MS define. This is a value in mS, and has a minimum value of 50 mS and a maximum of 65000 mS. This is defined as a constant in sixlowpan_wake.h:

```
#define SIXLOWPAN_TIMEOUT_MS 7000
```

Additionally an application callback is provided. This will be called after a certain number of SIXLOWPAN_PERIODIC_TIME, and can be used to send periodic sensor readings for example. If this variable is set to '0' the feature is disabled.

```
SIXLOWPAN_PERIODIC_APP_TIME = 15;
```

When using the SENSORS app with IPv6, the periodic app timer is set to a constant of '1'. The periodic time is a user-configurable variable, hence every time the node wakes up the periodic data is sent. This variable is set using the 'r' command described in section 5.

In normal 6LoWPAN applications the SIXLOWPAN_PERIODIC_TIME and SIXLOWPAN_PERIODIC_APP_TIME are set in the sixlowpan_application_init() function. They can also be changed at run-time, for instance to switch to shorter sleep intervals during certain times of the day when power is abundant.

Appendix A - Route Under MAC (RUM) Protocol

A.1 Overview

This appendix outlines the scheme used by RUM for implementing a route-under network, where the routing of network packets is done at the MAC layer. This has a number of advantages:

- Routers and end nodes can be simpler, and therefore less expensive. These nodes manage almost no routing information.
- The coordinator knows all pertinent information about every node in its PAN, which means special “guessing” routing algorithms are not needed.
- Higher level code does not have to be concerned with routing, and has only to send a packet to a destination address.

A.2 Features

- Auto-forming network
- Auto-healing network (re-associates when a broken link is detected)
- Multi-hop routing of data at the MAC layer
- PING packets are defined and implemented at the MAC layer
- Small (~6K) flash code size for end nodes and routers.
- Packets conform to 802.15.4 spec.

A.3 Assumptions

Here are the assumptions about the end application that have led to the design of this networking scheme:

1. End nodes and routers are small, low-cost devices. The single coordinator is larger and more capable. Therefore, each end nodes stores only two short addresses – its own address and the address of its parent.
2. Routers store a table of directly-connected (children) end nodes and router nodes.
3. The end nodes are usually sleeping to save power. Coordinator and router devices are powered all the time. Routers could be configured to be off most of the time, with a configured time slot for synchronized operation. Support for sleeping routers may require an extension to the protocol.
4. The coordinator, routers, and end nodes will auto-form a working network, and packets can be routed to/from any node to any other in the network using only the short address as the destination.
5. Each node can be accessed from outside the PAN via the coordinator.
6. All data packets must be routed through the coordinator.
7. The network is self-healing, so that a broken connection causes a re-forming of network connections. The re-connection is handled at the application layer, so that the parameters for detecting and re-establishing a broken network can be tuned to the application’s performance requirements and environment.



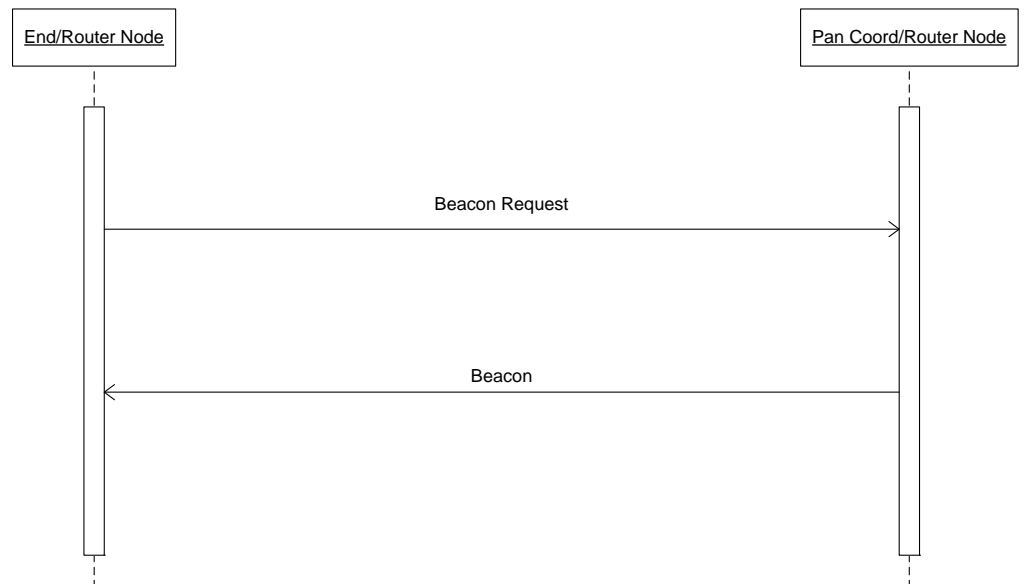
8. Some pre-deployment configuration can be used to determine whether a given node should or can join a given network. This configuration is part of the application, not the MAC.
9. Only short (16-bit) 802.15.4 addresses are used in sending data over the network except during association, since a new node does not have a short address until it is issued one.
10. The coordinator's short address is defined to be 0x0000.

A.4 Implementation Details

A.4.1 End node

The message sequence chart in Figure A-4-1 shows the effect of the end node “scanning” a particular channel by sending out a beacon request and receiving a beacon.

Figure A-4-1 Channel Scan Message Sequence



When the end node powers up, it performs a scan to find a parent node.

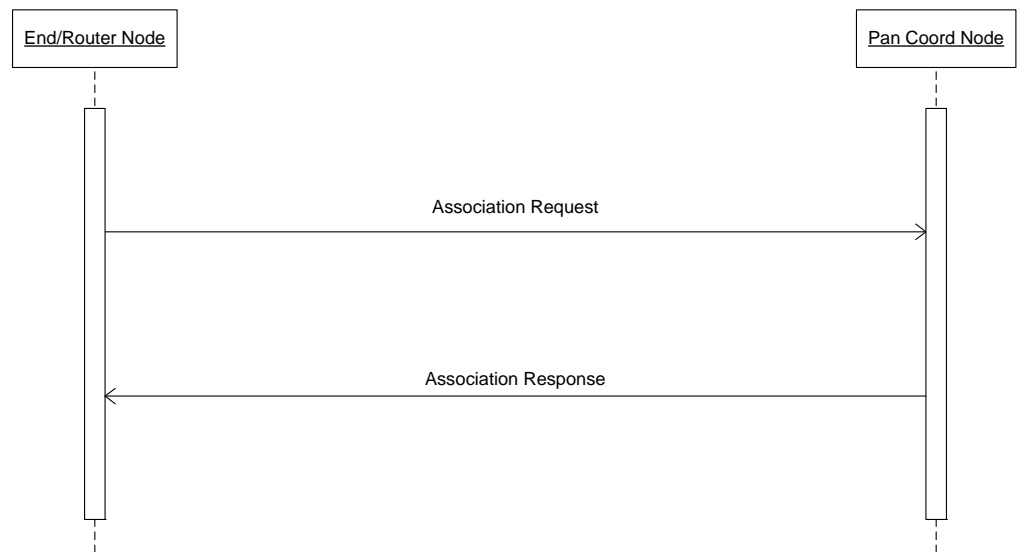
The node sends a beacon request frame on each channel and listens for beacon frames. The node picks a router based on the following criteria:

1. Pick the router/coordinator with the highest LQI value for the link.
2. In event of a tie with LQI, pick the router/coordinator with the lowest number of hops to a coordinator.
3. In event of a tie with hops, pick the highest RSSI value for the link.

Note:

If the compile flag DEMO is set, these criteria above are altered to only find the best RSSI during association. This provides a mechanism to demonstrate multi-hop routing.

Figure A-4-2 Direct Association Message Sequence



The node then associates to its parent as illustrated in figure A-4-2 (above):

The node sends an Association Request packet to the chosen router (or coordinator). The association request payload includes the MAC address of the end node, the short address of the parent router node, and the type of the requesting node (router or end). This request is forwarded to the coordinator, and the coordinator issues a response, which is routed back to the new node.

The node receives an Association Response packet from the router (originating from the coordinator). The newly associated node then stores the two short addresses contained in the association response – its own short address and parent's short address.

When the node becomes associated, it must only store a few bits of information to be connected to the network.

- Its own short address (16 bits).
- The short address of its parent (16 bits).
- The PAN ID of the network (16 bits).
- The channel of the network (8 bits).

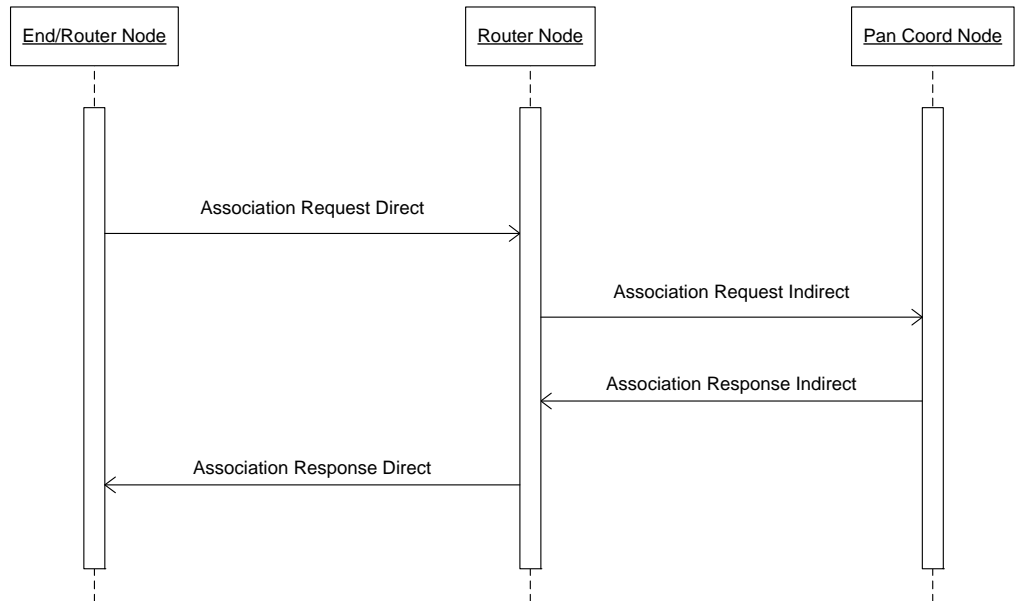
The node sends data to coordinator periodically per the application, via the parent router (or coordinator if the node is directly connected to the coordinator).

A.4.2 Router node

The router node can act as an intermediary between end nodes and the rest of the network. It can either be directly associated with the coordinator, or indirectly through a chain of router nodes. The direct scenario has been illustrated in figures A-4-1 and A-4-2 and the indirect scenario is illustrated in figure A-4-3. A router node can also perform the duties of an end node, sending data readings as the application requires.



Figure A-4-3 In-Direct Association Message Sequence



When a router node starts up, the router does the following steps:

1. Perform the steps that an end node does, as outlined above. This results in the router becoming associated to the network, with a short address and a parent.
2. Listen for beacon requests. For each beacon request, issue a beacon frame. If the router has reached its limit of router/end nodes, or if it has lost its network connection, then it does not return a beacon frame. The beacon frame contains:
 - PAN ID of the network.
 - Short address of node sending the beacon.
 - Special ID byte (application specific).
 - Number of hops to coordinator (zero means that the beacon frame was sent by the coordinator).
3. Listen for frames received from parent or children nodes.
 - Routing frames – this frame has a payload which is a list of short addresses that describe a route through a string of routers to a destination node. For this kind of frame, remove the first short address from the list, and re-send the frame to the short address removed from the list. Also, store the address of the next router in the chain, so that all further data packets will be sent to this child node from now on.
 - For all other frames – dispatch to other nodes in the following order. The word “my” denotes the router’s point of view.
 - If the final destination address is my child node, then send the packet to the child.
 - If the frame was sent from my child node, send the packet to my parent.

- If neither of the above conditions apply, then send the packet to the last routed address used for sending (which was stored from a routing frame).
4. If an association response is received with the router's short address as parent, then add the child node to a table of child nodes and short addresses, and forward the association response to the new child node.
 5. Listen for frames received from non-parent nodes – both end nodes and other routers. Forward all frames to parent. This includes association request frames. Note that a router can only receive frames that are explicitly sent to its short address and PAN ID.

A.4.3 Coordinator node

The coordinator keeps track of every node in the PAN, including the route needed to reach a given node. With each association request/response transaction, the coordinator builds a table that contains information on each node in the network:

Table A-4-1. Coordinator network table

Short Address	Type	MAC address	Parent Short Addr	IPv6 Address	Last Route	Sleeping
2-byte address issued by coordinator at association	End node or router node	The unique 8-byte 802.15.4 address	The short address of the parent of the given node.	Node's IPv6 address	Short addr of last node routed	Flag: is the node sleeping?

- The short address of a node is really the index into the table of the node, so that the address is not explicitly stored.
- The node Type is either end (3) or router (2). The coordinator is Type (1).
- The “Last Route” entry in the table is only used for a node that is a router directly connected to the coordinator. This entry contains the short address of the last destination node routed to that router's tree. This is useful for sending a data packet to a node in the tree without having to re-send a routing packet. The coordinator figures out which router to use to send a routing packet, and if the destination node is the same as “Last Route”, then no routing packet is necessary.

When the coordinator starts, it performs the following actions:

1. Do a scan to find any existing networks, and scan for RF energy at the same time. Pick a free and clear channel and randomly choose a PAN ID. Or, alternatively, pick a pre-defined channel and PAN ID if PAN_CHANNEL and/or PAN_ID compiler variables are set.
2. Listen for beacon request packets from other nodes. Same as step 2 of router node.
3. For each association request, store the new node's information in the network table shown in Table A-4. Then send an association response back to the new node.
4. To send a packet to a child node, a routing packet may be required. Note that a routing packet is only required under certain circumstances:



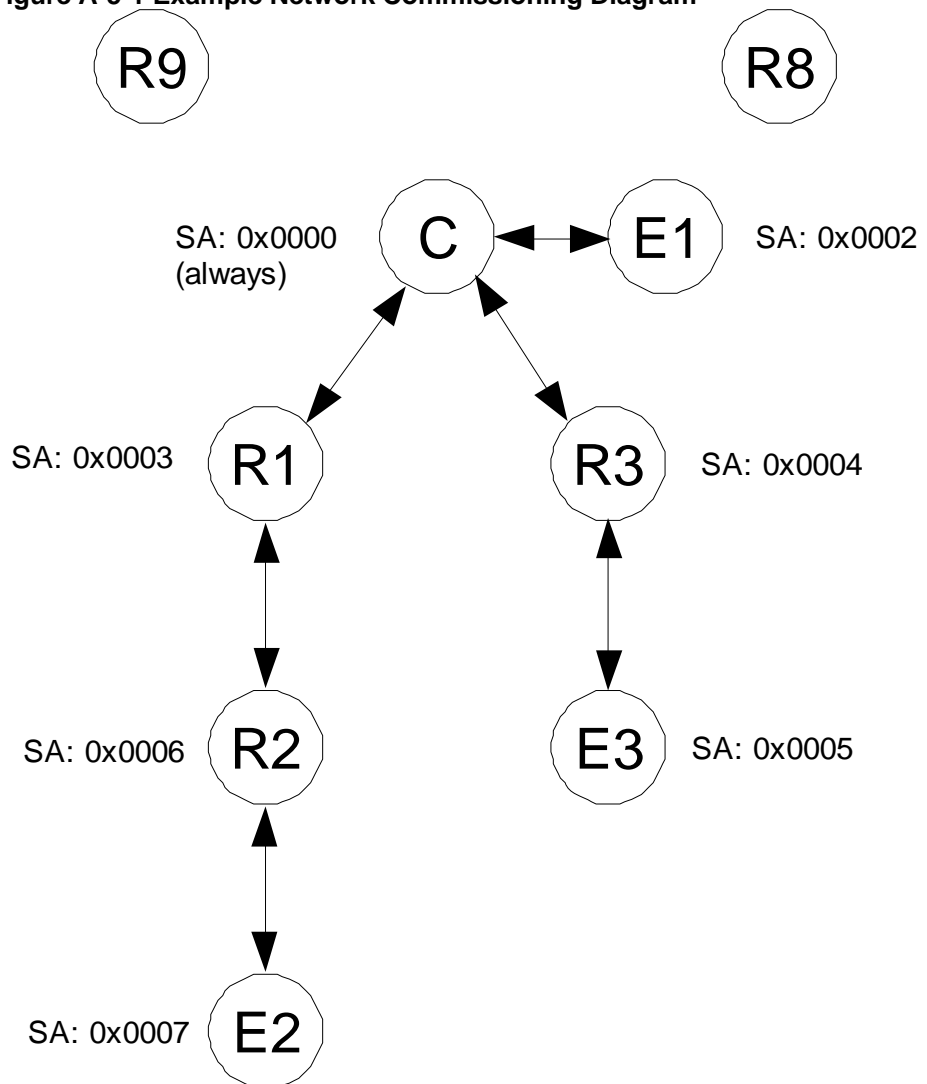


- The destination node must be more than two hops away from the coordinator. For one or two hops, there is no ambiguity in the route, so no routing packet is required.
 - The last time a packet was sent through the top-most router in a sub-tree, the destination address was different from the address of the packet currently being sent.
5. To create a routing packet, the coordinator builds a list of short addresses for each node in the chain to get to the destination node. The coordinator then sends the routing packet to the first router node in the chain. This causes each router in the chain to remember the route for the following data packet(s). The list does not include the destination short address, since the last router in the chain will recognize the data packet's final destination address as the address of one of its own children, and will send the packet on without any explicit routing information.

A.5 Examples of network operation

For the following examples, see Figure A-5-1. Note that IEEE 802.15.4 headers are variable-length, with some fields omitted depending on the value of the various fields within the FCF.

Figure A-5-1 Example Network Commissioning Diagram



Legend:

- C = coordinator
- Rn = Router
- En = End node
- SA = Short address
- FCF - Frame Control Field, see IEEE 802.15.4 Spec.
- SEQ - Frame Sequence Number
- PID - PAN_ID
- CSA - Coordinator Short Address
- MAC - MAC Command Frame ID, see IEEE 802.15.4 Spec.

A.5.1 Example 1 – End node connecting to coordinator

In this example, the coordinator starts, performs a channel scan, chooses a channel and PANID = 0x1234, and always uses short address = 0x0000.

End node E1 starts, does a scan, and finds the coordinator C (and no other beacon).



Table A-5-1. Beacon request and beacon frames

E1	FCF – beacon req 0x0803	Seq 01	Broadcast PAN ID 0xffff		Broadcast short addr 0xffff		07 (beacon req) 0x07	
C	FCF – beacon 0x8000	Seq 01	PID 0x1234	Coord SA 0x0000	Superframe 0x40ff	ID (6=6LoWPAN) 0x06		Hops 0

E1 selects C based on zero hops, and sends association request. The payload contains E1's MAC address, and the SA of the parent. This is called a "direct association request" because the source address is a long (MAC) address and the frame was sent directly from the associating node.

Table A-5-2. Association request frame (direct)

E1	FCF – assoc req 0xC863	Seq 02	PID 0x1234	C SA 0x0000	E1 MAC addr 0x1122334455667788	MAC 01	Parent SA 0x0000	Type 0x03
----	---------------------------	-----------	---------------	----------------	-----------------------------------	-----------	---------------------	--------------

C assigns E1 to its table of nodes, and sends an association response. This is a "direct association response" because the destination address is a long address, so that the frame is sent directly to the newly-associated node.

Table A-5-3. Association response frame (direct)

C	FCF – assoc rsp 0x8C63	Seq 03	PID 0x1234	E1 MAC 0x1122334455667788	Coord SA 0x0000	MAC Cmd 02	E1 SA 0x0002
---	---------------------------	-----------	---------------	------------------------------	--------------------	---------------	-----------------

E1 stores two addresses: its own newly-acquired short address, and the short address of its parent.. In this case the parent is the coordinator C.

E1 sends data to coordinator C as needed.

Table A-5-4. Data packet to coordinator

E1	FCF – data 0x8861	Seq 04	PID 0x1234	Coord SA 0x0000	E1 SA 0x0002	Final Dest SA 0x0000	Origin SA 0x0002	Frame Type 0x01	Payload per application
----	----------------------	-----------	---------------	--------------------	-----------------	----------------------------	------------------------	-----------------------	-------------------------------

A.5.2 Example 2 – Router R1 connects to Coordinator C

Coordinator C has started and has chosen PANID = 0x1234, and short address = 0x0000

Router node R1 starts, does a scan, and finds the coordinator C (and receives no other beacons).

Table A-5-5. Beacon request and beacon frames

R1	FCF – beacon req 0x0803	Seq 01	Broadcast PAN ID 0xffff		Broadcast short addr 0xffff		07 (beacon req) 0x07	
C	FCF – beacon 0x8000	Seq 01	PID 0x1234	Coord SA 0x0000	Superframe 0x40ff	ID (6=6LoWPAN) 0x06		Hops 0

R1 selects C as it is the only available network, and sends an association request.

Table A-5-6. Association request (direct)

R1	FCF – assoc req 0xC863	Seq 02	PID 0x1234	C SA 0x0000	R1 MAC addr 0x3333444455556666	MAC 01	Parent SA 0x0000	Type 0x02
----	---------------------------	-----------	---------------	----------------	-----------------------------------	-----------	---------------------	--------------

C sends association response.

Table A-5-7. Associaton response (direct)

C	FCF – assoc rsp 0x8C63	Seq 03	PID 0x1234	E1 MAC 0x3333444455556666	Coord SA 0x0000	MAC Cmd 02	R1 SA 0x0003
---	---------------------------	-----------	---------------	------------------------------	--------------------	---------------	-----------------

R1 stores two addresses: Parent (coord) SA and R1 SA.

A.5.3 Example 3 – Router R3 connects to Coordinator C

This example is identical to example 2, except that R3 receives a beacon from R1 as well as C. Since the coordinator C node is accessible directly to R3, it ignores R1, because the number of hops are higher than directly connecting to the coordinator C.

A.5.4 Example 4 – Router R2 connects to Network

This example shows a multi-hop node being configured. At the start, assume that routers R1 and R3 are already associated to the network.

R2 powers up, and scans for routers. It gets a beacon from C, R1, and R3. Since C is far away, its LQI is less than R1's LQI, so R2 ignores C and tries to connect to R1, since its signal is stronger than R3's signal.

R2 sends an association request to R1. This is an “direct association request” because the source address is long. All new nodes send a direct request, since they do not yet have a short address.

Table A-5-8. Association request (direct)

R2	FCF –assoc req 0xC863	Seq 01	PID 0x1234	R1 SA 0x0003	R1 MAC addr 0x5555444433332222	MAC 01	Parent SA 0x0003	Type 0x02
----	--------------------------	-----------	---------------	-----------------	-----------------------------------	-----------	---------------------	--------------

R1 forwards the association request to C, after re-arranging the packet into an “indirect association request”, which has both addresses as short.

Table A-5-9. Association request (indirect)

R1	FCF –assoc req 0x8863	Seq 02	PID 0x1234	C SA 0x0000	R1 SA 0x0003	MAC CMD 01	Par SA 0x0003	R2 MAC addr 0x5555444433332222	Type 0x02
----	--------------------------	-----------	---------------	----------------	-----------------	------------------	------------------	-----------------------------------	--------------

C stores R2's MAC address and assigns a short address to R2. It then sends back an association response frame.

This is an “indirect association response” frame, since the response is sent through a router and not directly to the end node. Indirect frames use short addresses for both source and destination.

Table A-5-10. Association response (indirect)

C	FCF – assoc rsp 0x8863	Seq 03	PID 0x1234	R1 SA 0x0003	C SA 0x0000	MAC 02	Parent SA 0x0003	R2 MAC ad 0x55554...	R2 SA 0x0006
---	---------------------------	-----------	---------------	-----------------	----------------	-----------	---------------------	-------------------------	-----------------

R1 receives the frame from C, and notices that the Parent SA matches its own SA. This causes R1 to re-package the frame into a “direct association response” frame, and to store R2's SA in its child table before sending the association response on to R2.



Table A-5-11. Association response (direct)

R1	FCF – assoc rsp 0x8C63	Seq 03	PID 0x1234	R2 MAC addr 0x5555444433332222	R1 SA 0x0003	MAC 02	R2 SA 0x0006
----	---------------------------	-----------	---------------	-----------------------------------	-----------------	-----------	-----------------

R2 saves its parent's short address and its own short address.

A.5.5 Example 5 – End node E2 connects to network

This example shows an end node connecting to the network, through two routers R2 and R1.

E2 scans for routers, and selects R2 based on LQI/hops/RSSI. It then sends a direct association request.

Table A-5-12. Association request (direct)

E2	FCF –assoc req 0xC863	Seq 05	PID 0x1234	R2 SA 0x0006	E2 MAC addr 0x8877665544332211	MAC 01	Parent SA 0x0006
----	--------------------------	-----------	---------------	-----------------	-----------------------------------	-----------	---------------------

R2 forwards the packet to R1, converting it to an “indirect association request”.

Table A-5-13. Association request (indirect)

R2	FCF – assoc req 0x8863	Seq 05	PID 0x1234	R1 SA 0x0003	R2 SA 0x0006	MAC 01	Par SA 0x0006	E2 MAC addr 0x8877665544332211	Type 0x03
----	------------------------------	-----------	---------------	-----------------	-----------------	-----------	------------------	-----------------------------------	--------------

R1 forwards the packet to C.

Table A-5-14. Association request (indirect)

R1	FCF – assoc req 0x8863	Seq 06	PID 0x1234	C SA 0x0000	R1 SA 0x0003	MAC 01	Par SA 0x0006	E2 MAC addr 0x8877665544332211	Type 0x03
----	------------------------------	-----------	---------------	----------------	-----------------	-----------	------------------	-----------------------------------	--------------

C assigns E2 a short address, add E2's SA and Parent SA to its table, sends a routing packet to E2, and then sends an association response to R1.

Table A-5-15. Association response (indirect)

C	FCF – assoc rsp 0x8863	Seq 07	PID 0x1234	R1 SA 0x0003	C SA 0x0000	MAC 02	Parent SA 0x0006	E2 MAC ad 0x88776...	E2 SA 0x0007
---	---------------------------	-----------	---------------	-----------------	----------------	-----------	---------------------	-------------------------	-----------------

R1 forwards the packet to R2.

Table A-5-16. Association response (indirect)

R1	FCF – assoc rsp 0x8863	Seq 08	PID 0x1234	R2 SA 0x0006	R1 SA 0x0003	MAC 02	Par SA 0x0006	E2 MAC ad 0x88776...	E2 SA 0x0007
----	---------------------------	-----------	---------------	-----------------	-----------------	-----------	------------------	-------------------------	-----------------

R2 notices that the new node's parent is R2, and sends a “direct association response” packet to E2, and stores E2's SA in its child table.

Table A-5-17. Association response (direct)

R2	FCF – assoc rsp 0x8C63	Seq 09	PID 0x1234	E2 MAC addr 0x887766...	R1 SA 0x0003	MAC 02	E2 SA 0x0007
----	---------------------------	-----------	---------------	----------------------------	-----------------	-----------	-----------------

A.6 Routing packets

There is a special packet used to create a route for a packet leaving the coordinator toward any router or end node. Each router node keeps track of the last address it sent a routing packet to, and will send each later (non-routing) packet from its parent to the same address (unless the packet is addressed to a child node). This way, the coordinator can send one routing packet to an end node, followed by many data packets. Each data packet will travel the route specified by the last routing packet.

For example, suppose the router has to send a data packet to end node E2. The router simply scans its table of nodes to find out E2's parent, then that node's parent, and so on, constructing a router frame as shown:

Table A-6-1. Routing packet

C	FCF – routing 0x8863	Seq 22	PID 0x1234	R1 SA 0x0003	C SA 0x0000	MAC 0xbb	R2 SA 0x0006
---	-------------------------	-----------	---------------	-----------------	----------------	-------------	-----------------

Note that the end node's (E2) short address does not need to be in the routing packet. As long as the data packets that follow the routing packet end up at R2, then R2 will read the destination address in the data packet and correctly forward the packet to E2, since E2 is a child of R2. R1 does not have to actually send an empty routing packet to R2, since R2 does nothing with it.

Also, note that R1's short address is not in the routing packet. This is because R1 is the first hop in the chain, and R1's address is in the frame header.

In this example, R2 is the only node whose short address is in the payload. If there were more than one intermediate jump, then the nodes closest to the coordinator come first in the payload.

When a node receives a routing packet, it does the following:

1. If there is more than one short address in the packet, then create a new routing packet to the first SA in the list, and remove the first SA from the list.
2. Store the SA of the second address in the list. Until further notice (by a new routing packet), forward any data packet addressed to a non-child node sent downstream to this stored address.

One good feature of this routing implementation is that a routing packet only has to be sent if the receiving node is more than two hops away from the coordinator. For networks that occupy a physically small area, routing packets should rarely be seen.

A.6.1 Data packets

Data is sent in a data packet. Data from an end node is always relayed to the coordinator, and downstream packets are routed in the same path as the last routing packet.

Table A-6-2. Data frame (Coordinator C to Router R1)

C	FCF – Data 0x8861	Seq 34	PID 0x1234	R1 SA 0x0003	C SA 0x0000	Final Dest SA 0x0007	Origin SA 0x0000	Data payload
---	----------------------	-----------	---------------	-----------------	----------------	----------------------------	---------------------	-----------------

When a destination node sees its own short address in the "Dest SA" field, it accepts the data and of course does not forward the packet.





Table A-6-3. End node E2 to Coordinator C via Router R2

E2	FCF – Data 0x8861	Seq 34	PID 0x1234	R2 SA 0x0006	E2 SA 0x0007	Final Dest SA 0x0000	Origin SA 0x0007	Data payload
----	-------------------------	-----------	---------------	-----------------	-----------------	----------------------------	---------------------	-----------------

A data frame from a child node is passed to the coordinator. The source and destination addresses in the 802.15.4 frame header are changed for each hop, but the rest of the frame is unchanged. Final destination and origin addresses do not change as the packet progresses through the network.

A data frame may pass through the coordinator, if the “Dest SA” field is anything but 0x0000 (coordinator’s short address). Any frame the coordinator sends, whether it is relayed through the coordinator or originates with the coordinator, is preceded by a routing packet if necessary.

A.7 Packet Formats

There are only a few packets used in this system, so structures can be pre-defined for each. The key values used to distinguish one frame type from another are the FCF value and the MAC Command byte.

Note that a new MAC command byte of 0xBB has been defined for a routing packet. This is of course non-standard; however, it is not expected that other proprietary networks are able to route RUM packets, so nodes in another network should never have to parse a RUM routing packet.

Table A-7-1. Pre-defined packet types

Type	FCF	MAC CMD
Beacon request	0x0803	7
Beacon	0x8000	-
Association Request- direct	0xC863	1
Association Request- indirect	0x8863	1
Association Response – indirect	0x8863	2
Association Response – direct	0x8C63	2
Routing packet	0x8863	0xBB
Data packet	0x8861	-

Appendix B - Firmware API Overview

This appendix discusses how the RUM firmware is implemented, what Application Programming Interface (API) functions are present, and gives some detail about what functions are called to implement the RUM protocol.

The firmware source, available with this Application Note, has been extensively documented in source code comments. This documentation exists as HTML pages which are generated from the source itself using the Doxygen program. Refer to the Doxygen-generated documentation for a more detailed description of how the firmware operates and complete list of API and functions.

The descriptions of software organization in this appendix apply to the AVR version of the firmware. The SAM-7X version firmware uses a multitasking OS – μ Tasker – to coordinate the various tasks, but the flowcharts below still largely apply.

B.1 Program Organization

The program is structured using a simple “forever” loop in the main() function. The program performs some initialization, and then forever calls some task functions – appTask() and macTask(). These two functions service events generated by interrupt service routines (ISR’s). Examples of ISR’s include the radio interrupt (packet received or sent), timer interrupt, and serial port interrupt.

The main loop processing is called the *foreground*, and the ISR processing is called the *background*. Communication between background (ISR functions) and foreground (main loop) is done with an event queue. The background process stores an event in the queue with the mac_put_event() function, and the foreground pulls events from the queue with a call to mac_get_event(). In this way ISR events can be handled without clobbering foreground processing.

Figure B-1 shows this overall scheme.

The main() function configures the system before entering the main loop. Most of the hardware setup is done in the applnit() function. Figure B-2 shows the major events that occur as a result of calling applnit. A coordinator node will create a new network with itself at the center, and a router or end node will connect itself (associate) to the closest available network.

If the node fails to find or associate to an existing network, the scan process is started again after a one second delay.

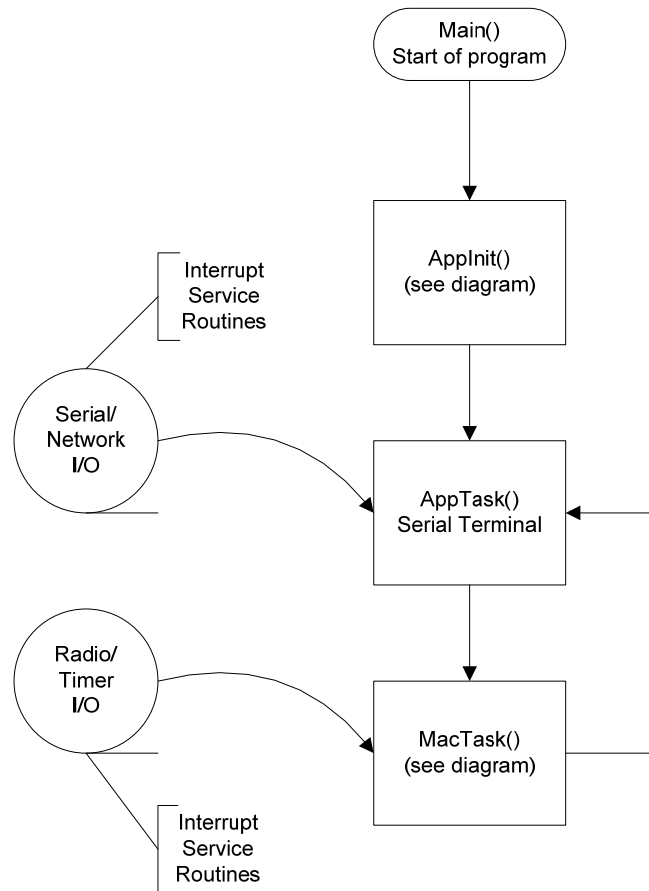
Figure B-3 outlines the macTask() function. This is called very often from the main “forever” loop, and handles events that have arise from interrupt routines. There is an event queue that stores the interrupt events in FIFO order, and macTask() retrieves items from the queue and processes each one in the order in which the events were received. Every event except for serial character I/O is handled by macTask().

The flowchart in Figure B-4 shows how macDataIndication() dispatches received data frames. A “data frame” here means a frame with the *Frame Control Field* element *Frame Type* set to type “data” per the IEEE 802.15.4 specification. Data frames application data, ping request and response frames, drop child command frames, and 6LoWPAN frames.

Figure B-6 shows the flowchart for the radio’s interrupt service routine (ISR). The AT86RF2xx family has one interrupt pin, so the ISR must determine what event caused the interrupt and then dispatch the event to the appropriate routine for processing.



Figure B-1 Overall Program Structure.



If a frame was received by the radio, it is transferred from the transceiver into a receive buffer in the host processor. End-of-transmit interrupts and energy detect interrupts are dispatched from the ISR and values stored for later processing from the main loop.

Figure B-2 applnit overview

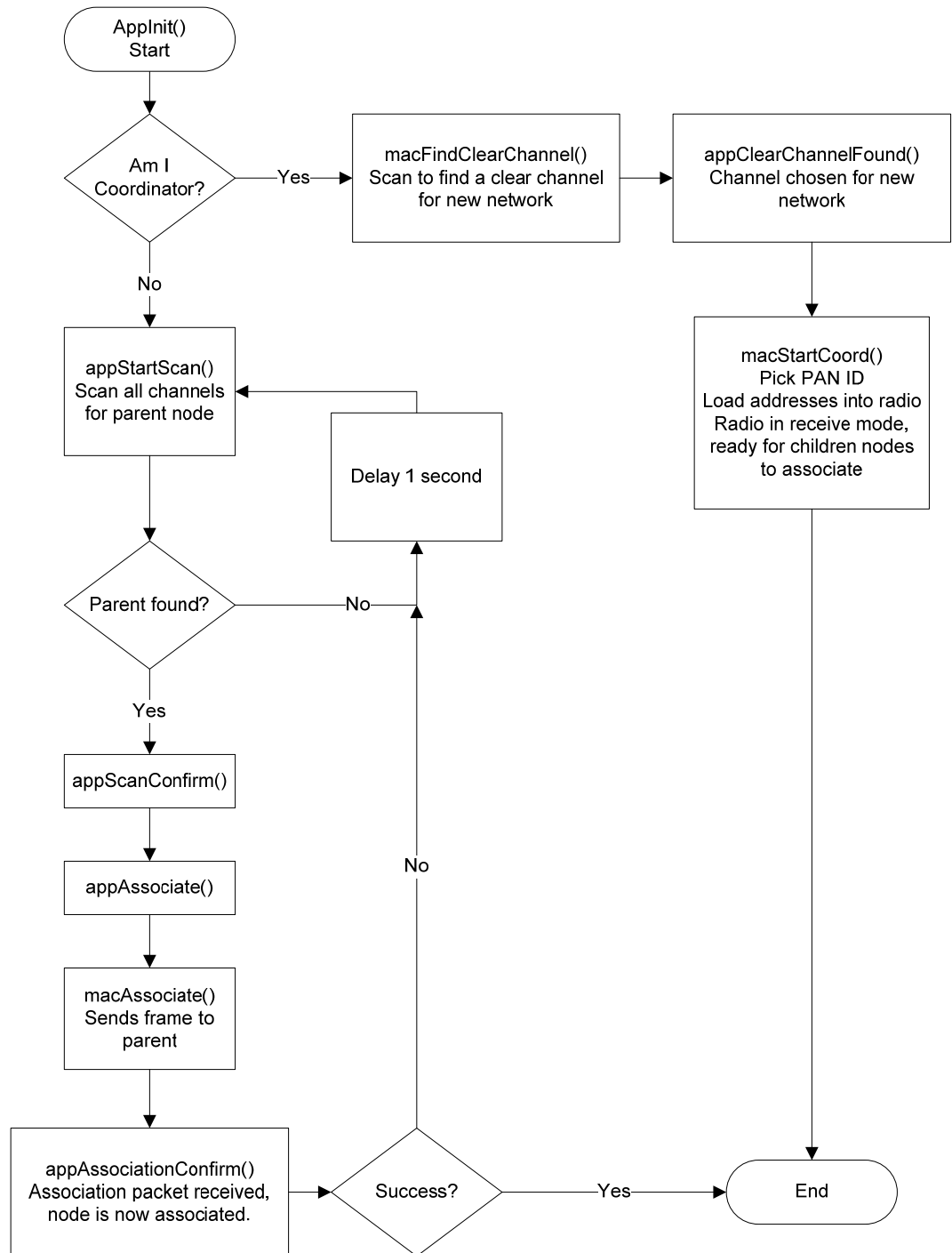


Figure B-3 macTask overview

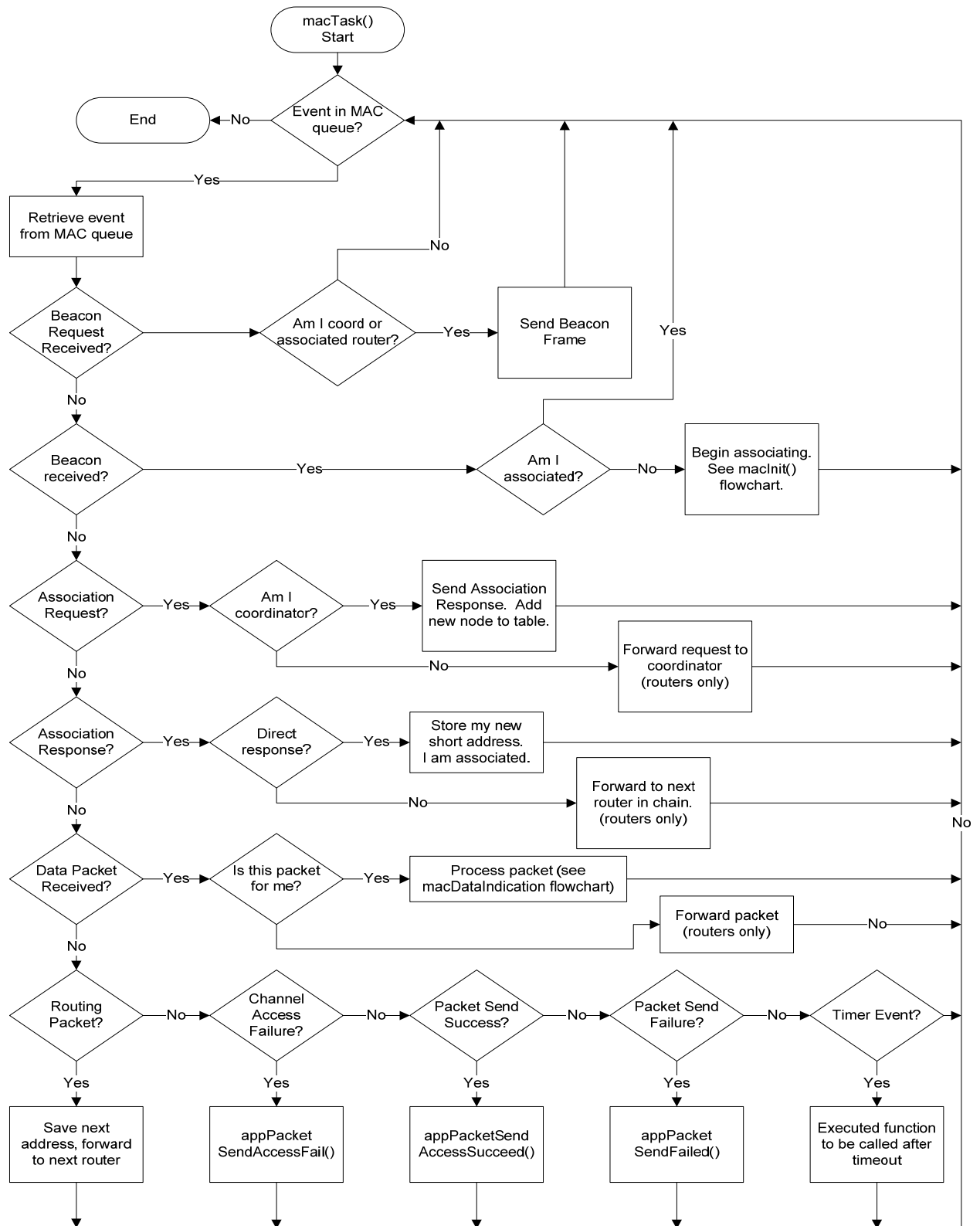


Figure B-4 macDataIndication overview

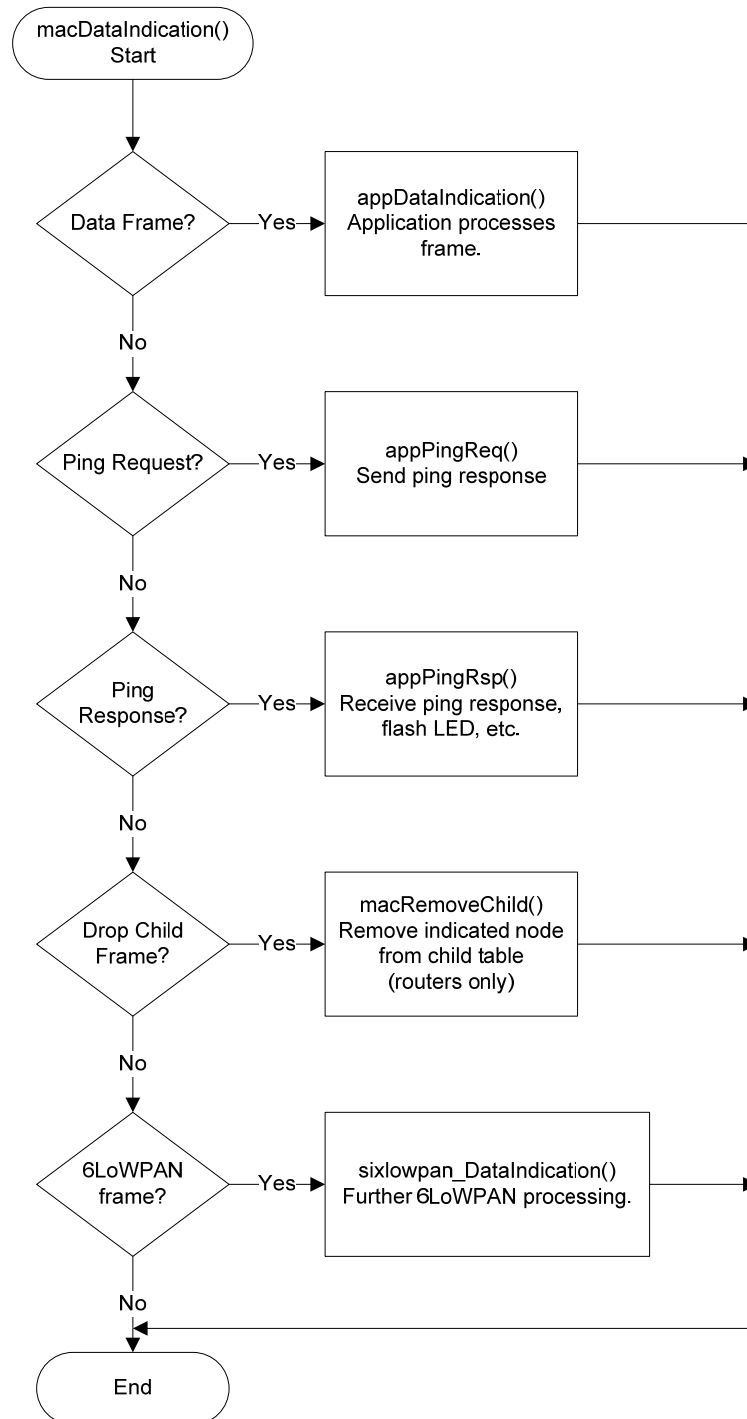


Figure B-5 Frame routing overview

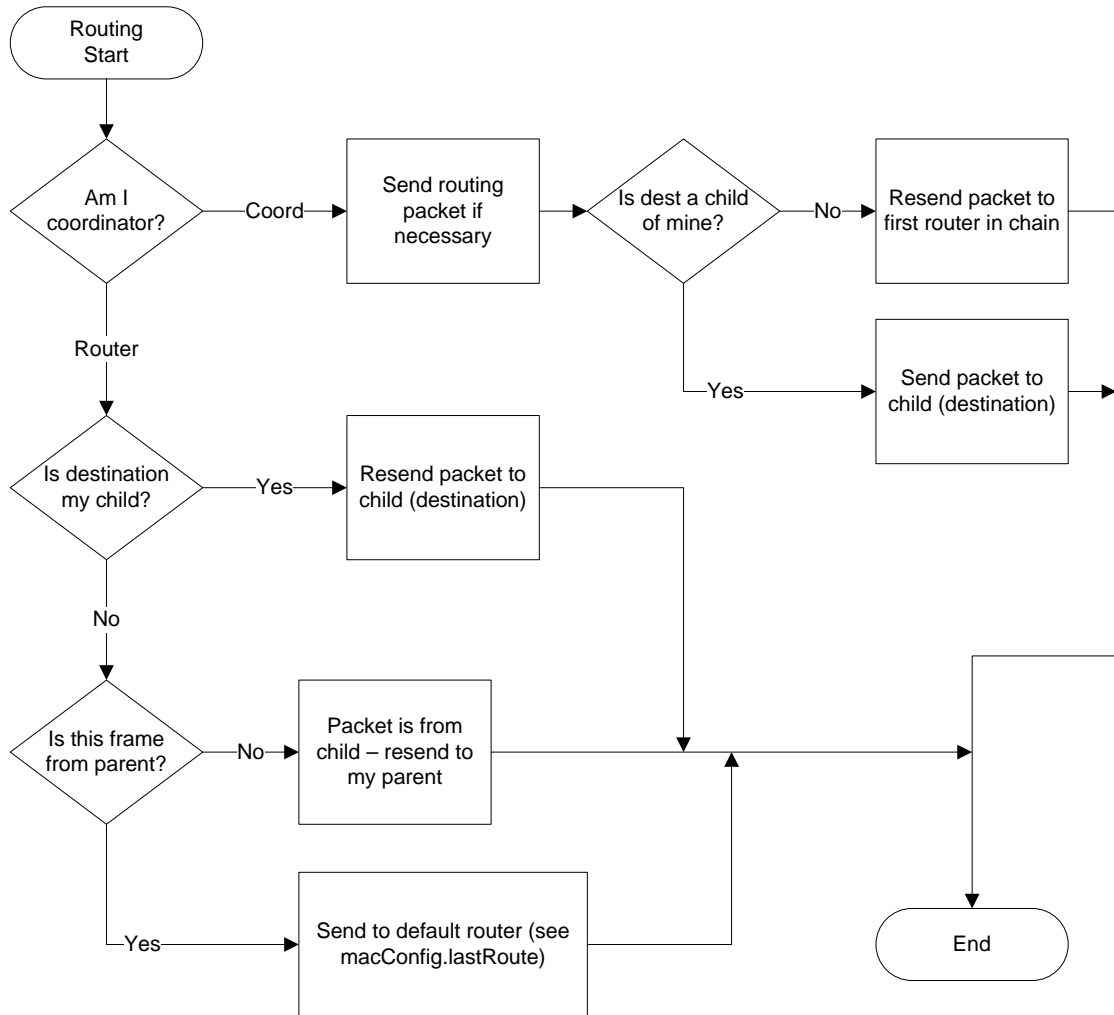
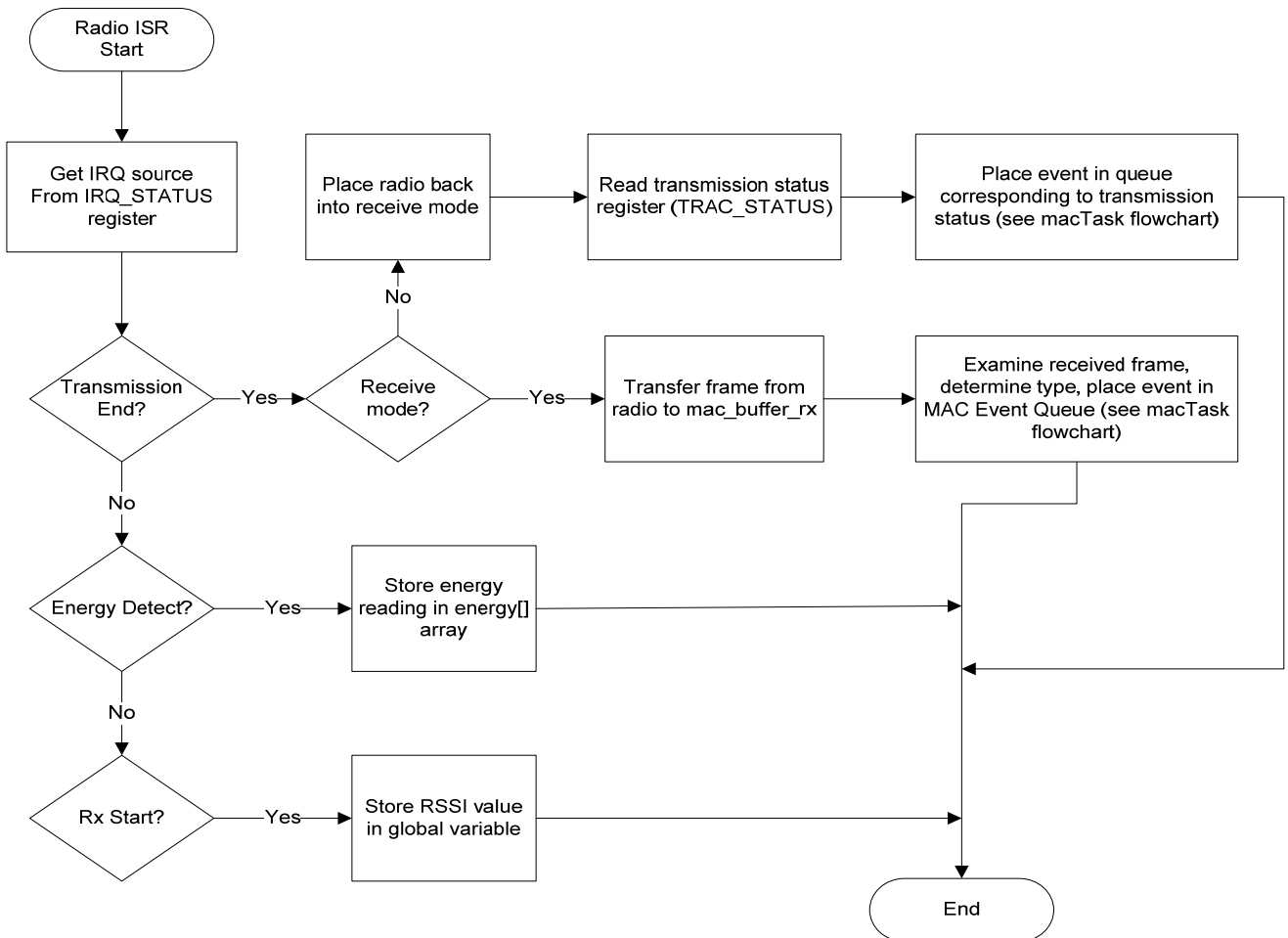


Figure B-6 Radio ISR overview





The flowchart shown in Figure B-5 shows how the RUM protocol routes packets. Most of this processing occurs in the `macRouteData()` function. The flowchart shows that just a few simple rules are needed to route packets to their destination.

B.2 RUM API

An application talks to the MAC by using a few function calls in the MAC, and the MAC communicates events back to the application by calling pre-defined callback functions. The relevant MAC functions and the callback functions are listed in the header file `system.h`.

B.2.1 Coordinator commands

- **macFindClearChannel()** is called on startup. The new coordinator node finds a clear channel by doing an energy scan and finding the quietest channel. Alternatively, a pre-defined channel can be set in `PAN_CHANNEL`.
- **appClearChanFound()** is called when the scan is complete. The coordinator chooses a channel and PAN ID by calling **macStartCoord()**, and is then ready for operation.

When the coordinator receives a beacon request, it calls **sendBeaconFrame()**, which sends a beacon back to the requester.

When the coordinator receives an association request, it calls **macAssociationResponse()**, which stores the new node's information in the coordinator's network table, and issues an association response frame.

B.2.2 Router and end node commands

On the router/end node side, several functions are called in sequence associate to the network. The timing of these calls are regulated by the MAC's timer module, by making calls to **macSetAlarm()**.

- **macInit()** is called to initialize the radio and the MAC.
- **macScan()** is then called to search for a network to join. This causes the node to send out beacon request nodes on every channel, and to record the beacons it gets back. The best node is chosen.
- **appScanConfirm()** is called when the scan is complete. If the scan was successful, then **appScanConfirm** calls **appAssociate**, which in turn calls ...
- **macAssociate()** - this sends an association request to the coordinator (sometimes via intermediate nodes), and processes an association response packet with ...
- **appAssociateConfirm()** is called when the node either associates successfully, or times out waiting to associate.
- After the nodes have associated the `macConfig.associated` flag is set to true and, all nodes communicate using the same functions:
- **macDataRequest()** is called by the sending node, or **macPing()** is called to ping another node. The MAC calls back to either **appPacketSendSucceed()** or **appPacketSendFailed()**.
- **macDataIndication()** is called by the MAC if a packet is received that is addressed to this node.

For more detailed examples of association and sending sensor data, see MAC function calls and Sensor application function calls.

There are a few other useful functions that the MAC offers. These functions are useful for making a non-networking application, such as a remote control unit.

- **macIsChild()** reports on whether a given node is a child of this node.
- **macSetOperatingChannel()** can be used to manually set the radio channel.
- **radioGetPartnum()** will query the Atmel transceiver and return the part number.
- **radioGetSavedRssiValue()** returns the last measured received signal strength indication (RSSI) value for a received packet.
- **radioGetSavedLqiValue()** returns the last measured link quality indication (LQI) value for a received packet.
- **radioGetOperatingChannel()**
- **radioGetTxPowerLevel()** and **radioSetTxPowerLevel()** set and read the output RF power levels
- **radioBatmonGetVoltageThreshold()**, **radioBatmonGetVoltageRange()**, **radioBatmonConfigure()**, and **radioBatmonGetStatus()** are used to work with the RF2xx on-board battery monitor function.
- **radioGetClockSpeed()** and **radioSetClockSpeed()** allow the use of the RF2xx CLKM signal, which can be used to clock the CPU or provide an accurate timebase to calibrate any other oscillator.
- **radioEnterSleepMode()** puts the transceiver to sleep and **radioLeaveSleepMode()** wakes up the transceiver.
- **radioSendData()** sends a "raw" packet over the radio. This is a lower-level function that RUM uses to send data to another node.
- **radioRandom()** returns up to 8 bits of random data, created from the random radio noise on the RF2xx radio. The RF230 does not have a random number generator, so the radioRandom function only returns a random number from the rand() system function.
- **nodeSleep()** Puts the entire node to sleep for a specified time.

Other MAC parameters reside in the macConfig structure. While this structure is not meant to be used by the application directly, several useful parameters are available for reference:

- **longAddr** - The long (MAC) address of this node
- **associated** - True if this node has been associated to a network
- **panId** - The PAN ID of this node
- **shortAddress** - the short address of this node
- **parentShortAddress** - the short address of this node's parent
- **currentChannel** - the current radio channel selected

The timer module can be used by an application to execute functions after a non-blocking delay.

The Serial Port module provides a serial port for the AVR targets.



B.3 6LoWPAN API

This group of functions is used to send a UDP packet to a node either on the wireless network ('iplocal') or somewhere outside the wireless network ('ipglobal'). The source and destination ports are set, the payload loaded, and finally the UDP packet is sent. The Doxygen documentation provides specific examples.

- `uint8_t * sixlowpan_hc01_udp_setup_ipglobal(void)`
- `void sixlowpan_hc01_udp_setup_iplocal(uint16_t addr)`
- `void sixlowpan_hc01_udp_setup_ports(uint16_t srcport, uint16_t destport)`
- `uint8_t * sixlowpan_hc01_udp_get_payloadptr(void)`
- `void sixlowpan_hc01_udp_set_payloadsize(uint8_t size)`
- `void sixlowpan_hc01_udp_send(void)`

This function below is called on the AVR when a UDP frame is received. The UDP payload is pointed to by *payload* and is of length *payloadlen*. After the frame is processed, a message can be sent back to the source port and IP address by copying a new payload into the *payload* pointer. The return value indicates how many bytes to send back – a return of zero results in no response sent back. The *payloadmax* parameter indicates the maximum allowable payload that could be sent. This function is written by the user, an example is provided in the `sixlowpan_application_example.c` file.

- `uint8_t sixlowpan_udp_usercall (uint16_t sourceport, uint16_t destport, uint8_t * payload, uint8_t payloadlen, uint8_t payloadmax)`

The following group of functions is used to send an ICMP Echo Request (ping) to a remote IP address. The Doxygen documentation contains an example of how to use this to ping an end node.

- `uint8_t * sixlowpan_hc01_ping_setup_ipglobal (uint8_t sequence)`
- `void sixlowpan_hc01_ping_send (void)`

The next function is called when an ICMP Echo Response is received. The *sequence* holds the sequence number of the returned ping.

- `void sixlowpan_ping_usercall (uint8_t sequence)`

This function below handles an incoming RUM frame that is flagged as containing 6LoWPAN data. It copies the frame to another buffer, and calls the `sixlowpan_hc01_process()` function on the AVR. This function performs any needed actions – responding to Neighbor Solicitation, storing information from Router Advertisements, responding to Echo Requests, and calling user functions if data is received. The 6LoWPAN and IPv6 stack on the ARM device are based on uIPv6 integrated into Contiki. See www.sics.se/contiki and the RUM source code for integration details. This process is shown for AVR devices in figure B-7 and for ARM devices in figure B-8.

- `void sixlowpan_DataIndication(ftData * frame, uint8_t payloadlen)`

Figure B-7 AVR 6LoWPAN DataIndication

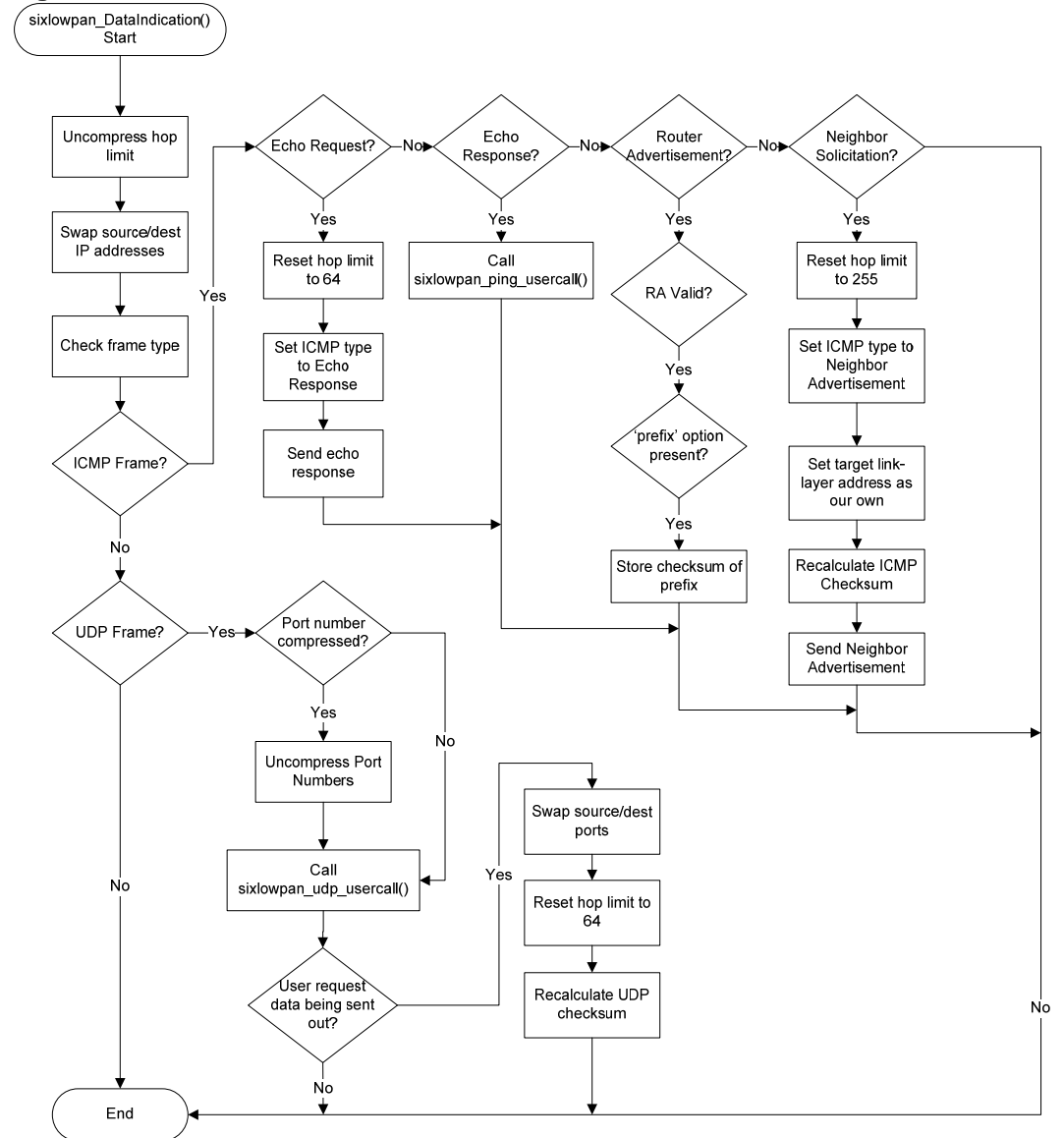
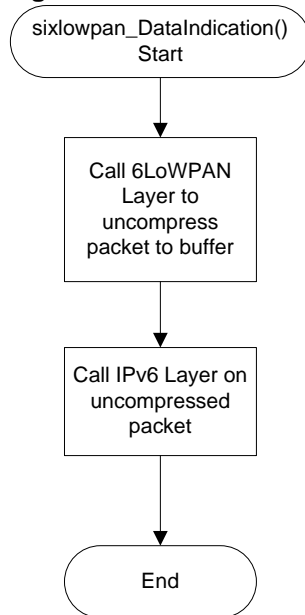


Figure B-8 ARM 6LoWPAN DataIndication



B.4 Writing a Custom Application Using RUM

RUM is meant to be a base upon which a custom application can be written for a wireless product. There are a few steps to doing this.

- Make sure the hardware is compatible with RUM.
- Add a new PLATFORM definition to RUM for the new hardware.
- Verify that the transceiver is talking to the microcontroller.
- Verify that the RUM network is working on the hardware.
- Add the application code to the project.

Each of these steps is covered in detail. An AVR target is assumed in this section.

B.4.1 Step 1: Make sure the hardware is compatible with RUM

To work with RUM, the design must contain an AVR or ARM processor that is supported. As of this release, RUM has been proven to work with these microcontrollers:

- ATmega1281
- ATmega1284P
- ATmega88P, 168P, 328P
- AT90USB1287
- AT91SAM7X256

Almost any AVR can be made to work with RUM, as long as it includes an SPI interface, as all of the AT86RF2xx transceivers interface with the microcontroller over SPI. In addition to the SPI interface, the radio has an IRQ output that must be supported as an interrupt on the AVR. This can be an external interrupt, pin change interrupt, or timer capture interrupt. The 'RF230 has a rising edge interrupt signal,

and the RF231 and RF212 radios can be configured for rising or falling edge via the IRQ_POLARITY register value.

In addition, there are some GPIO signals that must be connected to the microcontroller:

- RST – Reset signal, active low
- SLP_TR – Sleep/Transmit signal. See radio datasheet for details.
- CLKM – Optional clock output from the radio.
- SCLK – SPI clock
- MOSI – SPI Master Out/Slave In signal
- MISO – SPI Master In/Slave Out signal
- SEL – Radio select line, active low.

Note that the transceiver can operate on a supply of 1.8V to 3.6V, while the microcontroller may have a different operating range. Be sure both devices operate from the same supply voltage, or that the appropriate level-shifting circuitry has been added.

On some AVR microcontrollers, the SPI interface pins used to connect to the radio are shared with the ISP programming port. This can cause difficulty connecting to the target processor, as the transceiver's select line can float high, causing the radio to drive the MISO line, which interferes with ISP function. The solution to this problem is to put a pull-up resistor on the radio SEL (select) line. If this resistor causes excessive sleep current, it may be removed after programming the AVR.

Affected AVR microcontrollers include the ATmega88/168/328 family.

RUM currently operates with an Internal RC oscillator set for 8MHz.

B.4.2 Step 2: Define a new PLATFORM for the hardware

A platform describes several aspects of a board:

- Which microcontroller is connected to the radio.
- How the radio pins are connected to the microcontroller.
- Which interrupt vector the radio uses.
- How to enable and disable the radio's interrupt handler.
- Which serial port the board uses for debugging I/O (optional).
- How to enable/disable/read the ADC for sensor data (optional).
- How to read and set buttons and LED's on the board (optional).
- Which band the radio operates in.

Define the new platform in hal_avr.h by adding a new entry to the list of platform types. Then define a block of parameter definitions similar to the existing platform definitions. For example:

(In the list of platform definitions)

```
#define MY_NEW_BOARD 9
```

(further down in file)

```
#elif PLATFORM==MY_NEW_BOARD
```

```
// Set this to the Microcontroller the new design uses
```





```
#ifndef __AVR_ATmega1281__
    #error "Incorrect MCU for Platform! Check Makefile"
#endif

// Set this to the port that the SEL pin is connected to
# define SSPORT      B
// Set this to the pin that the SEL pin is connected to
# define SSPIN       (0x00)
// Set this to the port that the SPI port is on
# define SPIPOT      B
// Set this to the pin that the MOSI signal is on
# define MOSIPIN     (0x02)
// Set this to the pin that the MISO signal is on
# define MISOPIN     (0x03)
// Set this to the pin that the SCLK signal is on
# define SCKPIN      (0x01)
// Set this to the port that the RST pin is connected to
# define RSTPORT     B
// Set this to the pin that the RST pin is connected to
# define RSTPIN      (0x05)
// Set this to the port that the SLP_TP pin is connected to
# define SLPTRPORT   B
// Set this to the pin that the SLP_TP pin is connected to
# define SLPTRPIN    (0x04)
// Set this to the UART number (0, 1, 2, etc.) for the
// serial port being used.
# define USART       1

// Define which port of the AVR hosts the ADC converter.
# define ADPORT      F
// Define which pin of the ADC port is connected
// to an analog input.
# define ADPIN       (0x00)
// Define the DIDR register associated with the ADC pin
// (See AVR datasheet).
# define DIDR        DIDR0
// Define which 16-bit timer is to be used for the
// system timer.
# define TICKTIMER   3
// Define which AVR vector handles the radio interrupt.
# define RADIO_VECT  INT0_vect

// Define Macros to handle setting up interrupts and
// ADC functionality
#define HAL_ENABLE_RADIO_INTERRUPT( ) EICRA |= 3, EIMSK |= 1
#define HAL_DISABLE_RADIO_INTERRUPT( ) EICRA&=~3, EIMSK &= ~1
```



```

#   define HAL_INIT_ADC() DIDR0 |= (1 << ADPIN), \
      ADMUX = 0xC0 | ADPIN, ADCSRA = 0x84
#   define HAL_STOP_ADC() ADCSRA &= ~0x80
#   define HAL_SAMPLE_ADC() ADCSRA |= (1 << ADSC) \
      | (1<< ADIF)
#   define HAL_WAIT_ADC() while (!(ADCSRA | (1<<ADIF))) {}
#   define HAL_READ_ADC() ADC
#   define BAND BAND900      // RF212

// LED Macros
#define LED_INIT() (DDRE |= ((1<<2) | (1<<3) | (1<<4)), \
      PORTE |= ((1<<2) | (1<<3) | (1<<4)))
// LED_ON(led), where led = 1-3
#define LED_ON(led) (PORTE &= ~(1 << (led+1)))
#define LED_OFF(led) (PORTE |= 1 << (led+1))

// Button macros
#define BUTTON_SETUP()      DDRE &= ~(1 << PE5), \
      PORTE |= (1 << PE5)
#define BUTTON_PRESSED() (DDRE &= ~0x20, \
      PORTE |= 0x20, !(PINE & 0x20))

```

Note that some features may not be available on a new platform, like the ADC converter or the LED's and button. To leave a feature out of the platform definition, define it as nothing, so that the compiler will not complain about the missing symbol:

```

#   define HAL_INIT_ADC()
#   define HAL_STOP_ADC()
#   define HAL_SAMPLE_ADC()
#   define HAL_WAIT_ADC()
#   define HAL_READ_ADC() 0
#   define BUTTON_SETUP()
#   define BUTTON_PRESSED() 0
#   define LED_ON()
#   define LED_OFF()

```

After checking these definitions against the schematic, compile the RUM code. Be sure to specify the correct microcontroller definition in the project options, or Makefile on Linux, so that it matches the definition in the platform block as shown above. Fix any compilation errors.

B.4.3 Step 3: Verify that the transceiver is communicating with the microcontroller

To verify that the definitions in `hal_avr.h` or `hal_arm.h` are working, the firmware must be run to see if the microcontroller is able to read and write to the radio via the SPI port. There are two ways to do this. Try one of the following.

1. If a serial port is available on the new platform, compile RUM with the `DEBUG` flag set to one, and connect a serial port to the target. Using a terminal program, open the target's serial port (38.4Kbps, n, 8, 1, no flow





control) and press the enter key. A simple terminal menu should be printed, and the ASCII 'd' character should cause a dump of the radio's register set. If these values look reasonable (not all zero's or 0xff's), then the radio is connected properly. If terminal display does not print, then the radio code is probably stuck, waiting for the transceiver to initialize, which will never happen if the radio isn't able to communicate over the SPI port.

2. Using the AVR debugger, set a breakpoint on the call to `appTask()`. If the firmware is able to execute to this point, then it can be assumed that the radio has initialized properly, and therefore the radio can communicate.

If communication cannot be verified, then there is a problem with the interconnects between the radio and the microcontroller. Try the following:

- Double-check the interconnect definitions that were added into `hal_avr.h` or `hal_arm.h`.
- Inspect the target board for solder bridges, bad solder joints, and other problems.
- Verify the board's power supply voltage is correct.
- Use an oscilloscope to watch each radio signal while stepping through the code. Does each pin move up and down as directed by code?

After basic SPI communication has been established, it is necessary to verify that the radio interrupt mechanism is working. To do this, simply start debugging the target, place a breakpoint on the radio ISR function (`RADIO_VECT`) in `hal_avr.h` or `hal_arm.h`, and then run the program. There should be at least one interrupt on startup (`TRX_END`) if everything is working right. There should also be an interrupt when the radio receives any 802.15.4 packet.

B.4.4 Step 4: Verify that the RUM network is working on the hardware

At this point, it is important to verify that the RUM network is completely functional on the new board. To do this, a second node will be needed to talk to the first target board. This other node must be a coordinator if the new node is configured as a router or end node, or vice versa. If there is a telnet or serial debug interface available and it has been enabled by setting the `DEBUG` flag to one, the `DEBUG` interface will be able to show when the nodes connect as soon as both nodes are powered on (and running firmware) at the same time.

If there is no network connection between the two nodes, check the following:

1. Are both nodes working in the same band?
2. If the band is 900MHz, are both radios using the same modulation scheme?
3. Is the coordinator set to a single fixed channel? See the `PAN_CHANNEL` keyword.

Appendix C - IPv6 / 6LoWPAN Background

Using IPv6 and 6LoWPAN will be easier if an understanding of the underlying technologies is in place. This section assumes familiarity with the RUM network outlined in Appendix A.

C.1 The problem with RF-Only Networks

Atmel® provides the RUM network layer as a very easy method of passing messages around the wireless network. Problems occur when messages need to be passed outside the wireless network. Any wireless protocol designed specifically for the 802.15.4 radios (RUM included) will have poor support outside the physical wireless network. This means passing messages outside the physical radio network requires either specialized software on connected computers, or translating the RF protocol to some well-known network protocol.

C.2 Why IP?

IP is used in the biggest computer networks in existence, proving its ability to scale across global networks. IP is already supported by almost every desktop computer, meaning that accessing a sensor network using IP would require no specialized tools. Setting up a wireless sensor network could be managed by the IT department of a company where no special knowledge outside of normal network setup is needed.

Since IP is such a general-purpose protocol, it is not optimized for low-cost, low-power nodes. At first glance it would seem crazy to attempt to use such a versatile high-power protocol for tiny sensor nodes. However IP is very flexible, and many of the benefits of IP can be obtained with a minimum of resources required.

C.3 6LoWPAN to the Rescue

6LoWPAN is a working group at the Internet Engineering Task Force (IETF), which has a number of RFC's documenting a method of transmitting IPv6 across Low power Wireless Personal Area Networks.

6LoWPAN specifies how the IP packets can be passed across the 802.15.4 links. This includes how to compress IP headers to eliminate redundant information, fragmentation to pass messages larger than a single 802.15.4 frame, and how to guarantee interoperability between this low-power IPv6 network and the greater internet.

A huge advantage of 6LoWPAN is that nodes from different vendors, running at different radio frequencies or on different channels, can all be interconnected through an IPv6 link.

C.4 A Crash Course in IPv6

An understanding of IPv6, and how it differs from IPv4 is needed to run this demo. A quick overview is given here in order to educate a user with this new version of the Internet Protocol.

C.4.1 IPv6 Addressing

IPv6 addresses are 128-bits long, and are written in hexadecimal notation. A typical IPv6 address written out might look like:

2001:0DB8:0000:0000:0008:0800:200C:417A





Any leading zeros can be dropped, writing addresses like:

2001:DB8:0:0:8:800:200C:417A

Finally a number of zeros in the middle of the address can be replaced with '::', as such:

2001:DB8::8:800:200C:417A

All IPv6 networks have a “prefix” associated with them. Everything on the same network has the same prefix, so for example the network might have the prefix 2001:0DB8:0000:0000::/64. The '/64' means the prefix is 64-bits long.

Here are a few important IPv6 prefixes that have been globally allocated:

::1/128	loopback address (note 128-bit prefix)
FF00::/8	multicast
FE80::/10	link-local unicast

Every interface always has a link-local address associated with it. The link-local address is only valid on the network the device is on, it cannot be routed across networks. This is important as the link-local address cannot be pinged across the internet for example. The device needs to have a global address assigned to the interface.

C.4.2 IPv6 Neighbor Discovery

IPv6 integrates into the core protocol how nodes find each other, their router, and information about what network they are on. In IPv4 this was done with Address Resolution Protocol (ARP) over Ethernet for example. This is required to find out the mapping between a physical address and an IP address.

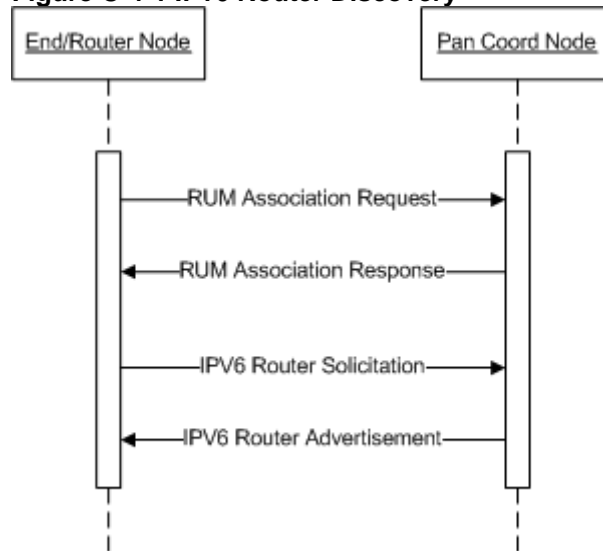
Neighbor discovery consists of four main types of packets. The first is **neighbor solicitation** packets. These are sent to discover if a certain IP address is on the same network, and if so what the physical address of it is.

A neighbor solicitation packet will be answered with a **neighbor advertisement** packet. This advertises that a certain physical address is associated with an IP address. Note the “physical address” will be referred to as the MAC, link-layer, Layer 2, or L2 address. All these terms are synonymous.

A node can send a **router solicitation** packet to inquire about routers that are on the network like shown in Figure C-4-1.

A router solicitation is answered with a **router advertisement** packet. This informs the nodes about the router information including: the physical address, router lifetime, network prefix, and if the router should be used as a default router. This router solicitation will also be periodically sent by the router to inform nodes of any changes in network information.

Figure C-4-1 IPv6 Router Discovery



C.4.3 Node Auto-configuration

On power-up a node uses these packets to acquire an address using stateless auto-configuration. It first auto-configures a link-local address by using the fe80:: prefix followed by an **interface identifier description** (IID) based on its physical address. It then sends a neighbor solicitation packet looking for someone else with this same address – this is the **duplicate address detection** (DAD) phase. If no response is heard to the neighbor solicitation, it assumes it has a valid unique address. A router solicitation is then sent out to learn about any on-link routers. If the routers have prefix information, it can then combine the network prefix with the IID to form a globally accessible address.

As an example, consider how an Ethernet interface with a physical address of 00:1C:23:2B:BD:6C gets a fully operational address:

1. Node comes to life, calculates an IID of 021c:23ff:fe2b:bd6c/64 from its physical address.
2. Node sends a neighbor solicitation to fe80::21c:23ff:fe2b:bd6c.
3. Node waits for response, resending neighbor solicitation a certain number of times.
4. Node fails to hear a response, so auto-configures itself to have the address fe80::21c:23ff:fe2b:bd6c.
5. Node sends a neighbor advertisement, advertising it has address fe80::21c:23ff:fe2b:bd6c.
6. Node sends a router solicitation.
7. Router sends a router advertisement, out of which node finds the network prefix is 2001:db8:1e1::/64.
8. Node sends neighbor solicitation to 2001:db8:1e1:0:21c:23ff:fe2b:bd6c, again listening for a response.
9. No response heard, node advertises itself as owning address 2001:db8:1e1:0:21c:23ff:fe2b:bd6c.





10. Node is now on the network.

It can be seen how IPv6 simplifies auto-configuration of network addresses. Nodes no longer require DHCP to acquire an address. IPv6 does support DHCPv6 (called stateful auto-configuration) should the extra features be required.

C.5 6LoWPAN Basics

Consider that the IPv6 header alone is 40 bytes long, and IPv6 specifies that a packet may be at least 1280 bytes. At first glance it would seem crazy to attempt to combine this with 802.15.4, who's maximum packet size is 127 bytes. The header alone would take 31% of the entire packet, not even including the 802.15.4 header. However 6LoWPAN bridges these two technologies seamlessly, taking advantage of a number of features of IPv6 to transmit the packets without substantial overhead.

Many of the fields in the IPv6 header are often certain values, and do not require the range of data which is given to them. For instance the 'flow label' is 20 bits, but is often zero. Hence a single bit can be used to indicate if the 'flow label' is zero, and if it is zero it is not transmitted.

The previously mentioned way in which IPv6 can auto-configure addresses based on the physical address is also used. The 802.15.4 header already has the destination and source address of a packet, but this is the physical address. Since the IPv6 addresses are often based on these physical addresses, there may be no need to transmit the IPv6 addresses. In the best case a 40-byte IPv6 header can be compressed to two bytes.

To do this address compression, 6LoWPAN relies on the notion of "context". Here "context" means the node knows what address or prefix to use based on the context of the conversation. For example one of the context's the node knows is the prefix of the local network. There would never be a need to transmit this, since all nodes on the network already know this prefix.

As an example, consider if a node has an IP address of:

2001:db8:1e1:1:baad:ff:fe00:1

The address can be split as follows:

2001:db8:1e1:	This is the IPv6 prefix for the network (64 bits)
baad	This is the 802.15.4 PANID (16 bits)
ff:fe00	This is a fixed bit-sequence (32 bits)
1	This is the 802.15.4 short address for the node (16-bit)

From this it can be seen how the IPv6 address can be directly written from the 802.15.4 short address of the node. To send to the node with an IPv6 address of 2001:db8:1e1:1:baad:ff:fe00:5, it means the node with the short address of 5 is the destination node.

C.5.1 Draft-ietf-6lowpan-hc01

The exact version of the "header compression" used in this project is HC01, available at <http://tools.ietf.org/html/draft-hui-6lowpan-hc-01>. Since the standard is evolving, this is not the most recent version of the header-compression standard. The most recent version will be available at <http://tools.ietf.org/wg/6lowpan>. The following quickly describes what features are present in HC01, and supported by this code:

Traffic Class and Flow Label encoding

A message will be properly parsed by end-nodes regardless if traffic class and flow label is compressed or uncompressed. However the value itself is not read, hence to avoid wasting space all messages should have the traffic class and flow label set to zero.

Address Compression

The code supports carrying all 128 bytes; or compressing an address down to 64, 16, or 0 bytes of extra payload.

Next Header Compression

Only a UDP packet will have the next header field compressed, any other type will have the next header field carried in full.

Hop Limit Compression

A hop limit of 255, 64, or 1 will result in the hop limit being compressed. Any other value will result in the hop limit field being carried in full.

UDP Header Compression

UDP Header compression is supported by this implementation.

C.6 6LoWPAN Compressed Header

If sniffing a 6LoWPAN network, it can be useful to understand the header. Note that the 802.15.4 payload will be the RUM frame, which includes some additional fields. The 6LoWPAN header described here is actually the RUM payload. Table C-6-1 illustrates this relationship.

Table C-6-1 Understanding the relationship between 6LoWPAN, RUM, and 802.15.4 Frames.

802.15.4 Frame								
802.15.4 Header					802.15.4 Payload			
RUM Data Header							RUM Data Payload	
FCF	Seq	PID	Dest	Src	Final Dest	Origin	Type	6LoWPAN Frame
0x8821	0x12	0x1234	0x0006	0x0007	0x0000	0x0007	0x05

The 6LoWPAN Frame contains three bytes of interest at the beginning. The first is the 'dispatch' which is always set to 0x03, which corresponds to the header compression used. The HC01 Encoding is specified in two bytes, and a detailed description of this field is given at <http://tools.ietf.org/html/draft-ietf-6lowpan-hc-01> in section C.5.1. Additionally the source code for the avr_sixlowpan.c file in the sixlowpan_hc01_process() function provides a reference for decoding the compressed 6LoWPAN header.

Table C-6-2 6LoWPAN Frame

6LoWPAN Dispatch	HC01 Encoding	Compressed IPv6 Header / IPv6 Payload
1 byte	2 bytes	Variable





Compared to normal IPv6 networks, there are some differences to how a node acquires its IPv6 address. A typical startup sequence on this Atmel 6LoWPAN network is (shown in Figure C-4-1):

1. Node associates to coordinator using RUM protocol, and is assigned an 802.15.4 short address
2. Node sends IPv6 router solicitation to edge router (coordinator)
3. Edge router sends router advertisement back, including IPv6 prefix
4. Node stores this prefix as the default context it uses in all communication
5. Node now has an IPv6 address, since it has context and a short address

There are several differences from the normal IPv6 auto-configuration. Sending physically multicast / broadcast messages is eliminated, as it is not necessary since the edge router address is already known from RUM association. End nodes do not perform duplicate address detection, as each node is guaranteed to have a unique address on the 6LoWPAN network.

The current IPv6 stack on the end devices (AVR) has some limitations. The most important ones are:

- Incoming IPv6 checksums are not checked, however outgoing packets have valid checksums in them.
- The IPv6 edge router and PAN coordinator must be the same device.
- Fragmentation is not provided at the 6LoWPAN layer, meaning packets must fit within a single 802.15.4 frame.
- All IPv6 addresses of nodes on the network must be based on short addresses.

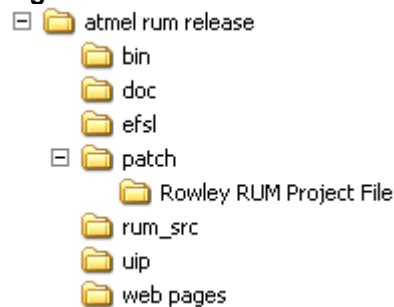
Appendix D - AT91SAM7X-EK Development Tools

uTasker can be compiled in a number of different environments: IAR™, Rowley Crossworks and Eclipse™ (with gcc). The discussion that follows here is based on the Rowley Crossworks tool chain and the Eclipse tool chain.

D.1 Folder Structure

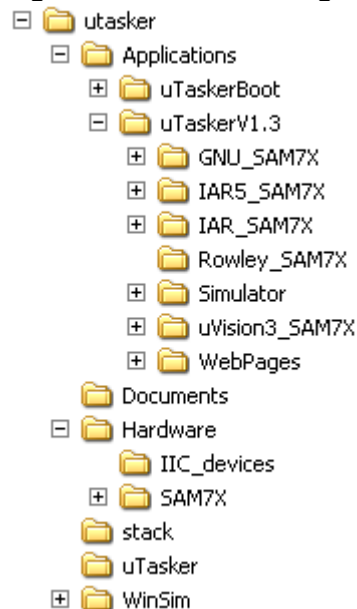
The complete source code for the ARM and AVR based platforms are contained in the folder structure shown in figure D-1-1. This is the folder structure as downloaded from www.atmel.com. The RUM specific source is located in the *rum_src* folder. The *patch* folder contains the modified uTasker files to support RUM. Follow the uTasker patch procedure described in section 4.1.1 to create the new folder structure shown in figure D-1-3.

Figure D-1-1 RUM Source and uTasker Support Download



The original uTasker source package should have the SP4 already integrated before applying the RUM patches. Figure D-1-2 shows the uTasker source package before the RUM patches (a uTasker license is required for source code access from www.utasker.com).

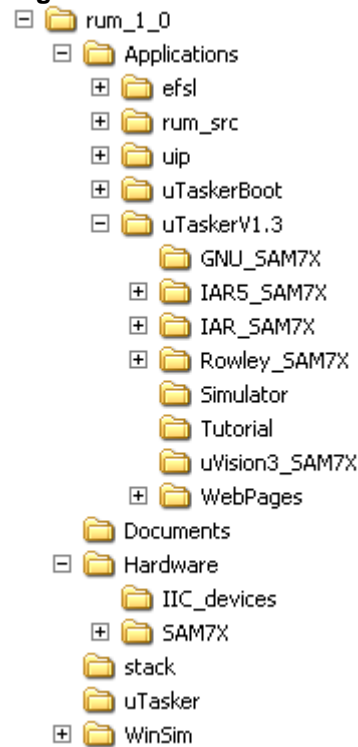
Figure D-1-2 uTasker Original Source w/ SP4 Package



After following the uTasker RUM patch procedure, the following folder structure shows the integrated uTasker and RUM project for application development.



Figure D-1-3 uTasker and RUM Integrated Folder Structure



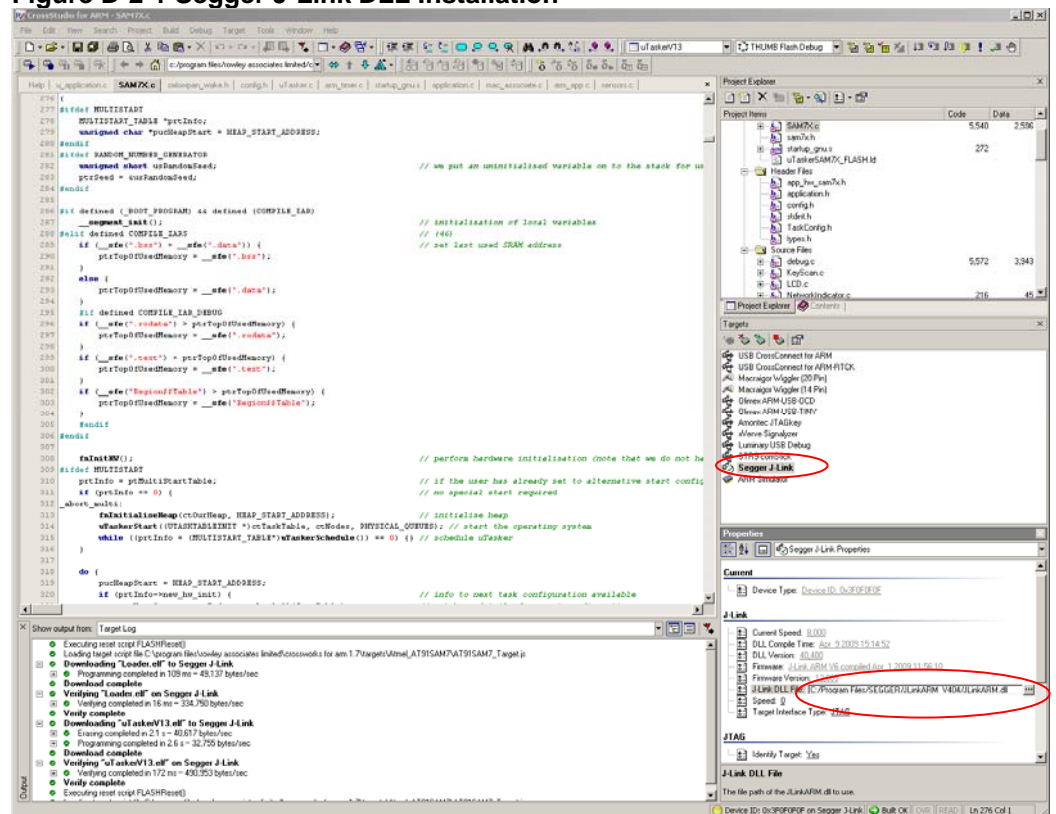
D.2 Rowley Crossworks IDE

Rowley Crossworks is a cross platform IDE that is lower cost alternative to other ARM development IDE's on the market. There are many license models available. Rowley Crossworks and detailed documentation can be downloaded for the ARM from www.rowley.co.uk/arm/index.htm. Following are the steps necessary to setup Crossworks for the first time and subsequent debug sessions.

1. A 30-day Evaluation License may be requested before purchasing.
 - a. Open Tools -> License Manager
 - b. Request Eval license by email (one day processing).
2. Download Support Packages
 - a. Open Tools -> Download Packages From WEB
 - b. Download Board Support: Atmel - AT91SAM7X-EK.hzq
 - c. Download CPU Support: Atmel - AT91SAM7.hzq
 - d. Complete installation procedures for both packages.
3. Open an existing project
 - a. File -> Open
 - b. Locate the Rowley project file for the uTasker RUM demo (ie...\utasker\Applications\utaskerV1.3\Rowley_SAM7X\utaskerV13.hzp). Need to have uTasker license to obtain source level access.
4. Install Segger J-Link software package for the AT91SAM-ICE JTAG programmer from www.segger.com/download_jlink.html.

5. Load J-Link .dll for debugging
 - a. Target -> Connect Segger J-Link
 - b. Should see “DLL WARNING”
 - c. Select Tools -> Targets
 - d. Highlight “Segger J-Link”, right-click and select “Properties” as shown in figure D-3-1.
 - e. Find Properties window in lower right corner, make sure properties of “Segger J-Link” is selected.
 - f. Highlight “J-Link DLL File”
 - g. Locate .dll file from Segger folder (ie. C:/Program Files/SEGGER/JLinkARM_V392/JLinkARM.dll)
 - h. Re-do Step A.
 - i. Verify Device Type Connects to J-Link

Figure D-2-1 Segger J-Link DLL Installation



6. To Start debugging
 - a. Debug -> Start Debugging

D.2.1 Rowley RUM Project

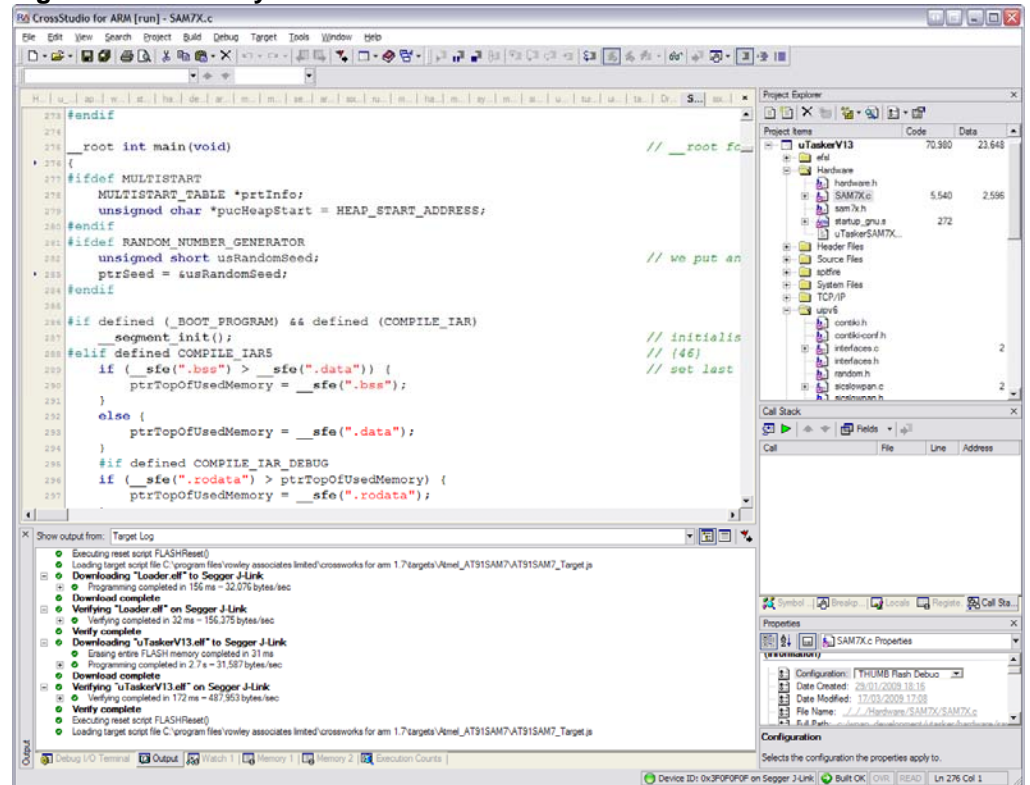
The Rowley project file can be launched by opening up the `\patch` folder and navigating to the `\Rowley RUM Project File` folder containing the `.hxp` project file. This file needs to be copied over the original Rowley project file located in the `\luTaskerV1.3\Rowley_SAM7X1` folder. Assuming all the project patch procedures and





folder structuring has been properly followed; the Rowley project file should build as expected.

Figure D-2-2 Rowley IDE



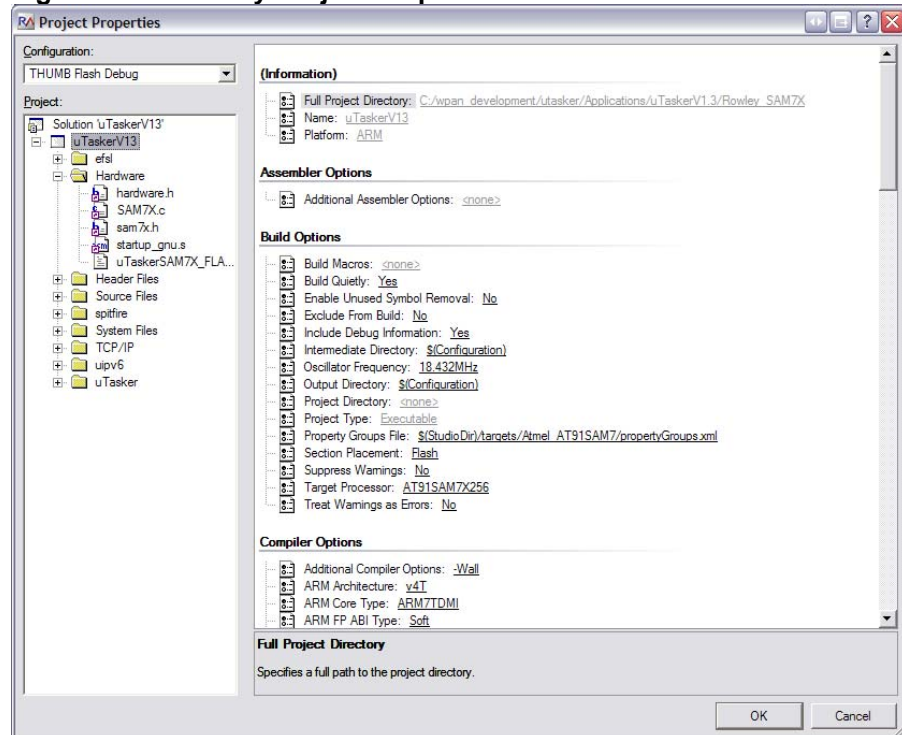
The Rowley Crossworks interface looks like the image shown in figure D-2-2.

The Rowley compile option flags can be set via the IDE. Click on Project -> Properties to locate the Preprocessor Options. Figure D-2-3 shows what the configuration screen looks like.

Complete descriptions of compile time options are found in section 3.2.1:

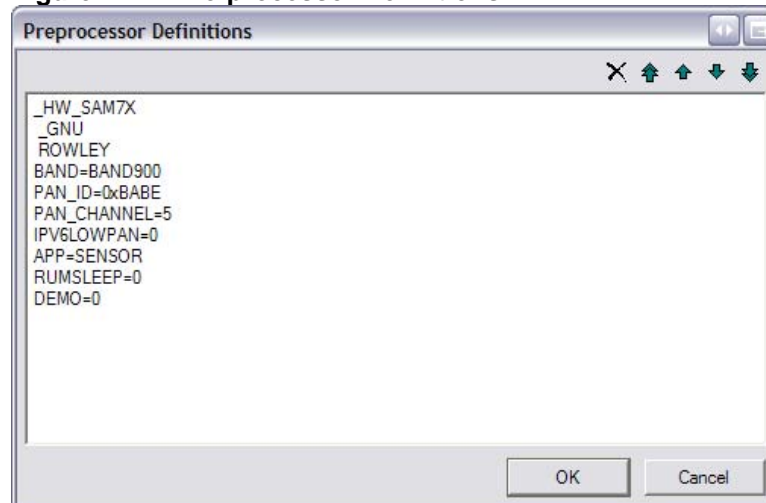
- APP=0,1
- CHINA=0,1
- DEBUG=0,1
- DEMO=0,1
- IPV6LOWPAN=0,1
- PAN_CHANNEL=0 or integer 0 – 26
- PAN_ID=0 or 2 byte user defined
- PLATFORM=0 **Note:** Not needed for SAM7X
- BAND=BAND2400, BAND900
- CHINA_MODE=0, 1
- RUMSLEEP=0,1
- SENSOR_TYPE=0

Figure D-2-3 Rowley Project Properties



Then click on the ellipsis button to bring up the Preprocessor Definitions window.

Figure D-2-4 Pre-processor Definitions



The code can be built by either pressing the F7 key or by clicking on the Build the menu item and then clicking on Build -> uTaskerV13. After successfully compiling the code it can be downloaded to the target using the SAM-ICE (or CrossConnect) JTAG adapter. To start the download press the F5 key or click Build -> Build and Debug to debug or Build -> Build and Run to just run the code.



Note:

Sometimes the SAM7X will retain old FLASH values such as IP addresses. This can be a valuable feature during code reloads to keep static variables. To ensure that the memory is purged, the *Erase* jumper on the SAM7X board can be connected to ground. Doing so will completely erase the memory and will ensure that reloaded code will implement new values.

D.3 Eclipse IDE

D.3.1 Required Tools

Besides the RUM source code, a few external tools are needed. These tools are the compiler and associated toolchain, the graphical interface, the emulator interface, and the FLASH programming tool.

D.3.1.1 YAGARTO

YAGARTO is a GCC compiler distribution. Download the latest version of the "YAGARTO GNU ARM toolchain" from www.yagarto.de. Their website also has links to other documentation on setting up the toolchain.

D.3.1.2 Eclipse

Eclipse is the graphical interface that will be used. Get the C/C++ Edition from www.eclipse.org/downloads/.

D.3.1.3 J-Link Software and Documentation Pack from Segger

This provides the GDB-Server that allows the Atmel SAM-ICE to be used for debugging. Obtain the software pack from Segger at www.segger.com/download_jlink.html.

D.3.1.4 AT91SAM-ICE (SAM-PROG)

The SAM-PROG™ utility allows programming the FLASH memory in the SAM7X device using the Atmel SAM-ICE. Get the latest version of the "AT91-ISP.exe" from www.atmel.com/dyn/products/tools.asp?family_id=605.

D.3.2 Installing

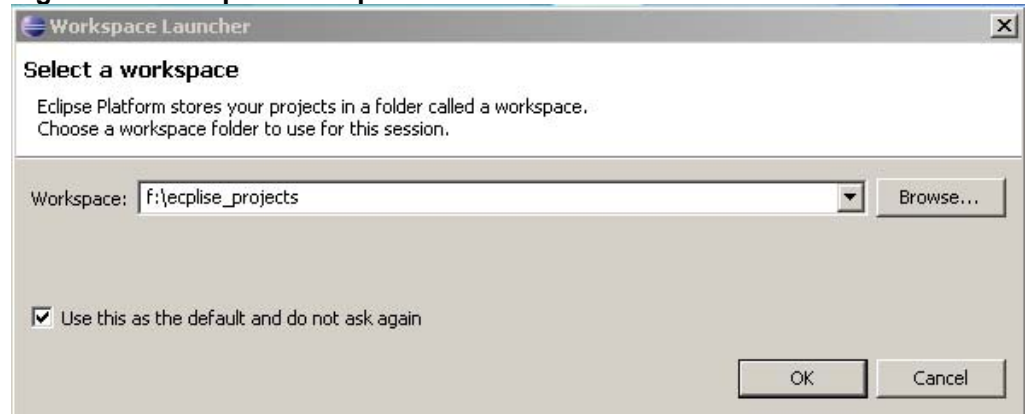
Run the provided installers for each tool. With Eclipse there is no install needed – just extract the folder and create a shortcut to the eclipse.exe program.

D.3.3 Building RUM – Step by Step

Start the Eclipse program; a splash screen should appear.

If no splash screen appears, there may be a problem with the Java® Runtime Environment. Check the Eclipse documentation on eclipse.org for more details. Eclipse will then ask for the "workspace", which is where it stores all its projects.

Figure D-3-1 Eclipse Workspace Selection



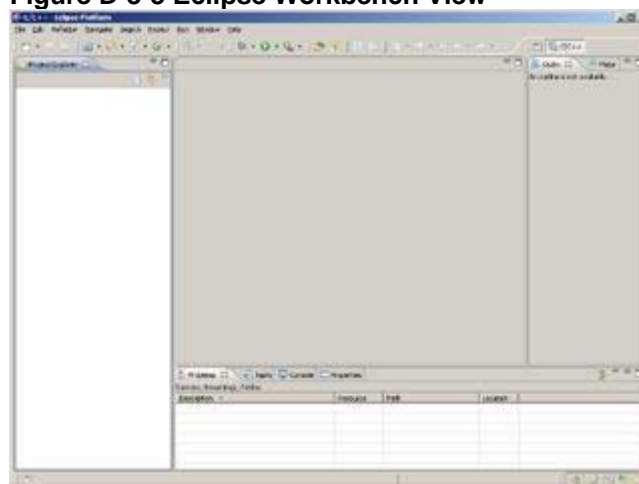
In this example they are stored in the *f:\eclipse_projects* directory. With that, the Welcome screen will appear:

Figure D-3-2 Eclipse Welcome Screen



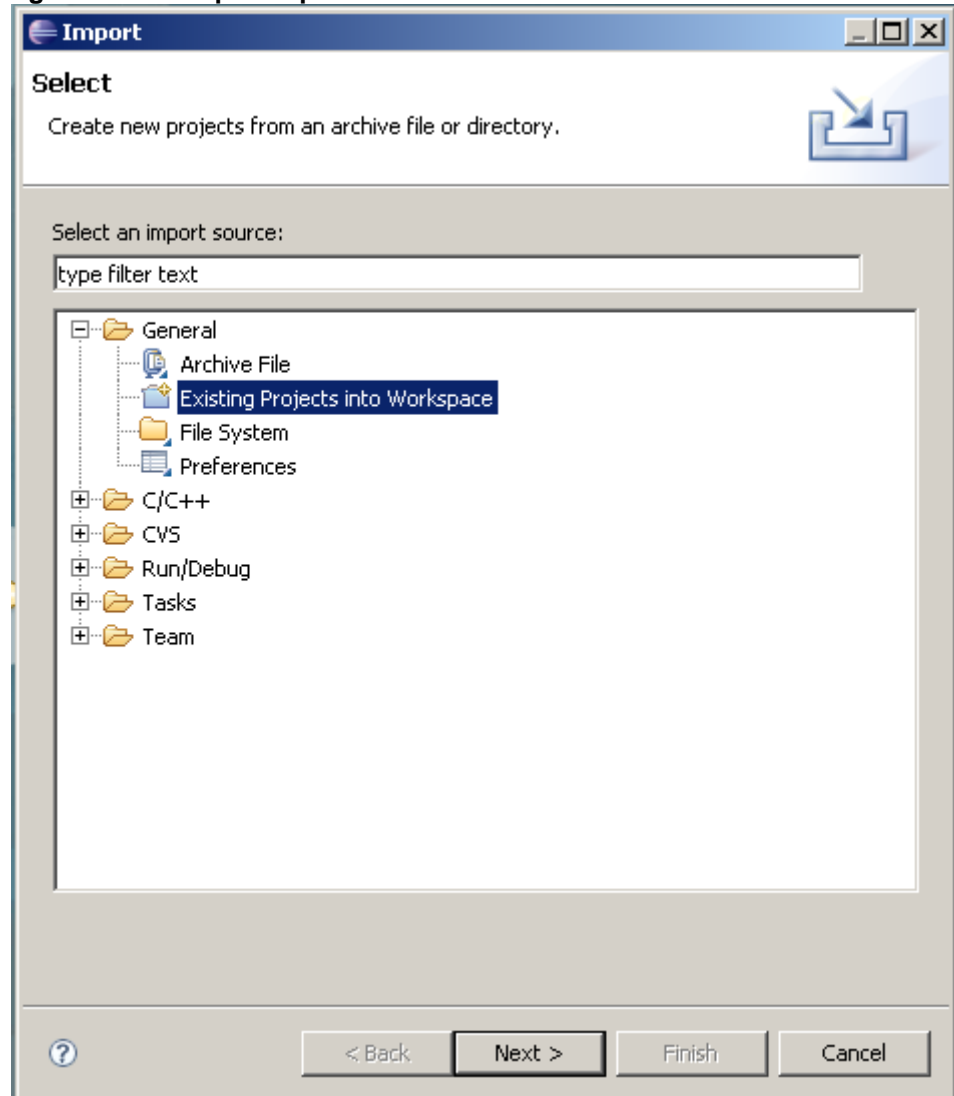
Clicking the “workbench” icon on the far right will then open the workbench view:

Figure D-3-3 Eclipse Workbench View



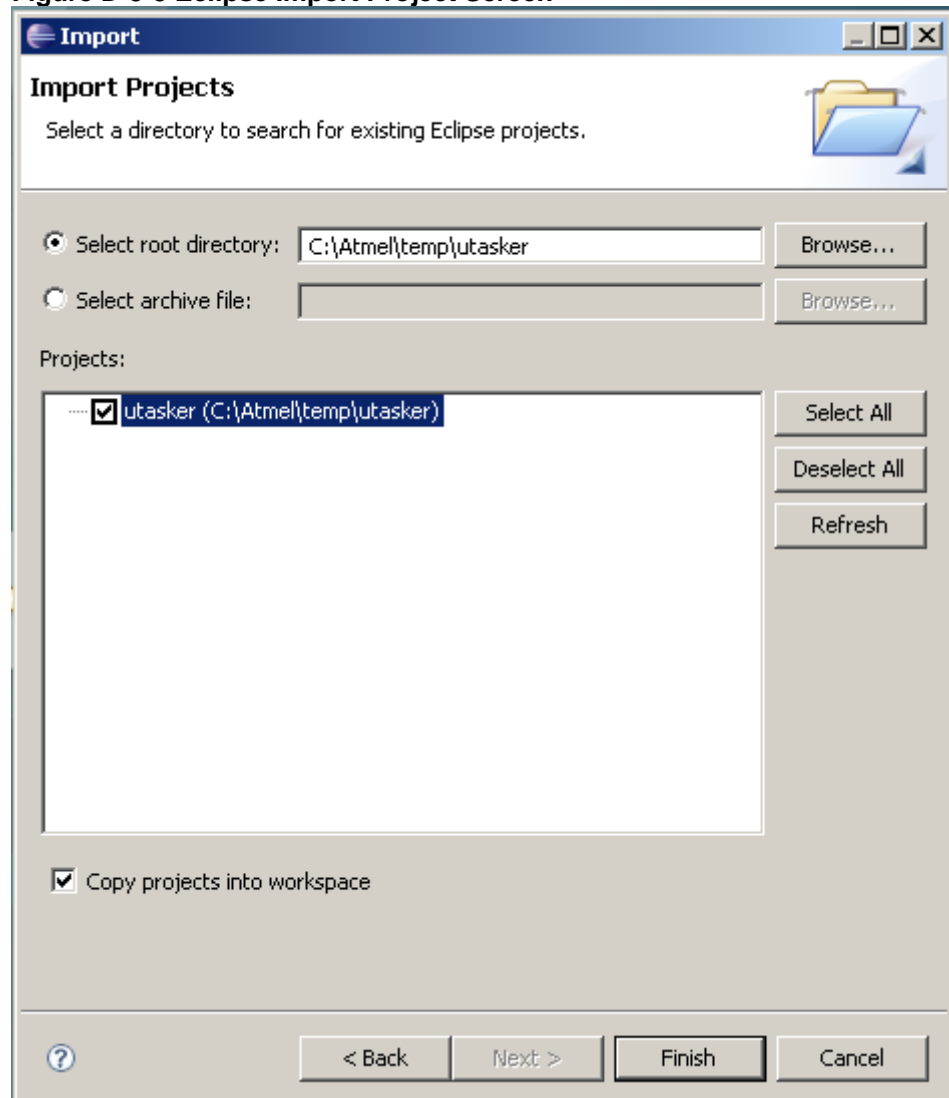
Finally the RUM project can be imported. This is done by going to the “File -> Import” menu. Select the type as “Existing Projects into Workspace”, and click next:

figure D-3-4 Eclipse Import Selection Screen



Point the root directory to the RUM source code. It should automatically find the project, and optionally one can check the “Copy projects into workspace” option to copy the source files to a local Eclipse workspace.

Figure D-3-5 Eclipse Import Project Screen

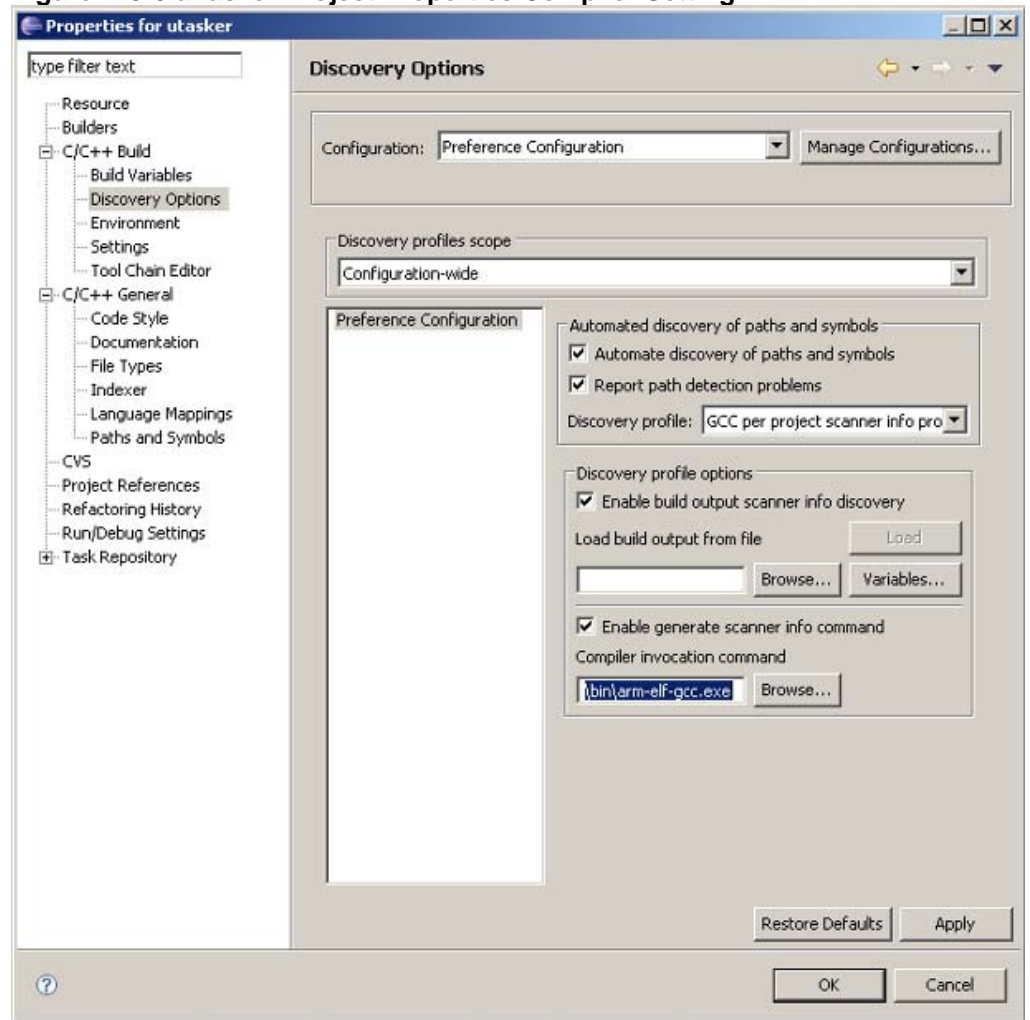


Upon hitting the “Finish” button, Eclipse will import all the files. This will also copy them to the local working directory if that option was selected.

Some paths need to be updated to reflect the local development system. Right-click on the project in the *Project Explorer*, and hit the “Properties” option. Then open “Discovery Options” under “C/C++ Build” in the Properties window.

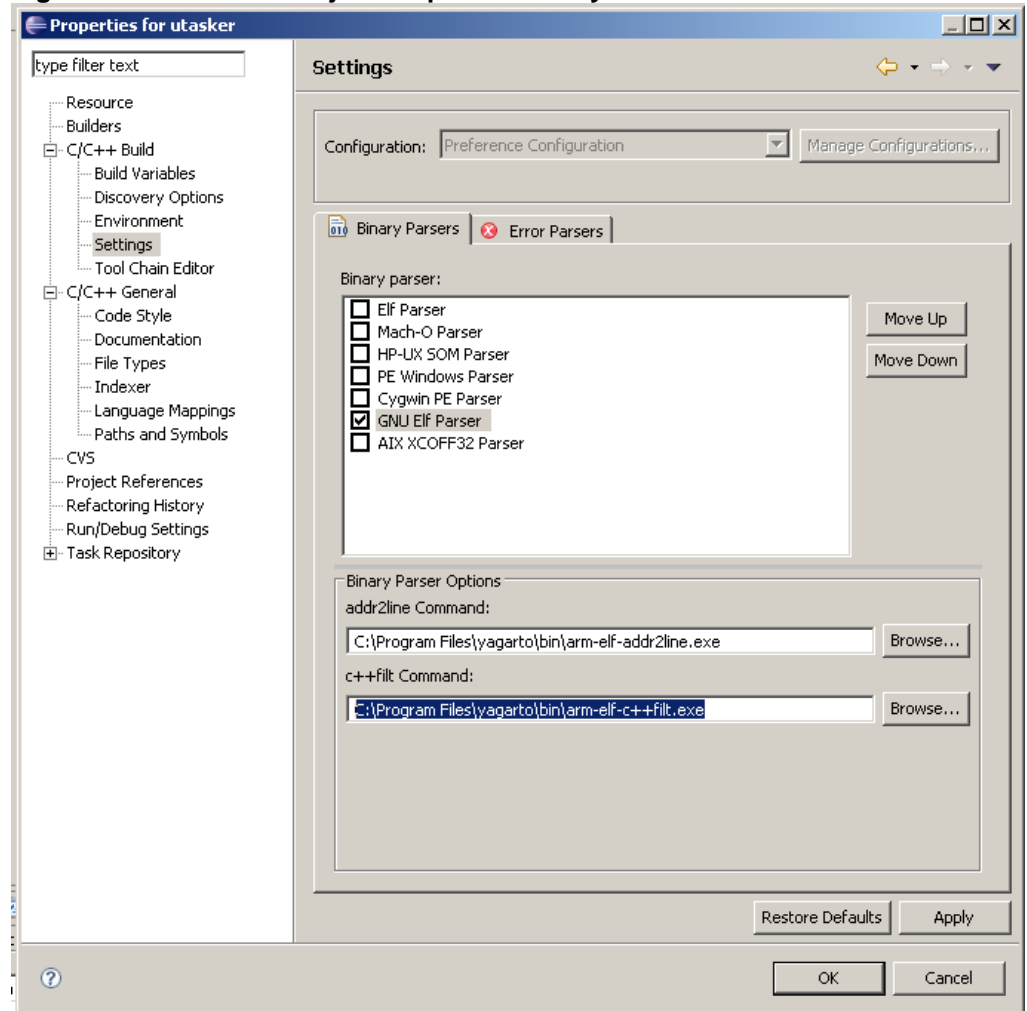
Change the “compiler invocation command” to point to the YAGARTO installation. In this example it is located at *C:\Program Files\yagarto\bin\arm-elf-gcc.exe*:

Figure D-3-6 uTasker Project Properties Compiler Setting



Next open the “Settings” pane under “C/C++ Build”. Select the “GNU Elf Parser” checkbox, then point both the `addr2line` and `c++filt` command to point to the YAGARTO commands. In this case this was `C:\Program Files\yagarto\bin\arm-elf-addr2line.exe` and `C:\Program Files\yagarto\bin\arm-elf-c++filt.exe` respectively.

Figure D-3-7 uTasker Project Properties Binary Parser



Hit OK, and attempt to rebuild the project. Select “Project -> Clean”, and it should clean and then rebuild the project. View output in the “Console” tab at the bottom right of the workspace.

The result should be a message printing the size of the resulting ELF file.

D.3.4 Debugging RUM Step-By-Step

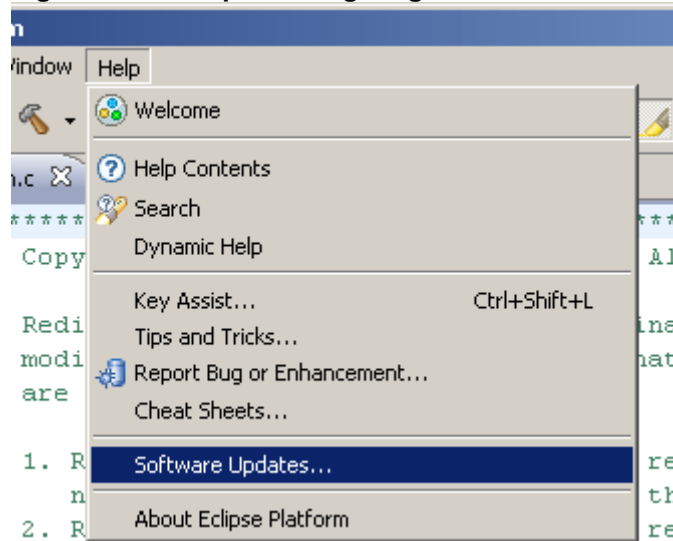
An Atmel SAM-ICE can be used to debug RUM on the SAM7X board. Connect the SAM-ICE to the debug port, and ensure the Segger J-Link tools are installed, along with any needed drivers.

D.3.4.1 Zylind CDT plugin

Before continuing with the debug tutorial, install an extra plugin for Eclipse. This is easily done, by using the “Help -> Software Updates..” menu:

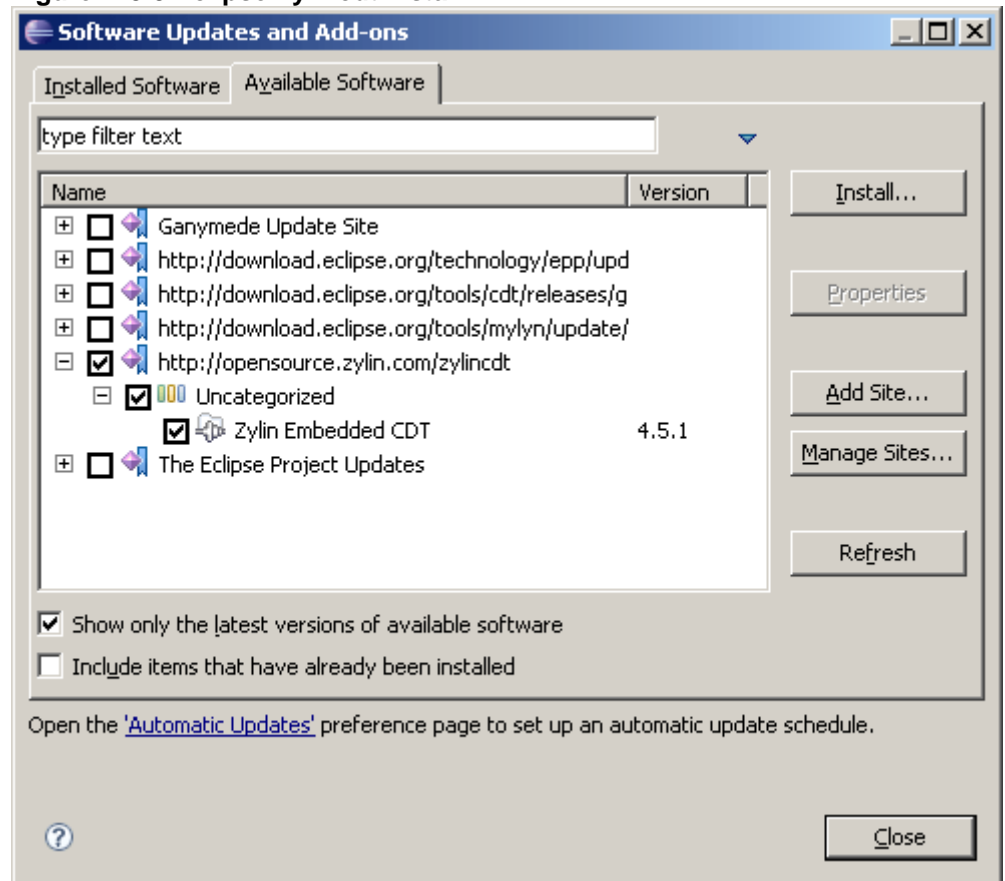


Figure D-3-8 Eclipse Debug Plugin



Press “Add Site” and add the site <http://opensource.zylin.com/zylincdt> and press OK. Now select the “zylincdt” and hit “Install”:

Figure D-3-9 Eclipse Zylincdt Install

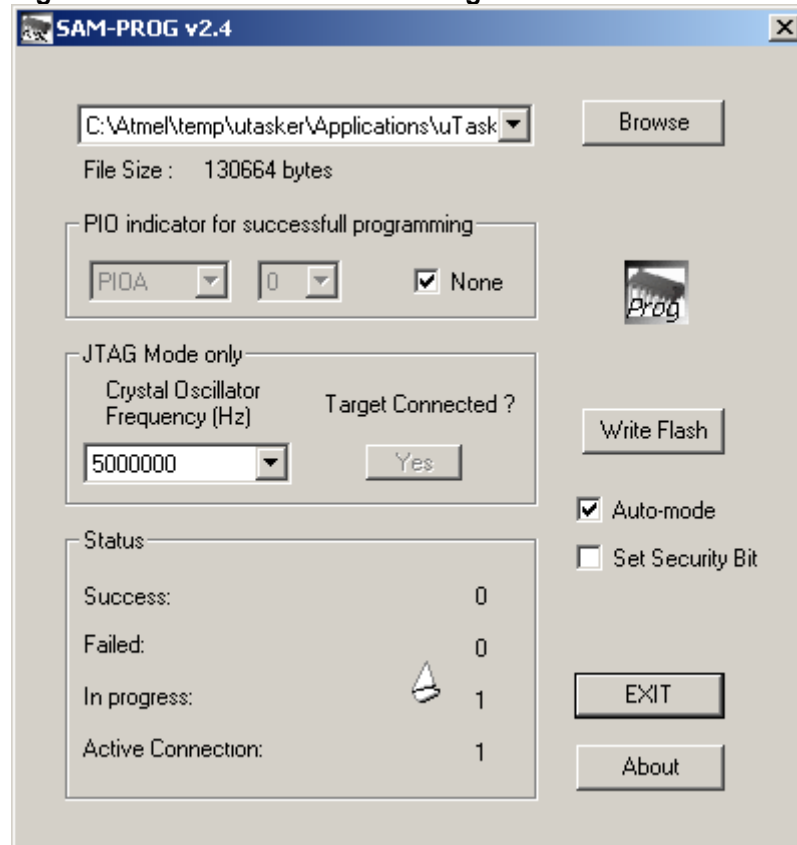


Completing the install will require agreeing to the terms of the license agreement. If asked to restart Eclipse, press “Yes” to do so.

D.3.5 Programming the FLASH

First programming the FLASH memory with SAM-PROG will be covered. With the SAM-ICE connected, open the SAM-PROG program. Point to the file at *Applications\UtaskerV1.3\GNU_SAM7X\UtaskerV1.3.bin*. Ensure the “None” and “Auto-mode” checkbox are checked.

Figure D-3-10 SAM-PROG Flash Programmer

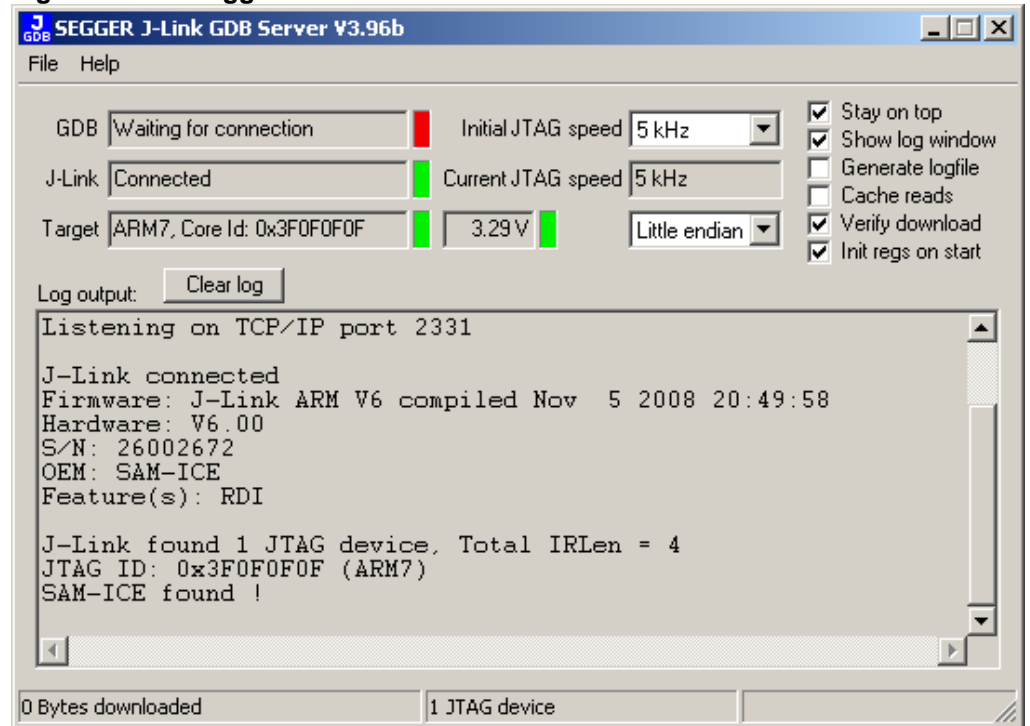


Then hit the “Yes” button under “Target Connected”, and the device should be programmed. With the FLASH programmed, it is now a matter of debugging the program.

Start the GDB server from the Windows Program menu. It can be found under Windows Start -> All Programs -> SEGGER under “J-Link ARM V3.96b / J-Link GDB Server”. Note that both the GDB server and SAM-PROG can be run at the same time, provided both programs do not access the SAM-ICE at the same time. An indication the J-Link is connected should appear:

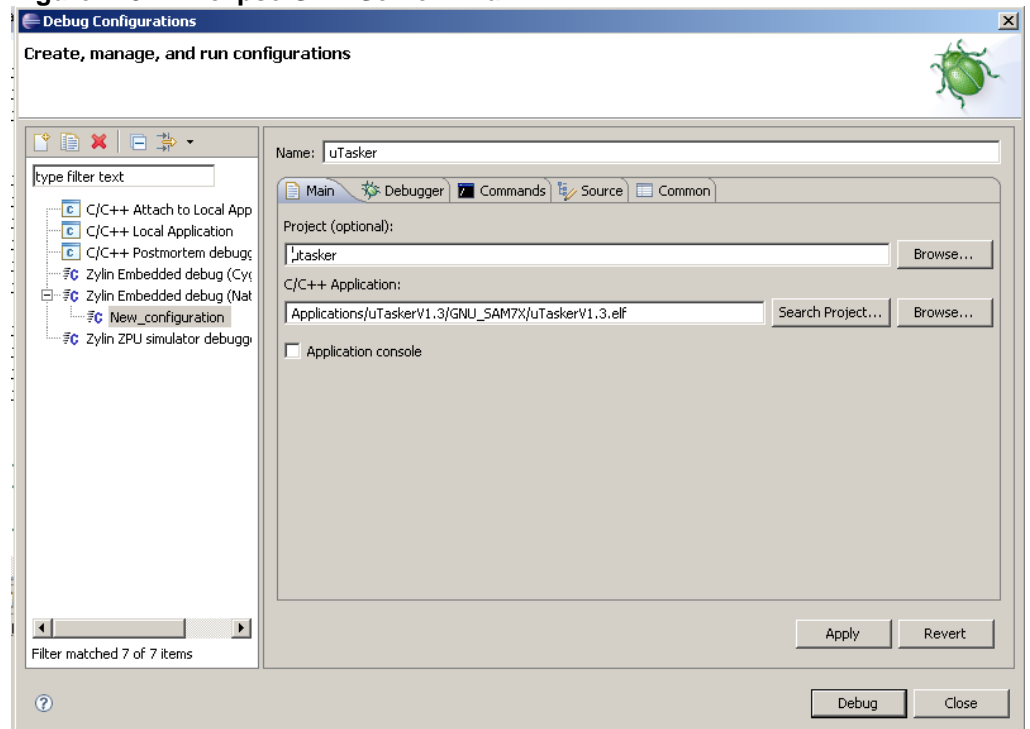


Figure D-3-11 Segger J-Link Connection Screen



Next Eclipse needs to be set up to work with the GDB Server. To do this click the small downward-pointing arrow beside the “Bug” button, and select “Debug Configurations”:

Figure D-3-12 Eclipse GDB Server - Main

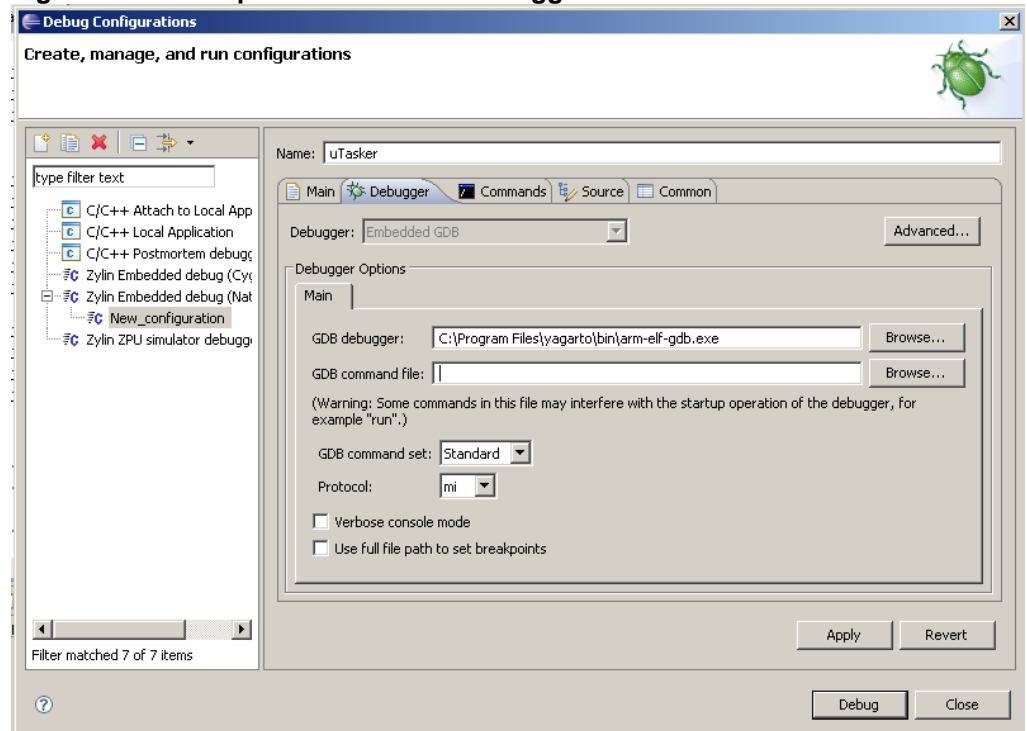


A new window will pop up, and select the “Zylin Embedded debug (Native)” category, and hit the new button. Set the name, and then set the project by hitting the “Browse” button and selecting the project.

Assuming the project has successfully been built, pressing the “Search Project” button beside the “C/C++ Application” line should acquire the ELF file for this project.

Next, select the “Debugger” tab. Set the GDB debugger to the location of the “arm-elf-gdb.exe” binary, in this example it is *C:\Program Files\yagarto\bin\arm-elf-gdb.exe*. Clear the line that says “GDB command file”:

Figure D-3-13 Eclipse GDB Server - Debugger



Next select the “Commands” tab. In the “Initialize commands”, copy the following:

```
# Listening for commands on this PC's tcp port 2331
target remote localhost:2331

# Enable flash download and flash breakpoints.
# Flash download and flash breakpoints are features of
# the J-Link software which require separate licenses
# from SEGGER.

# Select flash device
#monitor flash device = AT91SAM7X256

# Enable FlashDL and FlashBPs
#monitor flash download = 1
#monitor flash breakpoints = 1

# Set gdb server to little endian
```





```
monitor endian little

# Set JTAG speed to 30 kHz
monitor speed 30

# Reset the radio to get to a known state.
monitor reset 8
monitor sleep 10

#

# Disable the watchdog and setup the PLL
#

# WDT_MR, disable watchdog
monitor writeu32 0xFFFFFD44 = 0x00008000

# CKGR_MOR
#monitor writeu32 0xFFFFFC20 = 0x00000601
#monitor sleep 10

# CKGR_PLLR
#monitor writeu32 0xFFFFFC2C = 0x00480a0e
#monitor sleep 10

# PMC_MCKR
#monitor writeu32 0xFFFFFC30 = 0x00000007
#monitor sleep 10

# PMC_IER
#monitor writeu32 0xFFFFF60 = 0x00480100
#monitor sleep 100

# Set JTAG speed in khz
monitor speed 12000

#load
break main
continue
```

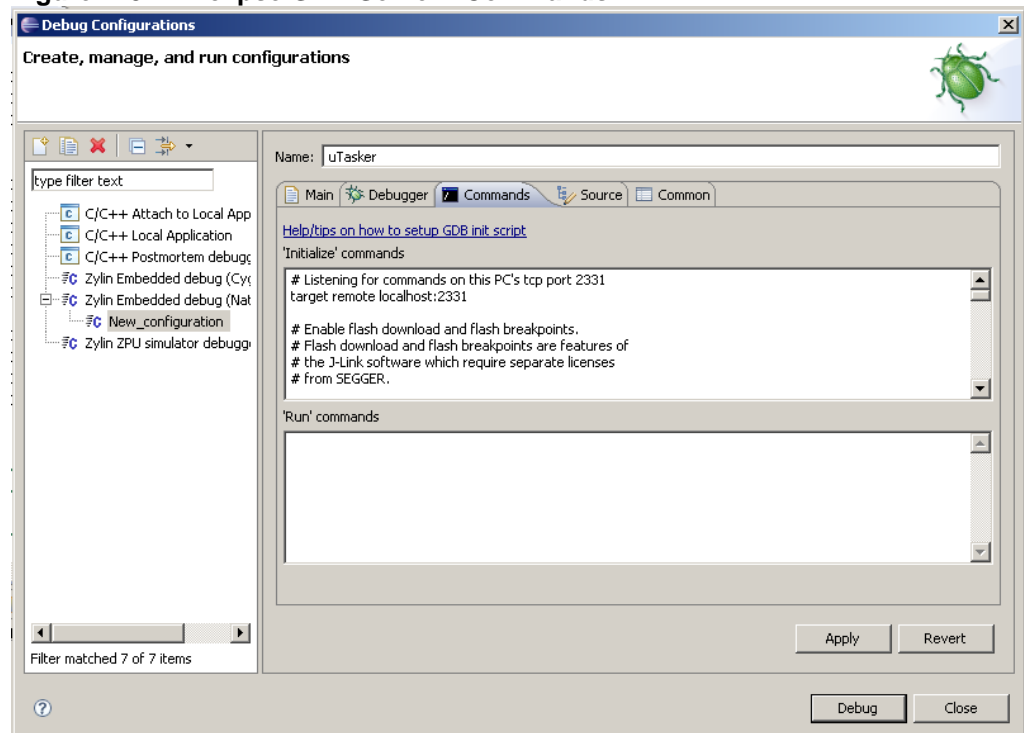
Note the following lines are commented out:

```
#monitor flash download = 1
#monitor flash breakpoints = 1
```

To use these features requires the purchase of an additional license. The flash download feature means that the FLASH can be programmed from within Eclipse. In

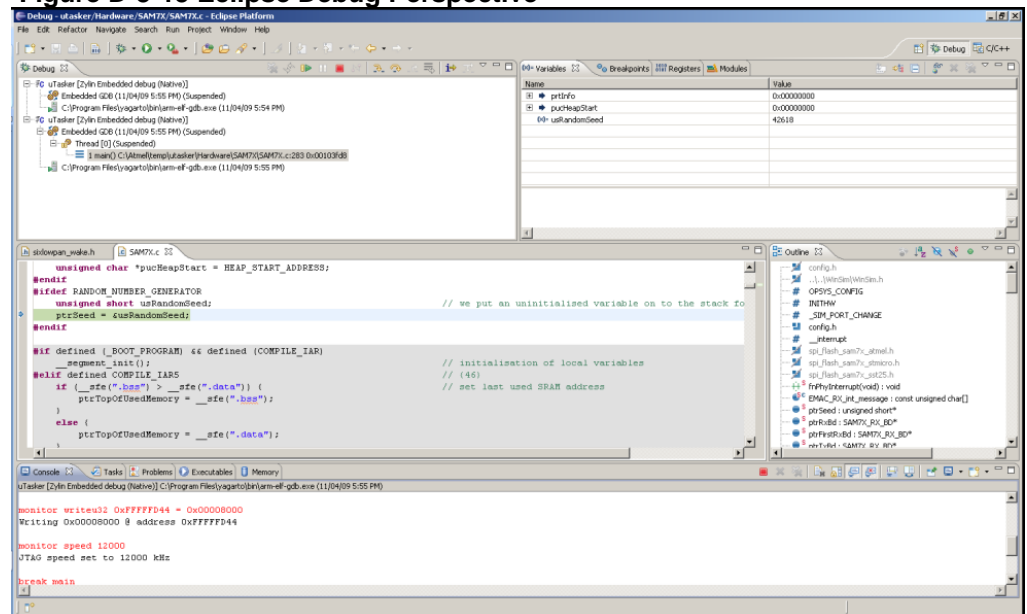
this tutorial the external SAM-PROG tool is used instead. The flash breakpoints feature removes the limit of two hardware breakpoints.

Figure D-3-14 Eclipse GDB Server - Commands



Now hit the “Debug” button, and Eclipse should ask to open the debug perspective. With this open, the screen should appear as:

Figure D-3-15 Eclipse Debug Perspective



The run, pause, stop, step into and step over buttons are across the top:

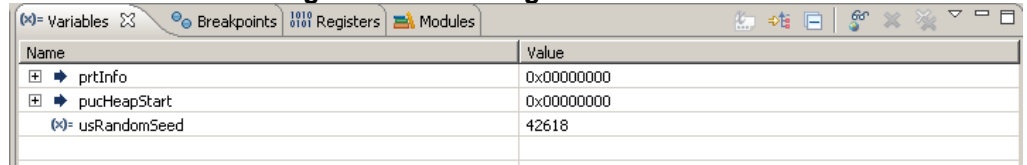


Figure D-3-16 Debugging Tools



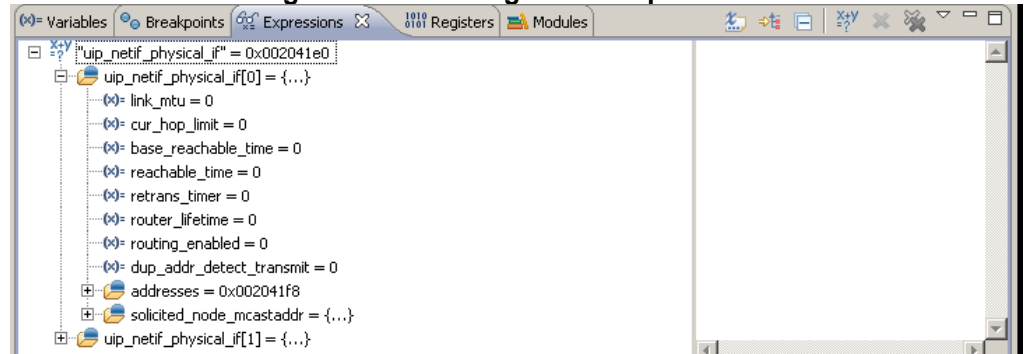
The “Variables” section contains all local variables for the current function. To add a global variable press the “Add Global Variable” button. It has the eyeglasses above a globe:

Figure D-3-17 Debug Watch Variables



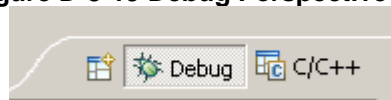
Additionally variables can be added by the “Expressions” tab. To open this Go to the “Window/Show View/Expressions” option. Add a variable by right-clicking and pressing “add watch expression”, then writing in the variable name. This is useful for static variables which do not appear in the global variable list:

Figure D-3-18 Debug Watch Expressions



To switch between the Debug perspective and the C/C++ perspective hit the “Debug” or “C/C++” button in the top-right corner. This does not stop the debug operation, but makes it easier to navigate the project by opening the C/C++ perspective:

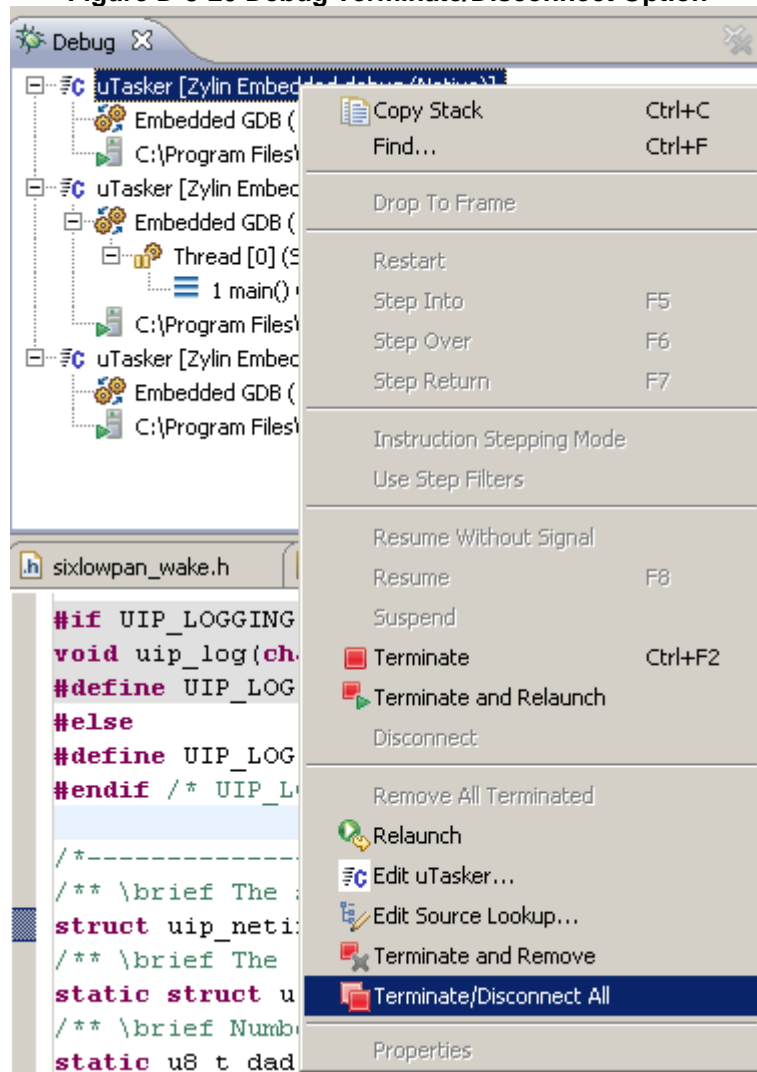
Figure D-3-19 Debug Perspective Tab



It is also important to remember the restriction about two breakpoints. This includes breakpoints used by GDB – for example stepping over a function uses one breakpoint. This leaves only one user-available breakpoint while inside the function. If more breakpoints are set than are available, an error will be thrown when a RUN command is attempted. To correct this remove or disable any breakpoints that are not immediately needed.

When debugging is finished, be sure to hit the “STOP” button to disconnect the debugger. If an attempt is made to start a new debugging session while an old debugging session is connected, it will result in a number of errors. To correct this switch to the debug perspective, then right click on a debugging session and choose the “terminate all” option. Then re-launch the debugger:

Figure D-3-20 Debug Terminate/Disconnect Option



Once debugging is finished, the process can begin again. After re-compiling, it is imperative to ensure the flash is reloaded with the SAM-PROG program. Simply starting a debug process again does NOT download new code, unless the extra flash programming module is purchased. The code must be reloaded with SAM-PROG.





Appendix E - Third-Party Reference Designs / Platforms

This section describes various reference designs that can be purchased from distributors like Dresden Elektronik (www.dresden-elektronik.de) and TRT Technology (www.trttech.com). These platforms are supported within the RUM source code for alternate evaluation and development options.

E.1 REB and REX_ARM Adaptor

The REB (Radio Extender Board) is designed to support evaluation of the standalone transceiver and this board can be connected to an STK500/600 or the AT91SAM7X-EK kit. Using the generic connection guide in section 4.2 will provide a method for connecting the board to any evaluation kit of choice. The REB can also be connected to the AT91SAM7X-EK board with a *REX_ARM* adaptor board.

The Atmel IEEE 802.15.4 radios can be controlled via SPI and a few discreet IO signal lines. Please refer to the respective datasheets for detailed information on the radio – microcontroller physical connections. To separate the radio from the external memories present or possible on the SAM7X board SPI-1 is used. The SAM7X is connected to the AT86RF2xx family based on the following table. This table also includes the REX_ARM adaptor board connections between the AT91SAM7X-EK and the REB.

Table E-1 Signal Connections

	ARM Adapter Board		AT91SAM7X-EK Board		
	REB Pin	SAM7X-EK Header Pin	SAM7X MCU Pin	Port	Port Function
MISO	27	A25	56	PA24	SPI1_MISO
MOSI	28	A24	55	PA23	SPI1_MOSI
SCK	29	A23	50	PA22	SPI1_SPCK
SEL	30	A22	49	PA21	SPI1_NPCS0
IRQ	38	C24	80	PA30	IRQ0
CLK1	17	C22	70	PB24	TIOB0
SLEEP_TR	26	A9	13	PA8	PA8
RST	25	A10	14	PA9	PA9
TXCW	24	A27	60	PA26	PA26 <i>Note: Only needed for AT86RF230</i>

An example of using the AT91SAM7X-EK and the REB with the REX_ARM adaptor is shown in the following pictures.

Figure E-1-1 AT91SAM7X-EK Standard Board

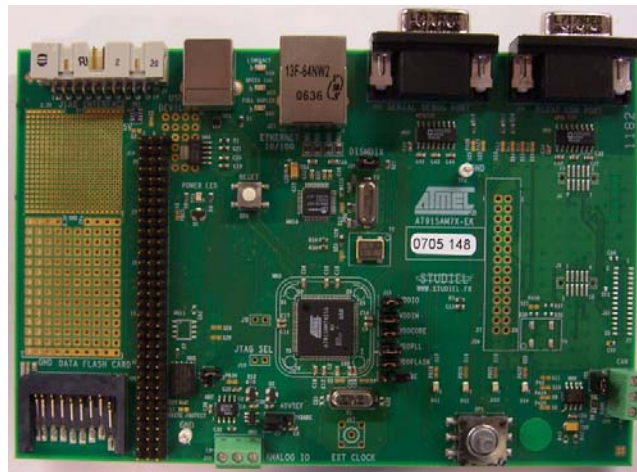


Figure E-1-2 REB and REX_ARM adaptor

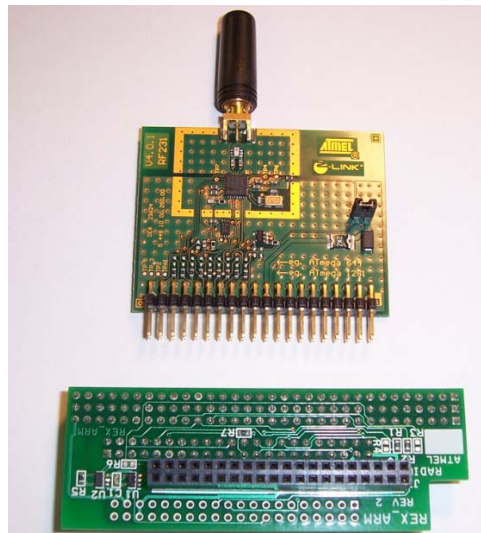
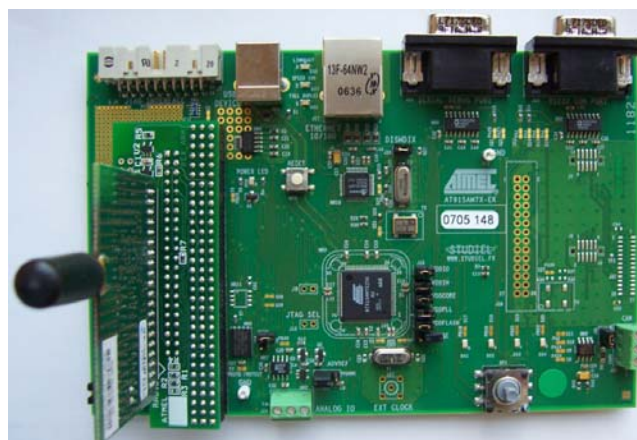


Figure E-1-3 AT91SAM7X-EK with REB/REX_ARM Connected





E.2 RCB212

This platform is a version of RCB (Radio Control Board) from Atmel, designed specifically for the AT86RF212 radio (in the 900 MHz band). Because this board operates in a different band from the RCB230 and RCB231 boards, RUM expects an RF212 radio on this platform. The REB (Radio Extender Board) for the RF212 also works with this profile.

This platform uses an ATmega1281 microcontroller, has three LED's, one push button, and a serial port for debug use.

E.3 RCB230

This platform is the original version of RCB (Radio Control Board) from Atmel, designed for the AT86RF230 radio (in the 2.4GHz band). This platform is also used for the original version of REB (Radio Extender Board) from Atmel. The REB must be plugged into an STK[®]500 development board.

This platform uses an ATmega1281 microcontroller, has three LED's, one push button, and a serial port for debug use.

E.4 RCB231

This platform is the updated version of RCB (Radio Control Board) from Atmel, designed to support the AT86RF231 radio. The updated REB (Radio Extender Board) also uses the RCB231 platform.

This platform uses an ATmega1281 microcontroller, has three LED's, one push button, and a serial port for debug use.

Note

The RCB and REB boards are available for customer purchase from third-party vendors.

There are a number of ways to use the RCB and REB

1. RCB plugged into STK541 loaded on an STK500.
2. STK541, connected to USB port of host computer, with RCB plugged in (USB communication not enabled).
3. RCB plugged into RCB_BB (RCB breakout board) with Serial interface.
4. REB (Radio Extender Board) plugged into AT91SAM7X-EK with a REX_ARM adaptor card.
5. REB (Radio Extender Board) plugged into STK500 with STK501.

All of these boards can be programmed with an Atmel JTAG-ICE MKII programmer, AVRISP programmer, or SAM-ICE programmer. The STK500 board can also program a target microcontroller via the serial port labeled "RS232 CTRL".

Note that the name RCB230 or RCB231 does not imply that the board must be loaded with the named radio. These names are historical, and carry those names because of the intended target radio to be used with the board. An RCB230 board can be loaded with an AT86RF231 radio and will operate correctly, as the RUM code detects which radio type is loaded and acts accordingly.

E.5 DSK001

This platform is a small circular PCB containing an RF230 or RF231 radio transceiver, an ATmega48/88/168/328 family microcontroller, a temperature sensor, and a three axis accelerometer. This board is available from TRT Technology (www.trttech.com), along with programming hardware and a compact plastic case. This platform has been FCC certified.

E.6 Compile Time Settings

These platforms can be compiled by defining the proper platform that was selected. These compile options are described in depth in section 3.2.1.

Table E-2 Compile Time Options

Option Name	Possible values	Meaning
PLATFORM	RCB230 RCB231 RCB212 DSK001	Build RUM to work with the given platform. This option can set other options, such as the band the radio operates in (900MHz or 2.4GHz). <i>Note: Not required for the ARM version of RUM. Set PLATFORM to 0.</i>

E.7 Fuses

Based on the selected platforms above, the following fuses can be used for the RUM operation:

RCB and REB based platforms: **0xFE; 0x91; 0xE2**

DSK001: **0x07; 0xD1; 0xE2**





Glossary

6LoWPAN - A scheme to compress and fragment IPv6 packets for transmission over an 802.15.4 wireless network. See RFC-4944 online for details.

Association - The method by which a new node joins the network. After association, a node is part of the network and can communicate freely with any other node on the network.

AVRISP - An Atmel programming tool for writing object code into most Atmel processors. Another similar tool is the JTAGICE MK-II.

Beacon - A special frame used to identify a network. A new node sends a beacon request packet, and receives back a beacon frame from a network that can be joined.

Band - The frequency spectrum in which the radio operates. The AT86RF212 chip operates in the 902MHz - 928 MHz band (and can be programmed to operate slightly outside that range), and the AT86RF230/AT86RF231 chips operate in the 2.405GHz - 2.480GHz band.

Channel - The AT86RF2xx chips can be operated on one of several channels. A RUM network operates on only one channel, which is chosen by the coordinator at startup. Channels 0-10 are in the 900MHz band, and channels 11-26 are in the 2.4GHz band.

Child node - Every node that is associated to the network - except the coordinator - has a parent node, and is a child of that parent.

Coordinator - The main node in the network, and one of the three node types. The other types are router and end node.

End node - A reduced-function node in the network. This node has similar functionality to a router node, but cannot route packets and also cannot associate child nodes.

Fragmentation - Breaking a packet into pieces for transmission, and re-assembling the pieces at the receiving end. This implementation of RUM and 6LoWPAN does not perform fragmentation.

Frame - A data packet to be sent over the air. All of the AT86RF2xx chips send data by a packet, which has a maximum length of 127 bytes.

HAL - Hardware Access Layer. The name for the software layer that directly accesses hardware. This layer is kept separate from the higher layers so that it can be interchanged from one architecture to another without modifying the upper protocol and application layers.

IEEE 802.15.4 - The IEEE specification that specifies radio parameters and modulation, data frame formats, and more about low-rate wireless sensor networks.

IPv6 - Internet Protocol version 6 - See Appendix C

JTAGICE MK-II - A programming and debugging tool used both for programming most AVR processors and debugging (stepping through code on a target system).

LQI - Link Quality Indication. A measure of the quality of a wireless link. The AT86RF2xx chips produce an LQI measurement of the link with every frame received.

MAC - Media Access Controller.

Multi-hop - A network that can relay packets over several wireless nodes to a destination. RUM has multi-hop capability, which allows a packet to send data to nodes that are out of range of the sending node.

PAN - Personal Area Network. Generic name for an IEEE 802.15.4 network.

PAN ID - Personal Area Network ID. A 16-bit identifier of a given network. All nodes on a PAN use this ID number as part of the addressing scheme.

Parent Node - Every node on the network - except for the coordinator - has a parent. The parent is a gateway to the network, and all data to and from a node passes through the parent node.

Platform - A platform is defined as a collection of interconnections between radio chip and microcontroller, along with some miscellaneous hardware configurations.

RF212 - Short name for Atmel's AT86RF212 transceiver.

RF230 - Short name for Atmel's AT86RF230 transceiver.

RF231 - Short name for Atmel's AT86RF231 transceiver.

RF2xx - Short name for any of Atmel's 802.15.4 transceivers.

Router node - One of three node types in a RUM network; the others are coordinator and end nodes. A router, as the name suggests, can relay packets for other nodes that cannot directly communicate with the coordinator. Router nodes can be used to collect data and actuate outputs, just like an end node.

RSSI - Received Signal Strength Indication. A measure of how strong the incoming RF signal is. RSSI can be measured by the AT86RF2xx chips during the RX_START portion of an incoming packet.

RTOS - Real-time operating system.

RUM - Route Under MAC. This protocol routes packets at the MAC layer, as opposed to the application or IPv6 layer, which would be a route *over* scheme. The *under* comes from the fact that routing is done at a low level.

Short Address – The two-byte (16-bit) address that is used to uniquely identify a node on a RUM network.

SPI - Serial Peripheral Interface. A standard method of communication between microcontrollers and peripheral chips. The AT86RF2xx chips communicate using SPI.

WinAVR - A windows-specific version of the GCC compiler for AVR microcontrollers, which is meant to be used with AVR Studio, a free, fully functional IDE for Atmel AVR microcontrollers.

WSN - Wireless Sensor Network.





Table of Contents

Features	1
1 Introduction	1
2 Stack Architecture	2
2.1 Overview of RUM	3
2.2 Overview of IPv6 and 6LoWPAN	3
2.3 Supported Hardware Platforms	4
2.3.1 AT91SAM7X-EK	4
2.3.2 Raven	4
2.3.3 Raven USB	5
2.3.4 ZIGBIT9/ZIGBIT24	5
3 AVR RUM Quickstart	6
3.1 Source Code	6
3.2 Compiling RUM	6
3.2.1 Compile-time Options	6
3.3 Build Sizes	10
3.4 Fuse settings	10
4 AT91SAM7X-EK RUM Quickstart	11
4.1 uTasker RTOS	11
4.1.1 uTasker Patches	12
4.2 Radio Interface	13
4.2.1 Hardware	13
4.2.2 Firmware	14
4.3 Serial Interfaces	14
4.4 Network Interfaces	15
4.5 AT91SAM-ICE	15
4.6 Loading the Program	16
4.7 Simple Web Interface	17
4.8 SD File Handling	19
5 Running the RUM Demo	20
5.1 Operation	20
5.1.1 Network Formation	20
5.1.2 Application Interface	20
5.1.3 Main Menu	20
6 Running the IPv6 Demo	23
6.1 Computer/Network Setup	23
6.2 Ping Demo	23
6.3 Using the 6LoWPAN / IPv6 Code on End Nodes	25
6.4 IPSO App Example	25

6.4.1 Commands on Port 61616..... 26

6.4.2 Commands on Port 61618..... 27

6.5 Sensor App Example..... 28

6.6 TFTP Bootloading 29

6.7 Sleeping Nodes 30

Appendix A - Route Under MAC (RUM) Protocol 31

A.1 Overview 31

A.2 Features 31

A.3 Assumptions..... 31

A.4 Implementation Details 32

 A.4.1 End node..... 32

 A.4.2 Router node 33

 A.4.3 Coordinator node 35

A.5 Examples of network operation..... 36

 A.5.1 Example 1 – End node connecting to coordinator..... 37

 A.5.2 Example 2 – Router R1 connects to Coordinator C 38

 A.5.3 Example 3 – Router R3 connects to Coordinator C 39

 A.5.4 Example 4 – Router R2 connects to Network 39

 A.5.5 Example 5 – End node E2 connects to network..... 40

A.6 Routing packets 41

 A.6.1 Data packets 41

A.7 Packet Formats 42

Appendix B - Firmware API Overview 43

B.1 Program Organization..... 43

B.2 RUM API 50

 B.2.1 Coordinator commands..... 50

 B.2.2 Router and end node commands..... 50

B.3 6LoWPAN API..... 52

B.4 Writing a Custom Application Using RUM 54

 B.4.1 Step 1: Make sure the hardware is compatible with RUM..... 54

 B.4.2 Step 2: Define a new PLATFORM for the hardware 55

 B.4.3 Step 3: Verify that the transceiver is communicating with the microcontroller..... 57

 B.4.4 Step 4: Verify that the RUM network is working on the hardware 58

Appendix C - IPv6 / 6LoWPAN Background 59

C.1 The problem with RF-Only Networks..... 59

C.2 Why IP? 59

C.3 6LoWPAN to the Rescue 59

C.4 A Crash Course in IPv6 59

 C.4.1 IPv6 Addressing..... 59

 C.4.2 IPv6 Neighbor Discovery 60

 C.4.3 Node Auto-configuration 61

C.5 6LoWPAN Basics 62





C.5.1 Draft-ietf-6lowpan-hc01.....	62
C.6 6LoWPAN Compressed Header.....	63
Appendix D - AT91SAM7X-EK Development Tools.....	65
D.1 Folder Structure	65
D.2 Rowley Crossworks IDE	66
D.2.1 Rowley RUM Project.....	67
D.3 Eclipse IDE	70
D.3.1 Required Tools	70
D.3.1.1 YAGARTO	70
D.3.1.2 Eclipse	70
D.3.1.3 J-Link Software and Documentation Pack from Segger	70
D.3.1.4 AT91SAM-ICE (SAM-PROG).....	70
D.3.2 Installing.....	70
D.3.3 Building RUM – Step by Step	70
D.3.4 Debugging RUM Step-By-Step	75
D.3.4.1 Zylind CDT plugin	75
D.3.5 Programming the FLASH.....	77
Appendix E - Third-Party Reference Designs / Platforms	84
E.1 REB and REX_ARM Adaptor.....	84
E.2 RCB212.....	86
E.3 RCB230.....	86
E.4 RCB231.....	86
E.5 DSK001	87
E.6 Compile Time Settings.....	87
E.7 Fuses	87
Glossary	88
Table of Contents.....	90



Headquarters

Atmel Corporation
2325 Orchard Parkway
San Jose, CA 95131
USA
Tel: 1(408) 441-0311
Fax: 1(408) 487-2600

International

Atmel Asia
Unit 1-5 & 16, 19/F
BEA Tower, Millennium City 5
418 Kwun Tong Road
Kwun Tong, Kowloon
Hong Kong
Tel: (852) 2245-6100
Fax: (852) 2722-1369

Atmel Europe
Le Krebs
8, Rue Jean-Pierre Timbaud
BP 309
78054 Saint-Quentin-en-
Yvelines Cedex
France
Tel: (33) 1-30-60-70-00
Fax: (33) 1-30-60-71-11

Atmel Japan
9F, Tonetsu Shinkawa Bldg.
1-24-8 Shinkawa
Chuo-ku, Tokyo 104-0033
Japan
Tel: (81) 3-3523-3551
Fax: (81) 3-3523-7581

Product Contact

Web Site
www.atmel.com

Technical Support
avr@atmel.com

Sales Contact
www.atmel.com/contacts

Literature Request
www.atmel.com/literature

Disclaimer: The information in this document is provided in connection with Atmel products. No license, express or implied, by estoppel or otherwise, to any intellectual property right is granted by this document or in connection with the sale of Atmel products. **EXCEPT AS SET FORTH IN ATMEL'S TERMS AND CONDITIONS OF SALE LOCATED ON ATMEL'S WEB SITE, ATMEL ASSUMES NO LIABILITY WHATSOEVER AND DISCLAIMS ANY EXPRESS, IMPLIED OR STATUTORY WARRANTY RELATING TO ITS PRODUCTS INCLUDING, BUT NOT LIMITED TO, THE IMPLIED WARRANTY OF MERCHANTABILITY, FITNESS FOR A PARTICULAR PURPOSE, OR NON-INFRINGEMENT. IN NO EVENT SHALL ATMEL BE LIABLE FOR ANY DIRECT, INDIRECT, CONSEQUENTIAL, PUNITIVE, SPECIAL OR INCIDENTAL DAMAGES (INCLUDING, WITHOUT LIMITATION, DAMAGES FOR LOSS OF PROFITS, BUSINESS INTERRUPTION, OR LOSS OF INFORMATION) ARISING OUT OF THE USE OR INABILITY TO USE THIS DOCUMENT, EVEN IF ATMEL HAS BEEN ADVISED OF THE POSSIBILITY OF SUCH DAMAGES.** Atmel makes no representations or warranties with respect to the accuracy or completeness of the contents of this document and reserves the right to make changes to specifications and product descriptions at any time without notice. Atmel does not make any commitment to update the information contained herein. Unless specifically provided otherwise, Atmel products are not suitable for, and shall not be used in, automotive applications. Atmel's products are not intended, authorized, or warranted for use as components in applications intended to support or sustain life.

© 2009 Atmel Corporation. All rights reserved. Atmel®, Atmel logo and combinations thereof, AVR®, STK®, AVR Studio®, SAM-BA® and others, are the registered trademarks, ZigBit™, MeshBean™ and others are trademarks of Atmel Corporation or its subsidiaries. Windows® and others are registered trademarks or trademarks of Microsoft Corporation in the US and/or other countries. ARM® is a registered trademark of ARM Ltd. Other terms and product names may be trademarks of others.

Free Manuals Download Website

<http://myh66.com>

<http://usermanuals.us>

<http://www.somanuals.com>

<http://www.4manuals.cc>

<http://www.manual-lib.com>

<http://www.404manual.com>

<http://www.luxmanual.com>

<http://aubethermostatmanual.com>

Golf course search by state

<http://golfingnear.com>

Email search by domain

<http://emailbydomain.com>

Auto manuals search

<http://auto.somanuals.com>

TV manuals search

<http://tv.somanuals.com>