

---

## ***Instruction Manual***

ATR2500-USB  
Cardioid Condenser USB Microphone

### ***Contents***

Introduction & features	2
Setting up your microphone with pivot mount & desk stand	3
Preliminary setup with Mac OS X	4
Preliminary setup with Windows XP	6
Preliminary setup with Windows Vista	9
Preliminary setup with Windows 7	10
Using headphones	13
Selecting software	13
Setting your software levels	13
Positioning your microphone	13
Protecting your microphone	13
Specifications	14
Warranty	15

### **Compliance with FCC rules (USA only)**

This device complies with Part 15 of the FCC rules. Operation is subject to the following two conditions:(1) this device may not cause harmful interference, and (2) this device must accept any interference received, including interference that may cause undesired operation.

### **FCC WARNING**

You are cautioned that any changes or modifications not expressly approved in this manual could void your authority to operate this equipment.

### **Canada only**

This Class B digital apparatus complies with Canadian ICES-003.

Cet appareil numérique de la classe B est conforme á la norme NMB -003 du Canada.

Thank you for buying the Audio-Technica ATR2500-USB cardioid condenser microphone. Designed for computer-based recording, this microphone is ideal for digitally capturing music or any acoustic audio source using your favorite recording software.

Equipped with a USB output for easy connection to your computer, the ATR2500-USB offers studio-quality articulation and intelligibility perfect for home studio recording, field recording, podcasting, and voiceover use.

The ATR2500-USB also features a built-in headphone jack with volume control that allows you to directly monitor your microphone's output during recording. The microphone's focused pickup pattern delivers excellent off-axis rejection, while its A/D converter with a 16-bit, 44.1/48 kHz sampling rate ensures clear, articulate sound reproduction.

Audio-Technica's state-of-the-art design and manufacturing techniques ensure that the microphone complies with the company's renowned consistency and reliability standards.

### **Features**

- Side-address studio condenser microphone with USB output for easy connection to your computer
- Ideal for podcasting, home studio recording, field recording, and voiceover use
- Built-in headphone jack allows you to directly monitor your microphone's output without audible delay
- Adjust headphone volume with easy-to-use controls on the front of the microphone
- High-quality A/D converter with 16-bit, 44.1/48 kHz sampling rate
- Compatible with Windows and Mac
- Low-mass diaphragm provides excellent frequency response
- Cardioid polar pattern reduces pickup of sounds from the sides and rear, improving isolation of desired sound source
- Low self-noise – ideally suited for digital recording equipment
- Pivoting, threaded stand mount attaches securely for easy and precise placement of the microphone
- Tripod desk stand with folding legs for secure and easily portable tabletop use

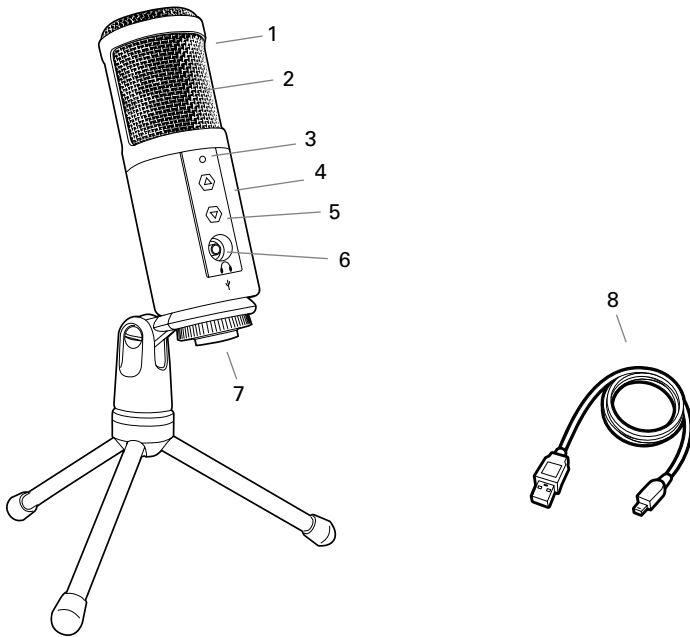

- 1. Windscreen**—Multi-stage grille design offers excellent protection against plosives and sibilance without compromising high-frequency clarity
- 2. Capsule**—Condenser microphone element with cardioid polar pattern
- 3. Blue LED**—Blue light shows mic is receiving USB power
- 4. Metal construction**—Tough, durable, resilient design
- 5. Headphone level control**—Soft-touch buttons control headphone volume
- 6. Headphone jack**—1/8-inch (3.5 mm) stereo jack for connecting your headphones
- 7. USB**—USB connector for connection to your Mac or PC
- 8. USB cable**

### Setting up your microphone with included pivot mount and tripod desk stand

- A.** Screw the pivot mount microphone adapter onto the threaded portion of the desk stand.
- B.** Extend the tripod legs to provide a wide, secure base. Place the tripod desk stand on a flat surface.
- C.** Install the ATR2500-USB microphone through the tapered side of the collar of the pivot mount. While holding the microphone in place, screw the threaded ring to the threaded portion of the microphone that extends through the collar, and tighten.
- D.** The front of the microphone should be facing the sound source. (The USB icon and LED indicate the front of the microphone.)
- E.** Use a screwdriver or coin to loosen and tighten the pivot screw for angle adjustment.
- F.** Plug the provided USB cable into the USB output at the base of the microphone.

**Note:** Many recording software programs are available online. Audacity is widely used free software for recording and editing sounds. It is available online at <http://audacity.sourceforge.net/>

---

## Preliminary setup with Mac OS X

---

1. Plug the free end of the provided USB cable into the USB port on your computer. The microphone's blue LED will illuminate, indicating the microphone is receiving power. Your computer will automatically recognize the USB device and install a driver.
2. To select the ATR2500-USB as your audio input, first, open your **System Preferences**.

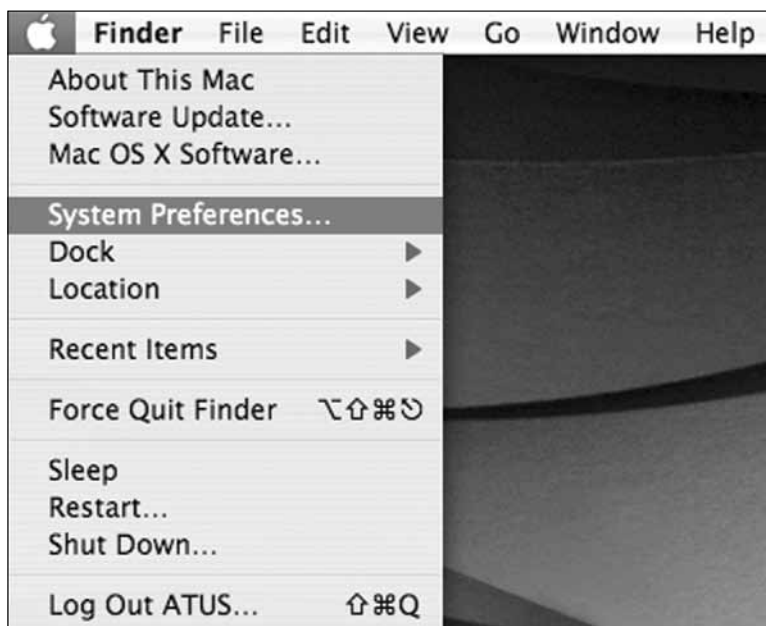

3. Next, click Sound to display the **Sound** preference pane.



4. Click the **Input** tab and select the **ATR2500-USB** as the device for sound input.

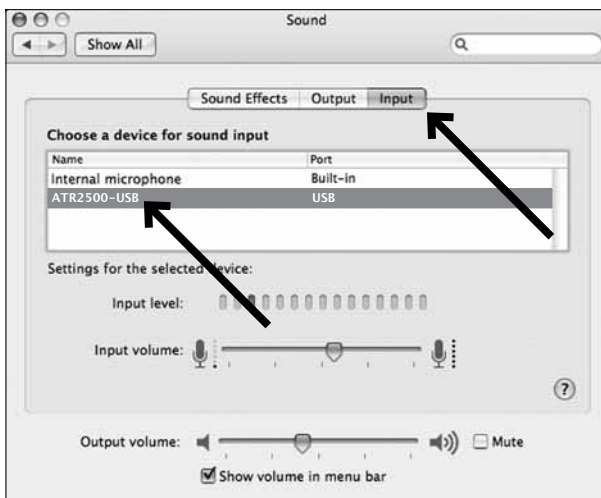

Your preferences are now set to use the ATR2500-USB on your Mac with GarageBand or another recording program of your choice.

## Preliminary setup with Windows XP

(Service Pack 2; other operating systems may vary slightly)

1. Plug the free end of the USB cable into the USB port on your computer. The microphone's blue LED will illuminate, indicating the mic is receiving power. Your computer will automatically recognize the USB device and install a driver.
2. In the lower right portion of your screen you may see a message that new hardware was found; or you may see a driver software installation notice.
3. To select the ATR2500-USB as your default recording device, begin at your **Start** menu. Select **Control Panel**.



#### 4. Select Sounds and Audio Devices.

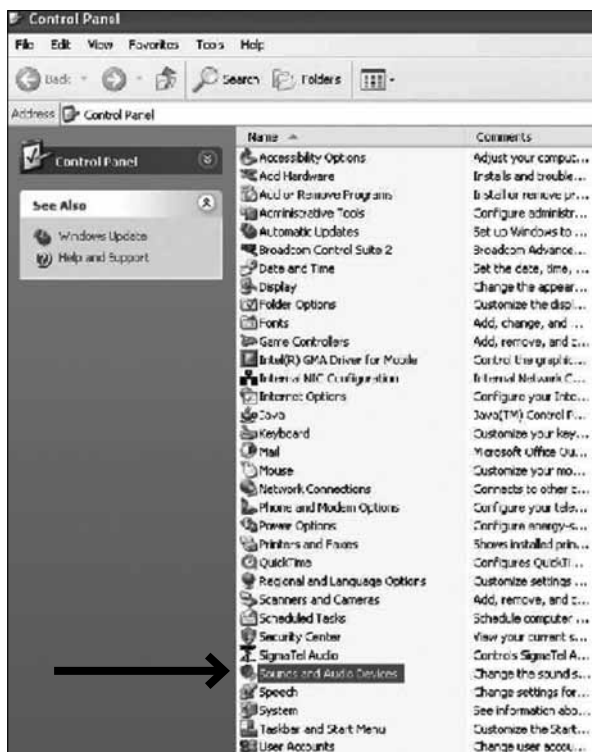

## Preliminary setup with Windows XP (continued)

5. Select the **Audio** tab, and choose **ATR2500-USB** as the default device.
6. Adjust computer volume by clicking on the **Volume** button beneath Sound recording Default device.

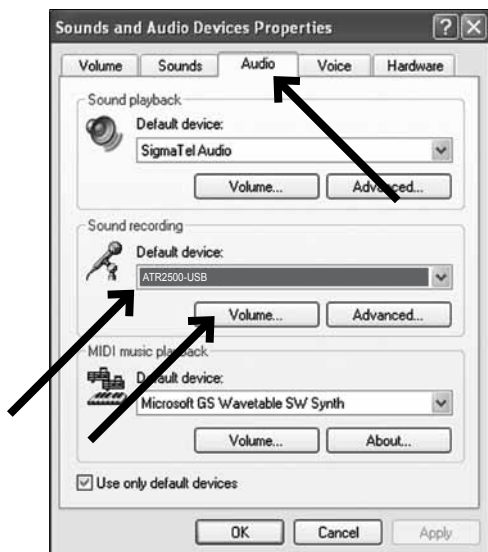

7. Through the **Wave In** window, you can set the computer volume or mute the microphone.

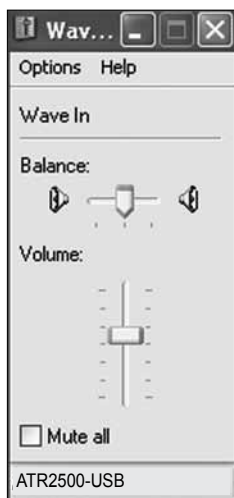

Your preferences are now set to use the ATR2500-USB with Windows XP with the recording program of your choice.



# Preliminary setup with Windows Vista

1. Plug the free end of the USB cable into the USB port on your computer. The microphone's blue LED will illuminate, indicating the mic is receiving power. Your computer will automatically recognize the USB device and install a driver.
2. In the lower right portion of your screen you may see a message that new hardware was found; or you may see a driver software installation notice.
3. To select the ATR2500-USB as your default recording device, begin at your **Start** menu. Select **Control Panel**.
4. Select (double-click) **Sound**.



5. Select the **Recording** tab. Make sure that the **ATR2500-USB** microphone is set as the default recording device. (You should see a green check mark beside the USB microphone icon.)

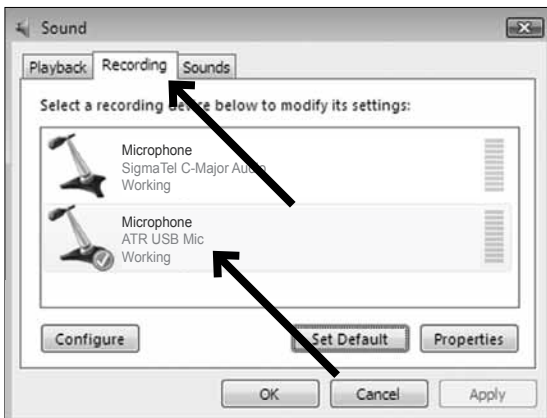

Your preferences are now set to use the ATR2500-USB with Windows Vista with the recording program of your choice.

## Preliminary setup with Windows 7

1. Plug the free end of the USB cable into the USB port on your computer. The microphone's blue LED light will illuminate, indicating the mic is receiving power. Your computer will automatically recognize the USB device and install a driver.
2. In the lower right portion of your screen you may get a message that new hardware was found; or you may see a driver software installation notice.
3. **Start menu > Control Panel > Sound**  
To select the ATR2500-USB as your default recording device, begin at your Start menu. Select **Control Panel**.

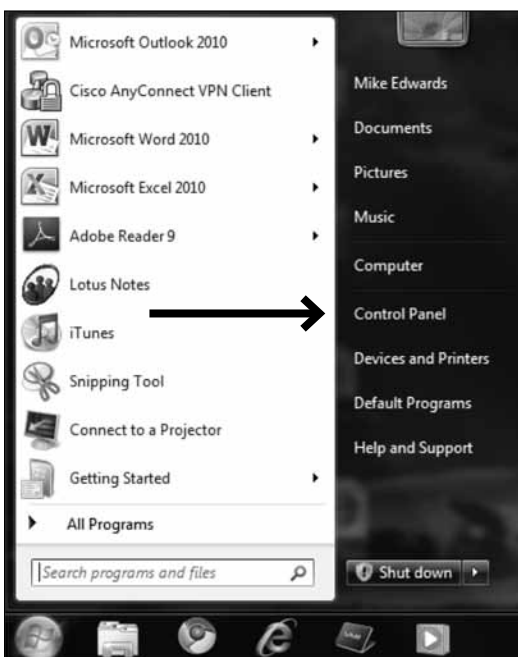

4. Select **Sound**.

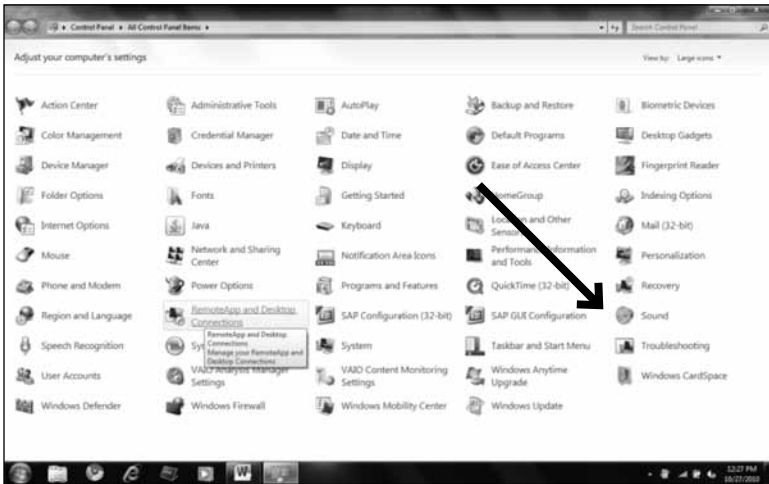

5. The following screen will pop up:



## Preliminary setup with Windows 7 (continued)

6. Select the **Recording** tab, and choose **ATR-USB MIC** as the default device.

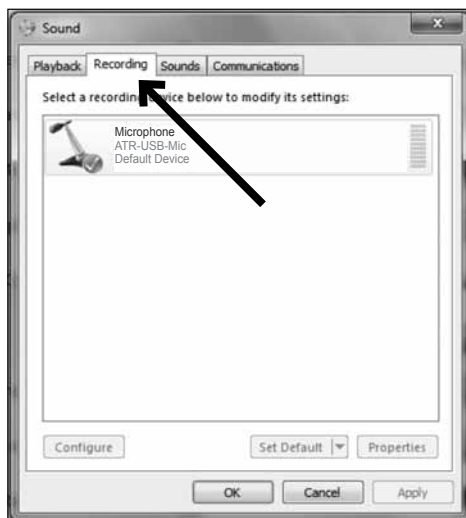

7. Double click on the ATR-USB-Mic icon to open the **Microphone Properties** window. Select the levels tab to adjust microphone level (loudness). You may need to come back to this window to readjust the level after you begin recording.

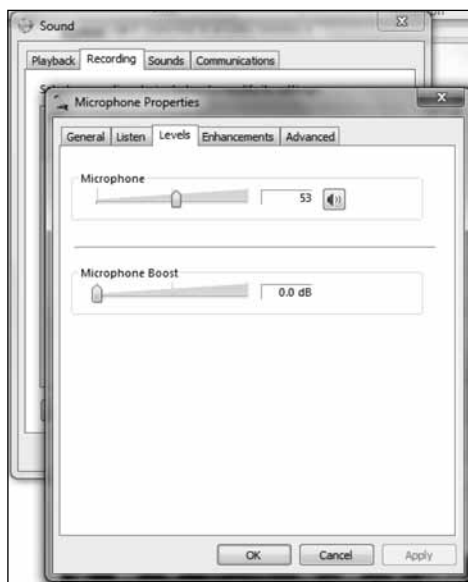

Your preferences are now set to use the ATR2500-USB with Windows 7 with the recording program of your choice.

### Using Headphones

The 1/8" (3.5 mm) headphone jack on the bottom of the microphone allows you to directly monitor your recording with a pair of headphones. When your preliminary setup is completed, and your USB microphone is connected to your computer's USB port (the microphone's blue LED is illuminated), plug your headphones into the headphone jack on the bottom of the microphone. While talking into the microphone, you should hear yourself in the headphones. Adjust the volume up or down by pressing the Up and Down buttons on the front of the microphone. **Note:** The Up and Down buttons only adjust the volume of the mic's headphone output; they do not adjust the microphone level.

### Selecting software

You have many choices in recording software. Audacity, available for free online at <http://audacity.sourceforge.net/>, is a widely used software program that provides basic recording software.

### Setting your software levels

Correct adjustment of microphone level is important for optimum performance. Ideally, the microphone level should be as high as possible without overloading the input of your computer. If you hear distortion, or if your recording program shows levels that are consistently overloaded (at peak levels), turn the microphone volume (or level) down, either through your control panel (or system preferences) settings, or through your recording software. If your recording program shows insufficient level, you can increase the microphone gain either from the control panel (or system preferences) settings or through your recording program.

No further microphone level adjustments should be needed, as long as the acoustic input does not change significantly.

### Positioning your microphone

It is important to position the microphone directly in line (on axis) with the person speaking/singing or instrument (or other sound source) to achieve the best frequency response of the microphone.

For use in speaking/singing applications, the ideal placement for the microphone is directly in front of the person speaking/singing. The same placement is optimal when miking an instrument such as an acoustic guitar, drums or piano. Experiment with different mic placements to find the best sound for your particular setup.

### Protecting your microphone

Avoid leaving your microphone in the open sun or in areas where temperatures exceed 110° F (43° C) for extended periods. Extremely high humidity should also be avoided.

# ATR2500-USB Specifications†

Element: Condenser

Polar Pattern: Cardioid

Frequency Response: 30 – 15,000 Hz

Power Requirements: USB Power (5V DC)

Bit Depth: 16 bit

Sample Rate: 44.1 kHz/48 kHz

Weight: 366 g (12.9 oz)

Dimensions: 155.0 mm (6.10") long, 50.0 mm (1.97") maximum body diameter

Output Connector: USB-type

Headphone Output Power: 10 mW @ 16 ohms

Headphone Volume Control: Up/Down buttons for level adjustment on front of microphone

Headphone Jack: 3.5 mm (1/8") TRS (stereo)

Accessories Furnished: Pivoting stand mount for 5/8"-27 threaded stands; tripod desk stand; 1.8 m (5.9') mini USB cable

System Requirements: Macintosh: Mac OS X; USB 1.0 or 2.0; 64 MB RAM (minimum);  
Windows: XP/Vista/Windows 7; USB 1.0 or 2.0; 64 MB RAM (minimum)

†In the interest of standards development, A.T.U.S. offers full details on its test methods to other industry professionals on request. Specifications are subject to change without notice.

## Frequency Response

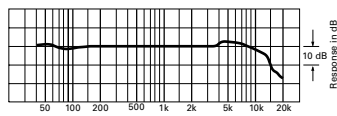

LEGEND — 12" or more on axis

## Polar Pattern

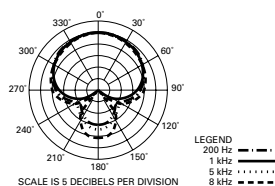

---

## **ATR2500-USB U.S. Lifetime Limited Warranty**

---

This product is warranted in the U.S.A. by Audio-Technica U.S., Inc. (A.T.U.S.) for the lifetime of the original purchaser. During the warranty period, A.T.U.S. will repair or replace these products, provided they are sent prepaid to the address below, with proof of original purchase and \$15.00 for handling and return to a U.S. address. Check or money order required; no cash or stamps. A.T.U.S. reserves the right to replace any product with one of equal value.

Except to the extent precluded by applicable state law, A.T.U.S. will have no liability for any consequential, incidental, or special damages; any warranty of merchantability or fitness for particular purpose expires when this warranty expires. This warranty gives you specific legal rights, and you may have other rights which vary from state to state.

Outside the U.S.A., please contact your local dealer for warranty details.

**Register your product at [audio-technica.com](http://audio-technica.com)**

**Audio-Technica U.S., Inc.**

1221 Commerce Drive, Stow, Ohio 44224 USA

---

## ATR2500-USB

---

To reduce the environmental impact of a multi-language printed document, product information is available online at [www.audio-technica.com](http://www.audio-technica.com) in a selection of languages.

Afin de réduire l'impact sur l'environnement de l'impression de plusieurs, les informations concernant les produits sont disponibles sur le site [www.audio-technica.com](http://www.audio-technica.com) dans une large sélection de langue.

Para reducir el impacto al medioambiente, y reducir la producción de documentos en varios leguajes, información de nuestros productos están disponibles en nuestra página del Internet: [www.audio-technica.com](http://www.audio-technica.com).



**Audio-Technica U.S., Inc.**

1221 Commerce Drive, Stow, Ohio 44224 USA +1 (330) 686-2600

©2011 Audio-Technica U.S., Inc. P52300





## Free Manuals Download Website

<http://myh66.com>

<http://usermanuals.us>

<http://www.somanuals.com>

<http://www.4manuals.cc>

<http://www.manual-lib.com>

<http://www.404manual.com>

<http://www.luxmanual.com>

<http://aubethermostatmanual.com>

Golf course search by state

<http://golfingnear.com>

Email search by domain

<http://emailbydomain.com>

Auto manuals search

<http://auto.somanuals.com>

TV manuals search

<http://tv.somanuals.com>