



Audiobahn®

QUALITY, RELIABILITY, & PURE BLISS



**XM READY CD PLAYER WITH FLIP-DOWN
DETACHABLE FACE IPOD DIRECT
USB INTERFACE AND REMOTE
A1200N**

**OPERATING INSTRUCTIONS
PLEASE RETAIN MANUAL FOR FUTURE USE AND REFERENCE**

The Audiobahn Way

To bring the product to market that excites the consumer through sound and vision from an orientation of integrity and customer service. We make you look as good as you sound. We strive to take car audio to an extreme the world has never seen, and a world that never stops evolving.

Audiobahn was established in 1997 with one long-term goal in mind, **"Build it Bigger, Badder, & Better, and the people will take notice!"** We back this statement with an engineering team that has brought home several Innovations, Design & Engineering Showcase Awards, and a marketing team from around the world that spends countless hours developing our no compromise products to satisfy the most discriminating enthusiasts.

Our global manufacturing facilities feature ISO9002 ratings (the highest level of quality control awarded in the electronics manufacturing industry), fully robotic assembly lines and a state of the art, California based R & D laboratory.

Due to overwhelming response from our competitors, and our goal to participate in even more events this year, we created **"TEAM AUDIOBAHN."** This organization is designed to create a support network along with shirts and perks for team members. "TEAM AUDIOBAHN" is not only for the diehard competitor, but also for anyone that loves car audio as much as we do. With four levels of play, one is right for you to get started in the Audiobahn family.

Our Technical Department and entire staff look to strive above and beyond the rest of the pack by going that extra mile to help you out. Whether you happen to be a veteran competitor, or a beginner car audio enthusiast that does not know a voice coil from a spider. We are all here to help you get the best system you can with what you have.

Judge for yourself, and remember what it's all about, **"If it's not Bigger, Badder & Better, it's not Audiobahn."** If audio is your life, Audiobahn is the brand for you! We make you look as good as you sound. People never stop trying to get the best product, so we will never stop making it.

*To learn more about "TEAM AUDIOBAHN" please give us a call, see our website at www.audiobahninc.com, or email us at team@audiobahninc.com to learn about all the details.

Dear Customer,

Congratulations on your purchase of the worlds finest brand of car audio products. Here at Audiobahn Inc. we are devoted to making our musical reproduction the very best, and we are pleased you have chosen our product. Through years of engineering expertise, hand craftsmanship, and critical testing procedures, we have created a wide range of products that reproduce music with all the clarity and richness you deserve.

For maximum performance we recommend you have your Audiobahn product installed by an Authorized Audiobahn Dealer, as we provide specialized training through our Audiobahn Installer Training Programs. Please read your warranty, keep your receipt, and original carton for possible future use.

Great products and proper installation are only a small piece of the puzzle when it comes to your system. Make sure that your installer is using only 100% authentic installation accessories from the Audiobahn Connections. The Audiobahn Connections line has everything ranging from the smallest terminal, to power wires up to 0 gauge, and 4 channel RCA cables.

To get a free brochure on Audiobahn products and Audiobahn Connections in the U.S. call (714) 988-0400 or e-mail us at sales@audiobahninc.com.

WARNING

Continuous exposure to sound pressure levels over 100 dB may cause permanent hearing loss. High powered autosound systems may produce sound pressure levels well over 135dB. Need we say more! Use common sense.

If after reading this manual, you still have questions regarding your product, we recommend that you see your nearest Audiobahn Dealer. A list of Authorized Audiobahn Dealers can be found on our web page. If you need further assistance, feel free to call us at (800)488-8595 and ask for the Technical Department. Be sure to have the model number, date of purchase, and invoice number available when you call.

The model number can be located on the outside of the carton. Record this in the space provided below along with the date of purchase. It is a good idea to keep your receipt with this, as you will need it in the case of a warranty repair or exchange.

Model Number: _____ Date of Purchase: _____

Installation	4	Pausing playing	13
Take out screw before installation.....	4	Previewing all tracks.....	13
DIN Front-Mount (Method A)	4	Repeating the same track	13
Installing the unit	4	Playing all tracks in random	13
Removing the unit.....	5	Ejecting a disc	13
DIN Rear-Mount (Method B)	6	CDC operation	13
Using the detachable front panel	7	Switching to CDC mode.....	13
Wiring Connection	8	Selecting tracks.....	13
Operation	9	Pausing playing	13
Location of keys.....	8	Previewing all tracks.....	13
Switching on/off the unit	10	Repeating individual tracks or	
Faceplate release	10	whole CDs	13
Sound adjustment.....	10	Playing all tracks in random	13
Loudness	10	Selecting disc	13
Display information	10	MP3 operation	14
Set the clock	10	Switching to CD (MP3) mode.....	14
Mute.....	10	Ejecting a disc	14
Equalization.....	10	Selecting tracks in single step.....	14
Liquid crystal display	10	Selecting directory up/down	14
Remote sensor	10	Pausing playing	14
Flashing LED	10	Previewing all tracks.....	14
ESP function	10	Repeating the same track	14
Reset function.....	11	Playing all tracks in random	14
Radio operation	11	Selecting tracks by	
Switching to radio mode	11	AS/PS/D-AUD button	14
Selecting the frequency band.....	11	Display information.....	15
Selecting station	11	WMA operation.....	15
Local/distance	11	Audio DSP (MP3/WMA decoder).....	16
Automatic memory storing &		Mixed-CD operation.....	16
program scanning.....	11	IPOD Operaton.....	16
Station storing	11	Disc notes	17
Mono/stereo	11	Remote Control handset	18
XM operation.....	12	Specification.....	19
Switching to XM mode	12	Trouble shooting	20
Selecting user-preset channel	12	Warning / Disclaimer.....	21
Selecting channel up/down.....	12	Warranty.....	22-23
Searching channel	12		
Storing preset channels.....	12		
XM mode selection.....	12		
CD operation.....	13		
Switching to CD mode	13		
Selecting tracks	13		

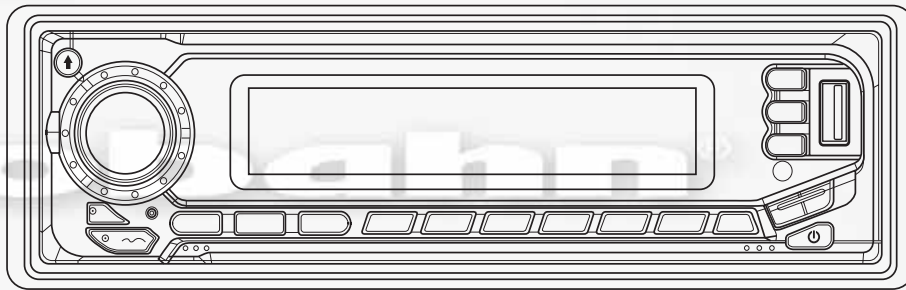

- **PLL Synthesizer Stereo Radio**
- **CD Player/MP3 Player/WMA Player**
- **XM Function**
- **IPOD Function**
- **USB Interface**
- **Automatic Memory Storing**
- **Fold Down Detachable Panel**
- **Preset Equalization**
- **Electronic Shockproof (ESP) Function**
- **CD Changer Control**
- **Auxiliary Input Function**
- **Remote Control**

Notes:

- Choose the mounting location where the unit will not interfere with the normal driving function of the driver.
- Before finally installing the unit, connect the wiring temporarily and make sure it is all connected up properly and the unit and the system work properly.
- Use only the parts included with the unit to ensure proper installation. The use of unauthorized parts can cause malfunctions.
- Consult with your nearest dealer if installation requires the drilling of holes or other modifications of the vehicle.
- Install the unit where it does not get in the driver's way and cannot injure the passenger if there is a sudden stop, like an emergency stop.
- If installation angle exceeds 30° from horizontal, the unit might not give its optimum performance.

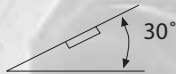

- Avoid installing the unit where it would be subject to high temperature, such as from direct sunlight, or from hot air, from the heater, or where it would be subject to dust, dirt or excessive vibration.

DIN FRONT/REAR-MOUNT

This unit can be properly installed either from "Front" (conventional DIN Front-mount) or "Rear" (DIN Rear-mount installation, utilizing threaded screw holes at the sides of the unit chassis). For details, refer to the following illustrated installation methods.

TAKE OUT SCREW BEFORE INSTALLATION

Before install the unit, please remove the two screws.

Take out screw before installation

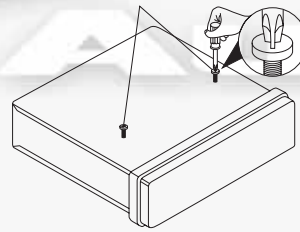

DIN FRONT-MOUNT (Method A)

Installation Opening

This unit can be installed in any dashboard having an opening as show below:



Installing the unit

Be sure you test all connections first, and then follow these steps to install the unit.

1. Make sure the ignition is turned off, and then disconnect the cable from the vehicle battery's negative (-) terminal.
2. Disconnect the wire harness and the antenna.
3. Press the release button on the front panel and remove the control panel (see the steps of "to detach the front panel").
4. Lift the top of the outer trim ring then pull it out to remove it.
5. The two supplied keys release tabs inside the unit's sleeve so you can remove it. Insert the keys as far as they will go (with the notches facing up) into the appropriate slots at the middle left and right sides of the unit. Then slide the sleeve off the back of the unit.

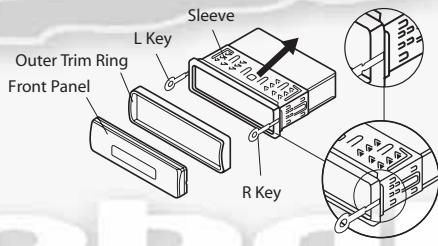

6. Mount the sleeve by inserting the sleeve into the opening of the dashboard and bend open the tabs located around the sleeve with a screwdriver. Not all tabs will be able to make contact, so examine which ones will be most effective. Bending open the appropriate tabs behind the dashboard to secure the sleeve in place.

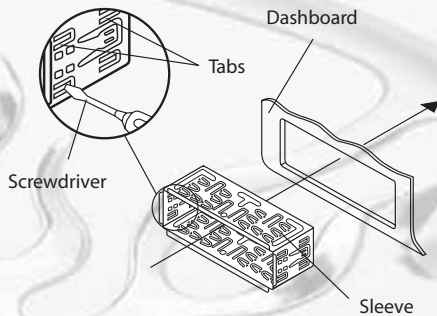

7. Reconnect the wire harness and the antenna and be careful not to pinch any wires or cables.
8. Slide the unit into the sleeve until it locks into place.
9. To further secure the unit, use the supplied metal strap to secure the back of the unit in place. Use the supplied hardware (Hex Nut (M5mm) and Spring Washer) to attach one end of the strap to the mounting bolt on the back of the unit. If necessary, bend the metal strap to fit your vehicle's mounting area. Then use the supplied hardware (Tapping Screw (5x25mm) and Plain Washer) to attach the other end of metal strap to a solid metal part of the vehicle under the dashboard. This strap also helps ensure proper electrical grounding of the unit.

Note: to install the short threading terminal of the mounting bolt to the back of the unit and the other long threading terminal to the dashboard.

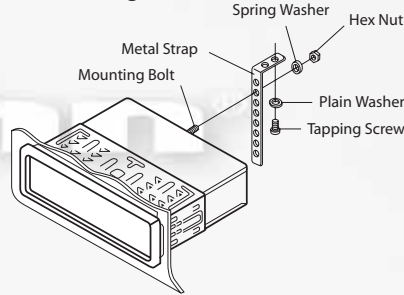

10. Reconnect the cable to the vehicle battery's negative (-) terminal. Then replace the outer trim ring and install the unit's front panel. (see the steps of "to install the front panel").

Removing the unit

1. Make sure the ignition is turned off, then disconnect the cable from the vehicle battery's negative (-) terminal.
2. Remove the metal strap attached the back of the unit (if attached).
3. Press the release button to remove the front panel.
4. Lift the top of the outer trim ring then pull it out to remove it.
5. Insert both of the supplied keys into the slots at the middle left and right sides of the unit, then pull the unit out of the dashboard.

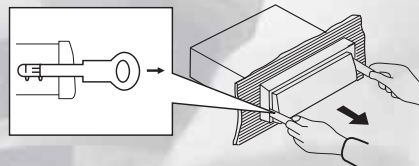

DIN REAR-MOUNT (Method B)

If your vehicle is a Nissan, Toyota, follow these mounting instructions.

Use the screw holes marked T (Toyota), N (Nissan) located on both sides of the unit to fasten the unit to the factory radio mounting brackets supplied with your vehicle.

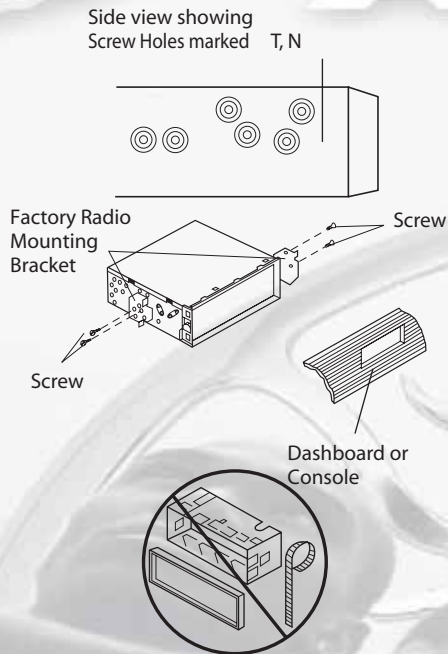

To fasten the unit to the factory radio mounting brackets.

Align the screw holes on the bracket with the screw holes on the unit, and then tighten the screws (5x5mm) on each side.

Note: the outer trim ring, sleeve and the metal strap are not used for method B installation.

To Detach the Front Panel

1. Press the **OPEN/CLOSE** button, then the front panel will slide down.

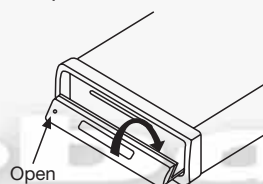

2. Press the **OPEN/CLOSE** button again, the front panel will slide up.

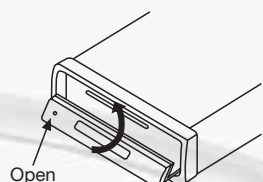

3. When the front panel slides down, press the bottom button of the front panel upward and pull it out from the panel bracket.

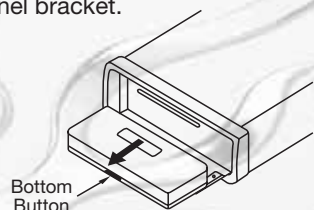

4. For safekeeping, store the front panel in the supplied protective case immediately after being removed.

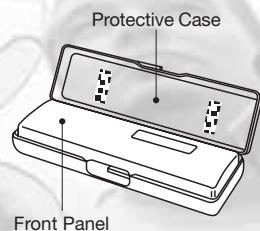

To Reinstall the Front Panel

1. When the panel bracket is in slide-down position, insert the front panel into panel bracket and press **OPEN/CLOSE** button to slide up.

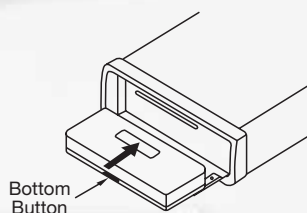

2. When the panel bracket is in slide-up position, insert one side of the front panel to its proper position and push the other side into the panel bracket, a 'click' sound should be heard.

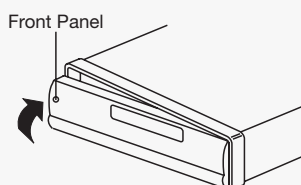

3. Note that if the front panel fails to lock in position properly, pressing control button may not function and the display may be missing some segments. Press the **OPEN/CLOSE** button and then reinstall the front panel again.

Precautions when handling

1. Do not drop the front panel.
2. Do not put pressure on the display or control buttons when detaching or re-installing the front panel.
3. Do not touch the contacts on the front panel or on the main unit body. It may result in poor electrical contact.
4. If any dirt or foreign substances adhered on the contacts, they can be removed with a clean and dry cloth.
5. Do not expose the front panel to high temperatures or direct sunlight in anywhere.
6. Keep away any volatile agents (e.g. benzene, thinner, or insecticides) from touching the surface of the front panel.
7. Do not attempt to disassemble the front panel.

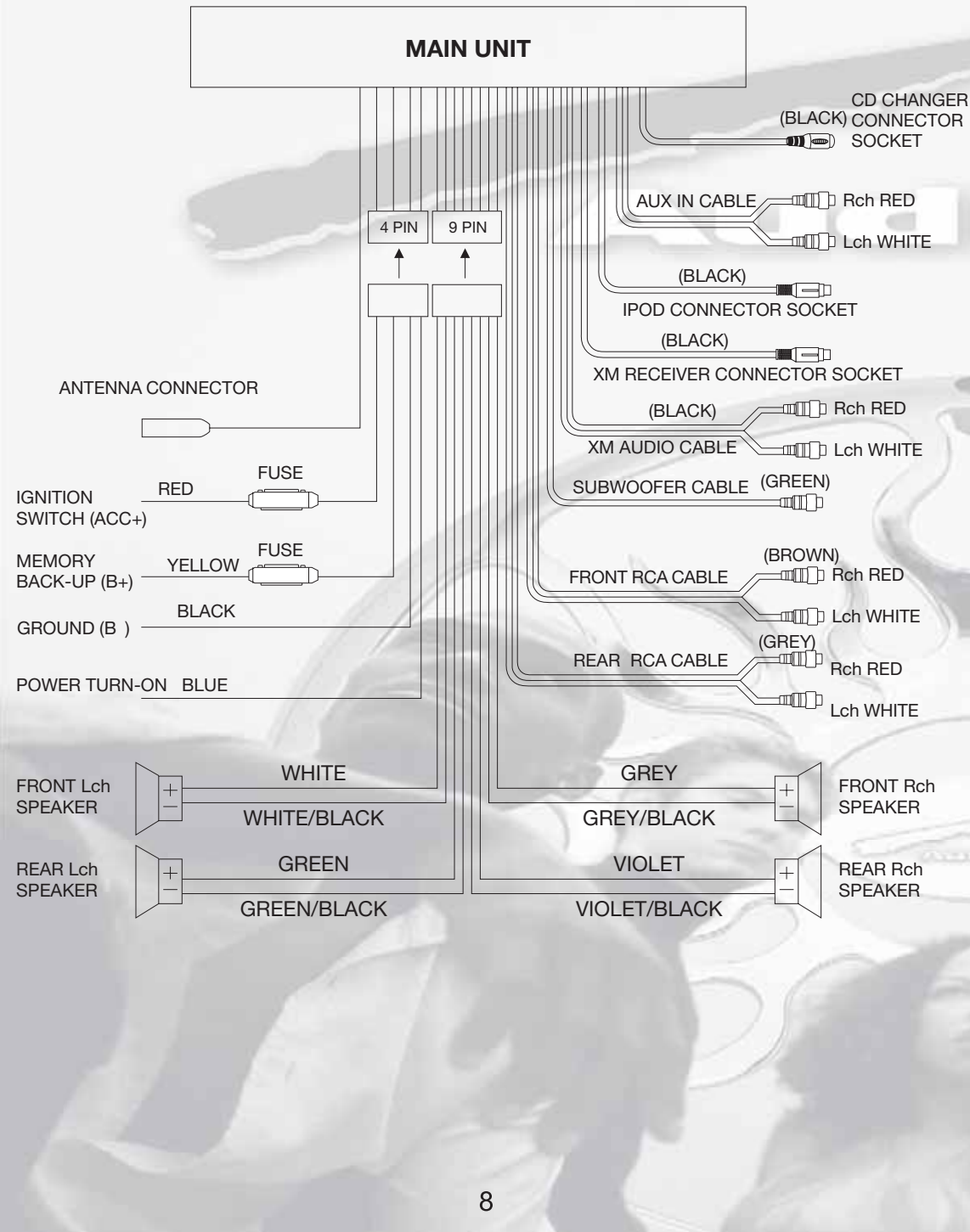

LOCATION OF KEYS

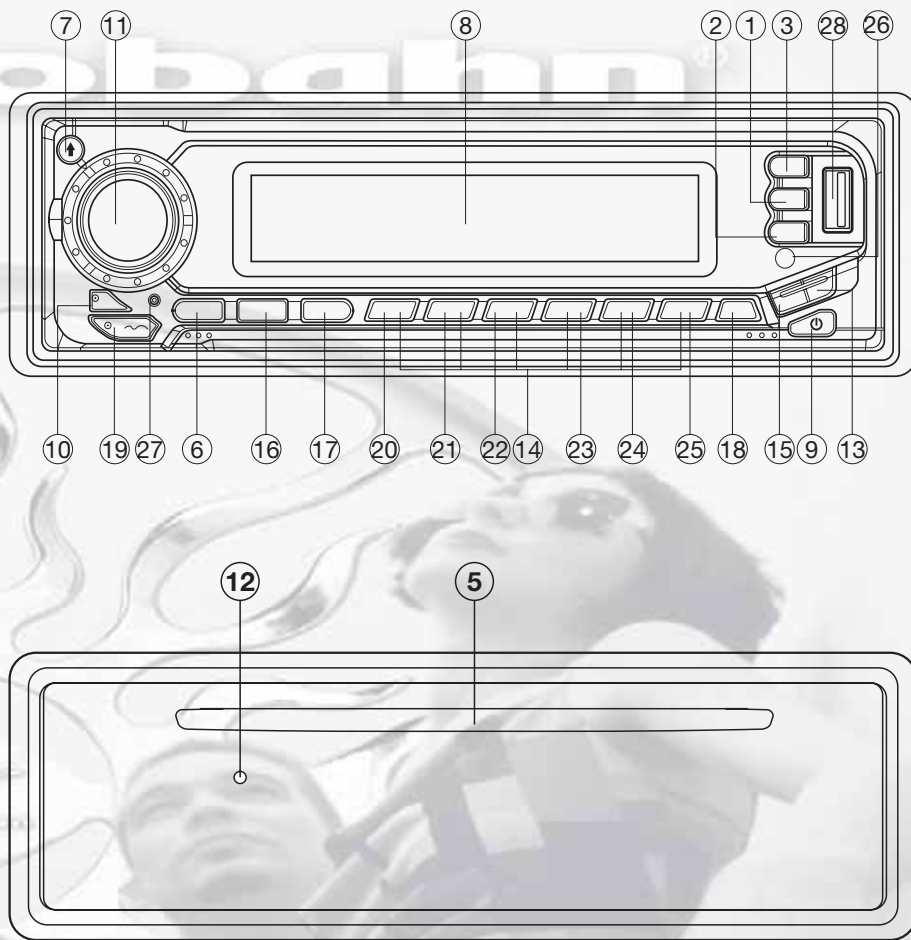

SWITCHING ON/OFF THE UNIT

Switch on the unit by pressing any button (except **OPEN** button (7) and **▲** button (4)). When system is on, press **⏻ PWR** button (9) to turn off the unit.

FACEPLATE RELEASE

Press **OPEN** button (7) to detach the removable faceplate.

SOUND ADJUSTMENT

Press **SEL** button (10) to select the desired adjustment mode.

The adjustment mode will change in the following order:

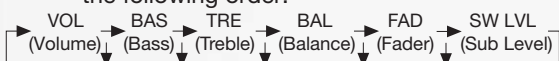

By rotating the **VOL** knob (11) clockwise or counter-clockwise, it is possible to adjust the desired sound quality. Press and hold the **SEL** button (10) for several seconds to enter into the selection for the situation of beep sound, then rotate the **VOL** knob (11) clockwise or counter-clockwise to select as follows:

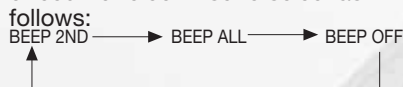

- BEEP 2ND mode:

The beep is only generated when all allowed double function button is pressed long (several seconds). e.g.

When preset button is pressed.

When **BND/LOU** button (13) is pressed.

When **AS/PS/D-AUD** button (18) is pressed.

- BEEP ALL mode:

The beep is generated when every button is pressed.

- BEEP OFF mode:

The beep is disabled.

LOUDNESS

Press **BND/LOU** button (13) for several seconds to reinforce the bass output. Press it for several seconds again to release this function.

DISPLAY INFORMATION

When pressed quickly, the **DSP** button (15) changes the display as follows.

- In AM/FM mode:

-> Frequency ->CLOCK ->

- In XM mode:

-> Channel Name -> Category Name

-> Artist Name -> Song Title ->

CLOCK ->

- In CD mode:

-> CD ->CLOCK ->

- In CDC (or AUX) mode:

-> CDC (or AUX) ->CLOCK ->

Each displaying time is 5 seconds,

the display will return to the first position after 5 seconds.

SET THE CLOCK

Press the **DSP** button (15) shortly until the clock is shown on the display. Then hold down **DSP** button until the clock flashes. Then press the **TUNE/TRACK** **▶▶+** button (17) to change hours or **TUNE/TRACK** **◀◀-** button (16) to change minutes.

MUTE

Press **MUT** button (3) to mute down the sound instantly. If any button is pressed in the mute state, the mute state is released.

EQUALIZATION

Press **P-EQ** button (19) to turn on equalization function and to select desired audio mode. There are five kinds of mode as below:

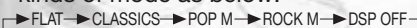

LIQUID CRYSTAL DISPLAY

Exhibit current frequency and activated functions on the display (8).

REMOTE SENSOR

Point the remote control handset to the remote sensor **IR** (26). Press the function keys on the handset to control the system.

FLASHING LED

If the front panel does not install in the main unit, the **LED** (12) will be flashing.

ESP FUNCTION

If the unit has the electronic shockproof function, it can be shockproof about several ten of seconds.

RESET FUNCTION

RESET button (27) must be activated with either a ball point pen or thin metal object.

The **RESET** button is to be activated for the following reasons:

- Initial installation of the unit when all wiring is completed.
- All the function buttons do not operate.
- Error symbol on the display.

Note: If press **RESET** button (27), the unit can't work yet, please use a cotton swab soaked in isopropyl alcohol to clean the socket on the back of the front panel.

RADIO OPERATION

SWITCHING TO RADIO MODE

Press **MOD** button (6) shortly to select radio mode, the radio mode appears in the display together with the memory band and frequency.

SELECTING THE FREQUENCY BAND

At radio mode, press **BND/LOU** button (13) shortly to select the desired band. The reception band will change in the following order:

→ FM1 → FM2 → FM3 → AM

SELECTING STATION

Press **TUNE/TRACK** **▶▶+** button (17) or **TUNE/TRACK** **◀◀-** button (16) shortly to activate automatic seek function. Press for several seconds until **"MANUAL"** appears on the display, the manual tuning mode is selected. If both buttons have not been pressed for several seconds, they will return to seek tuning mode and **"AUTO"** appears on the display.

LOCAL/DISTANT

Press **LOC** button (2) to select between local and distant stations. Local setting for reception of strong station, and a distant setting for reception of weaker stations. This function is effect during AUTO SEEK operation.

AUTOMATIC MEMORY STORING & PROGRAM SCANNING

- Automatic Memory Storing
Press **AS/PS/D-AUD** button (18) for several seconds, the radio searches from the current frequency and checks the signal strength until one cycle search is finished. And then 6 strongest stations are stored into the corresponding preset number button.
- Program Scanning
Press **AS/PS/D-AUD** button (18) shortly to scan preset station. When the field strength level is more than the threshold level of stop level, the radio is holding at that preset number for several seconds with releasing mute, then searches again.

STATION STORING

Press any one of the preset buttons (14) (1 to 6) to select a station which had been stored in the memory. Press this button for several seconds (until 2ND beeps come out), current station is stored into the number button.

MONO/STEREO

Press **MON** button (1) to select mono or stereo mode. You can sometimes improve reception of distant stations by selection mono operation.

ESP FUNCTION

This unit has built-in electronic shockproof protection, it can be shockproof about several 30 seconds.

XM OPERATION

SWITCHING TO XM MODE

Press **MOD** button (6) shortly to select XM mode.

SELECTING USER-PRESET CHANNEL

At XM mode, the XM user-preset channel group (3 channels) is toggled cyclically through the group by quickly pressing the **BND/LOU** button (13). The channel will change in the following order:

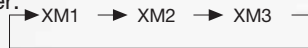

SELECTING CHANNEL UP/DOWN

Press the **TUNE/TRACK ►►+** button (17) or **TUNE/TRACK ◄◄-** button (16) to select the channel up or down.

SEARCHING CHANNEL

When the **AS/PS** button (18) is pressed, the channel searches for each user preset channel from XM1 to XM2 to XM3.

When an available channel is detected, the channel will be held at that preset number and play for 5 seconds. After that, it will mute and search for another available channel.

STORING PRESET CHANNELS

The preset buttons (14) can be used to store 6 channels for convenient access to your favorite channels.

- Programming channels
 1. Select the desired channel you want to store in memory.
 2. Press and hold one of the preset buttons (14) for more than 2 seconds until the corresponding preset button number appears. Repeat steps 1. and 2. to program additional channels.
- Quick tuning

Press one of the six preset buttons (14) shortly to select a preset channel directly.

XM MODE SELECTION

Press **LOC/XM-MOD** button (2) to switch Category mode, Direct Tune mode or normal. It is used as the

selection of each:

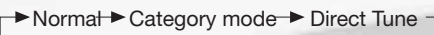

When Category mode is engaged, the "CATEGORY" function is turned on in the display. When Category mode is released, the "CATEGORY" function is turned off. When Direct mode is engaged, "DIRECT" of alphanumeric display is turned on.

Select Category and TUNE UP/DOWN within selected Category

Use **CD/DIR/CAT ▲** button (25) or **CD/DIR/CAT ▼** button (24) to select desire Category and press **BND/LOU** button (13).

In Category mode, channels can be tuned within the same category.

- When the user wishes to search by Category, press **LOC/XM-MOD** button (2) can be pressed until it goes into Category search mode.
- Press M6 button (25) or M5 button (24) up and down to get to the desired category.
- To change channels, press **LOC/XM-MOD** button (2) again to Normal mode, and then press **TUNE/TRACK ►►+** button (17) or **TUNE/TRACK ◄◄-** button (16) to select the channel up or down.

CD OPERATION

SWITCHING TO CD MODE

If there is no CD inserted in the driver: Gently insert the CD with the printed side uppermost into the CD compartment until you feel some resistance. The CD is drawn into the driver automatically. CD playback begins.

If a CD is already inserted in the driver: Keep pressing **MOD** button (6) shortly until the CD mode display appears.

SELECTING TRACKS

Press **TUNE/TRACK** **▶▶+** button (16) or **TUNE/TRACK** **◀◀-** button (17) to move to the previous track or the following track. Track number shows on display.

Hold **TUNE/TRACK** **▶▶+** button (16) or **TUNE/TRACK** **◀◀-** button (17) to fast reverse or fast forward. CD play starts from when you release the button.

PAUSING PLAYING

Press **PAU** button (20) to pause CD player. Press it again to resume play.

PREVIEWING ALL TRACKS

Press **SCN** button (21) to play first several seconds of each track on the current disc. Press again to stop intro and listen to track.

REPEATING THE SAME TRACK

Press **RPT** button (22) to continuously repeat the same track. Press it again to stop repeat.

PLAYING ALL TRACKS IN RANDOM

Press **SHF** button (23) to play all tracks on CD in random order. Press again to cancel the function.

EJECTING A DISC

Method (A):

When a disc is inserted into the disc slot (5) and playing, shortly press **OPEN** button (7) to slide down the front panel, then press and hold **OPEN** button (7) for several seconds and let go and the it will stop the unit playing the CD

and eject the disc from the disc slot, shortly press **OPEN** button (7) again will close the front panel.

Method (B):

When a disc is inserted into the disc slot (5) and playing, press and hold **OPEN** button (7) for several seconds and let go to slide down the front panel and eject the disc from the disc slot, then shortly press **OPEN** button (7) will close the front panel.

CDC OPERATION

You can connect a CD changer to the unit with CDC operation version only.

Information on handing CDs, inserting CDs and operating the CD changer can be found in the operating instructions supplied with your CD changer.

SWITCHING TO CDC MODE

Keep pressing **MOD** button (6) shortly until the CDC mode display appears. Playback begins with the first CD that the CD changer detects.

SELECTING TRACKS

Press **TUNE/TRACK** **◀◀-** button (16) or **TUNE/TRACK** **▶▶+** button (17) to move to the previous track or the following track. Track number shows on display.

Hold **TUNE/TRACK** **◀◀-** button (16) or **TUNE/TRACK** **▶▶+** button (17) to fast reverse or fast forward. CD play starts from when you release the button.

PAUSING PLAYING

Press **PAU** button (20) to pause CD player. Press it again to resume play.

PREVIEWING ALL TRACKS

Press **SCN** button (21) shortly to play first several seconds of each track on current disc. Press and hold **SCN** button (21) for several seconds to play first several seconds of the first track on each disc in the CD magazine. Press it again to stop intro and listen to track.

REPEATING INDIVIDUAL TRACKS OR WHOLE CDs

Press **RPT** button (22) shortly to continuously repeat the same track. Press and hold **RPT** button (22) for several seconds to continuously repeat all tracks on the current disc. Press it again to stop repeat.

PLAYING ALL TRACKS IN RANDOM

Press **SHF** button (23) shortly to play all tracks on the current disc in random order. Press and hold **SHF** button (23) for several seconds to select a disc in random and play the selected disc in random order. Press it again to cancel the function.

SELECTING DISC

Press **CD** **▼** button (24) to select previous disc and **CD** **▲** button (25) to select next disc.

MP3 OPERATION

SWITCHING TO CD (MP3) MODE

If there is no MP3 disc inserted in the driver:

Gently insert the MP3 disc with the printed side uppermost into the disc slot (5) until you feel some resistance. The MP3 disc is drawn into the driver automatically. The MP3 playback begins.

If a MP3 disc is already inserted in the driver:

Keep pressing **MOD** button (6) shortly until the CD (MP3) mode display appears.

SELECTING TRACKS IN SINGLE STEP

Press **TUNE/TRACK ←** button (16) or **TUNE/TRACK →** button (17) to move to the previous track or the following track. Track number shows on display.

SELECTING DIRECTORY UP/ DOWN

Press **M5** button (24) or **M6** button (25) to select directory downward or upward. If the MP3 disc does not contain any directory, there is no function of pressing **M5** button (24) or **M6** button (25).

PAUSING PLAYING

Press **PAU** button (20) to pause MP3 player. Press it again to resume play.

PREVIEWING ALL TRACKS

Press **SCN** button (21) to play first several seconds of each track on the current disc. Press again to stop intro and listen to track.

REPEATING THE SAME TRACK

Press **RPT** button (22) to continuously repeat the same track. Press it again to stop repeat.

PLAYING ALL TRACKS IN RANDOM

Press **SHF** button (23) to play all tracks on MP3 disc in random order. Press again to cancel the function.

SELECTING TRACKS BY AS/PS/D-AUD BUTTON

AS/PS button is assigned as Digital Audio Mode selection button in MP3 operation.

When pressed, it is activated as selecting each mode of Digital Audio. "Searching track directly" => "Searching Directory or File Name" => "Navigation" from root by **TUNE/TRACK UP/DOWN** buttons => "Navigation" from current directory by **TUNE/TRACK UP/DOWN** buttons.

Searching Track Directly

Press **AS/PS (D-AUD)** button for one time. It enters into "Searching track directly" in Digital Audio CD.

The unit searches the track selected by following direct numeric buttons:

M1-M6, MOD (7), TUNE/TRACK DOWN (8), TUNE/TRACK UP (9), DSP(0).

If selected three digits, the unit searches the track at once. If selected one or two digits, the unit wait for **ENT (BND/LOU)** button for seconds. The unit searches the track after few seconds, even if the enter button is not pressed.

Searching Directory or File Name

Press **AS/PS (D-AUD)** button for two times. It enters into "Searching Directory or File Name" in Digital Audio CD.

The unit searches files and directories that have the same character which is inputted by the user pressing the corresponding buttons listed on the Table 1 below.

Explain as follows:

- Use the corresponding buttons to select the characters A to Z, blank, 0 to 9, _, -, +.
- Press **SEL** button to confirm entry of each characters.
- Press **BND/LOU (ENT)** button to start the title search.

In case the selected title is a directory name, display will show (' '), then

- Use the **TUNE/TRACK UP/DOWN** buttons to list all songs under this

directory and select the title.

- Press **BND/LOU (ENT)** button to confirm and start the play.
- Repeat the above steps if the newly selected title is again a directory.

Searching From Root Directory

Press **AS/PS (D-AUD)** button for three times. The unit searches file or directory from root by **TUNE/TRACK UP/DOWN** buttons. (D-DIR icon turns on if the name is directory). Display will list all available directories and songs. Select the desired directory/songs by using **TUNE/TRACK UP/DOWN** buttons and **BND/LOU (ENT)** button to confirm. If the selected title is a song, it starts to play.

If the selected title is a directory name, display will show (' '), then

- Use the **TUNE/TRACK UP/DOWN** buttons to list all songs under this directory and select the title.
- Press **BND/LOU (ENT)** button to confirm and start the play.
- Repeat the above steps if the newly selected title is again a directory.

Searching From Current Directory

Press **AS/PS (D-AUD)** button for four times. The unit searches file or directory from current directory by **TUNE/TRACK UP/DOWN** buttons. (D-DIR icon turns on if the name is directory). The current directory name is displayed for a second and the currently playing file name is displayed (selected). The user can select the directory or file in the directory by **TUNE/TRACK UP/DOWN** buttons. The selected file can be played by pressing **BND/LOU (ENT)** button.

DISPLAY INFORMATION

Press **DSP** button to show following information, such as the clock, ID3 TAG (if available: song title, directory name, artist name, other contents) and other information.

KEY Assigned IN Searching mode (Table 1)

AS/PS	Mode Select
BND/LOU	ENTER
M1	A, B, C, 1
M2	D, E, F, 2
M3	G, H, I, 3
M4	J, K, L, 4
M5	M, N, O, 5/ Directory DOWN
M6	P, Q, R, 6/ Directory UP
MOD	S, T, U, 7
TUNE/TRACK DOWN	V, W, X, 8
TUNE/TRACK UP	Y, Z, SPACE, 9
SEL	CHARACTER SHIFT RIGHT
DSP	←, →, +, 0
AUDIO KNOB	CHARACTER SELECT (A, B - 8, 9, 0)

AUDIO KNOB (ENCODER) & TUNE / TRACK UP / DOWN buttons:

Searching file and directory during Navigation.

WMA OPERATION

The unit that can play the WMA disc and the operation is the same with MP3 operation described above.

USB PLAY OPERATION

In the front panel of the unit, there is an USB interface (28). You can connect an USB driver through this interface (28). For the unit with no SD/MMC interface, when you connect an USB driver through the interface, the unit will search the MP3 files or WMA files in the USB driver and start to play MP3 files or WMA files automatically. If in other mode, you can also press **MOD** button to select USB mode.

When playing the MP3 files or WMA files in the device, the operation is the same with the MP3 operation described above.

Note:

- The main unit can only support the standard USB-memory disc driver.
- USB MP3 player is not a standard which means different brand name or different models have their own standard. So our product cannot support every MP3 player.
- When connecting an MP3 player and there has normal battery in the player(non rechargeable battery), you should remove the battery from the MP3 player then connect it to the USB interface. Otherwise, it may cause battery burst.
- When in USB play mode, be sure not to remove the USB driver from the USB interface.

CAUTION:

When there are important files in the USB device, do not connect it to the main unit to play. And don't play the CD-R/RW disc that has important files in it. Because any wrong operation may cause files loss. And our company assumes no responsibility for this.

RECORD OPERATION

This unit provides record function. In radio, CDP mode, CD Changer, AUX or IPOD mode, press **P-EQ (REC)** button (19) shortly to activate RECORD mode. The unit will record files to USB and the format of the files is “.WMA”. The unit can find and play the record files in the device that connected to the unit through the USB interface. There will be shown “file name” during recording.

Press **P-EQ (REC)** button (19) shortly again to complete recording.

Notes:

- During recording, be sure not to remove the external device from the USB interface or turn off the power or switch off the ACC wire. Otherwise, it may destroy the record files and the USB interface may cause a malfunction.
- During recording in one mode, be sure not to switch to another mode (such as radio, CD, CDC or AUX mode). You

must press **P-EQ (REC)** button (19) shortly to complete recording, then you can change the current mode.

- When playing MP3/MWA disc in CDP the unit cannot record files to USB.

AUDIO DSP (MP3/WMA DECODER)

The following standards and bit rate are supported.

Standard	Bit Rate (kbps)	Supported Mode
MPEG1 Audio LAYER3 (44.1kHz)	32,48,64,96, 128,192,256,3, 20	STEREO
Windows Media Audio (44.1kHz)	64,96,128, 192,	STEREO

Our USB solution can supports:

1. Folder: 1024 max
2. File : 4096 max
3. Depth of folder: 8 layers
4. Size : 1GB

MIXED-CD OPERATION

If available, the unit can play the mixed-CD disc (the disc contains both CD audio tracks and MP3 files).

When you insert a mixed-CD disc into the CD slot, it starts to play the CD audio tracks. And the operation is the same with the CD operation described as above.

If you want to switch to play CD audio tracks, repeatedly, when it jumps to the end (i.e. when it selects the first directory or the last directory), and then press **M5** button (24) or **M6** button (25) again, it will start to play the CD tracks again.

In this way, you can switch between playing CD audio tracks or MP3 songs repeatedly.

IPOD OPERATION

After connect IPOD to the unit, the unit will play the IPOD automatically, and the “IPOD” will appear on the display.

• **Select Category**

When IPOD is playing, Press **BND** button (13) the category will appear on the display, by rotating the **VOL** button (11) clockwise or counterclockwise to change the category among PLYLIST / ARTIST / ALBUM / GENER / SONG / COMPOSER, then press **SEL** button (10) to confirm the selected category.

• Select Song

Press **DSP** button (15), the display will show the current song title (stored in the IPOD). By rotating the **VOL** button (11) clockwise or counterclockwise to change the song title to the next song or the previous song. Then press **SEL** (10) button to play the selected song, and the "IPOD" will appear on the display.

• DSP

When playing song and display IPOD, press **DSP** button (15) will show the Song's D5s information as follow: **Song Title / Artist Name / Album Name / play Time / Clock / IPOD 'C9**

PAU

When playing song, press **PAU** button (20) on the front panel will pause the playing. Press it again will resume playing.

RPT

When playing song, press **RPT** button (22) shortly will repeat the current song, and "RPT SONG" will appear on the display. Press it for about 2 seconds will repeat Album, and "RPT ALBM" will appear on the display. In the Song or Album repeat mode, press **RPT** button again, will stop repeat, and "RPT OFF" will appear on the display.

• SHF

When playing song, press **SHF** button (23) shortly, after the current song play to the end, will play the songs in current category in random order, and "SONG RDM" will appear on the display. Press it for about 2 seconds will play all songs in the album and "ALBM RDM" will appear on the display. In the Song or Album shuffle mode, press **SHF** button again, will stop shuffle, and "RDM OFF" will appear on the display.

NOTE: You can set the repeat mode and shuffle mode in the IPOD, if you select the mode is off in the IPOD, **RPT** button and **SHF** button on the player's D5s panel will be invalidation.

TURE/TRACK UP/DOWN

When playing the song, press **TURE/TRACK Up** button (17) will play the next track in the current category, but you can not enter to the next category.

When playing the song more than 1 seconds, press **TURE/TRACK Down** button (16) will play the song from the start position.

When playing the song less than 1 seconds, press **TURE/TRACK Down** button (16) will play the previous track.

When playing the song, press and hold **TURE/TRACK Up/Down** buttons (17/16) for more than 2 seconds will fast forward/reverse of the playing song. And the display will show the playing time (e.g. 0'00). (Note: Press **TURE/TRACK Up/Down** buttons cannot enter into the next/previous song.)

DISC NOTE

A. Notes on discs:

1. Attempting to use non-standard shape discs (e.g. square, start, heart) may damage the unit. Be sure to use round shape CD discs only for this unit.
2. Do not stick paper or tape etc., onto the label side or the recording side of any discs, as it may cause a malfunction.
3. Dirt, dust, scratches and warping discs will cause misoperation.

B. Notes on CD-Rs (recordable CDs)/CD-RWs (rewritable CDs):

1. Be sure to use discs with following marks only for the unit to play:



2. The unit cannot play a CD-R and CD-RW that is not finalized. (Please refer to the manual of your CD-R/CD-RW recorder or CD-R/CD-RW software for more information on finalization process).
3. Depending on the recording status, conditions of the disc and the equipment used for the recording, some CD-Rs/CD-RWs may not be played on this unit. (See *1)

*1: To have more reliable play back, please see following recommendations:

- a. Use CD-RWs with speed 1x to 4x and write with speed 1x to 2x.
- b. Use CD-Rs with speed 1x to 8x and write with speed 1x to 2x.
- c. Do not play a CD-RW which has been written for more than 5 times.

C. Notes on MP3 files :

1. The disc must be in the ISO9660 level 1 or level 2 format, or Joliet or Romeo in the expansion format.
2. When naming a MP3 file, be sure the file name extension is ".MP3".
3. For a non-MP3 file, even though the file name extension is ".MP3", the unit cannot recognize it.

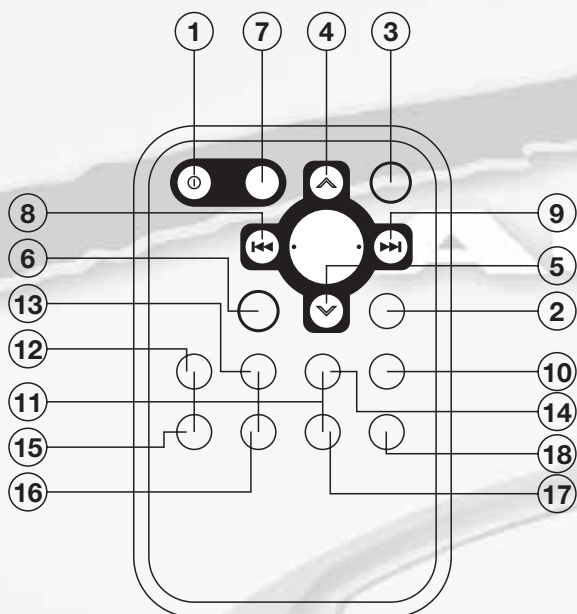

FUNCTION KEYS & CONTROL

- 1. PWR = Power ON/OFF Button
- 2. DSP (0) = Display Button (., , +, 0 For MP3/WMA Operation)
- 3. SEL = Sound Mode Select Button (Character Shift Right For MP3/WMA Operation)
- 4. VOL = Volume Up Button [Character Select (A, B ~ 8, 9, 0) For MP3/WMA Operation]
- 5. VOL = Volume Down Button [Character Select (A, B ~ 8, 9, 0) For MP3/WMA Operation]
- 6. BND (LOU/ENT) = Band Select Button (When pressed shortly)
Loudness Button (When pressed long)
(Enter Button For MP3/WMA Operation)
- 7. MOD (7) = Mode Button (S, T, U, 7 For MP3/WMA Operation)
- 8. TUNE/SEEK (8) = Tune/Skip Down Button; Select Channel Down in XM Mode
(V, W, X, 8 For MP3/WMA Operation)
- 9. TUNE/SEEK (9) = Tune/Skip Up Button; Select Channel Up in XM Mode (Y, Z, SPACE, 9 For MP3/WMA Operation)
- 10. AS/PS (D-AUD) = Automatic Memory Storing & Program Scanning Button
(Mode Select Button For MP3/WMA Operation)
- 11. M1 - M6 = Preset Buttons (A~R, 1~6 For MP3/WMA Operation)
- 12. PAU = Pause Button (A, B, C, 1 For MP3/WMA Operation)
- 13. SCN = Scanning Button (D, E, F, 2 For MP3/WMA Operation)
- 14. RPT = Repeat Button (G, H, I, 3 For MP3/WMA Operation)
- 15. SHF = Shuffle Button (J, K, L, 4 For MP3/WMA Operation)
- 16. DISC-/CAT = CD Down Button (For CD Changer Version Only);
Select Category Down in XM Mode;
M, N, O, 5/DIRECTORY DOWN (For MP3/WMA Operation)
- 17. DISC+/CAT = CD Up Button (For CD Changer Version Only);
Select Category Up in XM Mode;
P, Q, R, 6/DIRECTORY UP (For MP3/WMA Operation)
- 18. LOC (XM-MOD) = Local/Distant Select Button; XM Mode Select Button

GENERAL

Power Supply Requirements	: DC 12 Volts, Negative Ground
Chassis Dimensions	: 178 (W) x 160 (D) x 50 (H)
Tone Controls	
- Bass (at 100 Hz)	: ± 10 dB
- Treble (at 10 KHz)	: ± 10 dB
Maximum Output Power	: 4x45 watts
Pre-Out (RCA) Signal Voltage	: 4V
Current Drain	: 15 Ampere (max.)

Pre-Out (RCA) Signal Voltage:

CD PLAYER

Signal to Noise Ratio	: More than 55 dB
Channel Separation	: More than 45 dB
Frequency Response	: 40 Hz - 18 KHz

RADIO

	FM
Frequency Coverage	: 87.5 to 107.9 MHz
IF	: 10.7 MHz
Sensitivity (S/N = 30 dB)	: 4 μ V
Stereo Separation	: > 25 dB

	AM
Frequency Coverage	: 530 to 1710 KHz
IF	: 450 KHz
Sensitivity (S/N = 20 dB)	: 36 dBu

Before going through the checklist, check wiring connection. If any of the problems persist after checklist has been made, consult your nearest service dealer.

Symptom	Cause	Solution
No power.	The car ignition switch is not on.	If the power supply is connected to the car accessory circuits, but the engine is not moving, switch the ignition key to "ACC".
	The fuse is blown.	Replace the fuse.
Disc cannot be loaded or ejected.	Presence of CD disc inside the player.	Remove the disc in the player, then put a new one.
	Inserting the disc in reverse direction.	Insert the compact disc with the label facing upward.
	Compact disc is extremely dirty or defective disc.	Clean the disc or try to play a new one.
	Temperature inside the car is too high.	Cool off or until the ambient temperature return to normal.
	Condensation.	Leave the player off for an hour or so, then try again.
No sound.	Volume is in minimum.	Adjust volume to a desired level.
	Wiring is not properly connected.	Check wiring connection.
Sound skips.	The installation angle is more than 30 degrees.	Adjust the installation angle less than 30 degrees.
	The disc is extremely dirty or defective disc.	Clean the compact disc, then try to play a new one.
The operation keys do not work.	The built-in microcomputer is not operating properly due to noise.	Press the RESET button. Front panel is not properly fixed into its place.
The radio does not work. The radio station automatic selection does not work.	The antenna cable is not connected.	Insert the antenna cable firmly.
	The signals are too weak.	Select a station manually.

WARNING

Investigate the layout of your automobile thoroughly before drilling or cutting any holes. Take care when you work near the gas tanks, gas lines, hydraulic lines, and electrical wiring. Attach the system securely to the automobile to prevent damage, particularly in the event of an accident. Do not mount the system so that the wire connections are unprotected or are subject to pinching or damage from nearby objects.

The +12V DC power wire must be fused at the battery positive terminal connection. Before making or breaking power connections at the system power terminals, disconnect the +12V wire at the battery end. Confirm your radio/head unit and/or other equipment is turned off while connecting the input jacks and speaker terminals. If you need to replace the power fuse, replace it only with a fuse identical to that supplied with the system. Using a fuse of different type or rating may result in damage to this system which is not covered by the warranty.

Disclaimer

Specifications are subject to change without notice.
For the most updated Specifications call Audiobahn,
your local Authorized Audiobahn Dealer,
or check the Audiobahn website.
tech@audiobahn.com

Audiobahn Consumer Product Warranty Policy

Audiobahn products are manufactured with the highest quality components and some of the most advanced technology available. Because of this, we recommend that you have your new products installed by an **Authorized Audiobahn Dealer**. (A list of **Authorized Audiobahn Dealers** can be found on our web page).

Warranty Period: One year from the original date of purchase.

Warranty Coverage: This warranty covers manufacturer defects only. The warranty is applicable to the original purchaser, and is non-transferable. You must have a receipt from an **Authorized Audiobahn Dealer** that shows the location of purchase, price paid, and date of purchase.

(Products purchased by consumers from an **Authorized Audiobahn Dealer** outside the United States, are covered only by that countries Distributor and not by **Audiobahn**).

Notes:

Complete subwoofer enclosures (**Audiobahn** will replace defective subwoofers, plexiglass, or neon only. Do not send the entire enclosure, unless the enclosure is defective itself. You must receive prior authorization and an RA# before sending in any complete enclosure).

Audiobahn will only replace L.E.D.(s) found to be defective at the time of purchase.

Audiobahn warranties do not cover the following:

- Any product not purchased from an **Authorized Audiobahn Dealer** (including Internet dealers)
- Damage caused by abuse, misuse, accident, water / flood, or theft (including any cosmetic damage to the body of the product)
- Damage caused by improper installation
- Any cost or expense related to removal or reinstallation
- Any unauthorized services
- Any product that has the serial number removed, altered, or defaced
- Subsequent damage to any other components
- Pinched, cut, or stripped wires
- Any product that is new, and/or found to be in working condition
- L.E.D. indicators on electronics

How to receive warranty service: Contact your local **Authorized Audiobahn Dealer**, or call **Audiobahn** at **(800) 488-8595** between the hours of 9:00 AM and 5:00 PM PST.

If you are having problems with your system, we recommend you check the product carefully and thoroughly to confirm that the product truly has a manufacturer defect; as opposed to abuse, or other components in the system causing the failure. This might include having an **Authorized Audiobahn Dealer** look at the product to confirm the source of the problem. Any product found to have a manufacturer defect will be replaced with a new piece of the same or similar model, or repaired at the discretion of **Audiobahn**. Any product found to have no manufacturer defect will be returned to the sender at their cost.

You must acquire a Return Authorization Number (RA #) prior to returning ANY product to Audiobahn. That Return Authorization Number (RA#) must be prominently and clearly marked on the outside of the shipping carton, or product delivery will be refused (no exceptions will be made).

Please note: All shipping and handling (to and from) charges will be the sole responsibility of the consumer.

Please record and keep your Return Authorization Number (RA#) in the event that further communication is required.

Return Authorization Number (RA#): _____

Date product was sent: _____

Contact Information

Audiobahn Headquarters
114 South Berry St.
Brea, CA 92821
Phone (800)488-8595 Fax. (714)988-0433
Pacific Coast Time : 9am-5pm Mon. - Fri.
tech@audiobahn.com

Free Manuals Download Website

<http://myh66.com>

<http://usermanuals.us>

<http://www.somanuals.com>

<http://www.4manuals.cc>

<http://www.manual-lib.com>

<http://www.404manual.com>

<http://www.luxmanual.com>

<http://aubethermostatmanual.com>

Golf course search by state

<http://golfingnear.com>

Email search by domain

<http://emailbydomain.com>

Auto manuals search

<http://auto.somanuals.com>

TV manuals search

<http://tv.somanuals.com>