

ARCHITECT™

Model 960

Model 961

16 Channel

Power Amplifier

Speaker Optimizer

Professional Installer's
Consciousness Guide

AudioControl®

For Those Who Consider Perfection Possible®

22410 70th Avenue West
Mountlake Terrace, WA 98043 USA
425-775-8461 • Fax 425-778-3166
www.audiocontrol.com

©2004. All rights reserved.

Important Information

Dealer Name _____

Date Installed _____

Serial Number _____

Ethernet MAC Address _____

IP Address Dynamic / Static _____

AudioControl®

CONTENTS

The Architect™ Product Highlights	1
Experienced Installer's Quick Hook-Up Guide	3
A Guided Tour Of The Architect	4
Hooking Up Your System	7
Installation: The Long Version	8
Placement	8
Power	9
Remote Power Control	9
Audio Hook-Up	10
Speaker Hook-Up	13
Equalizing the System	14
Equalization Controls	15
A Short Introduction To Equalizers And Acoustics	16
Audio Analysis Using Pink Noise	17
What's Inside	18
The Truth About Bass and The Programmable Frequency Match Filter	18
Patented Intelligent Power Supply	18
Lightdrive Protection System	19
Using the Ethernet Port	20
Troubleshooting	23
A Brazen Plug For Other AudioControl Products	25
Appendices	
Appendix A	
Bridging The Architect	26
Appendix B	
Using the Ethernet-Based Automation Systems	26
The Warranty	28
Service Information	29
Block Diagram	30
Specifications	31

ARCHITECT™

*Model 960
Model 961*

Installer's Guide

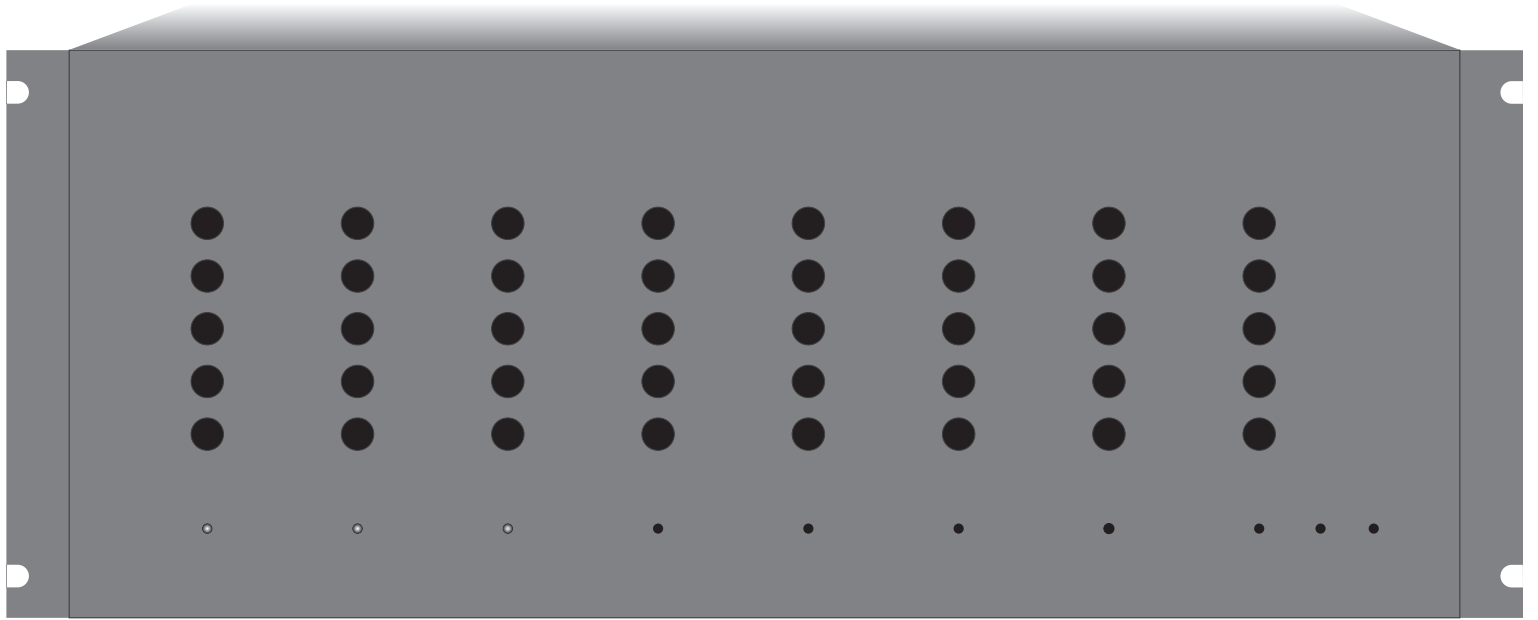

The Architect Model 960, Model 961

Congratulations!

You are now installing a component which can dramatically improve the performance of any distributed audio system, especially those utilizing in-wall speakers. The Architect™ 900 Series is an American-designed and built, “set and forget” component which will provide a lifetime of trouble-free service for your multi-room audio system.

The Architect™ 900 Series is made by the only electronics company in the world that specializes in amplifiers, equalizers, signal processors and audio analyzers. And the company whose professional sound division designed and sells the most popular one-third octave real time analyzer in the world, the SA-3050. AudioControl’s passion for high quality, meticulous attention to detail and pro sound heritage shows itself in the dozens of awards we have won for our designs, products and service. Now, as when we began, our greatest satisfaction is our reputation for sonic excellence and reliability among people just like you throughout the world.

This manual is designed to help you get everything you can out of your new amplifier. So, even though you’re dying to see it in action, please take a few minutes to slog through our not-so-weighty prose and learn how to get the most from The Architect power amplifier. Anything as capable as this amp deserves all the explanation it can get.

ARCHITECT™

*Model 960
Model 961*

Installer’s Guide

Product Highlights

Cool Running - Distributed audio systems can place terrific demands on a home's AC power. Sometimes just a little brownout can cause an amplifier to pull enough current to blow the house circuit breaker. Even when they're running properly, most amplifiers put out enough heat to make any air conditioning system sweat. AudioControl takes care of these problems with our patented (US Patent #5,708,577) power supply regulation and Class-H amplifier design. Both of these features combine to create one of the most reliable and efficient audio amplifiers available. Higher efficiency means a cooler running amplifier. The advanced power supply regulation also minimizes circuit breaker-popping in-rush currents.

Built For The Long Haul – The Architect™ 900 Series has been designed with durability in mind. The *Lightdrive* protection circuitry defends The Architect™ and your speakers against clipping, distortion, damage, and even teenage parties. Even if the party lasts all weekend. Each channel pair is independently protected so a problem in one channel will not affect the rest of the system.

Specially-Designed Equalization Controls – (Model 960 and Model 961) The Architect™ 900 Series is intended to provide a dramatic sound improvement for “small” speakers, such as those with 6-inch and 8-inch woofers. The Architect's 75Hz, 250Hz, 700Hz, 2500Hz and 12KHz band centers were chosen to optimize in-wall and 2-way bookshelf speakers at critical frequencies where adjustment is most advantageous. The bandwidths (or ‘Q’ as our engineering types call it) have also been optimized for the difficulties that in-wall speakers present. This allows The Architect™ 900 Series to improve the sound of these smaller speakers better than any other equalizer.

PFM Subsonic Filter – The Architect's Programmable Frequency Match (PFM) circuitry is a bass-blocking 40 Hz filter which protects small speakers and improves their overall sound. It gives small woofers only those frequencies they can use by “chopping off” bass below 40Hz. The woofer is protected and can do a better job of reproducing mid-bass and higher frequencies.

Ethernet Network Compatible – (Model 961) The power of the Internet is built into the Architect. This internal web server provides remote service diagnostic capabilities and enables the system integrator to control this amplifier via Ethernet.

Made in the Northwest Rainforest – The Architect™ 900 Series began its existence at our factory in Mountlake Terrace, Washington, a few miles north of Seattle. Here, we also build precision test instruments, equalizers, analyzers and a totally awesome line of car stereo components. AudioControl started in 1977 and has won so many audio industry awards for design and engineering excellence that our reception room wall is starting to sag. But enough about us, let's start getting the most from the audio system!

AudioControl®



ARCHITECT™

Model 960
Model 961

Installer's Guide



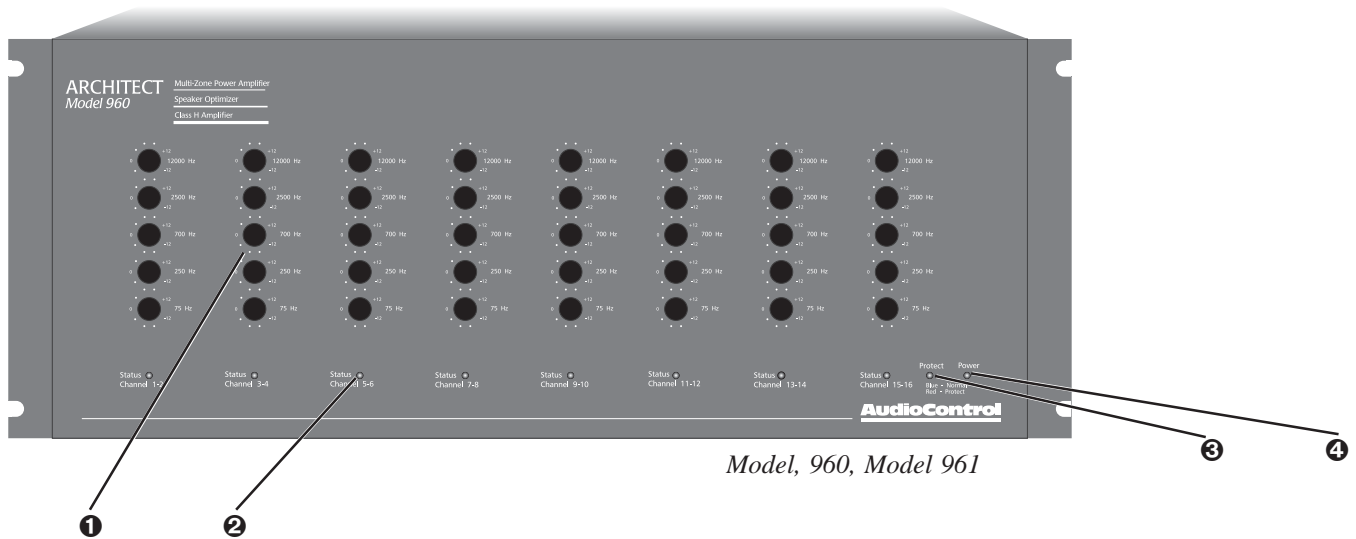

Model, 960, Model 961

Front Panel

- 1 Stereo Speaker Equalization controls** - This array of knobs provide up to 12dB boost or cut at 75Hz, 250Hz, 700Hz, 2500Hz and 12KHz. After initial adjustment the only time you would change the control settings are 1) if you connect different speakers into the system, 2) if (assuming the speakers aren't built-in) you move them significantly, such as from a bookshelf to floor stands, or 3) if your room acoustics change through addition or rearrangement of furniture, wall or floor coverings, large hairy dogs, etc.
- 2 Channel Status LED's** - These dual-color LED's serve two purposes. First they illuminate Blue when the corresponding channel is active. The second function of the status LED is to turn Red if something has caused that zone to go into protection.
- 3 Protection LED** - This LED also has two faces. In normal operation it glows Blue when the remote power trigger is active and the Architect is in stand-by. If the Protection LED turns Red, then one of the internal protection circuits have come into use. All the protection circuits automatically reset themselves when the problem causing the fault has been fixed.
- 4 Power LED** - Nothing too tricky here...when you have the Master Power switch on the back panel turned on and the Architect is plugged into an active AC outlet, this little Blue light will shine forth.

A Guided Tour Of
The Architect[™] 900 Series

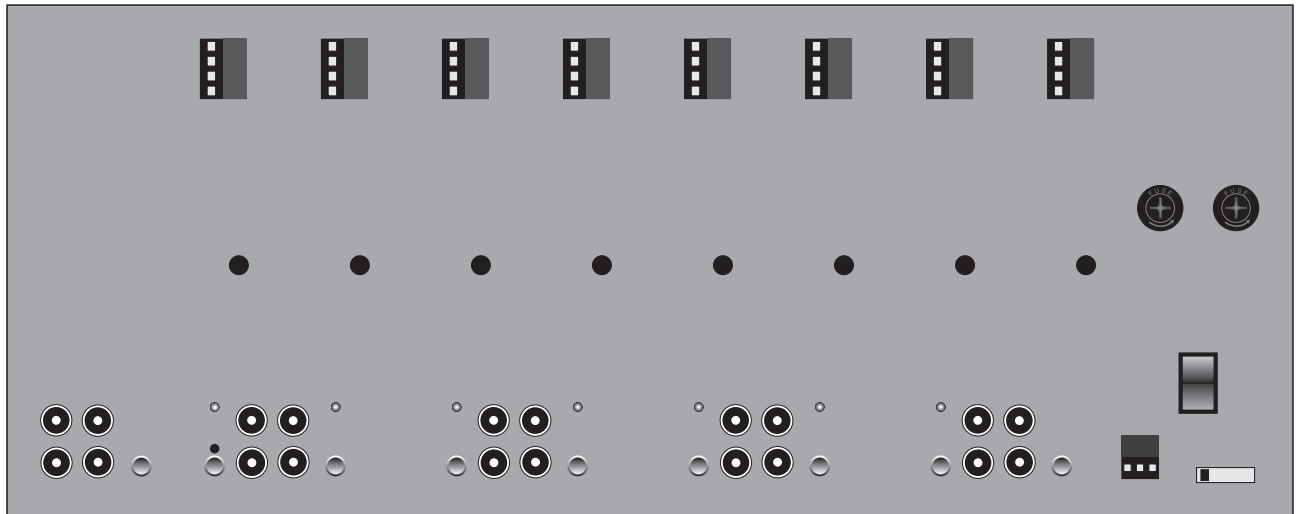

more rear panel features on the next page 

ARCHITECT[™]

*Model 960
Model 961*

Installer's Guide

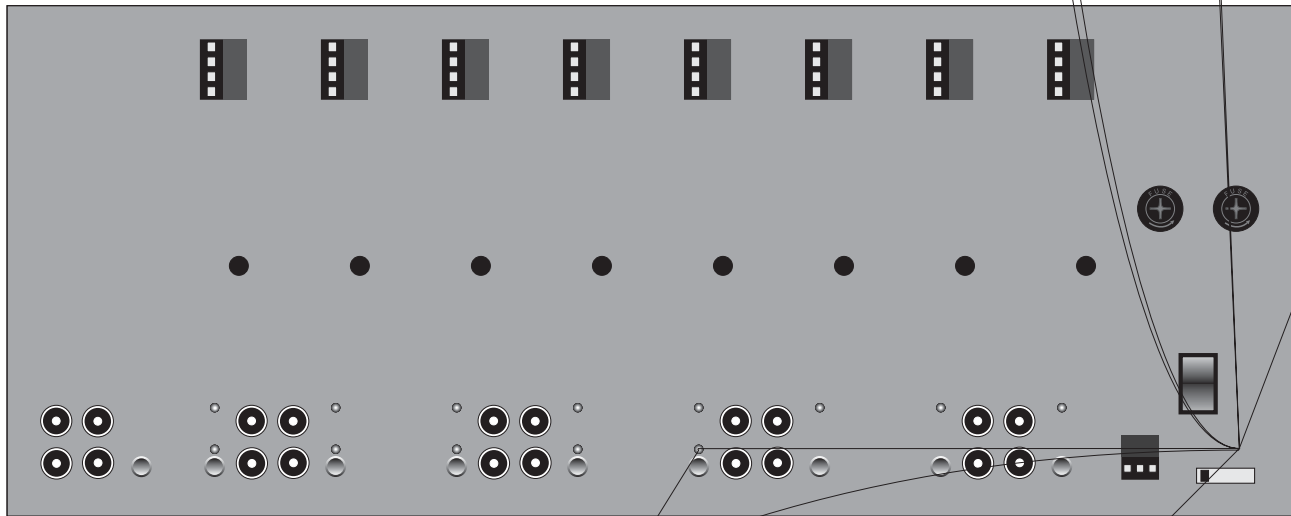

⑨ **PFM Highpass Filter** – This bass blocking filter sets the low frequency cut-off point of the Architect. The PFM filter is 18dB per octave and the frequency is fixed at 40Hz. When this button is Out (defeated) the channel passes full range to the zone.

⑩ **Bus Select Switches** – These two buttons next to each zone's local input jacks selects the input source for that amplifier zone. If both buttons are Out, the zone receives signal from the Local Input. If the Top #1 Bus button is pressed, the zone source is Bus Input #1. When Both Bus #1 and Bus #2 buttons are depressed, the zone source is Input Bus #2. Whenever a Bus Input is selected, the zone input can be remotely triggered to the local input using the 12 volt Local Trigger input (see #6 on previous page).

Local Inputs - These unbalanced RCA inputs connect to your preamplifier's outputs. Any standard line level audio signal can be connected to these inputs.

AC Power Fuses - The Architect is designed with several layers of protection circuitry. These main AC power fuses are here just in case something really awful goes wrong. There are no internal fuses in this amp.

Power Cord The Architect™ draws a maximum of 1600 watts at full power. Make certain that it is plugged directly into the wall outlet or a power strip with sufficient power rating. Since the Architect has remote power switching, you should plug the unit into an AC outlet that is always active.

Master Power Switch - This switch shuts off the main AC power. Normally the only time you need to turn the master power switch off is if the system is going to be shut down for an extended period of time.

Remote Power Control - This three pin connector allows you to remotely turn on the Architect. You can either use a contact closure between the *Trigger In* and the *+12V output* or an external 12 volt trigger between the *Control In* and *Ground* terminals. The +12 volt output is not designed to power other pieces of equipment.

Ground Lift Switch – This switch selects the level of isolation between the audio signal ground and your AC earth ground. In normal operation this switch should be in the *Ground* position, but if you run into trouble with an AC ground hum, try the other two settings for the best operation. For your safety, the chassis is always connected to the earth ground regardless of the switch setting.

Hooking Up Your System

What you'll need:

1. The Architect™ 900 Series Amplifier.
2. RCA audio hook-up cables.
3. Small blade screwdriver for terminal blocks
4. (Optional) A balanced line driver (of course we recommend the AudioControl BLD-10 and BLR-10) if you are going to mount the Architect more than 20 feet from the preamp.
5. Enough speaker wire to reach all of your speakers.
6. Multi-zone audio controller, receiver, or preamplifier.
7. Although you can set the speaker optimization controls by ear, a real-time audio analyzer such as the AudioControl Industrial SA-3052 is very helpful.
8. An RJ-45 10BaseT Ethernet connection cable.
(Optional - Architect Model 961)



SA-3052



BLR-10 and BLD-10 Balanced Audio Drivers send audio over CAT-5. Extends high quality audio up to 1000'.

ARCHITECT™

Model 960
Model 961

Installer's Guide

Installation: The Long Version

Installation: The Long Version

What follows is a step-by-step guide to integrating the Architect into your multi-zone system. If it seems overly detailed, please forgive us. We would rather tell you too much than too little.

First, check your new Architect for any shipping damage. We pack 'em pretty securely, but it's a vicious world out there and anything can happen between us building them here in Mountlake Terrace, Washington and your installation.

PAPERWORK

Yes, filling out the warranty registration card is about as exciting as cleaning out your sock drawer, but we'd definitely like the card back after you've hooked up the Architect and played with it a while. We DO read each and every incoming card and react to your suggestions. That's how great products like this are created.

Next, record the serial number on the sales receipt and make certain the home owner puts it away in a safe place. Stashing the receipt away is very important in the unlikely event that your Architect ever needs servicing, or...well things do happen...you need to prove to an insurance adjuster that something as great as the Architect was installed in the system.

PLACEMENT

The Architect 900 Series is a very efficient amplifier, but it does need some breathing room to operate properly. Make certain that the air vents on the rear and sides of the Architect are not blocked and have at least ½" of air space. Also make certain that heat sensitive components such as CD or Tape players are not directly on top of the Architect. Just as a reminder, you should avoid putting any leaky pipes above the audio equipment stack.

A benefit of having remote power control on the Architect is that you can install it in another area of the house (such as a basement or utility room) away from the main component stack. Make certain that you use a good quality audio line driver to extend the RCA cables if you choose this type of installation.

Installation: The Long Version

POWER

Under normal operating conditions, the Architect 900 Series can draw up to 1600 watts of AC power. Don't plug it into a switched outlet on your system unless you are certain that it can handle the power rating. Also, please don't cut off the ground pin on the power connector. It is an important safety feature. If you need to plug it into a two prong outlet, use a ground adapter (and connect the ground on it). If you have a ground noise problem, try the ground lift switch on the rear panel.

REMOTE POWER CONTROL

The Architect has several means of power control:

1) Main AC Power switch- This is the master control and must be turned ON for the Architect to function. When the main power switch is on, the blue Power LED on the front panel lights up. Normally the only time that you would need to turn the AC power switch off is when the system is going to be unused for an extended period.

2) Remote 12 volt Power Trigger - This removable 3-pin remote connector on the rear panel allows simple interfacing with external control systems. It accepts either a contact closure or external +12 volts DC. (see diagram) The two-color Protection LED on the front panel illuminates Blue to show that the remote power control is active.

3) Ethernet Control - If you have the Architect Model 961 with the Ethernet control port you have remote control over the amplifiers power from almost anywhere in the world via the Internet. This is also very useful on a more local sense for integrating the amplifier with a home automation system via Ethernet.

4) Signal Sensing - Another level of amplifier control is the Signal-Sense circuitry. This provides individual channel muting control. When active, it senses that an audio signal is present on the RCA inputs then enables the power and unmutes that zone. The zone status LEDs on the front panel light up Blue when a signal is present.

In some installations it may be desirable to defeat the signal-sense control and leave all zones active regardless of the audio input. To defeat the signal-sense, press in the Signal-Sense Defeat button on the rear panel



Warning - Always connect the safety earth ground. If you have an AC hum problem, use the ground lift switch



Installation Hint: If your installation doesn't require this remote power turn-on, you **must** put a short piece of wire between the +12 V output and the Trigger In pins.

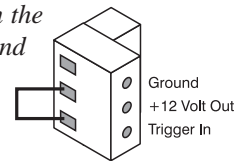

Note: Do not use the 12 volt power trigger if you are using the ethernet control. The power turn on is controlled by the ethernet

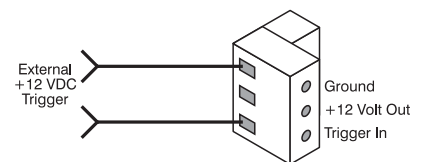

... or

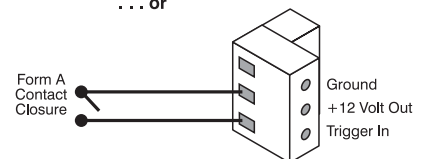

ARCHITECT™

Model 960
Model 961

Installer's Guide

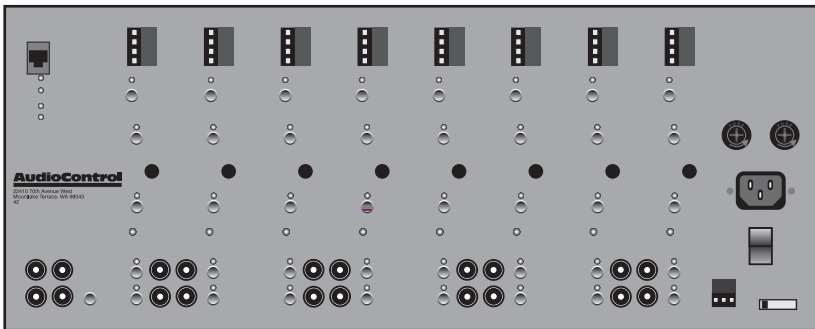

AudioControl®

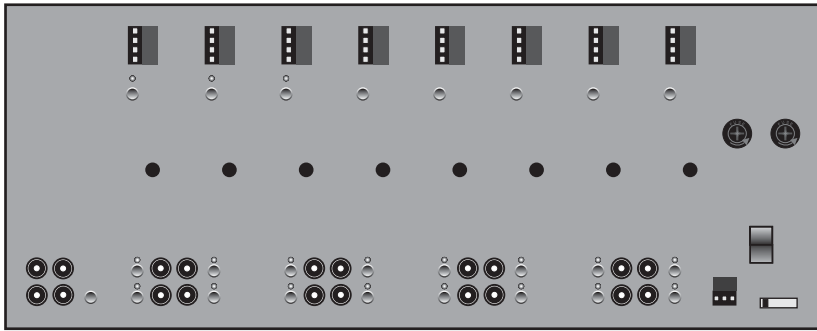

ARCHITECT™

Model 960
Model 961

Installer's Guide



AudioControl®

SPEAKER HOOK-UP

The same rule applies to the speaker wires as the RCA connections. Establish a standard connection color code and stick with it. One conductor of the speaker wire is normally marked by a different color (silver versus copper) or there is a ribbing on one side. Typically this marked conductor is used for the positive (+) speaker leads. Of course the really good wire has Positive and Negative printed right onto the wire jacket.

Your choice of speaker wire gauge and the length of the runs also affects the speaker impedance load presented to the amplifiers. As you can see in this table, even fairly short speaker runs can have significant resistance if you use a smaller wire gauge. This can be a benefit if you are paralleling lots of speakers. The wire itself acts as an impedance limiter, since the amplifier cannot see a speaker load lower than the resistance of the wire. The downside of this resistance in the wire is that you waste some part of the total power available to the speakers.

See the appendix for information about bridging the Architect into mono operation.

Congratulations! You're done with the audio hook up. Now for the details of operation...

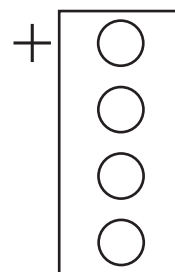

Speaker connection wiring

Speaker Wire Resistance Wire Gauge versus Run Length

	25'	50'	100'	250'	500'
24 GA	1.3 Ω	2.6 Ω	5.1 Ω	12.8 Ω	25.7 Ω
22 GA	0.8 Ω	1.6 Ω	3.24 Ω	8.1 Ω	16.0 Ω
20 GA	0.5 Ω	1.0 Ω	2.0 Ω	5.0 Ω	10.1 Ω
18 GA	0.3 Ω	0.6 Ω	1.28 Ω	3.2 Ω	6.4 Ω
16 GA	0.2 Ω	.4 Ω	0.8 Ω	2.0 Ω	4.0 Ω
14 GA	0.1 Ω	.25 Ω	0.5 Ω	1.26 Ω	2.5 Ω
12 GA	0.08 Ω	.16 Ω	0.32 Ω	0.8 Ω	1.6 Ω

ARCHITECT™

Model 960
Model 961

Installer's Guide

Equalizing the System

 **Note:** For the absolutely best results, The speaker optimizer controls on the Architect[™] Model 960/961 should be adjusted with a real time analyzer such as the AudioControl Industrial SA-3052.

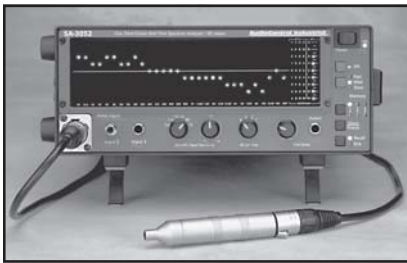

SA-3052

Equalizing the System

Before proceeding on to setting up the Speaker Optimization controls on the Architect, it's a good idea to make sure that you have everything connected and working properly.

1. Double-check all connections. Make certain that all of the audio and speaker connections are firmly seated and tightened down.
2. Turn on your audio system. The Power LED on the Architect should be Blue, the Protection LED should be Blue (after a few seconds of Red on startup) and (unless you have defeated the Signal-Sense) the Channel Status LEDs should be off.
3. Start one of the audio sources playing and send that signal to the Architect (how you do this depends on your particular multi-room system). The zone status LED should illuminate Blue within one second after the music begins.
4. Check each speaker output zone to ensure that each one plays properly.
5. With all the speaker loads turned on, turn up the volume and make certain that the channel status LEDs on the Architect stay Blue. If they slowly toggle between Blue and Red, then there is either a short in the speaker wiring, or the combined speaker load is too low.

Congratulations! You're ready to go on to setting the Speaker Optimization controls.

The following are examples of typical settings of the Architect[™] 900 Series Speaker Optimizer controls. Naturally, the results of adjustments will vary depending on the individual acoustic environment, the type of speakers, and the personal preferences of the listener. These recommendations are not concrete, they are simply good starting points.

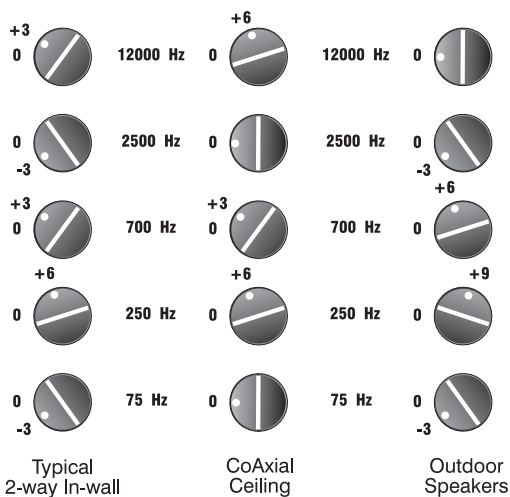

Example Settings

AudioControl®

Equalization Controls

Here is a brief introduction to each of the Speaker Optimization control frequencies and what their affect on your music is.

75 Hz – Bass. This is at the bottom end of the frequencies which typical in-wall and small bookshelf speakers can achieve. Even though the Architect's PFM filter cuts frequencies under 40 Hz, boosting this band more than 6 dB can cause distortion. Adjust this band with care. A mild boost will enhance bass instruments such as bass guitar, kick drum, floor toms, timpani and double bass violas.

250 Hz and 700 Hz — High and low midrange. These controls directly affect the sound of instruments and vocals. These bands also determine the speaker's presence (whether the music sounds far away or close in). Small speakers often produce too much midrange, so these controls are candidates for being turned down slightly during your initial experimentation. Definitely consider reducing 700 Hz if you are only using your extension speakers for background music.

2500 Hz — Treble. Female vocals and the "edge" of instruments such as guitars, snare drums, saxes, violins, etc. are found in this range. If accentuated too much (by boosting this control) sounds in the 2500 Hz range can seem harsh and fatiguing to the ear due to excessive output by the speaker or because of live, reflective room acoustics.

12 KHz — High treble. The fine detail, texture and sheen of music is found here. The breathiness of vocals, the sheen of cymbals, the high overtones of piano and strings. Actually, there's audible music information up to 20,000 Hz on some CD's and most adult's hearing is still pretty good at 15,000 Hz. But we've chosen 12,000 Hz because it provides more useful control to compensate for room acoustics and common small-speaker deficiencies.

ARCHITECT™

*Model 960
Model 961*

Installer's Guide

Introduction To Equalizers And Acoustics

A Short Introduction To Equalizers And Acoustics

Magazine reviewers and audio system owners spend much time critically appraising speakers and other stereo components. Unfortunately, a phenomenon that has a very large effect upon sound is not easily judged or changed. That effect is the ACOUSTICS of the environment in which you are listening.

Room acoustics is a complicated subject about which entire textbooks have been written. We simply want you to be aware of a few basics that have a direct effect on real time audio analysis.

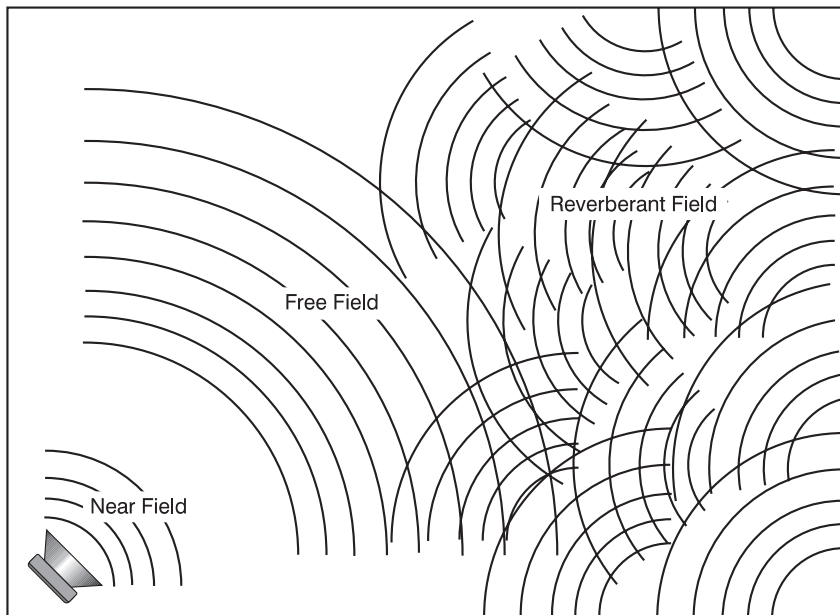

Room interaction

As you probably learned in junior high school, sound travels in waves. In a stereo system, these waves are created by the speakers. Like waves in a pond created by a splash, sound waves emanate from the transducers (speakers) and spread out into the room. If your room were infinitely big, that's all there would be to it. But just as waves in a pond reach the bank and reflect back, sound waves bounce off walls, ceilings, and floors, reflecting, reinforcing and canceling each other as

shown in the figure above. Since sound is energy, the way it reflects depends upon the angle of the surface, the type of material and the frequency of the sound wave. Because your listening position is likely to be towards the back of the Free Field waves shown in the diagram, you also get part of the reflected Reverberant Field as well.

Now we add the next set of complications: Different frequencies of sound have different wave lengths (a function of frequency and the speed of sound). Each frequency's wavelength contributes differently to the Free and Reverberant Fields because they are different sizes. For example, a 32 Hz bass note has a wavelength of 35 FEET, while a 16,000 Hz note has a wavelength just under a tenth of an inch. Tiny treble waves can be caught and neutralized by draperies, carpeting, upholstered furniture and gangs of indolent Persian cats... while gigantic bass waves simply slosh back and forth in the room.

Another set of variables is the shape and volume of your listening room. Large rooms require more bass energy to excite waves within them. Small rooms need less energy, but reflect it differently. And then there's the fact that most rooms don't have four walls anymore, but open into dining rooms, lofts, cathedral ceilings, etc. All of this means that predicting sound interaction patterns is very difficult due to the irregularities of the room shape.

As you can see, room acoustics is an important but complicated subject. To learn more about room acoustics, get a copy of AudioControl's Technical Paper 107, "*Small Room Acoustics De-Mythologized*". You can download this paper from www.audiocontrol.com or if you're still into the printed page, call us and we'll mail you a copy. The overall point that we're trying to make is that the various rooms in your home function as gigantic mechanical equalizers, boosting or cutting certain frequencies depending on size, shape, volume, acoustic treatment and the position of the speakers.

Audio Analysis Using Pink Noise

It may take several series of adjustments since there is some interaction between each control. We have included some sample settings here and general descriptions of each control's function further on page 15 or here.

After initial adjustment the only time you would change the control settings are 1) if you connect different speakers into the system, 2) if (assuming the speakers aren't built-in) you move them significantly, such as from a bookshelf to floor stands, or 3) if your room acoustics change through rearrangement of furniture, wall or floor coverings, large hairy dogs, etc.

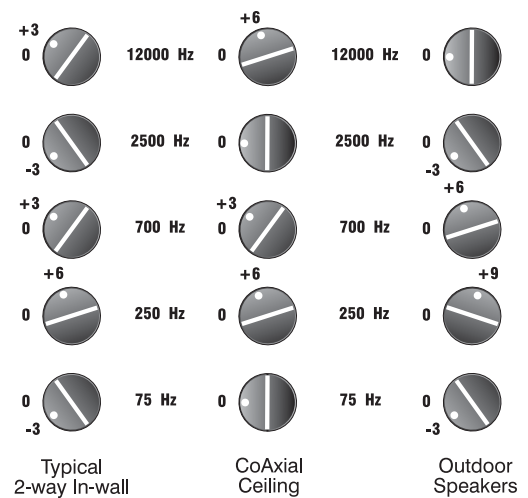

Example Settings

ARCHITECT™

*Model 960
Model 961*

Installer's Guide

What's Inside

THE TRUTH ABOUT BASS AND THE PROGRAMMABLE FREQUENCY MATCH FILTER

Now that digital audio is the favorite musical source, there's more low bass running around in a typical system. Low bass injects large amounts of power into ANY kind of speaker — up to 60% of your amplifier's output is being used to reproduce frequencies under 100Hz. That can really tax an audio system. The second problem is that bass produces heat in the speaker. If more heat is built-up than the speaker can dissipate, the voice coil can literally go into meltdown (or worse).

In addition, ultra-low bass and small speakers don't always get along, ESPECIALLY when you DO have ample power. The low bass music content can cause over-excursion: The speaker cone attempts to travel farther than its physical limits, potentially causing damage (in some cases you can actually hear a clacking sound!). Even before destruction sets in, there are other problems with feeding super-low bass to small speakers. Most bookshelf and in-wall loudspeakers are 2-way systems. That means that the woofer also handles a large part of the critical midrange area. When the woofer is bashing around trying to reproduce unrealistically low bass, its ability to produce midrange is compromised due to intermodulation distortion. So not only don't you get low bass, you get lousy vocal and instrumental reproduction.

Pragmatically, it boils down to this: If you want ultra-low, foundation-shaking bass from an in-wall speaker, you should add a separate subwoofer. A more economic approach is to equalize the speaker for maximum low bass output **WITHIN IT'S PRACTICAL RANGE** and eliminate lower frequencies which either can't be reproduced or which incite excessive cone travel. While it may seem surprising, actually cutting off some of the lowest bass, will make the bass sound cleaner, punchier and even louder.

INTELLIGENT POWER SUPPLY

Typical amplifiers simply waste their excess headroom power as heat. This prematurely wears the electronic components and will substantially increase the ventilation requirements of a typical home audio equipment stack. Our Class H design monitors the audio power requirements and continuously adjusts the Architect for the optimum headroom. The result is much cooler operation and less power draw from the AC wall outlet.

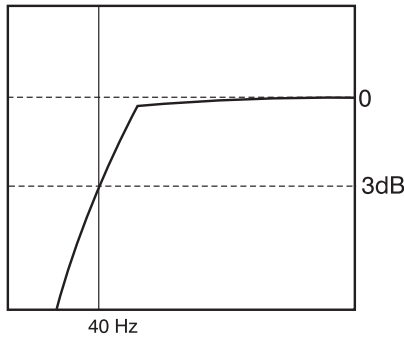

PFM filter frequency response

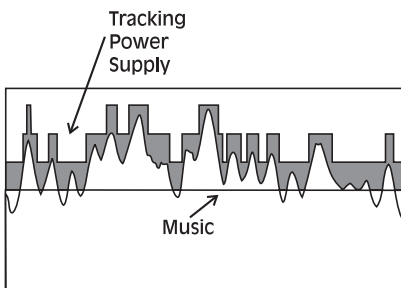

Class H Amplifier

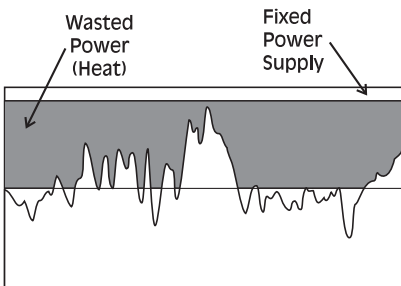

Typical Amplifier

A common problem with amplifiers is their *In-Rush* current. That is the extra power that the amplifier draws from the AC wall outlet when you turn on the amplifier. A single 15 amp household circuit may be fine for running a couple Brand X amplifiers under normal operation, but when they are first turned on, the combined in-rush current draw is usually enough to pop the house circuit breaker. This is a major problem in areas where there are frequent brown-outs or power fluctuations. Our patented (U.S. Patent #5,708,577) power supply design smoothly ramps up the Architect from a cold start. This keeps the in-rush current under control and means you don't have to over rate the AC feed just to keep breakers from blowing during a brownout.

LIGHTDRIVE PROTECTION SYSTEM

This amplifier is not only smart enough to protect itself, the Architect 900 series amplifiers also protects the speakers. When the volume is turned up too high and an amplifier is pushed into clipping; the resulting distortion will probably damage the tweeters in your speakers. AudioControl's exclusive *LightDrive* protection system eliminates the possibility of signal clipping in the Architect, even under the most demanding of conditions.

What is clipping? That's where the speaker output of an amplifier tries to exceed the available voltage of the amplifier's power supply. When that occurs, the amplifier can no longer properly create the audio signal waveform and the audio output becomes sharply squared off. This abrupt cutoff creates ultrasonics and high frequency distortion that is too much for a poor little speaker like a tweeter to handle. LightDrive solves this problem by continuously monitoring the output of the amplifier channels. If a channel begins to get near the limit of the power supply, it immediately begins compressing the audio to reduce the volume level. This happens so quickly that you'll never even hear the LightDrive system kick in...although your speaker will breathe a sigh of relief because it did.

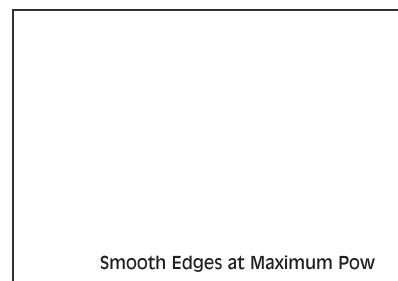

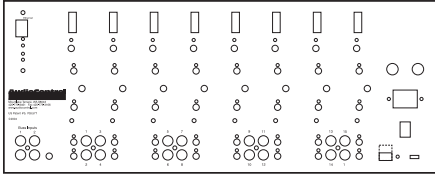

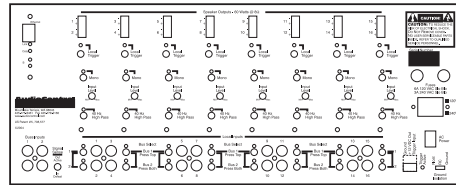

ARCHITECT™

*Model 960
Model 961*

Installer's Guide

Using the Ethernet Port

Dynamic versus Static IP Address – This is pretty basic; a *Dynamic* IP address changes every time you log onto the network, a *Static* IP address always stays the same. A good example of a dynamic IP address is your dial-up Internet access. Your computer gets a different IP address assigned to it every time you dial up. A network installation using Dynamic IP address requires a dedicated device known as a DHCP (Dynamic Host Control Protocol) server to assign the IP addresses from a pool of available addresses as each network device logs on. For an automation system we really recommend using a Static IP address setup. This makes it simple to always know what address to find a particular device, such as the Model 961 amplifier.

Troubleshooting the Architect

Almost all problems can be eliminated by re-checking the wiring and settings of the Architect amplifier. If a problem cannot be solved using the guide below, please call the AudioControl factory for further assistance.

1. No Sound:

- a. Verify the Power LED is Blue.
- b. Verify Protection LED is Blue.
- c. Verify Channel Status LED is Blue.
- d. Verify Source unit is operating.
- e. Check the Speaker Connector plug on the rear panel
- f. Check the AC Power Fuse on the rear panel.

2. Protection LED is Blue, but none of the Channel Status LEDs are on:

- a. Defeat the Signal-Sense circuit using switch on the rear panel. All of the Channel Status LEDs should turn on. If they do not, call the AudioControl factory.
- b. Verify Source unit is operating.
- c. Adjust the preamp volume higher.
- d. Adjust the Input Sensitivity control clockwise.

3. Channel Status LED is Red:

- a. Check speaker leads for short. Swap speaker connectors on rear to see if the problem moves with the wires.
- b. If the Architect is excessively hot (you cannot hold your hand on the top), turn down the volume and allow it to cool off. The Status LED should turn back to Blue after a short while. Verify that the ventilation holes on the rear and sides have not become blocked.
- c. The speaker impedance may be too low.



Install Tip - There are no internal fuses in the 900 Series amplifiers. All protection circuits are self-resetting.



ARCHITECT™

Model 960
Model 961

Installer's Guide

4. Protection LED is Red:

- a. Check main AC fuses - if one blows, the protection activates
- b. Something rather serious has happened inside the Architect. Call the AudioControl factory.

5. Speaker Buzzing or Cracking at high volume:

- a. Reduce the equalizer boost at 75Hz.
- b. Try enabling the PFM filter.

6. There is no audio input signal, but the Channel Status LED is still Blue:

- a. Check the Signal-Sense defeat switch on the rear panel. If it is pressed in, the Channel Status LEDs will stay on as long as the Remote Power Control is enabled.
- b. The Channel Status LEDs stays on for 30-60 seconds (depending on music volume) after the audio signal has stopped to prevent prematurely turning off during quiet passages or disk changes.

A Brazen Plug For Other AudioControl Products

AudioControl started out making graphic equalizers in 1977. Our heritage and design experience grew from a background in professional audio, so we were never quite satisfied with what was available for the consumer audio market. Since that time, we have continued to expand our product offerings to become a key part of great home audio systems. We supply the audio components that can make a more substantial improvement in the sound of your system than almost any other addition or upgrade. More bass, better sound, less harshness and the ability to hear music the way you want it.

We make our equalizers easy to use by incorporating features such as pairing channel controls together. We help you make the system sound as good as possible with high quality subsonic filters and, in selected models, built-in test analyzers that let you make accurate adjustments to instantly compensate for main system speaker and room deficiencies. In fact, AudioControl was the world's first manufacturer of a SEVEN CHANNEL equalizer for home theater surround sound use.

AudioControl also provides a full compliment of components for your home theater needs. The Maestro 7.1 is a THX Ultra 2 certified home theater surround processor with exceptional audio and video performance. The Diva 24 bit digital room correction system provides 8 channels of acoustical control to get the most out of your home theater. The Pantages and Avalon power amplifiers round out this theater system. Their audiophile sound quality, cool running Class-H design and exclusive LightDrive protection systems say these amplifiers mean serious business. Together the

AudioControl home theater system provides ultimate performance for your ultimate home theater.

Okay, enough commercials.

Once again, we thank you for choosing AudioControl components in your system and hope you enjoy a lifetime of performance and reliability.



BLR-10 and BLD-10 Balanced Audio Drivers. Sends over CAT-5 extends high quality audio up to 1000'.

ARCHITECT™

Model 960
Model 961

Installer's Guide

Appendices



Caution - Do not use a speaker rated at less than 8 ohms when bridging. In a bridged system, each channel of the bridged pair “sees” one half of the speaker load. This means that a bridged amp driving an 8 ohm speaker is actually operating into a 4 ohm load.

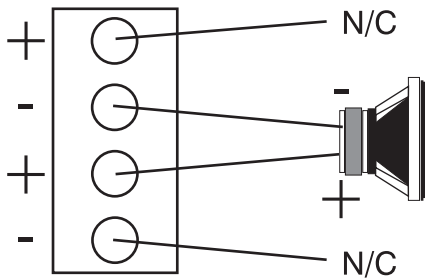

Bridged connection speaker hookup

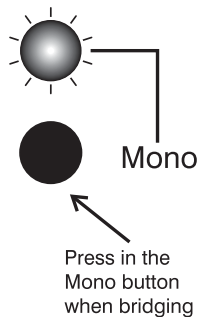

Appendix A BRIDGING THE ARCHITECT

To increase the output power of the Architect, you can join (bridge) two channels of the Architect into a single channel of 230 watts. Accomplishing this is a simple matter. Just press the Mono button to send the same audio signal to both channels of the zone and then connect the speaker terminals as shown in the diagram below.

Appendix B USING WITH ETHERNET-BASED AUTOMATION SYSTEMS

The Ethernet LAN connection on the Model 961 enables remote control of the amplifiers power and channel muting. While the internal web server of the Model 961 provides an HTML web page based interface, this is not the best means of controlling the unit from another computer system. The Architect Model 961 provides a Telnet TCP/IP protocol for system programmers. The Telnet protocol uses simple ASCII text commands to control and monitor the Architect Model 961 amplifier.

To log into the Architect Model 961 via Telnet, you need a Telnet client program in your system. The factory default static IP address of the Model 961 is *192.168.0.1* and telnet is active on port 23. The default user login ID and password are:

User ID: architect (note: all lower case)
Password: 900

An example of a typical telnet login session is:

```
/Telnet> login
/Telnet> UserID?: architect
/Telnet> Password?: 900
/Telnet> User authenticated!
/Telnet>
```

The serial ASCII control protocol over telnet allows simple integration with other automation computer systems. The basic command format is:

command<cr>

Where command is the ASCII text string of the command and <cr> is an ASCII carriage return (0C hex) character as a command delimiter. These commands are case sensitive and have a 500mS timeout if no valid command or delimiter is sent.

The commands are broken into two groups: **Controls** and **Inquiries**. The **Controls** issue instructions to the Model 961 for power control and channel muting; the **Inquires** return the status of amplifier channels, AC line voltage, the amplifier temperature, and the failure data log.

Control Commands

P0	(zero not 'O') Main Power On
P1	Main Power Off
M1	Mute channel 1-2
M2	Mute channel 3-4
M3	Mute channel 5-6
M4	Mute channel 7-8
M5	Mute channel 9-10
M6	Mute channel 11-12
M7	Mute channel 13-14
M8	Mute channel 15-16
MA	Mute all channels
U1	Unmute channel 1-2
U2	Unmute channel 3-4
U3	Unmute channel 5-6
U4	Unmute channel 7-8
U5	Unmute channel 9-10
U6	Unmute channel 11-12
U7	Unmute channel 13-14
U8	Unmute channel 15-16
UA	Unmute all channels

Inquiry Commands

M?	Binary string showing all zones mute status 0 = Mute 1 = Active (unmuted) (i.e. '00100000' – zone 3 is unmuted)
S?	Protection status (zone 1-8 and Amp)
T?	Temperature (zone 1-8)
P?	Main power status – 0=off, 1=on
V?	AC Line voltage – Decimal numeric value
L?	Protection data log (comma delimited text, 10 lines)

ARCHITECT™

Model 960
Model 961

Installer's Guide

Warranty

This is the only warranty given by AudioControl. This warranty gives you specific legal rights, and you may also have rights that vary from state to state. Promises of how well The Architect will work are not implied by this warranty. Other than what we've said we'll do in this warranty, we have no obligation, express or implied. We make no warranty of merchantability or fitness for any particular purpose. Also neither we nor anyone else who has been involved in the development or manufacture of the unit will have any liability of any incidental, consequential, special or punitive damages, including but not limited to any lost profits or damage to other parts of your system by hooking up to the unit (whether the claim is one for breach of warranty, negligence of other tort, or any other kind of claim). Some states do not allow limitations of consequential damages.

Failure to send in a properly completed warranty card negates any service claims.

The warranty included with the unit shall supersede this plain-text version if there is any inconsistency between the two.

The Warranty

People are scared of warranties. Lots of fine print. Months of waiting around. Well, fear no more. This warranty is designed to make you rave about AudioControl. It's a warranty that looks out for you and your client, plus helps you resist the temptation to have your friend, who's "good with electronics", try to repair your AudioControl product. So go ahead, read this warranty, then send in the warranty card and comments.

"Conditional" doesn't mean anything ominous. The Federal Trade Commission tells all manufacturers to use the term to indicate that certain conditions have to be met before they'll honor the warranty. If you meet all of these conditions, we will warrant all materials and workmanship on The Architect for five (5) years from the date you bought it, and we will fix or replace it, at our option, during that time.

Here are the conditional conditions:

1. You have to fill out the warranty card and send it to us within 15 days after installing the The Architect.
2. You must keep your sales receipt for proof of purchase showing when and from whom the unit was purchased. We're not the only ones who require this, so it's a good habit to get into with any major purchase.
3. The Architect must have originally been purchased from an authorized AudioControl dealer. You do not have to be the original owner, but you do need a copy of the original sales slip.
4. You cannot let anybody who isn't: (A) the AudioControl factory; or (B) somebody authorized in writing by AudioControl to service the The Architect. If anyone other than (A), or (B) messes with The Architect, that voids your warranty.
5. The warranty is also void if the serial number is altered or removed, or if The Architect has been used improperly. Now that sounds like a big loophole, but here is all we mean by it:

Unwarranted abuse is: (A) physical damage (don't use The Architect[™] to level your projection TV); (B) improper connections (120 volts into the RCA jacks can fry the poor thing); (C) sadistic things. This is the best product we know how to build, but if you strap it to the front bumper of your Range Rover, something might break.

Assuming you conform to 1 through 5, and it really isn't all that hard to do, we get the option of fixing your old unit or replacing it with a new one.

Legalese Section



What to do if you need service

First, contact AudioControl, either by e-mail, phone or FAX. We'll verify if there is anything wrong that you can fix yourself, or that it needs to be sent back to our factory for repair. Please include the following items with the returning unit:

- 1) A copy of your proof of purchase (that sales receipt we've been harping about). No originals please. We cannot guarantee returning them to you.
- 2) A brief explanation of the trouble you are having with The Architect_™. (You'd be surprised how many people forget this.)
- 3) A return street address. (No PO Boxes, please)
- 4) A daytime phone number in case our technician has a question about the problem you are having.

You're responsible for the freight charges to us, but we'll pay the return freight back as long as the unit is under warranty. We match whatever shipping method you use to send it to us, so if you return the unit overnight freight, we send it back overnight. We recommend United Parcel Service (UPS) for most shipments.

Repair service is available at:

AudioControl[®]

Attn: Service Department
22410 70th Avenue West
Mountlake Terrace, WA 98043 USA
Phone 425/775-8461 • FAX 425/778-3166



ARCHITECT[™]

*Model 960
Model 961*

Installer's Guide

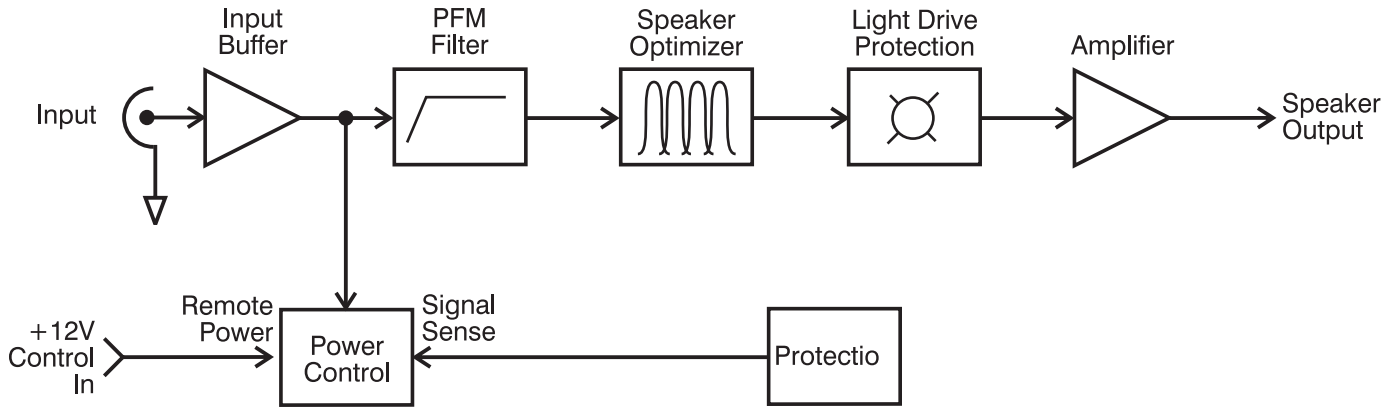

900 Series Specifications

Amplifier Power Rating (all channels driven)	60 Watts @ 8 ohms
Bridged Power	230 Watts @ 8 ohms
Minimum Speaker Load	4 ohms (2 ohms limited zones)
Damping Factor	Greater than 200
Total Harmonic Distortion	0.05% (Full Power, 20-20k)
Input Sensitivity	Variable 0-1 Vrms
Input Impedance	100 kilohms
Crosstalk	Greater than 80dB @ 1kHz
Equalizer Center Frequencies	75, 250, 700, 2.5k, 12KHz
PFM Highpass Filter	40Hz (switchable)
Remote Power Trigger	+12 VDC or Dry Contact Closure
AC Power Consumption	1600 Watts (all channels full power)
AC Main Fuse Rating	2 x 6 amp Slo-Blo
AC Main Operational Voltage	95 volts - 130 volts
Weight	48 pounds (22 kg)
Dimensions	17" W x 16" D x 7" H
Rack Mounting	19" Brackets (4U high)
Network Connection (Model 961)	10BaseT Ethernet
Network Protocol	TCP/IP
Communication Protocol	HTTP or Telnet
IP Addressing	Selectable Static or Dynamic via DHCP
Default Static IP Address	192.168.0.1
US Patent Number	5,708,577

© AudioControl 2004, All Rights Reserved.

This manual was written, designed, printed, folded and stuffed into the box in the U.S.A. Probably on a really soggy day considering where we live.

ARCHITECT™

Model 960
Model 961

Installer's Guide

AudioControl

For Those Who Consider Perfection Possible®

22410 70th Avenue West
Mountlake Terrace, WA 98043 USA
425-775-8461 • Fax 425-778-3166
e-mail: info@audiocontrol.com

Visit us on the web at www.audiocontrol.com

P/N 913 080 0

Free Manuals Download Website

<http://myh66.com>

<http://usermanuals.us>

<http://www.somanuals.com>

<http://www.4manuals.cc>

<http://www.manual-lib.com>

<http://www.404manual.com>

<http://www.luxmanual.com>

<http://aubethermostatmanual.com>

Golf course search by state

<http://golfingnear.com>

Email search by domain

<http://emailbydomain.com>

Auto manuals search

<http://auto.somanuals.com>

TV manuals search

<http://tv.somanuals.com>