

homebase™ DPF711K



audiovox

homebase™

TABLE OF CONTENTS

Important Safety Instructions	3
Introduction	4
Product Features	5
What's in the Box?	6
Installation	7
homebase Refrigerator Surface Installation	7
homebase Countertop Installation	8
homebase Wall Mount Installation Using the Wall Mount Bracket	9
homebase Wall Mount Installation Using the Angle Mount Brackets	10
Internal Battery Activation and/or Replacement	11
Controls, Indicators and Connectors	12
Accessory Placement	13
Operating the Homebase	14
Preliminary Connections	14
Connecting the Power	14
Getting Started	15
Family Names	16
Memos	17
Calendar	23
Countdown Timer	28
Photo Menu	29
General Settings	33
Language Selection	39
Technical Data	40
Warranty	44

homebase™

IMPORTANT SAFETY INSTRUCTIONS

Please read all safety and operating instructions carefully before installation, and keep these instructions handy for future reference. Take special note of all warnings listed in these instructions and on the unit.

1. **Water and Moisture:** The unit should not be used near water. For example: near a bathtub, swimming pool, etc.
2. **Ventilation:** The unit should be situated so that its location or position does not interfere with its proper ventila
3. **Heat:** The unit should be situated away from heat sources such as radiators, heat registers, stoves, or other appliances (including amplifiers) that produce heat.
4. **Power Source:** The unit should be connected to a power supply only of the type described in the operating instructions or as marked on the appliance.
5. **Power Cord Protection:** Power cords should be routed so that they are not likely to be walked on or pinched by items placed up or against them. It always best to have a clear area from where the cord exits the unit to where it is plugged into an AC outlet.
6. **Cleaning:** The unit should be cleaned as needed with a soft, non-abrasive cloth.
7. **Object and Liquid Entry:** Care should be taken so that objects do not fall and liquids are not spilled into any openings or vents located on the product.
8. **Attachments:** Do not use attachments not recommended by the product manufacturer.
9. **Lightning and Power Surge Protection:** Disconnect the unit from AC power during any electrical storm in the immediate vicinity. This will prevent damage to the product due to lightning and power-line surges.
10. **Overloading:** Do not overload wall outlets, extension cords, or integral convenience receptacles as this can resulting in a risk of fire or electric shock.
11. **Damage Requiring Service:** This unit should be serviced by qualified service personnel when:
 - a. The power supply cord or plug has been damaged.
 - b. Objects have fallen into or liquid has been spilled in the product enclosure.
 - c. The unit has been exposed to rain.
 - d. The unit has been dropped or the enclosure damaged.
 - e. The unit exhibits a marked change in performance or does not operate normally.
12. **Servicing:** The user should not attempt to service the unit beyond those methods described in the User's Manual. Service methods not covered in the operating instructions should be referred to qualified service personnel.

DPF711K

3

homebase™

INTRODUCTION

Consider homebase your one-stop home message center and digital picture frame. The whole family can use homebase to communicate with one another and to keep each other in the know.

Your homebase allows you to:

- Display digital photos from a number of internal or external media sources
- Record and retrieve video messages
- Record and retrieve audio messages
- Use the calendar to set audio and/or event reminders
- Display time and date
- Use a countdown timer
- Set an alarm
- Leave written messages on the unit's whiteboard or on the Post-it® pad
- Post items such as notes, coupons or receipts to the magnetic border with the included magnets

homebase™

PRODUCT FEATURES

Here's Everything You Get:

- 7-inch color LCD screen for displaying photos, the calendar and clock
- 1 GB of memory
 - enough for more than 125 high resolution pictures (Much more with standard pictures)
 - enough for 20 minutes of video memos; 40 memos max
 - enough for 30 minutes of audio memos; 40 memos max
 - enough for 400 event memos
- Built-in adjustable camera for recording digital voice memos
- Built-in microphone for recording digital voice memos
- Built-in speakers with separate volume control
- Magnetic border for posting notes, coupons, receipts, etc.
- LED light that indicates a message has been left
- Erasable whiteboard and dry erase marker for quick notes and messages
- Post-it notes for lists and reminders
- Multiple mounting options for your convenience: refrigerator, wall and countertop
- Supports SD/MMC, MS, xD and CF memory cards as well as USB flash drives
- Interactive calendar and digital clock (with alarm and countdown timer)

DPF711K

5

homebase™

WHAT'S IN THE BOX?

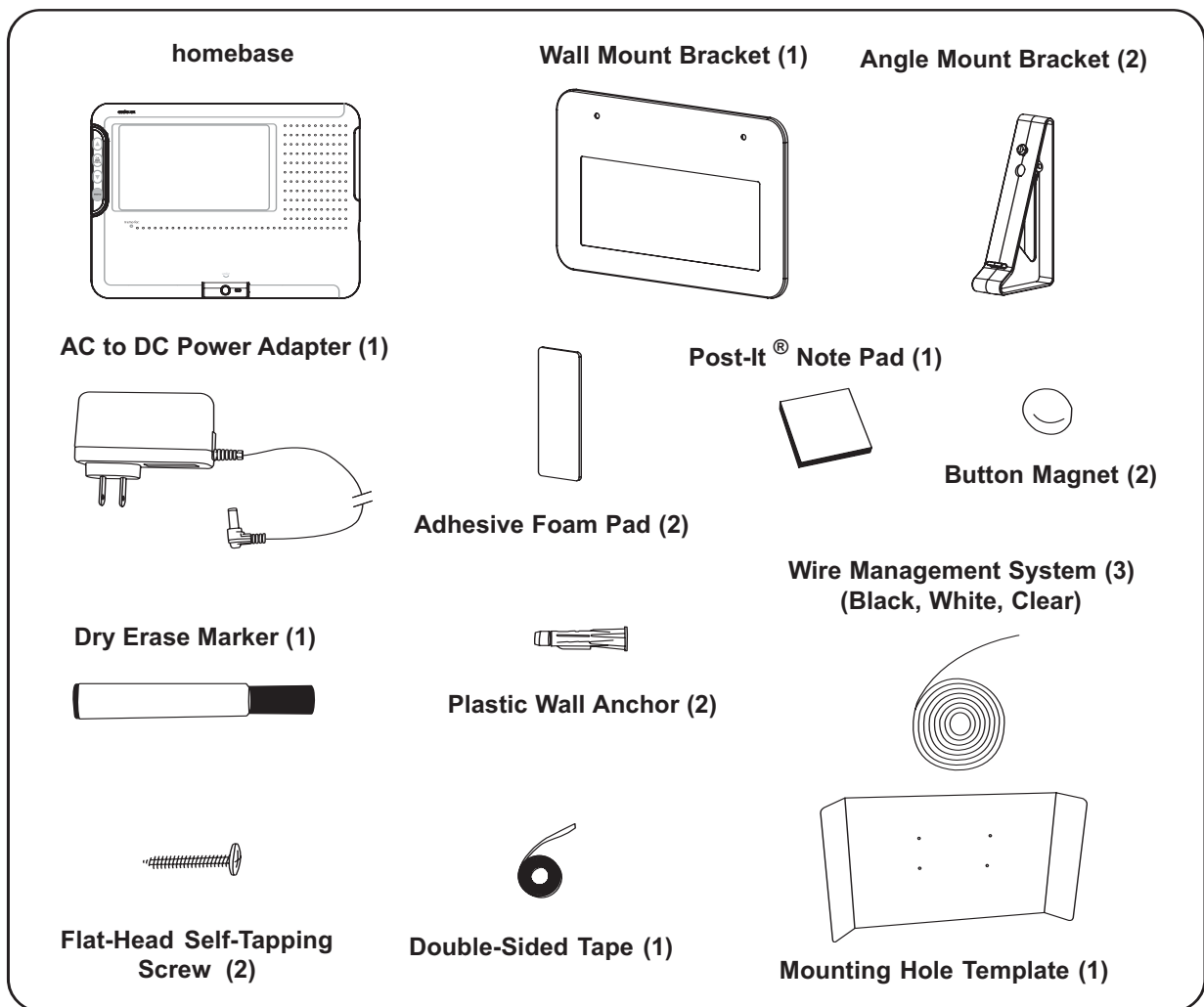

homebase™

INSTALLATION

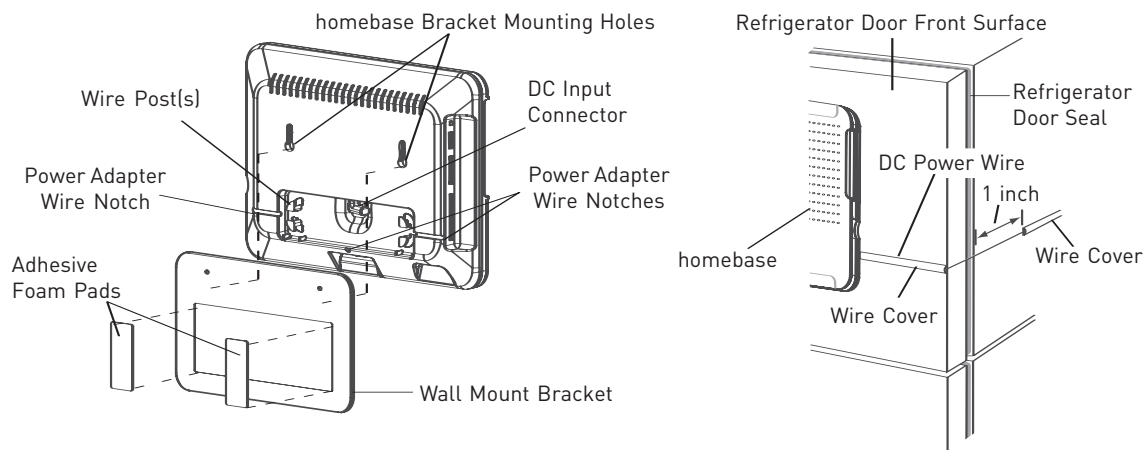

Refrigerator Surface Installation

1. Remove the protective backing **from one side** only of the two adhesive foam pads; position them on the back of the wall mount bracket as shown.
2. Clean the intended mounting area on the refrigerator with isopropyl alcohol.
NOTE: Do not use a glass cleaner.
3. Position the wall mount bracket where desired, making sure the top is level.
NOTE: Be sure of your location before removing the remaining protective backing from the adhesive pads, because they are NOT designed to be removed and repositioned once applied to the refrigerator surface.
4. Remove the protective backing from the two adhesive foam pads, line up the top of the bracket, then firmly press and hold the bracket in place to ensure that the pads adhere securely.
NOTE: 3M recommends waiting 24 hours for maximum adhesion before mounting the homebase to the wall mount bracket.
5. Connect the power adapter plug to the DC input connector at the rear of the homebase.
6. Determine how best to route the power adapter wire in reference to the AC wall outlet – to the left or right side of the homebase – and slip the DC wire into the corresponding wire notch on the back of the unit.
7. Check the amount of wire required to reach the AC outlet; spool any excess wire onto the four posts inside the rear hollow of the homebase.
8. Attach the homebase to the mount bracket by lining up the homebase bracket mounting holes with the wall bracket mounting pads; slide the homebase down until the mounting tabs fully engage the mounting hole slots.
9. Cover the power adapter wire with either the clear, black or white wire cover (to match your refrigerator); seal the cover using the double-sided tape provided, and then press into place, adhering it onto the refrigerator surface.

homebase™

INSTALLATION (cont'd)

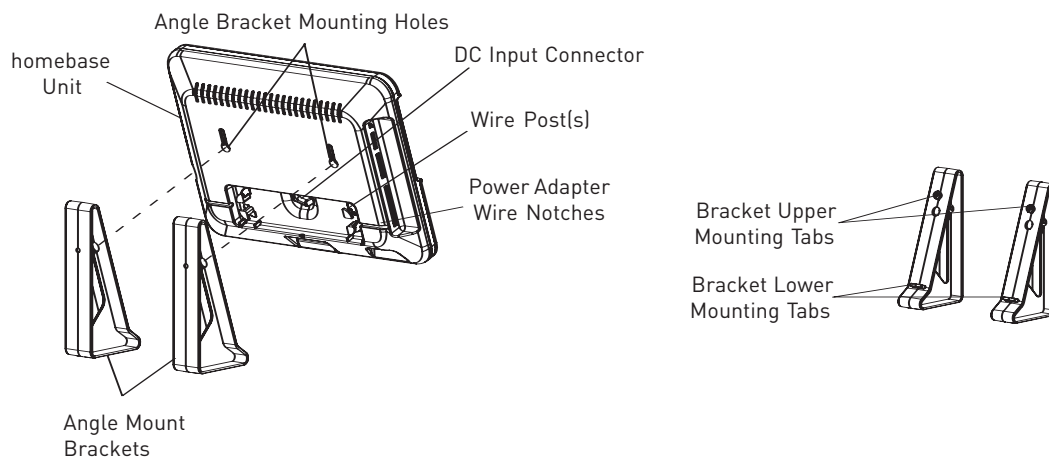

Countertop Installation

1. Find a suitable location on the countertop near an AC wall outlet.
2. Connect the power adapter plug to the **DC** input connector at the rear of the homebase.
3. Determine how best to route the power adapter wire in reference to the AC wall outlet – to the left or right side of the homebase – and slip the DC wire into the corresponding wire notch on the back of the unit.
4. Check the amount of wire required to reach the AC outlet; spool any excess wire onto the four posts inside the rear hollow of the homebase.
5. Attach each angle mount bracket to the homebase by lining up the individual angle mount bracket upper mounting tab with its corresponding hole on the homebase.
6. Push each angle mount bracket towards the top of the homebase until the upper mounting tab engages the mounting hole slot; when the bottom of the angle bracket contacts the homebase, the tab on the bottom of the angle bracket snaps into place.
7. Place the homebase in the desired location.

homebase™

INSTALLATION (cont'd)

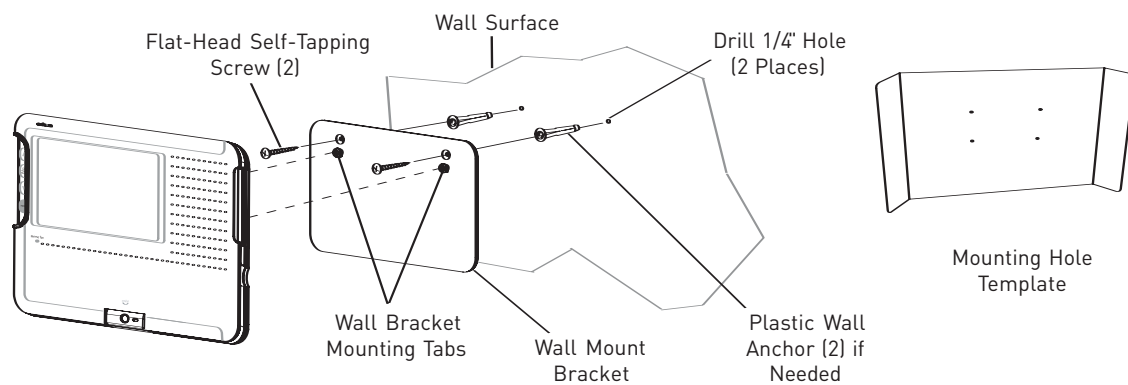

Wall Mount Installation Using the Wall Mount Bracket

NOTE: To mount the homebase to a wall using the adhesive pads, follow the same instructions indicated earlier in "refrigerator surface installation" – page 7.

To mount using screws, proceed as follows:

1. Position the mounting template against the wall at the desired location; level the top of the template, and mark the position of the two **upper** holes onto the wall.
2. Using a 1/4" (6mm) drill bit, drill two holes where you marked the wall; if a wall stud is not present, insert the provided plastic anchors into the holes until they are flush with the wall.
3. Align the wall bracket with the two drilled holes and/or wall anchors; insert the two flat-head screws provided, and secure the wall bracket to the wall.
CAUTION: Do not over tighten the screws; doing so may damage the wall bracket.
4. Connect the power adapter plug to the **DC** input connector at the rear of the homebase.
5. Determine how best to route the power adapter wire in reference to the AC wall outlet – to the left or right side of the homebase – and slip the DC wire into the corresponding wire notch on the back of the unit.
6. Check the amount of wire required to reach the AC outlet; spool any excess wire onto the four posts inside the rear hollow of the homebase.
7. Attach the homebase to the bracket by lining up the homebase bracket mounting holes with the wall bracket mounting tabs, and slide the homebase down until the mounting tabs engage the mounting hole slots.
8. Cover the power adapter wire with either the clear, black or white wire cover; seal the cover using the double-sided tape provided, and then press into place, adhering it onto the wall surface.

homebase™

INSTALLATION (cont'd)

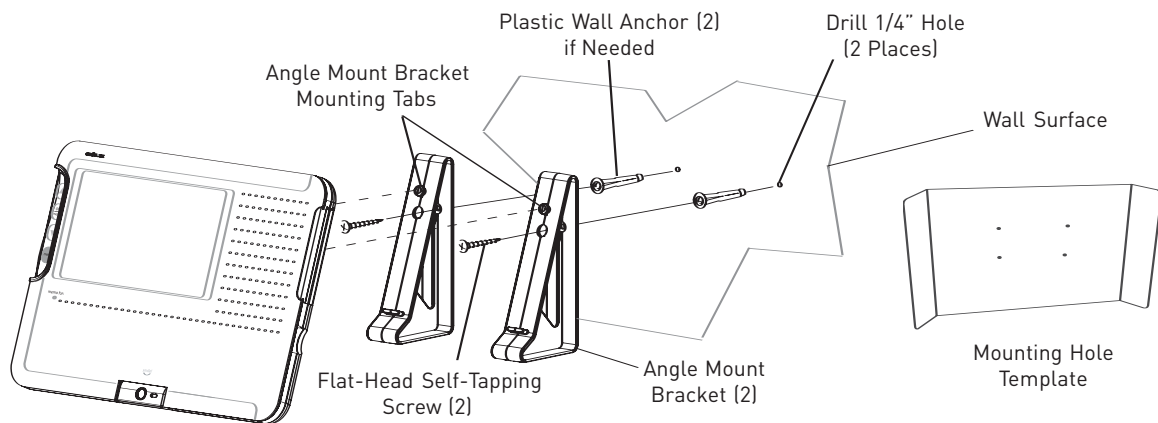

Wall Mount Installation Using the Angle Mount Brackets

NOTE: It is not recommended that you use the foam adhesive pads when mounting the angle mount brackets to a wall surface; in this case, always use screws.

1. Position the mounting template against the wall at the desired location; level the top of the template, and mark the position of the two **lower** holes onto the wall.
2. Using a 1/4" (6mm) drill bit, drill two holes where you marked the wall; if a wall stud is not present, insert the provided plastic anchors into the holes until they are flush with the wall.
3. Align each angle mount bracket with its respective drilled hole and/or wall anchor; insert a flat-head screw (two provided) through each wall bracket, and secure the bracket to the wall.
4. Connect the power adapter plug to the **DC** input connector at the rear of the homebase.
5. Determine how best to route the power adapter wire in reference to the AC wall outlet – to the left or right side of the homebase – and slip the DC wire into the corresponding wire notch on the back of the unit.
6. Check the amount of wire required to reach the AC outlet; spool any excess wire onto the four posts inside the rear hollow of the homebase.
7. Attach each angle mount bracket to the homebase by lining up the individual angle mount bracket upper mounting tab with its corresponding hole on the homebase.
8. Cover the power adapter wire with either the clear, black or white wire cover; seal the cover using the double-sided tape provided, and then press into place, adhering it onto the wall surface.

homebase™

INSTALLATION (cont'd)

Internal Battery Activation and/or Replacement

A type CR2032 battery is installed in a compartment behind the front panel of the homebase. If the unit is being used for the first time, the battery must be activated. A plastic insulator prevents contact with the battery terminals. The insulator must be removed for the calendar/clock backup functions to operate. To remove the insulator, simply pull out the plastic tab extending from the right side of the unit below the marker pen.

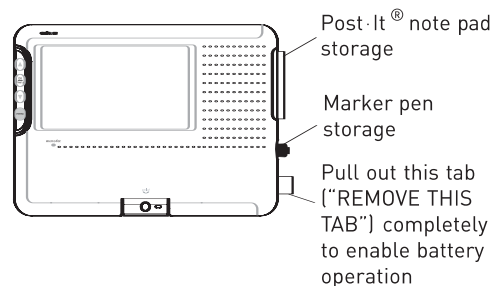

To remove and replace the battery, proceed as follows:

1. Lay the homebase on a flat surface with the front panel facing up.
2. Grasp the center of the front panel at the top and bottom edge, and bow the panel out until it clears the left side by the control buttons. Remove the panel to reveal the battery compartment cover.
3. With your thumb, press the cover in the direction indicated by the arrow until it disengages. Lift off the cover.
4. Carefully remove the battery.
5. Insert the battery into the compartment, paying special attention to battery orientation (+ side facing up).
6. Replace the battery compartment cover by first engaging the right-hand tabs in the slots; then press down and slide the cover to the left to secure it into place.
7. Replace the front panel by engaging the right side under the protruding lip; then slightly bow the panel out and slide the left side under the lip by the control buttons.
8. The battery backup feature should now be operational.

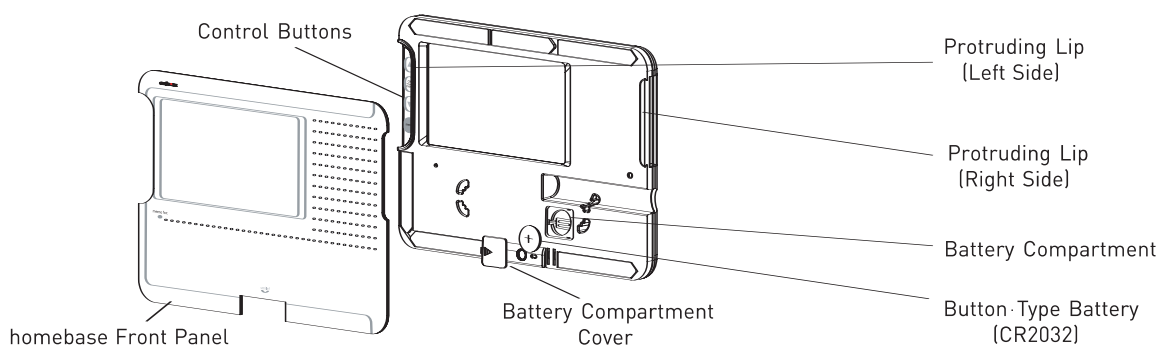

homebase™

CONTROLS, INDICATORS AND CONNECTORS

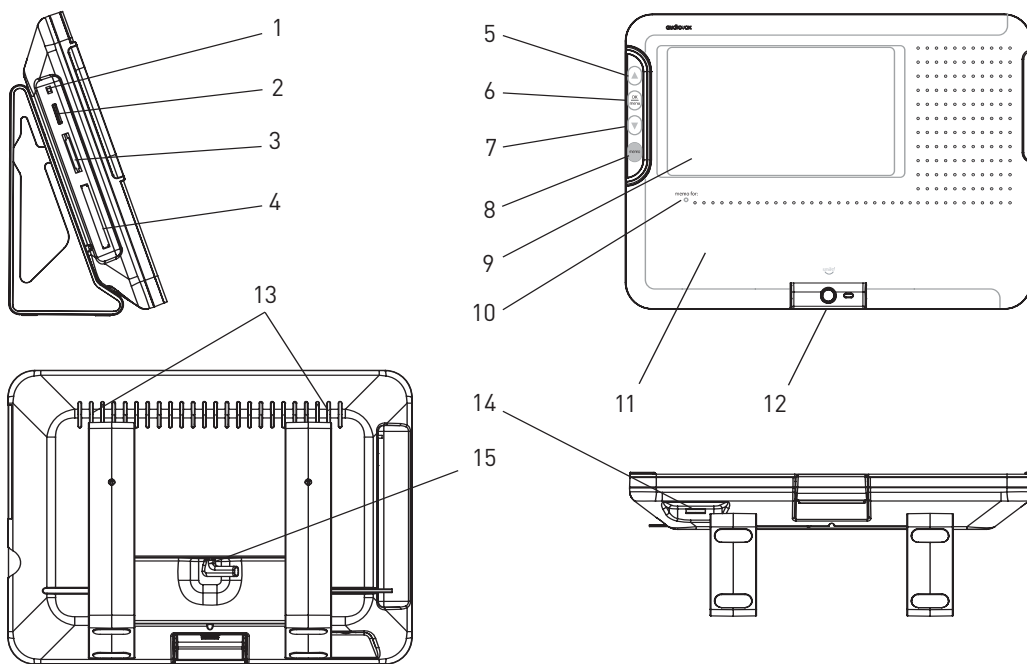

- | | |
|----------------------------------|-----------------------------------------|
| 1. Power On/Off Switch | 9. LCD Display |
| 2. USB Connector | 10. LED Indicator |
| 3. SD/MMC/MS/xD Connector | 11. Memo Writing Surface |
| 4. CF Connector | 12. Microphone, Camera,
Light Sensor |
| 5. Up (▲) Navigation Button | 13. Speakers |
| 6. OK / MENU Button | 14. - Volume + Control |
| 7. Down (▼) Navigation Button | 15. DC Input Connector |
| 8. MEMO Button | |

homebase™

ACCESSORY PLACEMENT

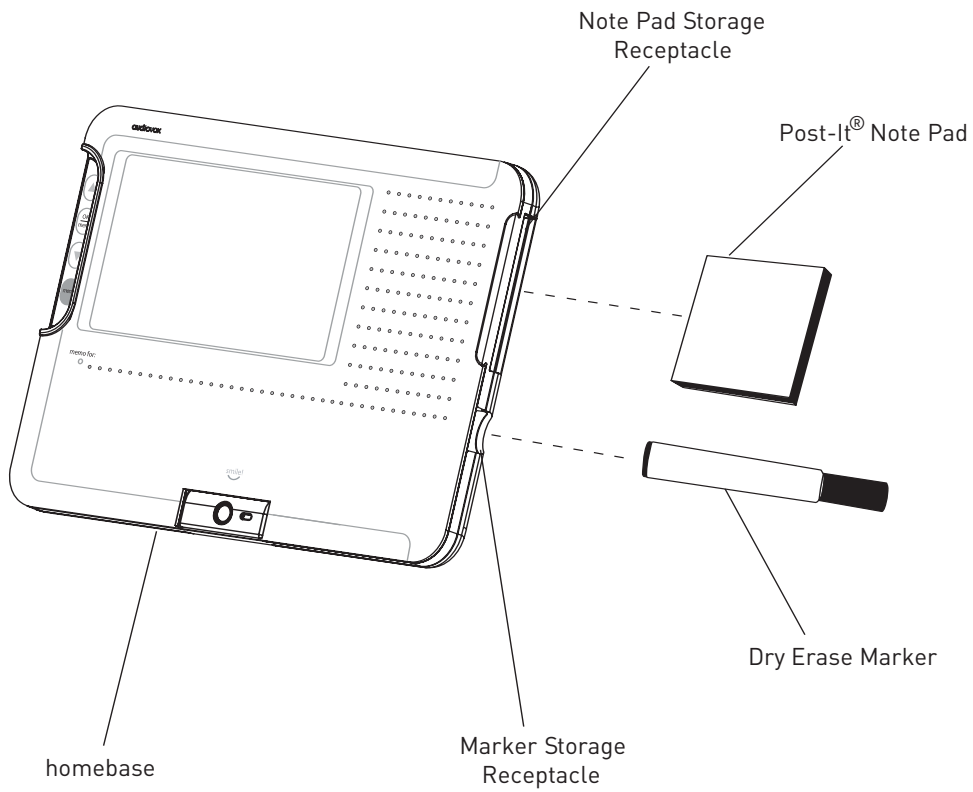

DPF711K

13

homebase™

OPERATING THE HOMEBASE

Preliminary Connections

Prior to initial operation, the unit must be plugged in, and the tab ("REMOVE THIS TAB") on the right side of the unit must be removed to enable backup battery operation.

Connecting the power

Power to the homebase is provided by the AC-to-DC wall adapter, which delivers +9VDC to the DC input connector at the rear of the unit. Refer to the installation procedures outlined previously for the methods involved in connecting the wall adapter plug to the power input connector, and the routing and dressing of the adapter power cable. The figure below illustrates a typical installation.

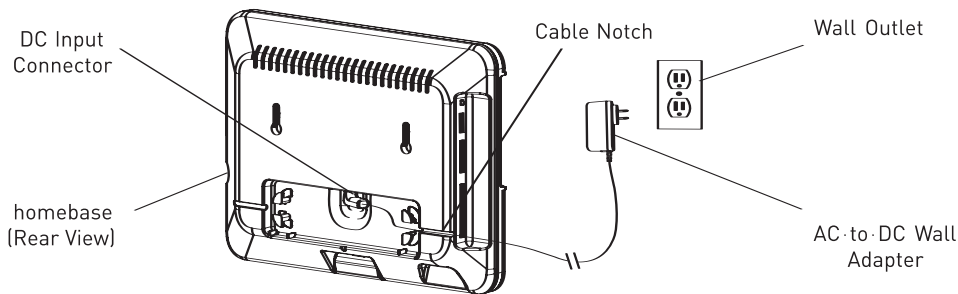

Inserting the Memory Card/USB Device

All memory devices attach at the left side of the homebase. These can include USB Flash Memory, a Compact Flash (CF) Memory Card, a Multi-Media Card (MMC), a Memory Stick (MS) Card, a Secure Digital (SD) Card or an xD Card. All of these devices are inserted into their respective receptacles with the label side facing the rear of the homebase.

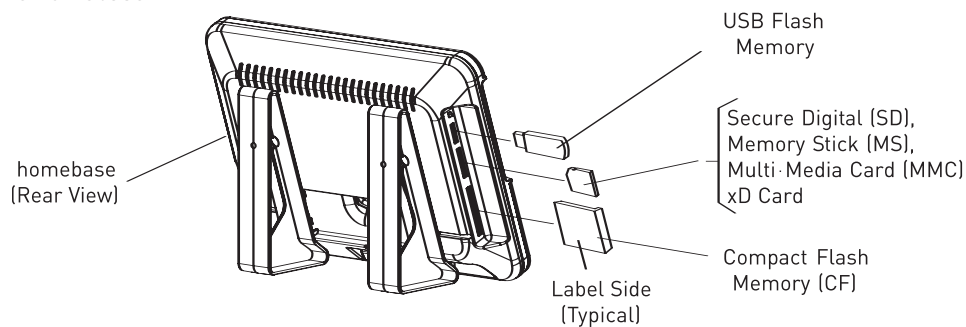

homebase™

GETTING STARTED

Once homebase is properly mounted and plugged in, you are ready to begin. If you want to use your own pictures, be sure to have your memory card already connected.

1. Turn homebase on by moving the power switch on the left side upward. After just a few seconds, you will see a white welcome screen that says "audiovox homebase."
IF YOUR MEMORY CARD IS CONNECTED... a slide show with your pictures will automatically start.
NO MEMORY CARD IS CONNECTED...a slide show with sample pictures will automatically start.

NOTE: If this is not the first time homebase is used, the white welcome screen may stay on with no pictures displayed. This is OK, as the sample pictures may have been deleted. You may want to erase the sample pictures prior to adding your pictures to the memory. You will learn about how to erase pictures in detail later on.

2. Press the **OK/menu** button. Everything homebase does starts here. You will see the main "menu" ("exit", "memo", "calendar", "timer", "photo" and "settings"). "Calendar" will automatically be highlighted in orange.
3. Try pressing the up and down arrows and watch the orange highlighter move. This is how you will highlight your function choices. Pressing **OK/menu** will take you straight to any of these options. It's that simple!
4. Remember, highlighting and selecting "exit" and/or "back" will always take you back home, even if you must do so several times. Home is the homebase screen or picture slide show.

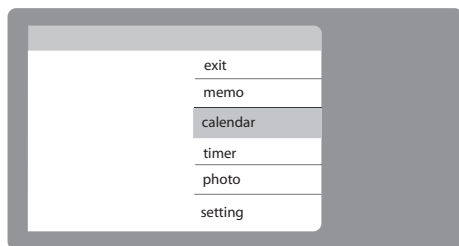

Now, let's learn more about using homebase's many features. Please note that all instructions are provided starting from "home"

homebase™

FAMILY NAMES

Your Homebase can be customized for your family by inputting you family member names into the unit. This will allow you to leave video and voice memos for specific family members. If there is a message waiting for someone, their name(s) will appear on the screen indicating they have a memo.

How do I input family names?

1. Press the **OK/menu** button. Highlight "settings" and press **OK/menu**.
2. Highlight "family names" and press **OK/menu**. The unit already has and defaults to the setting for "all" which can be used when there is a memo to all family members.
3. Highlight "add a new name" and press **OK/menu**. A new window will open with a flashing cursor. Now press the up or down arrow buttons to select the first letter of the name you want to add. (Note the up arrow button starts with the letter "a" and the down arrow button starts with the letter "z") After selecting the letter press **OK/menu** and the cursor moves to the next letter. Repeat this process until the name is spelled out.
4. When the name is finished press **OK/menu** 2 times. The name will now be added to the "family names" menu.
5. Now you can enter another name or highlight "back" and press **OK/menu** to exit.

NOTE: If you make an error you can easily delete the incorrect name from the family names menu and create the name again. There is no backup button.

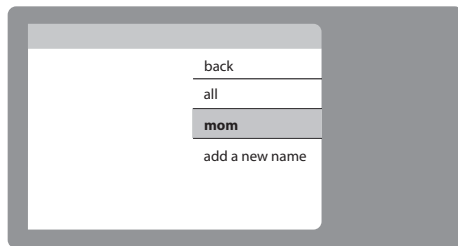
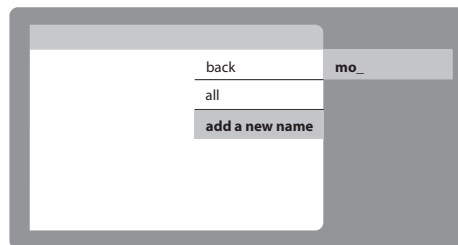
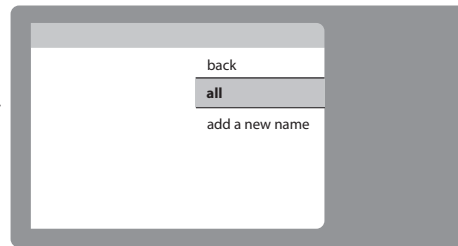

How do I delete a family name?

1. Press the **OK/menu** button. Highlight "settings" and press **OK/menu**.
2. Highlight "family names" and press **OK/menu**.
3. Highlight the "name" you want to delete and press **OK/menu**. A new menu will appear.
4. Highlight "delete" and press **OK/menu**.
5. Now you can enter or delete another name or highlight "back" and press **OK/menu** to exit.

homebase™

MEMOS

How do I leave a video memo?

1. Press the orange button that says memo. (This button will take you straight to the “memo” menu no matter where you are.) You can also press the menu button then highlight “memo” and press **OK/menu**. It’s up to you.
2. The “memo” menu has 5 options: “exit”, “record video”, “record voice”, “play/erase” and “erase all”.

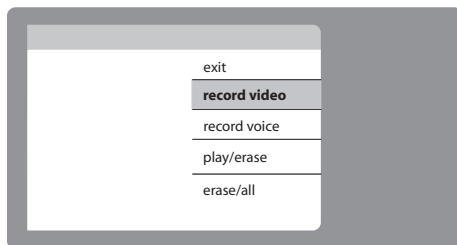

3. Highlight “record video” and then press **OK/menu**.
4. The “record video > for” menu will appear. Highlight the family member you want to leave the memo for and press **OK/menu**.
5. The video screen will appear. Now you can adjust the camera by moving the housing up and down as needed. You can also adjust the brightness of the video using the the up and down arrow buttons. When you are ready to record press **OK/menu**.
6. The orange light will illuminate and you are now recording your video memo. Press **OK/menu** when you are finished recording.
7. The “memo” menu will automatically come up (“review”, “keep/exit”, “record again” and “cancel”).

homebase™

MEMOS (cont'd)

Now, what would you like to do?

To save your video memo...

Highlight "keep/exit" and then press **OK/menu**. Your memo is saved. The orange light in front will stay lit and homebase will go back home.

NOTE: If one of the clock display options is active you will also see "memo(s) for:" followed by the family members name displayed on the screen.

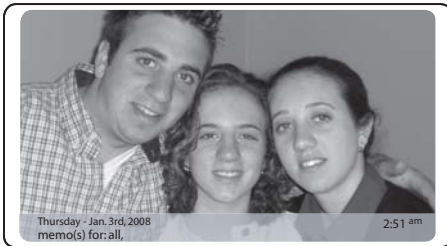

To view your video memo...

Highlight "review" and press **OK/menu**. View your memo again. If you like it, highlight "keep/exit" and then press **OK/menu**. Your memo is saved. The orange light in front will stay lit and homebase will go back home.

To change your video memo...

Highlight "record again" and press **OK/menu**. Again you can adjust your settings then press **OK/menu** to record your new memo and then press **OK/menu** to stop recording. If you are satisfied with your memo highlight "keep/exit" and press **OK/menu**. Your memo is saved. The orange light in front will stay lit and homebase will go back home.

To cancel your video memo...

Highlight "cancel" and press **OK/menu**. You will automatically return to the "memo" screen.

8. Highlight "exit" and press **OK/menu** to go back home.

homebase™

MEMOS (cont'd)

How do I leave a voice memo?

1. Press the orange button that says memo. (This button will take you straight to the "memo" menu no matter where you are.) You can also press the menu button then highlight "memo" and press **OK/menu**. It's up to you.
2. The "memo" menu has 5 options: "exit", "record video", record voice "play/erase" and "erase all".
3. Highlight "record voice" and then press **OK/menu**. The "record voice > for" will appear. Highlight the family member you want to leave the memo for and press **OK/menu**. You will see the orange light come on, and you can then start recording your memo.
4. Press **OK/menu** when you are finished recording.
5. The "memo" menu will automatically come up ("review", "keep/exit", "record again" and "cancel").

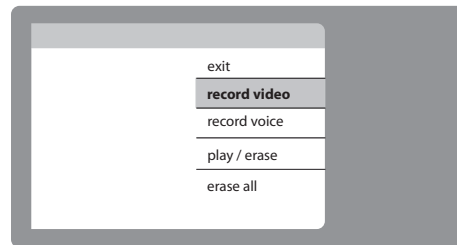

Now, what would you like to do?

To save your voice memo...

Highlight "keep/exit" and then press **OK/menu**. Your memo is saved. The orange light in front will stay lit and homebase will go back home.

NOTE: If one of the clock display options is active you will also see "memo(s) for:" followed by the family members name displayed on the screen.

To listen to your voice memo...

Highlight "review" and press **OK/menu**. Listen to your memo again. If you like it, highlight "keep/exit" and then press **OK/menu**. Your memo is saved. The orange light in front will stay lit and homebase will go back home.

To change your memo...

Highlight "record again" and press **OK/menu**. Record your new memo and then press **OK/menu** to stop recording. If you are satisfied with your memo highlight "keep/exit" and press **OK/menu**. Your memo is saved. The orange light in front will stay lit and homebase will go back home.

To cancel your memo...

Highlight "cancel" and press **OK/menu**. You will automatically return to the "memo" screen.

6. Highlight "exit" and press **OK/menu** to go back home.

homebase™

MEMOS (cont'd)

How do I listen to a voice or view a video memo?

1. Press **memo**.
2. Highlight "play/erase" and press **OK/menu**. All saved voice memos will pop up with dates and times. Unheard memos are left in orange.
3. Highlight the memo you want to hear and press **OK/menu**. As you highlight the memo an icon will appear to the right of the memo indicating what type of memo it is.

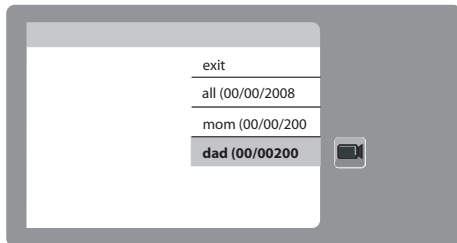

audio



video

You will have 4 play options: "play", "erase", "keep", and "keep as new".

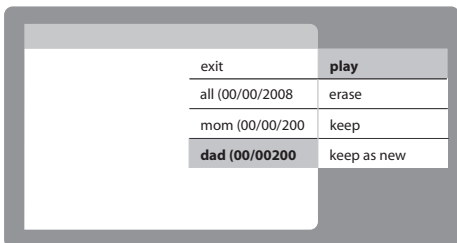

4. Highlight "play" and Press **OK/menu** to play the memo. When the memo finishes playing you return to this menu.

homebase™

MEMOS (cont'd)

Now, what do you want to do?

- "play" – will play your memo again and return you to this menu.
- "erase" – will erase your memo again and return you to this menu.
- "keep" – will save your memo and change the color to gray indicating that it has already been heard.
- "keep as new" – will save your memo and change the memo name color to orange as if it has not been heard.

5. When finished, highlight "exit" and press **OK/menu** to go back home.

How do I erase a voice or video memo?

1. Press **memo**.
2. Highlight "play/erase" and press **OK/menu**. All saved voice memos will pop up with dates. New messages will be in orange.
3. Highlight the memo you want to erase and press **OK/menu**.
4. Highlight "erase" and press **OK/menu**.
5. Highlight "exit" and press **OK/menu** to go back home.

How do erase all voice and video memos?

1. Press **memo**.
2. Highlight "play/erase" and press **OK/menu**. All saved voice memos will pop up with dates. New messages will be in orange.
3. Highlight "erase all" and press **OK/memo**. A sub menu will appear. Highlight "yes" and press **OK/menu**. All memos will be erased and the menu will display "no memo".
4. Highlight "exit" and press **OK/menu** to go back home.

How do I save a voice or video memo I've heard, but leave it highlighted as a new memo?

1. Press **memo**.
2. Highlight "play/erase" and press **OK/menu**.
3. Highlight the memo you want to save as new and press **OK/menu**.
4. Highlight "keep as new" and press **OK/menu**.
5. Highlight "exit" and press **OK/menu** to go back home.

homebase™

MEMOS (cont'd)

How do I listen to a voice or video memo, but not delete it?

1. Press **memo**.
2. Highlight "play/erase" and press **OK/menu**.
3. Highlight the memo you want to hear and press **OK/menu**.
4. Highlight "play" and press **OK/menu**.
5. Listen to or view the memo.
6. When memo is finished, highlight "keep" and press **OK/menu**.
7. Highlight "exit" and press **OK/menu** to go back home.

How do I erase all voice and video memos?

1. Press **memo**.
2. Highlight "erase all" and press **OK/memo**. A sub menu will appear. Highlight "yes" and press **OK/menu**. All memos will be erased and the menu will display "no memo. Highlight the memo you want to hear and press **OK/menu**.
3. Highlight "exit" and press **OK/menu** to go back home.

homebase™

CALENDAR

How do I leave a voice or video memo for a specific date?

NOTE: Dated voice memos are automatically deleted 72 hours after scheduled date.

1. Press the **OK/menu** button. You will see the main "menu" ("exit", "memo", "calendar", "timer", "photo" and "settings"). "Calendar" will automatically be highlighted in orange.
2. Press **OK/menu**.
3. In "Calendar", press the up or down arrows to change dates. Press and hold the up or down arrow for 2 seconds, then release, to change months.
4. Highlight the desired date and press memo button.
5. Select the type of memo you want to record by highlighting "record video" or "record voice" and press **OK/menu**.
6. Highlight the family member you want to leave the memo for and press **OK/menu**.
7. Press **OK/menu** when you are finished recording.
8. The "memo" menu will automatically come up ("review", "keep/exit", "record again" and "cancel").

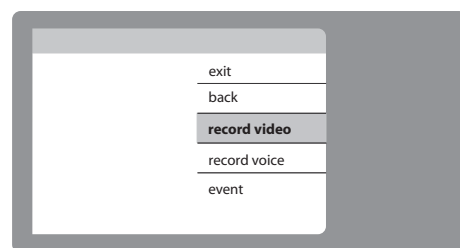
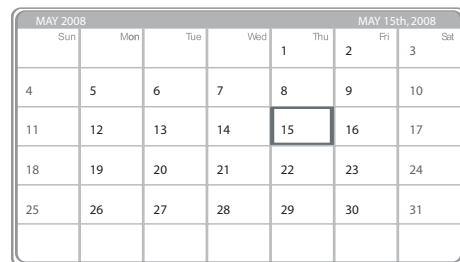
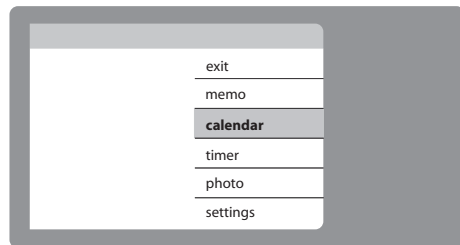

homebase™

CALENDAR (cont'd)

Now, what would you like to do?

To save your voice or video memo...

Highlight "keep/exit" and then press **OK/menu**. Your memo is saved. The orange light in front will stay lit and homebase will go back home. Be sure to use the marker to write down to whom the memo is intended for on the marker board under the "memo for:" light.

To listen to your voice or video memo...

Highlight "review" and press **OK/menu**. Listen to your memo again. If you like it, highlight "keep/exit" and then press **OK/menu**. Your memo is saved. The orange light in front will stay lit and homebase will go back to the "calendar memo" menu.

To change your voice or video memo...

Highlight "record again" and press **OK/menu**. Record your new memo and then press **OK/menu** to stop recording. If you are satisfied with your memo highlight "keep/exit" and press **OK/menu**. Your memo is saved. The orange light in front will stay lit and homebase will go back to the "calendar memo" menu.

To cancel your voice or video memo...

Highlight "cancel" and press **OK/menu**. You will automatically return to the "calendar memo" menu.

9. Once you select "keep/exit", the screen will return back to the "calendar memo" menu. A small gray box will appear on the date to indicate that your voice or video message has been saved for that date.
10. Highlight "exit" and press **OK/menu** to go back home.

How do I hear/view and erase... or hold onto a voice or video memo left on a specific date... or erase all memos on all dates?

1. Press **OK/menu**.
2. Press **OK/menu** again.
3. Select day and month in "calendar".
4. Highlight the desired date and press **OK/menu**.
5. Highlight "voice/video memo" and press **OK/menu**.
6. Highlight the memo you want to hear or view and press **OK/menu**.
7. "Play" will automatically be highlighted.
8. Press **OK/menu** to hear memo. When memo is finished, 4 options will automatically pop up: "play", "erase", "keep" and "keep as new".

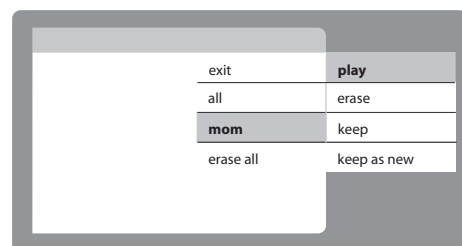

homebase™

CALENDAR (cont'd)

Now, what would you like to do?

To erase a voice or video memo...

- a. Highlight "erase" and press **OK/menu**. Screen will automatically return to calendar memo screen and memo will be gone from list.
- b. Highlight "exit" and press **OK/menu**. Screen will return to calendar.
- c. Press **OK/menu** and screen will return to calendar memo screen.
- d. Highlight "exit" and press **OK/menu** to go back home.

To keep a voice or video memo...

- a. "Keep" will automatically be highlighted; press **OK/menu**. Screen will automatically return to the "calendar memo" screen.
- b. Highlight "exit" and press **OK/menu**. Screen will return to calendar.
- c. Press **OK/menu** and screen will return to memo screen.
- d. Highlight "exit" and press **OK/menu** to go back home.

To erase all memos from all dates...

- a. Highlight "erase all" and press **OK/menu**. Screen will automatically return to the calendar date with no voice memo icons showing.
- b. Highlight "yes" and press **OK/menu**.
- c. Screen will return to the "calendar memo" menu showing "no memo"
- d. Highlight exit and press **OK/menu** and screen will return to the calendar screen.
- e. Press **OK/menu**. Highlight "exit" and press **OK/menu** to go back home.

How do I leave a special event memo?

1. Press the **OK/menu**.
2. Press **OK/menu** again.
3. Select day and month in "calendar".
4. Highlight the desired date and press the orange memo button.
5. Highlight "event" and press **OK/menu**.
6. Choose which type of special event this date is for: "birthday", "anniversary", "holiday" or "special". Highlight accordingly and press **OK/menu**.

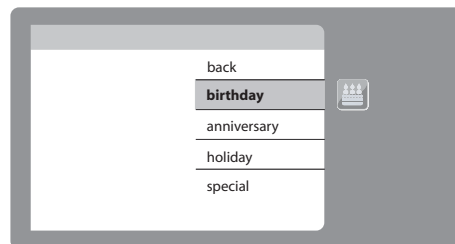

homebase™

CALENDAR (cont'd)

Now, what do you want to do?

To make this a one-time event...

- a. Leave "on" highlighted and press **OK/menu**. Screen will automatically return to event selection screen. A small orange box will appear on the date to indicate that your message has been saved for that date.
- b. Highlight "back" and press **OK/menu**. Screen will return to the calendar screen.
- c. Press **OK/menu** and highlight "exit" and press **OK/menu** again to go back home.





To mark this event on the same day every year...

- a. Highlight "on every year" and press **OK/menu**. Screen will automatically return to the event selection screen. A small orange box will appear on the date to indicate that your message has been saved for that date.
- b. Highlight "back" and press **OK/menu**. Screen will return to the calendar screen.
- c. Press **OK/menu** and highlight "exit" and press **OK/menu** again to go back home.

NOTE: Now when you are in the calendar and on the day of an event the event icon(s) will appear on the calendar telling you what are the events of that day. In addition, if one of the clock display options is active you will also see the event icon displayed on the screen indicating that there is an event on this day.

How do I check a calendar event?

1. Press the **OK/menu**.
2. Press **OK/menu** again.
3. Select day and month in "calendar".
4. Highlight the desired date and press **OK/menu**.
5. Highlight "event memo" and press **OK/menu**.
6. Select which event memo and press **OK/menu**.
7. An icon will appear displaying what type of occasion it is.
8. Press **OK/menu**. "Keep" will automatically be highlighted.
9. Press **OK/menu** to save event.
10. Highlight "back" and press **OK/menu**. Screen will return to the calendar menu.
11. Highlight "exit" and press **OK/menu** to go back home.

-  Special Event Icon
-  Anniversary Reminder Icon
-  Birthday Reminder Icon
-  Holiday Reminder Icon



homebase™

CALENDAR (cont'd)

How do I erase a calendar event?

1. Press the **OK/menu**.
2. Press **OK/menu** again.
3. Select day and month in "calendar".
4. Highlight the desired date and press **OK/menu**.
5. Highlight "event memos" and press **OK/menu**.
6. Highlight the event and press **OK/menu** and highlight "erase"; press **OK/menu** again. Screen will return to calendar memo screen and event will be missing.
7. Highlight "back" and press **OK/menu**. Screen will return to calendar.
8. Highlight "back" and press **OK/menu** to return to the calendar or highlight "exit" and press **OK/menu** to go back home.

homebase™

COUNTDOWN TIMER

How do I set a countdown reminder?

1. Press **OK/menu** and the main "menu" will pop up.

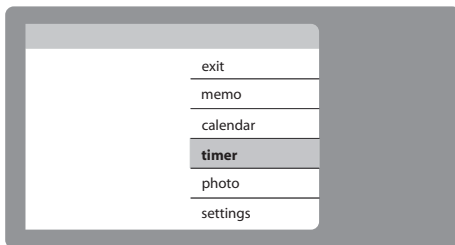

2. Highlight "timer" and press **OK/menu**. A split screen display appears with the countdown timer on the left and a slide show on the right.

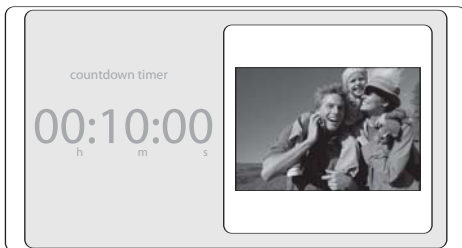

3. When the timer display appears, the hour (h) digits are flashing and "10 minutes" is indicated.
4. Use the up and down buttons to set the hours; press **OK/menu**.
5. The minutes digits are now flashing; use the up and down buttons to set the minutes (m); press **OK/menu**.
6. The timer starts. The minutes digit decreases by 1 and the seconds (s) digits begin to countdown from 59, initiating the countdown sequence.
7. To stop the countdown prior to "timeout", press **OK/menu**.
8. In the event that the timer is allowed to run out, "time up" appears below the digits; the display automatically returns to the slide show, and the alarm will sound for 2 minutes.
9. To shut off the alarm, press **OK/menu**.

homebase™

PHOTO MENU

The homebase can accept 6 different types of memory devices SD, MMC, MS, xD and CF cards as well as a USB flash drive. When you plug one of these devices into the appropriate receptacle the unit will go directly to step 6 below and display the photo icons on your memory device.

NOTE: If you turn on your homebase with a memory device installed the slideshow will default to that memory device rather than the pictures in your homebase photo library

How do I load my photos?

1. Insert your memory card in the appropriate receptacle on the side of the unit. The unit should immediately load the "external media" library for the memory device you installed. If this is the case go to number 6 below. If your memory device was already installed continue with number 2 below.
2. Press **OK/menu** and the main "menu" will pop up.
3. Highlight "photo" and press **OK/menu**; 4 options will then appear ("back", "external media", "photo library" and "slide show").

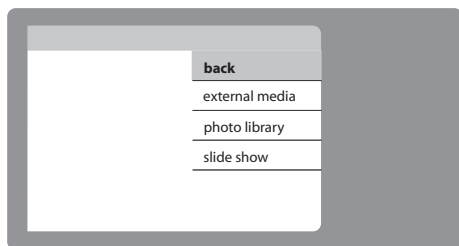

4. Highlight "external media" and press **OK/menu**. A new menu will appear with the different memory device listed
5. Highlight the device format name (for instance, if you have a SD card select "sd/mmc/xd/ms") and press **OK/menu**.

homebase™

PHOTO MENU (cont'd)

- All photos will automatically be displayed as thumbnails on the screen. Highlight the photo you would like to copy by pressing the up and down arrows; when photo is selected, press **OK/menu**.



- The photo will be displayed enlarged, followed by a menu that will automatically pop up with 5 options.

Now, what do you want to do?

To copy this photo to your photo library...

Highlight "copy" and press **OK/menu**. Menu will stay on screen when the copy is complete.

To copy all photos to your photo library...

Highlight "copy all" and press **OK/menu**. Menu will stay on the screen when the copy is complete.

To view the next photo enlarged...

Highlight "next" and press **OK/menu**.

To go back to thumbnail mode...

Highlight "back" and press **OK/menu**

- When all desired photos are copied, highlight "exit" and press **OK/menu** to go back home.

NOTE: Once all desired photos are copied, the memory card can be removed and the photos will be retained until deletion.

homebase™

PHOTO MENU (cont'd)

What can I do with my photos once they are in the Photo Library?

1. Press **OK/menu** and the main "menu" will pop up.
2. Highlight "photo" and press **OK/menu**.
3. Highlight "photo library" and press **OK/menu**. All photos stored in the photo library will automatically pop up.



4. Highlight desired photo by pressing the up and down arrows; when photo is selected, press **OK/menu**.
5. Photo will enlarge, followed by a menu that will automatically pop up with 6 options.

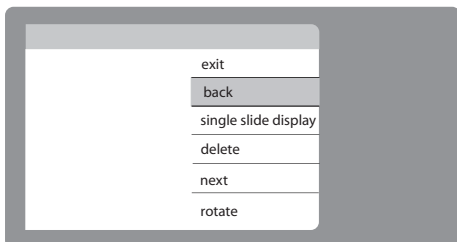

homebase™

PHOTO MENU (cont'd)

Now, what would you like to do?

To make this picture the only picture displayed...

Highlight "single slide show" and press **OK/menu**. Confirm that "on" is highlighted and press **OK/menu** once more. Now that photo you selected will be displayed until you change back to the slideshow.

NOTE: Turning single slide show on will stop home screen slide show. To restore, repeat above directions, but select "off" instead.

To rotate the photo for better viewing...

Highlight "rotate" and press **OK/menu**. A menu will automatically pop up. Highlight 0° to set the photo to its original position, 90° to rotate the photo clockwise a revolution, 180° to turn the photo upside down and 270° to turn the photo clockwise a revolution. Press **OK/menu** when desired position is highlighted.

To view next photo in photo library...

Highlight "next" and press **OK/menu**.

To go back to thumbnail mode...

Highlight "back" and press **OK/menu**.

To delete photo...

Highlight "delete" and press **OK/menu**. Highlight "yes" and press **OK/menu**.

To delete all photos in photo library...

Highlight "delete" and press **OK/menu**. Highlight "all" and press **OK/menu**.

Or 6. Highlight "back" and press **OK/menu** to go back to the photo icon library.

7. Highlight "exit" and press **OK/menu** to go back home.

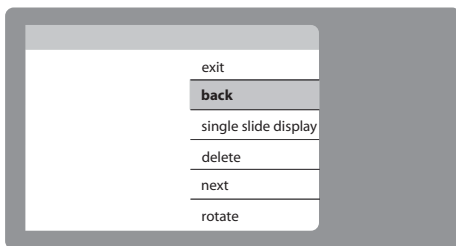

homebase™

GENERAL SETTINGS (cont'd)

How can I change the way the slide show plays?

1. Press **OK/menu** and the main "menu" will pop up.
2. Highlight "photo" and press **OK/menu**.
3. Highlight "slide show" and press **OK/menu**; a menu will automatically pop up giving you 4 options.

Now, what do you want to do?

To enable the slide show...

Highlight "enable slide show" and press **OK/menu**. Highlight "on" and press **OK/menu**.

To have the slide show play photos in order...

Highlight "slide show order" and press **OK/menu**. Highlight "sequential on" and press **OK/menu**.

To have the slide show play photos randomly...

Highlight "slide show order" and press **OK/menu**. Highlight "random on" and press **OK/menu**.

To set the time duration each photo will be displayed in the slide show...

Highlight "slide show time" and press **OK/menu**. Highlight length of time that is desired (5, 10 or 30 seconds) and press **OK/menu**.

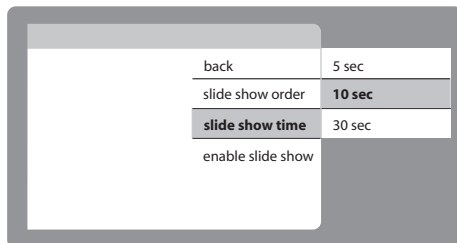

4. Highlight "back" and press **OK/menu**.
5. Highlight "exit" and press **OK/menu** to go back home.

homebase™

GENERAL SETTINGS

How can I choose between normal or widescreen for my photos?

1. Press **OK/menu** and the main "menu" will pop up.
2. Highlight "settings" and press **OK/menu**.
3. Highlight "general setup" and press **OK/menu**.

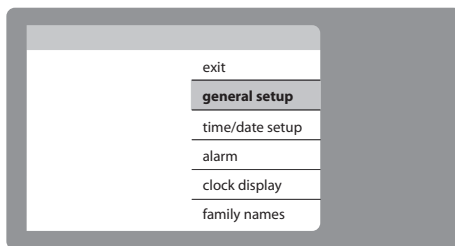

4. Highlight "photo mode" and press **OK/menu**.
5. Highlight "normal" or "widescreen" and press **OK/menu**. After selection, the unit will go back home.

How can I pick a time for homebase to turn on and off each day?

Your Homebase has a built in light sensor that will automatically turn off the display 2 minutes after the room goes dark. It will come back on automatically when the room is illuminated again. You can also set your homebase to turn on and off each day at specific times.

1. Press **OK/menu** and the main "menu" will pop up.
2. Highlight "settings" and press **OK/menu**.
3. Highlight "general setup" and press **OK/menu**.
4. Highlight "activation time" and press **OK/menu**.
5. Highlight "enable/disable" and press **OK/menu**. Highlight "enable" and press **OK/menu**.
6. Highlight "set turn on time" and press **OK/menu**.
7. Use the up and down arrows to set desired hour, then press **OK/menu**. Repeat for minutes and AM/PM. Press **OK/menu**.
8. Highlight "set turn off time" and press **OK/menu**.
9. Use the up and down arrows to set desired hour, then press **OK/menu**.
10. Highlight "back" and press **OK/menu**.
11. Highlight "exit" and press **OK/menu** to go back home.

homebase™

GENERAL SETTINGS (cont'd)

How can I clear all data stored in memory?

NOTE: This will permanently delete ALL stored photos, voice and video memos, events, times and alarms.

1. Press **OK/menu** and the main "menu" will pop up.
2. Highlight "settings" and press **OK/menu**.
3. Highlight "general setup" and press **OK/menu**.
4. Highlight "clear memory" and press **OK/menu**.
5. Homebase will clear all data and restart.

NOTE: If a memory card is still installed, then auto slide show will resume; if no memory card is installed, then homebase screen will be displayed.

How can I restore homebase to its factory settings?

1. Press **OK/menu** and the main "menu" will pop up.
2. Highlight "settings" and press **OK/menu**.
3. Highlight "general setup" and press **OK/menu**.
4. Highlight "default" and press **OK/menu**. Previous menu will pop up.
5. Highlight "yes" and press **OK/menu**.
6. Highlight "back" and press **OK/menu**.
7. Highlight "exit" and press **OK/menu** to go back home.

How do I set the time?

1. Press **OK/menu** and the main "menu" will pop up.
2. Highlight "settings" and press **OK/menu**.
3. Highlight "time/date setup" and press **OK/menu**.

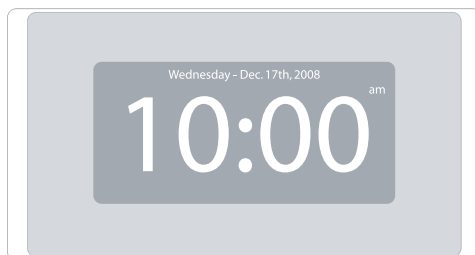

4. The time/date display appears with the hour digits flashing. Use the up and down arrows to set the hour and press **OK/menu**. Repeat for minutes, and press **OK/menu**.
5. Repeat once more for AM/PM indication, and press **OK/menu**.
6. Above the time is the date line. The month is now flashing. Use the up and down arrows to select the month, and press **OK/menu**.

homebase™

GENERAL SETTINGS (cont'd)

7. Repeat to select the numerical day of the month, and press **OK/menu**.
Note: When this is done correctly, the clock will automatically select the proper day name for the date entered.
8. The year is now flashing. Use the up and down arrows to select the proper year, and then press **OK/menu**.
9. Time and date setup is now complete, and the screen will return to the "settings" menu automatically.
10. Highlight "exit" and press **OK/menu** to go back home.

How do I set the alarm?

1. Press **OK/menu** and the main "menu" will pop up.
2. Highlight "settings" and press **OK/menu**.
3. Highlight "alarm" and press **OK/menu**.
4. Highlight "alarm set" and press **OK/menu**.

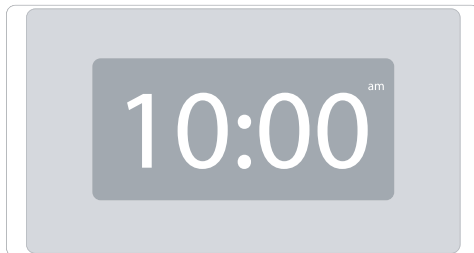

5. A clock is displayed with the hours flashing. Use the up and down arrows to select the desired hour, and then press **OK/menu**. Repeat for minutes, and press **OK/menu**.
6. Repeat again for AM/PM indication, and then press **OK/menu**.

homebase™

GENERAL SETTINGS (cont'd)

Now, what do you want to do?

To turn alarm on...

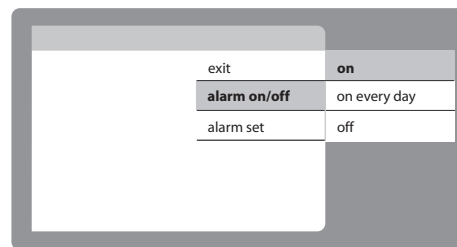
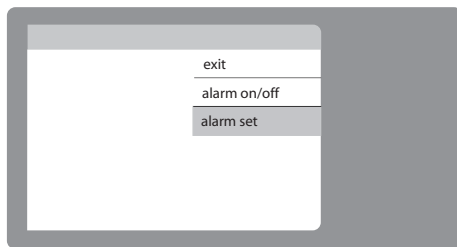

1. Highlight "alarm on/off" and press **OK/menu**.
2. You can now set an alarm for today only by highlighting "on" and pressing **OK/menu** or you can set the alarm to activate everyday at this time by highlighting "on everyday" and pressing **OK/menu**.

To turn alarm off...

1. Highlight "alarm on/off" and press **OK/menu**.
2. Highlight "off" and press **OK/menu**.
3. Highlight "back" and press **OK/menu**.
4. Highlight "exit" and press **OK/menu** to go back home.

NOTE: If the alarm is set correctly, a small clock icon will appear on all time display screens.

homebase™

GENERAL SETTINGS (cont'd)

How do I change where the time is displayed?

1. Press **OK/menu** and the main "menu" pops up.
2. Highlight "settings" and press **OK/menu**.
3. Highlight "clock display" and press **OK/menu**.

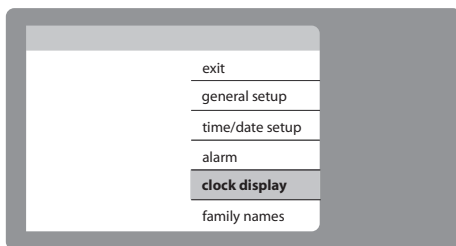

4. Highlight desired position from list ("off", "screen bottom edge", "large centered" and "split screen"), and then press **OK/menu**.

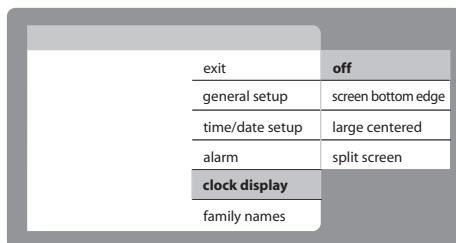

Clock icon displayed on bottom of screen

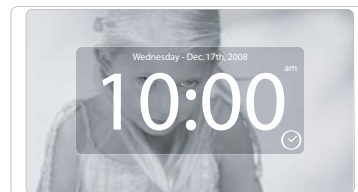

Clock icon displayed in center of screen

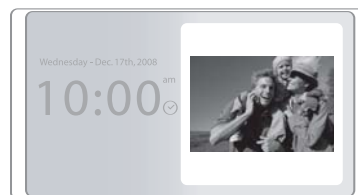

Clock icon displayed at left in split screen configuration

homebase™

GENERAL SETTINGS (cont'd)

How do I select my language?

1. Press **OK/menu** and the main "menu" pops up.
2. Highlight "settings" and press **OK/menu**.
3. Highlight "general setup" and press **OK/menu**.
4. Highlight "language select" and press **OK/menu**.
5. Highlight "english" or "french" and press **OK/menu**.
6. Press **OK/menu**

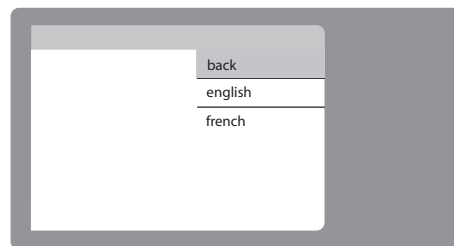
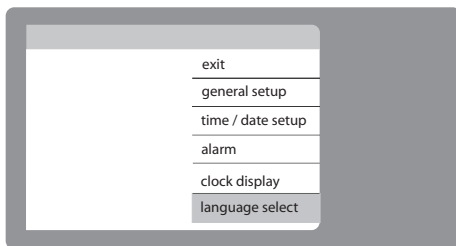

homebase™

TECHNICAL DATA

Specifications

- | | |
|-------------------------------|--------------------------------------------------------------------------------------------------------------------------|
| • Digital Picture Frame | 7" LCD |
| • Aspect Ratio | 16:9 |
| • Resolution: | 480 x 234 pixels |
| • Internal Flash Memory | 1 GB |
| • USB Connector | Provides interface for external USB memory device |
| • SD/MMC/MS/xD Card Slot | Provides interface for memory device |
| • CF Connector | Provides interface for CF memory device |
| • Date/Time | Digital Calendar and Clock Feature |
| • Video Messages | Internal camera for video recording |
| • Voice Messages | Internal microphone for digital audio recording |
| • Audio Output | Internal speakers (2) with separate volume control |
| • Menu Navigation | 3 keys |
| • Message Indicator | Orange LED |
| • Reminder Function | The memo LED will light when there is an unheard voice or video memo or an activated calendar voice or video memo |
| • Memory Backup for the Clock | Internal backup battery data Infoetc. Battery type CR2032 |
| • Image File Type Handling | JPEG |

homebase™

NOTES

DPF711K

41

homebase™

NOTES

homebase™



90 DAY LIMITED WARRANTY *Applies to Audiovox Video Products*

AUDIOVOX ELECTRONICS CORP. (the Company) warrants to the original retail purchaser of this product that should this product or any part thereof, under normal use and conditions, be proven defective in material or workmanship within ninety (90) days from the date of original purchase, such defect(s) will be repaired or replaced with reconditioned product (at the Company's option) without charge for parts and repair labor. A game controller, if supplied, is similarly warranted for ninety (90) days.

To obtain repair or replacement within the terms of this Warranty, the product is to be delivered with proof of warranty coverage (e.g. dated bill of sale), specification of defect(s), transportation prepaid, to the Company at the address shown below.

This Warranty does not extend to the elimination of externally generated static or noise, to correction of antenna problems, to costs incurred for installation, removal or reinstallation of the product, or to damage to digital memory/media devices, gaming devices, discs, speakers, accessories, or electrical systems.

This Warranty does not apply to any product or part thereof which, in the opinion of the Company, has suffered or been damaged through alteration, improper installation, mishandling, misuse, neglect, accident, or by removal or defacement of the factory serial number/bar code label(s). THE EXTENT OF THE COMPANY'S LIABILITY UNDER THIS WARRANTY IS LIMITED TO THE REPAIR OR REPLACEMENT PROVIDED ABOVE AND, IN NO EVENT, SHALL THE COMPANY'S LIABILITY EXCEED THE PURCHASE PRICE PAID BY PURCHASER FOR THE PRODUCT.

This Warranty is in lieu of all other express warranties or liabilities. ANY IMPLIED WARRANTIES, INCLUDING ANY IMPLIED WARRANTY OF MERCHANTABILITY, SHALL BE LIMITED TO THE DURATION OF THIS WRITTEN WARRANTY. ANY ACTION FOR BREACH OF ANY WARRANTY HEREUNDER INCLUDING ANY IMPLIED WARRANTY OF MERCHANTABILITY MUST BE BROUGHT WITHIN A PERIOD OF 12 MONTHS FROM DATE OF ORIGINAL PURCHASE. IN NO CASE SHALL THE COMPANY BE LIABLE FOR ANY CONSEQUENTIAL OR INCIDENTAL DAMAGES FOR BREACH OF THIS OR ANY OTHER WARRANTY. No person or representative is authorized to assume for the Company any liability other than expressed herein in connection with the sale of this product.

Some states do not allow limitations on how long an implied warranty lasts or the exclusion or limitation of incidental or consequential damage so the above limitations or exclusions may not apply to you. This Warranty gives you specific legal rights and you may also have other rights which vary from state to state

Audiovox Electronics Corporation, 150 Marcus Blvd., Hauppauge, New York 11788 • 1-800-645-4994

128-5556G

DPF711K

43

Audiovox Electronics Corp.
150 Marcus Boulevard
Hauppauge, NY 11788

128-8270

DPF711K

Free Manuals Download Website

<http://myh66.com>

<http://usermanuals.us>

<http://www.somanuals.com>

<http://www.4manuals.cc>

<http://www.manual-lib.com>

<http://www.404manual.com>

<http://www.luxmanual.com>

<http://aubethermostatmanual.com>

Golf course search by state

<http://golfingnear.com>

Email search by domain

<http://emailbydomain.com>

Auto manuals search

<http://auto.somanuals.com>

TV manuals search

<http://tv.somanuals.com>