

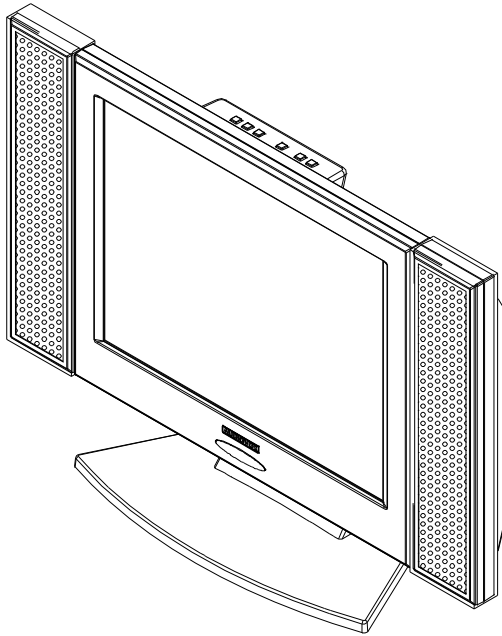

AUDIOVOX[®]
ELECTRONICS CORP.

15" LCD TV Operating Instructions

Model No. FP1520



For assistance, please call: 1-800-645-4994
Or visit us at WWW.AUDIOVOX.COM

Before connecting, operating or adjusting this product, please read these instructions completely. Please keep this manual for future reference



For Customer Service
Visit Our Website At
www.audiovox.com
Product Information, Photos,
FAQ's, Owner's Manuals

128-6777

Important Safety Instructions:

Read Instructions

All the safety and operating instructions should be read before the product is operated.

Retain Instructions

The safety and operating instructions should be retained for future references.

Heed Warnings

All Warnings on the product and in the operation instructions should be adhered to.

Follow Instructions

All Operating and user instructions should be followed.

Cleaning

Unplug this product from the wall outlet before cleaning. DO NOT use liquid cleaners or aerosol cleaners. Use damp Cloth for cleaning.

Attachments

DO NOT use attachments not recommend by the product manufacturer they may cause hazards.

Mounting

DO NOT place this product on an unstable cart, stand, tripod, bracket, or table. The product may fall, causing serious injury to a child or adult, and serious damage to the product. Use only with a cart, stand, tripod, bracket, or table recommended by the manufacturer or sold with the product. Any mounting of this product should follow the manufacture's instructions, and should use a mounting accessory recommended by the manufacturer.

Heat

The Product should be situated away from heat source such as radiators, heat registers, stoves or other products (including amplifiers) that produce heat.

Water

DO NOT use this product near water. For example: Avoid placing it near bathtub, washbowl, kitchen sink, or laundry tub, in a wet basement, or near a swimming pool, ETC;k

Cabinet Slots

NEVER push objects or any kind into the unit through the cabinet slots as they may touch dangerous voltage points or short out parts that could result in a fire or electric shock. NEVER spill liquid of any kind on the product.

Ventilation

DO NOT block any ventilation openings. Install in accordance with manufacture's instructions. Slots and openings in the cabinet and the back and bottom are provided for ventilation, and to ensure reliable operation of the product and to protect it from Overheating. These openings must NOT be blocked or covered. There should be at least 10cm of space from these openings. The openings should never be blocked by placing the unit on a bed, rug or other similar surface. This product should NOT be placed in a built-in installation such as a bookcase unless proper ventilation is provided.

Important Safety Instructions Continued

Grounding or Polarization

This product may be equipped with a polarized alternating current line plug (a plug having one blade wider than the other). This plug will fit the power outlet only one way. This is a safety feature. If you are unable to insert the plug fully into the outlet, try reversing the plug. If the plug should still fail to fit, contact your electrician to replace your obsolete outlet. DO NOT defeat the safety purpose of the polarized plug.

Power - Cord Protection

Power supply cords should be routed so that they are not likely to be walked on or pinched by items placed upon or against them. Pay particular attention to cords at plugs, convenience receptacles, and the point where they exit from the product.

Power Sources

This product should be operated only from the type of power source indicated on the rear panel. If you are not sure of the type of power supply to your home consult your product dealer or local power company.

Lightning

For added protection for this product during a lightning storm, or when it is left unattended and unused for a long period of time, unplug it from the outlet and disconnect the antenna or cable system. This will prevent damage to the product due to lightning and power-line surges.

Power Lines

An outside antenna system should not be located in the vicinity of overhead power lines or other electric light or power circuits, or where it can fall into such power lines or circuits. When installing an outside antenna system, extreme care should be taken to keep from touching such power lines or circuits, as contact with them might be fatal.

Overload

DO NOT overload wall outlets, extension cords or integral convenience receptacles as this can result in a risk of fire or electric shock.

Damages Requiring Service

Unplug this product from the wall outlet and refer servicing to qualified service personnel under the following conditions.

- ⚠ When the power-supply cord or plug is damaged.
- ⚠ If liquid has been spilled, or objects have fallen into the product.
- ⚠ If the product has been exposed to rain or water.
- ⚠ If the product does not operate normally after following the operating instructions. Adjust only those controls that are covered by the operating instructions as an improper adjustment of other controls may result in damage and will often require extensive work by a qualified technician to restore the product to its normal operation.
- ⚠ If the product has been dropped or damaged in any way.
- ⚠ When the product exhibits a distinct change in performance - this indicates a need for service.

Important Safety Instructions Continued

Replacement parts

When replacement parts are required, be sure the service technician has used replacement parts specified by the manufacturer or have the same characteristics as the original part. UNAUTHORIZED substitution may result in fire, electric shock or other hazards.

Safety Check

Upon completion of any service or repair to this product, ask the service technician to perform safety checks to determine that the product is in proper operating condition.

CAUTION

Danger of explosion if remote battery is incorrectly replaced. Replace only with the same or equivalent type.

Storage

Store LCD TV in a dark room at room temperature and low humidity in the original packing condition, to avoid condensation that may cause failure.

Handling

Since the LCD TV consists of glass and precise electronic components, it will be damaged by excessive shock or drop. Please handle the LCD TV carefully to minimize shock during transportation.

Important Information Regarding Use of Video Games, Computer, Captions or other Fixed Image Displays.

The Extended use of a fixed image program material can cause permanent "Shadow Image" on the LCD Panel. The Background image is viewable on normal programs in the form of stationary fixed image. This type of irreversible LCD panel deterioration can be limited by observing the following steps:

Reduce the brightness/contrast setting to a minimum viewing level.

DO NOT display the fixed image for extended periods of time.

Turn the power off when not in actual use.

Recycling

This product utilizes tin-lead solder, and has a fluorescent lamp containing a small amount of mercury. Disposal of these materials may be regulated in your community due to environmental considerations. For disposal or recycling information please contact you local authorities, or the Electronics Industries Alliance: <http://www.eiae.org/>

Important Safety Instructions Continued

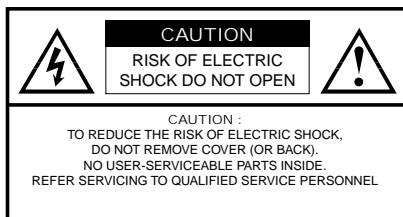

The Lightning flash with the arrowhead symbol within an equilateral triangle is intended to alert the user to the presence of uninsulated "DANGEROUS VOLTAGE" within the product's enclosure that may be of sufficient magnitude to constitute a risk or electric shock to persons.



The Exclamation point within an equilateral triangle is intended to alert the user to the presence of important operating and maintenance (servicing instructions in the literature accompanying the product).

Federal Communication Commission Information (FCC)

This Equipment has been tested and found to comply with the limits for a TV Broadcast Receiver, pursuant to Part 15 of the FCC Rules. These limits are designed to provide reasonable protection against harmful interference in a residential installation. This equipment generates, uses and can radiate radio frequency energy and, if not installed and used in accordance with the instructions, may cause harmful interference to radio communications. If this equipment does cause or receive interference, which can be determined by turning equipment off and on, the user is encouraged to try to correct the interference by one of the following measures:

- ▣ Reorient or relocate the TV antenna
- ▣ Increase the separation between TV and other equipment.
- ▣ Connect TV into separate outlet from equipment.
- ▣ Consult the dealer or an experienced radio/TV technician for help

FCC Caution: Any changes or modifications not expressly approved by the party responsible for compliance could void the user's authority to operate this equipment

CONTENTS

1. INTRODUCTION

Important Safety Instructions -----01-04

Product Description -----06

Product Features -----07

Package Contents -----08

2. SYSTEM SETUP

Top Panel & Remote Controller Function -----09-12

Assembly and Connections -----13

Input/Output Signal Connections -----14-17

3. FP1520 OPERATING INSTRUCTIONS

TV and AV Manual Operating Instructions -----18-31

Using the FP1520 as a Computer Monitor -----32-37

4. REFERENCE

Display Modes -----38

LCD Monitor Display Angle -----38

5. APPENDIX

Troubleshooting -----39-43

Specification -----44

1. INTRODUCTION

Product Description

Thank you for choosing the AUDIOVOX FP1520 TFT-LCD Color TV/Monitor and for your continued support and use of our products.

The FP1520 combines the features of a TV/MONITOR with a THIN FILM TRANSISTOR liquid crystal display (TFT-LCD).

This new generation of TFT-LCD incorporates a high quality display in a light weight module.

As such the unit has power-saving capabilities and emits no X-ray radiation. There are many benefits from this TFT-LCD namely comfort, safety, and environmental protection.

The FP1520 features a 15" color-active matrix, Thin-Film-Transistor (TFT) Liquid Crystal Display (LCD) to provide superior display performance. A maximum resolution of 1024x768 is ideal for displaying complex graphics and high definition images from your computer. Other outstanding features include freedom from video oscillations and selection of various choices of digital video and audio signal inputs.

You will get the feeling that the large-sized surface of operation with the Video - On - Video (VOV) feature, together with the high-quality 3D stereo speakers and remote high-level amplifiers connections, provides a coherent, top-of-the-line Audio and Video systems for viewing pleasure.

In addition the TFT-LCD display allows "Plug & Play" connection to your PC and has a built-in On Screen Display (OSD) functions that can operate from the convenience of a remote control.

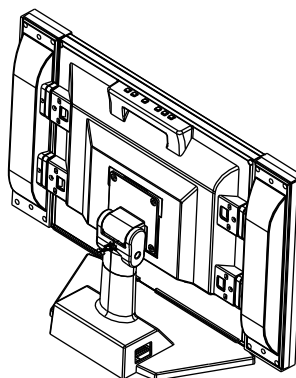
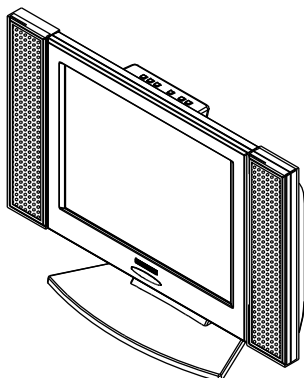
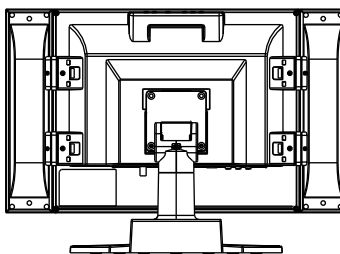
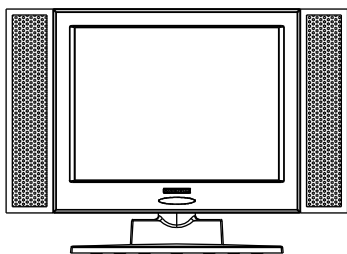

Product Features

- TFT-LCD screen connected with Computer support DDC1/2B for "Plug & Play" compatibility.
- 15-Inch high-resolution LCD Monitor which supports XGA 1024x768 resolution.
- Super 2,359,296 high-resolution pixels to enhance TFT-LCD definition.
- Super 450cd/m² high-brightness for picture enjoyment.
- Super wide viewing angle : Horizontal : 130° , Vertical : 120° .
- Super-low power consumption ; 50% more power saving than conventional TV.
- Super 9300° color temperature for LCD monitor choice of color.
- Internal subtitle decode function to precisely display multi-language capability
- CATV full-frequency channel receive capability
- AV-terminal input and S-Video inputs for high-quality pictures.
- 3D Stereo for realistic acoustics.
- Slim space-saving feature of up to 70% compared with a normal CRT monitor.
- Light design reduces weight by 15% compared with traditional TV monitor.
- High contrast ratio of 500 : 1 provides optimum clear image.
- Multi-digital input terminal provides a host of video and audio choices.
- Supports Video-On-Video ; VOV can display multiple video sources at one time.
- Intelligent screen image setting
Intelligent Window Control Surface to simplify function settings.
- Built-in wall mounting ; Detachable stand enhances wall-mounting application.

Package Contents

Please check the FP1520 Package to make sure it contains the following items :

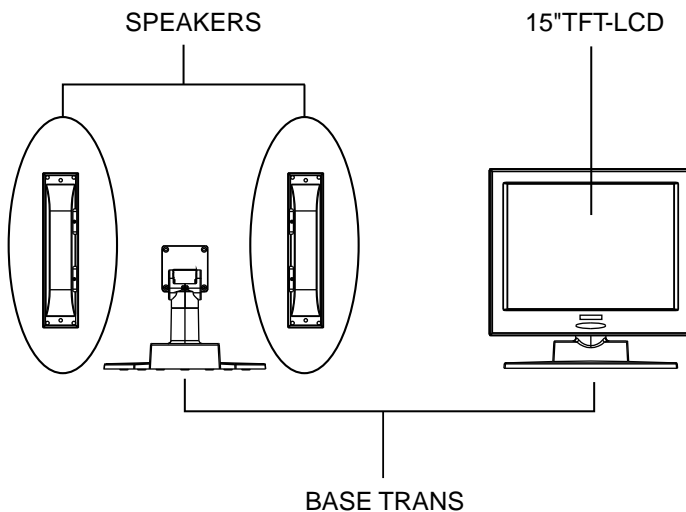

Slim-type
Remote Control

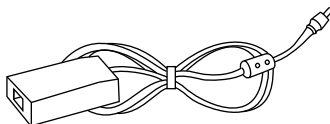

Power Transformer Cord
(Mounted in base from the factory)

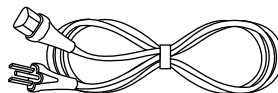

Power Cord

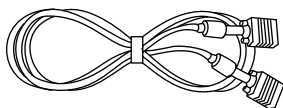

VGA Cable

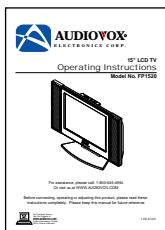

User Manual

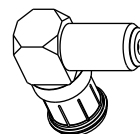

Right-angle adapter

2. SYSTEM SETUP

Top Panel & Remote Control Function

TOP PANEL :

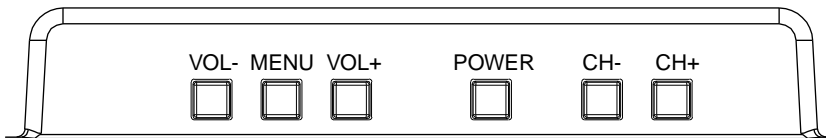



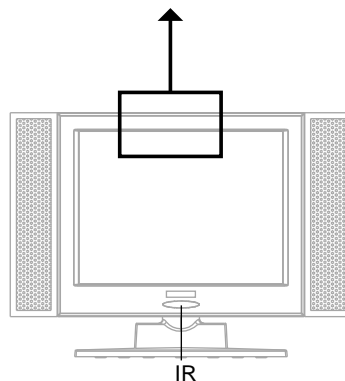



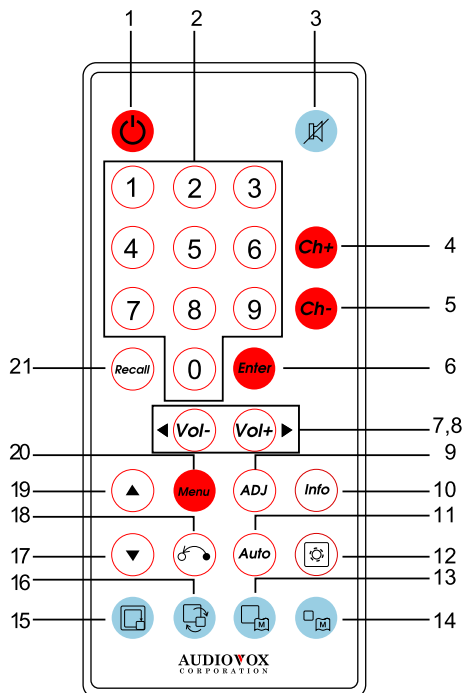







- VOL - : Volume down Button : decreases volume
- MENU : Menu Button : Selects command function
- VOL + : Volume up Button : Increases volume
- POWER : Power Button : Power on/off control
- CH - : Channel down Button : Decreases setting channel
- CH + : Channel up Button : Increases setting channel
- IR : Remote IR detect window : Receives IR signal from remote control



Remote Control Unit :



Remote Control Buttons :

- | | |
|--|---|
| <p>1  POWER
To turn Power On/Off</p> | <p>11  AUTO
Scans signal channels TV and CATV</p> |
| <p>2  KEYPAD
Press number key to select channel of TV</p> | <p>12  OSD Display
Chooses on-screen subtitle color, including yellow, blue, white and black</p> |
| <p>3  MUTE
Turns volume off</p> | <p>13  Main Disp Switch
Chooses Main Display for AV, SV,CATV,TV,PC</p> |
| <p>4  CH+
Increases TV channel setting</p> | <p>14  Sub Disp Switch
Chooses Sub Display for AV, SV,CATV,TV</p> |
| <p>5  CH-
Decreases TV channel setting</p> | <p>15  Sub Disp Move
Press to show VOV,sub picture and shift its position to one of four viewing angles in TV</p> |
| <p>6  ENTER
Enters command keypad functions</p> | <p>16  VOV Swap
Switches Video-On-Video in the TV window</p> |
| <p>7  VOL-
Decreases volume setting</p> | <p>17  BACKWARD
Selects next menu item</p> |
| <p>8  VOL+
Increases volume setting</p> | <p>18  CANCEL
Cancels OSD</p> |
| <p>9  ADJ
Adjusts the saturation, hue, brightness and contrast functions</p> | <p>19  FORWARD
Selects previous menu item</p> |
| <p>10  INFO
Displays the signal source of the current channel</p> | <p>20  Menu
Displays the main menu on screen</p> |
| | <p>21  RECALL
Recalls the last channel viewed</p> |

Remote Control Battery Installation/Removal :

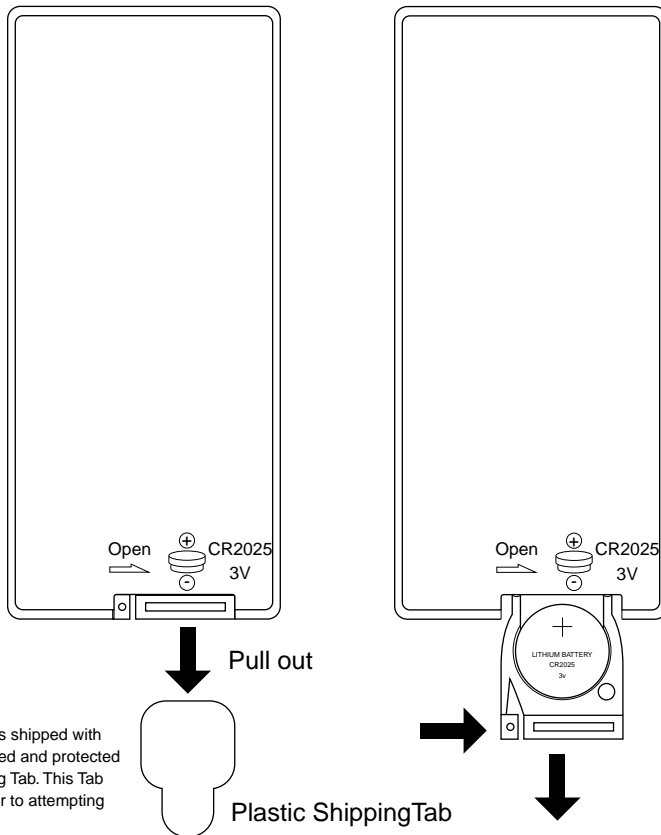

IMPORTANT !!
The Remote Control is shipped with the Battery pre-installed and protected with a Plastic Shipping Tab. This Tab must be removed prior to attempting to operate the unit.

Change the Battery if the Remote Control no longer operates the FP1520.



Caution :
Only use CR2025 type Battery.
Confirm the polarity(+/-) of battery before installing
Removal the battery if the Remote Control is not to be used for a long time.

Remote Control Operating Instruction:

The Remote Control Transmission consists of an Infrared (IR) Signal.

Make sure the line-of-sight between Remote Control and FP1520 is clear of objects that could interfere with the remote IR signal. Always point the Remote Control directly at the FP1520 sensor.

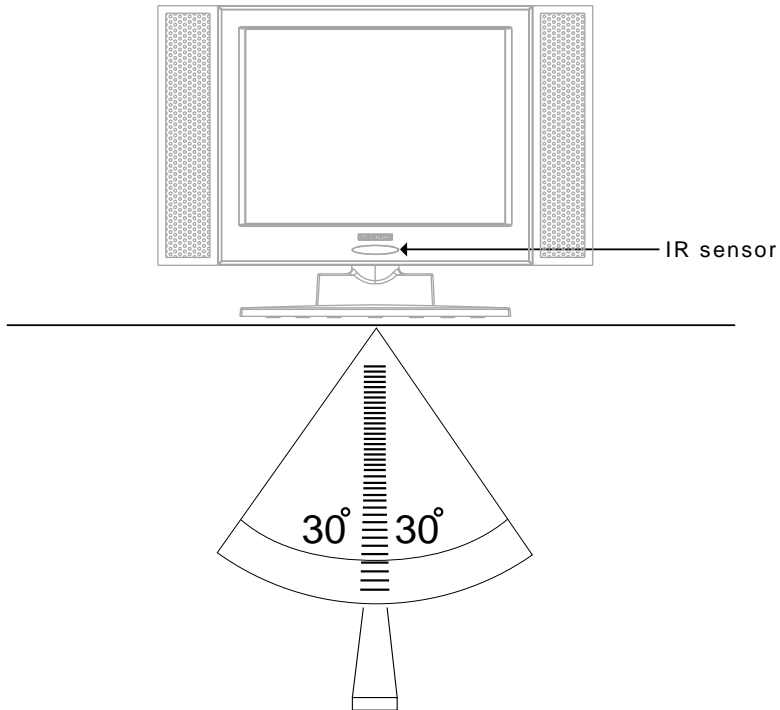

CAUTION !!

Avoid damaging the Remote Control by :

- Applying excessive pressure when pressing buttons
- Exposing to extreme Low or High temperatures
- Exposing to excessive Moisture
- Mishandling to Dropping

Assembly and Connection

The Speakers were premounted to the TV display in the factory prior to shipment. Locate the power cable in the accessory box and connect it to the base unit. Plug the other end of the power cable into the wall outlet.

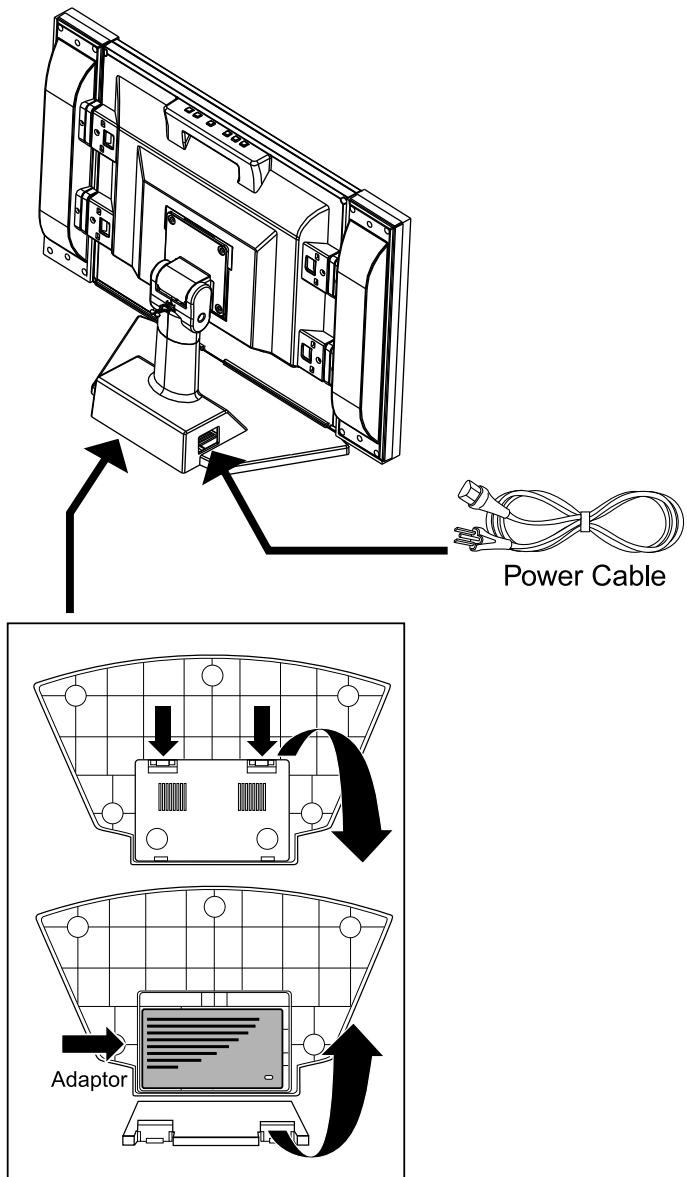

The adaptor is premounted in the base unit.

Input/Output Signal Connections

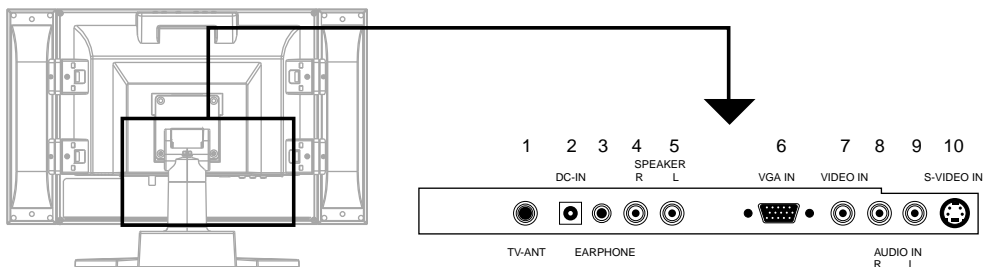

1. ANT. CABLE INPUT
2. POWER ADAPTER INPUT
3. EARPHONE OUTPUT
4. RIGHT SPEAKER OUTPUT
5. LEFT SPEAKER OUTPUT
6. VGA INPUT
7. A-VIDEO INPUT
8. RIGHT AUDIO INPUT
9. LEFT AUDIO INPUT
10. S-VIDEO INPUT

Connecting TV Cable

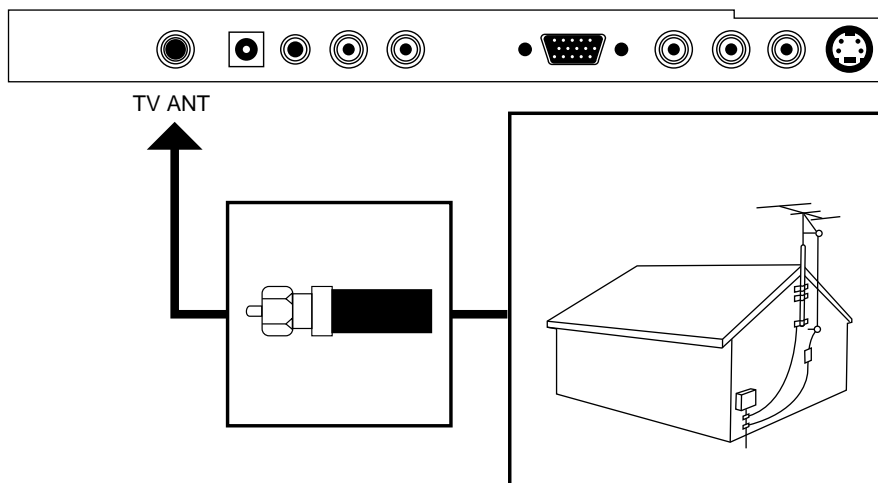

DC Power Socket



DC-IN

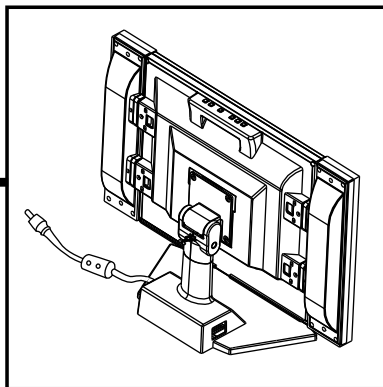

Connecting Left and Right Speakers

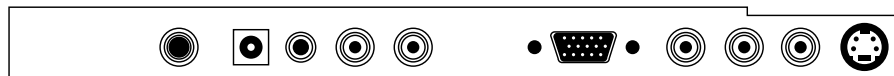

SPEAKER
R L

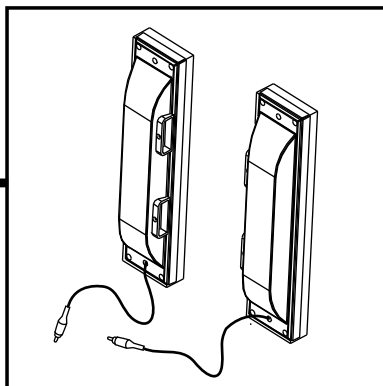

Connecting to S-video terminal equipment such as DVD, VCR or Gaming Console.

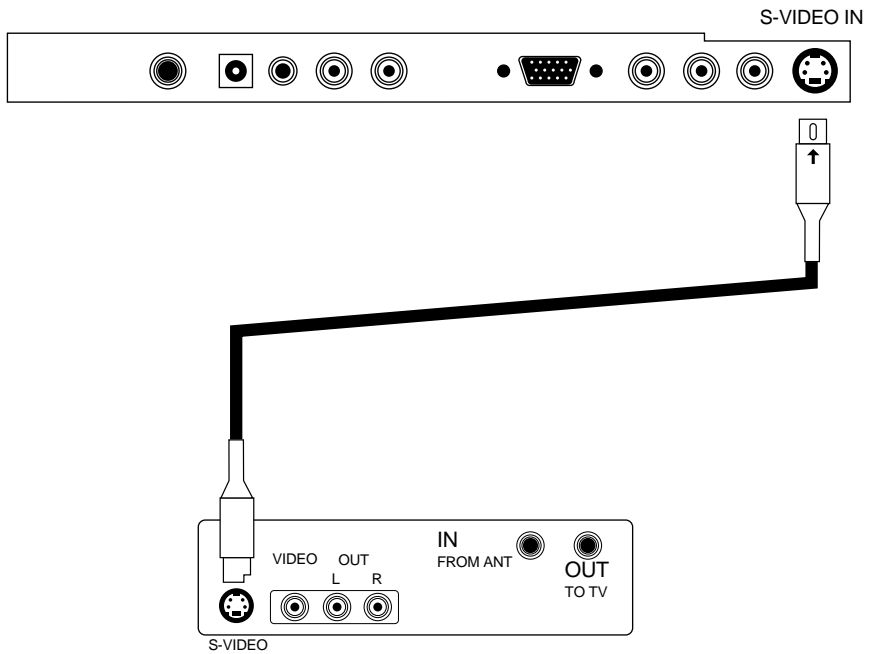

Connecting to 15-PIN VGA from a PC

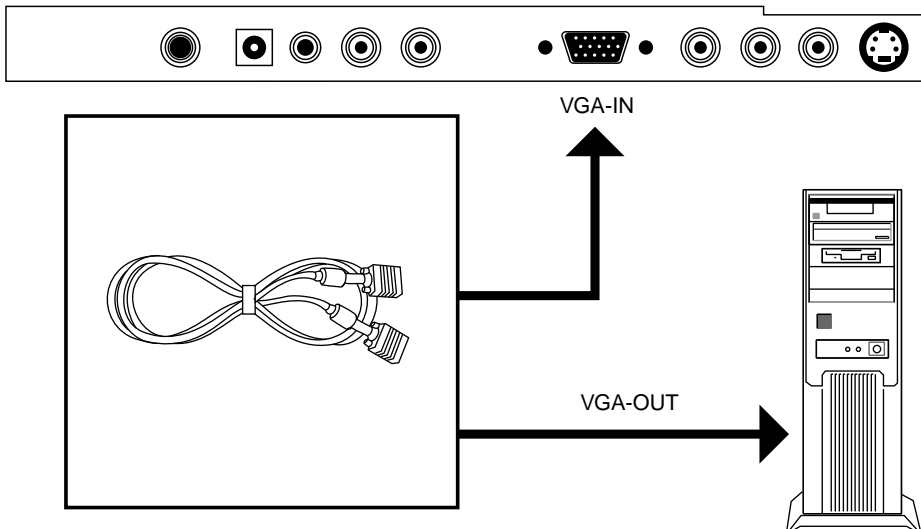

Connecting to AV-terminal equipment such as DVD, VCR, and Gaming Console.

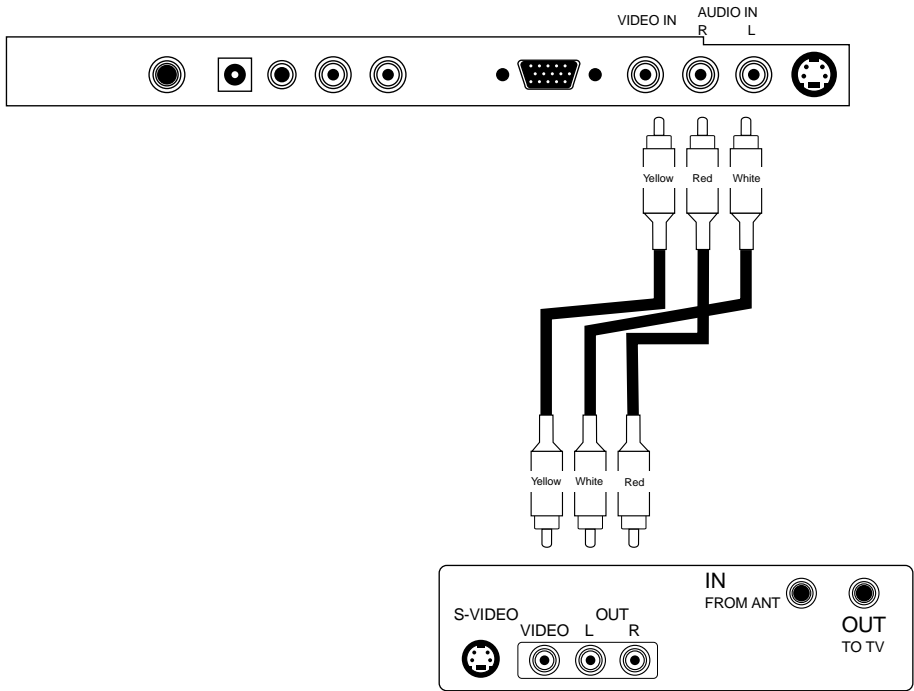

3.FP1520 OPERATING INSTRUCTIONS

TV and AV Operating Instructions

MAIN DISP

Press and release the Menu button to display the following Main Menu for TV and AV functions :

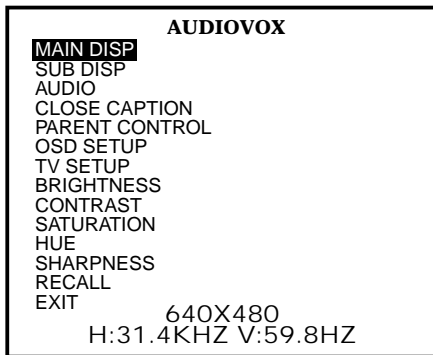

Press and release the Menu button again to access the MAIN DISP menu :

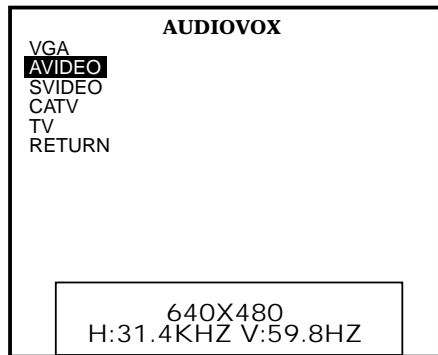

MAIN DISPLAY OPTIONS :

1. Main Display
2. Sub Display
3. Sound Option
4. Close Subtitle
5. Parent Control
6. On-Screen-Display(OSD) Option
7. TV Mode Option
8. Brightness
9. Contrast
10. Saturation
11. Hue
12. Sharpness
13. Recall
14. Exit

NOTE :
Screen Resolution
(Will vary)

INPUT SIGNAL SELECTIONS :

1. VGA-Computer Input Signal
2. AVIDEO-A-Video Input Signal
3. SVIDEO-S-Video Input Signal
4. CATV-Cable TV Input Signal
5. TV-TV Input Signal

RETURN to Previous Menu

SUB DISP (sub display)

SUB DISP has four signal inputs - AVIDEO, SVIDEO, CATV and TV. These inputs are used to connect to a DVD-Player, VCR etc.

1. AVIDEO (AV-Terminal)
2. SVIDEO (S-Terminal)
3. CATV
4. TV
5. Video-On-Video(VOV) OFF
6. RETURN

With the Main Menu displayed, Press and release the  button to highlight SUB DISP

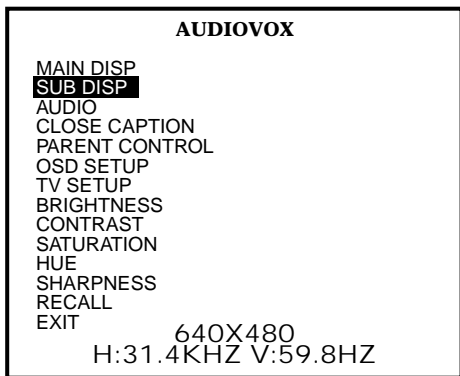

Press and release the MENU button to display the SUB DISP Menu :

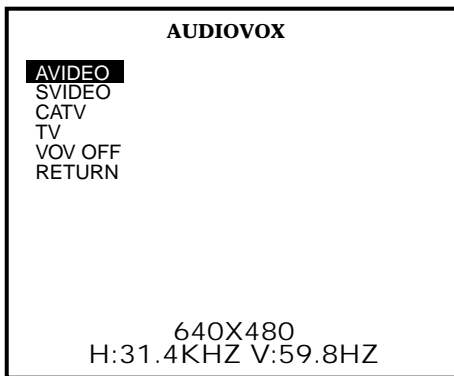

Press and release the  button to highlight AVIDEO. Then Press and release the Menu button to select AVIDEO for (Video-On-Video) viewing.

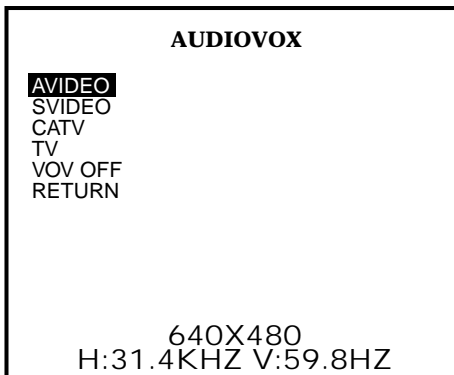

With the Main Menu displayed, use the

⏏ button to select VOV ADJUST

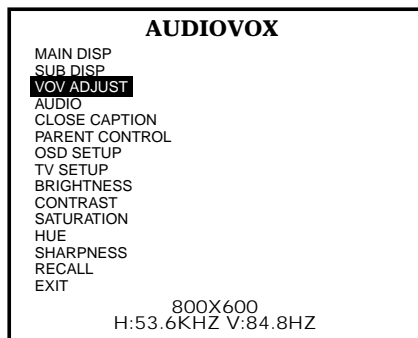

Then Press and release the Menu

button to select VOV adjustments :

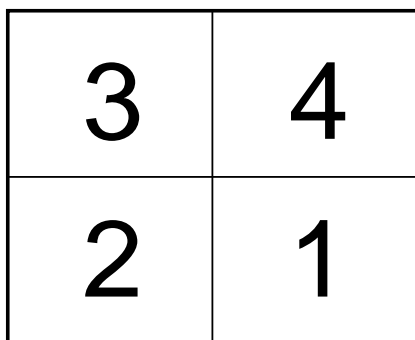
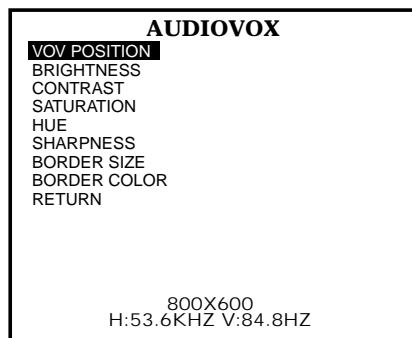

With the VOV POSITION Menu displayed,

use the ⏏ button to select the

VOV POSITION desired then Press Menu

to display

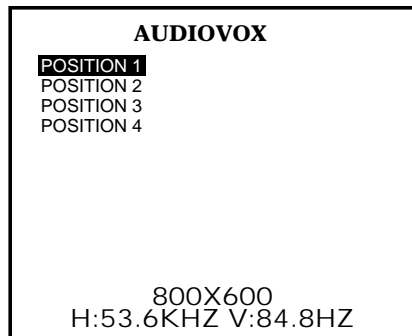

NOTE :

Position 1 - Bottom Right

Position 2 - Bottom Left

Position 3 - Upper Left

Position 4 - Upper Right

Press the ⏏ button to select

Position. Press and release the

Menu button to go back to the

previous Menu.

NOTE :

The following adjustments will effect the VOV only, not the Main display.

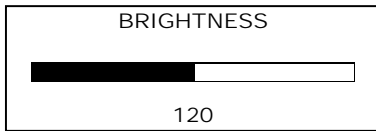
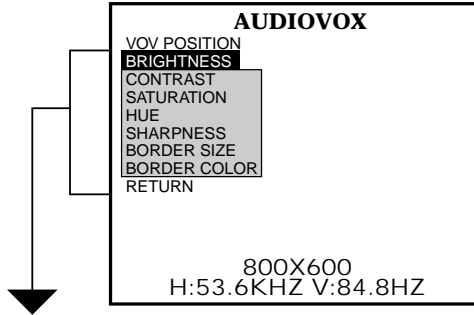

Press the (▲) (▼) button to adjust setting and then Press and release the Menu button to confirm and return to previous page.

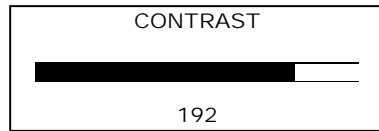

Press the (▲) (▼) button to adjust setting and then Press and release the Menu button to confirm and return to previous page.

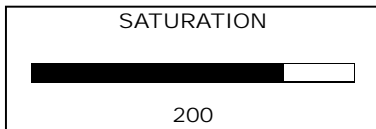

Press the (▲) (▼) button to adjust setting and then Press and release the Menu button to confirm and return to previous page.

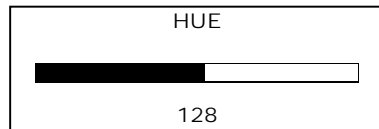

Press the (▲) (▼) button to adjust setting and then Press and release the Menu button to confirm and return to previous page.

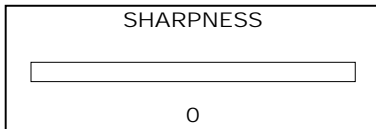

Press the (▲) (▼) button to adjust setting and then Press and release the Menu button to confirm and return to previous page.

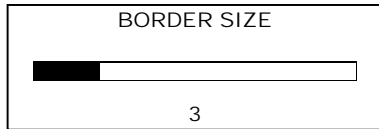

Press the (▲) (▼) button to adjust setting and then Press and release the Menu button to confirm and return to previous page.

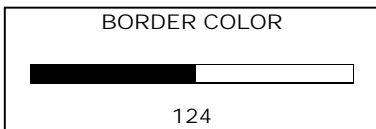

Press the (▲) (▼) button to adjust setting and then Press and release the Menu button to confirm and return to previous page.

AUDIO

Select the desired level of GAIN, BASS, TREBLE and LOUDNESS.

1. AUDIO CHANNEL - Choose Audio Input Source (A-Video, TV).
2. GAIN - Adjusts Audio Gain
3. BASS - Adjusts Bass
4. TREBLE - Adjusts Treble
5. LOUDNESS - On or Off
6. RETURN - Back to Main Menu Display

Access the Main Menu and highlight AUDIO then press and release the Menu button to select.

NOTE :

Use the ▲ and ▼ to move between the options, also use the ▲ and ▼ to adjust progress bar.

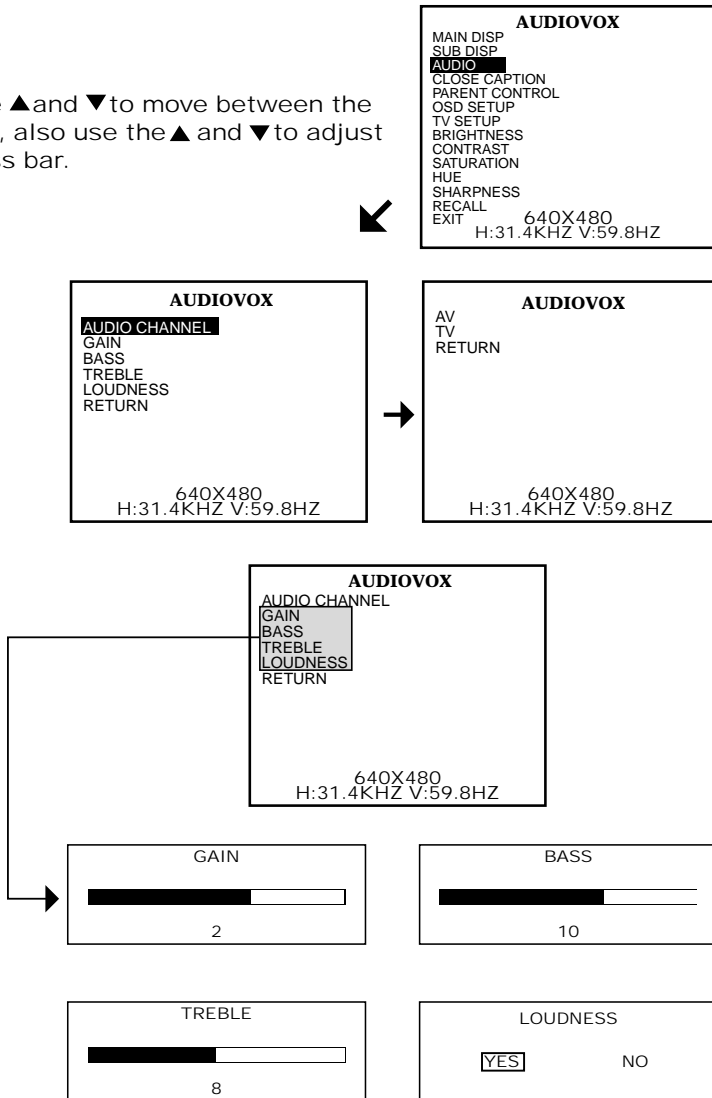

CLOSE CAPTION

The caption can display the spoken audio content of picture.

1. CAPTION - You can choose to show the caption or not.
2. DISPLAY :
 - a. BOX - You can choose to box the caption.
 - b. SHADOW - You can choose to show the caption in shadow (not boxed) format.
3. RETURN - Back to main menu display

NOTE :

Not all channels display CLOSE CAPTION.

With the Main Menu displayed, Press and release the  button to highlight CLOSE CAPTION

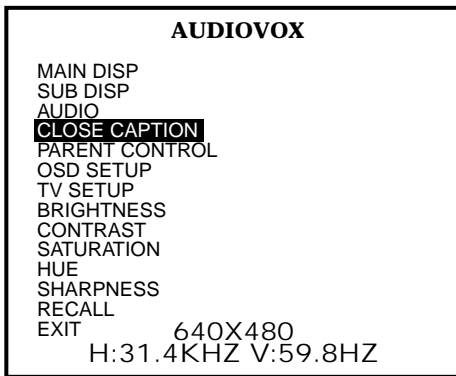

Press and release the Menu button to display the CAPTION Menu.

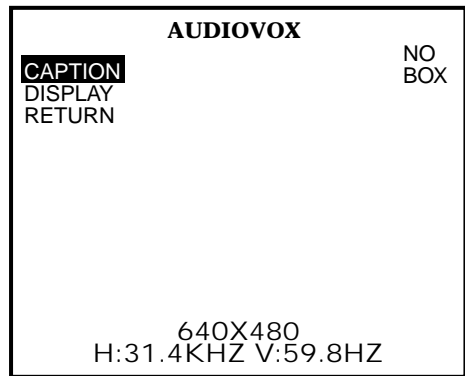

Press and release the Menu button to select CAPTION(1-4)and text (1-4) options.

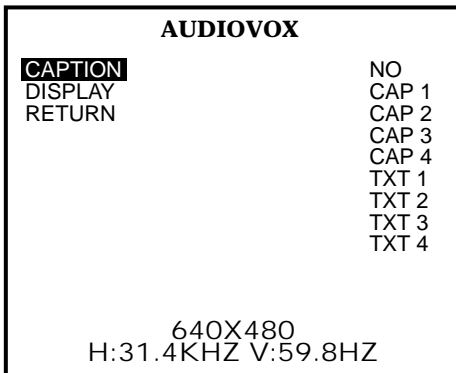

Press and release the Menu button to select DISPLAY.

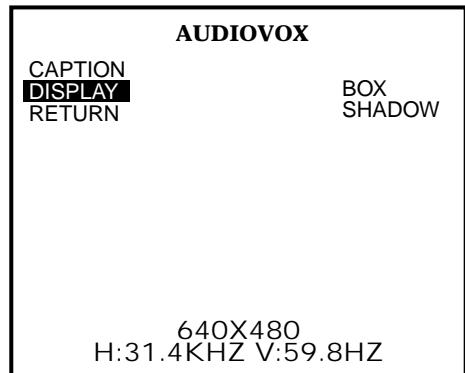

PARENT CONTROL

With the Main Menu displayed,
Press and release the  button
to highlight PARENT CONTROL :

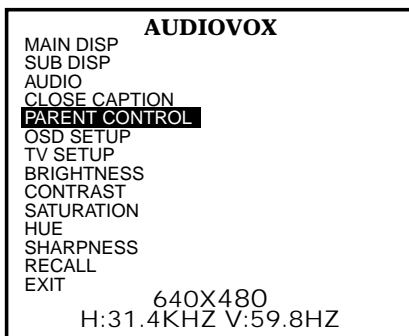

Input the four-digit Parent Control Password
and confirm using the Menu button
(Default Code is 3308)

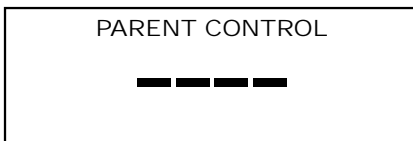

After entering the Password, the following
menu will appear :

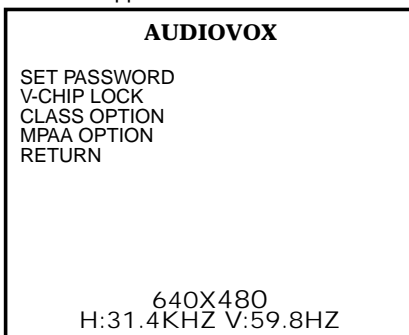

After accessing the Parent Control Menu,
highlight SET PASSWORD and Press and
release the Menu button.
Then enter a 4-digit Password to change
the Parental Control Menu Password.

PARENT CONTROL (continued)

From the PARENT CONTROL Main Menu.

Press and release the  button to highlight V-CHIP lock then Press and release the Menu button :

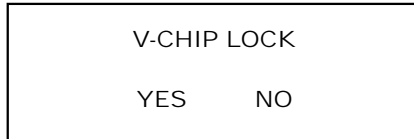

Enable the V-CHIP lock function by Selecting YES and disable by selecting NO.

From the PANRENT CONTROL Main Menu.

Press and release the  button to highlight CLASS OPTION on Main Parental Control Menu :

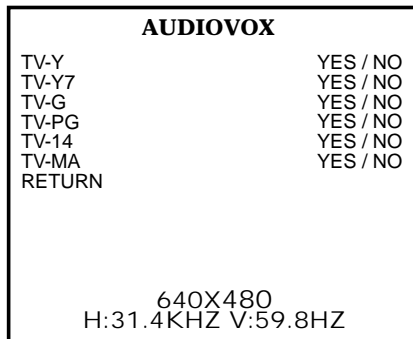

Select the desired age class and Press and release the Menu button.

Select RETURN to go back to the Parental Control Main Menu.

PARENT CONTROL (continued)

PARENTAL CONTROL RATINGS

From the PARENT CONTROL Main Menu.
Press and release the  button to
highlight MPAA OPTION and
press menu :

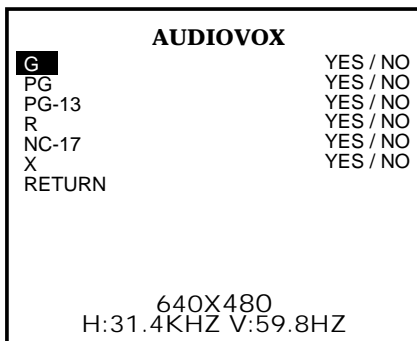

Select the desired rating level and press Menu.
Select RETURN to return to the main parental
control menu.

CLASS OPTION

- | | |
|----------|-----------|
| a. TV-Y | e. TV-14 |
| b. TV-Y7 | f. TV-MA |
| c. TV-G | g. Return |
| d. TV-PG | |

MPAA OPTION

- | | |
|----------|-----------|
| a. G | e. NC-17 |
| b. PG | f. X |
| c. PG-13 | g. RETURN |
| d. R | |

ON SCREEN DISPLAY(OSD) SETUP :

With the Main Menu displayed, Press and release the  button to highlight OSD SETUP

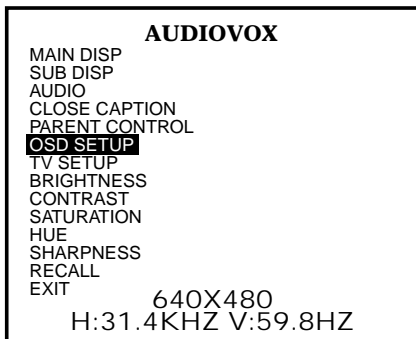

Press and release the Menu button to select LANGUAGE, OSD COLOR or OSD TIMER

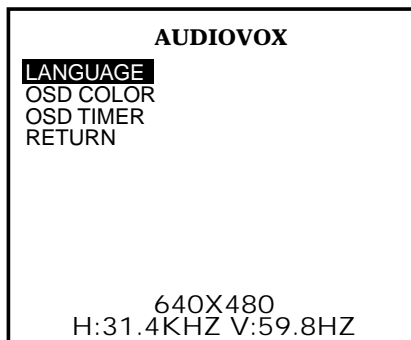

OSD LANGUAGE :

Using the  button, select the desired LANGUAGE

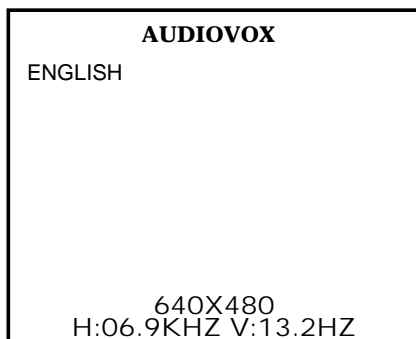

OSD COLOR :

Using the  button, select the desired OSD Message Color then Press and release the Menu button to confirm

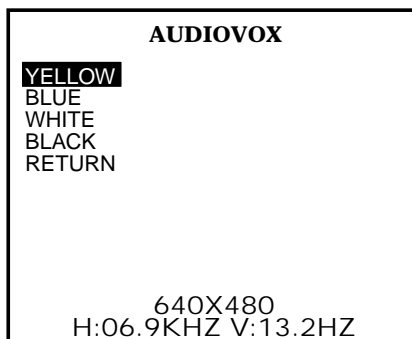

OSD TIMER :

Using the  button, select the amount of time you would like the OSD Message to be viewed (5,10,15 seconds) then Press and release the Menu button to confirm

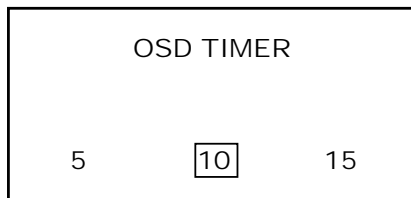

With the MAIN MENU displayed,
Select TV SETUP using the Menu
button :

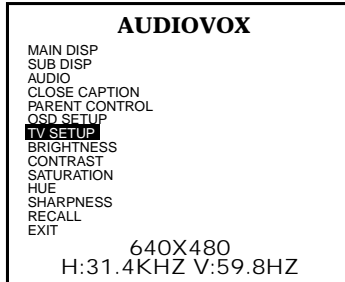

Select TV SETUP and highlight ERASE/
ADD then Press and release the Menu
button.

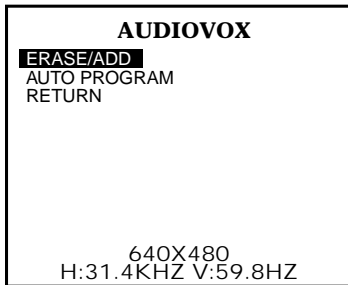

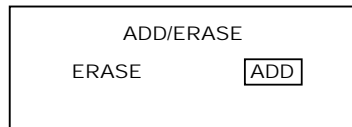

Using the  button, select ERASE or
ADD then Press and release the Menu
button to confirm.

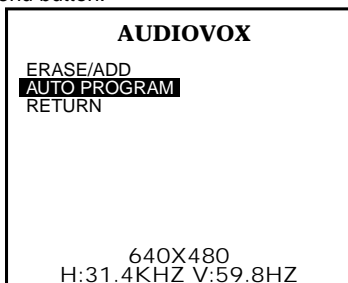

NOTE : This function can ERASE or ADD
the present display's channel.

Select TV SETUP and highlight AUTO
PROGRAM then Press and release the
Menu button.



Using the  button, select YES or NO.
(No need to press Menu button, The
Autoprogram will Autostart).

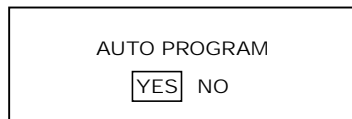

NOTE :
Users need to perform Auto Program
when the source is first connected to
the tuner module to ensure every
Channel is stored in the TV's memory.

With the MAIN MENU displayed, select BRIGHTNESS, CONTRAST, SATURATION, HUE or SHARPNESS then Press and release the Menu button to confirm. The following screen(s) will be displayed (see screens below)

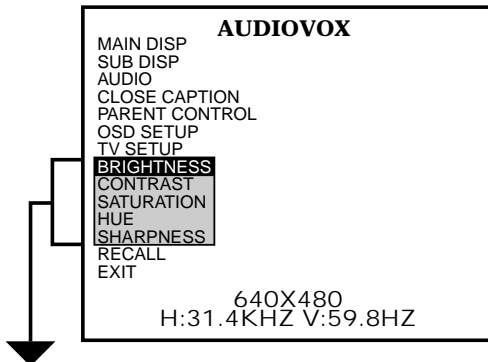

BRIGHTNESS

Adjusts the overall image and background screen brightness.

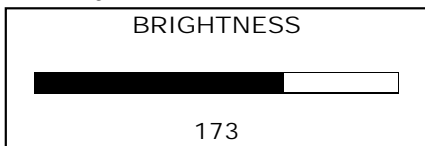

Press the button to adjust setting then press Menu to return to the previous menu.

SATURATION

Adjusts the color gradations in relation to the images and background.

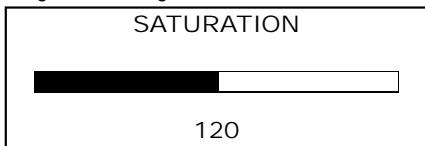

Press the button to adjust setting then press Menu to return to the previous menu.

SHARPNESS

Adjusts the overall image and background screen sharpness.

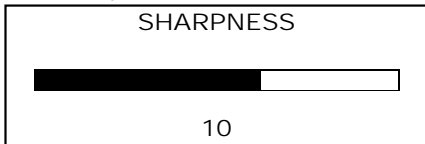

Press the button to adjust setting then press Menu to return to the previous menu.

CONTRAST

Adjusts the image brightness in relation to the background.

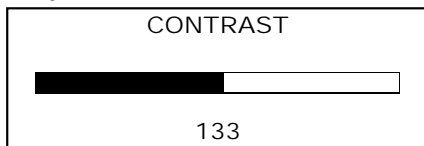

Press the button to adjust setting then press Menu to return to the previous menu.

HUE

Adjusts the color definition in relation to image and background.

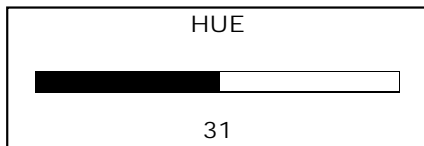

Press the button to adjust setting then press Menu to return to the previous menu.

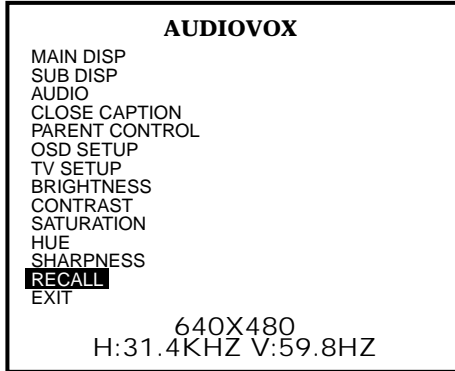

With the MAIN MENU displayed,
Select RECALL using the Menu button

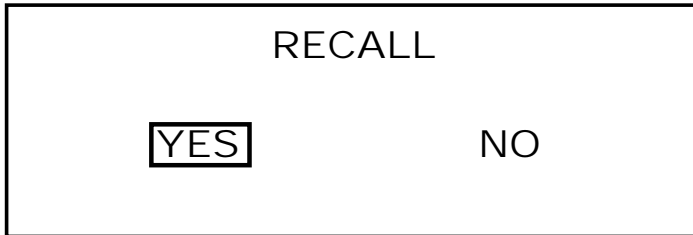

RECALL

Automatically reset setting to factory defaults.



Press the   buttons to select YES or NO option,
(No need to select Menu, the RECALL will happen Automatically).

EXIT

Exits the on-screen-menu controls

With the MAIN MENU displayed, select
EXIT using the MENU button to exit the
MAIN MENU

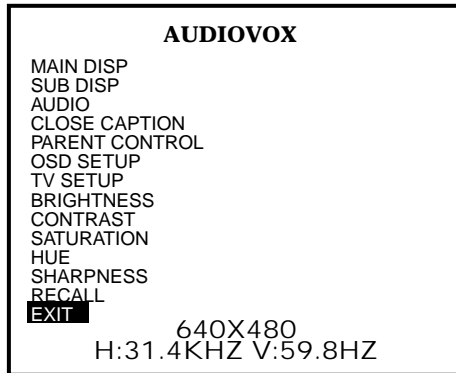

Using the FP1520 as a Computer Monitor

Press the  button to highlight MAIN DISP and Press and release the Menu button.



Select VGA and Press and release the Menu button.

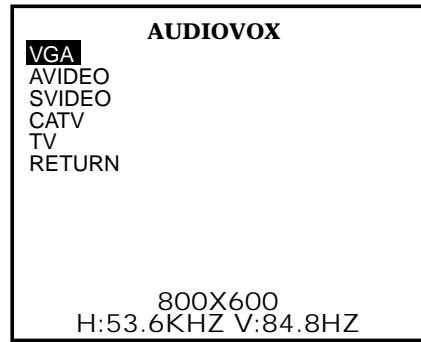

NOTE :

The CLOSE CAPTION and PARENT CONTROL options will not appear in the Main Menu until a TV program has been accessed using the SUB DISP menu.

AUTO TUNE

Automatically optimizes the VGA signal for viewing.

With the Main Menu displayed, use the  button to select AUTOTUNE

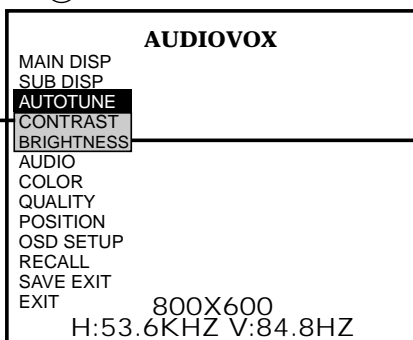

Then Press and release the Menu button to display the following screen :

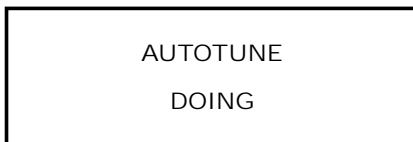



AUTOTUNE :
Only worked when unit is connected to computer
and the screen will appear "DOING"

CONTRAST

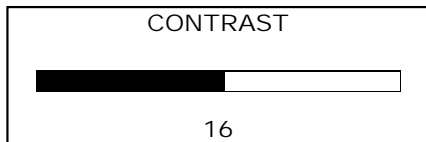
Adjusts the image brightness in relation to the background.





Press the   button to adjust setting then press Menu to return to the previous menu.

BRIGHTNESS

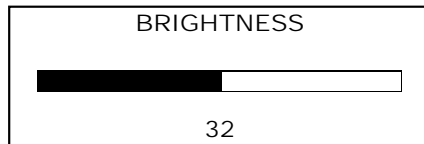
Adjusts the overall image and background screen brightness.



Press the   button to adjust setting then press Menu to return to the previous menu.

With the Main Menu displayed, use the

⏏ button to select COLOR.

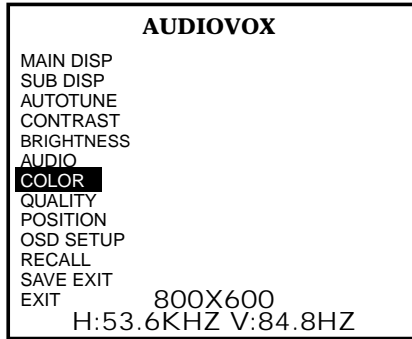

Press and release the Menu button to display the COLOR Menu :

Then use the ⏏ button to select USER.

When USER is selected, Color can be manually adjusted by selecting the following displayed colors :

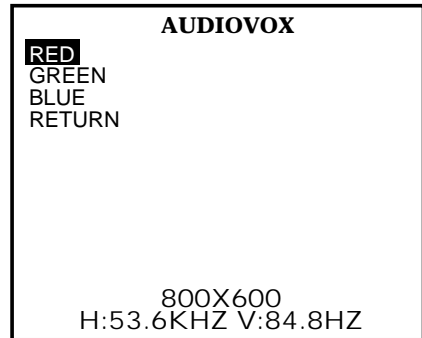
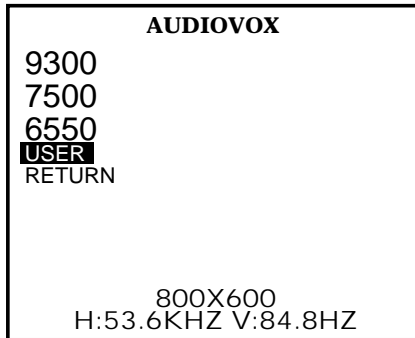

When RED is highlighted, pressing the Menu button will display the following screen :

Use the ⏏ and ⏶ buttons to adjust setting. Do this for each of the COLORS.

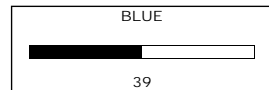
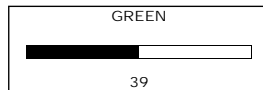
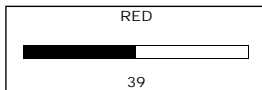

COLOR - Color temperature

1. 9300 - If you are partial to choose the 9300 setting.
2. 7500 - The 7500 setting is less blue than 9300.
3. 6550 - The color temperature setting is standard.
4. USER - Increases or decreases Red, Green or Blue colors. Change in color will be reflected on the screen image.

NOTE :

9300, 7500 and 6550 are Preset at the factory.

ADV. TUNE

With the Main Menu displayed, use the  button to select QUALITY.

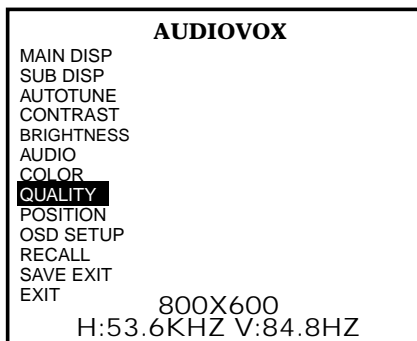

Then Press and release the Menu button to access the following screen ;

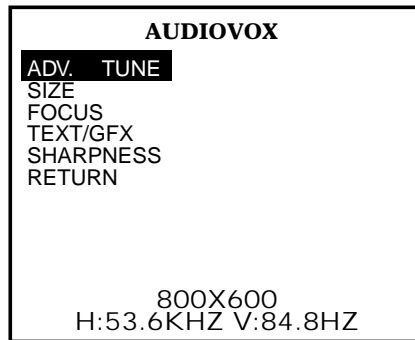

Adjust the picture FOCUS, SIZE and SHARPNESS.

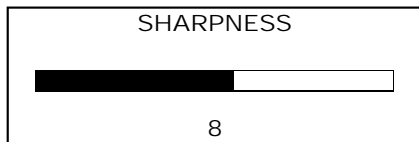
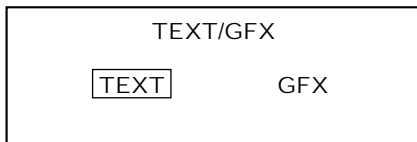
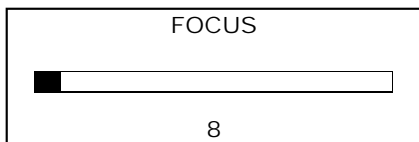
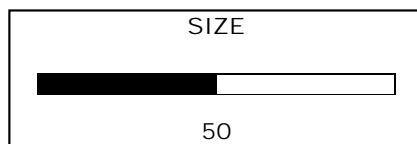
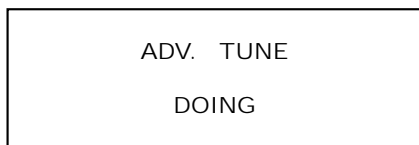

QUALITY

1. ADV. TUNE - Automatically adjusts image clarity and stability.
2. SIZE - Adjusts image size relative to the screen.
3. FOCUS - Controls image clarity.
4. TEXT/GFX - Adjusts text sharpness when PC is in DOS mode.
5. SHARPNESS - Adjusts image sharpness relative to the background.

IMAGE POSITION

With the Main Menu displayed, use the  button to select POSITION.

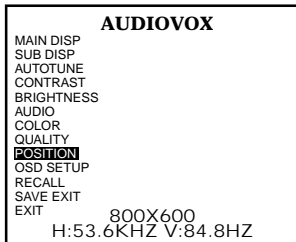

Then Press and release the Menu button to access the following screen :

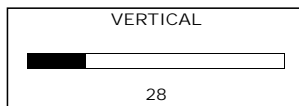
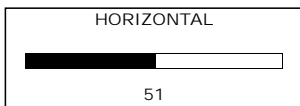
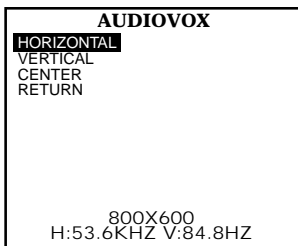
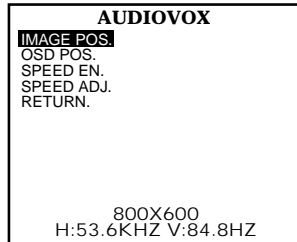

With SPEED EN highlighted, use the Menu button to access following screen :

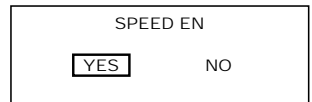

With SPEED ADJ highlighted, use the Menu button to access following screen :

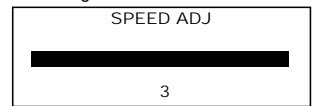

POSITION

1. IMAGE POS.

- a. HORIZONTAL - Adjusts the horizontal size by increasing or decreasing this setting.
- b. VERTICAL - Adjusts the vertical size by increasing or decreasing this setting.
- c. CENTER - Automatic adjusting image to center.

2. OSD POS. You can choose where you would like the OSD control window to appear on your screen. Selecting OSD location allows you to manually adjust the position of the OSD control menu left, right, up or down.

You can choose where you would like the OSD control window to appear in the center area on your screen.

3. SPEED EN.

- a. YES
- b. NO

4. SPEED ADJ.

SAVE EXIT

Saves your settings then exits main menu

EXIT :

Changes will not be saved.

With Main Menu displayed, use

the  button to select SAVE EXIT

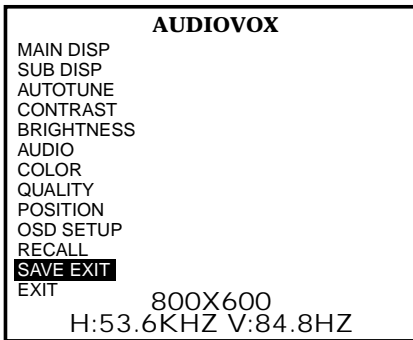

Then press and release the Menu button to save all settings and exit the Main Menu.

Use the  button to select EXIT

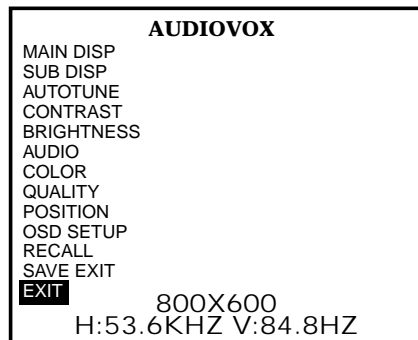

Then Press and release the Menu button to exit the Main Menu.

Reference
Display Modes

Mode	Resolution	Horizontal frequency(KHZ)	Vertical frequency(HZ)
1	640 × 350	31.47	70
2	720 × 400	31.47	70
3	640 × 480	31.47	60
4	640 × 480	37.86	72
5	640 × 480	37.5	75
6	800 × 600	35.16	56.3
7	800 × 600	37.88	60.3
8	800 × 600	48.08	72.2
9	800 × 600	46.87	75
10	1024 × 768	48.36	60
11	1024 × 768	56.47	70
12	1024 × 768	60	75
13	640 × 480	35	66.7
14	832 × 624	49.7	74.55
15	1024 × 768	48.78	60
16	1024 × 768	60.241	74.927

LCD Monitor Display Angle

Vertical : Left 30°/Right 30°
Horizontal : Up 30°/Down 5°

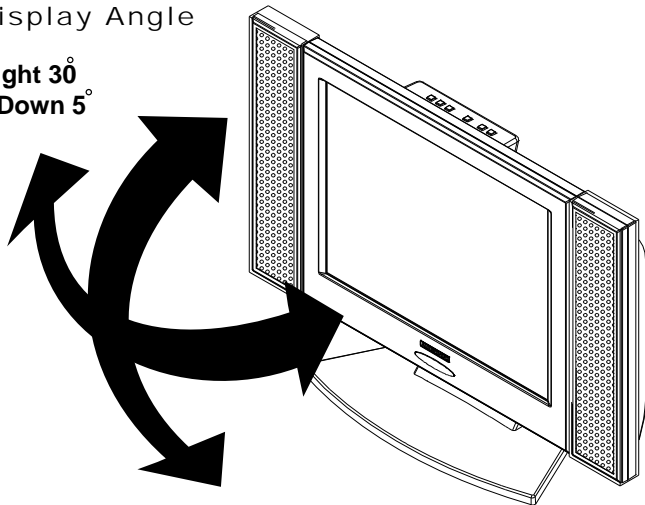

AUDIOVOX[®]

ELECTRONICS CORP.

Troubleshooting

Before calling our serviceman, please refer to the following chart to see if you can adjust the problems yourself.

Trouble	Checks and Adjustments
TV will not turn on	<ul style="list-style-type: none"> ■ Plug TV in. ■ Plug something else into the outlet to make sure it is working. ■ Make sure batteries in the remote are not dead. ■ Make sure batteries are placed in the remote the right way. ■ Unplug TV for a few minutes and then turn it on again.
Poor sound or no sound	<ul style="list-style-type: none"> ■ Check volume settings and mute settings ■ Check for possible interference sources
Blur picture or no picture	<ul style="list-style-type: none"> ■ Check antenna or TV cable ■ Check for possible outside interferences ■ Check picture settings
Some channels are not clear	<ul style="list-style-type: none"> ■ Check outdoor antenna and make necessary adjustments ■ Check possible outside interferences
Poor Color tone or No color	<ul style="list-style-type: none"> ■ Check memory settings ■ Check Color settings ■ Check if program is in correct channel ■ Check antenna and cable connections ■ Check possible outside interferences
No reception from Cable	<ul style="list-style-type: none"> ■ Check if cable is connected properly
Channels above 13 cannot receive	<ul style="list-style-type: none"> ■ Check if channels are selected properly ■ Check if cable company are experiencing technical problems
	<ul style="list-style-type: none"> ■ Check TV channel settings (CATV/TV) are set properly(page 20) ■ Check antenna and UHF settings
Unable to operate remote	<ul style="list-style-type: none"> ■ Check for low batteries or possible obstructions between remote and TV sensor ■ Check TV main power source
TV shut off	<ul style="list-style-type: none"> ■ Electric power failure ■ Preset sleep mode features are on ■ TV programs ended

Troubleshooting

Interference

Please note the following common TV reception interferences:]



Ignition effect

Black spots or vertical lines may appear. Screen jumps crazily or is very unstable. This is commonly the result of car ignition system interference, neon lights, or other forms of electrical interferences.



Ghost Shadows

This is the result of two signals : One being the original signal from the antenna while the 2nd signal is a slightly delayed signal, normally the result of bouncing off tall buildings or other obstructions. This problem might be corrected by adjusting your outdoor antenna.



Flurries

Lots of tiny dots appears on your screen. This is the result of poor reception signals. You may have to re-enforce your antenna signals.

★note: If interferences occur while you are using a cable system, then the problem could be at the cable source and not from your TV reception.

Troubleshooting

You may have problems that can be fixed with a few minor adjustments. Look for the type of problem you are having below and then apply the suggestions to get your TV going again.



Picture with no sound

- Check if you have accidentally pressed the "mute" button
- Check other channels if the same problem exist. If other channels are fine, then problem is with the TV program you are viewing. This shouldn't be a concern
- Verify all connections are firmly attached
- Connect cable to another TV
- If all checks fail, please contact our serviceman

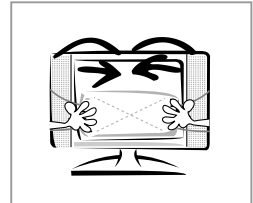

Sound with no picture

- Check if main power is switched on
- Check brightness and contrast level to see if they have been tuned to the minimum level thus making the screen dark
- Unplug the cable and re-plug it in after two minutes
- Check if you have accidentally pressed the "mute" button
- Connect cable to another TV

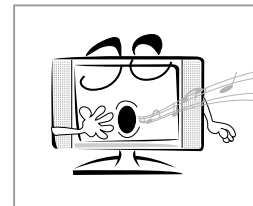

No Picture No Sound

- Check main power source
- Check other TV channels. If they are okay, problem is just with the TV program you are viewing
- Press the **MENU** button on the remote or on the top of the unit to get into the main display and reselect display option
- If you are using outdoor antenna, please check your connections are firmly attached.
- Please check if your power cord is connected properly, it may be loose
- Switch off main power, disconnect cable. Reconnect cable after two minutes rest then switch on the main power
- Check if the antenna or cable are well connected
- Check your Remote Control
- Check power adapter and power cord if they have been damaged
- Connect cable to another TV
- If all fails, please contact with serviceman immediately

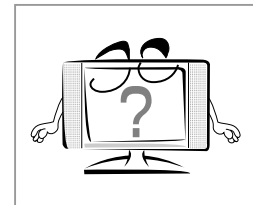

Troubleshooting



Picture too dark

- Check your brightness level
- Check your contrast level
- In the on screen display (OSD) select RECALL
- Check your LCD monitor for possible damage

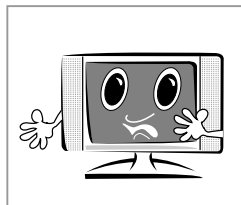

Remote Control Failure

- Check TV main power source
- Check if remote control batteries are weak
- Check if batteries have been correctly installed
- Check if there are obstructions between your remote control and the main TV remote sensor
- Disconnect your cable for two minutes before reinstalling it
- If failure resulted from electrical interferences, lighting or static, disconnect the TV main power for 10 seconds before reinstalling it. Restart your TV
- Try holding remote 2 inches from sensor

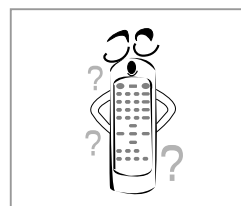

Picture is blurry

- Check other channels. Problem may be an isolated incidence
- If using outdoor antenna, please check connections
- Please check your accessories. Such as V ideo recorder, VCR, DVD player.
- Check your cable company or outdoor antenna reception
- RF signal may be too slow
- If all fails, please contact our serviceman immediately

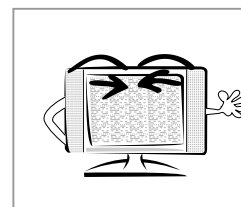

AUDIOVOX[®] ELECTRONICS CORP.

Note

Customer Record:

This Model number and serial number of this product can be found on its rear panel. You should note this serial number in the space provided below and retain this book, plus your purchase receipt, as a permanent record of your purchase to aid in identification in the event of theft or loss, and Warranty Service purpose.

Model Number: FP1520 Serial Number: _____

Audiovox Electronics Corporation
150 Marcus Blvd
Hauppauge, NY 11788
1-800-651-4994



For Customer Service
Visit Our Website At
www.audiovox.com
Product Information, Photos,
FAQ's, Owner's Manuals

Product Specifications:

Audiovox Model Number: FP1520

Monitor Display Specifications:	
Screen Size	15" (Viewable)
Aspect Ratio	4:3 aspect
Resolution	1024x768
Pixel pitch	0.29mm x 0.29mm
Total Display Colors	16.7 million true color display
Viewing Angle	
Contrast Ratio	500:1 (typ)
Brightness (cd/ϕT)	450 cd/ϕT(typ)
Backlight Lamp Life	50,000 hrs min
Connection Interfaces:	
RF (Coax)	
S-Video	
A/V Input	
Headphone Jack	
VGA (15 pin D-sub)	
Convenience Specifications:	
Total Watt output	5Wx2
Number of Speakers	
Parental Control with V-Chip	
Closed Caption (CC)	
181 Channel Cable ready	
NTSC Cable Standard	
Plug & Play for VGA	
Remote Control Type	Model specific
Licensing:	
FCC (Part 15)	YES
UL	YES
cUL	YES
Mechanical Dimensions:	
W x H x D (W/Stand)	20.1" (511mm) x 14.1" (360mm) x 7.1" (182.5mm)
W x H x D (W/o Stand)	20.1" (511mm) x 12" (305.5mm) x 2.2" (58mm)
Weight (W/o Power transformer)	11.4LB
Power usage:	
AC Power Source	110 - 240V ~1.8A, 50 -60Hz
Power Input	DC12V 3.0A 36W



AUDIOVOX®
ELECTRONICS CORP.

90 DAY LIMITED WARRANTY

Applies to Audiovox Video Products

AUDIOVOX ELECTRONICS CORPORATION (the Company) warrants to the original retail purchaser of this product that should this product or any part thereof, under normal use and conditions, be proven defective in material or workmanship within 90 days from the date of original purchase, such defect(s) will be repaired or replaced with reconditioned product (at the Company's option) without charge for parts and repair labor.

To obtain repair or replacement within the term of this Warranty, the products is to be delivered with proof of warranty coverage (e.g. dated bill of sale), specification of defect(s), transportation prepaid, to the Company at the address shown below.

This Warranty does not extend to the elimination of externally generated static or noise, to correction of antenna problems, to costs incurred for installation, removal or reinstallation of the product, or to damage to tapes, discs, speakers, accessories, or electrical systems.

This Warranty does not apply to any product or part thereof which, in the opinion of the Company , has suffered or been damaged through alteration, improper installation, mishandling, misuse, neglect, accident, or by removal or defacement of the factory serial number / bar code lable(s). THE EXTENT OF THE COMPANY'S LIABILITY UNDER THIS WARRANTY IS LIMITED TO THE REPAIR OR REPLACEMENT PROVIDED ABOVE AND, IN NO EVENT , SHALL THE COMPANY'S LIABILITY EXCEED THE PURCHASE PRICE PAID BY PURCHASER FOR THE PRODUCT.

This Warranty is in lieu of all other express warranties or liabilities. ANY IMPLIED WARRANTIES, INCLUDING ANY IMPLIED WARRANTY OF MERCHANTABILITY, SHALL BE LIMITED TO THE DURATION OF THIS WRITTEN WARRANTY. ANY ACTION FOR BREACHY OF ANY WARRANTY HEREUNDER INCLUDING ANY IMPLIED WARRANTY OF MERCHANTABILITY MUST BE BROUGHT WITHIN A PERIOD OF 30 MONTHS FROM DATE OF ORIGINAL PURCHASE. IN NO CASE SHALL THE COMPANY BE LIABLE FOR ANY CONSEQUENTIAL OR INCIDENTAL DAMAGES FOR BREACH OF THIS OR ANY OTHER WARRANTY, EXPRESS OR IMPLIED, WHATSOEVER. No person or representative is authorized to assume for the Company any liability other than expressed herein in connection with the sale of this product.

Some states do not allow limitations on how long an implied warranty lasts or the exclusion or limitation of incidental or consequential damage so the above limitation or exclusions may not apply to you. This Warranty gives you specific legal rights and you may also have other rights which vary from state to state.

U.S.A.: AUDIOVOX ELECTRONICS CORPORATION, 150 MARCUS BLVD., HAUPPAUGE, NEW YORK 11788 • 1-800-645-4994
CANADA: CALL 1-800-645-4994 FOR LOCATION OF WARRANTY STATION SERVING YOUR AREA

128-5556D

Free Manuals Download Website

<http://myh66.com>

<http://usermanuals.us>

<http://www.somanuals.com>

<http://www.4manuals.cc>

<http://www.manual-lib.com>

<http://www.404manual.com>

<http://www.luxmanual.com>

<http://aubethermostatmanual.com>

Golf course search by state

<http://golfingnear.com>

Email search by domain

<http://emailbydomain.com>

Auto manuals search

<http://auto.somanuals.com>

TV manuals search

<http://tv.somanuals.com>