

**AUDIOVOX®**  
ELECTRONICS CORP.

# LCD TV Operating Manual

---

## FPE3705



**Before connecting, operating or adjusting this product, please read the manual completely.**

FOR ASSISTANCE CALL 1-800-619-3848  
OR VISIT US AT [WWW.AUDIOVOX.COM](http://WWW.AUDIOVOX.COM)

1287358

# Table of Contents

---

Important Information .....	1
Important Safety Precautions .....	2
Preparations .....	5
Using the Remote Control.....	5
Batteries for the Remote Control.....	5
Power Connection .....	5
Antenna Connection .....	6
Identification of Controls.....	7
Main Unit .....	7
Remote Control .....	9
Connections.....	11
Cautions Before Connecting .....	11
To connect AV1/S-VIDEO input terminals.....	11
To connect AV2 input terminals .....	12
To connect Component input terminals.....	13
To connect DVI input.....	14
To connect D-Sub input.....	15
To connect AV output terminals.....	16
Turning the Unit On and Off.....	17
Turning the Unit On and Off .....	17
Viewing the Menus and Displays .....	17
Memorizing the Channels.....	18
Selecting the Signal Source .....	18
Storing Channels in Memory Automatically .....	18
Adding and Erasing Channels.....	19
Basic Operations.....	20
Changing Channels .....	20
Adjusting the Volume .....	20
Selecting Input Source Signal .....	21
Selecting a Menu Language.....	21
Setting Picture.....	22
Customizing the Picture .....	22
Using the Preset Picture Mode .....	22
Setting System.....	23
<b>Setting System In TV Mode</b> .....	23
Adjusting Screen Aspect.....	23
Reducing Picture Noise .....	23
VCR mode.....	23
Loading Default Values .....	23
<b>Setting System In VGA Mode</b> .....	24
Changing the Position of Image .....	24
Adjusting Clock and Phase .....	24
Adjusting the Picture Automatically.....	24
Adjusting Screen Aspect.....	25
Displaying Resolution Information.....	25
Loading Default Values .....	25

## Table of Contents (continued)

<b>Setting System In YPbPr Mode</b> .....	26
Adjusting Phase.....	26
Adjusting Screen Aspect .....	26
Reducing Picture Noise .....	26
Loading Default Values .....	26
<b>Setting System In DVI Mode</b> .....	27
Adjusting Screen Aspect.....	27
Displaying Resolution Information.....	27
Setting Sound .....	28
Customizing the Sound .....	28
Using the Preset Sound Mode.....	28
Setting SRS effect.....	28
Adjusting On-Screen Display .....	29
Adjusting OSD Position .....	29
Adjusting OSD Transparence.....	29
Zooming OSD Menu.....	29
Setting OSD Off Time .....	29
Loading default values.....	29
TVPC Operations .....	30
Viewing the TVPC.....	30
Selecting the Signal Source for the TVPC Frame .....	30
Changing Channels for the TVPC Frame .....	30
Changing the Position of the TVPC Frame.....	31
Adjusting the Size of TVPC Frame .....	31
Viewing Picture-by-Picture.....	31
Using Hotkeys.....	32
Setting Sleep Timer .....	32
Setting Audio Mode.....	32
Adjusting Back Light of the Panel .....	32
Freezing Picture.....	32
Viewing Closed Captions.....	33
Turning Closed Caption On or Off.....	33
Setting Closed Caption.....	33
Setting CC When Mute .....	33
Adjusting Child Lock Settings.....	34
Child Lock .....	34
Turning Child Lock On or Off .....	36
Changing the Password .....	36
Adjusting the Movie Rating.....	36
Adjusting the TV Rating .....	36
Adjusting Canadian English Rating .....	37
Adjusting Canadian French Rating .....	37
Troubleshooting .....	38
Care and Maintenance .....	39
Specification .....	40

# Important Information

**WARNING:** TO REDUCE THE RISK OF FIRE OR ELECTRIC SHOCK, DO NOT EXPOSE THIS APPARATUS TO RAIN OR MOISTURE.

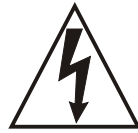
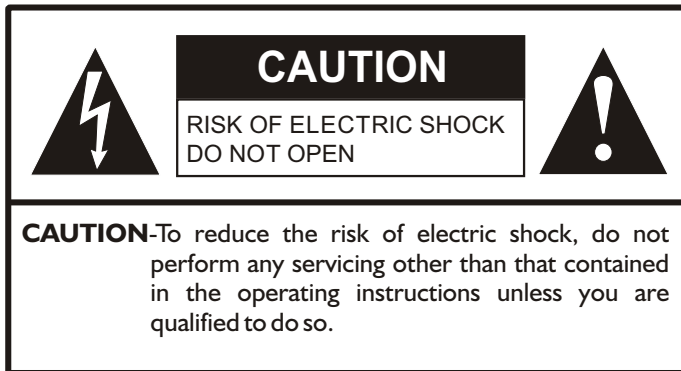

The lightning flash with arrowhead symbol, within an equilateral triangle is intended to alert the user to the presence of uninsulated dangerous voltage within the product's enclosure that may be of sufficient magnitude to constitute a risk of electric shock to persons.



The exclamation point within an equilateral triangle is intended to alert the user to the presence of important operating and maintenance (servicing) instructions in the literature accompanying the appliance.

"Note to CATV system installer: This reminder is provided to call the CATV system installer's attention to Article 820-40 of the National Electrical Code that provides guidelines for proper grounding and, in particular, specifies that the cable ground shall be connected to the grounding system of the building, as close to the point of cable entry as practical."

This product utilizes tin-lead solder, and fluorescent lamp containing a small amount of mercury. Disposal of these materials may be regulated due to environmental considerations. For disposal or recycling information, please contact your local authorities or the Electronic Industries Alliance: [www.eia.org](http://www.eia.org)

## FCC STATEMENT

### FCC Notice

#### LCD TV: A CLASS B digital device

This equipment has been tested and found to comply with the limits for a Class B digital device, pursuant to part 15 of the FCC Rules. These limits are designed to provide reasonable protection against harmful interference when the equipment is operated in a commercial environment.

This equipment generates, uses, and can radiate radio frequency energy and, if not installed and used in accordance with the instruction manual, may cause harmful interference to radio communications. Operation of this equipment in a residential area is likely to cause harmful interference in which case the user will be required to correct the interference at his own expense.

#### FCC CAUTION:

**Pursuant to 47CFR, Part 15.21 of the FCC rules, any changes or modifications to this monitor not expressly approved by the manufacturer could cause harmful interference and would void the user's authority to operate this device.**

**WARNING: This is a CLASS B product. In a domestic environment this product may cause radio interference in which case the user may be required to take adequate measures to counter interference.**

# Important Safety Precautions

Electrical energy can perform many useful functions, but it can also cause personal injuries and property damage if improperly handled. This product has been engineered and manufactured with the highest priority on safety. But **IMPROPER USE CAN RESULT IN POTENTIAL ELECTRICAL SHOCK OR FIRE HAZARD**. In order to prevent potential danger, please observe the following instructions when installing, operating and cleaning the product. To ensure your safety and prolong the service life of your LCD TV product, please read the following precautions carefully before using the product.

- 1. Read these instructions**---All operating instructions must be read and understood before the product is operated.
- 2. Keep these instructions**---These safety and operating instructions must be kept in a safe place for future reference.
- 3. Heed all warnings**---All warnings on the product and in the instructions must be observed closely.
- 4. Follow all instructions**---All operating instructions must be followed.

**5. Do not use this apparatus near water**---for example, near a bathtub, washbowl, kitchen sink, or laundry tub, in a wet basement, or near a swimming pool, and the like.

Do not use immediately after moving from a low temperature to high temperature environment, as this causes condensation, which may result in fire, electric shock, or other hazards.



**6. Clean only with dry cloth**---Unplug this product from the wall outlet before cleaning. Do not use liquid cleaners or aerosol cleaners. Use a damp cloth for cleaning.

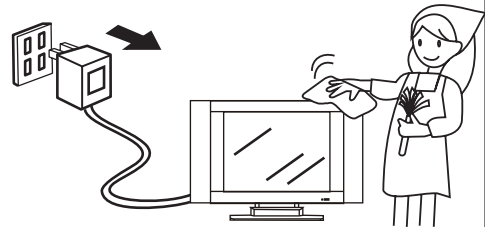

**7. Ventilation**---Do not block any ventilation openings. Install in accordance with the manufacturer instructions. The vents and other openings in the cabinet are designed for ventilation. Do not cover or block these vents and openings since insufficient ventilation can cause overheating and/or shorten the life of the product. Do not place the product on a bed, sofa, rug or other similar surface, since they can block ventilation openings. This product is not designed for built-in installation; do not place the product in an enclosed place such as a bookcase or rack, unless proper ventilation is provided or the manufacturer's instructions are followed.

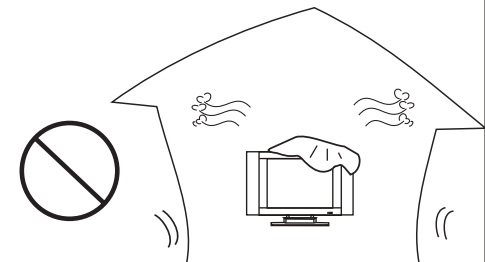

**8. Heat sources**---Do not install near any heat sources such as radiators, heat registers, stoves, or other apparatus (including amplifiers) that produce heat.

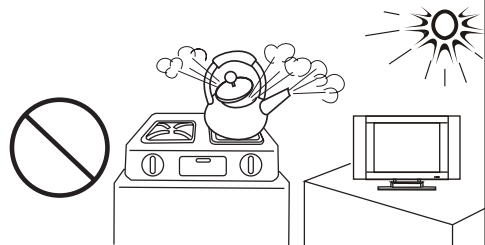

**9. Grounding or Polarization**---Do not defeat the safety purpose of the polarized or grounding-type plug. A polarized plug has two blades with one wider than the other. A grounding type plug has two blades and a third grounding prong. The wide blade or the third prong are provided for your safety. If the provided plug does not fit into your outlet, consult an electrician for replacement of the obsolete outlet.

**10. Power cord protection**---Protect the power cord from being walked on or pinched particularly at plugs, convenience receptacles, and the point where they exit from the apparatus.

**11. Attachments**---Only use attachments/accessories specified by the manufacturer. Do not use attachments not recommended by the manufacturer. Use of improper attachments can result in accidents.

## Important Safety Precautions (continued)

**12. Stand**---Use only with the cart, stand, tripod, bracket, or table specified by the manufacturer, or sold with the apparatus. Do not place the product on an unstable trolley, stand, tripod or table. Placing the product on an unstable base can cause the product to fall, resulting in serious personal injuries as well as damage to the product. When mounting the product on a wall, be sure to follow the manufacturer's instructions. Use only the mounting hardware recommended by the manufacturer.

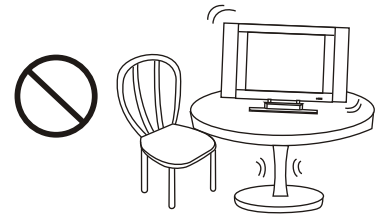

**13. Move Carefully**---When a cart is used, use caution when moving the cart/apparatus combination to avoid injury from tip-over. Sudden stops, excessive force and uneven floor surfaces can cause the product to fall from the trolley.



**14. Lightning**---Unplug this apparatus during lightning storms or when unused for long periods of time.

For added protection for this television equipment during a lightning storm, or when it is left unattended and unused for long periods of time, unplug it from the wall outlet and disconnect the antenna. This will prevent damage to the equipment due to lightning and power-line surges.

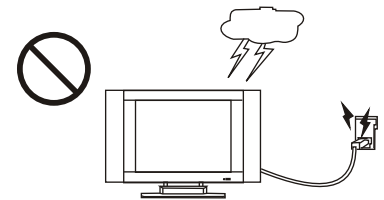

**15. Servicing**---Refer all servicing to qualified service personnel. Servicing is required when the apparatus has been damaged in any way, such as power-supply cord or plug is damaged, liquid has been spilled or objects have fallen into the apparatus, the apparatus has been exposed to rain or moisture, does not operate normally, or has been dropped.

**16. Replacement parts**---In case the product needs replacement parts, make sure that the service person uses replacement parts specified by the manufacturer, or those with the same characteristics and performance as the original parts. Use of unauthorized parts can result in fire, electric shock and/or other danger.

**17. Overloading**---Do not overload wall outlets, extension cords, or convenience receptacles on other equipment as this can result in a risk of fire or electric shock.

**18. Entering of objects and liquids**---Never insert an object into the product through vents or openings. High voltage flows in the product, and inserting an object can cause electric shock and/or short internal parts. For the same reason, do not spill water or liquid on the product.

**19. Damage requiring service**---If any of the following conditions occurs, unplug the power cord from the AC outlet, and request a qualified service person to perform repairs.

- a. When the power cord or plug is damaged.
- b. When a liquid is spilled on the product or when objects have fallen into the product.
- c. When the product has been exposed to rain or water.
- d. When the product does not operate properly as described in the operating instructions.

Do not touch the controls other than those described in the operating instructions. Improper adjustment of controls not described in the instructions can cause damage, which often requires extensive adjustment work by a qualified technician.

- e. If the product has been dropped or the cabinet has been damaged in any way.
- f. When the product displays an abnormal condition or exhibits a distinct change in performance. Any noticeable abnormality in the product indicates that the product needs servicing.

**20. Safety checks**---Upon completion of service or repair work, request the service technician to perform safety checks to ensure that the product is in proper operating condition.

**21. Wall or ceiling mounting**---When mounting the product on a wall or ceiling, be sure to install the product according to the method recommended by the manufacturer. This is a safety feature.

## Important Safety Precautions (continued)

**22. Power source**---This product is intended to be supplied by a listed power supply indicated on the marking label. If you are not sure of the type of power supply to your home, consult your product dealer or local power company. For added protection for this product during a lightning storm, or when it is left unattended and unused for long periods of time, unplug it from the wall outlet and disconnect the cable system. This will prevent damage to the product due to lightning and power line surges. When the unit has to be used with another power supply voltage, the power cable must be changed. Consult your product dealer. The socket outlet should be installed near the equipment and easily accessible. Use only the power cord designated by our dealer to ensure safety and EMC. When connecting other products such as VCRs and personal computers, you should turn off the power of the unit for protection against electric shock.

**23. Panel protection**---The LCD panel used in this product is made of glass. Therefore, it can break when the product is dropped or impacted upon by other objects. Be careful not to be injured by broken glass pieces in case the LCD panel breaks.

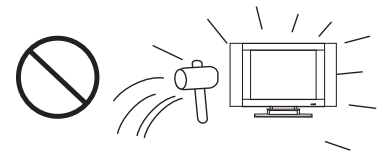

**24. Pixel defect**---The LCD panel is a very high technology product, giving you finely detailed pictures. Occasionally, a few non-active pixels may appear on the screen as a fixed point of blue, green or red. Please note that this does not affect the performance of your product.

- If an outside antenna is connected to the television equipment, be sure the antenna system is grounded so as to provide some protection against voltage surges and built-up static charges. Section 810 of the National Electrical Code provides information with respect to proper grounding of the mast and supporting structure, grounding of the lead-in wire to an antenna discharge unit, size of grounding conductors, location of antenna-discharge unit, connection to grounding electrodes, and requirements for the grounding electrode.

### EXAMPLE OF ANTENNA GROUNDING AS PER NATIONAL ELECTRICAL CODE

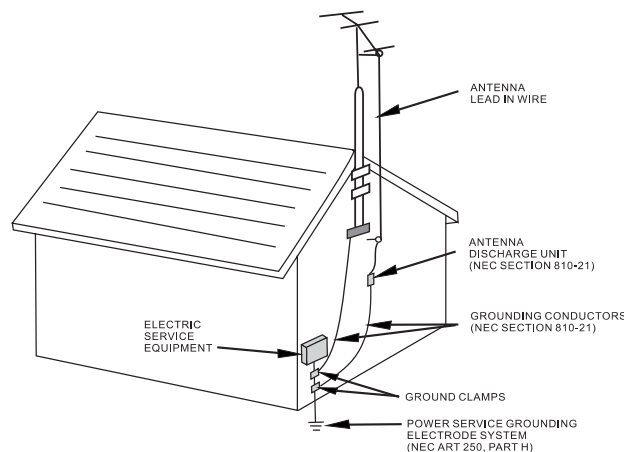

### NEC—NATIONAL ELECTRICAL CODE

- An outside antenna system should not be located in the vicinity of overhead power lines or other electric light or power circuits, or where it can collide with such power lines or circuits. When installing an outside antenna system, extreme care should be taken to keep from touching such power lines or circuits, as contact with them might be fatal.

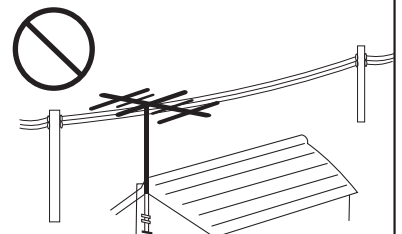

# Preparations

## Using the Remote Control

- Use the remote control by pointing it towards the remote sensor window of the set. Objects between the remote control and sensor window may prevent proper operation.

**Note:** This illustration is for reference only. The remote sensor may be in different locations on different models.

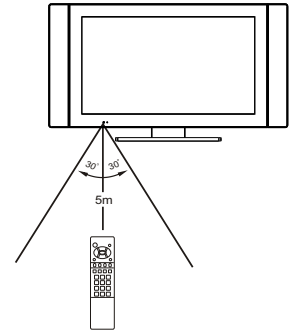

## Cautions regarding use of remote control

- Do not expose the remote control to shock. In addition, do not expose the remote control to liquids, and do not place in an area with high humidity.
- Do not install or place the remote control under direct sunlight. The heat may cause deformation of the unit.
- The remote control may not work properly if the remote sensor window of the main unit is under direct sunlight or strong lighting. In such a case, change the angle of the lighting or LCD TV set, or operate the remote control closer to the remote sensor window.

## Batteries for the Remote Control

If the remote control fails to operate the LCD TV functions, replace the batteries in the remote control.

1 Open the battery cover.

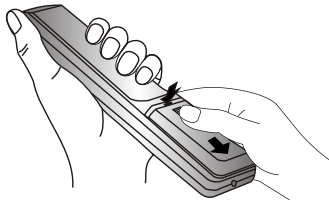

- (Slide the cover while pressing down.)

2 Insert two size-AAA batteries.

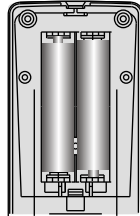

- (Place the batteries with their terminals corresponding to the (+) and (-) indications in the battery compartment.)

3 Replace the cover and slide in reverse until the lock snaps.

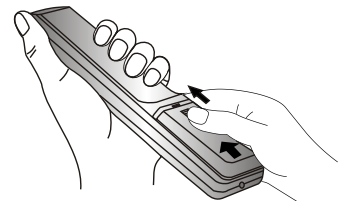

## Precaution on battery use

Improper use of batteries can result in a leakage of chemicals and/or explosion. Be sure to follow the instructions below.

- Place batteries with their terminals corresponding to the (+) and (-) indications.
- Different types of batteries have different characteristics. Do not mix batteries of different types.
- Do not mix old and new batteries. Mixing old and new batteries can shorten the life of new batteries and/or cause old batteries to leak chemicals.
- Remove batteries as soon as they are non-operable. Chemicals that leak from batteries can cause a rash. If chemical leakage is found, wipe with a cloth.
- The batteries supplied with the product may have a shorter life expectancy due to storage conditions.
- If the remote control is not used for an extended period of time, remove the batteries from the remote control.

## To open or close the back cover

Push downward and then pull out the cover carefully in the direction of the arrow to remove the cover.

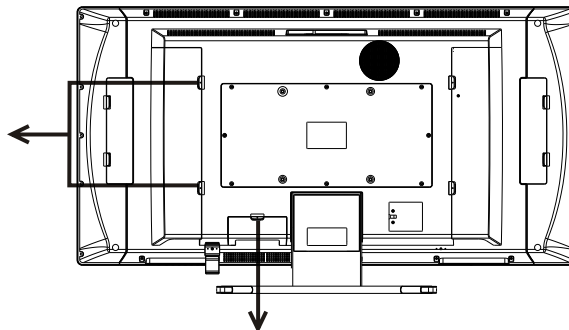

Push downward and then pull out the cover carefully in the direction of the arrow to remove the cover.

When you finish connecting, aim the Hook toward the Locating groove, then carefully push the Cover until the Cover locks in place with a click.



## Antenna Connection

### CABLE TV (CATV) CONNECTION

A 75-ohm coaxial cable connector is built into the set for easy hookup. When connecting the 75-ohm coaxial cable to the set, screw the 75-ohm cable to the ANT. Terminal.

Some cable TV companies offer "premium pay channels". Since the signals of these premium pay channels are scrambled, a cable TV converter/descrambler is generally provided to the subscriber by the cable TV company.

This converter/descrambler is necessary for normal viewing of the scrambled channels. For more specific instructions on installing cable TV, consult your cable TV company. One possible method of utilizing the converter/descrambler provided by your cable TV company is explained below. Please note: An RF switch provided with two inputs (A and B) is required (not supplied).

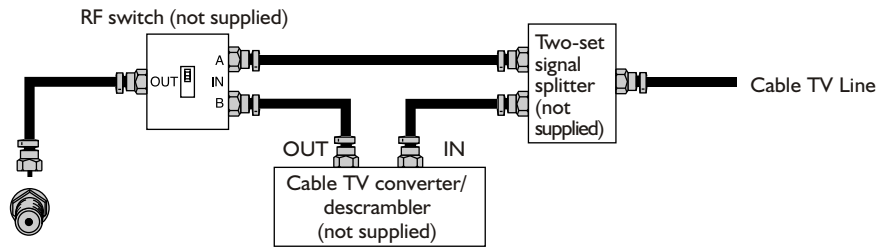

"A" position on the RF switch (not supplied) : You can view all unscrambled channels by using the TV's channel keys.

"B" position on the RF switch (not supplied) : You can view the scrambled channels via the converter/descrambler by using the converter's channel keys.

#### Note:

Consult your Dealer or Service Center for the type of splitter, RF switch or combiner that might be required.

### ANTENNAS

The antenna requirements for good color television reception are more important than those for black & white television reception. For this reason, a good quality outdoor antenna is strongly recommended.

The following is a brief explanation of the type of connections that are provided with the various antenna systems.

1. A 75-ohm system is generally a round cable with F-type connector that can easily be attached to a terminal without tools (not supplied).
2. A 300-ohm system is a flat "twin-lead" cable that can be attached to a 75-ohm terminal through a 300-75-ohm adapter (not supplied).

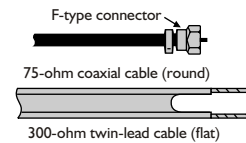

### OUTDOOR ANTENNA CONNECTION

Use one of the following two diagrams if you connect an outdoor antenna.

A: Using a VHF/UHF combination outdoor antenna.

B: Using separate VHF and/or UHF outdoor antennas.

Connect the outdoor antenna cable lead-in to the ANT. terminal on the rear of the TV set.

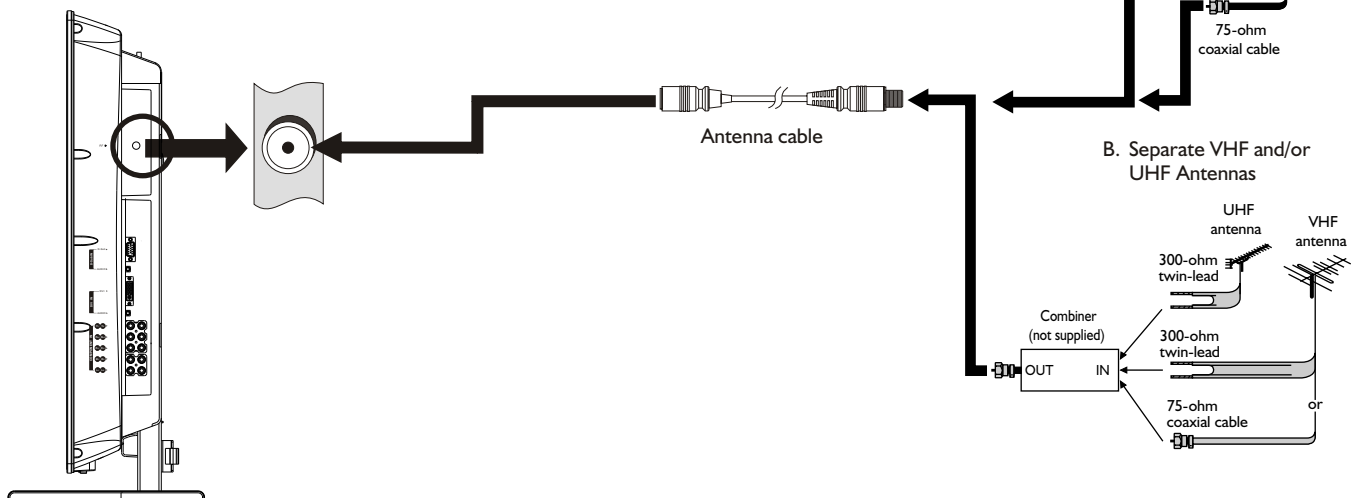

# Identification of Controls

## Main Unit

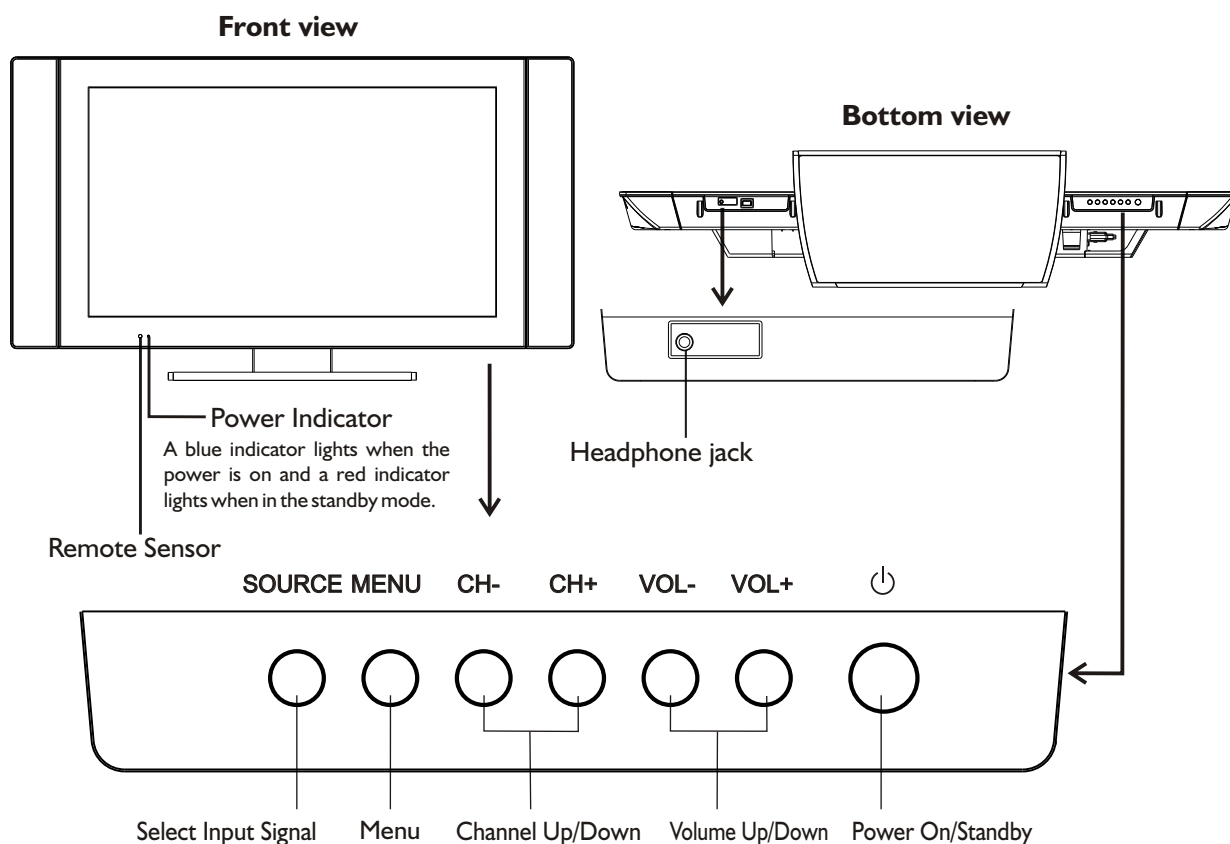

### 1. POWER

Press this button to turn the unit ON from STANDBY mode. Press it again to turn the set back to STANDBY.

### 2. SOURCE

To access signal source select menu.

### 3. MENU

Press this button to access the Menu main page.

### 4. CH+/-

Press these two buttons to directly change the TV channel;  
In OSD Menu, press these buttons to choose the OSD items.

### 5. VOL+/-

Press the **VOL+** or **VOL-** button to directly increase or decrease the sound volume level;  
In OSD Menu, press these buttons to adjust the value or setting of each item.

### Note:

Functions of **VOL+/-**, **CH+/-**, **MENU**, **INPUT** and **POWER** are also provided to the remote control. This operation manual provides a description based on operating functions with the remote control.

## Main Unit

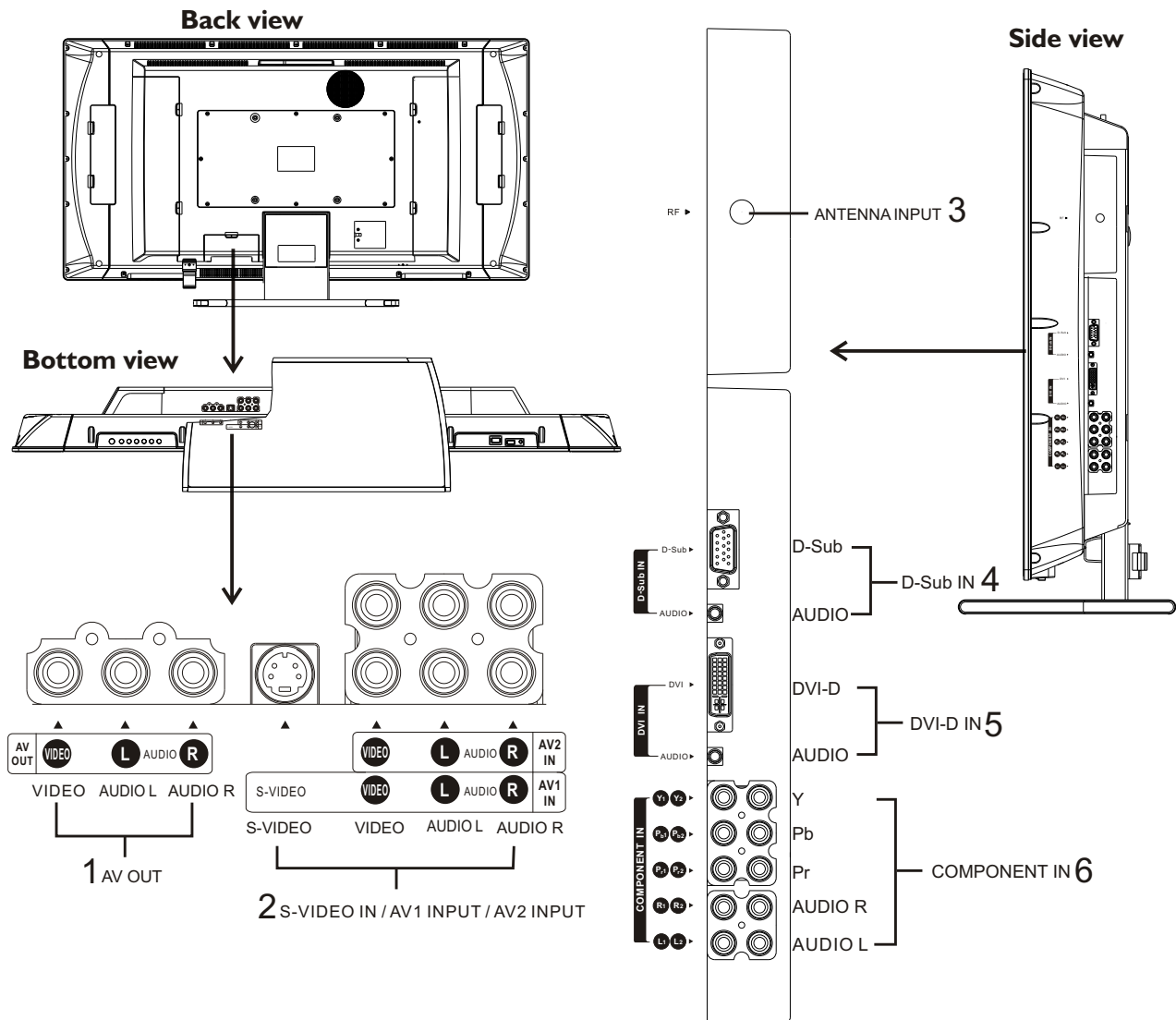

- 1. AV outputs** (Video, Audio L/mono, R)  
Connect to the VCR input jacks to record programs.
- 2. S-Video input / AV1 inputs / AV2 inputs** (Video, Audio L/mono, R)  
Receive a S-Video signal from external source such as VCR or DVD player.  
Receive video/audio signals from external sources such as VCR or DVD player.
- 3. Antenna input**  
Allows you to connect cable or outdoor antenna.
- 4. D-sub (VGA) input / Audio in**  
Connect to the VGA/audio outputs on your PC.
- 5. DVI input / Audio in**  
Connect to the DVI/audio outputs on your DTV receiver.
- 6. Component inputs** (Y, Pb, Pr, Audio L, R)  
Connect to the audio and component output jacks of a DVD player or Set-Top Box.

**Note:**

The AV output terminals output audio/video signal inputted from Antenna input or AV inputs.

# Identification of Controls (continued)

## Remote Control

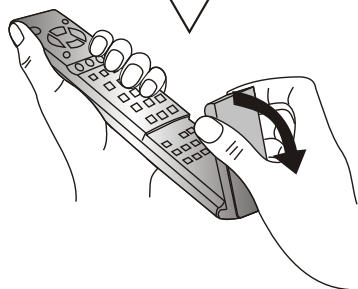
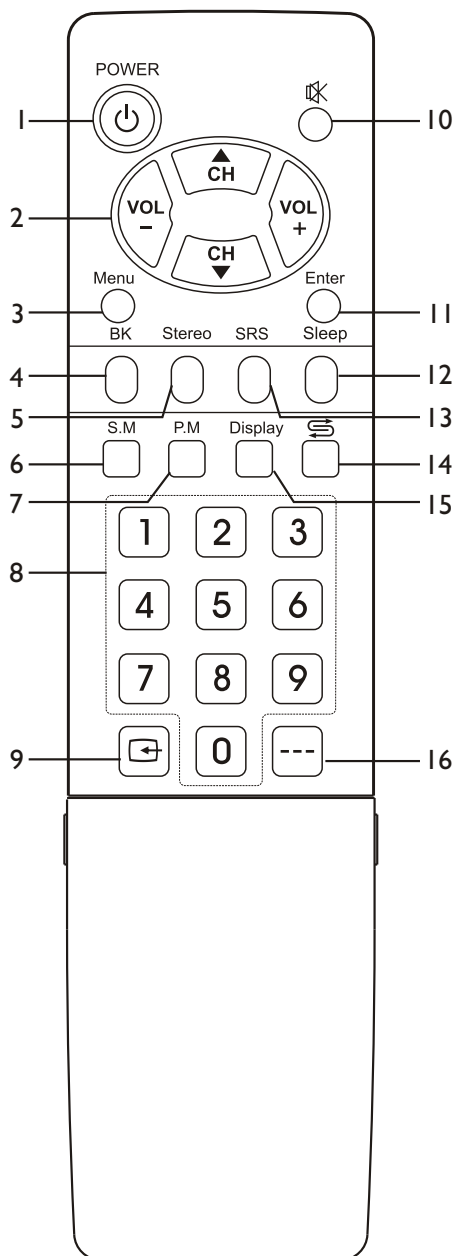

Flip the cover, open in the direction of the arrow.

### 1. POWER

Turn the unit on or off

- 2. CH ▲ / ▼ :** Use to switch channels;  
In Menu operation, use **CH ▲ / ▼** to select menu item;  
**VOL +/-:** Use to adjust volume;  
In Menu operation, use **VOL +/-** to adjust selected item;

### 3. Menu

To access the Menu main page or exit menu operation

### 4. BK

To adjust panel backlight

### 5. Stereo

To select STEREO, SAP or MONO

### 6. S.M

Sound mode select

### 7 P.M

Picture mode select

### 8. 0~9 number buttons

Direct channel select

### 9. Source

To access source select menu

### 10. Mute

Sound mute

### 11. Enter

To confirm, enter submenu or toggle the settings of the selected menu;

### 12. Sleep

To set Sleep timer

### 13. SRS

To turn on or off the SRS sound effect \*

### 14. Return

To quickly jump between current channel and last selected channel.

### 15. Display

To display channel status or signal information

### 16. ---

To select three-digit channel number

\* The SRS symbol are trademark of SRS Labs, Inc.

SRS technology is incorporated under license from SRS Labs, Inc.

## Remote Control

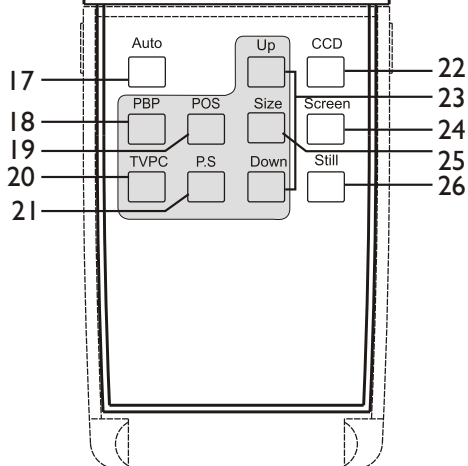
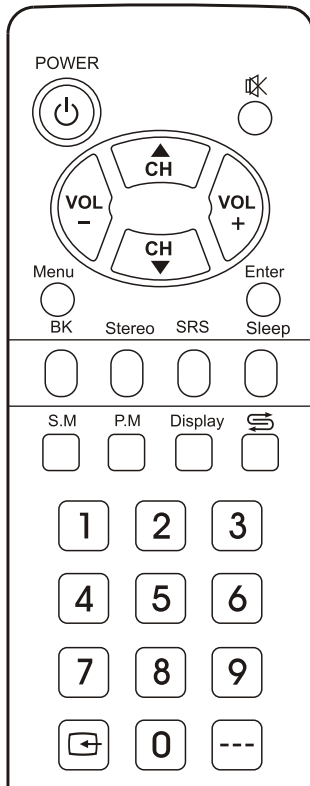

### 17. Auto

To rectify the picture automatically in VGA mode

### 18. PBP

To activate picture-by-picture

### 19. POS

To adjust TVPC frame position

### 20. TVPC

To activate TVPC function

### Note:

The TVPC function means you may view a TV program from a mini window while the main window is displaying a PC screen.

### 21. P.S.

To select signal source for TVPC frame

### 22. CCD

To select CCD on/off and CCD channel

### 23. Up, Down

To change channel of TVPC frame

### 24. Screen

To select screen aspect ratio

### 25. Size

To adjust TVPC frame size

### 26. Still

To freeze current picture

# Connections

## Cautions Before Connecting

- Carefully check the terminals for position and type before making any connections.
- The illustration of the external equipment may be different depending on your model.
- Loose connectors can result in image or color problems. Make sure that all connectors are securely inserted into their terminals.
- Refer to the operating manual of the external device as well.
- When connecting an external device, turn the power off on the panel to avoid any issues.

## To connect AVI/S-video input terminals

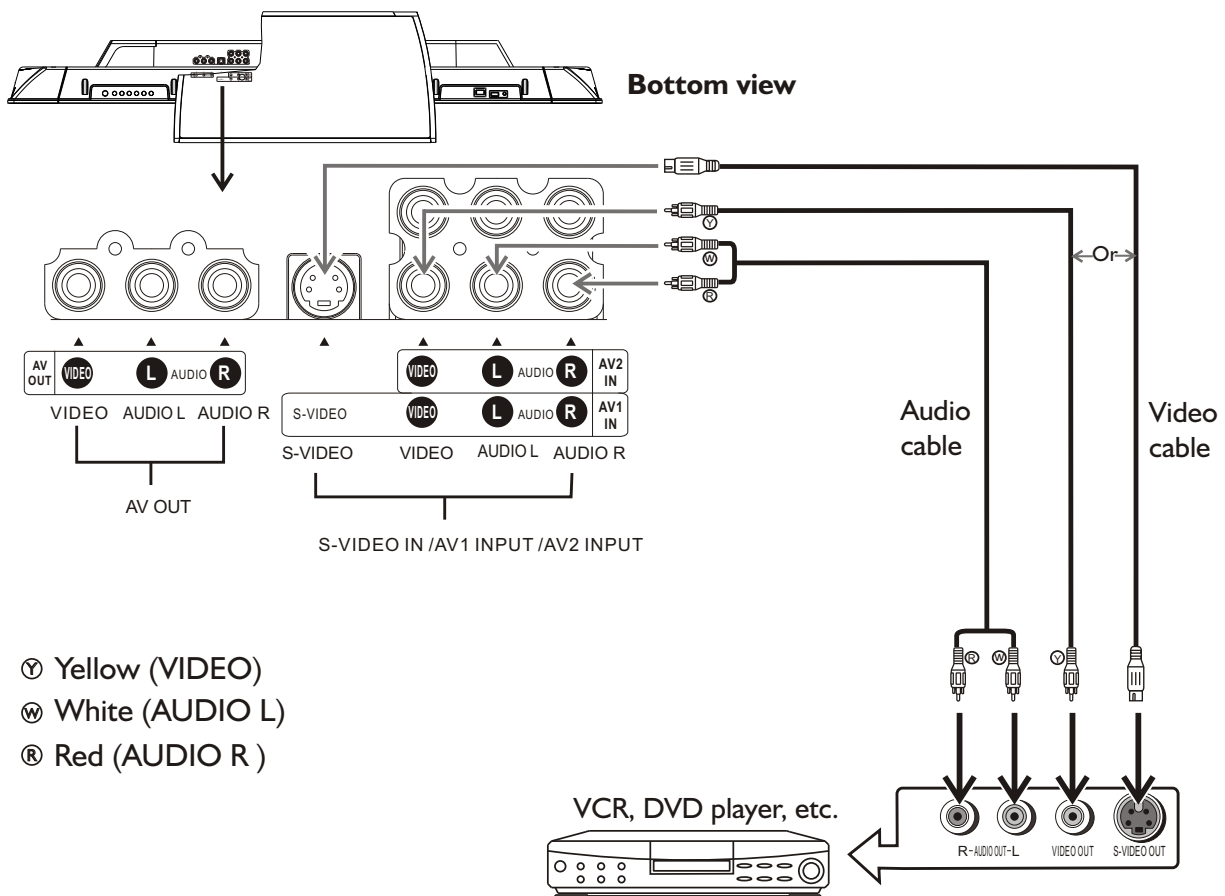

### How to connect:

Connect the Audio/Video cables between the Audio (L/R)/Video jacks on the unit and VCR.

### Note:

For better video, you can use the S-video terminal if your source supports it. The S-video terminal is prior to Video terminal when they are connected at the same time. To use Video terminal, you should disconnect S-video.

### To play VCR

1. Turn on your LCD TV, press **INPUT** button on the remote control.
2. Press **▲** or **▼** to select **Video1** (AV1 IN) and press **OK** to confirm.
3. Turn on your VCR, insert a videotape and press the Play button.

Source Select  
VGA  
DVI  
RF  
**Video1**  
Video2  
YPbPr1  
YPbPr2

## To connect AV2 input terminals

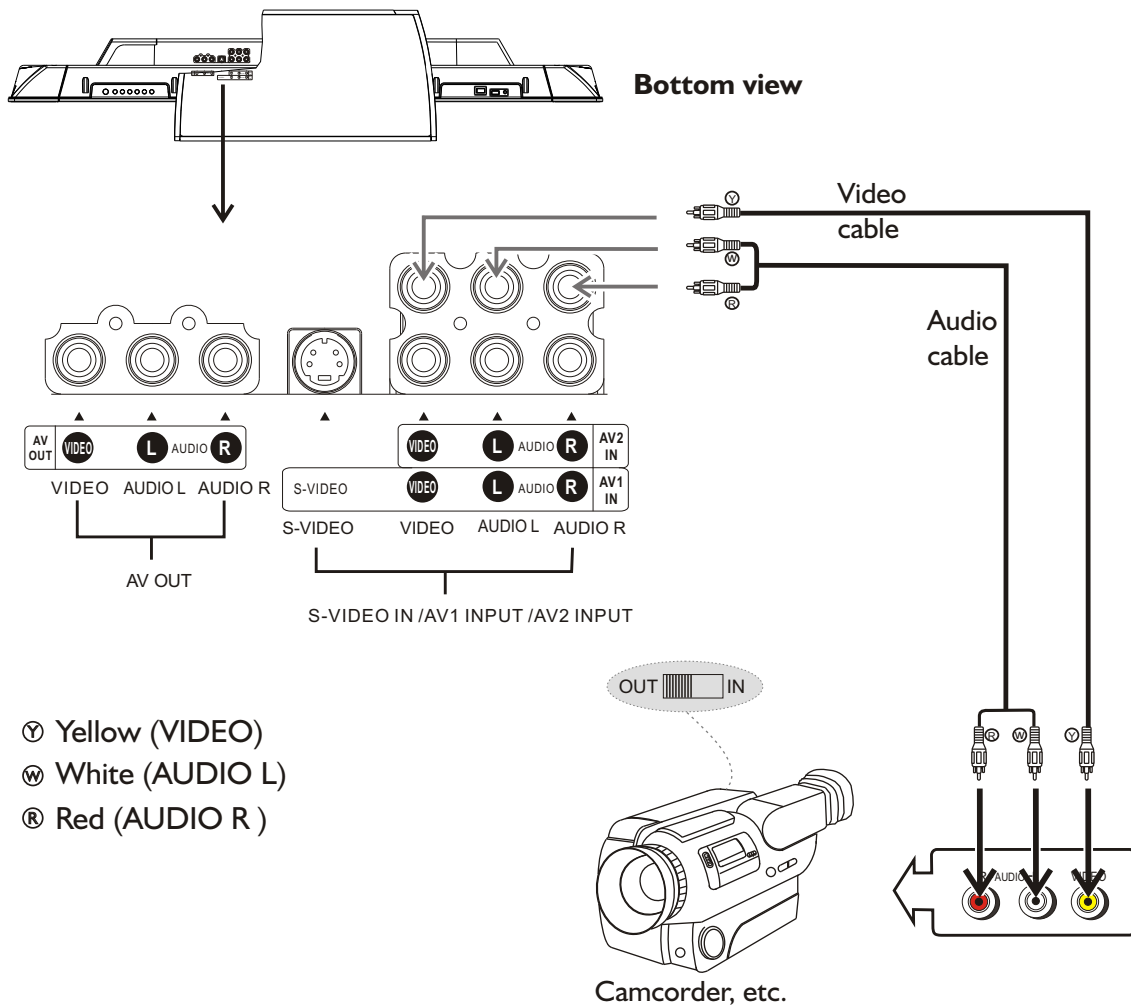

### How to connect:

Connect the Audio/Video cables between the Audio (L/R)/Video jacks on the unit and camcorder.

### To playback Camcorder

1. Turn on your LCD TV, press **INPUT** button on the remote control.
2. Press **▲** or **▼** to select **Video2** and press **OK** to confirm.
3. Turn on your camcorder and set it to output mode. (For details, refer to your camcorder owner's manual.)
4. Insert the tape into the camcorder and press Play button.

### Note:

The operations of the camcorder may be different and is dependent on your model. Please read the owner's manual of your camcorder to confirm operation.

Source Select  
VGA  
DVI  
RF  
Video1  
**Video2**  
YPbPr1  
YPbPr2

## Connections (continued)

### To connect Component input terminals

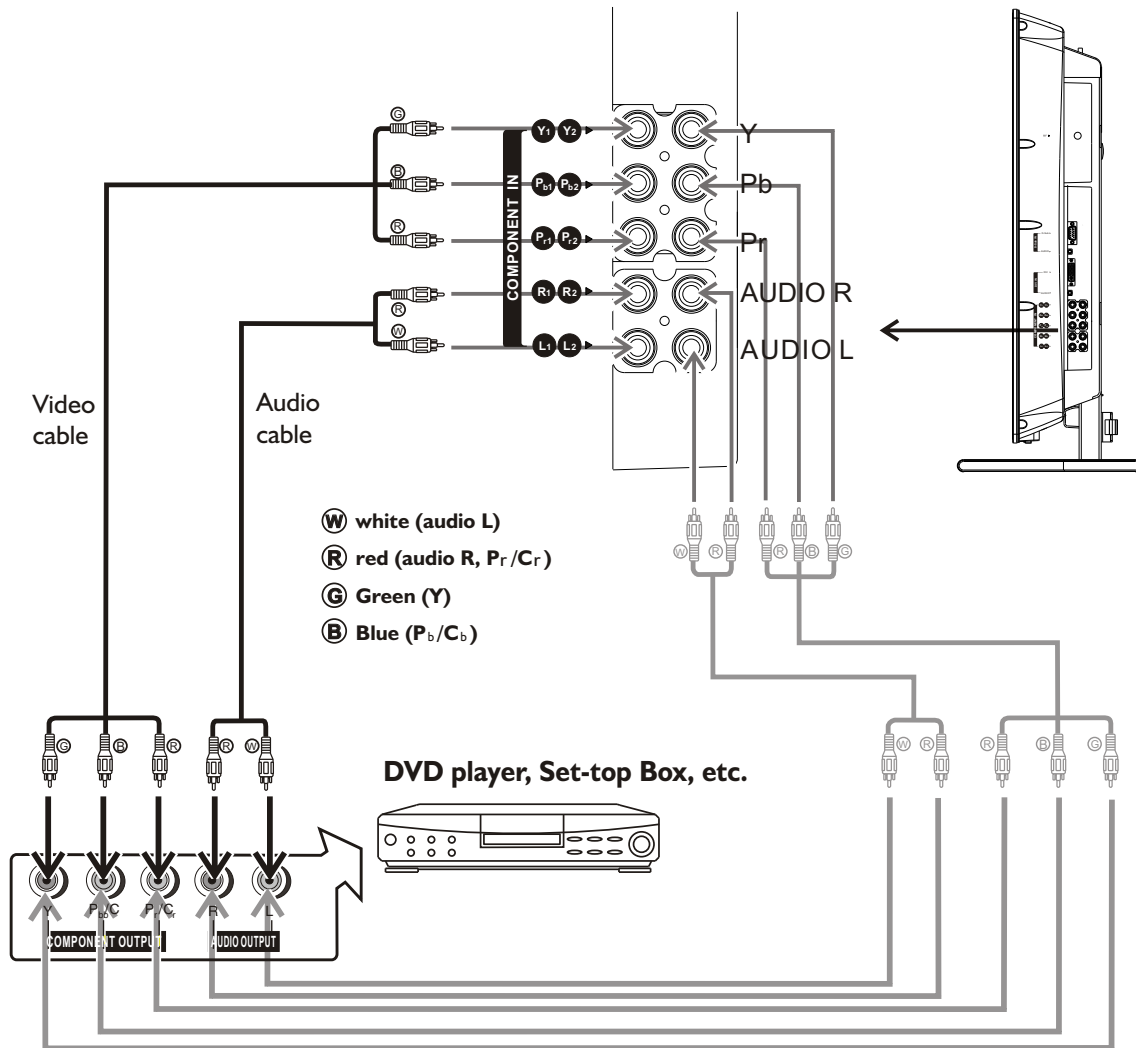

### How to connect a DVD Player (or Set-Top Box) using Component Video Connections:

Connect the Video cable between the Y, Pb, Pr input jacks on the unit and Y, Pb, Pr output jacks on the DVD player (or Set-Top Box).

Connect the Audio cable between the AUDIO input jacks on the unit and AUDIO output jacks on the DVD player (or Set-Top Box).

### To play DVD or Set-Top Box

1. Turn on your LCD TV, press **INPUT** button on the remote control.
2. Press **▲** or **▼** to select **YPbPr1** or **YPbPr2**.
3. Press **OK** to confirm.
3. Turn on your DVD player (or Set-Top Box).

Source Select  
VGA  
DVI  
RF  
Video1  
Video2  
YPbPr1  
**YPbPr2**

### Note:

The Y, Pb, Pr outputs on your DVD player are sometimes labeled Y, Cb, Cr or Y, U, V. If so, connect the cables to like colors.



## To connect DVI input

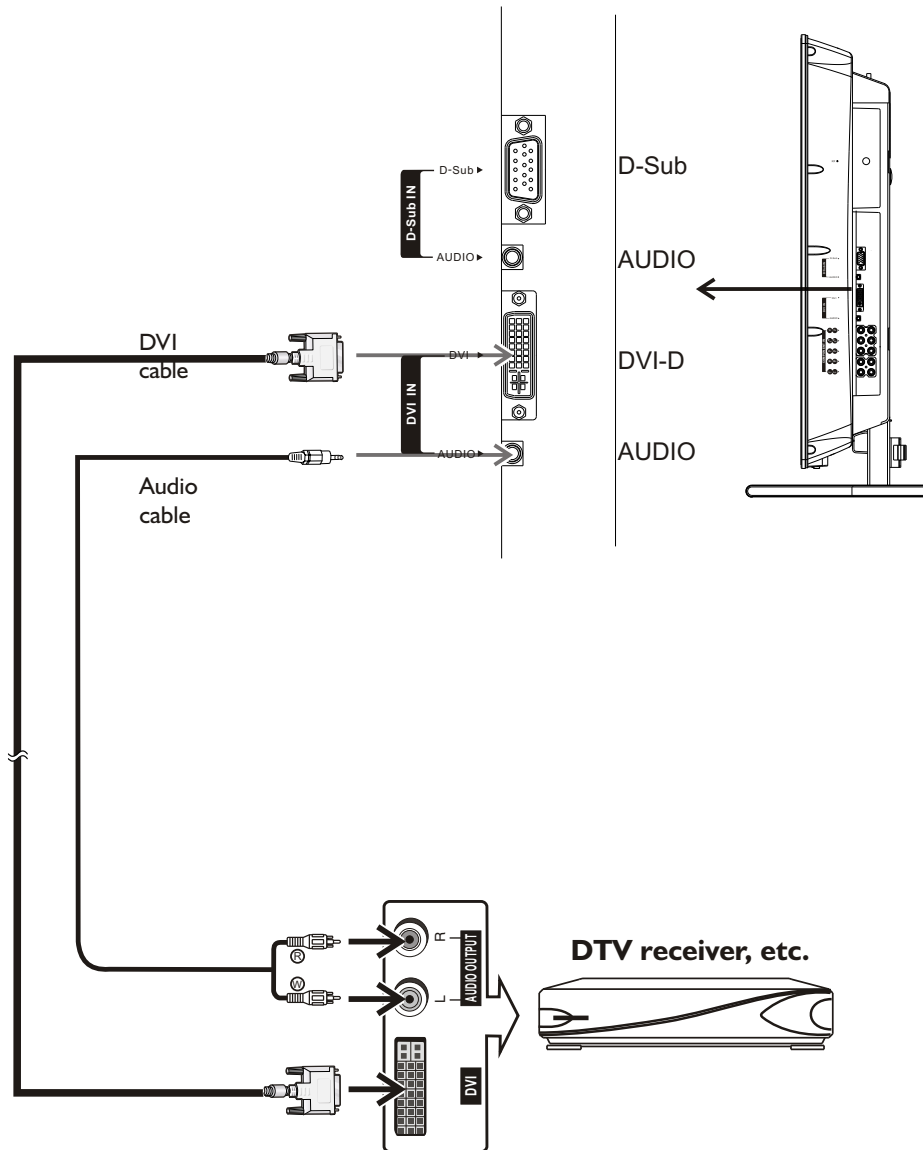

### How to connect:

Connect the cable or antenna to the antenna input jack on the DTV receiver. Connect the DVI cable between the DVI input interface on the unit and DVI output interface on the DTV receiver . Connect the Audio cable between the AUDIO input jack on the unit and AUDIO output jacks on the DTV receiver.

### To Watch DTV

1. Turn on your LCD TV , press **INPUT** button on the remote control.
2. Press **▲** or **▼** to select **DVI**.
3. Press **OK** to confirm.
4. Turn on your DTV receiver.

Source Select  
 VGA  
 DVI  
 RF  
 Video1  
 Video2  
 YPbPr1  
 YPbPr2

## Connections (continued)

### To connect D-Sub input

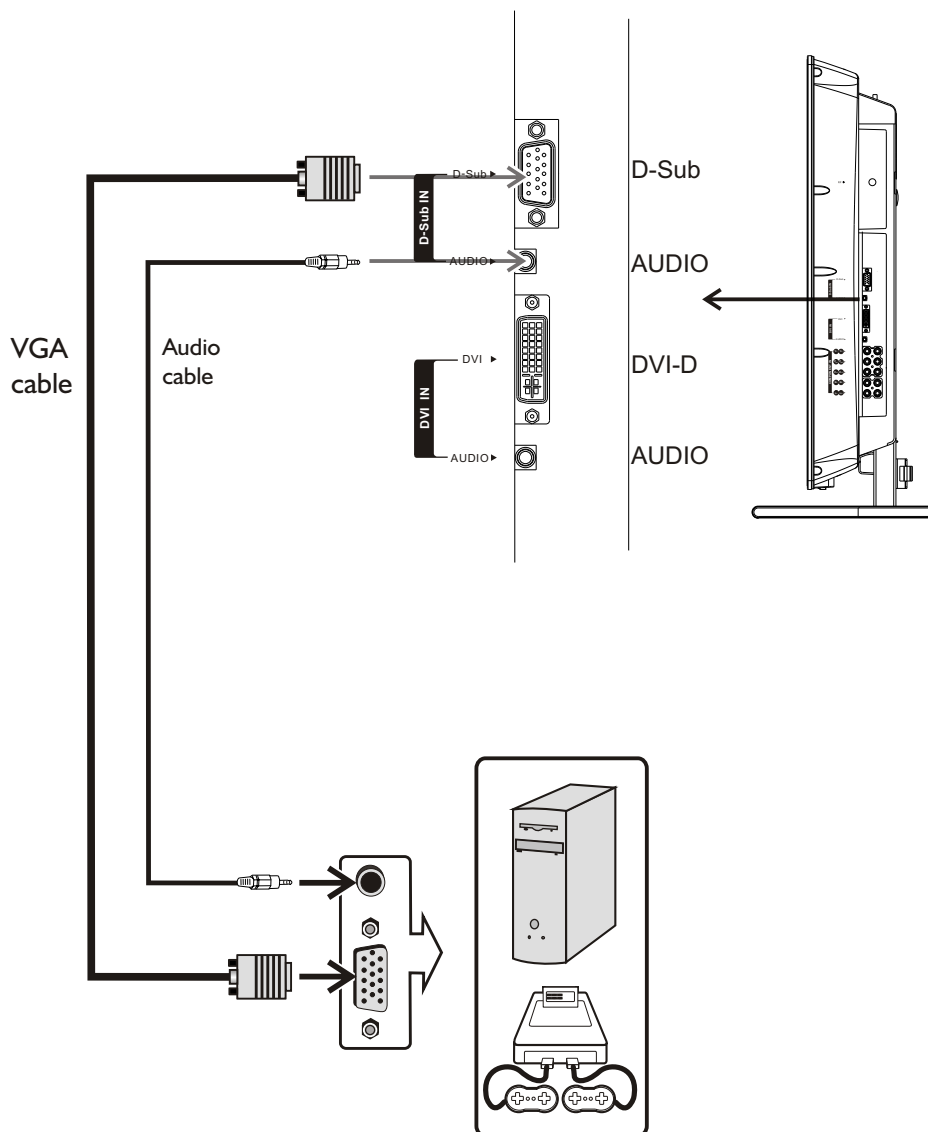

Computer or other equipment with VGA interface

#### How to connect:

Connect a VGA cable between the VGA jack on the PC and the VGA input jack on the unit.

Connect an Audio cable between the AUDIO output on the PC and AUDIO input jack on the unit.

#### To Watch the PC screen

1. Turn on your LCD TV, press **INPUT** button on the remote control.
2. Press **▲** or **▼** to select **VGA**.
3. Press **OK** to confirm.
4. Turn on your PC and check for PC system requirements.
5. Adjust the screen resolution and settings on your computer to the preferred settings.

Source Select

**VGA**  
DVI  
RF  
Video1  
Video2  
YPbPr1  
YPbPr2

## To connect AV output terminals

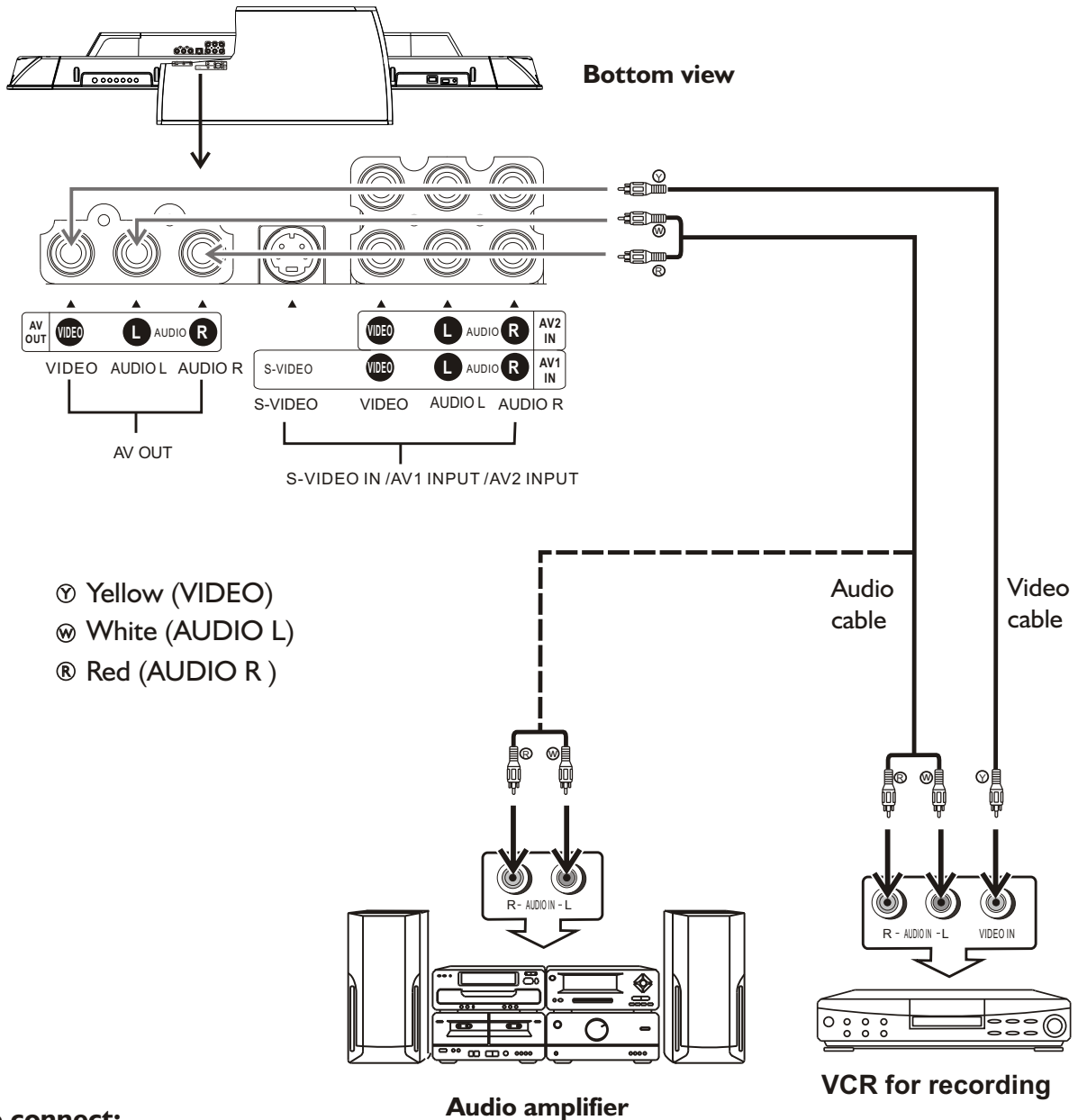

### How to connect:

Connect the Audio/Video cables between the Audio (L/R)/Video jacks on the unit and VCR.  
 Or connect the Audio cable between the Audio (L/R) jacks on the unit and Audio amplifier.

### How to record program

1. Turn on your LCD TV, select a program you wish to record.
2. Turn on your VCR, insert a videotape for recording.
3. Press the Record button to begin recording.

### How to enjoy high quality sound by Audio amplifier

1. Connect cables as shown above.
2. Turn the volume of the Audio amplifier to minimum.
3. Turn on the LCD TV and select source.
4. Turn on the audio amplifier and adjust for a proper volume.

### Note:

The AV output terminals output the audio/video signal from the Antenna input or AV inputs.

# Turning the Unit On and Off

## Turning the Unit On and Off

### Turning On

Insert the power cord into the wall outlet.  
Press the **Power**  button on the remote control.  
The unit will be turned on and you will be ready to use it's features.

### Turning Off

With the power on, press the **Power**  button on the remote control to turn off.

#### Note:

You can also use the **Power**  button on the control panel on the main unit.

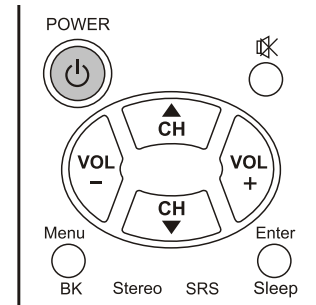





## Viewing the Menus and Displays

Your LCD TV has a simple, easy-to-use menu system that appears on the screen. This system makes it convenient and fast to use features on the unit. The unit also lets you display the status of many of your LCD TV features.

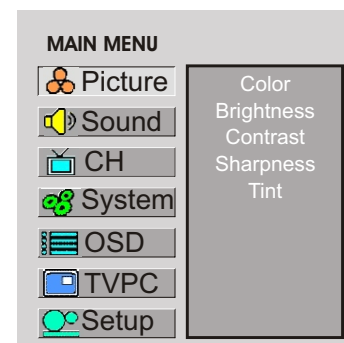
### Viewing the Menus

With the power on, press the **Menu** button on the remote control.  
The main menu appears on the screen. The picture menu is selected.



2 Use the **CH**  /  to select menu item. Use **VOL**  /  to adjust value of item. Use **Enter** to confirm, enter submenu or toggle the settings of the selected menu item.  
you can press the **Menu** button repeatedly to exit the menu operations.

#### Note:

To clearly introduce the menu operations, this operation manual provides a description based on operation with the remote control.

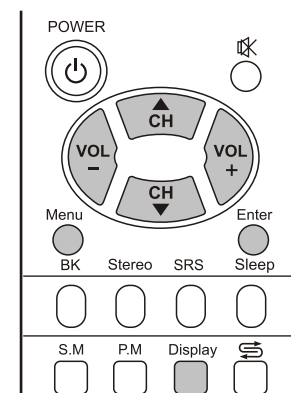

### Displaying Status Information

Press the **Display** button on the remote control, the unit will display current status information such as channel number, audio mode or signal source, etc.

# Memorizing the Channels

Your LCD TV can memorize and store all the available channels for both antenna and cable channels. After the available channels are memorized, use CH ▲ / ▼ to scan the channels.

## Selecting the Signal Source

Before your LCD TV can memorize the available channels, you must specify the type of signal source that is connected to the unit. (i.e., an antenna or cable system)

- 1 Press **Menu** to display the menu main page.
- 2 Press **CH ▲ / ▼** repeatedly to select **CH** item.
- 3 Press **Enter** to access the submenu.  
The **TV/Cable** menu item will be highlighted automatically.
- 4 Press **Enter** to toggle **TV** or **Cable**.  
If you are connected to an antenna, please select TV. If you connect cable, please select cable.

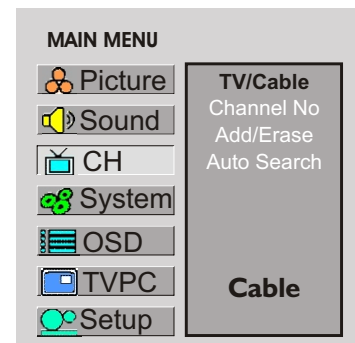
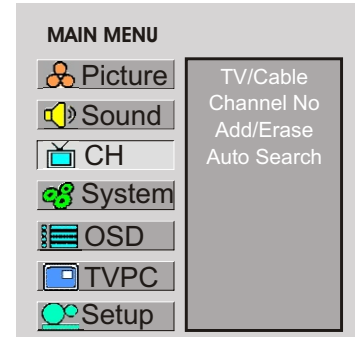

## Storing Channels in Memory Automatically

- 1 Press **Menu** to display the menu main page.
- 2 Press **CH ▲ / ▼** repeatedly to select **CH** item.
- 3 Press **Enter** to access the submenu.
- 4 Press **CH ▼** repeatedly to highlight **Auto Search** item.
- 5 Press **Enter** to store channels in memory automatically.  
The unit will begin memorizing all the available channels. During the process of the Auto Search, you can press **Menu** to exit.

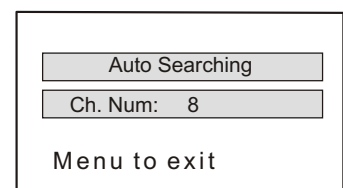
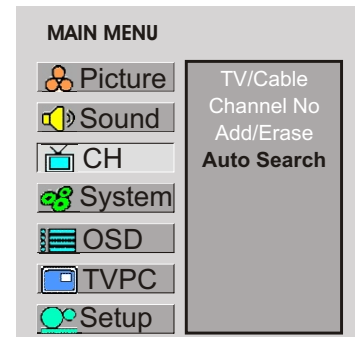

# Memorizing the Channels (continued)

## Adding and Erasing Channels

- 1 Press **Menu** to display the menu main page.
- 2 Press **CH** ▲/▼ repeatedly to select **CH** item.
- 3 Press **Enter** to access the submenu.
- 4 Press **CH** ▼ to highlight **Channel No** item.
- 5 Press **VOL** +/- to select a channel number you want to add or erase.  
You can also use number buttons to select a desired channel number directly.
- 6 Press **CH** ▼ to highlight **Add/Eraser** item.
- 7 Press **Enter** to toggle **Add** or **Erase**.  
When the item is set to erase, the selected channel will be erased.  
When the item is set to add, the selected channel will be added.

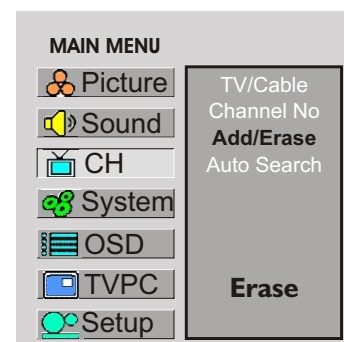
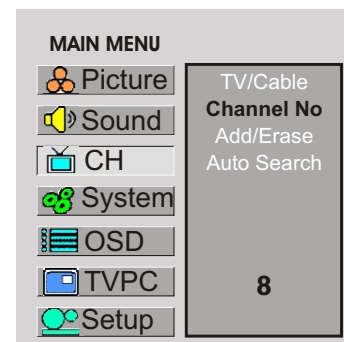

## Changing Channels

### Using the Channel Buttons (CH▲ or CH▼)

---

Press the **CH▲** or **CH▼** to change channels.

When you press the **CH▲** or **CH▼**, the unit changes channels in sequence. You will see all the channels that the unit has memorized.

You will not see channels that were erased.

### Direct Accessing Channels

---

Press the **number buttons** to go directly to a channel.

To select a one-digit channel: press the **0-9 number buttons** to input the channel number and the unit automatically goes to the selected channel in some seconds.

To select a two-digit channel: press the **0-9 number buttons** to input the channel number and the unit goes to the selected channel immediately.

To select a three-digit channel: press the --- button to display "1--", then press the **0-9 number buttons** to input the remain two digits of the channel number, then the unit goes to the selected channel.

#### Note:

*When you use the number buttons, you can directly select channels that were erased.*

### Using the Return ⏪ button

---

Press this button to switch between the current channel and the previous channel.

## Adjusting the Volume

### Using the volume buttons (VOL+ and VOL-)

---

Press the **VOL+** or **VOL-** to increase or decrease the volume.

## Using the Mute

### Using the Mute 🔇 button

---



At any time, you can temporarily cut off the sound using the Mute button.

1 Press the 🔇 button and the sound cuts off.

2 To turn mute off, press the 🔇 button again.

## Basic Operations (continued)

### Selecting Input Source Signal

- 1 Press the **Source**  button to access **Source Select** menu.
- 2 Press **CH**  or **CH**  to select a desired input source.
- 3 Press **Enter** to confirm and the unit displays signal from the selected input source.

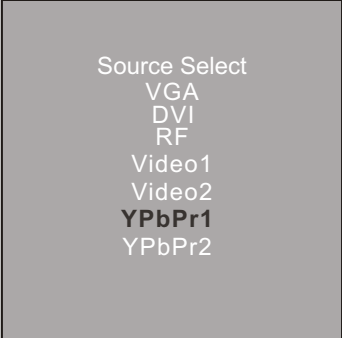

Source Select  
VGA  
DVI  
RF  
Video1  
Video2  
**YPbPr1**  
YPbPr2

**VGA** ---Select signal from VGA (15-pin D-sub) interface.

**DVI** ----Select signal from DVI interface.

**RF** -----Select TV signal.



**Video1**-----Select signal from AV1 IN terminals.

**Video2**-----Select signal from AV2 IN terminals.

**YPbPr1**-----Select signal from YPbPr1.





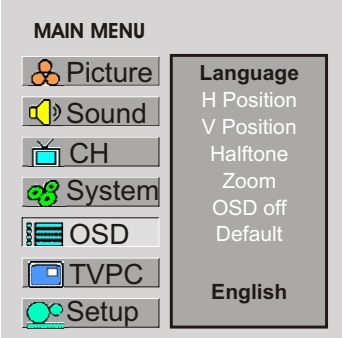

**YPbPr2**-----Select signal from YPbPr2.

### Selecting a Menu Language

- 1 Press **Menu** to display the menu main page.
- 2 Press **CH**  /  repeatedly to select **OSD** item.
- 3 Press **Enter** to access the submenu.  
The **Language** item will be highlighted automatically.
- 4 Press **Enter** to toggle between **English**, **French** and **Spanish**.
- 5 Press **Menu** to exit.

#### MAIN MENU



 **Picture**  
 **Sound**  
 **CH**  
 **System**  
 **OSD**  
 **TVPC**  
 **Setup**

#### Language

H Position  
V Position  
Halftone  
Zoom  
OSD off  
Default

**English**



## Customizing the Picture

- 1 Press **Menu** to display the menu main page.  
The picture menu page will be displayed automatically.
- 2 Press **Enter** to access the **Picture** submenu.
- 3 Press **CH** ▲ / ▼ to select the item you wish to change.
- 4 Press **VOL** +/- to adjust the value of the item.
- 5 Press **Menu** to exit.

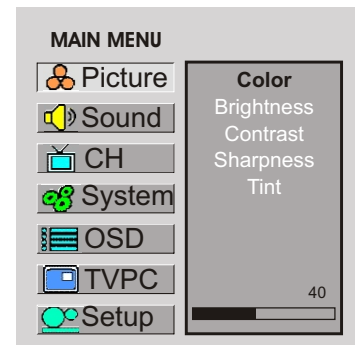

### In TV/Video mode

Option	Function	Operation	Range
Color	Adjusts color saturation.	VOL+ deeper VOL- paler	0~100
Brightness	Adjusts screen brightness for easier viewing of dark picture such as night scenes and black hair.	VOL+ lighter VOL- darker	0~100
Contrast	Adjusts image contrast.	VOL+ stronger VOL- weaker	0~100
Sharpness	Adjusts image sharpness and displays a sharp image.	VOL+ sharper VOL- softer	0~100
Tint	Adjusts tint for image.	VOL+ greenish VOL- purplish	0~100

### In VGA/DVI mode

Option	Function	Operation	Range
Brightness	Adjusts screen brightness for easier viewing of dark picture such as night scenes and black hair.	VOL+ lighter VOL- darker	0~100
Contrast	Adjusts image contrast.	VOL+ stronger VOL- weaker	0~100
Sharpness	Adjusts image sharpness and displays a sharp image.	VOL+ sharper VOL- softer	0~100
Color Temp	Adjusts preset color temperature.	Use <b>Enter</b> to toggle	6500K 9300K 12000K

## Using the Preset Picture Mode

Use the **PM** button to quickly select picture mode. There are three preset picture modes (**Bright**, **Soft** and **Nature**) and one user-set picture mode (**User**). Each preset mode has its own picture settings.

**Bright:** Select for a bright picture.

**Soft:** Select for a finely detailed picture.

**Nature:** Select for a normal picture.

Adjusted settings are stored in User mode.

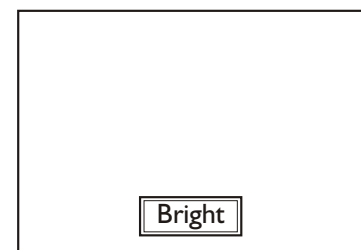

# Setting System

## Setting System In TV Mode

### Adjusting Screen Aspect

- 1 Press **Menu** to display the menu main page.
- 2 Press **CH ▲/▼** repeatedly to select **System** item.
- 3 Press **Enter** to access the submenu.  
The **Aspect Ratio** item will be highlighted automatically.
- 4 Press **Enter** repeatedly to select a desired aspect ratio.  
You can select the image aspect ratio between **4:3**, **Panorama**, **Zoom** and **16:9**.  
**4:3** — For 4:3 signal format. This mode displays a 4:3 picture at its standard 4:3 size without any stretching.  
**16:9** — For 16:9 signal format. This mode displays 16:9 aspect ratio picture.  
**Panorama** — In this mode the picture is progressively stretched toward each side of the screen.  
**Zoom** — For 4:3 letterbox signal format. This mode stretches the picture horizontally and crops the top and bottom black bars of the picture.

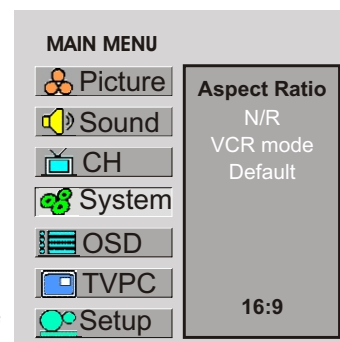

#### Note:

You may quickly select the screen aspect by using the **Screen** button on the remote control.

### Reducing Picture Noise

- 1 Press **Menu** to display the menu main page.
- 2 Press **CH ▲/▼** repeatedly to select **System** item.
- 3 Press **Enter** to access the submenu.
- 4 Press **CH ▲/▼** repeatedly to select **N/R** item.
- 5 Press **Enter** to select **Off**, **Auto**, **Strong**, **Middle** or **Weak**.  
Sometimes a noisy picture may appear on the screen because of poor signal. This function helps to enhance the picture quality by reducing the noise.

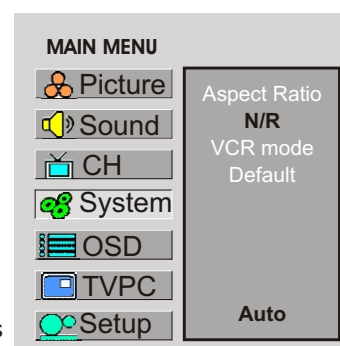

### VCR mode

- 1 Press **Menu** to display the menu main page.
- 2 Press **CH ▲/▼** repeatedly to select **System** item.
- 3 Press **Enter** to access the submenu.
- 4 Press **CH ▲/▼** repeatedly to select **VCR mode** item.
- 5 Press **Enter** to select **On** or **Off**.

When you are watching VCR program type or receiving weak signal, please set the "VCR mode" item to "On". It helps to obtain a better synchronization and improve

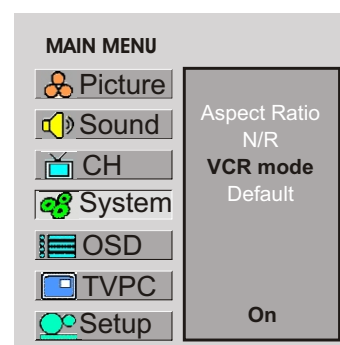

### Loading Default Values

You may quickly load default values by using the **Default** item.

## Setting System In VGA Mode

### Changing the Position of Image

The unit allows you to adjust the position of the screen if it is not well-aligned.

- 1 Press **Menu** to display the menu main page.
- 2 Press **CH ▲/▼** repeatedly to select **System** item.
- 3 Press **Enter** to access the submenu.
- 4 Press **CH ▲/▼** to select **H position** or **V position** item.
- 5 Press **VOL +/-** to adjust the value of the item until the screen is well-aligned.

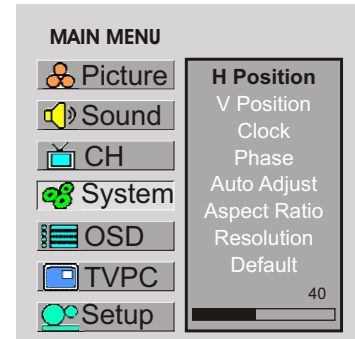

### Adjusting Clock and Phase

- 1 Press **Menu** to display the menu main page.
- 2 Press **CH ▲/▼** repeatedly to select **System** item.
- 3 Press **Enter** to access the submenu.
- 4 Press **CH ▲/▼** to select **Clock** or **Phase** item.
- 5 Press **VOL +/-** to adjust the value of the item until the screen is well-aligned.

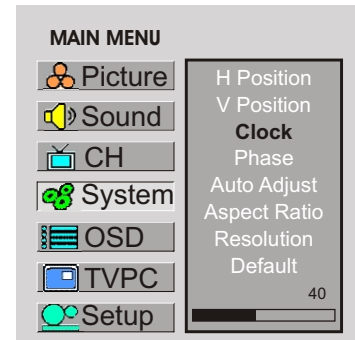

Adjust the clock frequency of the set's internal clock signal. If shimmering or rainbow-like noise is apparent in the image, try adjusting the clock frequency setting.

You may find that images blur, depending on the clock phase of your PC's Processor. If you experience blurring, you can obtain a clearer image by adjusting the phase setting.

### Adjusting the Picture Automatically

- 1 Press **Menu** to display the menu main page.
- 2 Press **CH ▲/▼** repeatedly to select **System** item.
- 3 Press **Enter** to access the submenu.
- 4 Press **CH ▲/▼** repeatedly to select **Auto Adjust** item.
- 5 Press **Enter** to confirm.

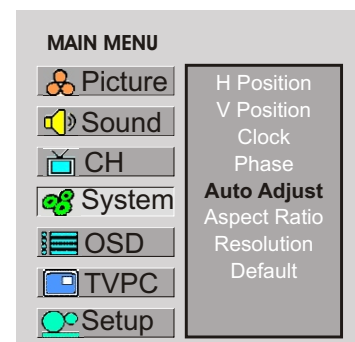

You may quickly adjust the picture by using the **Auto** button directly. The unit automatically adjusts phase, clock or position, etc.

The Auto Adjust function only works when the picture is displayed in 16:9 with full screen.

# Setting System (continued)

---

## Setting System In VGA Mode(continued)

### Adjusting Screen Aspect

---

- 1 Press **Menu** to display the menu main page.
- 2 Press **CH ▲/▼** repeatedly to select **System** item.
- 3 Press **Enter** to access the submenu.
- 4 Press **CH ▲/▼** repeatedly to highlight **Aspect Ratio** item.
- 5 Press **Enter** repeatedly to select **4:3** or **16:9**.

**Note:**

You may quickly select the screen aspect by using the **Screen** button on the remote control.

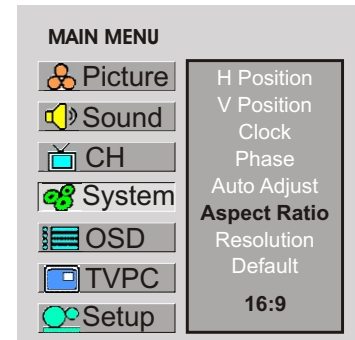

### Displaying Resolution Information

---

You may quickly display the resolution information by using the **Resolution** item.

### Loading Default Values

---

You may quickly load default values by using the **Default** item.

## Setting System In YPbPr Mode

### Adjusting Phase

- 1 Press **Menu** to display the menu main page.
- 2 Press **CH ▲/▼** repeatedly to select **System** item.
- 3 Press **Enter** to access the submenu.  
The **Phase** item will be highlighted automatically.
- 4 Press **VOL +/-** repeatedly to adjust the value.

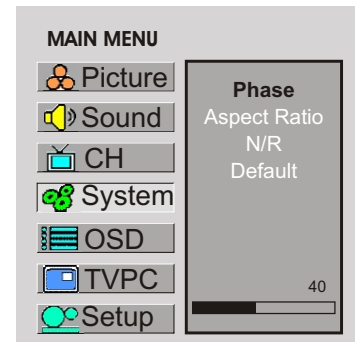

### Adjusting Screen Aspect

- 1 Press **Menu** to display the menu main page.
- 2 Press **CH ▲/▼** repeatedly to select **System** item.
- 3 Press **Enter** to access the submenu.
- 4 Press **CH ▲/▼** repeatedly to highlight **Aspect Ratio** item.
- 5 Press **Enter** repeatedly to select a desired aspect ratio.

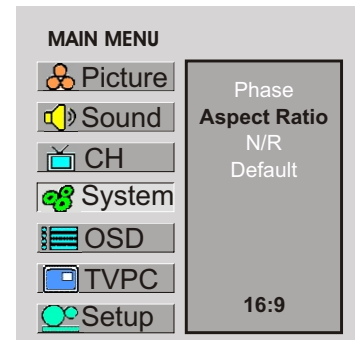

For 480i or 480P signal format, you can select the image aspect ratio between **4:3**, **16:9**, **Panorama** and **Zoom**.

For 720P or 1080i signal format, you can select the image aspect ratio between **4:3** and **16:9**.

**Note:**

You may quickly select the screen aspect by using the **Screen** button on the remote control.

### Reducing Picture Noise

- 1 Press **Menu** to display the menu main page.
- 2 Press **CH ▲/▼** repeatedly to select **System** item.
- 3 Press **Enter** to access the submenu.
- 4 Press **CH ▲/▼** repeatedly to select **N/R** item.
- 5 Press **Enter** repeatedly to select **Off**, **Auto**, **Strong**, **Middle** or **Weak**.

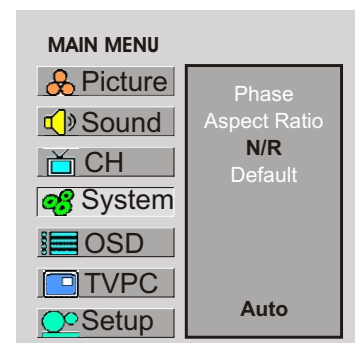

### Loading Default Values

You may quickly load default values by using the **Default** item.

## Setting System (continued)

---

### Setting System In DVI Mode

#### Adjusting Screen Aspect

---

- 1 Press **Menu** to display the menu main page.
- 2 Press **CH** ▲ / ▼ repeatedly to select **System** item.
- 3 Press **Enter** to access the submenu.  
The **Aspect Ratio** item will be highlighted automatically.
- 4 Press **Enter** repeatedly to select **4:3** or **16:9**.

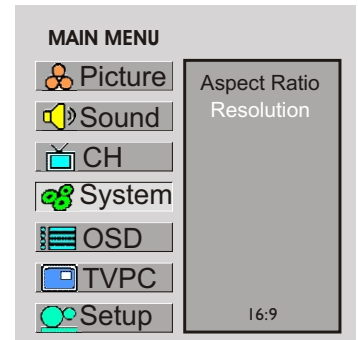

**Note:**

You may quickly select the screen aspect by using the **Screen** button on the remote control.

#### Displaying Resolution Information

---

- 1 Press **Menu** to display the menu main page.
- 2 Press **CH** ▲ / ▼ repeatedly to select **System** item.
- 3 Press **Enter** to access the submenu.
- 4 Press **CH** ▼ to select **Resolution** item.  
Now the resolution information will be displayed.

## Customizing the Sound

- 1 Press **Menu** to display the menu main page.
- 2 Press **CH** ▲/▼ repeatedly to select **Sound** item.
- 3 Press **Enter** to access the submenu.
- 4 Press **CH** ▲/▼ repeatedly to select the option items you want to adjust.
- 5 Press **VOL** +/- to adjust the value or **Enter** to toggle settings.

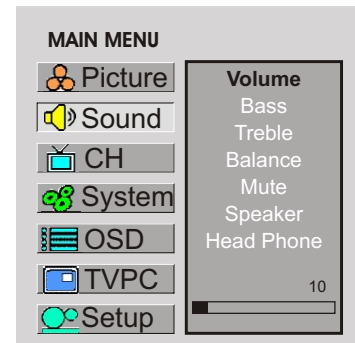

Option	Function	Operation	Range
Volume	Adjusts volume value.	VOL+ stronger VOL- weaker	0~100
Bass	Adjusts Bass (low sounds)	VOL+ stronger VOL- weaker	0~100
Treble	Adjusts Treble (high sounds).	VOL+ stronger VOL- weaker	0~100
Balance	Adjusts volume balance (left and right volumes).	VOL+ Higher volume from right speaker. VOL- Higher volume from left speaker.	0~100
Mute	Mutes the sound	Use Enter to toggle	On or Off
Speaker	Turns on or off speaker sound output	Use Enter to toggle	On or Off
Head Phone	Turns on or off headphone sound output	Use Enter to toggle	On or Off

## Using the Preset Sound Mode

Use the **S.M** button to quickly select sound mode. There are three preset sound modes (**Movie**, **Music** and **News**) and one user-set sound mode (**User**). Each preset mode has its own sound settings (Bass and Treble).  
**Movie**: Select for a movie program.  
**Music**: Select for a music program.  
**News**: Select for a speech or conversation program.  
 Adjusted settings are stored in **User** mode.



## Setting SRS effect

Use the **SRS** button to quickly turn on or off the SRS effect. **SRS** (Sound Retrieval System®) is an audio enhancement technology that restores the spatial cues that are present in a live listening environment and processes it to provide a natural 3D sound field.  
 \* The SRS symbol are trademark of SRS Labs, Inc.  
 SRS technology is incorporated under license from SRS Labs, Inc.

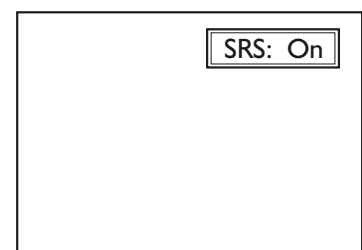

### Note:

When the **SRS** effect is set to **On**, the **SRS** function may affect the setting of **Balance** item.

# Adjusting On-Screen Display

## Adjusting OSD Position

- 1 Press **Menu** to display the menu main page.
- 2 Press **CH ▲/▼** repeatedly to select **OSD** item.
- 3 Press **Enter** to access the submenu.
- 4 Press **CH ▲/▼** repeatedly to select **H Position** or **V Position** item.
- 5 Press **VOL +/-** to adjust the OSD position.

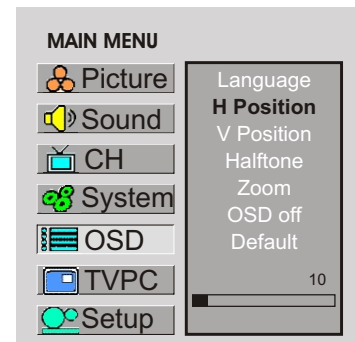

## Adjusting OSD Transparency

- 1 Press **Menu** to display the menu main page.
- 2 Press **CH ▲/▼** repeatedly to select **OSD** item.
- 3 Press **Enter** to access the submenu.
- 4 Press **CH ▲/▼** repeatedly to select **Halftone** item.
- 5 Press **VOL +/-** to adjust the OSD transparency.

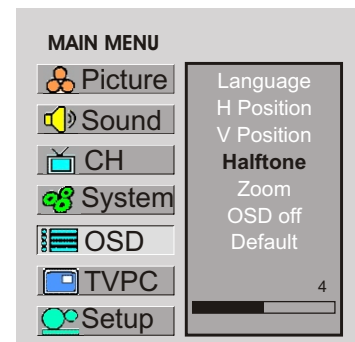

## Zooming OSD Menu

- 1 Press **Menu** to display the menu main page.
- 2 Press **CH ▲/▼** repeatedly to select **OSD** item.
- 3 Press **Enter** to access the submenu.
- 4 Press **CH ▲/▼** repeatedly to select **Zoom** item.
- 5 Press **Enter** repeatedly to select **Normal** or **Zoom**.

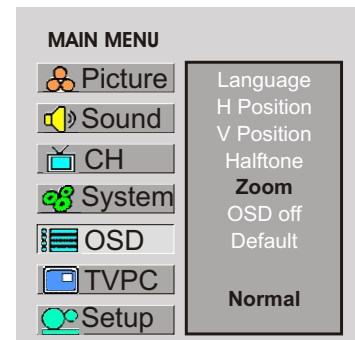

### Note:

When you zoom in the OSD menu, the **V position** item is unadjustable

## Setting OSD Off Time

This setting allows you to set the time that the OSD for the main menu is displayed onscreen.

- 1 Press **Menu** to display the menu main page.
- 2 Press **CH ▲/▼** repeatedly to select **OSD** item.
- 3 Press **Enter** to access the submenu.
- 4 Press **CH ▲/▼** repeatedly to select **OSD Off** item.
- 5 Press **Enter** repeatedly to select a proper time.  
You may select between 5 seconds, 10 seconds, 20 seconds, 50 seconds or 200 seconds.

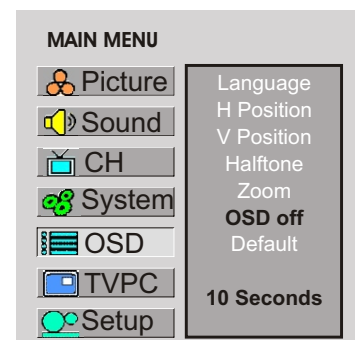

## Loading default values

You may quickly load default values by using the **Default** item.



## Viewing the TVPC

The **TVPC** function is available only when the main frame is in **VGA/DVI** mode and the aspect ratio is in **16:9** and the vertical frequency is **60 Hz**.

- 1 Press **Menu** to display the menu main page.
- 2 Press **CH** ▲/▼ repeatedly to select **TVPC** item.
- 3 Press **Enter** to access the submenu.  
The **TVPC** item will be highlighted automatically.
- 4 Press **Enter** to select **On** or **Off**.

**Note:**

- ▶ You may quickly open or close **TVPC** frame by using the **TVPC** button directly.
- ▶ Audio is from the main picture only.

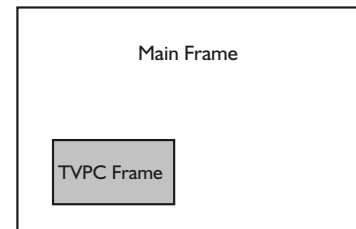
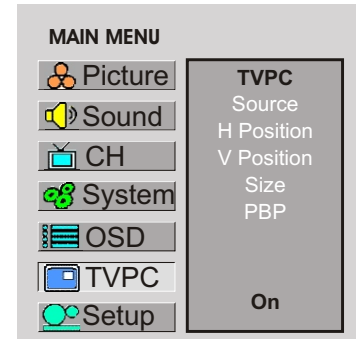

## Selecting the Signal Source for the TVPC Frame

- 1 Press **Menu** to display the menu main page.
- 2 Press **CH** ▲/▼ repeatedly to select **TVPC** item.
- 3 Press **Enter** to access the submenu.
- 4 Press **CH** ▲/▼ repeatedly to select **Source** item.
- 5 Press **Enter** repeatedly to select signal source for the TVPC frame.  
You may select **RF**, **Video1**, **Video2** or **YPbPr** for the TVPC Frame.

**Note:**

You may quickly select signal source for the **TVPC** frame by using the **P.S.** button.

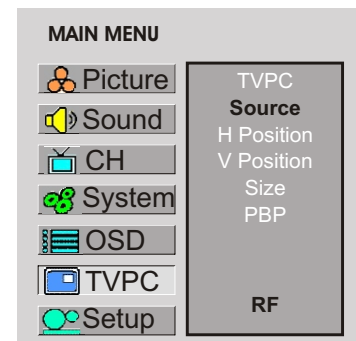

## Changing Channels for the TVPC Frame

When the **TVPC** frame is in **TV** mode, press the **up** or **down** button to change channels.

When you press the **up** or **down**, the unit changes channels in sequence. You will see all the channels that the unit has memorized.

You will not see channels that were erased.

# TVPC Operations (continued)

## Changing the Position of the TVPC Frame

- 1 Press **Menu** to display the menu main page.
- 2 Press **CH ▲/▼** repeatedly to select **TVPC** item.
- 3 Press **Enter** to access the submenu.
- 4 Press **CH ▲/▼** repeatedly to select **H Position** or **V Position** item.
- 5 Press **VOL +/-** to adjust the TVPC frame position.

**Note:**

You can quickly adjust TVPC position by using the **POS** button.

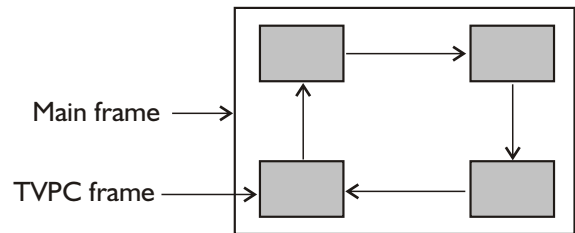
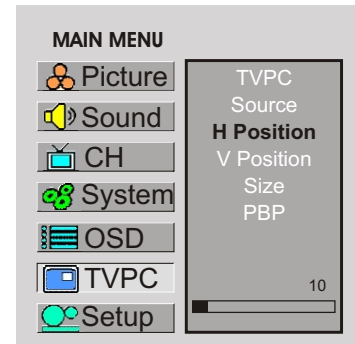

## Adjusting the Size of TVPC Frame

- 1 Press **Menu** to display the menu main page.
- 2 Press **CH ▲/▼** repeatedly to select **TVPC** item.
- 3 Press **Enter** to access the submenu.
- 4 Press **CH ▲/▼** repeatedly to select **Size** item.
- 5 Press **Enter** to adjust the TVPC frame size.

**Note:**

You may quickly adjust TVPC size by using the **Size** button.

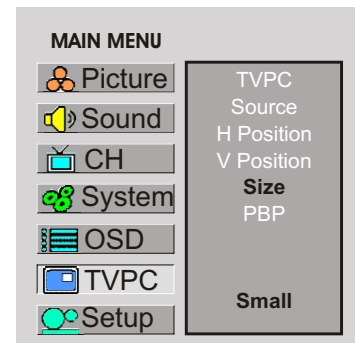

## Viewing Picture-by-Picture

You may view double windows by using **PBP** function.

- 1 Without TVPC function working, press **Menu** to display the menu main page.
- 2 Press **CH ▲/▼** repeatedly to select **TVPC** item.
- 3 Press **Enter** to access the submenu.
- 4 Press **CH ▲/▼** repeatedly to select **PBP** item.
- 5 Press **Enter** to turn on or off **PBP** function.

**Note:**

- You can quickly switch to PBP mode by using the **PBP** button.
- In PBP mode, the **H Position** and **V Position** item do not work if they are adjusted.

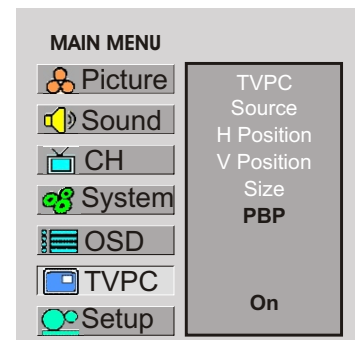

## Setting Sleep Timer

Press the **Sleep** button repeatedly to set a sleep time to automatically turn off the unit. Each press of the button, the value changes as below.

Off → 5 minutes → 10 minutes → 15 minutes → 30 minutes

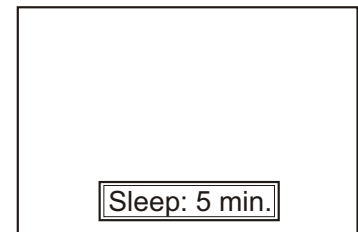

## Setting Audio Mode

Press the **Stereo** button repeatedly to select the audio mode between **MONO**, **SAP** and **STEREO**.

Choose **STEREO** for channels that are broadcasting in stereo.

Choose **MONO** for channels that are broadcasting in mono, or if you are having difficulty receiving a stereo signal.

Choose **SAP** to listen to the Second Audio Program, which is usually a foreign-language translation of a program.

## Adjusting Back Light of the Panel

Press the **BK** button repeatedly to select the back light of the panel. There are several levels of the back light for adjustment.

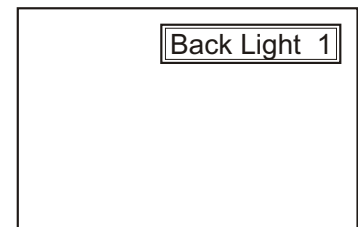

## Freezing the Picture

Press the **Still** button to hold on the image on the screen (the video sources still run). Press again to reactivate the image.

**Note:**

*The freeze function works in TV, Video mode only.*

*For the sake of protecting the screen, please do NOT freeze a picture for a long time.*

# Viewing Closed Captions



The unit decodes and displays the closed captions that are broadcast with certain TV shows. These captions are usually subtitles for the hearing impaired or foreign language translations. All VCRs record the closed caption signal from television programs, so home-recorded video tapes also provide closed captions. Most prerecorded commercial video tapes provide closed captions as well. Check for the closed caption symbol in your television schedule and on the tape's packaging: .

## Note:

The Caption feature does not work with YPbPr, VGA, DVI.



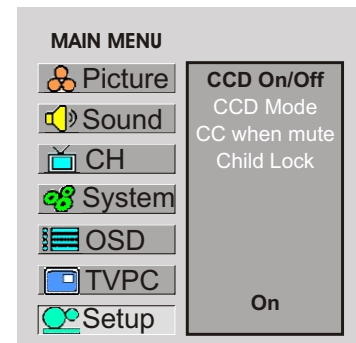

Not all the programs and videos will offer closed captioning. Please look for the  symbol to ensure that captions will be shown.

## Turning Closed Caption On or Off

- 1 Press **Menu** to display the menu main page.
- 2 Press **CH**  /  repeatedly to select **Setup** item.
- 3 Press **Enter** to access the submenu.  
The **CCD On/Off** item will be highlighted automatically.
- 4 Press **Enter** to select **On** or **Off**.



## Setting Closed Caption

- 1 Press **Menu** to display the menu main page.
- 2 Press **CH**  /  repeatedly to select **Setup** item.
- 3 Press **Enter** to access the submenu.
- 4 Press **CH**  /  repeatedly to select **CCD mode** item.
- 5 Press **Enter** repeatedly to select a desired mode.

You may select between CC-1, CC-2, CC-3, CC-4, T-1, T-2, T-3 and T-4.

The Closed Caption broadcasts can be viewed in two modes: CAPTION and TEXT. For each mode, four channels are available.

The [CAPTION] mode shows subtitles of dialogues and commentaries of TV dramas and news programs while allowing a clear view of the picture.



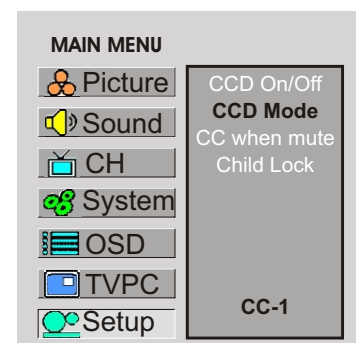

The [TEXT] mode displays various information over the picture (such as TV program schedule, weather forecast, etc.) that is independent of the TV programs.

## Note:

You may quickly select CCD mode by using the **CCD** button directly.



## Setting CC When Mute

- 1 Press **Menu** to display the menu main page.
  - 2 Press **CH**  /  repeatedly to select **Setup** item.
  - 3 Press **Enter** to access the submenu.
  - 4 Press **CH**  /  repeatedly to select **CC when mute** item.
  - 5 Press **Enter** to select **On** or **Off**.
- If you set this item to **On**, the unit display closed caption when you mute the sound.

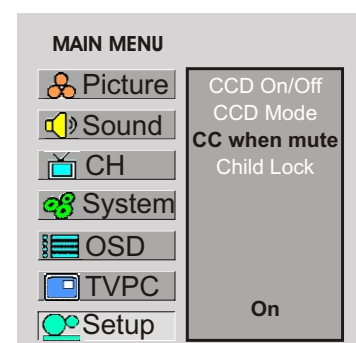

# Adjusting Child Lock Settings

## Child Lock

This function allows TV programs to be restricted and TV usage to be controlled based on FCC data. It prevents children from watching violent or sexual scenes that may be harmful.

Restriction of TV programs includes two ratings that contain information about the program: the MPAA rating and the TV Parental Guidelines. The MPAA rating is restricted by age. TV Parental Guidelines are restricted by age and content.

Since a TV program may use either the MPAA rating or the TV Guidelines, both should be adjusted for complete control.

### [1] Movie Rating (MPAA)

Rating		
age based	G	GENERAL AUDIENCES. All ages admitted.
	PG	PARENTAL GUIDANCE SUGGESTED. Some material may not be suitable for children.
	PG-13	PARENTAL STRONGLY CAUTIONED. Some material may be inappropriate for children under 13.
	R	RESTRICTED. Under 17 requires accompanying parent or adult guardian.
	NC-17	NO ONE 17 AND UNDER ADMITTED.
	X	X Rating is an older rating that is unified with NC-17 but may be encoded in the data of older movies.
	N/A	NOT RATED.

**Note:**

The Movie rating is only age-based.

Example 1:

“PG-13” in the age-based rating is blocked, this will automatically block the higher ratings “R”, “NC-17”, “X” also.

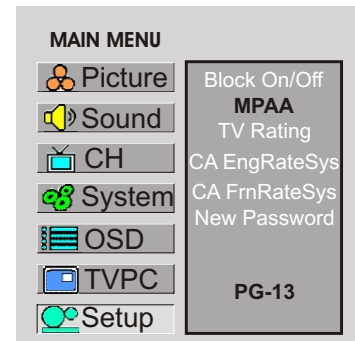

Example 2:

“R” in the age-based rating is blocked, this will automatically block the higher rating “NC-17”, “X” also.

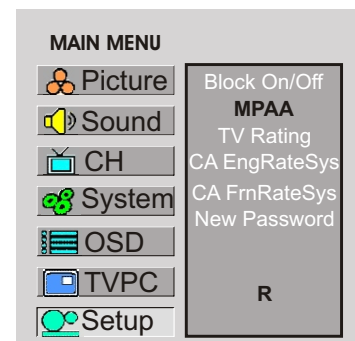

“Child Lock Block” with a green screen will be displayed if you watch the program with Program Rating data as same as you configured.

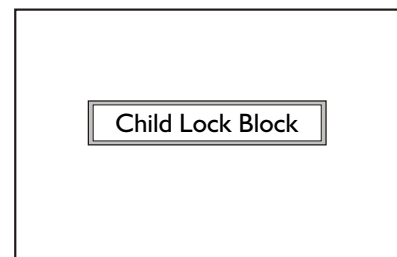

# Adjusting Child Lock Settings (continued)

## [2] TV Rating

Rating		← content based →				
		D	L	S	V	FV
age based	TV-Y (All children)	×	×	×	×	×
	TV-Y7 (Direct to Older Children)	×	×	×	×	●
	TV-G (General Audience)	×	×	×	×	
	TV-PG (Parental Guidance Suggested)	●	●	●	●	
	TV-14 (Parents Strongly Cautioned)	●	●	●	●	
	TV-MA (Mature Audience Only)		●	●	●	

× — Content Rating can be set but this Rating is not normally broadcast by TV Station.

● — Content Rating can be set.

D: Sexually Suggestive Dialog

L: Adult Language

S: Sexual Situation

V: Violence

FV: Fantasy Violence

### Note:

Age-based ratings can be modified by the content-based ratings but only in the combinations indicated by an ● in the table above. Choosing lower age-based rating blocks the higher age-based ratings regardless of content ratings settings.

### Example 1:

When TV-Y7 in the age-based rating is set to BLOCK, this will automatically block the higher ratings: TV-G, TV-PG, TV-14 and TV-MA. In addition, D, L, S, V and FV in content are automatically blocked.

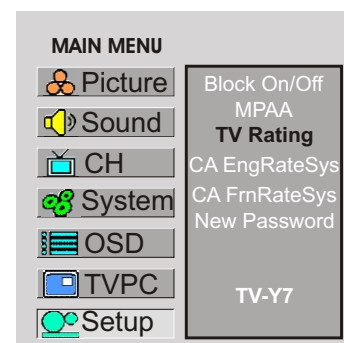

### Example 2:

When TV-14 in the age-based rating is set to BLOCK, this will automatically block the higher ratings: TV-MA. In addition, if you block "L" sub-rating in TV-PG, then the D, L, S, V and FV in content in TV-14 and TV-MA will automatically be blocked.

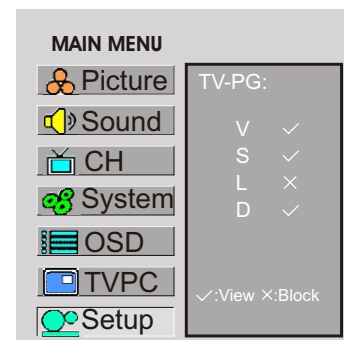

"Child Lock Block" with a green screen will be displayed if you watch the program with Program Rating data as same as you configured.

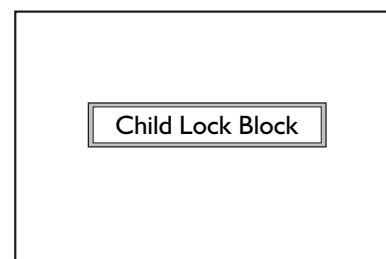

# Adjusting Child Lock Settings (continued)

## Turning Child Lock On or Off

- 1 Press the **Menu** button to display the menu main page.;
- 2 Press **CH ▲/▼** repeatedly to select **Setup** item;
- 3 Press **Enter** to access the submenu;
- 4 Enter password with the **number buttons**.  
The default password is 1234, you can change the password by yourself.  
The unit allows you to access the Child Lock menu if you input the right password, or you will be denied.  
The **Block On/Off** item will be highlighted automatically.
- 5 Press **Enter** to turn on or off the Child Lock.

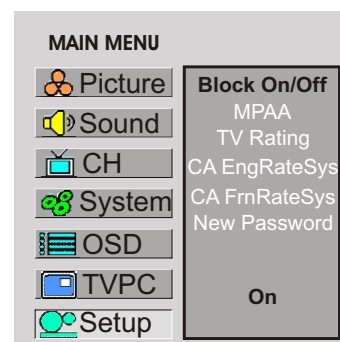

## Changing the Password

- 1 From the password menu page, press **CH ▲/▼** repeatedly to select **New Password** item.
- 2 Input a new 4-digit password. For example, you may set "0000" as your new password.
- 3 Press the **Menu** button to exit.  
Be sure to write down your password and retain it for future use.  
The unit provides a master password "8888". If you forget your password and can't access Child Lock menu, you may input the master password to access Child Lock menu. Please set a new password and make sure to remember your password.

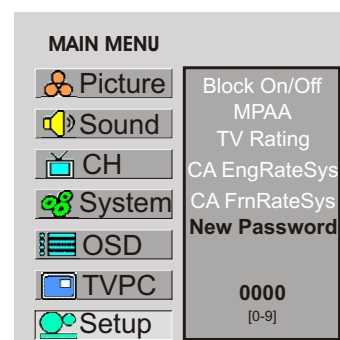

## Adjusting the Movie Rating

- 1 From the **Child Lock** menu page, press **CH ▲/▼** repeatedly to select **MPAA** item.
- 2 Press **Enter** repeatedly to select a desired rating you want to block.  
For example, "PG-13" in the age-based rating is selected, this will automatically block the higher ratings "R", "NC-17", "X" also.
- 3 Press the **Menu** button to exit.

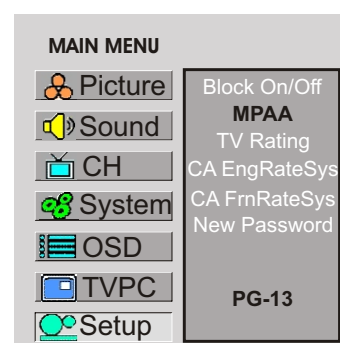

## Adjusting the TV Rating

- 1 From the **Child Lock** menu page, press **CH ▲/▼** repeatedly to select **TV Rating** item.
- 2 Press **Enter** repeatedly to select a desired rating you want to block.  
This will automatically block the higher age-based ratings. You may set the individual content-based ratings as follow.
- 3 Press **VOL +/-** if you want to set content-based ratings.
- 4 Press **CH ▲/▼** repeatedly to select a desired content rating.
- 5 Press **Enter** to block (×) or unblock (✓) this rating.
- 6 Press **Menu** repeatedly to exit.

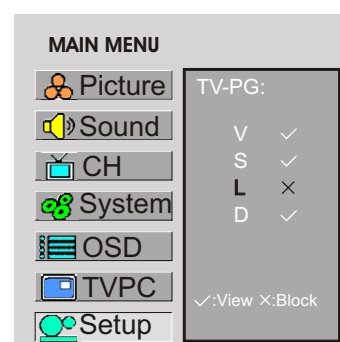
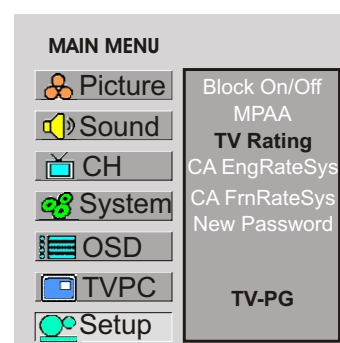

# Adjusting Child Lock Settings (continued)

## Adjusting Canadian English Rating

- 1 From the **Child Lock** menu page, press **CH ▲/▼** repeatedly to select **CA EngRateSys** item.
- 2 Press **Enter** repeatedly to select a desired rating you want to block.
- 3 Press the **Menu** button to exit.

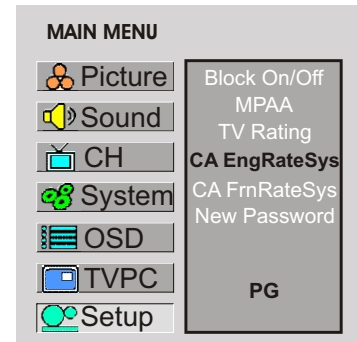

### CANADIAN ENGLISH RATING CHART

E	Exempt - Exempt programming includes: news, sports, documentaries and other information programming, talk shows, music videos, and variety programming.
C	Programming intended for children under age 8. No offensive language, nudity or sexual content.
C8+	Programming generally considered acceptable for children 8 years and over. No profanity, nudity or sexual content.
G	General programming, suitable for all audiences.
PG	Parental Guidance suggested. Some material may not be suitable for children.
14+	Programming contains themes or content which may not be suitable for viewers under the age of 14. Parents are strongly cautioned to exercise discretion in permitting viewing by pre-teens and early teens.
18+	Intended for viewers 18 years and older and might contain depictions of violence.

## Adjusting Canadian French Rating

- 1 From the **Child Lock** menu page, press **CH ▲/▼** repeatedly to select **CA FrnRateSys** item.
- 2 Press **Enter** repeatedly to select a desired rating you want to block.
- 3 Press the **Menu** button to exit.

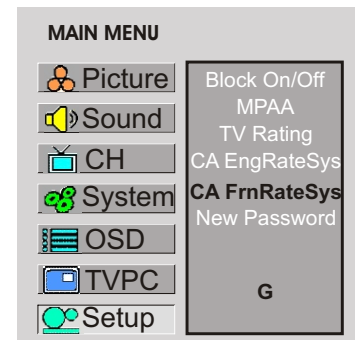

### CANADIAN FRENCH RATING CHART

E	Exempt - Exempt programming.
G	General - Programming intended for audience of all ages. Contains no violence, or the violence content is minimal or is depicted appropriately.
8 ANS+	8+ General - Not recommended for young children. Programming intended for a broad audience but contains light or occasional violence. Adult supervision recommended.
13 ANS+	Programming may not be suitable for children under the age of 13 - Contains either a few violent scenes or one or more sufficiently violent scenes to affect them. Adult supervision strongly suggested.
16 ANS+	Programming may not be suitable for children under the age of 16 - Contains frequent scenes of violence or intense violence.
18 ANS+	Only for adult viewing. Could contain frequent violent scenes and extreme violence.



**Before calling for repair service, check the following items for possible remedies to the encountered symptoms.**

Symptoms	Check item
"Ghost" or double images	<ul style="list-style-type: none"> <li>This may be caused by obstruction to the antenna due to high rise buildings or hills. Using a highly directional antenna may improve the picture.</li> </ul>
No power	<ul style="list-style-type: none"> <li>Check that the AC power cord is plugged into the mains socket.</li> <li>Unplug the power cord, wait for 60 seconds. Then re-insert plug into the mains socket and turn on the unit again.</li> </ul>
No picture	<ul style="list-style-type: none"> <li>Check antenna connections at the rear of the unit to see if it is properly connected to the unit.</li> <li>Possible broadcast station trouble. Try another channel.</li> <li>Adjust the contrast and brightness settings.</li> <li>Check the Closed Captions control. Some TEXT modes could block the screen.</li> <li>Select a correct input.</li> <li>Is a non-compatible signal being input?</li> </ul>
Good picture but no sound	<ul style="list-style-type: none"> <li>Increase the VOLUME.</li> <li>Check that the unit is not muted.</li> <li>Check that the Speaker item in SOUND menu is set to ON.</li> </ul>
Good sound but poor color	<ul style="list-style-type: none"> <li>Adjust the contrast, color and brightness settings.</li> </ul>
Poor picture	<ul style="list-style-type: none"> <li>Sometimes, poor picture quality occurs when having activated an S-VHS camera or camcorder connected and having connected another peripheral at the same time. In this case, switch off one of the other peripherals.</li> <li>Check whether the room is too bright.</li> </ul>
Horizontal dotted line	<ul style="list-style-type: none"> <li>This may be caused by electrical interference (e.g. hairdryer, nearby neon lights, etc.).</li> <li>Turn off the equipment.</li> </ul>
Television not responding to remote control	<ul style="list-style-type: none"> <li>Check whether the batteries are working. Replace if necessary.</li> <li>Clean the remote control sensor lens on the unit.</li> <li>Do not use the remote control under strong or fluorescent lighting.</li> <li>The batteries should be inserted with polarity (+, -) aligned.</li> </ul>
Snowy picture and noise	<ul style="list-style-type: none"> <li>Check the antenna connection.</li> </ul>
No stable or not synchronized VGA picture	<ul style="list-style-type: none"> <li>Check if you have selected the correct VGA mode in your PC.</li> </ul>
No output from one of the speakers	<ul style="list-style-type: none"> <li>Adjust Balance in the SOUND menu.</li> </ul>
Control buttons do not work.	<ul style="list-style-type: none"> <li>Unplug the power cord, wait for some seconds. Then re-plug the power cord and turn on the unit again.</li> </ul>

**■ Do not use in hot and cold rooms (locations)**

- When the unit is used in rooms (locations) with low temperature, the picture may leave trails or appear slightly delayed. This is not a malfunction, and the unit will recover when the temperature returns to normal.
- Do not leave the unit in a hot or cold location. Also, do not leave the unit in a location exposed to direct sunlight or near a heater, as this may cause the cabinet to deform and the LCD panel to malfunction.

(Storage temperature: 0°C to +50°C      Working temperature: 5°C to +40°C)

**Note:**

*If your problem is not solved, turn your unit off and then on again once.*

*Never attempt to repair a defective unit yourself.*

# Care and Maintenance

---

## LCD Display panel information

---

### **Important Information Regarding Use of Video Games, Computers, Captions or Other Fixed Image Displays.**

The extended use of fixed image program material can cause a permanent "shadow image" on the LCD panel.

This background image is viewable on normal programs in the form of a stationary fixed image. This type of irreversible LCD panel deterioration can be limited by observing the following steps:

- A. Reduce the brightness/contrast setting to a minimum viewing level.
- B. Do not display the fixed image for extended periods of time.
- C. Turn the power off when not in actual use.

### **Note:**

*The marking or retained image on the LCD panel resulting from fixed image use is not an operating defect and as such is not covered by Warranty. This product is not designed to display fixed image patterns for extended periods of time.*

## Cleaning and Maintenance

---

### **To clean this unit, wipe with a soft, dry cloth.**

If the surfaces are extremely dirty, use a soft cloth dipped in a soap and water solution or a weak detergent solution.

- Use eyeglass cleaner to remove stubborn dirt from the LCD.
- Never use alcohol, paint thinner or benzine to clean this unit.
- Before using a chemically treated cloth, read the instructions that came with the cloth carefully.

Type	LCD TV
Display Size diagonal	37"
Display Feature	
LCD panel	TFT-LCD
Resolution	1366 x 768
Pixel Pitch	0.600 (H)x0.600(V) mm
Maximum Colors	16,700,000
Brightness	500 nit
Contrast	600:1
Viewing Angle	176°/176°
Response Time	16.6 ms
TV Tuner & Color System	
Tuner	FST x 1
TV System	NTSC
Channel Coverage	VHF 2-13, UHF 14-69, CATV (1-125)
Video Features	Progressive Scan
Audio Speaker System	
Maximum Audio Output	10Wx2
Stereo Sound System	BTSC
Power Supply	AC 100-240V, 50/ 60Hz
Power Consumption	200W
Stand by Mode Power Consumption	< 1W
Unit weight (lb)	61.6
TV Unit Dimension (WxHxD) (inch)	44.7 x 25.67 x 9.84
Other functions	Sleep Timer (Off only)
	Picture Freeze (TV and AV only)
Caption	Closed Caption
Security	Child Lock
Remote Control function support for full OSD features	OSD Support English, French, Spanish





PRINTED IN  
RECYCLED PAPER

604-L37K73-00

## Free Manuals Download Website

<http://myh66.com>

<http://usermanuals.us>

<http://www.somanuals.com>

<http://www.4manuals.cc>

<http://www.manual-lib.com>

<http://www.404manual.com>

<http://www.luxmanual.com>

<http://aubethermostatmanual.com>

Golf course search by state

<http://golfingnear.com>

Email search by domain

<http://emailbydomain.com>

Auto manuals search

<http://auto.somanuals.com>

TV manuals search

<http://tv.somanuals.com>