

 **AUDIOVOX™**

PVS21090

9" LCD TV with DVD/CD Player

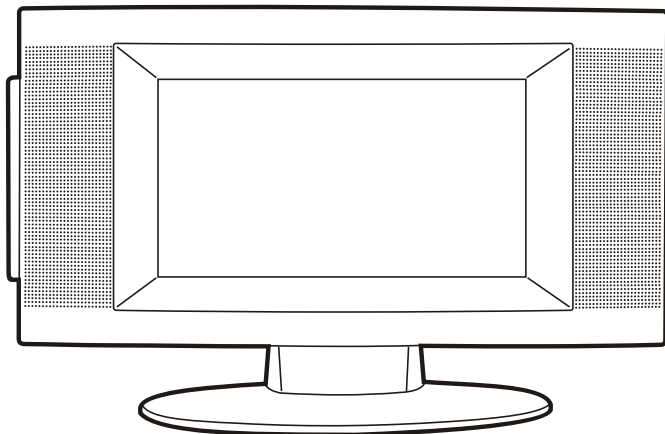

Instruction Manual



Need More Help?

DO NOT RETURN THIS PRODUCT TO THE STORE

Please visit online help at

<http://www.1800customersupport.com/audiovox>

SAFETY PRECAUTIONS

	CAUTION RISK OF ELECTRIC SHOCK DO NOT OPEN	
AVIS	RISQUE DE CHOC ÉLECTRIQUE NE PAS OUVRIR	
WARNING : TO REDUCE THE RISK OF ELECTRIC SHOCK, DO NOT REMOVE COVER (OR BACK). NO USER-SERVICEABLE PARTS INSIDE. REFER SERVICING TO QUALIFIED SERVICE PERSONNEL.		

 The lightning flash with arrowhead symbol, within an equilateral triangle, is intended to alert the user to the presence of uninsulated "dangerous voltage" within the product's enclosure that may be of sufficient magnitude to constitute a risk of electric shock to persons.

 The exclamation point within an equilateral triangle is intended to alert the user to the presence of important operating and maintenance (servicing) instructions in the literature accompanying the appliance.

 This product contains a low power laser device.

CLASS 1 LASER PRODUCT
APPAREIL À LASER DE CLASSE 1

 The symbol for Class II (Double Insulation)

CAUTION
INVISIBLE LASER RADIATION WHEN UNIT IS OPENED AND INTERLOCKS ARE DEFECTED. AVOID EXPOSURE TO LASER BEAM.

CAUTION

- DANGER OF EXPLOSION IF BATTERY IS INCORRECTLY REPLACED. REPLACE ONLY WITH THE SAME OR EQUIVALENT TYPE.
- TO PREVENT ELECTRIC SHOCK, MATCH WIDE BLADE OF PLUG TO WIDE SLOT OF WALL OUTLET, THEN FULLY INSERT.

 **WARNING :**

- TO PREVENT FIRE OR SHOCK HAZARD, DO NOT EXPOSE THIS UNIT TO RAIN OR MOISTURE. DO NOT PLACE OBJECTS FILLED WITH LIQUIDS ON OR NEAR THIS UNIT.
- SHOULD ANY TROUBLE OCCUR, DISCONNECT THE AC POWER CORD AND REFER SERVICING TO A QUALIFIED TECHNICIAN.

PLACEMENT INFORMATION

- Do not use this unit in places which are extremely hot, cold, dusty or humid.
- Do not restrict the air flow of this unit by placing it somewhere with poor air flow, by covering it with a cloth, by placing it on bedding or carpeting.

SAFETY INFORMATION

- When connecting or disconnecting the AC power cord, grip the plug and not the cord itself. Pulling the cord may damage it and create a hazard.
- When you are not going to use the unit for a long period of time, disconnect the AC power cord.

CONDENSATION INFORMATION

- When left in a heated room where it is warm and damp, water droplets or condensation may form inside the equipment. When there is condensation inside the unit, the unit may not function normally. Let the unit stand for 1-2 hours before turning the power on or gradually heat the room and let the unit dry before use.

RATING PLATE LOCATION

The rating plate is located on the rear of unit.

FCC STATEMENTS

NOTE: This unit has been tested and found to comply with the limits for a Class B digital device, pursuant to Part 15 of the FCC Rules. These limits are designed to provide reasonable protection against harmful interference in a residential installation. This unit generates, uses and can radiate radio frequency energy and, if not installed and used in accordance with the instructions, may cause harmful interference to radio communication. However, there is not guarantee that interference will not occur in a particular installation. If this unit does cause harmful interference to radio or television reception, which can be determined by turning the unit off and on, the user is encouraged to try to correct the interference by one or more of the following measures:

- Reorient or relocate the receiving antenna.
- Increase the separation between the unit and receiver.
- Connect the unit into an outlet on a circuit different from that to which the receiver is connected.
- Consult the dealer or an experienced radio/TV technician for help.



WARNING: Changes or modifications to this unit not expressly approved by party responsible for compliance could void the user authority to operate unit.

IMPORTANT SAFETY INSTRUCTIONS

- 1) Read these instructions.
- 2) Keep these instructions.
- 3) Heed all warnings.
- 4) Follow all instructions.
- 5) Do not use this apparatus near water.
- 6) Clean only with dry cloth.
- 7) Do not block any ventilation openings. Install in accordance with the manufacturer's instructions.
- 8) Do not install near any heat sources such as radiators, heat registers, stoves, or other apparatus (Including amplifiers) that produce heat.
- 9) Do not defect the safety purpose of the polarized or grounding-type plug. A polarized plug has two blades with one wider than the other. A grounding type plug has two blades and a third grounding prong. The wide blade or the third prong are provided for your safety. If the provided plug does not fit into your outlet, consult an electrician for replacement of the obsolete outlet.
- 10) Protect the power cord from being walked on or pinched particularly at plugs, convenience receptacles, and the point where they exit from the apparatus.
- 11) Only use detachments / accessories specified by the manufacturer.
- 12) Use only with the cart, stand, tripod, bracket, or table specified by the manufacturer, or sold with the apparatus. When a cart is used, use caution when moving the cart / apparatus combination to avoid injury from tip-over.
- 13) Unplug this apparatus during lightning storms or when unused for long periods of time.
- 14) Refer all servicing to qualified service personnel. Servicing is required when the apparatus has been damaged in any way, such as power-supply cord or plug is damages, liquid has been spilled or objects have fallen into the apparatus, the apparatus has been exposed to rain or moisture, does not operate normally, or has been dropped.



MAINTENANCE

CLEANING THE DISC

A defective or dirty disc inserted into the unit can cause sound to drop out during playback.

Handle the disc by holding its inner and outer edges.

- Do NOT touch the surface of the unlabeled side of the disc.
- Do NOT stick paper or tape on the surface of the disc.
- Do NOT expose the disc to direct sunlight or excessive heat.
- Clean the disc before playback. Wipe the disc from the center outward with a cleaning cloth.
- NEVER use solvents such as benzine or alcohol to clean the disc.
- Do NOT use irregular shape discs (example : heart shaped, octagonal, etc.). They may cause malfunctions.

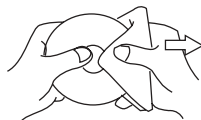

CLEANING THE UNIT

- Be sure to turn the unit off and disconnect the AC power cord before cleaning the unit.
- Wipe the unit with a dry soft cloth. If the surfaces are extremely dirty, wipe clean with a cloth which has been dipped in a weak soap-and-water solution and wrung out thoroughly. Then wipe it with a dry cloth.
- Never use alcohol, benzine, paint-thinner, cleaning fluid or other chemicals. Do NOT use compressed air to remove dust.

IMPORTANT NOTE

Before shipping the unit, remove any disc from the disc compartment.

CONTENTS

SAFETY PRECAUTIONS	1	PLAYING A DISC	16-17
IMPORTANT SAFETY INSTRUCTIONS	2	Playing a Disc	16
MAINTENANCE	2	Playing a Picture File Disc	16
CONTENTS	3	Pausing Playback (still mode)	16
DISC FORMATS	4	Stopping Playback	16
ACCESSORIES	5	Skipping to a different Track	16
USING OF REMOTE CONTROL	5	Fast Forward / Fast Reverse	17
CONTROL REFERENCE GUIDE .	6-7	Audio Selection (DVD)	17
CONNECTIONS	8-9	Subtitle Selection (DVD)	17
Connecting a TV Antenna	8	Angle Selection (DVD)	17
Connecting to other Equipment with Video Output (VCR, Camcorder, Video Game System, Cable, Satellite system, etc.)	8	SPECIAL FUNCTION	18
Connecting to another TV with A/V Input	9	Display	18
Connecting the AC Power Cord	9	Locating a Specific tTtle (DVD)	18
INSTALLATION	10	Locating s Specific Chapter / Track ..	18
Removing the Base Sand	10	Locating a Specific Time (DVD)	18
Mounting on the wall	10	REPEAT PLAYBACK	19
USING HEADPHONES	10	Repeating a Chapter / Title (DVD)	19
SCREEN VIEWING ANGLE ADJUSTMENT	11	Repeating a Single Track / an Entire Disc (CD)	19
UNIT OPERATION	11	DVD/CD PROGRAMMABLE PLAYBACK	20
SOUND SYSTEM	11	Title / Chapter Programmed Playback (DVD)	20
USING THE TV	12	Track Programmed Playback (CD)	20
Searching for TV Channels Automatically	12	CUSTOMIZING THE FUNCTION SETTINGS	20-21
Manual Searching for TV Channels	12	Language Setup	20
Watching Television	12	Video Setup	21
Resetting the TV Channels	12	System Setup	21
TV SETUP	13-15	TROUBLESHOOTING GUIDE	22
Picture Setting	13		
Sound Setting	13		
Timer Setting	14		
Misc Setting	14		
TV Channel Setting	15		

DISC FORMATS

NOTES ON COPYRIGHT

It is forbidden by law to copy, broadcast, show, broadcast on cable, play in public or rent copyrighted material without permission.

Apparatus Claims of U.S. Patent Nos. 4,907,093; 5,315,448 and 6,516,132 licensed for limited viewing uses only.

DVD video discs are copy protected, and any recordings made from these discs will be distorted. This product incorporates copyright protection technology that is protected by method claims of certain U.S. patents and other intellectual property rights owned by Macrovision Corporation and other rights owners. Use of this copyright protection technology must be authorized by Macrovision Corporation, and is intended for home and other limited viewing uses only, unless otherwise authorized by Macrovision Corporation. Reverse engineering or disassembly is prohibited.

The unit can play:



DVDs [8cm/
12cm disc]



Audio CDs [8cm/
12cm disc]

CD-R CD-RW
Compatible

REGION MANAGEMENT INFORMATION

Region Management Information: This unit is designed and manufactured to respond to the Region Management Information that is encoded on DVD discs. If the Region number printed on the DVD disc does not correspond to the Region number of this unit, this unit cannot play that disc.



The region number of this equipment is 1.

DISC FUNCTION OR OPERATION THAT IS NOT AVAILABLE

When the  symbol appears on the screen, it indicates that the function or operation attempted is not available at that time. This occurs because the DVD disc manufacturer determines the specific functions. Certain functions may not be available on some discs. Be sure to read the documentation provided with the DVD.

ICONS USED ON DVDS

Sample Icons:

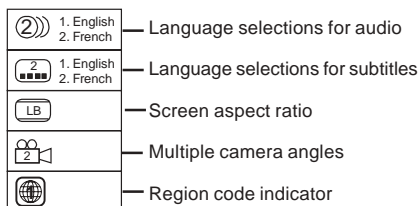

NOTE:

When playing back a CD-G (Graphics) or CD EXTRA disc, the audio portion will be played, but the graphic images will not be shown.

TITLES, CHAPTERS AND TRACKS

- DVDs are divided into "TITLES" and "CHAPTERS". If the disc has more than one movie on it, each movie would be a separate "TITLE". "CHAPTER" are sections of titles.

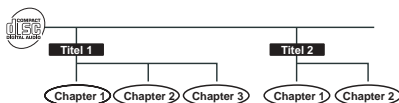

- Audio CDs are divided into "TRACKS". A "TRACK" is usually one song on an audio CD.

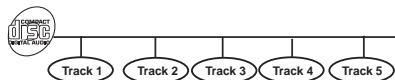

NOTE

Numbers identify each title, chapter and track on a disc. Most discs have these numbers record on them, but some do not.

NOTES ON UNAUTHORIZED DISCS

You may not be able to playback some DVD discs on this equipment if they were purchased from outside your geographic area or made for business purpose.

ACCESSORIES

Please check and identify the supplied accessories.

- AC Power Cord x 1
- AC Adapter x 1
- Remote Control (with batteries) x 1

USING OF REMOTE CONTROL

USING THE REMOTE CONTROL

- This remote control is magnetic and can be attached to most refrigerators. Some refrigerator panels are not metallic. In this case, try attaching the magnetic remote control to the side of the refrigerator.
- Point the remote control at the remote sensor located on the unit.
- When there is a strong ambient light source, the performance of the infrared remote sensor may be degraded, causing unreliable operation.
- The recommended effective distance for remote operation is about 16 feet (5 meters).

TO INSTALL BATTERIES

1. Open the battery door.

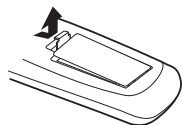

2. Insert 2 "AAA" batteries.

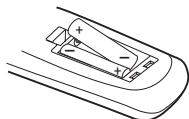

BATTERY REPLACEMENT

When the batteries become weak, the operating distance of the remote control is greatly reduced and you will need to replace the batteries.



CAUTION: Danger of explosion if battery is incorrectly replaced. Replace only with the same or equivalent type.

NOTES

- Do not place the remote control near magnetic devices.
- If the remote control is not going to be used for a long time, remove the batteries to avoid damage caused by battery leakage corrosion.
- Do not mix old and new batteries. Do not mix ALKALINE, standard (CARBON-ZINC) or rechargeable (NICKEL-CADMIUM) batteries.
- Always remove batteries as soon as they become weak.
- Weak batteries can leak and severely damage the remote control.
- **WARNING :** Do not dispose of batteries in a fire. Batteries may explode or leak.

CONTROL REFERENCE GUIDE

REMOTE CONTROL

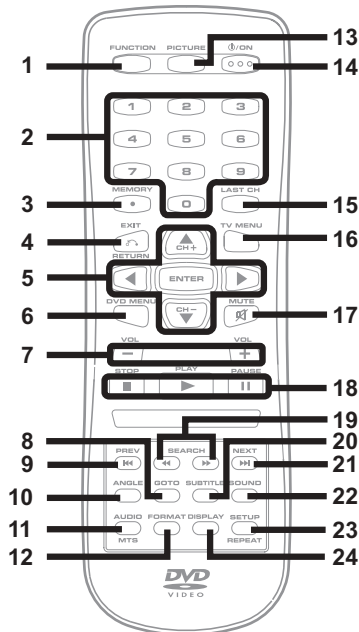

- 1. FUNCTION button**
Switch between TV / AV IN / DVD.
- 2. Number (0 - 9) buttons**
- 3. MEMORY button**
Set predetermined playback.
 - **[dot] button**
Digital TV channels (i.e. 11.3 or 12.7)
- 4. EXIT button**
Press to exit the TV menu and return directly to normal viewing.
RETURN button
Return to normal operation after using the SETUP menu of a DVD.
- 5. CURSOR (▲, ▼, ◀, ▶) buttons**
Use to highlight selections on a menu screen and adjust certain settings.
ENTER button
Press to confirm selections on a menu screen.
CH+ / CH- buttons
Press + / - button to move the TV channels.
- 6. DVD MENU button**
Press to enter the main menu of the DVD you are watching.

- 7. VOLUME (- / +) buttons**
Press to adjust the volume level. Use to highlight selections on a menu screen and adjust certain settings.
- 8. GOTO button**
Skip directly to a specific location on a DVD / CD.
- 9. ◀◀ PREV button**
Select previous chapters or tracks on a disc.
- 10. ANGLE button**
Switch the camera angle of the video presentation when scenes with multiple camera angles are recorded on a DVD.
- 11. AUDIO button**
Select audio soundtracks of a DVD or change the output mode of a CD.
MTS button
Press to select MONO sound, STEREO sound and Secondary Audio Program (SAP).
- 12. FORMAT button**
Press to select the picture format.
- 13. PICTURE button**
Select from preset screen display settings to match the type of show you are watching.
- 14. ON / OFF button**
Press to turn ON the unit or put it in STANDBY (OFF) mode.
- 15. LAST CH button**
Press to switch repeatedly between the last two channels displayed.
- 16. TV MENU button**
Press to display the on-screen TV menu.
- 17. MUTE button**
Press to turn off the sound.
- 18. ■ STOP button**
Stop playing a disc.
 - ▶ **PLAY button**
Press to start and resume playback of a disc.
 - || **PAUSE button**
Pause playback and single frame advance.
- 19. SEARCH ◀◀ / ▶▶ buttons**
 - ◀◀ : Fast reverse playback.
 - ▶▶ : Fast forward playback.
- 20. SUBTITLE button**
Select one of the subtitle languages programmed on a DVD.
- 21. NEXT ▶▶ button**
Select next title, chapter or track on a disc.
- 22. SOUND button**
Press to select from preset sound settings to match the type of show you are watching.
- 23. REPEAT button**
Repeat chapter or title of a DVD.
Repeat single track or whole CD.
SETUP button
Enter and exit the SETUP menu of the DVD.
- 24. DISP (DISPLAY) button**
Change disc status information displayed on the screen.

CONTROL REFERENCE GUIDE

FRONT & BACK VIEWS

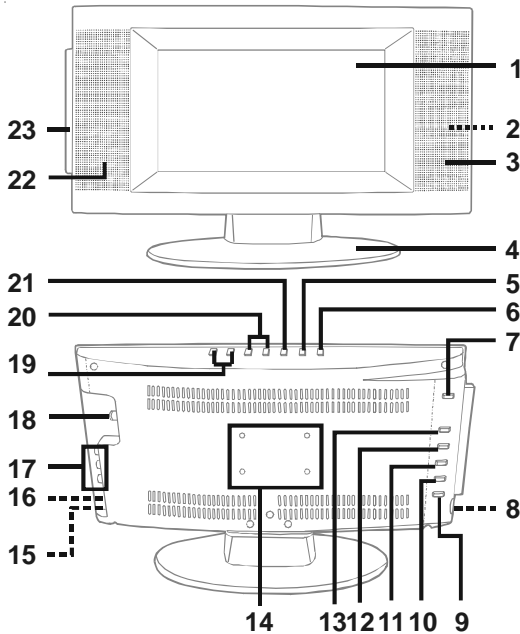

- 1. Color LCD screen**
- 2. Remote sensor**
Point the remote control here.
- 3. Right speaker**
- 4. Removable stand**
- 5. MENU button**
Enters the on-screen TV menu.
- 6. ϕ / ON button**
Turns the unit on and off.
- 7. DVD DOOR OPEN button**
Open the disc door.
- 8. AUDIO / VIDEO OUT jacks (DVD out)**
Connects to another TV.
- 9. \blacktriangleleft PREV button**
Press PREV button to go back to previous chapters / tracks.
Press and hold fast reverse playback.
- 10. \blacktriangleright NEXT button**
Press NEXT button to advance chapters / tracks.
Press and hold to fast forward playback.
- 11. \parallel PAUSE button**
Pause playback and single frame advance.
- 12. \blacksquare STOP button**
Stop playing a disc.
- 13. \blacktriangleright PLAY button**
Press to start and resume playback of a disc.
- 14. Wall mounting holes**
- 15. DC IN 12V jack**
- 16. Headphones jack**
- 17. AUDIO IN (Left/Right)/ VIDEO IN jacks**
- 18. TV ANTENNA terminal**
Connects a TV antenna or CATV cable.
- 19. - VOL + controls**
Adjusts the volume level and highlights selections (Left & Right) on the TV menu screen.
- 20. \blacktriangle CH \blacktriangledown buttons**
Press to confirm selections on the TV menu screen and \blacktriangle / \blacktriangledown to move the TV channels.
- 21. FUNCTION button**
Selects TV / AV IN / DVD
- 22. Left speaker**
- 23. DVD door**
Close by pushing the disc door.

CONNECTIONS

CONNECTING A TV ANTENNA

To view television channels correctly, a signal must be received from one of the following sources:

- An indoor or outdoor aerial antenna
- A cable system
- A satellite system

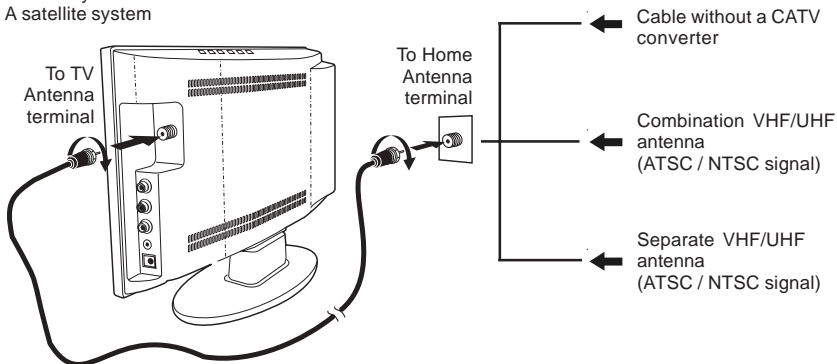

NOTE

For receiving over-the-air TV broadcasts, we recommend that you use an external fixed antenna. Should you require the use of a temporary antenna, please ensure that you purchase an antenna with sufficient ability to receive in weak signal areas. Only when you are in close proximity to a transmitter will a temporary antenna reproduce a signal as strongly as a fixed antenna.

CONNECTING TO OTHER EQUIPMENT WITH VIDEO OUTPUT

To connect to other equipment such as a VCR, camcorder, video game system, cable or satellite system etc.

Connecting to a VCR / Camcorder / Video Game System / Cable / Satellite System

Connects the AUDIO / VIDEO cable (not included) as shown:

Make sure you connect the cable from the other equipment (AUDIO/VIDEO OUT) to this unit (AUDIO/VIDEO IN).

NOTE

Please refer to the user manual for the other equipment for more information.

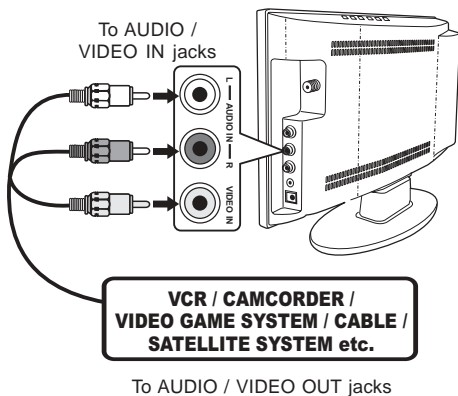

CONNECTIONS

CONNECTING TO ANOTHER TV WITH A/V INPUT

Connecting to another TV

Connects the AUDIO / VIDEO cable (not included) as shown:

Make sure you connect the cable from another TV (**AUDIO/VIDEO IN**) to this unit (**AUDIO/VIDEO OUT**).

NOTE

- Please refer to your another TV user manual for more information.

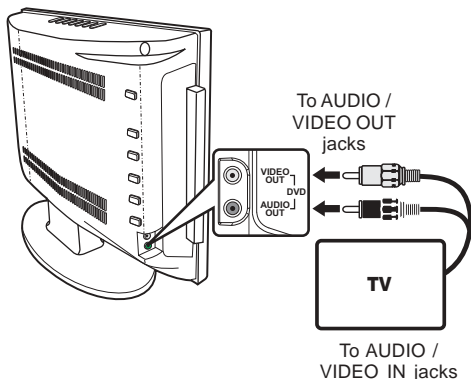

CONNECTING THE AC POWER CORD

This AC adapter operates on AC 110-240V.

1. Connect the AC power cord to the AC adapter.
2. Plug the AC adapter cord into the DC-IN 12V on the unit.
3. Connect the AC adapter and AC power cord into a wall outlet.

NOTES

- The included AC adapter and AC power cord are for use with this unit only. Do not use them with other equipment.
- **TO PREVENT ELECTRIC SHOCK, MATCH WIDE BLADE OF PLUG TO WIDE SLOT OF WALL OUTLET, THEN FULLY INSERT.**
- When the AC power cord is plugged in, the unit is not completely disconnected from the main, even when the power is turned off.
- Be sure the AC power cord is disconnected and all functions are off before making connections.
- Make sure that all the components are connected correctly.
- When you are not going to use the unit for a long period of time, disconnect the AC power cord.

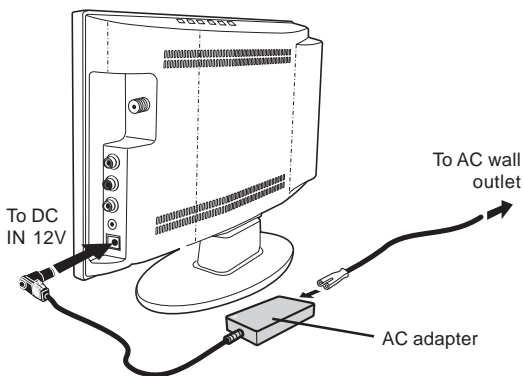

INSTALLATION

REMOVING THE BASE STAND

WARNING: The LCD display is very fragile, and must be protected at all times when removing the base stand. Be sure that no hard or sharp objects, or anything that could scratch or damage the LCD display, come in contact with it. Do NOT place pressure on the rear of the unit at anytime because the screen could crack.

1. Disconnect any cables or cords connected to the unit.
2. Lay the unit down on a flat surface, so the back side is facing up, making sure to place a soft cushioned material (such as a pillow or thick piece of foam) beneath the screen.
3. Remove the 3 screws and then remove the BASE STAND from the unit.

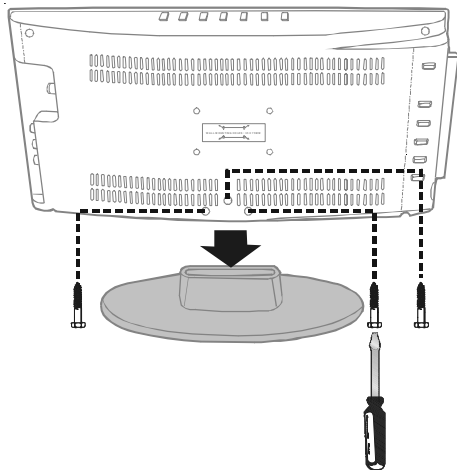

MOUNTING ON THE WALL

This unit is VESA-compliant, and is designed to be wall-mounted with a VESA-compliant 1.375" x 2.9375" (35mm x 75mm) mounting kit designed for flat-panel TVs (sold separately). Mount this unit according to the directions included with the mounting kit.

NOTE

Remove the base stand before mounting the unit on the wall.

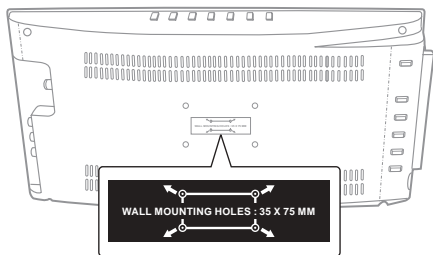

USING HEADPHONES

- Turn down the volume before connecting headphones to the unit, then adjust the volume to your desired level.
- When headphones are connected, no sound will come from the front speakers.

NOTE

Avoid listening to sound at high levels for prolonged periods of time. This may be harmful to you and may cause hearing loss.

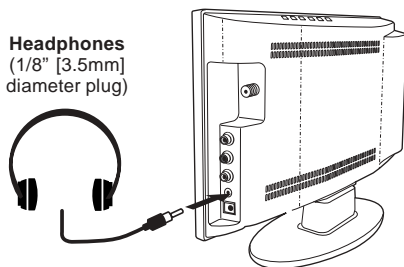

SCREEN VIEWING ANGLE ADJUSTMENT

The unit is designed to allow users to have a comfortable viewing angle.

1. Hold the stand firmly.
2. Gently adjust the TV.

CAUTION

Do not force the LCD screen over the maximum viewing angle settings as stated above. Attempting this will result in damage to the unit.

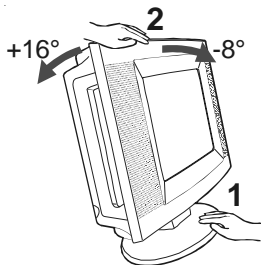

UNIT OPERATION

TURNING THE UNIT ON

When the AC power cord is connected, press the **ON** button to turn it on. Press the **FUNCTION** button to select the desired mode (TV / AV IN / DVD). If you select DVD, the DVD logo will appear on the screen.

NOTE

When the unit is not going to be used for a long time, disconnect the AC power cord from the AC wall outlet.



SOUND SYSTEM

DOLBY DIGITAL (FOR DVD)

Dolby Digital is a sound system developed by Dolby Laboratories Inc. that gives movie theatre ambience to audio output when the unit is connected to a Dolby Digital 5.1 channel processor or amplifier. This unit automatically recognises DVDs that have been recorded with Dolby Digital.

Not all Dolby Digital sources are recorded with 6 channels.

Some sources marked Dolby Digital may be recorded in Dolby Surround, 1 2 channel system. Look for this logo on your unit.



Manufacturer under license from Dolby Laboratories.

"Dolby" and  the double-D symbol are trademarks of Dolby Laboratories.

TV SETUP

PICTURE SETTING

1. Press the **TV MENU** button.
2. Use the **▲** or **▼** button to select the options (**Picture Mode / Contrast / Brightness / Sharpness / Tint / Color**).
3. Use **◀** or **▶** button to make adjustment. The screen will change to your selected mode immediately. Press the **TV MENU** button to return to the previous menu.
4. Repeat steps 2 and 3 to adjust other options.
5. To exit the TV SETUP MENU and return to the normal screen, press the **EXIT** button on the remote control.

NOTE

You can also access these setting by pressing the **PICTURE** button.

Picture Mode: Select from preset screen display settings to match the type of show you are watching (Standard, Dynamic, Soft & Personal).

Contrast: Adjust to sharpen the picture quality. The black portions of the picture become richer in darkness and the white become brighter.

Brightness: Adjust to brighten or darken the whole picture.

Sharpness: Adjust the sharpness level to improve detail in the picture.

Tint: Adjust natural skin tones in the picture quality.

Color: Adjust the color of the picture.

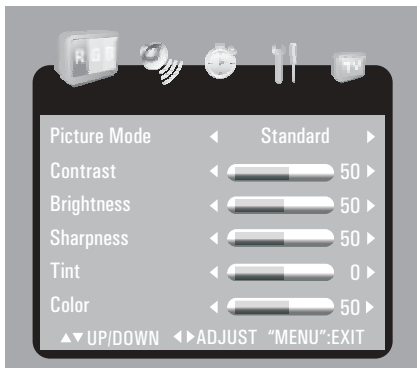

SOUND SETTING

1. Press the **TV MENU** button.
2. Use the **◀** or **▶** button to select **SOUND SETTING**.
3. Use the **▲** or **▼** button to select the options (**Sound Mode / Bass / Treble / Balance**).
4. Use the **◀** or **▶** button to make adjustment. Press the **TV MENU** button to return to the previous menu.
5. Repeat steps 2 to 4 to adjust other options.
6. To exit the TV SETUP MENU and return to the normal screen, press the **EXIT** button on the remote control.

NOTE

You can also access these setting by pressing the **SOUND** button.

Sound Mode: Select from preset sound settings (Standard, Music, Movie, Personal) to match the type of show you are watching.

Bass: Adjust the bass range.

Treble: Adjust the treble range.

Balance: Adjust the balance level toward the left or right speakers.

Audio Language: Use the **◀** or **▶** button to select English, French or Spanish (**Available for Digital TV system only**).

NOTE

Only for DTV/ATSC input source mode, thus it is not available in other input source mode.

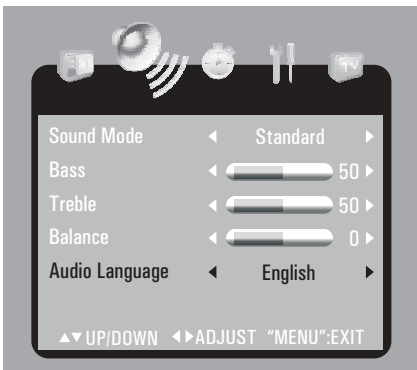

TV SETUP

TIMER SETTING

1. Press the **TV MENU** button.
2. Use the ◀ or ▶ button to select **TIMER SETTING**.
3. Use the ▲ or ▼ button to select the options (**OSD Duration / Sleep Timer / Time Zone / Day Saving Time**).
4. Use the ◀ or ▶ button to make adjustment. Press the **TV MENU** button to return to the previous menu.
5. Repeat steps 2 to 4 to adjust other options.
6. To exit the TV SETUP MENU and return to the normal screen, press the **EXIT** button on the remote control.

OSD Duration: Select amount the time of TV menu showing on screen.

Sleep Timer: Set the LCD TV to turn itself off within a certain time.

Time Zone / Day Saving Time / Clock

1. Set the local Time Zone, eg. Pacific.
2. After selecting the time zone, the Day Saving Time must be activated for those areas observing such change.
3. The clock will be recoded automatically (for ATSC only).

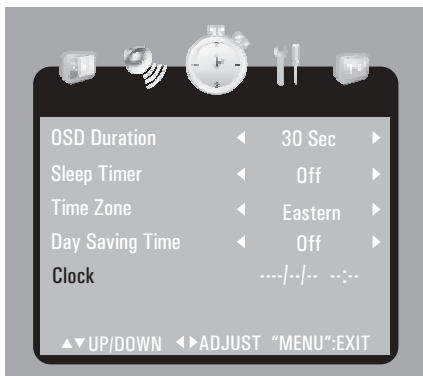

MISC SETTING

1. Press the **TV MENU** button.
2. Use the ◀ or ▶ button to select **MISC SETTING**.
3. Use the ▲ or ▼ button to select the options (**Language / Color Mode / Restore Setting**).
4. Use the ◀ or ▶ button to make adjustment. The screen will change to your selected mode immediately. Press the **TV MENU** button to return to the previous menu.
5. Repeat steps 2 to 4 to adjust other options.
6. To exit the TV SETUP MENU and return to the normal screen, press the **EXIT** button on the remote control.

Language : Select from English / Français / Español.

Color Mode : Adjust the three color temperature of the picture. Select Normal (balanced) / Warm (red white) / Cool (blue white) mode.

Restore Setting : If you reset the TV to the factory settings, all your present settings on picture & sound will be erased and replaced by the factory's default settings.

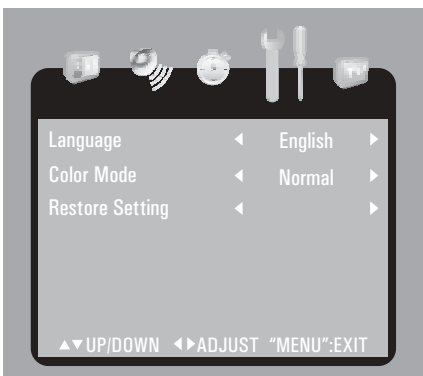

TV SETUP

TV CHANNEL SETTING

1. Press the **TV MENU** button.
2. Use the ◀ or ▶ button to select TV CHANNEL SETTING.
3. Use the ▲ or ▼ button to select the options (**Antenna / Auto Scan / Auto Scan Add CH / Channel Skip / Channel No. / Channel Label**).
4. Use the ◀ or ▶ button to make adjustment. The screen will change to your selected mode immediately. Press the **TV MENU** button to return to the previous menu.
5. Repeat steps 2 to 4 to adjust other options.
6. To exit the TV SETUP MENU and return to the normal screen, press the **EXIT** button on the remote control.

NOTE

Channel No. : 2-69 Channel for Air, 1-135 Channel for CATV.

Antenna : Select "CATV" to receive cable signal. Select "AIR" to receive air signal.

Auto Scan : Automatically search all channels for those with adequate signal strength.

Auto Scan Add CH : The stored channels can not be cleared and the Auto Scan Channels will be added.

If you have selected CATV in TV CHANNEL SETTING, then you can select Cable System (AUTO / STD / HRC / IRC) in the sub menu as the picture shown.

Channel Skip: You may switch ON/OFF the skip function of each stored channel by selecting the channel with ▲ / ▼ button (and using ◀ / ▶ button to select page if the amount of stored channels in more than 1 page), and followed with pressing the **ENTER** button.

Channel Label: You may edit one label for each channel.

1. Select the Channel Label item and press the ◀ or ▶ button to go into the channel label edit screen.
2. Use the ▲ or ▼ button to enter the number or letter.
3. Use the ◀ or ▶ button to move and edit for the next character.
4. After editing, press the **DISPLAY** button and the Channel & Channel Label will be shown on the screen.

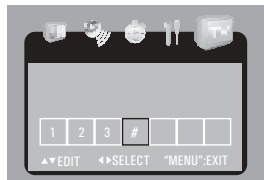
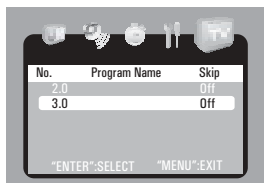
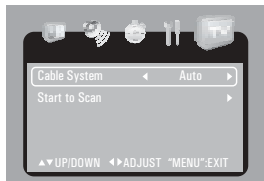
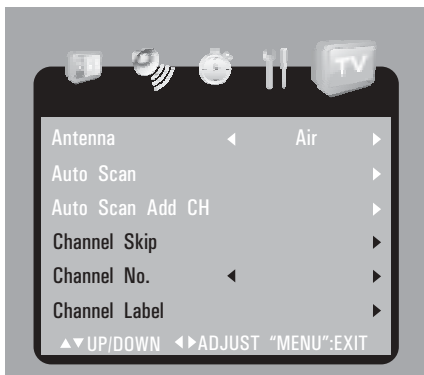

PLAYING A DISC

This owner's manual explains the basic instructions of this unit. Some DVDs are produced with limited operation during playback. For example, many DVDs do not allow users to skip government warnings, or in some cases previews or other features. This is not a defect in the unit. Refer to the instruction notes of discs.

"Ⓜ" may appear on the screen during operation. A "Ⓜ" means that the desired operation is not permitted by the unit or disc.

PLAYING A DISC

1. Press the **⏻/ON** button to turn on the unit.
2. Use the **◀** button to select "NO", then press the **ENTER** button. (*Only appears to the first time Power ON*)
3. Use **FUNCTION** button repeatedly to select DVD mode, then press the **ENTER** button.

See **CUSTOMIZING THE FUNCTION SETTINGS** before proceeding to step 4.

4. Press the **◀ OPEN** button to open the disc door.
5. Hold the disc by its sides and carefully press onto the central support of compartment with the printed side facing towards you until you hear a "click".
6. Push the disc door to close it.

It takes a short while for your unit to load the disc. After loading, the unit will automatically either bring you to the main menu of DVD, or start playing the DVD. If the unit does not automatically start playing the DVD, press the **▶ PLAY** button.

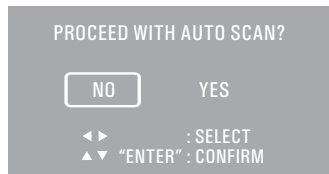

PLAYING A PICTURE FILE DISC

This unit can play JPEG files recorded on a CD-R or CD-ROM disc.

1. Press the **◀ OPEN** button to open the disc door.
2. Hold a JPEG file disc by its edge and gently push it onto the spindle with label side facing towards you until you hear a "click".
3. Push the disc door to close it.
4. The unit will load the disc and automatically display the contents of the disc on the screen, while also beginning to play the picture file. These files will then be played back one by one.
5. Press the **RETURN** button to folder list.
6. Use the **▲, ▼, ◀** or **▶** button to view and select desired file, then press the **ENTER** button to confirm the selected file.

NOTES

- You can press the **⏸ PAUSE** button to freeze the picture, and press the **▶ PLAY** button to resume slide show.
- You can press the **⏮ PREV** or **⏭ NEXT** button to change the picture. Press the **⏮ PREV** button to view the previous picture. Press the **⏭ NEXT** button to view the next picture.
- You can press the **ANGLE** button to rotate direction of the picture by 90°.

PAUSING PLAYBACK (STILL MODE)

Press the **⏸ PAUSE** button. To resume normal playback, press the **▶ PLAY** button. Each time you press the **⏸ PAUSE** button, the picture advances one frame.

STOPPING PLAYBACK

Press the **■ STOP** button at the location where you want to interrupt playback. To resume playback at the position where the disc was stopped, press the **▶ PLAY** button.

SKIPPING TO A DIFFERENT TRACK

- Press the **⏮ PREV** button to skip to the start of the current/previous track.
- Press the **⏭ NEXT** button to skip to the next track.
- For an audio CD, use the number buttons on the remote control to go directly to the desired track number.

PLAYING A DISC

FAST FORWARD / FAST REVERSE

1. Press the **SEARCH** ◀◀ or ▶▶ **SEARCH** button when a disc is playing.
 - The disc begins a fast scan at two times normal (x2) speed.
 - Four speeds are available. Each time the **SEARCH** button is pressed, the speed of the fast scan changes
2. Press the ▶ **PLAY** button when you have reached the desired point to resume playback at normal speed.

AUDIO SELECTION (DVD)

On some discs, the sound is recorded in two or more formats. Follow the directions below to select the type of playback.

1. While a disc is playing, press the **AUDIO** button to show the current audio format number.
2. Press the **AUDIO** button repeatedly to select the desired audio format.

Ⓞ : 1/3 ENG DD 6CH

NOTES

- If only one audio format is recorded, the number does not change.
- About two seconds later, playback continues in the new audio format.

SUBTITLE SELECTION (DVD)

1. While a DVD is playing, press the **SUBTITLE** button to display the current language setting.
2. Press the **SUBTITLE** button repeatedly to select the desired subtitle language.

NOTES

- If only one language is recorded, the language does not change.
- About two seconds later, playback continues with the new subtitle you selected.
- The number of languages recorded differs depending on the disc.
- If no button is pressed within a few seconds, playback continues without changing the current subtitle.
- This function can only be used for discs on which subtitles have been recorded in multiple languages.
- On some DVDs, subtitles are activated from the main menu of the DVD. Press the **DVD MENU** button to activate the main menu.

⋮ : 2/3 ESP

ANGLE SELECTION (DVD)

Some DVDs contain scenes which have been shot from a number of different angles. For these discs, the same scene can be viewed from each of these different angles.

1. While you are playing a DVD with different angles recorded, press the **ANGLE** button to view the number of the current angle available.
2. Press the **ANGLE** button repeatedly to change the scene to the next angle in those recorded.
 - About two seconds later, playback continues from the new angle you selected.
 - If no button is pressed within 10 seconds, playback continues without changing the current angle.

NOTES

- This function can only be used for discs on which scenes shot from multiple angles have been recorded.
- If only one angle is recorded, "Ⓜ 1/1" is displayed.

Ⓜ : [2 / 3]

Sequence of angle shots
(Example)



SPECIAL FUNCTION

DISPLAY

While the disc is playing, press the **DISPLAY** button repeatedly to display information on operation status.

	Title	Chapter	Elapsed time
DVD	TT 1/21	CH 6/29	⌚ 00:07:18
	Audio	Subtitle	Angle
Ⓜ	1/3 ENG	DOD 6 CH	📺 2/3 ESP OFF
	Title	Chapter	Remaining time
DVD	TT 1/21	CH 11/29	R -00:30:28
	Title	Chapter	Total time
DVD	TT 1/21	CH 11/29	T -01:00:28

LOCATING A SPECIFIC TITLE (DVD)

If a DVD disc contains title numbers, you can locate a specific title by directly selecting its title number.

1. In STOP mode, press the **GOTO** button.
2. Press the ◀ or ▶ button to highlight a specific field and press the corresponding number button(s) for the title you want.
3. Press the **ENTER** button to confirm. The unit will start playback about 3 second later.

DVD TT 00/21 CH 029/029 ⌚ 00:00:00

LOCATING A SPECIFIC CHAPTER / TRACK

If you know the chapter / track number you want to play, you can locate a specific chapter / track by directly selecting a chapter / track number.

1. Press the **GOTO** button to search for your desired chapter / track.
2. Press the ◀ or ▶ button to highlight a chapter / track and press the corresponding number button(s) for the chapter / track you want.
3. Press the **ENTER** button to confirm. The unit will start playback about 3 second later.

DVD TT 00/34 CH 000/029 ⌚ 00:00:00

CD TRK 00 / 12 🔊 🔍 ⌚ 00:00:00

LOCATING A SPECIFIC TIME

You can move to a specific location by entering its corresponding time (hours, minutes, seconds)

1. Press the **GOTO** button.
2. Press the ◀ or ▶ button to highlight a time and press the corresponding number button(s) for the setting point you want.
3. Press the **ENTER** button to confirm. The unit will start playback about 3 second later.

DVD TT 00/21 CH 029/029 ⌚ 01:00:00

NOTES

- Some discs may not respond to this process.
- This method of locating a title/chapter is available only on a DVD disc that contains title/chapter numbers.
- Some scenes may not be located as precisely as you specified.
- This method for accessing specific locations is available only within the current title of the DVD disc.

REPEAT PLAYBACK

You can play a specific title or chapter repeatedly.

(Title repeat, chapter repeat)

REPEATING A CHAPTER (DVD)

When you play the same chapter repeatedly.

1. While the DVD disc is playing, press the **REPEAT** button until the "**REP : CHAPTER**" indicator displays on the screen. The current chapter is played repeatedly.

REPEATING A TITLE

When you play the same title repeatedly.

2. While the DVD disc is playing, press the **REPEAT** button until the "**REP : TITLE**" indicator displays on the screen. The current title is played repeatedly.

To resume normal playback

3. While the DVD disc is playing, press the **REPEAT** button until the "**REP : OFF**" indicator displays on the screen.

You can play a single track or an entire disc repeatedly.

REPEATING A SINGLE TRACK (CD)

You can play the same track repeatedly.

1. When the CD disc is playing, press the **REPEAT** button until the "**REP : REP1**" indicator displays on the screen. The current track is played repeatedly.

REPEATING AN ENTIRE DISC

2. While the CD disc is playing, press the **REPEAT** button until the "**REP : REP ALL**" indicator displays on the screen. The entire disc is played repeatedly.

To resume normal playback

3. Press the **REPEAT** button until the "**REP : OFF**" indicator display on the screen.

DVD / CD PROGRAMMABLE PLAYBACK

PROGRAMMABLE MEMORY

The two types of programmed playback provided by this unit are title/chapter programmed playback and track programmed playback.

Title / chapter programmed playback (DVD)

1. In STOP mode, press the **MEMORY** button.
2. Enter the title numbers in **---**. Use the **◀** or **▶** button to move the highlight to chapter and enter the chapter numbers in **---**.
3. Use the **◀**, **▶**, **▲** or **▼** button to move to other fields.
4. Repeat steps 2 to 3.
5. Press the **▶ PLAY** button to start the programmed playback.

Title		Chapter						
PROG	T C	T C	T C	T C	T C			
1	---	5	---	9	---	13	---	
2	---	6	---	10	---	14	---	
3	---	7	---	11	---	15	---	
4	---	8	---	12	---	16	---	
				PLAY	CLEAR			

Track programmed playback (CD)

1. In STOP mode, press the **MEMORY** button.
2. Enter the track numbers in **----**.
3. Use the **◀**, **▶**, **▲** or **▼** button to move to other fields.
4. Repeat steps 2 to 3.
5. Press the **▶ PLAY** button to start the programmed playback.

Track								
PROG	T C	T C	T C	T C				
1	----	5	----	9	----	13	----	
2	----	6	----	10	----	14	----	
3	----	7	----	11	----	15	----	
4	----	8	----	12	----	16	----	
				PLAY	CLEAR			

CUSTOMIZING THE FUNCTION SETTINGS

LANGUAGE SETUP

1. Press the **SETUP** button in STOP mode.
2. Use the **▶** button to change the highlight cursor. Use the **▲** or **▼** button to select a language, then press the **ENTER** button. The screen will change to your selected language immediately.
3. To exit the **SETUP MENU** and return to the normal screen, press the **SETUP** or **RETURN** button.

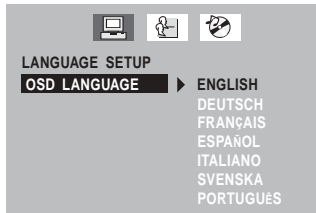

VIDEO SETUP

1. Press the **SETUP** button in STOP mode.
2. Use the **▲** button to select **LANGUAGE SETUP**, then press the **◀** or **▶** button repeatedly until **VIDEO SETUP** appears.
3. Use the **▲** or **▼** button to select the option (**BRIGHTNESS** or **CONTRAST**), then press the **▶** button. Use the **▲** or **▼** button to make adjustments, then press the **ENTER** button. The screen will change to your selected setting.
4. Repeat steps 2 and 3 above to adjust other options.
5. To exit the **SETUP MENU** and return to the normal screen, press the **SETUP** or **RETURN** button.



CUSTOMIZING THE FUNCTION SETTINGS

SYSTEM SETUP

1. Press the **SETUP** button in STOP mode.
2. Use the **▲** button to select LANGUAGE SETUP, then press the **◀** or **▶** button repeatedly until SYSTEM SETUP appears.
3. Use the **▲** or **▼** button to select the option (**TV TYPE** or **DEFAULT**), then press the **▶** button. Use the **▲** or **▼** button to make adjustments, then press the **ENTER** button. The screen will change to your selected setting.
4. Repeat steps 2 and 3 above to adjust other options.
5. To exit the SETUP MENU and return to the normal screen, press the **SETUP** or **RETURN** button.

TV Type

Pan Scan

- When wide-screen video is played, this mode clips the right and left sides of the image so that it can be viewed on a conventional screen.
- Some wide-screen DVDs that do not permit Pan Scan playback are automatically played in Letter Box mode (black bands at top and bottom of screen).

Letter Box

- When wide-screen video is played in this mode on a conventional screen, black bands appear at the top and bottom of the screen.

Wide-screen

- This is the correct mode for playing wide-screen videos on a wide-screen.

NOTES

- The displayable picture size is preset on the DVD discs. Therefore the playback picture of some DVDs may not conform to the picture size you select.
- When you play DVDs recorded in the 4:3 aspect ratio, the playback picture will always appear in the 4:3 aspect ratio regardless of the TV shape setting.

Default

It takes 3-5 seconds to reset the unit to the factory default.



SYSTEM SETUP

TV TYPE
DEFAULT

Cut off when a wide-screen video image is played.



Pan Scan



Letter Box



Wide-screen

TROUBLESHOOTING GUIDE

SYMPTOM

CAUSE (AND REMEDY)

No power.

- Check that the AC adapter and AC power cord are connected.
- The unit is not turned on.

The remote does not function.

- Remove any obstacles between the remote and the unit.
- Use the remote near the unit.
- Point the remote at the remote sensor on the unit.
- Replace the batteries in the remote with new ones.

DVD

No sound or only a very low-level sound is heard.

- Make sure that you select DVD mode.
- The system is in pause mode. Press the ► **PLAY** button to return to normal PLAY mode.
- Fast-forward or fast-reverse is performed. Press the ► **PLAY** button to return to normal play mode.
- Make sure that AUDIO / VIDEO output and AV IN input connections are correct.
- The DTS DVD disc cannot be decoded to have speaker output.
- The unit is too hot, shut off the unit for 30 minutes to cool it down.

No picture.

- The region number of the disc doesn't match the region number of this unit.



The picture is not clear.

- Clean the disc.
- The disc is scratched.

Severe hum or noise is heard.

- The plugs and jacks are dirty. Wipe them with a cloth slightly moistened with alcohol.
- Clean the disc.

The disc does not play.

- There is no disc inside ("No Disc" appears on the screen).
- Insert the disc correctly with the playback side facing down.
- Clean the disc.
- A non-valid disc has been inserted. The unit and disc region number are incompatible.
- Condensation may have formed inside the unit due to a sudden change in temperature. Wait about an hour for it to clear and try again.

TV

Bad Picture (snow, multiple images, distortion, blurry)

- Check the location of the antenna and adjust it if necessary.
- Make sure the antenna cable is firmly connected.
- Make sure all input cables are firmly connected.

Black and white picture.

- Check the PICTURE SETTING within the TV SETUP MENU.
- Check to make sure the program you are watching is broadcast in Color and not Black & White.

No picture or sound.

- Make sure the unit is plugged in and turned on.
- Make sure that TV mode is selected.
- Try a new channel to check for possible station trouble.
- Make sure the antenna is connected properly.
- Increase the volume.
- Make sure the antenna or audio video source device is working properly.
- Make sure all cables are firmly connected.
- Check for local interference.

Colored patches of picture.

- Make sure there are no unshielded electrical devices nearby that are causing interference.
- Turn the unit off for 30 minutes, then try it again.

Unit : INCH

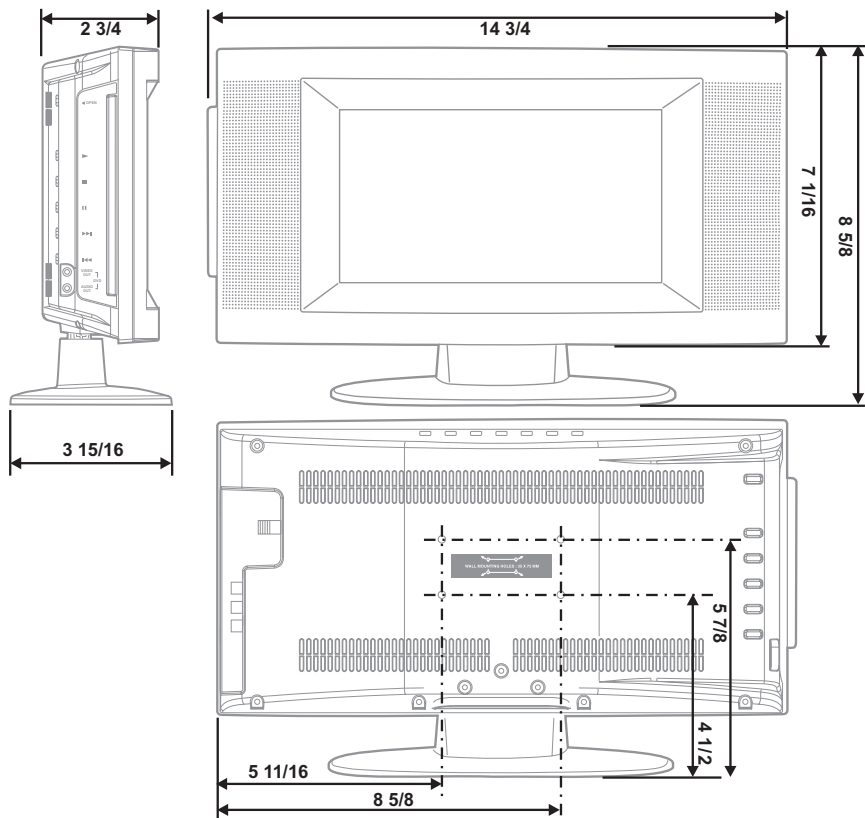

Printed in China
811-210991W011

Free Manuals Download Website

<http://myh66.com>

<http://usermanuals.us>

<http://www.somanuals.com>

<http://www.4manuals.cc>

<http://www.manual-lib.com>

<http://www.404manual.com>

<http://www.luxmanual.com>

<http://aubethermostatmanual.com>

Golf course search by state

<http://golfingnear.com>

Email search by domain

<http://emailbydomain.com>

Auto manuals search

<http://auto.somanuals.com>

TV manuals search

<http://tv.somanuals.com>