

AUDIOWOX

CD / MP3 Disc Player with Anti-Shock System

CE151MP

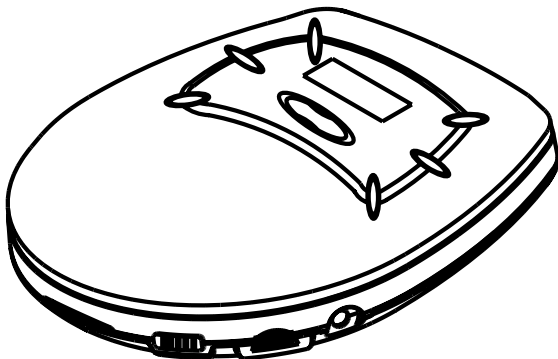

INSTRUCTION MANUAL

128-6205

PLEASE READ THE INSTRUCTION CAREFULLY BEFORE OPERATING THIS UNIT.

WARNING

To prevent fire or shock hazard, do not expose this appliance to rain or moisture.

IMPORTANT

Since the CD circuitry may cause interference to other radio tuners nearby, switch this unit off when not in use or move it away from the affected radio tuner.

This device complies with Part 15 of the FCC Rules, operation is subject to the following two conditions: (1) This device may not cause harmful interference, and (2) this device must accept any interference received, including interference that may cause undesirable operation.

NOTE : This equipment has been tested and found to comply within the limits for a Class B digital device, pursuant to Part 15 of the FCC Rules. These limits are designed to provide reasonable protection against harmful interference in a residential installation. This equipment generates, uses and can radiate radio frequency energy and, if not installed and used in accordance with the instruction, may cause harmful interference to radio communications. However, there is no guarantee that interference will not occur in a particular installation. If this equipment does cause harmful interference to radio or television reception, which can be determined by tuning the equipment off and on, the user is encouraged to try to correct the interference by one or more of the following measures:

- Reorient or relocate the receiving antenna.
- Increase the separation between the equipment and receiver.
- Connect the equipment into an outlet on a circuit different from that to which the receiver is connected.
- Consult the dealer or an experienced radio / TV technician for help.

SAFETY CERTIFICATION

This Compact Disc Player is made and tested to meet safety standards of the FCC, requirements and compliance with safety performance of the U.S. Department of Health and Human Services, and also with FDA Radiation Performance Standards 21 CFR Subchapter J.

DANGER



INVISIBLE LASER RADIATION
WHEN OPEN AND INTER-
LOCK FAILED OR DEFEATED.
AVOID DIRECT EXPOSURE
TO LASER BEAM.

LASER SAFETY

This unit employs an optical laser beam system in the CD mechanism, designed with built-in safeguards. Do not attempt to disassemble, refer to qualified service personnel. Exposure to this invisible laser light beam may be harmful to the human eye.

THIS IS A CLASS-1 LASER PRODUCT. USE OF CONTROLS, OR ADJUSTMENTS OR PROCEDURES OTHER THAN THOSE SPECIFIED HEREIN, MAY RESULT IN HAZARDOUS LASER LIGHT BEAM EXPOSURE.

SAFETY PRECAUTIONS

1. Do not open the cabinet. Refer servicing to qualified personnel only.
2. Do not expose to excessive heat, direct sunlight, dust, moisture, vibration or shock.
3. Use ONLY the AC adaptor provide, others may damage your unit. Disconnect from the wall outlet when the set is not to be used for an extended period of time.
4. When cleaning your unit, use a soft dry cloth, do not use solvents or commercially available cleaners as they may damage or discolor the finish.
5. Do not wear headphones while operating a motor vehicle, this could create a traffic hazard and is illegal in many areas.
6. The headphones supplied with your unit provide super stereo listening while allowing you to hear outside sounds when listening at normally low volume levels. Listening at extremely high volume levels minimizes the intrusion of outside noise/sounds.
7. If you notice that the sound has become weak or distorted, this is an indication that your batteries are low. Replace with new or recharged (see "BATTERY OPERATION")

LOCATION OF CONTROLS

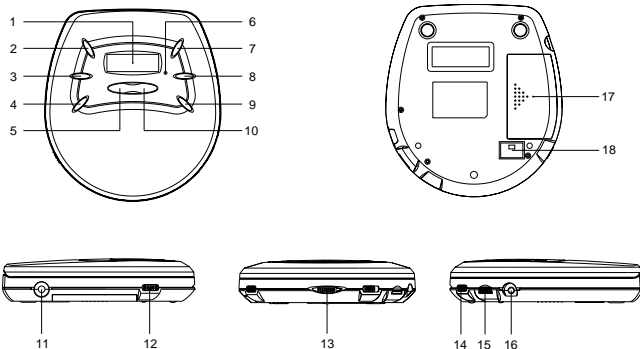

1. LCD Display
2. Menu Up Button
in combination of
- CD : ESP On/Off
- MP3 : ID3 On/Off
3. Program Button
in combination of
- Program Track Select
- Program Track Delete
4. B. Skip / B. Search Button
5. CD Stop in combination of
- Power Off
- Folder Back
6. Charge Indicator
7. Menu Down Button
in combination of
- Key Beep On/Off
8. Menu Button
in combination of
- Equalizer (long press)
- Navigation (MP3 Disc only)
- Play List
- Play Mode
9. F. Skip / F. Search Button
10. Play / Pause Button
in combination of
- Enter
11. DC Input Jack
12. Hold Switch
13. Door Open Switch
14. Bass Boost Switch
15. Volume Control
16. Phones Jack
17. Battery Door
18. Charge Switch

POWER SOURCES NORMAL BATTERIES / AC ADAPTOR

Battery Power Operation

1. Open the battery compartment cover and insert two "AA" alkaline batteries inside the battery compartment. Follow the polarity as indicated in the battery compartment.
2. Close the battery compartment cover.

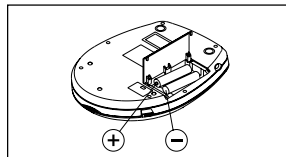

Battery Type	Average Playing Time (Continuous Play)		
	Normal CD	Anti-Shock CD	MP3
Alkaline "AA"	Approx. 9 hrs.	Approx. 8 hrs.	Approx. 10 hrs.
Ni-CAD Rechargeable (min specification recommended 1.2V - 600mA)	Approx. 4 hrs.	Approx. 3 hrs.	Approx. 5 hrs.

Note: Zinc/Carbon, or Zinc/Chloride type batteries are not recommended for this unit as their use will result in extremely it is recommended that the mains adaptor supplied with this unit is used.

AC Operation

1. Insert the DC plug, at the end of the AC adaptor cord into the DC input jack.
2. Plug the AC adaptor into AC power outlet socket. Use only with the provided AC adaptor and make sure the local voltage corresponds to the adaptor's required AC input voltage.

Note: If the AC plug of this unit does not fit in your AC outlet, a plug adaptor (Not supplied) should be used. Consult your local dealer on the type of plug adaptor required.

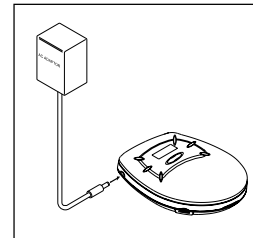

LOW BATTERY ALERT

When the Batt. symbol  is shown, it means that the batteries are losing their charge. In this case the player will not function properly and the batteries must be replaced.

In case the Ni-cd rechargeable are being used follow the instruction on how to recharge the batteries detailed in the owners manual (see "CHARGING AND USE OF RECHARGEABLE BATTERIES".)

CHARGING AND USE OF RECHARGEABLE BATTERIES

Rechargeable Battery Operation

This unit can fully recharge the specified rechargeable battery, in approximately 15 hours. The rechargeable batteries (NOT supplied) should be charged before they are used for the first time, if they have not been used for a long period (over 60 days).

1. Open the battery compartment cover and insert two of the recommended rechargeable batteries, matching polarity. (1.2V 600mA)

BOTH BATTERIES MUST BE THE RECHARGEABLE NICKEL-CADMIUM TYPE.

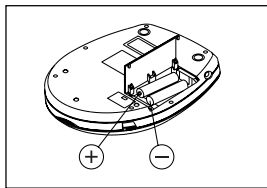

2. Plug in the AC adaptor and set the Charge Switch to ON position to start charging. **USE ONLY THE AC ADAPTOR SUPPLIED WITH THE SET FOR CHARGING.**

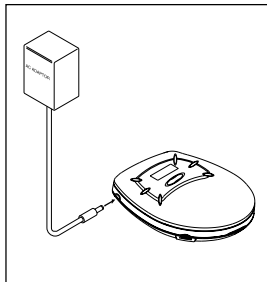

3. After 15 hours, please unplug the AC adaptor and switch the Charge Switch to the OFF position. **DO NOT CHARGE CONTINUOUSLY FOR 24 HOURS OR MORE. DOING SO CAN CAUSE THE PERFORMANCE OF THE RECHARGEABLE BATTERY TO DETERIORATE.**

4. If the operating time decreases drastically even when the rechargeable nickel-cadmium batteries are properly recharged, purchase a new set of rechargeable nickel-cadmium batteries.

5. When charging for the first time or after a long time, playing time may be reduced. In this case, charge and discharge the batteries several times.

LISTENING WITH HEADPHONES

Connect the plug of the stereo headphones into the PHONES (GREEN) socket.

Caution: Avoid excessive volume levels and listening to sound for a long period of time when using headphones.

- Adjust Volume to the desired level.

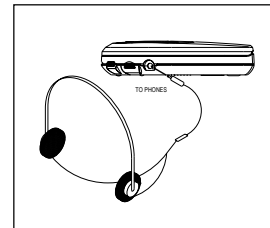

HANDLING COMPACT DISCS

This unit is designed to play only compact disc bearing the identification logo below. Other disc may not conform to the CD standard and may not play properly.



- Dirty, scratched or warped disc may cause skipping or noise.
- Handle the disc only by the edges. To keep clean, do not touch its surface.
- Discs should be stored in their cases after use to avoid serious scratches.
- Do not expose disc to direct sunlight, high humidity, high temperatures or dust etc. Prolonged exposure to extreme temperatures can warp the disc.
- Do not stick or write anything on either side of disc. Sharp writing instruments, or the inks used in some felttip pens, may damage its surface.

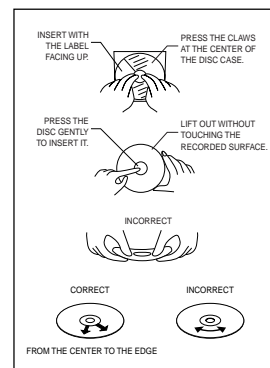

Remove the disc

Hold the edge and gently press the centre pivot as illustrated, to pick up the disc.

CAUTION:

Wait for the disc to stop rotating before pressing the OPEN button.

Note: This unit can play 3" (8cm) single CD's without an adaptor. Do not use a CD single adaptor for these discs.

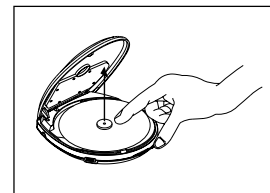

CLEANING DISCS

Finger prints should be carefully wiped from the surface of the disc with a soft cloth. Unlike conventional records, compact discs have no grooves to collect dust and microscopic debris, so gently wiping them with a soft cloth should remove most particles. Wipe in a straight motion from the center to the edge.

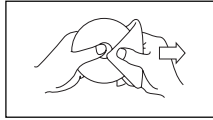

Never use thinner, benzene, record cleaner or anti-static spray on a compact disc. Such chemicals can damage its plastic surface.

BASIC DISC PLAY

1. Connect the headphones to the PHONES (GREEN) socket.
2. Press the **OPEN** button to open the CD compartment lid.
3. Adjust the **VOLUME** to desired the sound level.
4. Insert the disc with the label side facing up.
5. Close the lid securely until a click is heard.
6. Press the **PLAY** button to start playing.

To Emphasize the bass sound

Set the **BASS BOOST** switch to the ON position.

Note: The bass boost performance will be dependant on the **VOLUME** control setting.

- During play or stop mode, by sliding this switch, a <BASS ON> or <BASS OFF> message will be displayed.

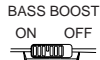

HOLD Switch

This switch prevents accidental selection of an unwanted function during playback or stop mode. In the HOLD "ON" position, no function button on the unit can operated (except OPEN). Moving the switch to the "OFF" position, the unit returns to normal operation.

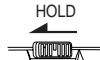

During play or stop mode, by sliding this switch, a <HOLD ON> or <HOLD OFF> message will be displayed.

If the player is turned on when the **HOLD** feature is activated, the screen will display a <KEY HOLD> and <Good Bye> message. The unit will then power down automatically.

Turning Power on and off

This unit has no ON/OFF switch. To turn on and off, press the following buttons.

To turn on: Press **PLAY/PAUSE** (playback starts).

To turn off: Press **STOP** button once to standby mode.

If press **STOP** button twice, it will turn off the power immediately.

Auto power-off function

When the unit is stopped (standby mode) for approximately 30 seconds, the power is automatically turned off.

LCD DISPLAY INFORMATION

When power on, CD lid is closed:

- If disc is in, starts CD reading.

CD Disc

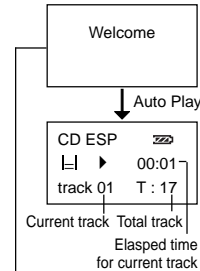

- If no disc

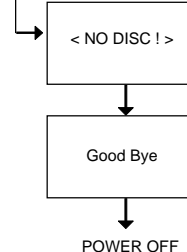

MP3 Disc

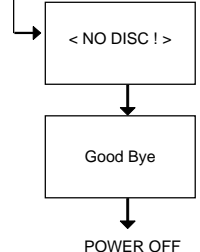
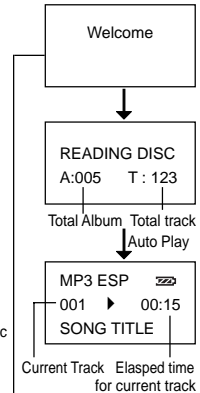

- Other un-recognized CD format discs.

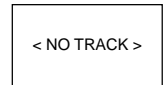
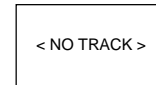

NOTE: On rare occasions, the unit may display <Can Not Read> or <READING DISC> or other messages. This condition is caused by a CD with an unrecognized format. If the player is unresponsive or appears to be locked up, simply open the CD door, remove the CD and replace with a CD containing a supported format.

- Stop mode

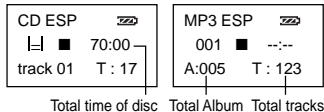

- CD and MP3-CD playback from stop mode:
 - Press **PLAY/PAUSE** button to start play.
 - Press this button again to pause play temporarily, elapsed time display is flashing, play symbol is changed to "II"
 - Press this button once again to resume play.

- Skip/search forward and backward
 - During stop or play mode, press **>>I** or **I<<** buttons to skip track forward or backward.
 - During play, press and hold button **>>I** or **I<<** to search forward or backward within current track.

- Stop
 - During play, press **STOP** button to stop play.

- Menu
 - Long press **MENU** button to enter equalize mode selection.
 - Press **MENU UP** or **MENU DOWN** buttons to select desired EQ setting:
 1. Normal
 2. Rock
 3. Pop
 4. Jazz
 5. Classic
 - When desired mode is displayed, press **PLAY/PAUSE** button to confirm.

CD and MP3 Disc

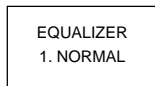

R=ROCK; P=POP;
J=JAZZ; C=CLASSIC;
NORMAL= no indication

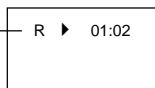

- Short press **MENU** button to display "MENU".
- Press **MENU UP** or **MENU DOWN** button to display:
 1. Navigation
 2. Play List
 3. Play Mode

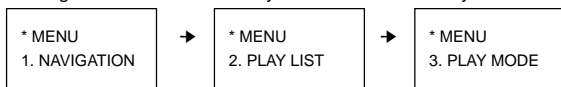

(For MP3 disc only, please refer to chapter "NAVIGATION" for details)

- Play List
 - When Play List displayed, press **PLAY/PAUSE (ENTER)** button to confirm
 - If no track is programmed, [PGM LIST 000] will be shown.

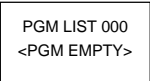

- If programmed tracks were made.
- Press **MENU UP** or **MENU DOWN** button to view program track number and song titles (MP3 only). Also refer to example below.
- You can play any selected track within playlist by pressing **PLAY/PAUSE** button.
- Pre-programmed tracks will play in ascending order.

Example : (For CD disc) Pre-programmed CD audio tracks in order : 6, 2, 8

Example : (For MP3 disc) Pre-programmed MP3 tracks in order: track 6, Song title 6; track 2, Song title 2; track 8, Song title 8

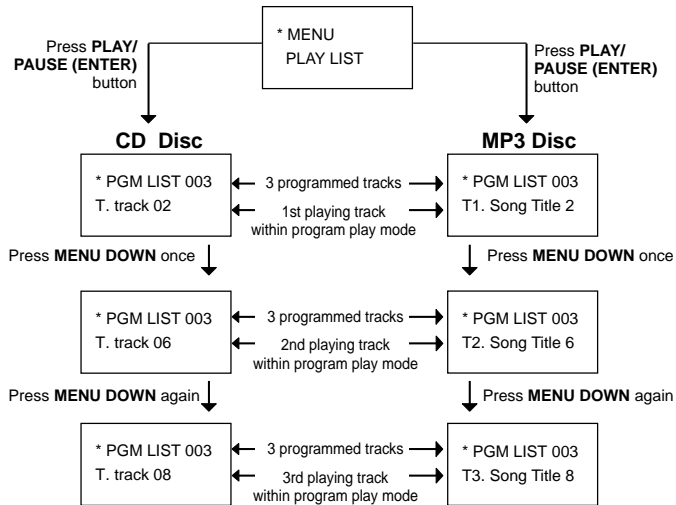

• Play Mode

- When Play Mode displayed, press **PLAY/PAUSE** button to confirm.
- Press **MENU UP** or **MENU DOWN** button to select other mode to display:
 1. Normal
 2. Introduction
 3. Repeat 1
 4. Repeat All
 5. Random
 6. Program
 7. ProgramRepeat
 8. Program Random
- Press **PLAY/PAUSE (ENTER)** button to confirm above mode to be selected.

* PLAY MODE
1. NORMAL

1. Normal

- Normal playback mode.

2. Introduction (INT)

- Play all tracks for the first 10 seconds.

3. Repeat 1 (RPT 1)

- Repeat to play current track

4. Repeat ALL (RPT ALL)

- Repeat all tracks for the entire disc.

5. Random (RDM)

- Play all tracks in Random sequence.

6. Program (PRG)

- Playback according to program list (within play list), if programmed track(s) available.

7. Program Repeat (PRG RPT)

- Repeat to play the program list (within play list), if programmed track(s) available.

8. Program Random (PRG RDM)

- Playback the program list (within play list) in random sequence, if programmed track(s) available.

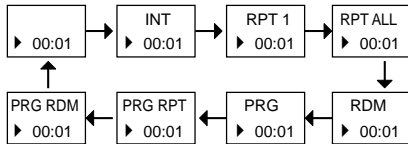

• Program Tracks

Programs can be set in stop or play mode:

- Select desired tracks by pressing **>>I** or **I<<** button.
- Press **PROGRAM** button to confirm the selected tracks, LCD will show <Selected>.
- Repeat above steps to select more tracks.

▶ 00:15
< Selected >

• To view program list

- Refer to Play List description.

• To play program tracks

- Refer to Play Mode - Program, Program Repeat and Program Random.

• Programmed track delete

Tracks can be deleted in stop or play mode.

- Press **MENU** button to enter "PLAY LIST"
- Press **PLAY/PAUSE (ENTER)** button to confirm.
- Press **MENU UP** or **MENU DOWN** button for desired tracks.
- Short press **PROGRAM** button to display.

<Delete 1>
≥ YES ≤ NO

- Long press **PROGRAM** button to display.

<Delete ALL>
≥ YES ≤ NO

- Press **>>I** or **I<<** button to change "YES" or "NO"

- Press **PLAY/PAUSE** button to confirm "YES" or "NO"

If confirmed to "YES", the desired track or all tracks will be deleted.



If confirmed to "NO", the desired track or all tracks will not be deleted.

- Repeat above steps to confirm "YES" or "NO" to delete or keep programmed tracks.

USING ANTI-SKIP (ESP) FEATURE

When playing a CD with CD Audio files, press ESP button (2), then  will appear on display.

Note the " |x|" indicator appears on display as being empty when first activated. As it immediately begins to store sound data in memory bank, it shows "  " to indicate the data buffer is full.

When the laser loses tracking due to mechanical shock, the data stream into the memory is interrupted but the data output from the memory buffer continues, so the sound is uninterrupted. As the data is read from the memory, the indicator changes from "  " to "  ".

Once the laser locks again on the CD track, the data stream is fed to the memory and joined to the previous data (see indicator changes).

REMINDER ...

If the unit is subjected to excessive and continuous repeated shocks, the memory buffer becomes overloaded beyond its capacity therefore causing the sound to skip. Also note the " |x|" indicator will remain empty.

NOTES

- When the "ESP" is operating, the battery consumption is higher because the disc rotates faster than normal and the memory circuitry is activated.
- When the digital anti-skip function is switched "ON" or "OFF", the sound is interrupted for a short time. This is normal.

- Remember that conditions such as dirty, scratched or warped discs may cause skipping or noise thereby affecting performance of "ANTI-SKIP" system.
- The ESP button is for CD playback function only. When playback the MP3 format disc, the ESP is always on.

SPECIAL FUNCTION FOR MP3-CDs

- Button (2), ID3 ON/OFF
ID3 ON : Song title and other information (such as singer name) to be displayed.
ID3 OFF: Song title to be displayed

- Button (8) NAVIGATION

- Press **PLAY/PAUSE** button to enter "NAVIGATION"
- Press **MENU UP** or **MENU DOWN** button to display:

* MENU
1. NAVIGATION

* NAVIGATION
1. BY TRACK



* NAVIGATION
2. BY ALBUM



* NAVIGATION
3. BY ALPHABT

- Press **PLAY/PAUSE** button to confirm "1. BY TRACK".
- Press **MENU UP** or **MENU DOWN** button to change track number and corresponding song title will also display.
- If desired track is selected, press **PLAY/PAUSE** button to play this track.

* NAVIGATION
1. BY TRACK

- Press **PLAY/PAUSE** button to confirm "2. BY ALBUM".
(If no Album found, it will turn to "BY TRACK".

* NAVIGATION
2. BY ALBUM

- Press **PLAY/PAUSE** button to confirm desired Album.
- Press **MENU UP** or **MENU DOWN** button to display different tracks under same album.
- If desired album and track are selected, press **PLAY/PAUSE** button to play.

* BY ALBUM
a. Album Name

Album

* a. Album Name
t1. Song Title

- Press **PLAY/PAUSE** button to confirm "3. BY ALPHABET"
- Press **>>I** or **I<<** to display different letters that the corresponding song title begins with and track number will display.
(If no corresponding song title to match displayed alphabet, <Not Found !> will display.)
- Press **PLAY/PAUSE** button to start play if desired track appears.

* ALPHABET : B-
t115. Song Title

Selected alphabet

Note:

- Within NAVIGATION BY TRACK, BY ALBUM or BY ALPHABET stall, short press **PROGRAM** button to program the desired track (expressed by T symbol) or desired album (expressed by A symbol). Short press again to delete the programmed track (expressed by t symbol) or (expressed by a symbol).
- Long press **PROGRAM** button to enter <SELECT ALL> tracks. Long press this button again to enter <DELETE ALL> tracks, all tracks will be selected or all programmed tracks will be deleted accordingly.

MAINTENANCE

Cleaning the Cabinet

Wipe with a soft cloth. If the cabinet is very dirty, dampen the cloth with a weak solution of neutral detergent and water, and then wipe clean.

Cleaning the Lens

A dirty lens will cause sound skipping and, if the lens is very dirty, the CD may not work. Open the disc cover and clean the lens as below.

- Dust or Dry Particles

Using a camera lens brush/blower, blow on the lens couple times, then wipe it lightly with the brush to remove dust. Then, blow on the lens once more.

- Fingerprints

If the lens cannot be cleaned by using a brush/blower, use a dry cotton swab starting in the middle and working to the outside edge.

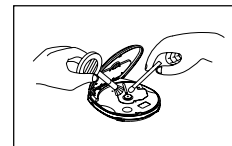

Playback information:

General Supports:

- Up to 99 tracks playback and program for CD audio track.
- CD Audio, CD-R (Recordable) and CD-RW (Rewritable) disc.
- Mixed mode disc, however CD Audio Track is default playback mode.

For MP3-CD Support:

- Up to 999 tracks playback and programmed.
- MP3 music file format only.
- ISO9660, Joliet, Multisession
- MP3 bit rate from 32 – 320 kpbs and variable bit rate.
- ID3 V1.0 TAG.
- English Text.

NOTE:

- This set cannot read the disc recorded by Direct CD, Packet Writing and UDF format disc.

PRODUCT SPECIFICATIONS

PICK UP

System	Compact disc digital audio system
Properties	Wavelength: $\lambda = 780\text{nm}$
Supported Disc Type	CD Audio, CD-R, CD-RW

AUDIO

D/A conversion	DAC four times oversampling
Frequency response	20-20,000Hz
Wow and filter	Below measurable limits
No. of channels	2 Channel (stereo)
Output level	Headphones : 20mW (32 Ω)
Bass boost effect (100Hz)	> 6dB
Equalizer	Normal, Rock, Pop, Jazz, Classic

DISPLAY

1 row icons, 2 rows 12-character dot matrix LCD

GENERAL

Power requirements	- 2 x LR6 "AA" alkaline battery - DC in 6V jack accepts AC power adaptor (centre positive)
Power consumption	0.8W (DC 3V) under normal condition
Dimension	Approx. 133 (W) x 31 (H) x 146 (D) mm
Weight	Approx. 290g not including battery

DESIGN AND SPECIFICATION ARE SUBJECT TO CHANGE WITHOUT NOTICE.

TROUBLE SHOOTING GUIDE

Check the following guide for problem resolution

SYMPTOM	CAUSE	SOLUTION
CD/MP3 Player will not turn on	Dead or weak batteries.	Replace batteries.
	AC adaptor not connected properly.	Check AC adaptor connection.
Disc will not play	Defective compact disc.	Reinsert disc with label disc facing up.
	Defective compact disc.	Try another compact disc.
	CD compartment not closed	Closed lid securely.
	Moisture has formed.	Remove the disc, and leave the compartment door open for about one hour to dry the moisture condensation.
No sound from headphones	Headphone plug not inserted properly.	Reinsert headphone cord into headphones jack.
	Volume control set to minimum. Weak batteries	Increase the volume. Replace with fresh batteries or use AC power
	Defective compact disc	Try another compact disc.
Sound is skipping	The compact disc or pickup lens is dirty.	Clean or replace the compact disc or clean the pickup lens.
	Strong vibrations.	Place the CD/MP3 Player on a level surface that is stable (no vibrations).
Button keys no response	HOLD switch in "ON" position.	Slide the HOLD switch in "OFF" position.
Irregular characters display	Weak batteries	Replace batteries
	Electro-Static discharge to the player	Open and Close the CD door, start the player again.

Free Manuals Download Website

<http://myh66.com>

<http://usermanuals.us>

<http://www.somanuals.com>

<http://www.4manuals.cc>

<http://www.manual-lib.com>

<http://www.404manual.com>

<http://www.luxmanual.com>

<http://aubethermostatmanual.com>

Golf course search by state

<http://golfingnear.com>

Email search by domain

<http://emailbydomain.com>

Auto manuals search

<http://auto.somanuals.com>

TV manuals search

<http://tv.somanuals.com>