

# VSI-PRO

Version 13



## VIDEO SERIAL CASH REGISTER INTERFACE

Operation Manual

June 2008



# VSI-Pro



**CAUTION!**  
**RISK OF ELECTRICAL SHOCK!**  
**DO NOT OPEN!**

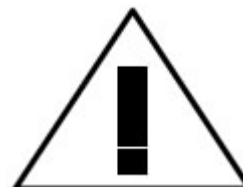

**TO PREVENT ELECTRIC SHOCK, DO NOT REMOVE THE COVER. DO NOT EXPOSE THE EQUIPMENT TO RAIN OR MOISTURE. NO USER SERVICEABLE PARTS ARE INSIDE. REFER SERVICING TO QUALIFIED PERSONNEL.**

## **WARNING!**

**THIS EQUIPMENT GENERATES, USES, AND CAN RADIATE RADIO FREQUENCY ENERGY AND IF NOT INSTALLED AND USED IN ACCORDANCE WITH THE INSTRUCTION MANUAL MAY CAUSE INTERFERENCE TO RADIO COMMUNICATIONS. IT HAS BEEN TESTED AND FOUND TO COMPLY WITH THE LIMITS FOR A CLASS A COMPUTING DEVICE PURSUANT TO SUBPART J OF PART 15 OF FCC RULES, WHICH ARE DESIGNED TO PROVIDE REASONABLE PROTECTION AGAINST SUCH INTERFERENCE WHEN OPERATED IN A COMMERCIAL ENVIRONMENT. OPERATION OF THIS EQUIPMENT IN A RESIDENTIAL AREA IS LIKELY TO CAUSE INTERFERENCE IN WHICH CASE THE USER AT HIS/HER OWN EXPENSE WILL BE REQUIRED TO TAKE WHATEVER MEASURES MAY BE REQUIRED TO CORRECT THE INTERFERENCE.**

### **AVE Multiview UK**

**Unit 1C, The Potteries,  
Woodgreen Road, Waltham  
Abbey Essex, EN9 3SA, UK  
Tel: 440-870-770-9323  
Fax: 440-870-770-9363  
Email: [ave-uk@multiview.net](mailto:ave-uk@multiview.net)  
[www.multiview.net](http://www.multiview.net)**

### **AVE Multiview USA**

**2000 West Governors Circle  
Suite E, Houston, Texas 77092  
Tel: 1-281-443-2300  
Fax: 1-281-443-8915  
Email: [sales@aveusa.com](mailto:sales@aveusa.com)  
<http://www.americanvideoequipment.com>**

### **AVE Thailand Co., Ltd.**

**147 Soi On-Nut 44  
Sukhumvit 77 Rd., Suan Luang  
Bangkok 10250, Thailand  
Tel: 662-331-9364, 331-9285  
Fax: 662-331-9554  
Email: [ave@avethailand.com](mailto:ave@avethailand.com)  
<http://www.ave.co.th> (Thai)  
<http://www.avethailand.com> (English)**

**Copyright © AVE Thailand Co., Ltd. 2000-2008**

1. Introduction.....	7
2. Features & Specifications.....	8
2.1 Features.....	8
2.2 Specifications.....	9
3. Connections.....	10
3.1 RS-232 Serial Input.....	11
4. User Front Panel Controls.....	13
4.1 Front Panel Controls.....	13
5. Programming.....	15
5.1 Getting Started.....	15
5.2 Main- Menu Programming.....	15
5.3 Register Select.....	15
Section A : VSI-Pro Version 13.00.....	16
TCPIP.....	16
Section B : VSI-Pro Version 13.24.....	21
5.4 Screen Setup.....	23
Text Grayscale.....	23
Background Gayscale.....	23
Clock.....	24
On-Screen Titler.....	24
Titler.....	25
5.5 Text Display.....	25
Screen Blank.....	26
Display Line.....	26
Display Format.....	26
Space Compress .....	27
Left Justified.....	27
Scroll Delay.....	27
Display.....	27
5.6 Communication.....	28
Interface Type.....	28
RX Baudrate.....	28
TX Baudrate.....	28
Parity.....	29
Data Bits.....	29
Handshake.....	29
Auto Linefeed.....	29
5.7 Exception Report.....	29
Exception History.....	31
DVR Selection.....	31
Time Search.....	32
Set Exception.....	33
Scroll Matching.....	35
Exception String.....	36
Operator.....	36
Range.....	36
5.8 Alarm Output.....	39
Alarm No.....	39
Alarm Trigger.....	40
Normal State.....	40
Alarm Duration.....	40
Flag Type.....	41
Flag Duration.....	41
Triggered Text.....	41
Set Triggered Text.....	42
5.9 Test / Demo Mode.....	42
Port 1 Test.....	43
Data Capture.....	45
Register Demo.....	46
Version ID.....	46

## CONTENTS

5.10 Download/Upload Setup.....	46
Download/Upload Setup Using VSI-Pro to VSI-Pro.....	47
Download/Upload Setup Using a PC.....	49
Update Firmware.....	52
5.11 Help.....	55

## APPENDICES

Appendix A : Problem Solving Guide.....	55
Appendix B : PC-Based Cash Register.....	57
Appendix C : Hydra and Regcom.....	58
Appendix D : RS-485 Networker.....	62
Appendix E : PC Software with Cash Register.....	63
Appendix F : RS485 Vnetworker.....	63
Appendix G : VSIB Installation.....	66
Appendix H : ECR Interface Cards.....	67
Appendix I : TCPIP 232 Adapter.....	68
Appendix J : Hard Alarm Output.....	69
Appendix K : Register Select.....	70
Appendix L : Master Reset.....	73
Appendix M : Limited Warranty.....	74
Appendix N : Notes.....	73 & 75

## TABLES

Table 1 : Pin-Out of the DB-9 Female Connector on the VSI-Pro RS-232.....	10
Table 2 : RS-232 DB-9 Pin-Out vs VSI-Pro DB-9 Pin-Out.....	10
Table 3 : Pin-Out of the DB-9 Female Connector on the VSI-Pro RS-422 / RS-485.....	11
Table 2C : DB-9 Pin-Out.....	59
Table 3C : RJ-45 Pin-Out.....	59
Table 4C : RS-485 Network Data Cable Wiring.....	60
Table 5C : Electrical Characteristics.....	60
Table 6C : Physical Characteristics.....	60
Table 7C : RS-232 Parameter.....	60
Table 8C : Network Parameter.....	60
Table 9C : Address Selection.....	61
Table 1I : VSI-Pro Version 13.00 Register Menu.....	70
Table 2I : VSI-Pro Version 13.24 Register Menu.....	72

## FIGURES

Figure 1 : Front of VSI-Pro.....	8
Figure 2 : VSI-Pro Rear Panel.....	10
Figure 3 : VSI-Pro Cable Connections.....	10
Figure 4 : VSI-Pro Connections.....	12
Figure 5 : Four Front Panel Push Button of VSI-Pro.....	13
Figure 6 : Four Front Panel Push Button of VSI-Pro (Down).....	13
Figure 7 : Four Front Panel Push Button of VSI-Pro (Up).....	13
Figure 8 : Four Front Panel Push Button of VSI-Pro (Set).....	14
Figure 9 : VSI-Pro Main-Menu.....	15
Figure 10-A : Register Select Sub-Menu.....	16
figure 10-B : TCPIP Sub Menu.....	16
Figure 11-A : Addressable VSI Sub-Menu.....	17
Figure 12-A : ADS Sub-Menu.....	17
Figure 13-A : Delta Sono 3.1 Sub-Menu.....	17
Figure 14-A : Dresser Wayne Sub-Menu.....	17
Figure 15-A : POS / CDU Sub-Menu.....	17
Figure 16-A : Nucleus Sub-Menu.....	17
Figure 17-A : Edacom Sub-Menu.....	18
Figure 18-A : Model E90 Sub-Menu.....	18
Figure 19-A : IBM RDS Sub-Menu.....	18

Figure 20-A : Gasboy Sub-Menu.....	18
Figure 21-A : Gilbarco Sub-Menu.....	18
Figure 22-A : IBM 3151 Terminal Sub-Menu.....	18
Figure 23-A : IBM RDS Sub-Menu.....	18
Figure 24-A : Mirelec Sub-Menu.....	18
Figure 25-A : Mirelec MS Series Sub-Menu.....	19
Figure 26-A : Mirelec 9500 Sub-Menu.....	19
Figure 27-A : Micros Sub-Menu.....	19
Figure 28-A : Micros IDN Networker.....	19
Figure 29-A : Micros ISN Networker.....	19
Figure 30-A : NCR Sub-Menu.....	20
Figure 31-A : Nixdorf Beetle Sub-Menu.....	20
Figure 32-A : Norand 1200 Sub-Menu.....	20
Figure 33-A : Panasonic Sub-Menu.....	20
Figure 34-A : Sharp Sub-Menu.....	20
Figure 35-A : Sicom Sub-Menu.....	20
Figure 36-A : Suntronic Sub-Menu.....	20
Figure 37-A : TCI Sub-Menu.....	21
Figure 38-A : Uniwell UN 4025 Sub-Menu.....	21
Figure 39-A : Verifone Sub-Menu.....	21
Figure 40-B : Register Select Sub-Menu.....	21
Figure 41-B : Beetle / 50 Printers Sub-Menu.....	21
Figure 42-B : Casio TK-T 500 Sub-Menu.....	21
Figure 43-B : Clarity Epos Sub-Menu.....	21
Figure 44-B : Dresser Wayne Sub-Menu.....	22
Figure 45-B : POS / CDU Sub-Menu.....	22
Figure 46-B : Nucleus Sub-Menu.....	22
Figure 47-B : EDacom Sub-Menu.....	22
Figure 48-B : Model E90 Sub-Menu.....	22
Figure 49-B : Nixdorf Beetle Sub-Menu.....	22
Figure 50-B : Omega 2000 Sub-Menu.....	22
Figure 51-B : Schlumberger Sub-Menu.....	22
Figure 52-B : Sharp 750 ER - 01PU.....	22
Figure 53 : VSI-Pro On-Screen Setup Menu.....	23
Figure 54 : Clock Display Sub-Menu.....	24
Figure 55 : On-Screen Titler Sub-Menu.....	25
Figure 56 : Text Display Sub-Menu.....	25
Figure 57 : Communication Sub-Menu.....	28
Figure 58 : Exception Report Sub-Menu.....	30
Figure 59 : Exception History Sub-Menu.....	31
Figure 60 : Display of View Exception.....	31
Figure 61 : DVR Selection Sub-Menu.....	31
Figure 62 : DVR-3011.3021 Sub-Menu.....	32
Figure 63 : Display of Time Search.....	33
Figure 64 : VSI-Pro with DVR Connections.....	34
Figure 65 : Set Exception Sub-Menu.....	34
Figure 66 : Alarm Output Sub-Menu.....	40
Figure 67 : Triggered Text Sub-Menu.....	41
Figure 68 : Set Triggered Text Sub-Menu.....	41
Figure 69 : Test / Demo Mode Sub-Menu.....	41
Figure 70 : Port 1 Sub-Menu.....	42
Figure 71 : Recerve [RX ]Test Sub-Menu.....	42
Figure 72 : Transmit [RX ]Test Sub-Menu.....	42
Figure 73 : RX / TX Test Sub-Menu.....	43
Figure 74 : Baudrate Scan Sub-Menu.....	43
Figure 75 : Data Capture Sub-Menu.....	44
Figure 76 : Capture to Port 1 Sub-Menu.....	44
Figure 77 : Capture to Memory.....	44
Figure 78 : Download/Upload Data Cable.....	46

## CONTENTS

---

Figure 79 : Download/Upload Setup Using VSI-Pro to VSI-Pro.....	47
Figure 80 : Download/Upload Sub-Menu.....	48
Figure 81 : Download Setup Sub-Menu & Display.....	48
Figure 82 : Upload Setup Sub-Menu & Display.....	48
Figure P1 : Program Download Menu.....	49
Figure P2 : Remote Menu.....	50
Figure P3 : File Menu.....	51
Figure P4 : About Menu.....	51
Figure P5 : Hyper Terminal Main Menu.....	52
Figure P6 : Connect To Menu.....	53
Figure P7 : Port Settings Menu.....	53
Figure P8 : In-System Programming Display.....	54
Figure 83 : Help Sub-Menu.....	55
Figure 1B : P2RS Parallel Front Panel.....	57
Figure 2B : P2RS Parallel to Serial Converter.....	57
Figure 3B : P2RS Parallel Connection Cables.....	57
Figure 4B : DB-25 Cable.....	57
Figure 5B : Centronics Cable.....	57
Figure 6B : Pin-Out for P2RS to VSI-Pro.....	57
Figure 1C : DS-20-OF VSI-Pro PCB Rack.....	58
Figure 2C : Connection Diagram.....	59
Figure 3C : Hydra / Regcom Front Panel.....	59
Figure 4C : Hydra /Regcom Front Panel.....	59
Figure 1D : Connection Diagram for RS-485 Network.....	62
Figure 1E : Window Tile Horizontal.....	63
Figure 1F : VSI-Pro Front Panel.....	66
Figure 2F : VSIB Front Panel.....	66
Figure 3F : VSIB Rear Panel.....	66
Figure 4F : VSIB Connection Cable.....	66
Figure 5F : Cable Connection to the VSIB.....	66
Figure 6F : Pin-Out for VSIB to VSI-Pro.....	66
Figure 1G : TK 6000/7000 PCB and Cable.....	67
Figure 2G : TK 2300 and Adapter.....	67
Figure 1H : Front of TCPIP232 Adapter.....	68
Figure 2H : Rear of TCPIP 232 Adapter.....	68
Figure 3H : VSI-Pro Connections with TCPIP 232 Adapter.....	68
Figure 4H : Pin-Out for TCPIP 232 Adapter to VSI-Pro.....	68
Figure 1 I : Hard Alarm Output.....	69

## 1. INTRODUCTION

The Video Serial Interface (VSI-Pro) allows characters to be inserted into any video source via an RS-232 / RS-422 / RS-485 link. This allows cash registers, computers, scales, pole displays, printers or any RS-232 / RS-485 / RS-422 communicating device to display alpha-numeric in the video picture of any CCTV system. Simple front panel push-buttons allow the user to simply program all functions and features of the VSI-Pro. This includes characters position, gray scale and a wide variety text processing function including exceptions and alarming features.

Whether used with a cash register providing real time data on an RS-232 port or tapping off a serial printer or pole display, the VSI-Pro is a valuable tool in loss prevention. When used in conjunction with AVE's extensive line of adapters this device can connect to any POS (Point of Sale) / ECR (Electronic Cash Register) or peripheral on the market today. Now available the TCP/IP232 Adapter for interfacing to Ethernet LAN networks to capture common printer data or monitor any single register transactions.

The VSI-Pro can be used to trigger switchers, time lapse VCRs, DVRs, remote transmission devices or other alarming devices via the 2 hardwired open collector alarm outputs.

The VSI-Pro also has an additional RS-232 output that can send the formatted ASCII text to a DVR that can store the data as an electronic file in addition to inserted in the actual video image.

The Exception Processor of the VSI-Pro provides the intelligence to bring questionable or exceptional transactions to view for the user. This allows the user to quickly and easily review employee transactions to identify fraud and theft transactions at the cash register. When used with a compatible DVR, the VSI-Pro will command the DVR to automatically search to the transaction in question for instant review of the recorded video.

With the new "Scroll Matching" feature, users can easily set and erase scrolling advertising messages from the customer display but always record the valid transactions.

The AVE line of VSI-Pro is fully networkable with our "Networker", "Vnetworker", "Hydra" and "Regcom" line of products. These device connect to the VSI-Pro or ECR Interfaces or Adapters directly and communicate back via an RS-485 network to the central location. The Hydra is used to convert this RS-485 network to be compatible with many models of DVRs while the other devices connect at the cash register end. PC Windows-based software can also be used as the controller of this network and store transaction files for up to 64 cash registers for remote viewing or downloading to produce reports for management.

The VSI-Pro is fully remotely downloadable, uploadable or programmable by our PC VSI Programmable software. This utilizes a direct connection via RS-232 from a laptop to the VSI-Pro. Complete VSI-Pro settings can be saved on the laptop and uploaded to the VSI-Pro at will. This is mainly used for dealer maintenance or for single station user programming. The Vnetworker allows the ability to remotely program up to 16 VSI-Pro's with our VNetworker PC based Software which allows all the features of the Networker plus remote programming and setup.

Firmware is also downloadable in the field with our Firmware Utility so new updates and features can be easily passed to customers without changing EPROMs or opening the unit.

### VSI / VSI+ / VSI-Pro Backward Compatibility

Since 1990 various versions of the VSI have been on the market solving cash register retail problems. Several special version are available to interface to other RS-232 devices like scales, coin counters, PLCC, gambling machines and ATMs along with countless other generic RS-232 devices. The first VSI, Version 9 had no exception processing until the release of Version 10. However these versions had the ability to output the data so are compatible with the Regcom line of networking adapters. As features increased we moved to the VSI+ Version 11, which had the first powerful set of exception processing and printing functions. This version also had hardware handshaking capability which allows it to be fully operational with the Networker and Regcom line. The introduction of the VSI-Pro Version 12 added on-screen selection of various model registers for ease of installation and supported many characters sizes for multiple units to display data on one camera view. This version also supports the Networker and Regcom products. The current VSI-Pro Version 13.XX has improved features and additional registers and the Version 13.00 supports North America cash registers and Version 13.24 supports UK and European models. All Version 13.XX VSI-Pro support the Networker and Regcom products. All Version 13.XX can be upgraded to the latest Release 12. This latest software adds PC Programming capability, Firmware update externally and Vnetworker support along with Networker and Regcom compatibility.

Contact the AVE factory for additional details on upgrading and networking with any DVR or learn about the advanced features when integrated with the AVE line of text insertion and search DVRs locally or remotely.



## FEATURES & SPECIFICATIONS

---

### 2. FEATURES & SPECIFICATIONS

#### 2.1 FEATURES

- .....56 register selections
- .....User selectable hardware communications
  - RS-232C
  - RS-485 / RS-422
  - Passive tap (Hi-Z)
- .....Serial output of all data or exceptions to printers, computers, modems and DVRs
- .....Programmable time-stamp on exception output
- .....Time/Date Searching with Compatible DVR
- .....Universal time/date format
- .....100 lines exception history buffer
- .....16 triggered text associated with 16 alarms
- .....Large data buffers for input/output to accommodate newer, faster registers
- .....2 built-in alarm outputs
- .....Powerful data filtering algorithms
- .....Easy on-screen menu-driven setup and programming
- .....Auto baud rate detection
- .....24 field programmable exceptions with numeric range
- .....On-screen flagging of exceptions with asterisk or reverse text
- .....Programmable alarm outputs.
- .....Alarm input for drawer open, safe open, etc.
- .....Programmable delayed screen blanking
- .....Choice of 1 to 11 lines displayed on-screen
- .....On-screen titler up to 40 characters
- .....Gray scale and border selection from front panel
- .....Built-in test mode
- .....Built-in cash register demo
- .....Upload/download programming to a PC or another VSI-Pro
- .....Data captured either to the memory or to the serial port
- .....Local Firmware Downloadable
- .....Local / Remote Programming via PC Software
- .....Supports Hydra/Regcom/Networker/Vnetworker networking communications products



Figure 1: Front of VSI-Pro



**2.2 SPECIFICATIONS**

Video In (BNC)	1V P-P Terminated 75 ohms +/- 20%												
Video Out (BNC)	1V P-P Terminated or Unterminated												
Video S / N	better than 50dB												
Video B / W	better than 7MHz												
Power (DC Coax 2.1mmx5.5mm)	9-12VDC 170mA												
Battery Backup NiMH	1 year with 24 hour charge												
Serial Port (DB-9 Female)	<table border="0"> <tr> <td>RS-232C</td> <td>RS-485 / RS-422</td> <td>PassiveHi-Z</td> </tr> <tr> <td>RXD - Pin 2</td> <td>A - Pin 4</td> <td>RXD - Pin 2</td> </tr> <tr> <td>TXD - Pin 3</td> <td>B - Pin 6</td> <td>TXD - Pin 3</td> </tr> <tr> <td>GND - Pin 5</td> <td>GND - Pin 5</td> <td>GND - Pin 5</td> </tr> </table>	RS-232C	RS-485 / RS-422	PassiveHi-Z	RXD - Pin 2	A - Pin 4	RXD - Pin 2	TXD - Pin 3	B - Pin 6	TXD - Pin 3	GND - Pin 5	GND - Pin 5	GND - Pin 5
RS-232C	RS-485 / RS-422	PassiveHi-Z											
RXD - Pin 2	A - Pin 4	RXD - Pin 2											
TXD - Pin 3	B - Pin 6	TXD - Pin 3											
GND - Pin 5	GND - Pin 5	GND - Pin 5											
Baud Rate	AUTO, 135, 150, 300, 600, 1200, 2400, 4800, 9600, 19.2K, 28.8K, and 38.4K												
Word Length	7 or 8												
Parity	ODD, EVEN, NONE												
Stop Bits	1												
RTS / CTS Handshaking	ON or OFF 3.3K Pull Up												
DTR / DSR	3.3K Pull Up												
Data Buffer	32K bytes												
Alarm Outputs Pin 1 & 9	Open Collector 12VDC @ 20mA												
Real Time Clock	12 or 24 Hr with Auto Daylight Savings Time Programmable												
Date Format	MM/DD/YY, DD/MM/YY, YY/MM/DD Julian Calendar												
Display Characters	40												
Number of Lines	1-11												
Character Gray Scale	8 levels of Gray												
Matte Character Border	8 levels of Gray												
Screen Update Delay .5s	ON or OFF												
Auto Scrolling from last line													
Line Processing	Compress, Truncate, Left Justify												
DVR Support	MVDR2000, 3000, 4000, 5000 DMS-3001, DVR-3011, DVR-3021												
Watchdog Timer Hardware and Software													
Local / Remote Programming via PC Software													
Local Firmware Downloading													
History Buffer Downloadable / Searchable													
Temperature Rating	0 - 50 degrees Celsius 32 - 122 degrees Fahrenheit												
Humidity	Non-Condensing 85% RH												
Weight	0.68 Kg or 1.5 lbs												
Metal Enclosure Beige	130L x 127W x 38H (mm) 5.12L x 5W x 1.5H (in)												
Maximum Size with Connectors	145L x 127W x 43H (mm) 5.7L x 5W x 1.7H (in)												
Packed in White Box with Manual	1.02 Kg or 2.26 lbs 340L x 190W x 85H (mm) 13.4L x 86.2W x 3.35H (in)												



# CONNECTIONS

## 3. CONNECTIONS

The VSI-Pro will overlay the characters on any input video source. The video input can be virtually any baseband or composite video source. The VSI-Pro will accept NTSC, RS-170, RS-330, CCIR, PAL or SECAM video formats.

The Video input to the VSI-Pro is a standard BNC connector, terminated at 75 [ohms].

**NOTE**   
*The input video level must be 1[V] Peak to Peak. If this level is not maintained within +/- 20%, the VSI-Pro will have difficulty locking the character display over the input video source.*

After completing the interface installation as described in the separate Installation Guide for your specific cash register, computer, radar gun or other serial device, connect the video input source to the video input BNC on the rear of the VSI-Pro. The BNC video output goes out to the video system (VCR, DVR, quad, switcher, multiplexer, or monitor). This connection is shown in Figure 3. The video output from the VSI-Pro is 1[V] Peak to Peak into a 75 [ohm] load. Most monitors or televisions with direct video inputs are terminated with a 75 ohm load. If the monitor is not terminated, the VSI-Pro will still output 1[V] Peak to Peak. The VSI-Pro will be able to drive two terminated loads without loss of video level.

**NOTE**   
*The VSI-Pro will not enter the programming mode unless it is connected to a video source.*

Included with the VSI-Pro is a 9 VDC @300 [mA] UL/CSA power supply which must be plugged into the Power input on the VSI-Pro's Rear Panel.



Figure 2: VSI-Pro Rear Panel



Serial Input Power Video Input Video Output

Figure 3: VSI-Pro Cable Connections

PIN #	FUNCTION	DIRECTION
1	Alarm Out 1	Open Collector Transistor
2	Receive Data	To VSI-Pro
3	Transmit Data	From VSI-Pro
4	DTR	From VSI-Pro (Remain High)
5	Ground	
6	DSR	From VSI-Pro (Stay High)
7	RTS ( Alarm In )	To VSI-Pro
8	CTS	From VSI-Pro
9	Alarm Out 2	Open Collector Transistor

Table 1: Pin-Out of the DB-9 Female Connector on the VSI-Pro RS-232

### 3.1 RS-232 SERIAL INPUT

The VSI-Pro accepts serial data via the DB-9 female connector located on the rear of VSI-Pro. This connector is similar to “AT” type computer RS232 serial ports and the pin out is identical. Table 1 shows the standard pin out for VSI-Pro RS-232 female connector. On the other hand Table 2 compares the VSI-Pro RS-232 with standard “AT” computer’s RS-232 connector.

PIN #	SIGNAL NAME ( RS232 )	VSI-Pro
1	CD (Carrier Detect )	Alarm Out 1
2	RxD ( Recieve Data )	RxD
3	TxD ( Transmit Data )	TxD
4	DTR ( Data Terminal Ready )	Always True
5	SG ( Signal Control )	GND
6	DSR ( Data Set Ready )	
	Always True	
7	RTS ( Request to Send )	CTS ( Option )
8	CTS ( Clear to Send )	RTS ( Option )

Table 2: RS-232 DB-9 Pin-Out vs VSI-Pro DB-9 Pin-Out



## CONNECTIONS

PIN #	FUNCTION	DIRECTION
1	Alarm Out 1	Open Collector Transistor
2	No Function	No Function
3	TXD RS-232	From VSI-Pro
4	RS-485 A Data	To VSI-Pro
5	Ground	
6	RS-485 B Data	To VSI-Pro
7	RTS ( Alarm In )	To VSI-Pro
8	CTS	From VSI-Pro
9	Alarm Out 2	Open Collector Transistor

Table 3 : Pin-Out of the DB-9 Female Connector on the VSI-Pro RS-422 / RS-485

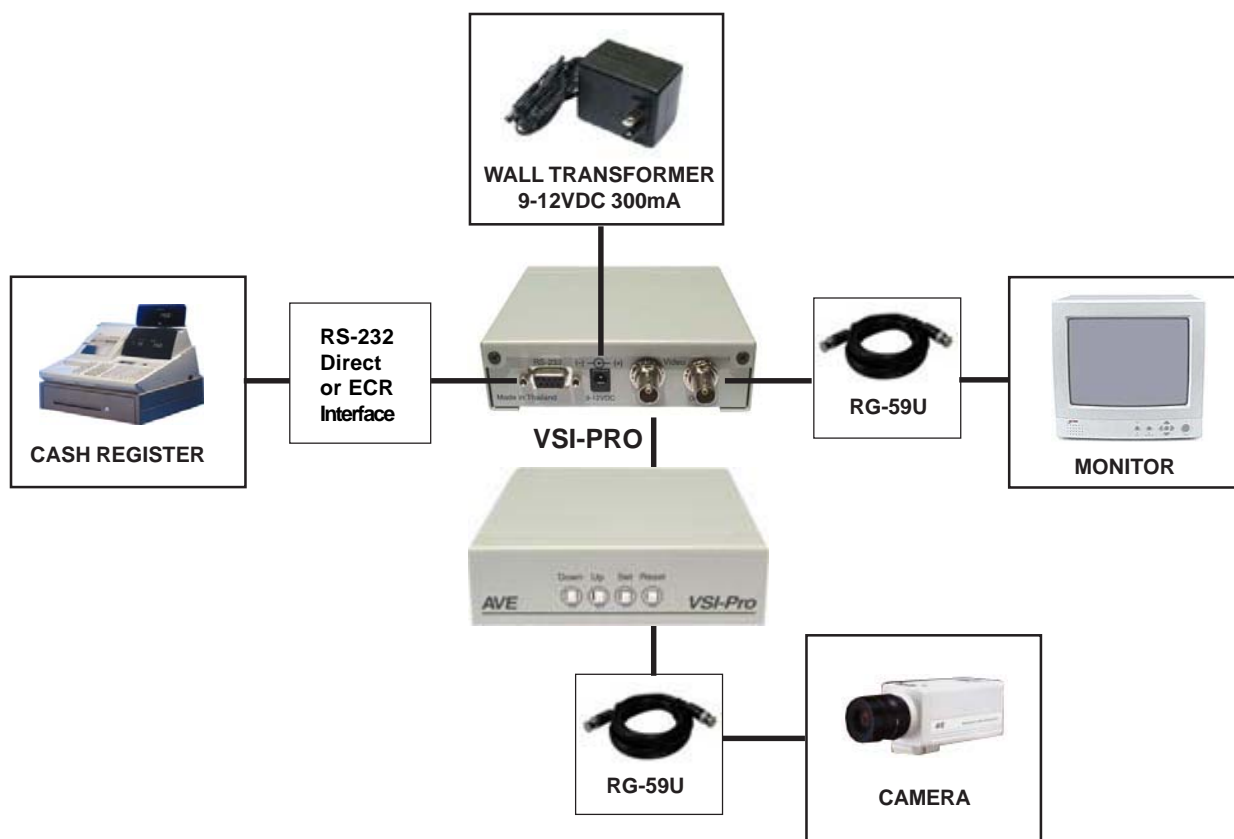

Figure 4: VSI-Pro Connections

## 4. USER FRONT PANEL CONTROLS

The VSI-Pro is programmed by pressing and releasing specific combinations of the four front panel push-buttons. Via these four simple buttons, all of the powerful programming features of the Text Inserter are available. A video source and a monitor must be connected in order to see the programming menus.

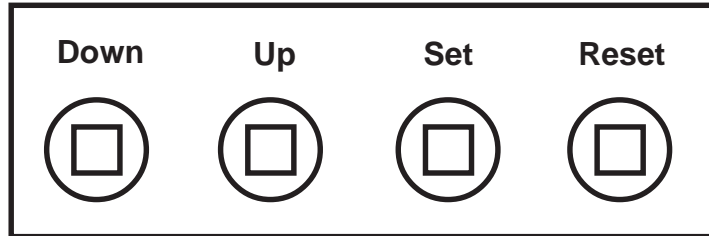

Figure 5 : Four Front Panel Push Buttons of VSI-Pro

### 4.1 FRONT PANEL CONTROLS

The front panel controls are provided to allow simple changing of the display's vertical and horizontal position and the gray scale or border. This eliminates the need of the user to enter the main menu and inadvertently change important programming setups.

#### *Changing the Gray Scale*

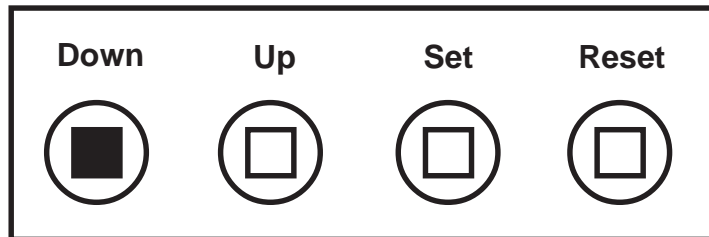

Figure 6: Four Front Panel Push Buttons of VSI-Pro (Down)

- 1) Press and hold the "Down" button.
- 2) Press and release the "Reset" button.
- 3) Release the "Down" button.
- 4) Press "Down" or "Up" to select the Gray Scale.
- 5) When choice is made, press and release the "Set" button.

## USER FRONT PANEL CONTROLS

---

### *Changing the Horizontal Position*

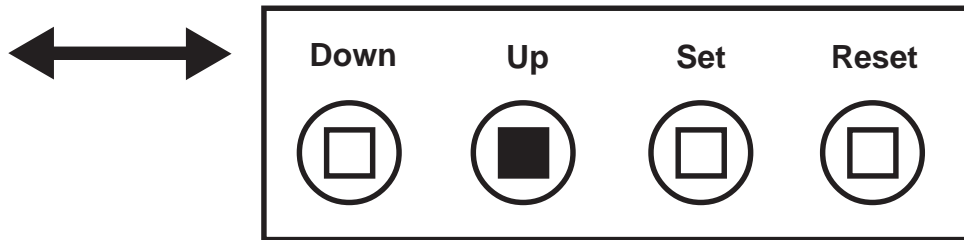

**Figure 7: Four Front Panel Push Buttons of VSI-Pro (Up)**

1. Press and hold the "Up" button.
2. Press and release the "Reset" button.
3. Release the "Up" button.
4. Press "Down" or "Up" to move the text block.
5. When the choice is made, press and release the "Set" button.

### *Changing the Vertical Position*

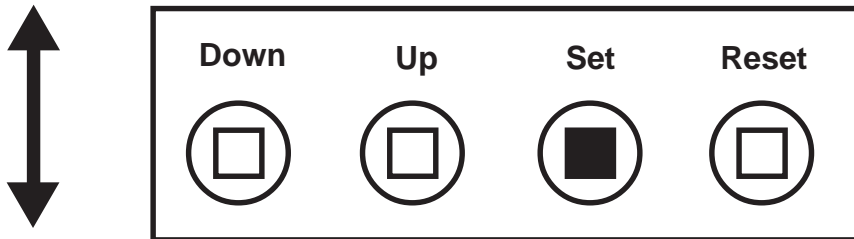

**Figure 8: Four Front Panel Push Buttons of VSI-Pro (Set)**

- 1) Press and hold the "Set" button.
- 2) Press and release the "Reset" button.
- 3) Release the "Set" button.
- 4) Press "Down" or "Up" to move the text block.
- 5) When the choice is made, press and release the "Set" button.

## 5.1 GETTING STARTED

To access the main-menu of the VSI-Pro, simultaneously hold down the “Down” & “Up” buttons and press and release the “Reset” button and then release the “Down” & “Up” buttons. This will take you to the main programming menu. To navigate through this menu, simply use the “Down” and “Up” buttons to position the cursor in front of the desired function, then press “Set” to access that function.

If you have difficulty entering the main-menu, try the following procedure exactly. With your left thumb, lightly press and hold in the two buttons to the left (Up & Down). While holding down these buttons, press and release the “Reset” button with your right thumb. Then release the other buttons.

### NOTE

*If a sub-menu has an “EXIT” selection, always go there and press “Set”. Pressing “Reset” at the main-menu exits you from the programming mode.*

## 5.2 MAIN PROGRAMMING MENU

Following is a detailed description of the menu selections and the programming capabilities of the VSI-Pro.

- REGISTER SELECT
- SCREEN SETUP
- TEXT DISPLAY
- COMMUNICATION
- EXCEPTION REPORT
- ALARM OUTPUTS
- TEST/DEMO MODE
- DOWNLOAD/UPLOAD SETUP
- HELP

Figure 9 : VSI-Pro Main-Menu

## 5.3 REGISTER SELECT

To select a specific register, press the “Up” or “Down” button to move the cursor to “REGISTER SELECT” and press “Set”. The REGISTER SELECT menu will bring up a sub-menu consisting of registers shown in Figure 10-A. You can go to the next or previous page by placing the cursor in front of “NEXT” or “PREVIOUS” and then pressing “Set”. To select the desired register, press the “Up” or “Down” button to move the cursor to that register and press “Set”. After selecting the register, exit out of the REGISTER SELECT menu by pressing the “Up” or “Down” button to move the cursor to “EXIT” and then pressing “Set”. In the main-menu, press “Reset” to activate the programming for that specific register. REGISTER SELECT automatically formats the VSI-Pro to match your register’s communication settings. However, if you need to change these settings, you can do so through the COMMUNICATION menu described later in this manual.

### NOTE

*Whenever you select a register in this menu, certain programming features are reset to the default settings. Always set the register selection first, get the data on-screen, then proceed with additional programming.*

# PROGRAMMING

## SECTION A : VSI-Pro Version 13.00

Press the “Up” or “Down” button to move the cursor to “REGISTER SELECT” and press “Set”. The REGISTER SELECT menu will appear:

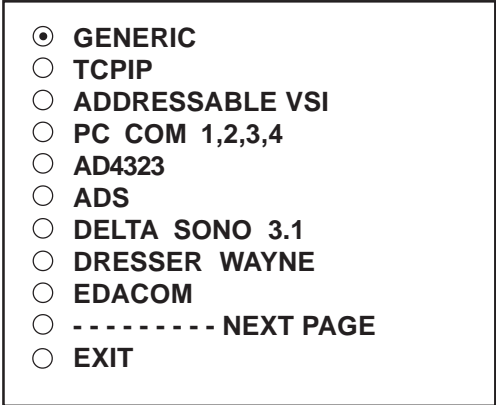

Figure 10-A: REGISTER SELECT Sub-Menu

1. Press the “Up” or “Down” button to move the cursor to “TCPIP” and press “Set” to enter and change the IP address to the same as the IP address you wish to monitor.

**EXAMPLE:** If the IP address is 192.168.0.141, set the address on the TCPIP 232 Adapter using this menu.

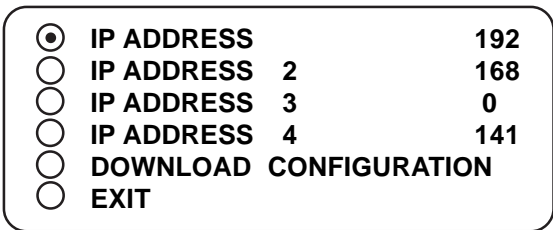

Figure 10-B: TCPIP Sub-Menu

2. Press the “Up” or “Down” button to move the cursor to “Download Configuration” and press “Set” to execute. Make sure a TCPIP232 Adapter is connected and the VSI-Pro will download the IP settings to this device.

3. Press the “Up” or “Down” button to move the cursor to “EXIT” and press “Set” to return to the previous menu.

Refer to Appendix I for additional information on the TCPIP232 Adapter or the manual included with the adapter.

**NOTE:** The TCPIP232 Adapter can be programmed by this method or by using a standard PC with a serial cable along with the AVE IP setting software. Refer to the TCIP232 Adpater Manual for doing this.

Once you have set the IP address of the TCPIP232 Adapter you will be in the “Generic” display mode. You may select another register driver to format this display. When you do this the VSI-Pro loads the default register baudrate as if a direct connection to the register so make sure you set the proper baudrate as described below.

The TCPIP232 Adpater communicates with the VSI-Pro via RS-232 at a baudrate of 19.2K. Therefore when you select this menu option the baudrate of the VSI-Pro is changed to this rate so communication for downloading the configuration can occur. When using the TCPIP232 adpater with other register drivers or data dump mode make sure you change the RXD baudrate to 19.2K so the VSI-Pro will communicate.

### TCP/IP Limitations

The TCPIP232 Adapter can monitor any Ethernet LAN either 10MB/s or 100MB/s. However the actual long term throughput of the adpater is limited to 5MB/s. This is more than enough for network printers for cash receipts, bar code scanners or single cash registers that operate in a “Live Mode”. Live Mode means the register transmits the data on the network line by line or at the end of each transaction. Some cash registers have large local built in memories for thousands of items and then only batch multiple transactions on the network at any given time or controlled by the server. Cash Registers utilizing this kind of batch processing are not suitable for security monitoring. Other devices that output large amounts of data will overrun the buffers of either the TCPIP232 Adapter or VSI-Pro and data will be lost and would not be suitable for security monitoring anyway.

The VSI-Pro has a set of powerful data dump modes that compatible with the TCPIP232 Adpater. If large data packets need filtering or special formats are required contact the factory.



## PROGRAMMING

Press the "Up" or "Down" button to move the cursor to "ADDRESSABLE VSI" and press "Set". The ADDRESSABLE VSI menu will appear:

<input checked="" type="radio"/> SET ADDRESS	ANY
<input type="radio"/> EXIT	

Figure 11-A: ADDRESSABLE VSI Sub-Menu

### SET ADDRESS

Choices: ANY, 1, 2, 3,..., 253, 254, 255

Press the "Up" or "Down" button to move the cursor to "PC COM 1,2,3,4" and press "Set". No menu will appear and merely sets the VSI-Pro to "Generic" mode.

Press the "Up" or "Down" button to move the cursor to "AD4323" and press "Set". No menu will appear and merely sets the VSI-Pro to support the special protocol of this model.

Press the "Up" or "Down" button to move the cursor to "ADS" and press "Set". The ADS menu will appear.

<input checked="" type="radio"/> DISPLAY	RECEIPT
<input type="radio"/> EXIT	

Figure 12-A: ADS Sub-Menu

### DISPLAY

Choices: JOURNAL, RECEIPT

Press the "Up" or "Down" button to move the cursor to "DELTA SONO 3.1" and press "Set". The DELTA SONO 3.1 menu will appear:

<input checked="" type="radio"/> DELTA JOURNAL
<input type="radio"/> DELTA RECEIPT
<input type="radio"/> EPSON JOURNAL
<input type="radio"/> EPSON RECEIPT
<input type="radio"/> EXIT

Figure 13-A: DELTA SONO 3.1 Sub-Menu

Press the "Up" or "Down" button to move the cursor to "DRESSER WAYNE" and press "Set". The DRESSER WAYNE menu will appear:

<input checked="" type="radio"/> POS / CDU
<input type="radio"/> NUCLEUS

Figure 14-A: DRESSER WAYNE Sub-Menu

Press the "Up" or "Down" button to move the cursor to "POS / CDU" and press "Set". The POS / CDU menu will appear:

<input checked="" type="radio"/> JOURNAL	PRINTER
<input type="radio"/> RECEIPT	PRINTER

Figure 15-A: POS / CDU Sub-Menu

Press the "Up" or "Down" button to move the cursor to "NUCLEUS" and press "Set". The NUCLEUS menu will appear:

<input checked="" type="radio"/> Terminal 1
<input type="radio"/> Terminal 2
<input type="radio"/> Terminal 3
<input type="radio"/> Terminal 4
<input type="radio"/> Terminal 5
<input type="radio"/> Terminal 6
<input type="radio"/> Terminal 7
<input type="radio"/> Terminal 8

Figure 16-A: NUCLEUS Sub-Menu

Press the "Up" or "Down" button to move the cursor to "EDACOM" and press "Set". The EDACOM menu will appear:



**Figure 17-A: EDACOM Sub-Menu**

Press the "Up" or "Down" button to move the cursor to "MODEL E90" and press "Set". The MODEL E90 menu will appear:



**Figure 18-A: MODEL E90 Sub-Menu**

Press the "Up" or "Down" button to move the cursor to "FUJISU 9920" and press "Set". The FUJISU 9920 menu will appear:

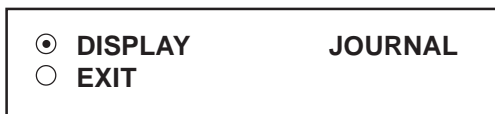

**Figure 19-A: IBM RDS Sub-Menu**

Press the "Up" or "Down" button to move the cursor to "GASBOY" and press "Set". The GASBOY20-A menu will appear:



**Figure 20-A: GASBOY Sub-Menu**

**DEVICE**

Choices: PRINTER, CONSOLE, CSL OLD

**DEVICE ADDRESS**

Choices: ANY, 01, 02, 03,..., 17

Press the "Up" or "Down" button to move the cursor to "GILBARCO" and press "Set". The GILBARCO menu will appear:

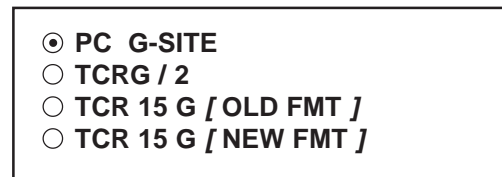

**Figure 21-A: GILBARCO Sub-Menu**

Press the "Up" or "Down" button to move the cursor to "IBM 3151 TERMINAL" and press "Set". The IBM 3151 TERMINAL menu will appear:

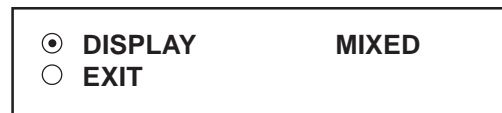

**Figure 22-A: IBM 3151 TERMINAL Sub-Menu**

**IBM 3151 TERMINAL**

Choices: JOURNAL, RECEIPT, MIXED

Press the "Up" or "Down" button to move the cursor to "IBM RDS" and press "Set". The IBM RDS menu will appear:



**Figure 23-A: IBM RDS Sub-Menu**

Press the "Up" or "Down" button to move the cursor to "MICRELEC" and press "Set". The MICRELEC menu will appear:

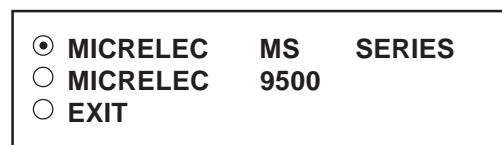

**Figure 24-A: MICRELEC Sub-Menu**

# PROGRAMMING

Press the "Up" or "Down" button to move the cursor to "MICRELEC MS SERIES" and press "Set". The MICRELEC MS SERIES menu will appear:

- OPERATOR
- CUSTOMER
- COMBINED
- EXIT

Figure 25-A: MICRELEC MS SERIES Sub-Menu

Press the "Up" or "Down" button to move the cursor to "MICRELEC 9500" and press "Set". The MICRELEC9500 menu will appear:

- JOURNAL
- RECEIPT
- CHECK
- CREDIT
- EXIT

Figure 26-A: MICRELEC 9500 Sub-Menu

Press the "Up" or "Down" button to move the cursor to "MICROS" and press "Set". The MICROS menu will appear:

- LOCAL VSS
- MICROS IDN NETWORK
- MICROS ISN NETWORK
- EXIT

Figure 27-A: MICROS Sub-Menu

Press the "Up" or "Down" button to move the cursor to "MICROS IDN NETWORK" and press "Set". The MICROS IDN NETWORK menu will appear:

- DEVICE : PRINTER
- DEVICE ADDRESS: ANY
- MODE: TAP
- EXIT

Figure 28-A: MICROS IDN NETWORK Sub-Menu

## DEVICE

Choices: PRINTER, VIDEO

## DEVICE ADDRESS

Choices: ANY, 01, 02, 03,..., 13, 14, 15

## MODE

Choices: EMULATE, TAP

Press the "Up" or "Down" button to move the cursor to "MICROS ISN NETWORK" and press "Set". The MICROS ISN NETWORK menu will appear:

- SOURCE TYPE : ANY
- SRC ISN GNA : ANY
- SRC ISN LNA : ANY
- SRC IDN ID : ANY
- DESTIN TYPE : ANY
- DST ISN GNA : ANY
- DST ISN LNA : ANY
- DST IDN ID : ANY
- EXIT

Figure 29-A: MICROS IDN NETWORK Sub-Menu

## SOURCE TYPE

Choices: ANY, 00, 01, 02, 03,..., 09

## SRC ISN GNA

Choices: ANY, 00, 01, 02, 03,..., 32

## SRC ISN LNA

Choices: ANY, 00, 01, 02, 03,..., 32

## SRC IDN ID

Choices: ANY, 00, 01, 02, 03,..., 15

## DESTIN TYPE

Choices: ANY, 00, 01, 02, 03,..., 09

## DST ISN GNA

Choices: ANY, 00, 01, 02, 03,..., 32

## DST ISN LNA

Choices: ANY, 00, 01, 02, 03,..., 32

## DST IDN ID

Choices: ANY, 00, 01, 02, 03,..., 15



Press the "Up" or "Down" button to move the cursor to "NCR" and press "Set". The NCR menu will appear:

- NCR 2113,3110**
- NCR 745X [ POLE ]**
- NCR JRNL PRINTER**
- NCR RCPT PRINTER**
- NCR SLIP PRINTER**

**Figure 30-A: NCR Sub-Menu**

Press the "Up" or "Down" button to move the cursor to "NIXDORF BEETLE" and press "Set". The NIXDORF BEETLE menu will appear:

- REMOTE SLIP**
- OPERATOR DISPLAY**

**Figure 31-A: NIXDORF BEETLE Sub-Menu**

Press the "Up" or "Down" button to move the cursor to "NORAND 1200" and press "Set". The NORAND 1200 menu will appear:

- TITLE DISPLAY : ON**
- CONSOLE ID : ANY**
- WORKING MODE :**
- EXIT**

**Figure 32-A: NORAND 1200 Sub-Menu**

**TITLE DISPLAY**

*Choices: ON, OFF*

**CONSOLE ID :**

*Choices: ANY, 1, 2, 3, 4, 5, 6, 7, 8*

**WORKING MODE**

*Choices: ACK, TAP*

Press the "Up" or "Down" button to move the cursor to "PANASONIC" and press "Set". The PANASONIC menu will appear:

- MODEL :**
- WORKING MODE :**
- EXIT**

**Figure 33-A: PANASONIC Sub-Menu**

**MODEL**

*Choices : 6000, 7000, 8000*

**WORKING MODE**

*Choices : ACK, TAP*

Press the "Up" or "Down" button to move the cursor to "SHARP" and press "Set". The SHARP menu will appear.

- 2590**
- 3100,3110**
- 3220,3221,3250**
- 3310,3311,3550**
- A-460,A-470**
- A-550,A-570**
- A-610,A650**
- A-750**
- A-770**

**Figure 34-A: SHARP Sub-Menu**

Press the "Up" or "Down" button to move the cursor to "SICOM" and press "Set". The SICOM menu will appear:

- SECRET ADDRESS 8**
- EXIT**

**Figure 35-A: SICOM Sub-Menu**

**SECRET ADDRESS**

*Choices: ANY, 1, 2, 3,..., 255*

Press the "Up" or "Down" button to move the cursor to "SUNTRONIC" and press "Set". The SUNTRONIC menu will appear.

- 890,891,960**
- 2000**

**Figure 36-A: SUNTRONIC Sub-Menu**

# PROGRAMMING

Press the "Up" or "Down" button to move the cursor to "TCI" and press "Set". The TCI menu will appear:

<input checked="" type="radio"/> <b>DEVICE ADDRESS</b> <b>000</b>
<input type="radio"/> <b>EXIT</b>

Figure 37-A: TCI Sub-Menu

## DEVICE ADDRESS

Choices : 000, 001, 002, ..., 999

Press the "Up" or "Down" button to move the cursor to "UNIWELL UN 4025" and press "Set". The UNIWELL UN 4025 menu will appear:

<input checked="" type="radio"/> <b>DEVICE ADDRESS</b> <b>000</b>
<input type="radio"/> <b>ANY ADDRESS</b>
<input type="radio"/> <b>ON</b>
<input type="radio"/> <b>EXIT</b>

Figure 38-A: UNIWELL UN 4025 Sub-Menu

## DEVICE ADDRESS

Choices: 000, 001, 002, ..., 999

## ANY ADDRESS

Choices: ON, OFF

Press the "Up" or "Down" button to move the cursor to "VERIFONE" and press "Set". The VERIFONE menu will appear:

<input checked="" type="radio"/> <b>JOURNAL TAPPING</b>
<input type="radio"/> <b>RECEIPT TAPPING</b>
<input type="radio"/> <b>JOURNAL EMULATING</b>
<input type="radio"/> <b>RECEIPT EMULATING</b>

Figure 39-A: VERIFONE Sub-Menu

## SECTION B: VSI-Pro V13.24

Press the "Up" or "Down" button to move the cursor to "REGISTER SELECT" and press "Set". The REGISTER SELECT menu will appear:

<input checked="" type="radio"/> <b>GENERIC</b>
<input type="radio"/> <b>BEETLE / 50 PRINTERS</b>
<input type="radio"/> <b>CASIO TK-T500</b>
<input type="radio"/> <b>CLARITY EPOS</b>
<input type="radio"/> <b>CASIO QT2K</b>
<input type="radio"/> <b>DRESSER WAYNE</b>
<input type="radio"/> <b>EDACOM</b>
<input type="radio"/> <b>HTEC</b>
<input type="radio"/> <b>HUTH T400 / T500</b>
<input type="radio"/> <b>---- NEXT PAGE</b>
<input type="radio"/> <b>EXIT</b>

Figure 40-B: REGISTER SELECT Sub-Menu

Press the "Up" or "Down" button to move the cursor to "BEETLE / 50 PRINTER" and press "Set". The BEETLE / 50 PRINTER menu will appear:

<input checked="" type="radio"/> <b>REMOTE</b>	<b>SLIP</b>
<input type="radio"/> <b>OPERATOR</b>	<b>DISPLAY</b>

Figure 41-B: BEETLE / 50 PRINTERS Sub-Menu

Press the "Up" or "Down" button to move the cursor to "CASIO TK-T500" and press "Set". The CASIO TK-T500 menu will appear:

<input checked="" type="radio"/> <b>MODEL :</b>	<b>TK-T500</b>
<input type="radio"/> <b>MODE :</b>	<b>EMULATING</b>
<input type="radio"/> <b>EXIT</b>	

Figure 42-B: CASIO TK-T500 Sub-Menu

## MODE

Choices: TAPPING, EMULATING

Press the "Up" or "Down" button to move the cursor to "CLALITY EPOS" and press "Set". The CLALITY EPOS menu will appear:

<input checked="" type="radio"/> <b>SET TERM NO</b>	<b>ALL</b>
<input type="radio"/> <b>EXIT</b>	

Figure 43-B: CLARITY EPOS Sub-Menu

**SET TERM NO.**

Choices: ALL, 1, 2, 3, ..., 253, 254, 255

Press the "Up" or "Down" button to move the cursor to "DRESSER WAYNE" and press "Set". The DRESSER WAYNE menu will appear:

<input checked="" type="radio"/> POS / CDU <input type="radio"/> NUCLEUS
---

**Figure 44-B: DRESSER WAYNE Sub-Menu**

Press the "Up" or "Down" button to move the cursor to "POS / CDU" and press "Set". The POS / CDU menu will appear:

<input checked="" type="radio"/> JOURNAL <input type="radio"/> RECEIPT	<input type="radio"/> PRINTER <input type="radio"/> PRINTER
---	--

**Figure 45-B: POS / CDU Sub-Menu**

Press the "Up" or "Down" button to move the cursor to "NUCLEUS" and press "Set". The NUCLEUS menu will appear:

<input checked="" type="radio"/> Terminal 1 <input type="radio"/> Terminal 2 <input type="radio"/> Terminal 3 <input type="radio"/> Terminal 4 <input type="radio"/> Terminal 5 <input type="radio"/> Terminal 6 <input type="radio"/> Terminal 7 <input type="radio"/> Terminal 8
---

**Figure 46-B: NUCLEUS Sub-Menu**

Press the "Up" or "Down" button to move the cursor to "EDACOM" and press "Set". The EDACOM menu will appear:

<input checked="" type="radio"/> MODEL <input type="radio"/> EXIT	<b>E90</b>
--	------------

**Figure 47-B: EDACOM Sub-Menu**

Press the "Up" or "Down" button to move the cursor to "MODEL E90" and press "Set". The MODEL E90 menu will appear:

<input checked="" type="radio"/> MODEL <input type="radio"/> EXIT	<b>E9010</b>
--	--------------

**Figure 48-B: MODEL E90 Sub-Menu**

Press the "Up" or "Down" button to move the cursor to "NIXDORF BEETLE" and press "Set". The NIXDORF BEETLE menu will appear:

<input checked="" type="radio"/> JOURNAL PRINTER <input type="radio"/> RECEIPT PRINTER
---

**Figure 49-B: NIXDORF BEETLE Sub-Menu**

Press the "Up" or "Down" button to move the cursor to "OMEGA 2000" and press "Set". The OMEGA 2000 menu will appear:

<input checked="" type="radio"/> JOURNAL PRINTER <input type="radio"/> RECEIPT PRINTER
---

**Figure 50-B: OMEGA 2000 Sub-Menu**

Press the "Up" or "Down" button to move the cursor to "SCHLUMBERGER" and press "Set". The SCHLUMBERGER menu will appear:

<input checked="" type="radio"/> DISPLAY <input type="radio"/> EXIT	<input type="radio"/> RECEIPT
--	-------------------------------

**Figure 51-B: SCHLUMBERGER Sub-Menu**

**DISPLAY**

Choices: RECEIPT, CDU[ 2L ], C.D.U.

Press the "Up" or "Down" button to move the cursor to "SHARP 750 ER-01PU" and press "Set". The SHARP 750 ER-01PU menu will appear:

<input checked="" type="radio"/> DISPLAY <input type="radio"/> EXIT	<input type="radio"/> RECEIPT
--	-------------------------------

**Figure 52-B: SHARP 750 ER-01PU Sub-Menu**

**DISPLAY**

Choices: RECEIPT, JOURNAL

**NOTE** 

*As we continually add new registers, these menus are subject to change.*

## PROGRAMMING

---

### 5.4 SCREEN SETUP

Press the “Up” or “Down” button to move the cursor to “SCREEN SETUP” and press “Set”. The following menu will appear:

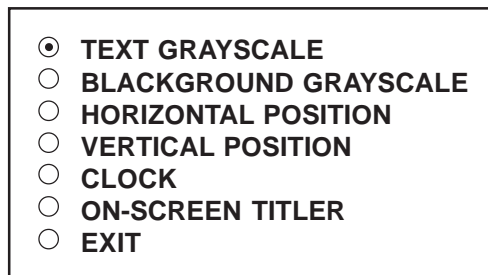

Figure 53: SCREEN SETUP Sub-Menu

#### TEXT GRAYSCALE

To change the display border and/or the grayscale of the text on screen, press the “Up” or “Down” button to move the cursor to “TEXT GRAYSCALE” and press “Set”. Cycle through the selections by pressing the “Up” or “Down” buttons. There are 10 settings to choose from. Make your selection and press “Set” to return to the previous menu.

#### BACKGROUND GRAYSCALE

To change the display border and/or the grayscale of the text on screen, press the “Up” or “Down” button to move the cursor to “BACKGROUND GRAY SCALE” and press “Set”. Cycle through the selections by pressing the “Up” or “Down” buttons. There are 10 settings to choose from. Make your selection and press “Set” to return to the previous menu.

#### HORIZONTAL POSITION

To change the horizontal position of the inserted text on-screen, press the “Up” or “Down” button to move the cursor to “HORIZONTAL POSITON” and press “Set”. Press the “Up” or “Down” buttons to move the text to the desired horizontal position.

#### VERTICAL POSITION

To change the vertical position of the inserted text on-screen, press the “Up” or “Down” button to move the cursor to “VERTICAL POSITION” and press “Set”. Press the “Up” or “Down” buttons to move the text to the desired vertical position.

#### **NOTE**

*Upon powering up for the first time or when the battery becomes depleted, the on-screen Time / Date display may be incorrect or have unreadable characters. If this is the case, enter the clock menu and “Reset Time / Date”. The Time / Date will then show readable characters and be unaffected by a Master Reset.*

#### CLOCK

To program the clock's functions, press the “Up” or “Down” button to move the cursor to “CLOCK” and press “Set”. The following menu will appear:

<input checked="" type="radio"/> <b>T/D DISPLAY</b>	<b>ON</b>
<input type="radio"/> <b>TIME FORMAT</b>	<b>12 HOUR</b>
<input type="radio"/> <b>DATE FORMAT</b>	<b>MM/DD/YY</b>
<input type="radio"/> <b>DAYLIGHT SAVING</b>	<b>DISABLED</b>
<input type="radio"/> <b>SET TIME / DATE</b>	
<input type="radio"/> <b>RESET TIME / DATE</b>	
<input type="radio"/> <b>T/D LOCKING</b>	<b>ON</b>
<input type="radio"/> <b>EXIT</b>	

Figure 54: CLOCK Sub-Menu

**T/D DISPLAY** turns the time/date display on or off. Press the “Up” or “Down” button to move the cursor to “T/D DISPLAY” and press “Set”. The cursor will start flashing. Press the “Up” or “Down” button to toggle between “ON” or “OFF” and press “Set” when the desired value is displayed.

**TIME DISPLAY** selects either 12-hour AM/PM or 24-hour Military Time format with AM/PM. Press the “Up” or “Down” button to move the cursor to “TIME DISPLAY” and press “Set”. The cursor will start flashing. Press the “Up” or “Down” button to toggle between time formats and press “Set” when the desired format is displayed.

**DATE FORMAT** chooses one of the three available formats. Press the “Up” or “Down” button to move the cursor to “DATE FORMAT” and press “Set”. The cursor will start flashing. Press the “Up” or “Down” button to toggle between date formats and press “Set” when the desired format is displayed.

**DAYLIGHT SAVING** selects, for example, USA, Canada, Australia or is disabled. Press the “Up” or “Down” button to move the cursor to “DAYLIGHT SAVING” and press “Set”. The cursor will start flashing. Press the “Up” or “Down” button to toggle between values and press “Set” when the desired value is displayed.

**SET TIME/DATE** sets the clock manually. Press the “Up” or “Down” button to move the cursor to “SET TIME/DATE” and press “Set”. The time/date will appear and the cursor will start flashing. Press the “Up” and “Down” button to change the value and press “Set” when the desired value is displayed. The value is selected and the cursor will advance to the next position. When the desired time/date is displayed, press the “Up” and “Down” buttons simultaneously to enter the time/date into memory and return to the previous menu.

**RESET TIME/DATE** resets the clock to the default value. Press the “Up” or “Down” button to move the cursor to “RESET TIME/DATE” and press “Set” to reset the time/date.

**T/D LOCKING** turns the time/date locking on or off. If the time/date locking is turned on, make sure that the time and date format selected is the same as the ATM time and date format. Press the “Up” or “Down” button to move the cursor to “T/D LOCKING” and press “Set”. The cursor will start flashing. Press the “Up” or “Down” button to toggle between “ON” or “OFF” and press “Set” when the desired value is displayed.

If the T/D LOCKING is turned on, make sure that the time format selected is the same as the register’s time/date format. If the T/D LOCKING is turned on, the VSI-Pro will monitor the incoming data string. If it finds a valid time and date in one or two consecutive lines, it will set the clock to whatever time/date it finds. A valid time has the following formats:

HH:MM, HH:MM:ss  
 HH:MM AM, HH:mm:ss AM  
 HH:MM PM, HH:MM:ss PM

where hh is a number between 0 and 12 ( 24 if either AM or PM not present )  
 A valid date has the same format as for date display and has either “/” or “-” as a separator.

## ON-SCREEN TITLER

Press the “Up” or “Down” button to move the cursor to “ON-SCREEN TITLER” and press “Set”. The following menu will appear:





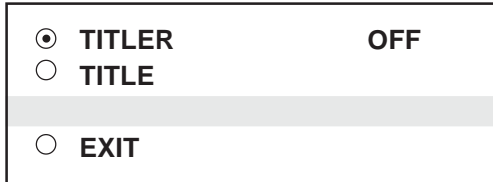

**Figure 55: ON-SCREEN TITLER Sub-Menu**

**TITLER**

To change the status of the on-screen titler, press the “Up” or “Down” button to move the cursor to “TITLER” and press “Set”. The cursor will start flashing. Select either “ON” or “OFF” by pressing the “Up” or “Down” button. After making a selection, press “Set”. This will return the cursor to the non-flashing mode. Now select “EXIT” to return to the previous menu.

**TITLE**

The VSI-Pro gives you the option of a 40-character display for easy register identification in addition to the actual register transaction data.

To create a title, press the “Up” or “Down” button to move the cursor to “TITLE” and press “Set”. You will see a row of 40 boxes and the first box will be flashing.

To change the character in the first position, press the “Up” or “Down” buttons to cycle through the alpha-numeric selections from the following list of available characters.

**ABCDEFGHIJKLMNOPQRSTUVWXYZ  
abcdefghijklmnopqrstuvwxyz =.+-\*/9876543210**

The solid white box is used for a blank space. Make your selection and press “Set”. This will advance to the next block, repeat until you have entered the desired title. When finished, simultaneously press and release the “Down” & “Up” buttons to enter your title into memory. The white boxes will disappear and your title will be displayed as it will appear on-screen. Press the “Up” or “Down” button to move the cursor to “EXIT” and press “Set” to return to the previous menu.

**NOTE** *Remember, enabling the TITLE will limit text insertions to 10 lines maximum.*

**EXIT**

Press the “Up” or “Down” button to move the cursor to “EXIT” and press “Set” to return to the previous menu.

**5.5 TEXT DISPLAY**

This menu will give you more control over the actual text block formatting and its appearance on the screen. To access the menu, press the “Up” or “Down” button to move the cursor to “TEXT DISPLAY” and press “Set”. The following sub-menu will appear:

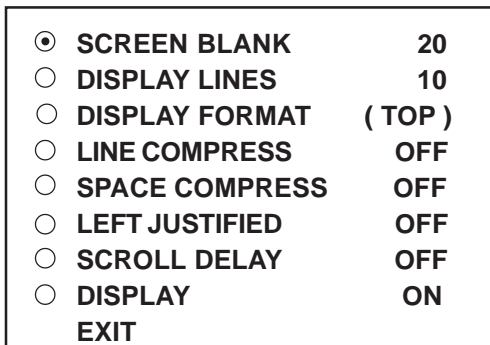

**Figure 56: Text Display Sub-Menu**

## SCREEN BLANK

Choices: NONE, 6, 12, 20, 30, 60, 120, 180, 300

This is the amount of time that the VSI-Pro text display will remain on-screen after a transaction before blanking itself off (not the video picture, just the register transaction data) until the next transaction.

To change the SCREEN BLANK setting, press the "Up" or "Down" button to move the cursor to "SCREEN BLANK" and press "SET". The cursor will begin flashing. Press the "Up" or "Down" buttons to cycle through the selections.

Press "Set" when the desired time is displayed. The cursor will stop flashing and you may continue programming.

### NOTE

**Choosing "NONE" means No Blanking. The VSI-Pro will display the last transaction until a new transaction is performed.**

## DISPLAY LINES

You have the choice of how many lines of text to display on-screen for register transactions. The choices are up to 11 lines.

To change the DISPLAY LINES setting, press the "Up" or "Down" button to move the cursor to "DISPLAY LINES" and press "Set". The cursor will begin flashing. Press the "Up" or "Down" buttons to cycle through the selections. Press "Set" when the desired number is displayed. The cursor will stop flashing and you may continue programming.

### NOTE

**All register transaction data will scroll up regardless of the number of lines you choose to display on-screen and the more lines you display on-screen, the greater the amount of time that the transaction data will be recorded. However, some applications may limit the number of lines and the size of the on-screen display.**

### NOTE

**If you are using an on-screen title, it will occupy Line 1, leaving 10 lines for the text insertion. If you enable the on-screen Time/Date then this takes one additional line also.**

## DISPLAY FORMAT

If "TOP" is selected which is the default, the data scrolls from the top most line down to the selected number of lines displayed. "T/D" and/or "TITLE" is displayed at the top of the screen. If "BOTTOM" is selected then the data scrolls up from the bottom most line to the top of the screen and "T/D" and/or "TITLE" is displayed at the bottom of the screen.

## PROGRAMMING

---

### LINE COMPRESS

**NOTE**  *Set your Exceptions first before enabling this feature.*

The VSI-Pro automatically compresses the spaces in a line first as it reaches 40 characters. With LINE COMPRESS "ON", the VSI-Pro will additionally remove multiple spaces and then vowels from the text to further compress the display as necessary.

To make this selection, position the arrow in front of "LINE COMPRESS" and press and release "Set". The arrow will start flashing. Cycle through "ON" or "OFF" by pressing either the "Up" or "Down" button, and press "Set" when your choice is displayed. The cursor will stop flashing and you can continue programming.

### SPACE COMPRESS

Space Compress allows you select the number of maximum spaces next to each other in a line. The selections are 1,2,3,4,5 and OFF. If you select "1" then if three spaces are shown on the receipt the VSI-Pro will delete 2 and only show 1 space between characters on the video and on the output data to the DVR.

### LEFT JUSTIFICATION

When LEFT JUSTIFIED is "ON", the VSI-Pro will start each line of text with no leading spaces from the left margin of the text display block.

### SCROLL DELAY

Scroll delay ensures that lines of text remain on-screen a minimum of 0.5 seconds. This is especially useful with registers that run at a high baud rate, time-lapse VCRs in extended record modes, switchers, or multiplexers. Sometimes, the register can produce characters so quickly that they can scroll up too fast on the screen to be recorded. When SCROLL DELAY is "ON", the VSI-Pro slows down this data feed just enough to insure that each line of text is recorded.

The choices for SCROLL DELAY are either "ON" or "OFF". To make this selection, position the arrow in front of "SCROLL DELAY" and press and release "Set". The arrow will start flashing. Cycle through "ON" or "OFF" by pressing either the "Up" or "Down" button, then press "Set" when your choice is displayed. The cursor will stop flashing and you can continue programming.

**NOTE**  *At high baud rates, the SCROLL DELAY on the internal buffer of the VSI-Pro may overflow. This will cause lost text. The internal buffer can hold up to 20K characters before overflowing so it is more than enough for almost all cash register applications.*

### DISPLAY

You have the choice to globally turn "ON" or "OFF" the complete VSI-Pro text insertion function. This means no data will be visible on the monitor if you select DISPLAY "OFF". However, if you select the DISPLAY "OFF", you can still command each exception independently to either display on-screen or not through its program setup menu under "EXCEPTION REPORTS". You may also choose to enable an alarm output to occur during an exception while not displaying the exception data through the program set-up in the ALARM OUTPUTS menu. With the display "OFF", the VSI-Pro will still perform all functions as programmed, for example, exception reporting will still function, but the information will not appear on-screen unless programmed to do so in the EXCEPTIONS REPORT menu. Also the data will not show in the history buffer if not displayed.

### EXIT

Press the "Up" or "Down" button to move the cursor to "EXIT" and press "Set" to return to the previous menu.



## 5.6 COMMUNICATION

This was discussed briefly in the section under “REGISTER SELECT” and will be fully explained here. When you choose your register type under the REGISTER SELECT menu, this automatically formats the VSI-Pro to the appropriate settings needed to communicate with your register. There may be times when you will need to amend these settings for a specific register.

To access the Communication menu, press the “Up” or “Down” button to move the cursor to “COMMUNICATION” and press “Set”. The following menu will appear:

<input checked="" type="radio"/> INTERFACE TYPE	RS-232
<input type="radio"/> RX BAUD RATE	AUTO
<input type="radio"/> TX BAUD RATE	AUTO
<input type="radio"/> PARITY	
<input type="radio"/> NONE	
<input type="radio"/> DATA BITS	8
<input type="radio"/> HANDSHAKE	ON
<input type="radio"/> AUTO LINEFEED	ON
EXIT	

Figure 57: COMMUNICATION Sub-Menu

### INTERFACE TYPE

Choices: RS-232, PASSIVE TAP, RS-485

To set the interface type for your particular device, press the “Up” or “Down” button to move the cursor to “INTERFACE TYPE” and press and release “Set”. The cursor will start flashing. You can now use the “Up” or “Down” button to make your selection. When your selection appears, press “Set” again. The cursor will stop flashing and you can proceed to the next menu item for programming. RS-232 and RS-485 are defined by IEEE standards, however, the Passive Tap is a high impedance (100K) input with full diode protection. Refer to Table 1 and 1A for respective pin-outs of RS-232 or RS-485.

### RX BAUD RATE

Choices: AUTO, 150, 300, 600, 1200, 2400, 4800, 9600, 14.4K, 19.2K, 28.8K, 38.4K

To set the baud rate for your particular device, press the “Up” or “Down” button to move the cursor to “RX Baud Rate” and press “Set”. The cursor will start flashing. You can now use the “Up” or “Down” button to make your selection. When your selection appears, press “Set” again. The cursor will stop flashing and you can proceed to the next menu item for programming.

### TX BAUD RATE

Choices: AUTO, 150, 300, 600, 1200, 2400, 4800, 9600, 14.4K, 19.2K, 28.8K, 38.4K

This is a new feature that allows you to set the transmit baud rate to a separate device if you are looping the data back out of the VSI-Pro.

To set the TX Baud Rate for your particular device, press the “Up” or “Down” button to move the cursor to “TX BAUD RATE” and press “Set”. The cursor will start flashing. You can now use the “Up” or “Down” buttons to make your selection. When your selection appears, press “Set”. The cursor will stop flashing and you can proceed to the next menu item for programming.

#### NOTE

When selecting 38.4K, the TX and RX Baud rate must both be 38.4K. However, with any lower baud rate the TX and RX can be any different baud rate.

## PROGRAMMING

---

### PARITY

*Choices: NONE, ODD, EVEN*

Press the "Up" or "Down" button to move the cursor to "PARITY" and press "Set". The cursor will start flashing. Press the "Up" or "Down" button to cycle through the values and press "Set" when the desired value is displayed.

### DATA BITS

*Choices: 7 or 8*

If you select 7 Data Bits, you must select "ODD" or "EVEN" Parity in the Parity menu. Press the "Up" or "Down" button to move the cursor to "DATA BITS" and press "Set". The cursor will start flashing. Press the "Up" or "Down" button to cycle through the values and press "Set" when the desired value is displayed.

### HANDSHAKE

*Choices: ON, OFF*

Handshaking is an electrical signal that tells the cash register or computer that the VSI-Pro is ready to receive data. It may not be necessary and/or need not be connected to an outgoing signal from the cash register or computer since the VSI-Pro does not require handshaking. The VSI-Pro handshaking signal is always true signally the cash register or computer to send data.

Handshaking guarantees that the internal buffer is not over run or text is not lost. Most AVE interfaces do not support this function. Also since the VSI-Pro has a 20K buffer this feature is generally not required.

Press the "Up" or "Down" button to move the cursor to "HANDSHAKE" and press "Set". The cursor will start flashing. Press the "Up" or "Down" button to cycle through the values and press "Set" when the desired value is displayed.

### AUTO LINEFEED

*Choices: ON, OFF*

Auto Linefeed makes the VSI-Pro append a CR/ LF after each displayed line. The default of this function is "ON", but if you would like to disable it then press the "Up" or "Down" button to move the cursor to "AUTO LINEFEED" and press "Set". The cursor will start flashing. Press the "Up" or "Down" button to cycle through the values and press "Set" when the desired value is displayed.

### EXIT

Press the "Up" or "Down" button to move the cursor to "EXIT" and press "Set" to return to the previous menu.

## 5.7 EXCEPTION REPORTS

### EXCEPTION REPORT OVERVIEW

The Exception Report gives you the option to assign an on-screen flag, trigger an alarming device, or send data to another serial device on any questionable transaction that you have preprogrammed into the VSI-Pro. The VSI-Pro will allow programming of up to 24 separate exceptions. These exceptions can be VOIDS, REFUNDS, COUPONS, PAID OUT, RETURNS, individual departments, specific items, or any transaction that you determine (by programming) to be "exceptional" or questionable.

You may even set ranges for the exceptions. For example, all transactions over \$100, between \$8.00 and \$25.00, or lower than \$10 and greater than \$25.00, all transactions by a specific cashier, or whatever transactions you need to watch exceptionally close.



The following is a brief overview of how to set up Exception Reports.

1. On the main-menu, press the "Up" or "Down" button to move the cursor to "EXCEPTION REPORT" and press "Set".
2. On the sub-menu, press the "Up" or "Down" button to move the cursor to "EXCEPTION HISTORY" and press "Set".
3. On the sub-menu, press the "Up" or "Down" button to move the cursor to "DVR SELECTION" and press "Set". Then select the model of DVR you are using.
4. Exit and press the "Up" or "Down" button to move the cursor to "SET EXCEPTION" and press "Set".
5. To select the Exception No. that you wish to program, press the "Up" or "Down" button to move the cursor to the desired Exception No. then press "Set". Press the "Up" or "Down" button to toggle between the choices.
6. Make sure that DISPLAY is set to "ON" for any exception data to be saved in the Exception History.
7. Program the Exception String in the Exception Report to compare the data that shows on the screen for time search mode in the Exception History menu.
8. After you have set up the desired configurations, press the REC button on the DVR to record video into a hard drive or use alarm output for triggering the DVR at record input.
9. The monitor should display a flashing REC message and the REC button will light up indicating the DVR is in the recording mode.

### ON-SCREEN FLAGS

You have several options for programming your Exception Report. The first option typically has all programmed exceptions display a flashing asterisk in the upper right corner of the on-screen display, or reversing the entire text display. This on-screen flag is controlled through the ALARM OUTPUTS menu. You assign a corresponding alarm to an exception and set the parameters for the flag in this menu. You do this by choosing "DISPLAY" for the corresponding exception number and selecting "ON". With this option, all questionable transactions (exceptions) will be "flagged" with the flashing asterisk.

You can then review these exceptions by putting your DVR or VCR in play and pressing the FF button. This will give you a fast scan of the tape and you can go into normal play when you see the flashing asterisk and view that transaction in real time or slow play or frame by frame, depending on the type of playback options of your particular DVR or VCR.

### HARD ALARM OUTPUT

The VSI-Pro allows you to program exceptions to trigger external alarming devices such as time-lapse VCR's, quads, enunciators, LED's etc. Using the ALARM OUTPUT you can have your time-lapse VCR record only exceptions, or have an alarming quad go to full screen on an exception, or even trigger a buzzer to alert you that an exception has occurred.

### PRINTER or DVR OUTPUT

There may be situations where you do not want cashiers or other employees to know what triggers an exception. In this case, the VSI-Pro provides a separate output that will send data to a remotely located serial printer. If you turn the on-screen display off and the output on and you have a remote serial printer hooked up to the VSI-Pro, then, whenever an exception is reported, it is sent out to the serial printer only. The printer will give you a hard copy printout of the questionable transaction with the time and date. With this hard copy printout of the exception report, you can then review the tape by going directly to that exception's time.

The serial printer output of the VSI-Pro can be programmed to send out the entire transaction. The output can be connected to the other equipment such as DVRs, computers, phone line transmissions or digital storage devices for later retrieval.

The VSI-Pro also has a "triggered text" feature. This feature allows programmed text or control characters to be sent out when an exception occurs to trigger devices like DVR's to save the data file for future review. Other computer devices can wait for this specified text string and do other functions at this time via the serial communication process.

From the main programming VSI-Pro menu, press the "Up" or "Down" button to move the cursor to "EXCEPTION REPORT" and press and release "Set". The following menu will appear:



# PROGRAMMING

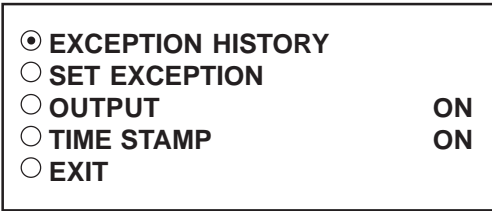

Figure 58: EXCEPTION REPORT Sub-Menu

## EXCEPTION HISTORY

Press the “Up” or “Down” button to move the cursor to “ EXCEPTION HISTORY ” and press “Set”. The following menu will appear:

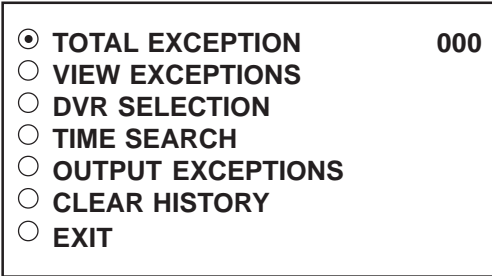

Figure 59: EXEPTION HISTORY Sub-Menu

## TOTAL EXCEPTIONS

This is not a selection for just displays the total exception count kept in the Exception History Buffer.

## VIEW EXCEPTIONS

This displays the buffered exceptions on-screen, starting with the oldest exception in the buffer. Press the “Up” or “Down” button to move the cursor to “VIEW EXCEPTIONS” and press “Set”. Once in the exception displaying screen, press the “Up” or “Down” button to scroll to the next screen. Press “Set” to exit and return to the previous menu. Remember, you must turn the DISPLAY “ON” for exceptions to be saved in history.

### For example:

Define “NOSELL” as an exception string In Exception NO. 2 , DISPLAY to be “ON”, and define OPERATOR “IN”.

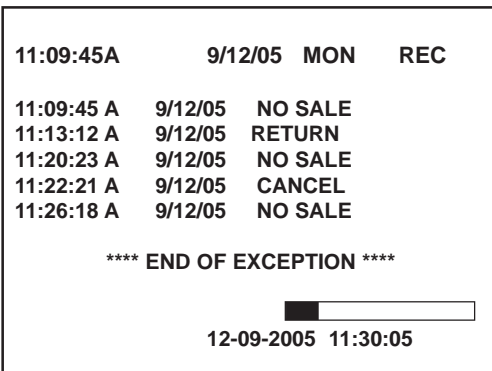

Figure 60: Display of View Exceptions

 **NOTE**  
*For any exception you must program Display “ON” for any exception data to be saved in the Exception History.*

**DVR SELECTION**

Press the “Up” or “Down” button to move the cursor to “DVR SELECTION” and press “Set”. The following menu will appear:

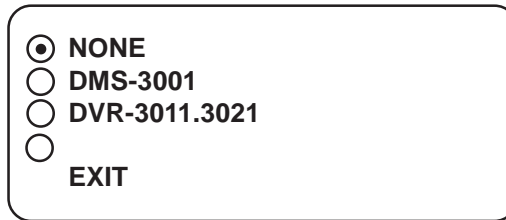

Figure 61: DVR Selection Sub-Menu

**DVR-3011 / DVR-3021**

Press the “Up” or “Down” button to move the cursor to “DVR-3011.3021” and press “Set”. An asterisk appears to indicate your selection.



Figure 62: DVR-3011.3021 Sub-Menu

**DEST ID and SRC ID**

Choices: 1 through 32

**TIME SEARCH**

**TIME SEARCH SETTING**

**USING TIME SEARCH FUNCTION**

Press the “Up” or “Down” button to move the cursor to “TIME SEARCH” and press “Set”. The following sub-menu will appear:

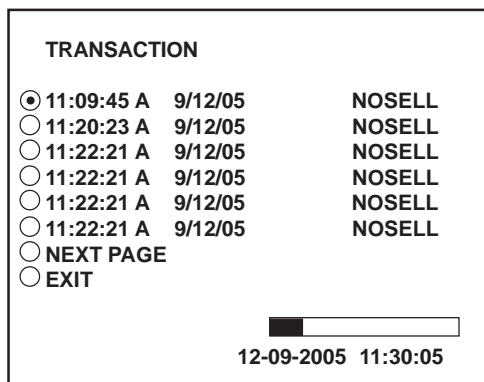

Figure 63: Display of TIME SEARCH



## PROGRAMMING

### EXAMPLE

Define "NOSELL" as an exception string In Exception No. 2 , DISPLAY to be "ON", and define OPERATOR "IN".

If the screen is displayed "NOSELL", the VSI-Pro will keep this displayed line on Exception History.

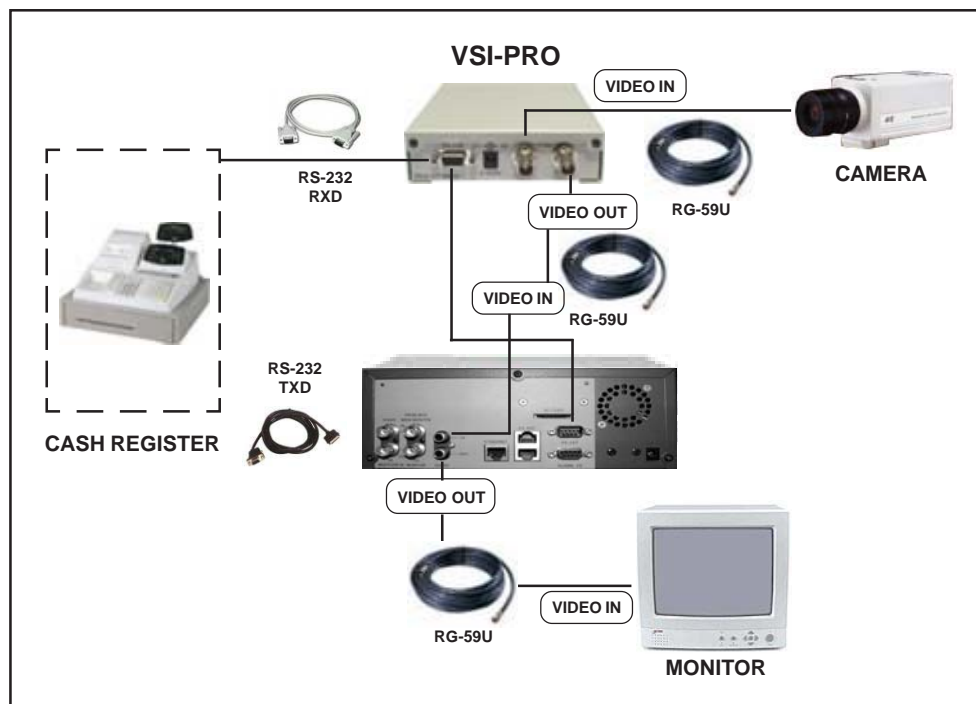

Figure 64: VSI-Pro with DVR Connections

### OUTPUT EXCEPTIONS

This selection allows you to have the buffered exceptions sent out for printing. This is a global setting for all exceptions, but you also need to turn on the output for each independent exception.

### CLEAR HISTORY

This selection clears all the buffered exceptions and resets the TOTAL EXCEPTIONS counter.

### EXIT

Press the "Up" or "Down" button to move the cursor to "EXIT" and press "Set" to return to the previous menu.

### SET EXCEPTION

Press the "Up" or "Down" button to move the cursor to "SET EXCEPTION" and press "Set". The following sub-menu will appear:

<input checked="" type="radio"/>	EXCEPTION NO.	1
<input type="radio"/>	DISPLAY	ON
<input type="radio"/>	OUTPUT	ON
<input type="radio"/>	HISTORY BUFFER	ON
<input type="radio"/>	SCROLL MATCHING	OFF
<input type="radio"/>	EXCEPTION STRING	
	NO SALE	
<input type="radio"/>	RANGE	
	0000.00 - 0000.00	
<input type="radio"/>	OPERATOR	NONE
<input type="radio"/>	EXIT	

Figure 65: SET EXCEPTION Sub-Menu

**EXCEPTION NO.**

Choices: 1 through 24

To select the Exception No. that you wish to program, press the "Up" or "Down" button to move the cursor to "EXCEPTION NO." and press "Set". The cursor will start flashing. Use the "Up" & "Down" button to sequence through the choices. Make your selection and press "Set". The cursor will stop flashing and you may continue to the next menu item.

**DISPLAY**

Choices: ON, OFF

The DISPLAY item lets you control whether or not this particular exception is displayed on the video monitor. Please understand that if you are not using a remote serial printer and if you do not turn on the Exceptions display here, you will not have the on-screen flag and consequently no record of the exception when it occurs.

To make your selection, press the "Up" or "Down" button to move the cursor to "DISPLAY" and press "Set". The cursor will start flashing. Press the "Up" or "Down" button to toggle between "ON" or "OFF". Make your selection and press "Set". The cursor will stop flashing and you may continue to the next menu item.

 **APPLICATION NOTE**

*If the display of the Exception is turned off here, the exception data will actually be erased from the screen. This feature can be used to generate what we refer to as "Negative Exceptions", allowing the removal of unwanted text from the screen. See "Negative Exceptions" that follows.*

**OUTPUT**

Choices: ON, OFF

The OUTPUT controls the RS-232 data from the VSI-Pro. Typically this is sent to a remote Serial Printer to provide a hard copy of Exceptions with time and date on it. This data can also be sent out to a computer with appropriate software and give you the ability to analyze data. You could also use an auto answer modem and have the data sent to a central office or even to your home. The serial devices must have the same Baud Rate, Parity, and Data Bits as the VSI-Pro for optimum performance of data transfer.

To make your selection, press the "Up" or "Down" button to move the cursor to "OUTPUT" and press "Set". Press the "Up" or "Down" button to toggle between "ON" or "OFF". Make your selection and press "Set". The cursor will stop flashing and you may continue to the next menu item.

## PROGRAMMING

---

### HISTORY BUFFER ON/OFF

The history buffer stores all the exceptions that occur in the VSI-Pro. Sometimes this can be very large and consume a large portion of the memory of the VSI-Pro. This can be used to automatically search a compatible DVR, upload to a PC to save or print out and view on screen on the VSI-Pro. This setting allows the user to enable or disable this feature as to conserve memory allocation for other features.

### SCROLL MATCHING EXCEPTION STRINGS ON/OFF

Scroll Matching is a feature to better remove those advertising scrolling messages on the customer display of cash registers so they do not clutter up the video recording. To better understand how to use this, first we must discuss how the Exception String is processed.

Exception Strings (with Scroll Matching OFF) are compared to any text in a line or any text after a CR LF up to 20 characters. If the line is longer than 20 characters we insert a virtual LF CR. Therefore exception string can not be longer than 20 characters. If you use a wild card in front of or behind of a normal exception string then no matter what letter is received in that position of the wild card it will be accepted as part of exception string.

Typically to erase these scrolling messages we would use the Negative Exception feature and turn "Off" the display after we entered in the words with or without wildcards. However this left many unwanted bits and pieces of the scrolling message visible because the transactions interrupt the scrolling message and then when the transaction is completed the scrolling message goes back to the exact place in the message where it was interrupted. This is different than normal transactions for they always start with a the description, quantity and price usually in one line.

In scrolling messages we may not have LF and sometimes no CR. This has the first character of every line different of the scrolling message possibly different and even partial words starting at any place within any one of the words of the scrolling message. Therefore conventional Exceptions even with the wild card does not remove all.

Scroll Matching "On" allows you to enter an exception string with or without wildcards and no matter when this string is detected the entire line is erased. This feature "On" does not process the exception string any differently than normal exceptions with Display "Off" but gives a higher priority than any normal exception set with Scroll Matching "Off" and Display "On".

This means that if you set an Exception for "Shipping" with or without a dollar figure associated and a normal transaction that you wanted to generate an exception and set Display "On". Everytime you hit the "Shipping" key your would get an exception. However if you had a scrolling message "You can rely on us for all your Shipping needs" Then you might want to erase this entire line and by doing so the word shipping would be included in the exception with scroll matching "On". In this case you would never see the normal transactions with Shipping \$4.50 either as an exception or displayed for the Scroll Matching would override.

A rule of thumb is to never use a scroll matching word the same word as any word in an item description or any partial word that is a partial of any item description.

## PROGRAMMING

---



### PROGRAMMING NOTE

*The following sections defines the Exceptions Strings, the Operator and the Range. The Exception String is programmed first, then Range is defined and finally the Operator is selected. The VSI-Pro looks at the Exceptions String first, and if there is data that matches, it then checks to see if a Range has been defined.*

### EXCEPTION STRING

The VSI-Pro compares the data that is printed to video to the data entered in the Exception String. The Exception String can also be used without a defined range. Example of this would be to assign a word "VOID" as an exception. VSI-Pro will look for that string so range definition is not necessary. However, exception string "VOID" could be further defined by assigning a Range, i.e. all "VOID" over \$20.

You can also define a global exception to flag all negative transactions. An example of this using the Samsung ER-4715 would be the following exception to flag any transaction that contains a "-", or negative sign. For example, in the Samaung ER-4715 register an assigned Exception string ".-." will flag all Void, Refund, Merchandise Return and Paid out to the monitor.

You can also use wild card symbol ".", a centered dot on any data location. An example of this would be instead of assigning eight different exception strings for dept 00 to dept 07, you can assign only one exception string e.g. "dept .". That wild card exception string will handle exceptions for all eight departments.

To program the exception string, press the "Up" or "Down" button to move the cursor to "EXCEPTION STRING" and press "Set". The first 40 character exception will become active after flashing. Program in your exception string.

### NOTE

*Remember to enter your Exception String based on the way that data prints to video, including spaces. Also remember pressing "Set" advances to the next position. Pressing "Down" and "Up" at the same time enters the string into memory and returns to the menu for further programming.*



### TIP

*If you make a mistake and need to erase a character, pressing "Up" and "Set" at the same time will change the character back to a blank space.*

### NEGATIVE EXCEPTION

You can remove unwanted text from the screen using the VSI-Pro. The VSI-Pro displays data in the text block 11 lines by 40 characters wide for total of 440 characters. To remove unwanted messages from the register data you first determine how the unwanted messages prints to the video. For example, a typical message which scrolls on the customer display or appears on the video monitor.

The removing of the above string is referred to as the Negative Exception. Follow the following steps to program the negative exception. Turn the display off for that exception. In the Exception String enter the words "WELCOME TO XYZ SUPER" exactly as they appear on the screen, including spaces.



STRENGTH IN THE BUSINESS.

VSI-Pro VIDEO SERIAL INTERFACE

**NOTE** 

*Only 40 characters are allowed in each Exception String, including blank spaces.*

**OPERATOR**

Choices: 0000.00-9999.99

The Operator determines the behavior of the Range. Think of the Operator in mathematical terms. Setting the correct range and specifying "IN" or "OUT" will make the Operator perform "greater than", "less than", "equal to", "in the range", or "out of the range" calculations.

With this version of the VSI-Pro, you can define ranges for your exceptions and have the VSI-Pro alarm when an exception falls within the range's parameters or outside the range of the two numbers. The choices are "IN", "OUT", and "NONE". To program the operator, press the "Up" or "Down" button to move the cursor to "OPERATOR" and press "Set". The cursor will start flashing. Press the "Up" or "Down" button to cycle through the values and press "Set" when the desired value is displayed.

**RANGE**

Choices: 0000.00-9999.99

The Range defines the limits of the Operator. These are numeric only. As you can see from the previous examples, the range has two separate fields that are separated by a double-sided arrow. This format must be followed.

To program the range, press the "Up" or "Down" button to move the cursor to "RANGE" and press "Set". The first "0" in the range starts to flash. This means it is active and ready for programming. Press the "Up" or "Down" button to cycle through the values and press "Set" when the desired value is displayed. This will advance the active block to the next character. While you are on an active block, pressing the "Up" and "Set" buttons simultaneously will return that block back to a blank, which is designated by a solid white box. You can follow this format to program your range. When you have finished and want to set this range into the VSI-Pro memory, simultaneously press and release the "Up" and "Down" buttons.

When you are ready to exit and continue on, simultaneously press and release the "Up" and "Down" buttons. This will set the range in the VSI-Pro memory and exit you back to the previous menu.

**EXMAPLES FOR SETTING EXCEPTION****EQUAL**

Suppose Exception #2 would be flag all \$10 sales on Register Department 1. This would be the settings for this Exception: (For these examples, we are using the Samsung ER-4715 Electronic Cash Register)

Exception	No. 2
Display	ON
Output	ON,OFF (depending on presence of serial printer)
Exception String1 . . .	
Range	0010.00-0010.00
Operator	IN

## PROGRAMMING

---

### OUT RANGE

Suppose Exception #3 would "FLAG" every transaction on Department 2 that is under 10 cents and over \$100 dollars. This would be the settings for this Exception:

Exception No. 3  
Display ON  
Output ON, OFF (Depending on presence of serial printer).  
Exception String2 . . .  
Range 0000.10 -0099.99  
Operator OUT

### IN RANGE

Suppose Exception # 5 would flag all transactions between \$50.00 & \$100.00 on Department 3:

Exception No. 3  
Display ON  
Output ON or OFF (Depending on presence of serial printer).  
Exception String3 ...  
Range 0049.99-0099.99  
Operator IN

*With this exception all sales between \$50 and \$100 dollars will be flagged.*

### IN RANGE

Suppose Exception # 5 would flag all transactions between \$50.00 & \$100.00 on Department 3:

Exception No. 3  
Display ON  
Output ON or OFF (Depending on presence of serial printer).  
Exception String 3 ...  
Range 0049.99-0099.99  
Operator IN

*With this exception all sales between \$50 and \$100 dollars will be flagged.*

### GREATER THAN

This example will show you how to program an exception to flag all sales in department 5 greater than \$100 dollars

Exception No. 2  
Display ON  
Output ON or OFF  
Exception String 5...  
Range 0000.01- 0099.99  
Operator OUT

*Now whenever anyone rings a sale of \$100 or more on Department 5, the transaction will be flagged.*

### LESS THAN

This example will show you how to program an exception to flag all sales in Department 6 of less than \$100. 00:

Exception No. 4  
Display ON  
Output ON or OFF  
Exception String 6  
Range 0000.01-0099.00  
Operator IN



**EXCEPTION REPORT MENU CONTINUED****OUTPUT**

Choices: ON, OFF

This is global output to send data to the serial printer. When "ON" is selected all the data will be send to the serial printer regardless of what setting of out put has selected in the individual output in set exception menu. When "OFF" is selected only those exception will send to the serial printer whose out put is "ON" under set exceptions menu for individual exceptions. To turn output "ON" or "OFF", press the "Up" or "Down" button to move the cursor to "OUTPUT" and press "Set". Press the "Up" or "Down" button to cycle through the values and press "Set" when the desired value is displayed.

**TIME STAMP**

Choices: ON, OFF

If TIME STAMP is selected "ON" then printer will print the exception with time stamp flag, otherwise just print the Exception. To turn TIME STAMP "ON" or "OFF", press the "Up" or "Down" button to move the cursor to "TIME STAMP" and press "Set". Press the "Up" or "Down" button to cycle through the values and press "Set" when the desired value is displayed.

**EXIT**

Press the "Up" or "Down" button to move the cursor to "Set" to return to the previous menu.

**5.8 ALARM OUTPUTS**

To access alarm output, press the "Up" or "Down" button to move the cursor to "ALARM OUTPUTS" and press "Set". The following sub-menu will appear:

<input checked="" type="radio"/> ALARM NO.	1
<input type="radio"/> ALARM TRIGGER	1
<input type="radio"/> NORMALSTATE	NO
<input type="radio"/> ALARM DURATION	20
<input type="radio"/> FLAG TYPE	FLASH *
<input type="radio"/> FLAG DURATION	000
<input type="radio"/> TRIGGERED TEXT	
<input type="radio"/> EXIT	

Figure 66: ALARM OUTPUTS Sub-Menu

**The ALARM OUTPUTS menu controls not only the formatting of the external alarms but also the formatting of the on-screen flags assigned to individual exceptions.**

**ALARM NO.**

Choices: 1, 2, 3, 4, 5, 6, 7, 8, 9, 10, 11, 12, 13, 14, 15, 16, 17, 18, 19, 20, 21, 22, 23, 24

The VSI-Pro allows you up to 16 alarms that may be used with any of the user programmed exceptions. However there are only 2 hardwired alarm outputs and these correspond to Alarm 1 & 2 only. The other 14 alarms can be used to send trigger text, serial data out or flash the screen. To select the Alarm Number that you want to program, press the "Up" or "Down" button to move the cursor to "ALARM NO." and press "Set". The cursor will start flashing. Press the "Up" or "Down" button to cycle through the values and press "Set" when the desired value is displayed.

# PROGRAMMING

---

## ALARM TRIGGER

Choices: 1, 2, 3, 4, 5, 6, 7, 8, 9, 10, 11, 12, 13, 14, 15, 16, 17, 18, 19, 20, 21, 22, 23,24 , 1-12, 13-24, 1-24

An Alarm Trigger is the source of activity programmed to activate a certain alarm. The alarm trigger tells the VSI-Pro what exception to use to trigger the alarming device or the on-screen flag.

Choices: Exceptions 1, 2, 3, 4, 5, 6, 7, 8, 9, 10, 11, 12, 13, 14, 15, 16, 17, 18, 19, 20, 21, 22, 23, and 24 (alarms when data is received that matches what you have set in these exception strings).

**Exceptions 1-12:** alarms when data is received that matches any data set in Exception 1-12.

**Exceptions 13-24:** alarms when data is received that matches any data set in Exception 13-24.

**Exceptions 1-24:** alarms when data is received that matches any data set in Exception.

## RTS

External alarm input. The VSI-Pro has 1 alarm input, if you are not using the handshaking function. A contact closure to ground on pin 7 (pin 5 is ground) will trigger this alarm. Coupled with the RTS Triggered text, you can now display a 40 character message from an external alarm input.



### **RTS APPLICATION NOTE**

**The RTS alarm input can be connected to a timer on the drawer of a cash register to alarm and send the message "DRAWER OPEN" to the screen if the drawer is open too long.**

To select the alarm trigger that you want to program, press the "Up" or "Down" button to move the cursor to "ALARM TRIGGER" and press "Set". The cursor will start flashing. Press the "Up" or "Down" button to cycle through the values and press "Set" when the desired value is displayed.

## NORMAL STATE

Choices: NO (Normally open), NC (Normal closed)

There are two choices: NO (normally open) or NC (normal closed). These selections determine whether the alarm outputs will act as a normally open switch or a normally closed switch.

To select the Normal State that you want to program, press the "Up" or "Down" button to move the cursor to "NORMAL STATE" and press "Set". The cursor will start flashing . Press the "Up" or "Down" button to cycle through the values and press "Set" when the desired value is displayed.

## ALARM DURATION

This is the amount of time in seconds that the alarm will remain activated once it is triggered. The selections for alarm duration are: PULSE, 6, 12, 20, 30, 60, 120, 180, and 300 seconds. (PULSE sends a 200mS alarm pulse to the alarm device.)

To select the amount of time in seconds that you want to program the alarm duration, press the "Up" or "Down" button to move the cursor to "ALARM DURATION" and press "Set". The cursor will start flashing. Press the "Up" or "Down" button to cycle through the values and press "Set" when the desired value is displayed.





## FLAG TYPE

This feature allows you to insert a visual alarm flag on each exception that you program to aid in the review of the video tape. This flag can appear as an asterisk "\*", a flashing asterisk, reverse text, or flashing reverse text.

To make your selection, press the "Up" or "Down" button to move the cursor to "FLAG TYPE" and press "Set". The cursor will start flashing. Press the "Up" or "Down" button to cycle through the values and press "Set" when the desired value is displayed.

## FLAG DURATION

Choices: 6, 12, 30, 60, 120, 180,..., 300

This is the amount of time in seconds that the on-screen FLAG, either the Asterisk or the Reverse mode, will remain activated once it is triggered.

### NOTE

**Flag Duration is independent of the Alarm Duration. Flag Duration is the amount of time the on-screen flag will remain on after activation, while, Alarm Duration is the amount of time that the hard-wired Alarm Output remains activated after it is triggered.**

To select the amount of time in seconds that you want to program for the flag duration, press the "Up" or "Down" button to move the cursor to "FLAG DURATION" and press "Set". The cursor will start flashing. Press the "Up" or "Down" button to cycle through the values and press "Set" when the desired value is displayed.

## TRIGGERED TEXT

A Triggered Text is a data string that associates with one of the 16 alarms or with external RTS alarm. When the alarm is triggered by a source, the associated string is sent out and/or displayed, if enabled respectively. Each Triggered Text can contain up to 40 printable ASCII data. If non-printable data (control code) is included, each control code occupies 3 printable spaces. Therefore, only 13 control codes maximum can be programmed in one Triggered Text. To program the TRIGGERED TEXT, go to the ALARM OUTPUTS sub-menu. Select desired ALARM NO or RTS for external alarm. Then go to the TRIGGERED TEXT sub-menu.

<input checked="" type="radio"/>	DISPLAY TEXT	OFF
<input type="radio"/>	OUTPUT TEXT	OFF
<input type="radio"/>	SET TRIGGERED	TEXT
<input type="radio"/>	EXIT	

Figure 67: TRIGGERED TEXT Sub-Menu

## DISPLAY TEXT

Choices: ON, OFF

Press the "Up" or "Down" button to move the cursor to "DISPLAY TEXT" and press "Set". The cursor will start flashing. Press the "Up" or "Down" button to cycle through the values and press "Set" when the desired value is displayed. Selecting "OFF" will not display any exception text on the video output.

# PROGRAMMING

---

## OUTPUT TEXT

Choices: ON, OFF

Press the “Up” or “Down” button to move the cursor to “OUTPUT TEXT” and press “Set”. The cursor will start flashing. Press the “Up” or “Down” button to cycle through the values and press “Set” when the desired value is displayed. Selecting “OFF” will not send any exception text to the serial printer.

## SET TRIGGERED TEXT

Press the “Up” or “Down” button to move the cursor to “SET TRIGGERED TEXT” and press “Set”. The following sub-menu will appear:



Figure 68: Triggered Text Main-Menu

You can enter 2 lines with 40 alpha numeric text on each line. You can also enter non-printable data (control code) instead of triggered text. Each control code occupies 3 characters, therefore you can enter 13 control codes in a line. To enter control code, first print up arrow ^ followed by 2 hex digit. For example, hex code 01 has to be entered like ^ 01.

Press “Up” and “Down” simultaneously to exit..

### EXIT

Press the “Up” or “Down” button to move the cursor to “EXIT” and press “Set” to return to the previous menu.

## 5.9 TEST/DEMO MODE

The TEST/DEMO MODE provides you with several ways to test the VSI-Pro and demonstrate its capabilities as a cash register interface. Press the “Up” or “Down” button to move the cursor to “TEST/DEMO MODE” and press “Set”. The following sub-menu will appear:

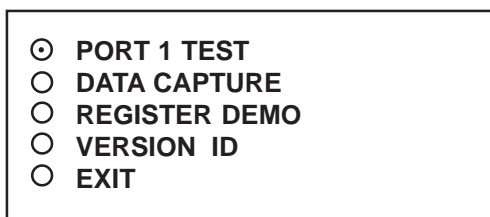

Figure 69: TEST/DEMO MODE Sub-Menu

## PORT 1 TEST

Sending and receiving data performance can be analyzed under the PORT 1 TEST sub-menu. Press the “Up” or “Down” button to move the cursor to “PORT 1 TEST” and press “Set”. The following sub-menu will appear:

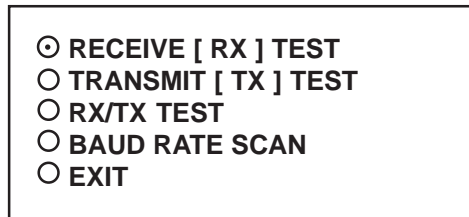

Figure 70: PORT 1 TEST Sub-Menu

## RECEIVE [ RX ] TEST

The purpose of this test is to determine that if VSI-Pro is receiving the data or not. Press the “Up” or “Down” button to move the cursor to “RECEIVE [ RX ] TEST”. The following display will appear (example only):

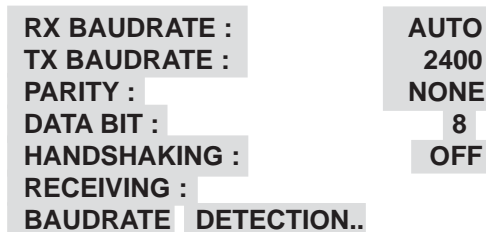

Figure 71: RECEIVE [ RX ] TEST Display

Receiving data will be appear in three sperate lines, scrolling from right to left. The first line is the actual ASCII data coming from the register while last two lines are HEX conversion of ASCII data. If you do not receive any data, check the connections between VSI-Pro and Register or any additional interfacing device.

Press “Set” to return to the previous menu.

## TRANSMIT [ TX ] TEST

The purpose of this test is to determine that if the VSI-Pro is able to transmit data or not. Press the “Up” or “Down” button to move the cursor to “TRANSMIT [ TX ] TEST” and press “Set”. The following display will appear (example only):

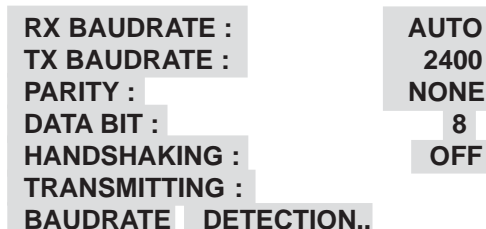



Figure 72: TRANSMIT [ TX ] TEST Display

If VSI-Pro transmitting data you will see some predefined ASCII character on the screen. If you don't see any characters on the screen, check the connections and try again.

Press “Set” to return to the previous menu.

**NOTE**   
*In any of the above tests, you can stop the scrolling data by holding down either “Up” or “Down” button.*

**RX / TX TEST**

In the RX/ TX test the VSI-Pro echos whatever it receives. Press the “Up” or “Down” button to move the cursor to “RX/ TX TEST” and press “Set”. The following display will appear (example only):

```
RX BAUDRATE :      AUTO
TX BAUDRATE :      2400
PARITY :          NONE
DATA BIT :        8
HANDSHAKING :     OFF
ECHOING :
BAUDRATE  DETECTION..
```

**Figure 73: RX /TX TEST Display**

Press “Set” to return to the previous menu.

**BAUD RATE SCAN**

The Baud Rate Scan test can scan the baud rate of your register. Press the “Up” or “Down” button to move the cursor to “BAUD RATE SCAN” and press “Set”. The following display will appear (example only):

```
RX BAUDRATE :      AUTO
TX BAUDRATE :      2400
PARITY :          NONE
DATA BIT :        8
HANDSHAKING :     OFF
BAUDRATE SCAN :
BAUDRATE  DETECTION..
```

**Figure 74: Baudrate Scan Display**

Enter a transaction from the register. The VSI-Pro will detect the baud rate and display it in front of RX Baud rate.

Press “Set” to return to the previous menu.

**EXIT**

Press the “Up” or “Down” button to move the cursor to “EXIT” and press “Set” to return to the previous menu.

## DATA CAPTURE

This feature allow user to store the data either internal memory of VSI-Pro or some external data storing device. Press the “Up” or “Down” button to move the cursor to “DATA CAPTURE” and press “Set”. The following sub-menu will appear:



Figure 75: DATA CAPTURE Sub-Menu

Press “Set” to return to the previous menu.

## CAPTURE TO PORT 1

This feature redirect the incoming data to VSI-Pro to its output ( Pin 3 of AT type RS-232 female connector ) where that data can be stored to data storing devices (e.g. PC). This feature is useful to store non-RS 232 format data. Press the “Up” or “Down” button to move the cursor to “CAPTURE TO PORT 1 and press “Set”. The following display will appear (example only):

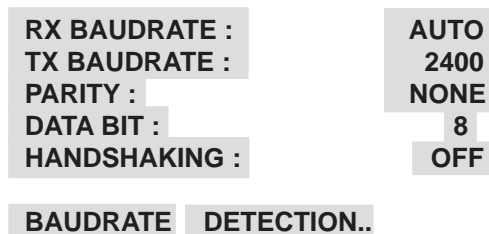

Figure 76: CAPTURE TO PORT 1 Display

Press “Set” to return to the previous menu.

## CAPTURE TO MEMORY

This feature allow you to store the data in the internal memory of VSI-Pro. You can store up to 20 kilobytes of data in the internal memory of VSI-Pro. Power up the VSI-Pro for 24 hours prior to download of data. This will provide VSI-Pro’s internal battery a full charge to hold data in its memory. Press the “Up” or “Down” button to move the cursor to “CAPTURE TO MEMORY” and press “Set”. The following display will appear (example only):

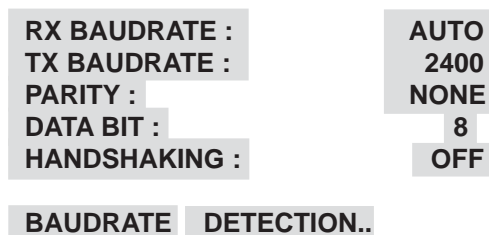

Figure 77: CAPTURE TO MEMORY Display

Press “Set” to return to the previous menu.

### NOTE

*VSI-Pro can only hold up to 20 kilobytes of data to make sure that you only transfer the data which is in correct format.*

## PROGRAMMING

**NOTE**  Any Programming or data transfer of any kind can overwrite the saved data in memory.

### DUMP MEMORY

You can upload any saved information from the VSI-Pro memory to any PC or some specific communication devices using appropriate upload cable. To upload the information into a PC you must have any communication software which can transfer the binary data. Press the “Up” or “Down” button to move the cursor to “DUMP MEMORY” and press “Set”. The VSI-Pro will start uploading the data.

### REGISTER DEMO

This demonstration simulates transaction data from a register. This is used to demonstrate the VSI-Pro's capabilities with just a monitor and camera without having a register hooked up. When the demo mode is active the VSI-Pro thinks the data is actually coming from a real register. You can use this demo data to configure exceptions and alarms to be fully functional for a complete customer demonstration.

Press the “Up” or “Down” button to move the cursor to “REGISTER DEMO” and press “Set”. You will see the following;

<input checked="" type="radio"/> DEMO	
<input type="radio"/> DEMO ON POWER UP	OFF
<input type="radio"/> EXIT	

Selecting “DEMO” will give you two options of 19 or 37 characters per line. After selection the demo will start after a few seconds. To exit this demo, press and release “Reset”. If data is sent to the VSI-Pro during this demo mode with “DEMO ON POWER UP” set to OFF then the demo mode will be disabled and you must go back into the programming mode and select again as described above.

If you select “DEMO ON POWER UP” as “ON” then pressing the “Reset” or powering up or down will have no effect on the demo mode and will continuously work until disabled by this menu selection. If you connect the VSI-Pro to a cash register and it sends data to the VSI-Pro during this demo mode then the demo mode will also be disabled until you press “Reset” or power down and up again.

### VERSION ID

When selected, this will display the version of software in use by the VSI-Pro shown detail (example below).

VSI-PRO Version 13.00R19  
03/25/2008

### EXIT

Press the “Up” or “Down” button to move the cursor to “EXIT” and press “Set” to return to the previous menu.

## 5.10 DOWNLOAD/UPLOAD SETUP

This feature lets you upload or download data between two VSI-Pro's or a VSI-Pro and a PC. This feature is especially helpful on multi-interface installations. You can program one VSI-Pro and download the data to another VSI-Pro with the download/upload feature and a data transfer cable. The cable is made up of two male DB-9 connectors and the pin-out is below. **NOTE:** This feature is only available to like versions and release. Therefore you can only program a Ver. 13.00 R5 with a same exact VSI-Pro or erroneous data will occur.

#### DOWNLOAD/UPLOAD DATA CABLE

PIN 2 \_\_\_ \_\_\_ \_\_\_ PIN 3  
PIN 3 \_\_\_ \_\_\_ \_\_\_ PIN 2  
PIN 5 \_\_\_ \_\_\_ \_\_\_ PIN 5

Figure 78: Download/Upload Data Cable



## DOWNLOAD/UPLOAD SETUP USING VSI-PRO TO VSI-PRO

To insure that the DOWNLOAD/UPLOAD process is accomplished, you need to access the programming menu for both VSI-Pro's, so each VSI-Pro needs a video input and a monitor. The optimum way to perform the DOWNLOAD/UPLOAD process would be to have a system set up with two separate cameras and monitors and the programmed VSI-Pro with the download data cable attached. The VSI-Pro programming data is stored internally in a battery backed 32K x SRAM. This would allow you to program one VSI-Pro on-site and bring the programmed VSI-Pro back to the shop or office and program additional VSI-Pro's quickly. We realize this may not always be possible to do and that there may be a need for field programming. The only difficulty with the field DOWNLOAD/UPLOAD process is accessing the programming menus of both VSI-Pro's simultaneously.

The use of the diagram in Figure 79 will let you perform the DOWNLOAD/UPLOAD process in the field. For this, you will need a short BNC to BNC cable approximately a foot long, the data cable, and a monitor that can be used next to the VSI-Pro's.

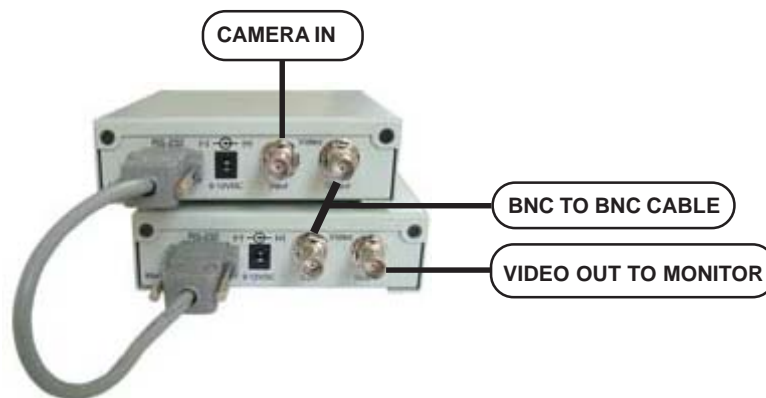

**Figure 79: DOWNLOAD/UPLOAD SETUP Using VSI-Pro to VSI-Pro**

The PROGRAMMED VSI-Pro will upload data to the UNPROGRAMMED VSI-Pro. In the configuration in the Figure 79, you can get the programming menus for both VSI-Pro's on the screen at the same time. Use the front panel shortcut to position the text block from the PROGRAMMED VSI-Pro on the left side of the screen. To do this, press and hold down "Up", then press and release "Reset" and then release "Up". Now, by using the "Up" and "Down" buttons you can move the display side to side on the screen. Move the text block as far to the left as you can and press "Set" to exit. To move the display to the top of the screen, press and hold down "Set" and press and release "Reset", then release "Set". Now by using the "Up" and "Down" buttons you can move the display up and down on the screen. Move the display to the top of the screen. When you have it in the correct position, press "Set" to exit.

Go to the UNPROGRAMMED VSI-Pro and follow the same instructions to move the display to the right side of the screen. After you have both displays positioned properly, the next step is to bring up both programming menus.

Let's bring up the PROGRAMMED VSI-Pro first. To do this, simultaneously press and hold "Up" and "Down" and press and release "Reset", then release "Up" and "Down". This will bring up the main-menu and it should be on the top left of the screen. Now go to the UNPROGRAMMED VSI-Pro and do the same thing. You should now have both programming menus side by side.

### NOTE

*Depending on the size of the monitor you are using, these two menus may overlap, but should not be a problem.*

## PROGRAMMING

To proceed with the DOWNLOAD/UPLOAD SETUP, we will configure the UNPROGRAMMED VSI-Pro first. From the main-menu, press the “Up” or “Down” button to move the cursor to “DOWNLOAD/UPLOAD SETUP” and press “Set”. The following sub-menu will appear:



Figure 80: DOWNLOAD/UPLOAD SETUP Sub-Menu

Press the “Up” or “Down” button to move the cursor to “DOWNLOAD SETUP” and press “Set”. The following sub-menu will appear. Move to the cursor to “DOWNLOAD SETUP” and press “Set” and the display “DOWNLOAD SETUP...” will appear:

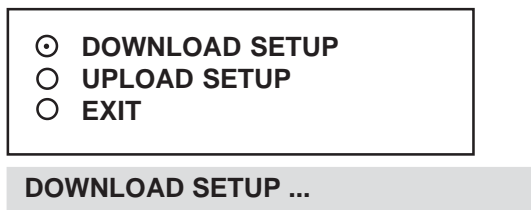

Figure 81: DOWNLOAD SETUP Sub-Menu & Display

The UNPROGRAMMED VSI-Pro is now waiting to receive data from the PROGRAMMED VSI-Pro.

Now go to the main-menu of the PROGRAMMED VSI-Pro and follow the previous instructions to get to “UPLOAD SETUP” and press “Set”. The following sub-menu will appear. Move to the cursor to “UPLOAD SETUP” and press “Set” and the display “UPLOAD SETUP...” will appear:



Figure 82: UPLOAD SETUP Sub-Menu & Display

The data transfer will begin and you will have a screen count down of the status that reads:

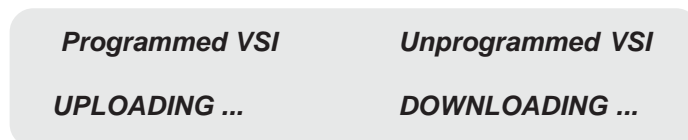

The count will end at 100. When this prompt clears the screen, the data transfer is complete. Press “Reset” to exit this menu on both VSI-Pro’s.

Now go to the main-menu of the previously UNPROGRAMMED VSI-Pro on the right side of the screen. Enter the EXCEPTIONS menu. You should see your exceptions and other programmed data just as they were on the original PROGRAMMED VSI-Pro.



## DOWNLOAD/UPLOAD SETUP USING A PC

You can use a Laptop PC and AVE's IC or equivalent communications program to store data from a VSI-Pro to a file. This file can then be uploaded to other VSI-Pro units with the same software revision level. Use 4800 baud for the PC's baud rate. **NOTE:** This feature is only available to like versions and release. Therefore you can only program a Ver. 13.00 R5 with a same exact VSI-Pro or erroneous data will occur.

### NOTE

*For locations or companies with a large number of interfaces, we strongly advise that you keep one programmed VSI-Pro as a master and a backup to insure your system integrity. This will also aid in reprogramming any changes and protect against any catastrophic events.*

## VSI-Pro Remote Program Downloading Ver. 1.0

The VSI-Pro Version 13.00 Release 12 now has the ability to upload or download all the programming settings and history files via a PC Windows based application. Customer or specific registers configurations can now be saved in a laptop for ease of service and programming. You can set the VSI-Pro clock in sync with a laptop or manually enter. Simple keyboard strokes can enter titles, exceptions and trigger strings quickly and easily. This is accomplished by using a Com port of the laptop or a USB to RS-232 adapter. Auto connection time out and error recovery guarantees the VSI-Pro will function under any condition including cable breakage, power down of laptop or VSI-Pro and accidentally hitting reset on the VSI-Pro during connection.

## Software Installation

Click Setup.exe for the VSI-Pro Program Download V1.0  
After installation is complete, run the program. The following window will be loaded.

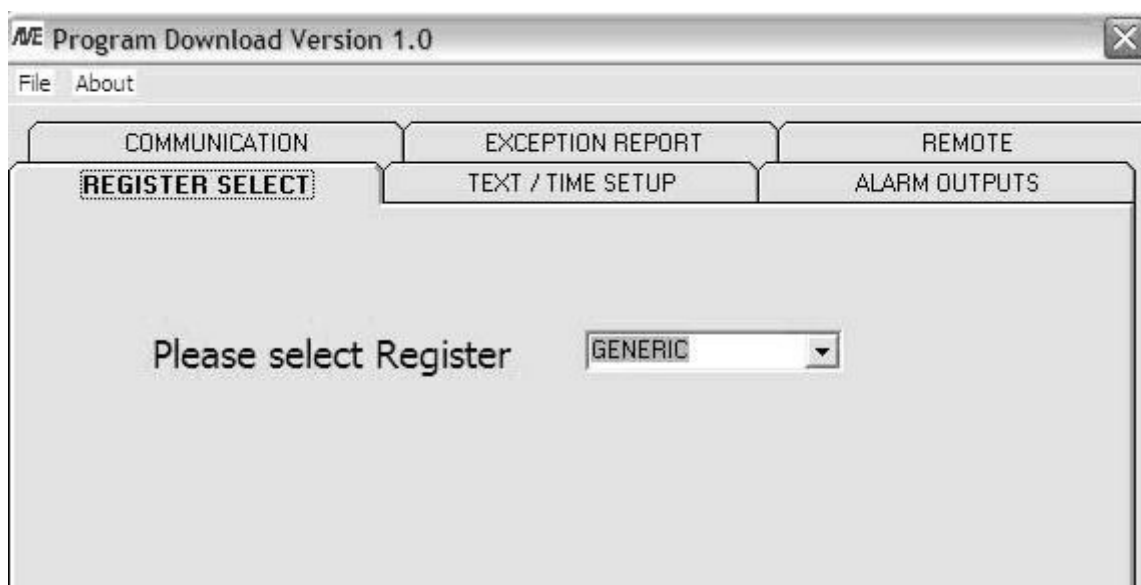
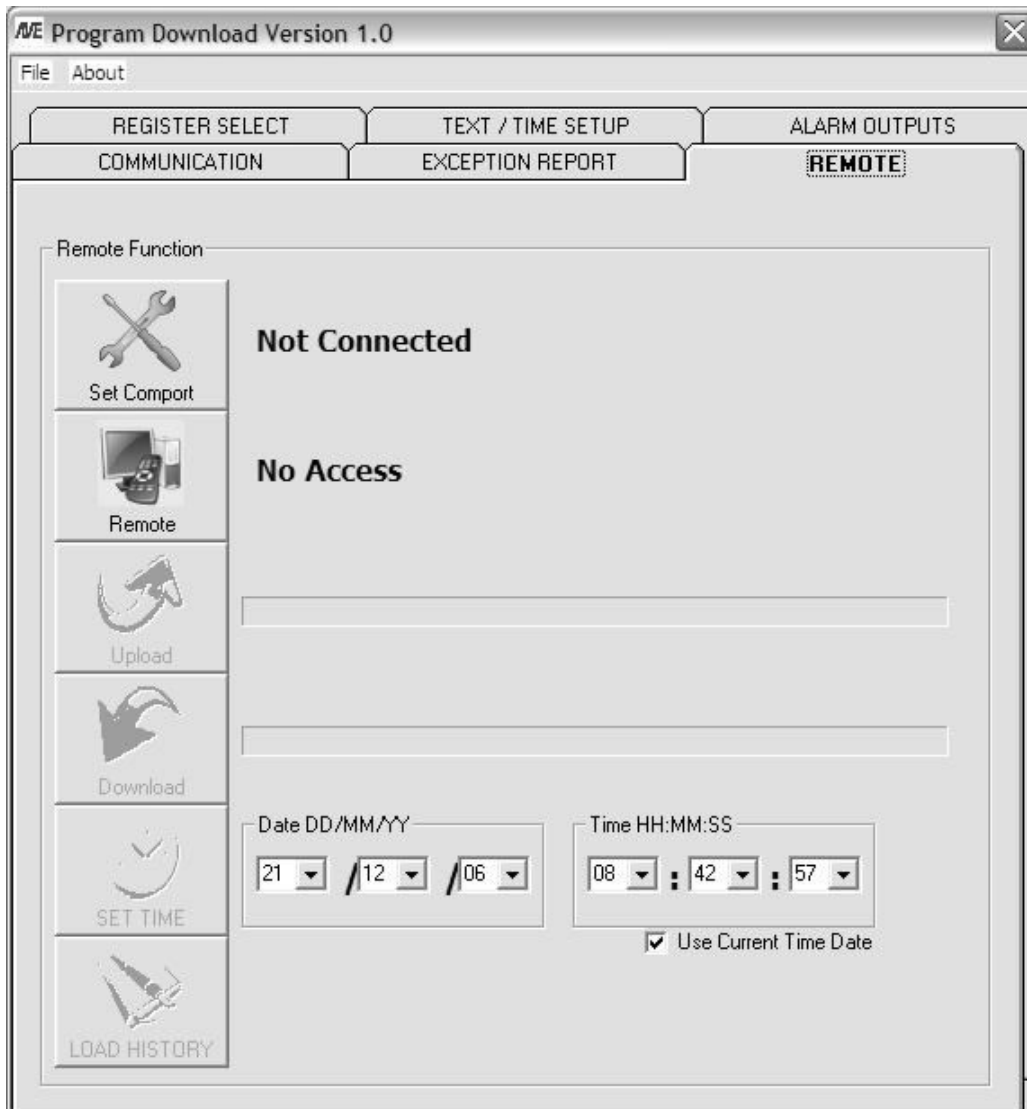

Figure P1 Program Download Main Menu

## PROGRAMMING

Click the Tab “Remote” and you will see the following Menu.



**Figure P2 Remote Menu**

Click on “Set Comport”. If the VSI-Pro is in the “Baudrate Detection” Mode then you can set any baud rate and the VSI-Pro will self configure. However if the VSI-Pro is already set to a baud rate you must select the exact baud rate and communication configuration in the VSI-Pro for connection to occur. If the unit does not display “Connected” then you have either entered the wrong baud rate or communication settings or a cable problem or the VSI-Pro not powered.

Once connected then click “Remote” and will display “Accessed” or will go back to “No Access” if the baud rate or cable connection is not proper and will also go back to “Not Connected” so you can reset the communication settings.

Once you have “Access” then you can do any function on this menu screen. “Upload” data which reads the current settings of the VSI-Pro into the PC. “Download” which sends the PC settings to the VSI-Pro. “Set Time” can set a new time or PC sync time to the VSI-Pro. “Load History” reads the History File of Exceptions from the VSI-Pro and saves as a text file on the PC.

Note: If the cable is disconnected, VSI-Pro reset or powered down, PC program closed, the PC and/or the VSI-Pro has a 30 second timeout and will reset itself for normal operation.

**File Menu**

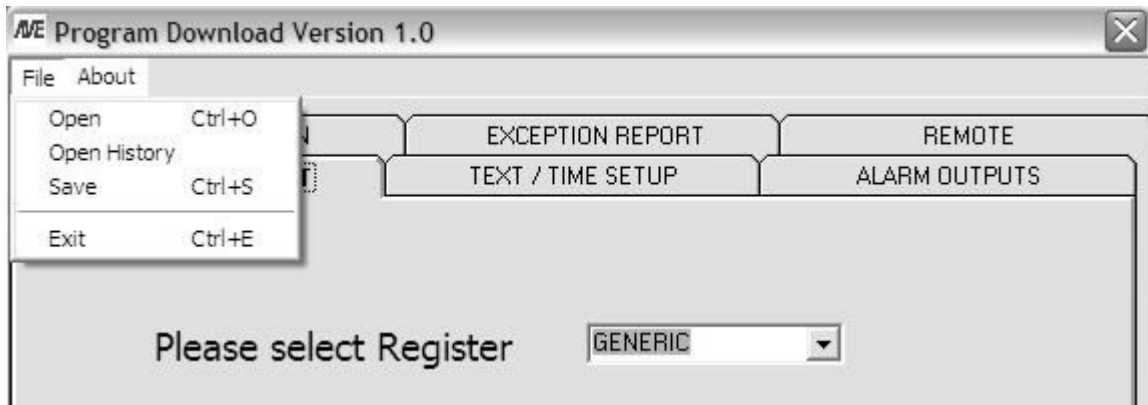

**Figure P3 File Menu**

“Open” allows you to select a file which contains a previously saved version of all the VSI-Pro setups.

“Open History” allows you to view a previously saved History File downloaded from the VSI-Pro.

“Save” allows you to save a current set of VSI-Pro settings that are configured in the program or previously uploaded from the VSI-Pro.

**About Menu**



**Figure P4 About Main Menu**

“Help” gives you all the help topics of the VSI-Pro Program Download Ver. 1.0.

“VSI-Pro Manual” is an online .pdf of the current VSI-Pro manual for easy reference to all the setups and programming features and applications of the VSI-Pro.

“About” shows you the version and release of this software.

**Communication Cable Pin Out**

The Com cable is RS-232 from the PC or laptop to the VSI-Pro as follows. This cable can be no more than 100’ but if additional length is required you will need a set of the AVE RS-232 to RS-422 adapter which will extend the range to 3000’

PC / Laptop	VSI-Pro
DB9F	DB9M
2 -----	3
3 -----	2
5 -----	5

# PROGRAMMING

## VSI-Pro Firmware Download Menu

To update the VSI-Pro, load the VSI-Pro Firmware Download Utility and follow the instructions below. Then select "UPDATE FIRMWARE" from the menu selection.



## VSI-Pro Firmware Download Utility

This document describes the VSI-Pro V13.00 Release 12. The new features of this version are able to download firmware update via the RS-232 port. The LDROM 4K boot strap loader must be burner to the uP via a conventional programmer. Then the executable program is then loaded via any terminal program such as Hyper Terminal via a PC or compatible device. All firmware files are encoded to the AVE proprietary format and decoded by the bootstrap loader for standard program execution.

### Update Firmware of VSI-Pro

You have to connect the VSI-Pro with a Serial Program Terminal such as HyperTerminal, IC etc. But advise to use HyperTerminal. First, you have to set the baud rate HyperTerminal to 19200

See PC Windows below to verify proper HyperTerminal setup.

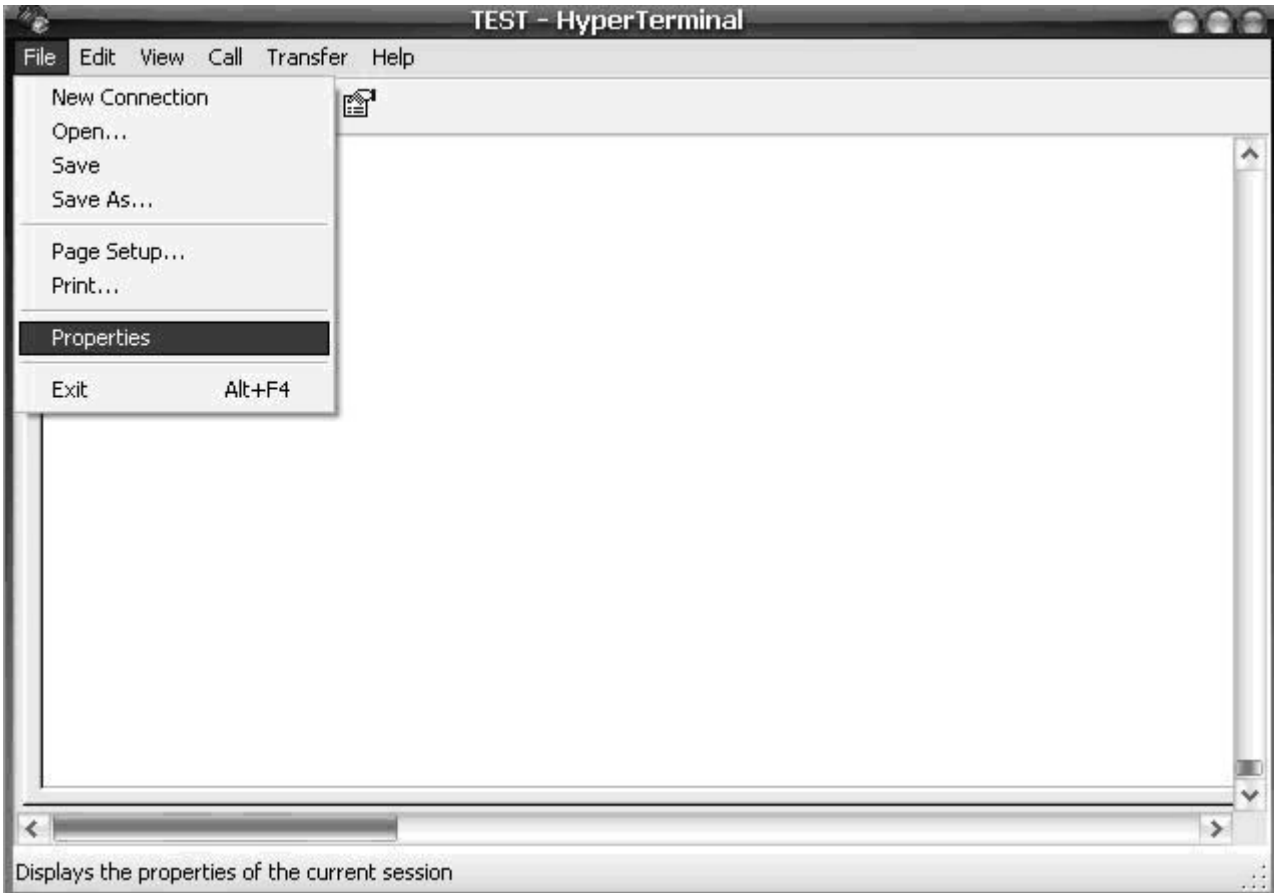
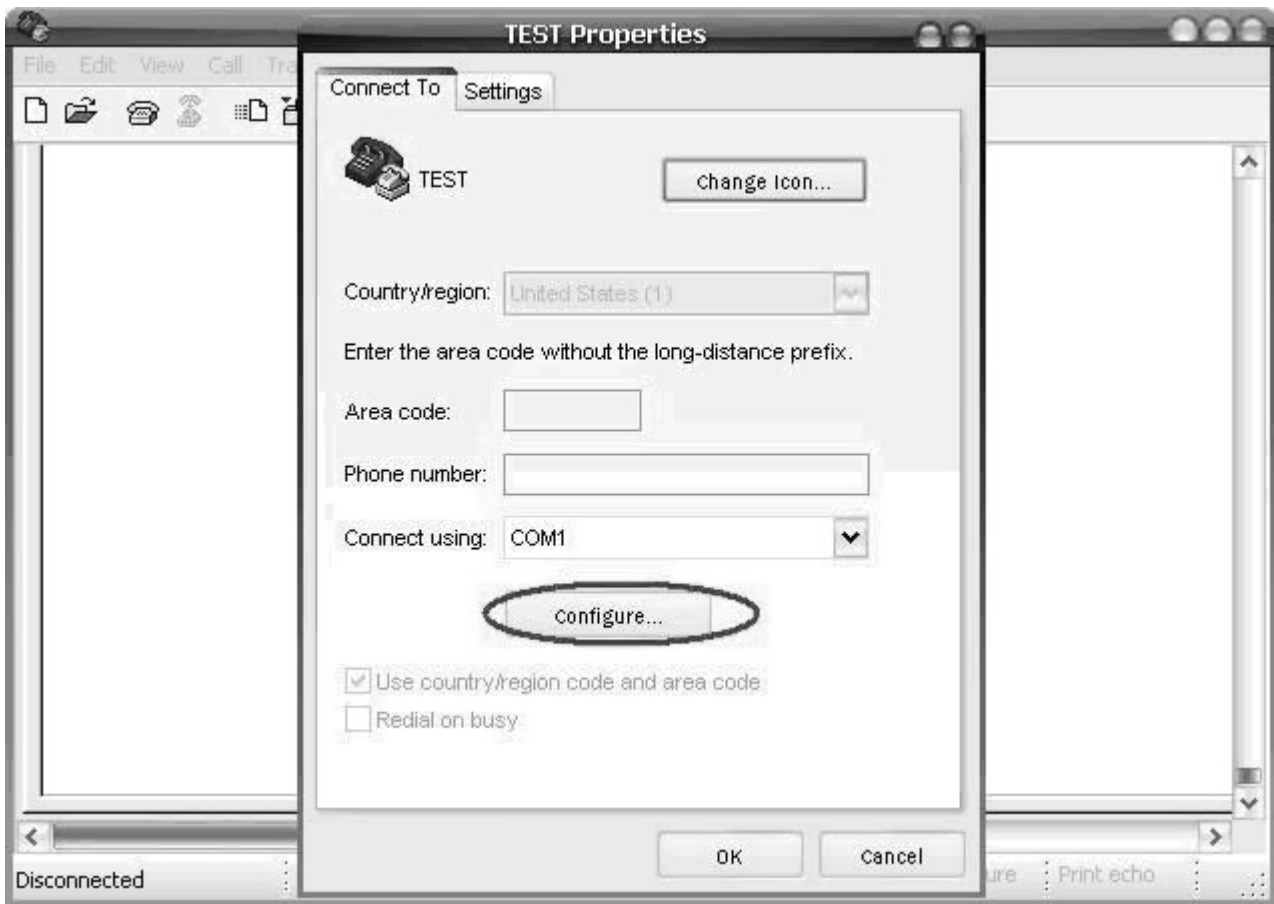

Figure P5 HyperTerminal Main Menu

Click File ==> Properties  
 You will see the configuration frame and then click.



Choose Bits per second to 19200 and press connect.

Figure P6 Connect To Menu

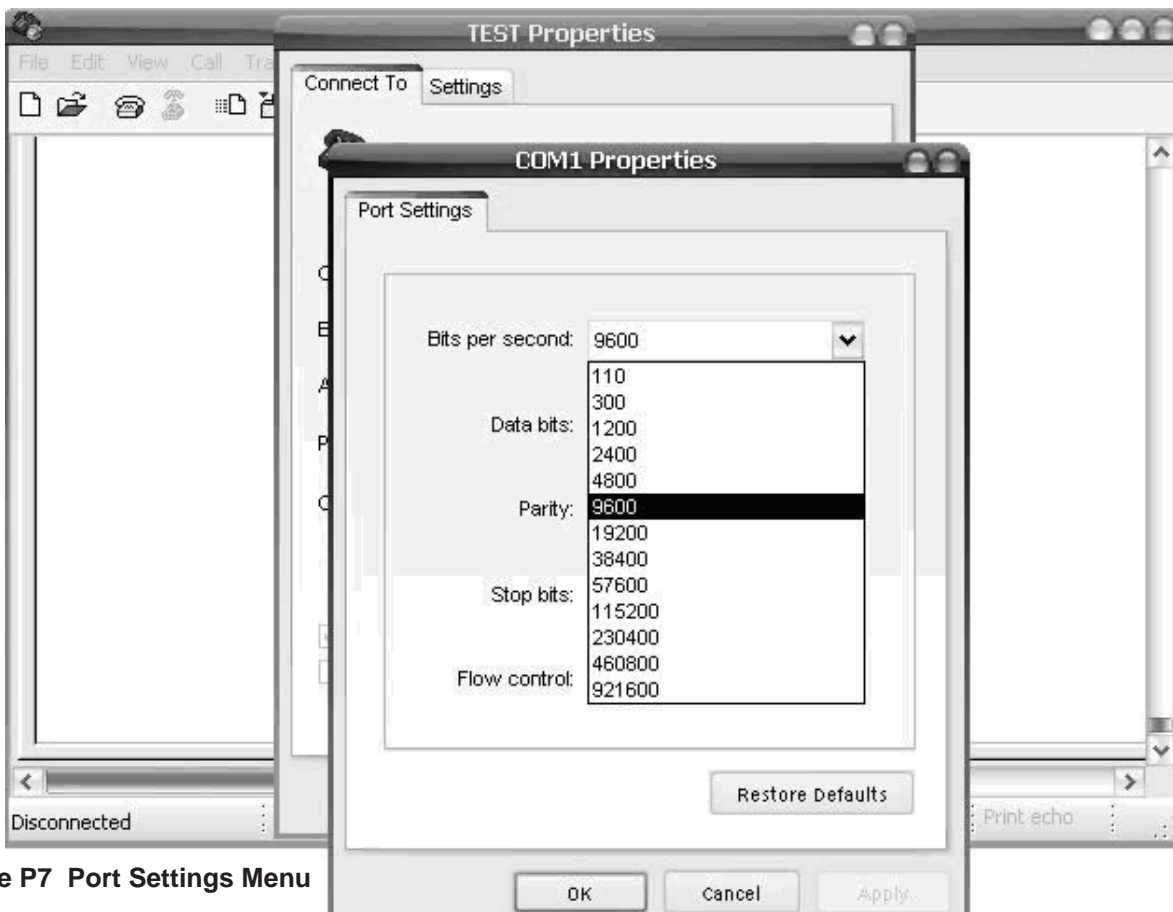
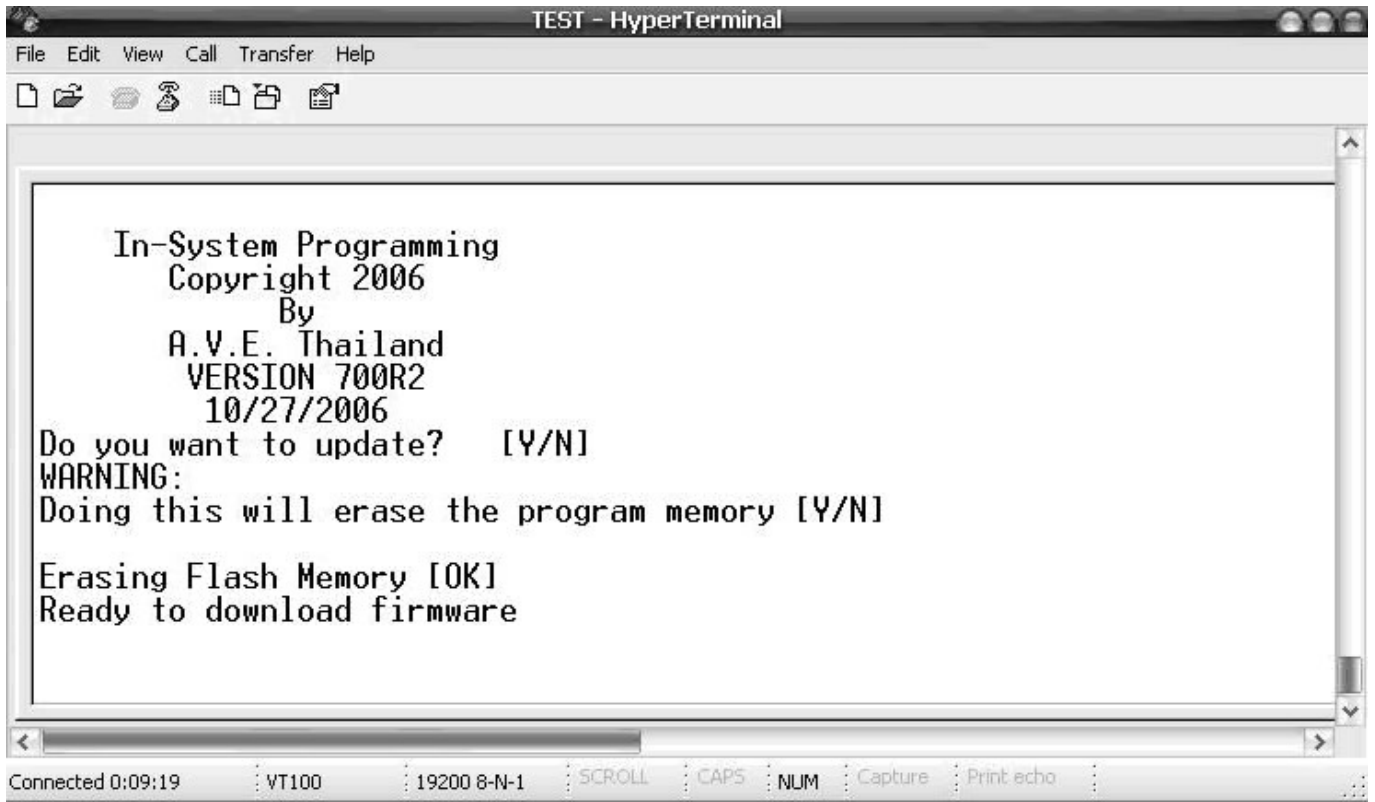

Figure P7 Port Settings Menu

## PROGRAMMING

Second, you go to the menu of the VSI-Pro "Download/Upload Setup" then select ==> "Update Firmware" and then press Set. Now you will see message in Hyper Terminal.



**Figure P8 In-System Programming Display**

"Do you want to update? [Y/N]"  
Press "Y" to accept update.  
You will see message warning again.  
"Doing this will erase the program memory [Y/N]"  
Press "Y" again to accept update.

NOTE: Pressing "Yes" again will permanently erase the entire program memory and the VSI-Pro will not function until firmware is loaded. Make sure you have the proper firmware file ready or the VSI-Pro will be rendered useless.

Finish erasing the program memory step.  
Next, you have to send file to update firmware by click on "Transfer Menu" and select "Send Text File" and wait until finished programming. Progress dots will be displayed on the terminal program until finished and takes approximately 2.5 minutes.

NOTE: If for some reason you are disconnected from the VSI-Pro during downloading, power is lost to the VSI-Pro or PC or the firmware update does not finish for any reason you can repeat the procedure above again. The bootstrap loader never is erased and will always request for a valid firmware update until achieved.

To do this just power up the VSI-Pro or press reset while the terminal program is connected and you will see the prompt messages as above window.

## 5.11 HELP

“HELP” on the main-menu provides a quick reference guide of the functions of the “Up” and “Down” and “Set” buttons.

<b>Key Definitions :</b>	
<b>UP/DOWN</b>	-- Change value
<b>SET</b>	-- Enter change mode
	-- Save change
	-- Go to position
<b>UP AND DOWN</b>	-- Save string
<b>input</b>	
<b>UP AND SET</b>	-- Erase character

Figure 83: HELP Sub-Menu

## PROBLEM SOLVING GUIDE

## APPENDIX A

### NO DATA ON-SREEN

1. Press the “Reset” button on the VSI-Pro front panel.
2. Incorrect register selected in the REGISTER SELECT menu.
3. Data cable is miswired.
4. Data cable is too long or did not use shielded cable.
5. May be connected to the wrong port.

### PROBLEMS WITH CR BOARDS

1. Check that the board is seated properly in the register.
2. Check jumper settings on the CR board if applicable.
3. On CR-700, 800 and 900 series boards, make sure the 2 pin data cable is plugged in correctly.
4. On CR-220 series board, make sure the 2 pin data cable is plugged in correctly.

### PROBLEMS WITH N2RS, NCR2RS, DTS2RS, B2RS ETC.

1. Check the cable to the register.
2. If VSI-Pro was working and stopped, power cycle the system. Turn off the register, unplug the power to the N2RS, and unplug the power to the VSI-Pro. Now power up the system, plug in the VSI-Pro and the N2RS. Turn on the register and do a transaction. The data should re-appear.
3. Check the cable between the VSI-Pro and the N2RS.

### NO VIDEO ON MONITOR

1. VSI-Pro transformer not plugged in, or is malfunctioning.
2. Video In/Out connectors reversed, or BNC connector is not correctly wired.
3. No video input signal.
4. Bad video cable or connector.
5. Camera Iris is closed.
6. Other video device in system is off or malfunctioning.



**CHARACTERS JITTER, JUMP, OR SKEW**

1. Darken the gray scale of the characters.
2. The VSI-Pro requires the input video signal to be 1V P-P +/-20%, terminated @ 75ohms. If the voltage is too high or low, then the VSI has trouble syncing the text to the video. Use an amplifier such as AVE's VDA-601 to get the proper level.
3. Poor input sync signals - too many AC coupled amplifiers in the video input signal.
4. Noisy or poor quality video source. Replace with better source.
5. Check for double termination.
6. Video level too high; VSI-Pro will clip video.
7. The text block is too close to the edge of the screen. Try repositioning the text block. Also, changing the size may help.
8. Too much light in the video picture may cause character distortion. Reposition the camera or reduce the amount of light to which the camera view is exposed. If the camera you're using has an auto iris lens, try adjusting the iris to average and then reduce or increase the level.

**NOTE** 

*The VSI-Pro requires 1V P-P +/- 20 percent, terminated @ 75 ohms.*

**FUNNY CHARACTERS OR GARBAGE ON SCREEN**

1. Power disconnected for too long and memory is lost.
2. Lightning strike, power line noise or power surge.
3. CR boards- make sure data cable is plugged in correctly.
4. Ground and Data wires are reversed. Verify correct DB-9 cable wiring.

**HOW TO DO A MASTER RESET ON VSI-PRO**

1. Press and hold in simultaneously the "Down", "Up" and "Set" buttons.
2. While holding those three buttons in, press and release the "Reset" button and then release the other three buttons.
3. This will display the copyright notice.
4. Restores the VSI-Pro to all the factory default settings.

**MY CUSTOMER IS CHANGING REGISTERS. WILL THE VSI-PRO THEY HAVE WORK WITH THE NEW REGISTER?**

This is a tricky one. The VSI-Pro interfaces to over 400 different registers, and as a result, there are several versions of software needed to work with all these different systems. The probability the VSI-Pro will work with a new system is relatively high, especially if it's Version 13 based. The chances any additional boards or boxes will work is lower, unless your customer is staying with the same manufacturer and within the same register series.

**Contact AVE's Product Support Specialists for additional help with this issue.**

**IF I INSTALL YOUR INTERFACE BOARD INTO A NEW REGISTER, WILL IT VOID MY CUSTOMER'S WARRANTY?**

If you are connecting to an external RS-232 port of the register, generally it does not void the warranty. But if you want to add the interface board inside your new cash register, we will highly recommend you to contact the manufacturer of the cash register.



**VSI-Pro VIDEO SERIAL INTERFACE**



There are a myriad of PC-based systems out there which do not appear on the AVE Cash Register Compatibility List. Most of the PC-based cash registers that were not included in the AVE Cash Register Compatibility List are able to interface to the VSI-Pro. To find the compatibility of a cash register we need to determine following:

Does the cash register use a stand-alone receipt printer? If it does it can either be a serial or parallel printer. Serial printers use DB9 or DB25 type connectors. However parallel printers generally use Centronics type connectors, but on the cash register side use DB25. If it is a serial printer then you can use an AVE Triport DB9 or Triport DB25.

The VSI-Pro can also interface with a parallel printer, if a high speed parallel-to-serial converter is connected with either the cash register or with the printer. You can also use AVE's high speed serial-to-parallel converter "P2RS" for interfacing the VSI-Pro to the parallel port. AVE's high speed P2RS converter is shown below.

Pole or Customer Displays are similar to printers and are either serial or parallel and all the above also apply.



Figure 1B: P2RS Parallel-to-Serial Converter Front Panel



Figure 2B: P2RS Parallel-to-Serial Converter Rear Panel



Serial Input      Power      Printer Cable

Figure 3B: P2RS Parallel-to-Serial Converter Connection Cables



Figure 4B: DB-25 Cable

The Pin-Out for the cable between the P2RS and the VSI-Pro is as follows.



Figure 5B: Centronics Cable

P-2-RS ( DB-9F )	VSI-Pro ( DB-9M )
TXD 3	2 RXD
GND 1	5 GND

Figure 6B: Pin-Out for P2RS to VSI-Pro

## REGCOM / HYDRA COMMUNICATION PROTOCOL

### OPERATION

The Regcom receives RS-232 data from a cash register, VSI-Pro, Interface Adapter, or ECR Interface card inside the cash register. It then stores this data in its buffer before sending it on to the Hydra via the RS-485 network.

The Regom & Hydra use a bi-directional, 2-wire RS-485 databus to communicate with each other. The Hydra is a "master" device and the Regcom is a "slave" device. One master device can be connected to a maximum of 16 slave devices. Only one master device can exist on a single network.

The master device controls the flow of data by polling each of the slaves in turn. When polled, a slave device will either respond with a "No Data" code to say it has no data to send, or it will begin sending data from its buffer.

The Hydra can support many manufactures of DVR for direct storage of the transaction data on the DVR as a file rather than just inserting in the video image for recording. It also supports the VSI-ADD (VSI Addressable) format which allows multiple VSI-Pros to be mounted in a convenient rack and connected on Hydra for display of cash register data remotely.

### HYDRA COMPATABILITY LIST

#### DVR

- Norbain Columbus
- GE StoreSafe
- Kalatel StoreSafe
- NOVAR VP
- Dallmeier
- Appro
- Pinetron

#### Other

- RegCom
- Networker
- Vnetworker
- VSI-ADD



Figure 1C: DS-20-OF VSI-Pro PCB Rack using VSI-ADD protocol

**REGCOM RS232 / RS485 INTERFACE DEVICES**

**OVERVIEW**

The Regcom is an interface device that allows the connection of multiple cash register terminals to a master unit for the purpose of transaction logging.

**CONNECTION DIAGRAM**

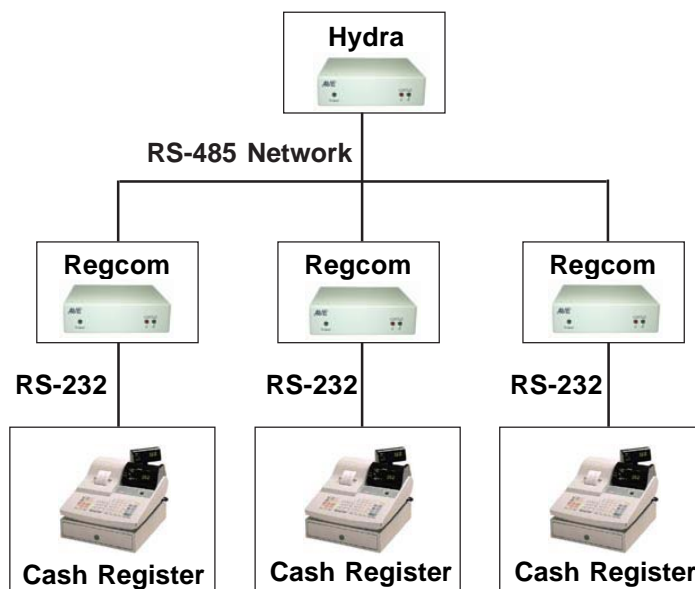

Figure 2C: Connection Diagram

**NETWORK TERMINATION**

The device at end of the network must be "TERMINATED". An 8 DIP switch on the rear of the unit is used to set the termination. When the switch is set to "ON", the device is terminated. When the switch is set to "OFF", it will be un-terminated.

**DB-9 Pin-Out**

Pin 1	
Pin 2	RX ( RS-232 )
Pin 3	TX ( RS-232 )
Pin 4	
Pin 5	Ground
Pin 6	
Pin 7	
Pin 8	
Pin 9	

Table 2C: DB-9 Pin-Out

**RJ-45 Pin-Out**

Pin 1	
Pin 2	
Pin 3	
Pin 4	RS-485 ( + )
Pin 5	RS-485 ( - )
Pin 6	
Pin 7	
Pin 8	

Table 3C: RJ-45 Pin-Out

## RS-485 NETWORK DATA CABLE WIRING

(120 Ohm impedance, twisted pair)

RJ-45	RJ-45
Pin 4	Pin 4
Pin 5	Pin 5

Table 4C : RS-485 Network Data Cable Wiring

## SPECIFICATIONS

## Electrical Characteristics

Operating voltage	9-12V DC
Supply Current	<200mA @ 12 V
Data Ports	1xRS-232 (DB-9), 2xRS-485 (RJ-45)

Table 5C: Electrical Characteristics

## Physical Characteristics

Size	160 x 35 x 110 (mm)
Weight	300 g
Color	Gray
Case material	Plastic

Table 6C: Physical Characteristics

## RS-232 Parameters

Baud rate	9600
Data bits	8
Parity	None
Stop bits	1

Table 7C: RS-232 Parameters

## Network Parameters

Standard	RS-485
Max line length	4000 ft
Cable type	120 Ohm twisted pair

Table 8C: Network Parameters

**ADDRESS SELECTION**

Each Regcom unit on the RS-485 network must be set with a unique network address.

The address is selected using switches 1-5 from the bank of DIP switches on the rear of the unit. The address must correspond to the DVR channel number that the text is to be associated with.

The address must be set in binary code (see below), SW1 being the “least significant bit”.

Address No.	SW1	SW2	SW3	SW4	SW5
1	ON	OFF	OFF	OFF	OFF
2	OFF	ON	OFF	OFF	OFF
3	ON	ON	OFF	OFF	OFF
4	OFF	OFF	ON	OFF	OFF
5	ON	OFF	ON	OFF	OFF
6	OFF	ON	ON	OFF	OFF
7	ON	ON	ON	OFF	OFF
8	OFF	OFF	OFF	ON	OFF
9	ON	OFF	OFF	ON	OFF
10	OFF	ON	OFF	ON	OFF
11	ON	ON	OFF	ON	OFF
12	OFF	OFF	ON	ON	OFF
13	ON	OFF	ON	ON	OFF
14	OFF	ON	ON	ON	OFF
15	ON	ON	ON	ON	OFF
16	OFF	OFF	OFF	OFF	ON

Table 9C: Address Selection

**LED STATUS INDICATION**

Status light A illuminates whenever data is sent from the Regcom to the master unit .

Status light B illuminates to indicate the Regcom is correctly connectly connected via the RS-485 network to the master unit.



Figure 3C: Hydra / Regcom Front Panel



Figure 4C: Hydra / Regcom Rear Panel

**RS-485 NETWORKER**

The RS-485 Networker is designed to convert the RS-232 serial port output of the VSI-Pro to be a poll/select network. This allows all the transaction data to be collected by one computer for up to 64 VSI-Pro's.

**APPLICATION**

Many users of the VSI-Pro want to capture all the transaction data from several units to one device. The RS-485 Networker allows all data from up to 64 VSI-Pro's to be recorded on one PC or sent to one DVR. The user can then later search data history for evaluation. With remote software like PC Anywhere, a remote location could dial into many sites and review exception history and provide a value added service their existing customers.

**THEORY**

The VSI-Pro contains an internal data buffer of 24K bytes. The VSI-Pro can also be programmed for this buffer to hold all the on-screen data or just exceptions optionally containing Time/Date and other trigger text. The "handshaking" option in the VSI-Pro allows for external hardware handshaking for this output port to be controlled by the "RTS" input. When this hardware handshaking input is false, the data is saved to the internal buffer. When this input is true the data is sent out the serial port. The RS-485 Networker controls this handshaking signal to the VSI-Pro and when the networker is addressed by the host the data from the VSI-Pro is sent to the host. The data from each Networker is saved to a log file on the PC which can be read later as a data history from each VSI-Pro.

**RS-485 NETWORK**

Up to 64 RS-485 Networkers can be connected on one RS-485 2-wire network. A unique address for each RS-485 Networker is set by its internal dipswitch. The protocol is basically poll/select. The baud rate is set at 19.2K.

**RS-485 to RS-232 CONVERTER**

A standard PC or Laptop is used with the supplied software. The RS-485 to RS-232 Converter converts the PC or DVR RS-232 to RS-485. The handshaking signals of the PC control the direction of the RS-485 communications.

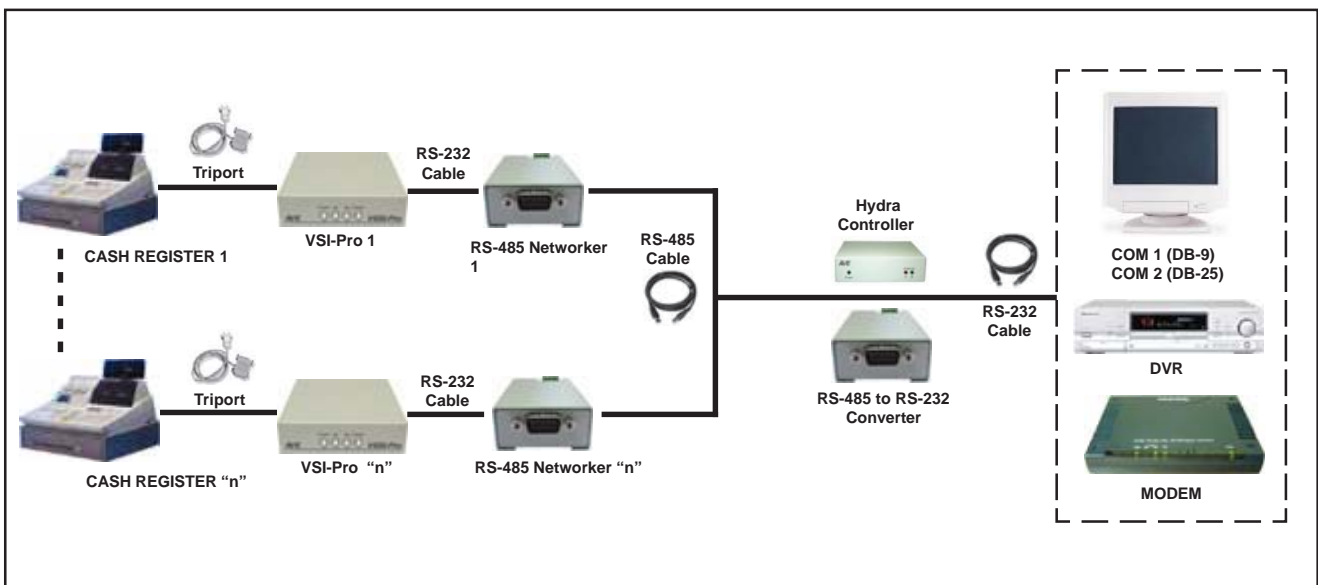

**"n" means up to 64 Cash Registers / VSI-Pro's / RS-485 Networkers can be connected on one RS-485 Network**

**Figure 1D: Connection Diagram for RS-485 Network**

The simple to install and use the Networker PC Software allows up to 64 VSI-Pros and Cash Registers to be configured on an RS-485 network and report all the transaction data back to a single monitoring computer. This Windows-based software can be configured to display in a windowing horizontal format below or tiling in a vertical format. All data files are stored separately as independent files on the PC and can be downloaded or searched locally or remotely to find specific transaction data or information. This can be used in conjunction with Windows-based DVR or Cash Register software and eliminates the use of an additional PC for the collection, search, or transmission.

WINDOWS TILE HORIZONTAL

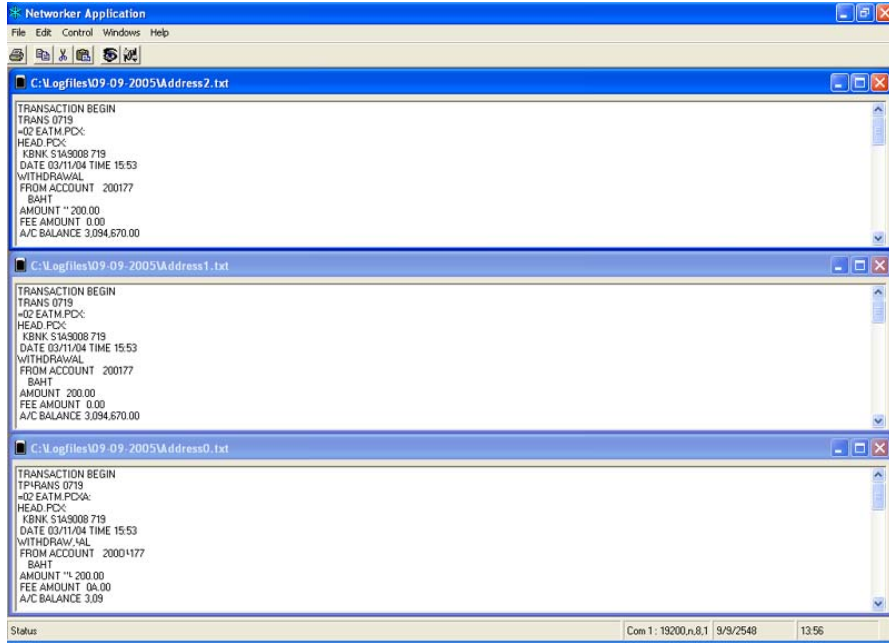

Figure1E : Windows Tile Horizontal

APPENDIX F

RS-485 VNETWORKER

RS-485 VNETWORKER

The Vnetworker is an enhancement to the Networker product and software to allow a PC to remotely control, program and upload register data from up to 16 VSI-Pros on a single RS-485 network. The Vnetworker products connects to the cash register, the VSI-Pro and the RS-485 networker and controls the flow of data from all devices. This device utilizes the "Hardware" handshaking RTS line of the VSI-Pro to control reading register data and signally the VSI-Pro that the user requires programming upload. The programming upload is user interactive remotely similar to pressing the front panel controls of the VSI-Pro and changing the on-screen menus. However most functions can be done remotely on the PC without looking at the monitor view of the menus and camera view. This feature is only available on VSI-Pro Ver. 13.XX Release 12 or higher. All Version 13.XX can be factory upgraded to support this feature.

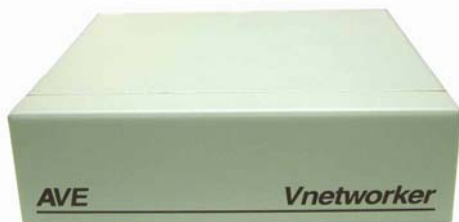
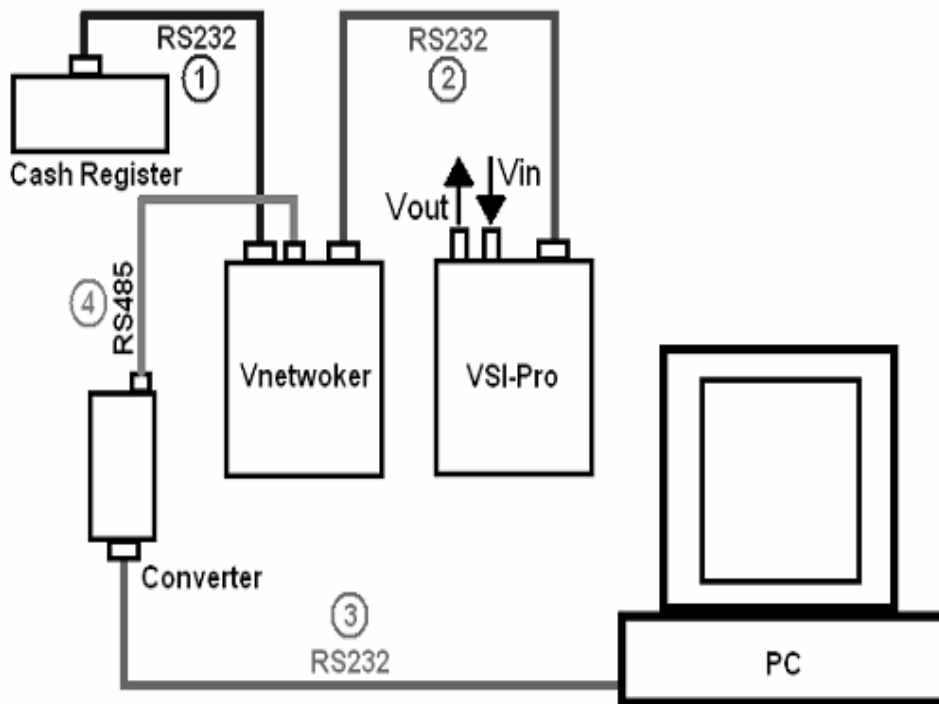

Figure : Vnetworker Front Panel



Figure : Vnetworker Rear Panel

The following diagram is a basic connection layout of the Vnetorker and VSI-Pro when used with a PC controller. All functions of the VSI-Pro locally operate normally and as a stand alone VSI-Pro. However the Vnetorker is placed between the VSI-Pro and the register so it can disable the serial connection to the VSI-Pro and control it for programming usage.



- ① RS232 Cable ( Vnetorker <=> Cash register )
  - ② RS232 Cable ( Vnetorker <=> VSI-Pro )
  - ③ RS232 Cable ( Converter <=> PC )
  - ④ RS485 Cable ( Vnetorker <=> Converter )
- <=> Communication One way  
 <=> Communication Two way

Figure : Vnetorker Connection Diagram

**Vnetorker Software**

The basic software of the Vnetorker is a macro set of the Networker software. The additional features allow the user to interactively program the VSI-Pro.

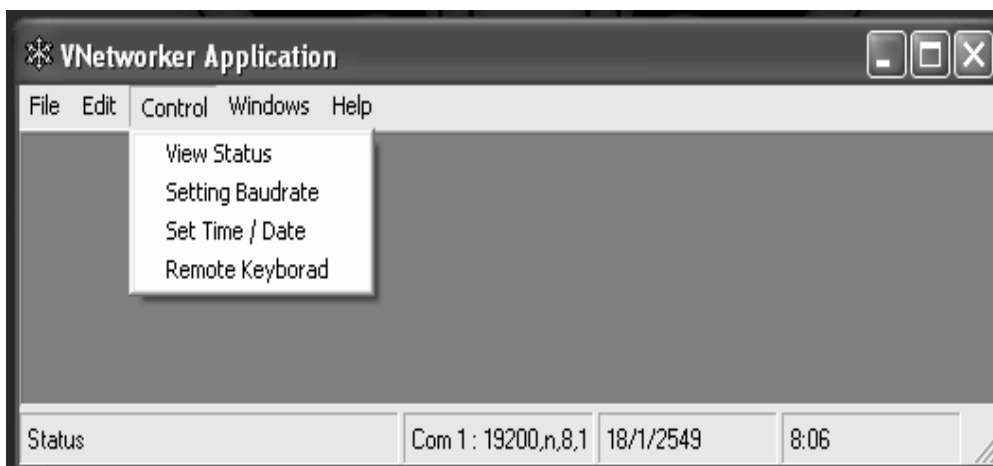

Figure : Vnetorker Main Menu



The new menu items are “Set Time / Date” and “Remote Keyboard”.

The “Set Time / Date” functions allows you to set this value from the PC Time/Date or manually enter yourself. Select ID sets the address value of the appropriate VSI-Pro on the network you wish to up date.

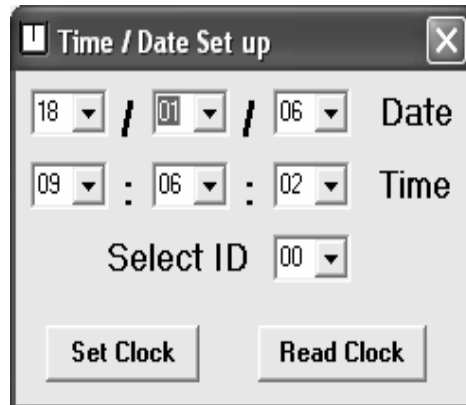

Figure : Time / Date Set up Menu

**Remote Keyboard**

This new function allows the user to select the appropriate VSI-Pro on the network with the Select Address setting. Once this is done you then click “Programming”. The Vnetworker will then signal the VSI-Pro to exit the register interface mode and go to the programming mode. **Note:** While in this mode all data from the cash register will not be stored or displayed in the VSI-Pro and will be lost.

After a brief pause, communication is established with the VSI-Pro and the following menu will be displayed. This is the same as the on-screen menu and using the “Up”, “Down”, “Enter” buttons you can navigate the VSI-Pro menu just like at the local pushbuttons.

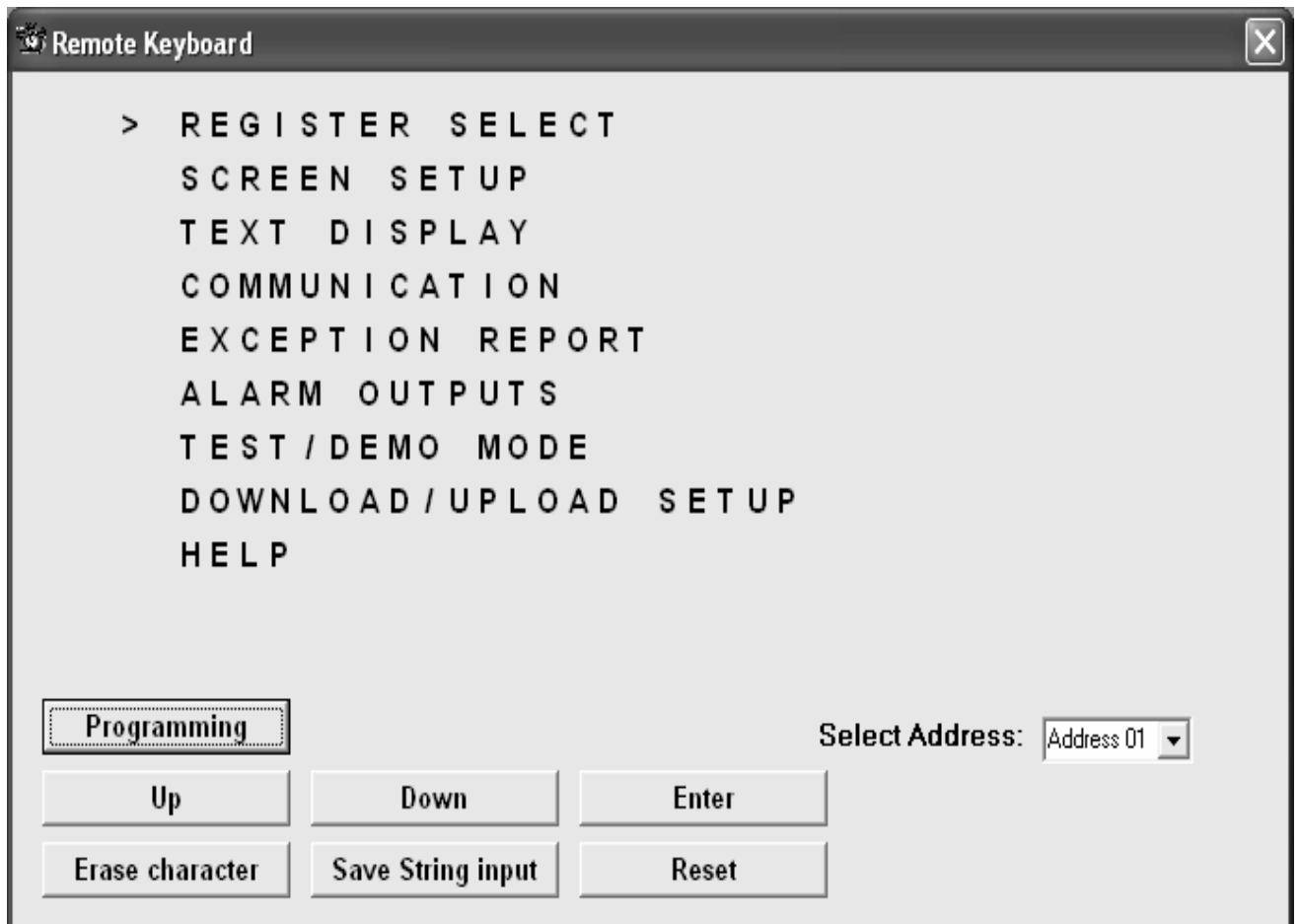

Figure : Remote Key-

VSIB for Thai, Korean or Chinese Languages

The VSIB is a bit-mapped display device that can display Thai, Korean, or Chinese characters. This device works in conjunction with the VSI-Pro. A special cable is connected between the VSI-Pro and the VSIB so all on-screen programming is done via the VSIB but the controls and menus are the same as the VSI-Pro. Therefore after connection, the programming will be identical to this manual. The VSIB must be ordered independently for any of the above supported languages and the language must be specified.



Figure 1F: VSI-Pro Front Panel



Figure 2F: VSIB Front Panel



Figure 3F: VSIB Rear Panel



Serial Input    Power    Video Input    Video Output

Figure 4F: VSIB Connection Cables

Disconnect the standard VSI-Pro and plug its cable into the female connector of the Triport.



Use the BNC connectors of the VSIB for your Video Input & Output

Figure 5F: Cable Connection to VSIB

The pin-out for the VSIB between the VSI-Pro and the VSIB is as follows:

VSIB ( DB-9M )	VSIB ( DB-9M )	VSIB ( DB-9M )	VSIB ( DB-9M )
TXD 3	_____	2	RXD
RTS 7	_____	8	CTS
GND 5	_____	5	GND

Figure 6F: Pin-Out for VSIB to VSI-Pro

The ECR Interfaces are small PCBs that mount internally to the cash registers. These PCBs convert internal data from matrix and drum printers or thermal printers to RS-232 data. This RS-232 data is then connected directly to the VSI-Pro for display. It also can be connected directly to the Regcom to send up to 16 cash register's data on a central collection PC or DVR.

The ECR Interfaces have many different connection types depending on the make and model of cash register. Typically the RS-232 cable comes from the rear of the register to further connect to the VSI-Pro or DVR. The manufacturer and model number of the cash register must be supplied when ordering this ECR Interface.

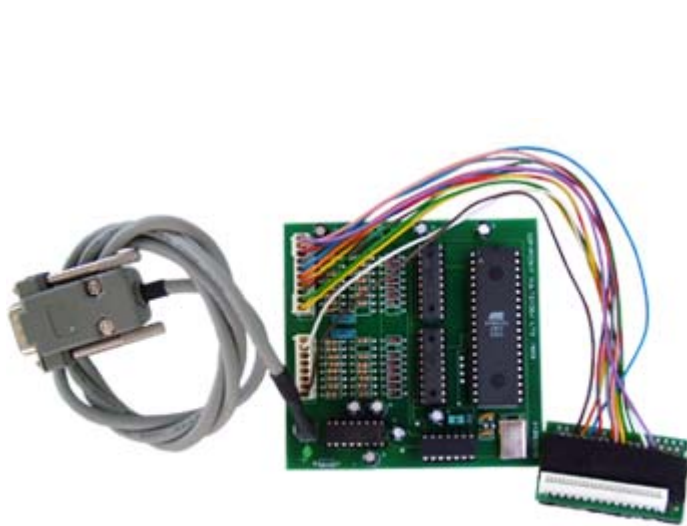

Figure 1G: TK6000/7000 PCB and Cable

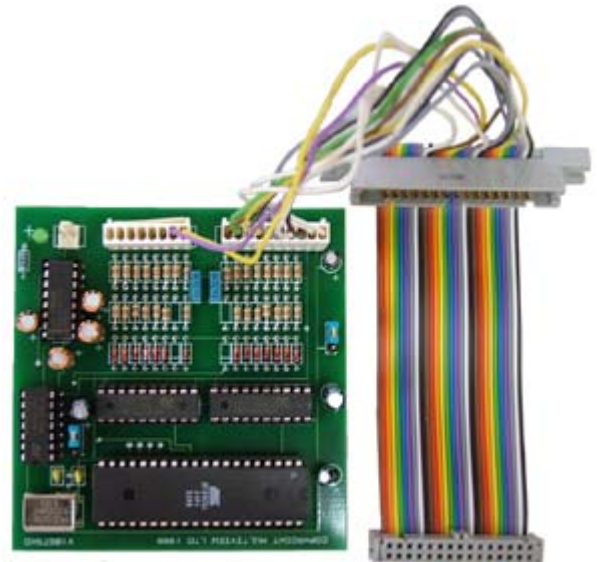

Figure 2G: TK2300 and Adapter

When using the AVE IF ECR Interface PCBs that are generally installed inside the cash register and an RS-232 connector mounted on the register or the RS-232 cable fitted through the rear of the till. These interfaces output direct converted and formatted RS-232 of the printer. This data can be connected directly to the AVE line of DVRs without additional conversion up to 100'. If additional lengths are needed then the AVE RS-232 to RS-422/485 converter can be used to extend this range to 3000'.

The Regcom interface can directly connect to these devices and report up to 16 tills on the Regcom network back to the PC Program or to the AVE line of DVRs converted using the Hydra.

TCPIP 232 ADAPTER

Interfacing the VSI-Pro to the cash register TCP/IP network requires the TCPIP 232 Adapter along with the VSI-Pro. The IP address of the cash register is programmed into the TCPIP 232 Adapter via on-screen programming. The cash register LAN cable is plugged into the adapter and the supplied additional LAN cable is then plugged into the cash register. Therefore this DOES NOT require an additional network port for the cash register interface or any host programming of a VPN router.



Figure 1H: Front of TCPIP 232 Adapter



Figure 2H: Rear of TCPIP 232 Adapter

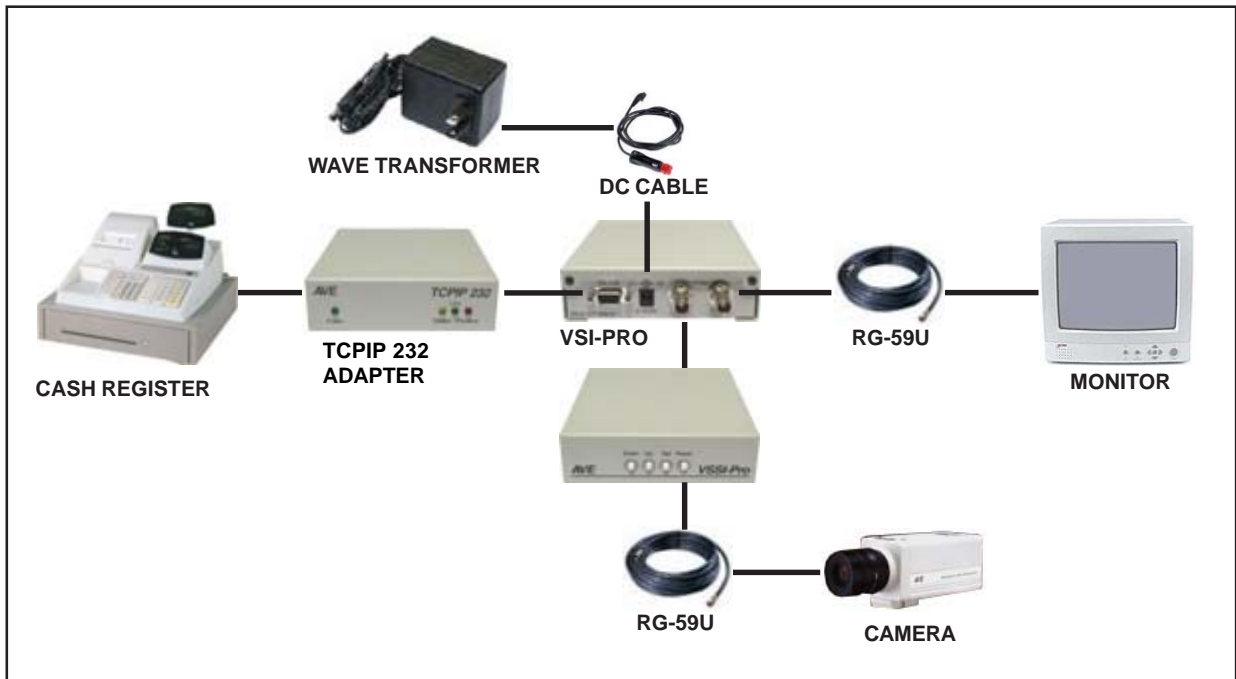

Figure 3H: VSI-Pro Connections with TCPIP 232 Adapter

The pin-out between the TCPIP 232 Adapter and the VSI-Pro is as follows:

TCPIP (DB-9M)	VSI-Pro (DB-9M)
RXD 2	3 TXD
TXD 3	2 RXD
GND 5	5 GND

Figure 4H: Pin-Out for TCPIP 232 Adapter to VSI-Pro

The VSI-Pro provides two open collector transistor alarm outputs to trigger alarming devices. These are Alarm 1 & 2 in the Alarm menu. Upon an Exception, a VSI-Pro can be programmed to trigger a VCR to go to its fastest record time, have a Quad go full screen, home a switcher, trigger a preprogrammed PTZ, or provide visual or audible alarms. The VSI-Pro provides two alarm outputs that are rated at 12VDC @ 20mA maximum.

The following are some basic circuit designs to take advantage of the alarm output option of the VSI-Pro.

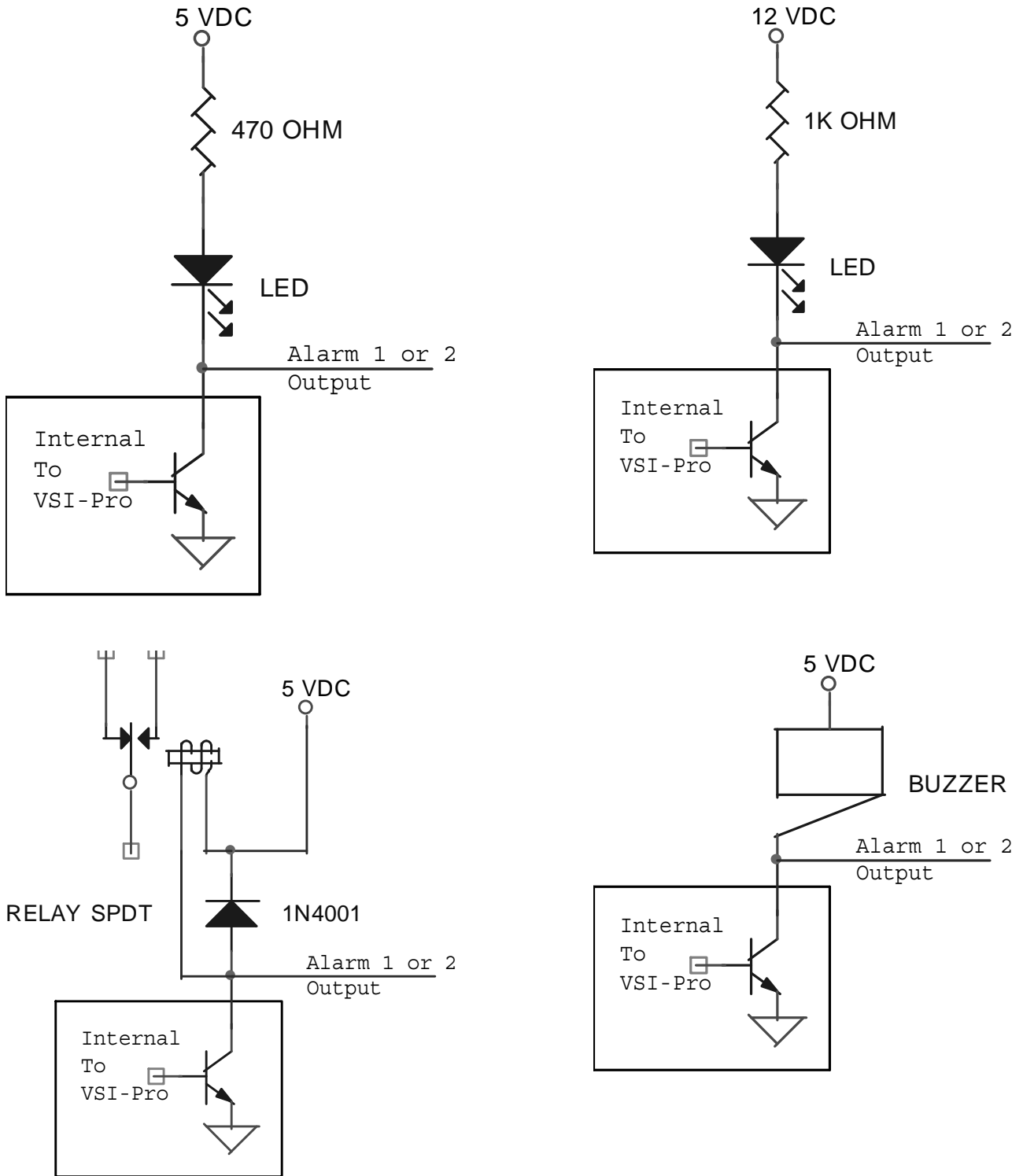

Figure 1H: Hard Alarm Output

## VSI-PRO VERSION 13.00 REGISTER SELECT MENU

MODEL	REGISTER	SPECIAL CABLE	SPECIAL MODE
GENERIC	X	X	X
ADDRESSABLE VSI	X	X	PASSIVE TAP
PC COM1,2,3,4	X	X	X
AD 4323			
ADS			
DELTA SONO 3.1	X	X	X
DRESSER WAYNE	X	X	X
EDACOM	X	X	X
ELCA	X	X	G2 MOD
FUJITSU 9920	X	CABLE FUJ 9920	X
GASBOY	X	X	X
GILBARCO	G-SITE	X	X
GILBARCO	TCRG/2	X	G2 MOD
GILBARCO	TCR15(OLD)	X	SPECIALMOD
IBM3151 TERMINAL	X	X	X
IBM	RDS	X	X
JETSORT			
MEMS-5	X	X	X
MICRELEC	MASTER SERISE	X	X
	9500	X	X
MICROMAX	X	X	X
MICROPOS	X	X	X
MICROS	LOCALVSS	X	MAX232ORMOD485
	IDN NETWORK	X	X
	ISN NETWORK	X	X
NCR	2113,3000	X	NCR2113MOD
NIXDORF	BEETLE	X	X
NORAND	1200	X	X
PANASONIC	5000	X	X
	7000	X	X
	8000	X	X

Table 11: VSI-Pro Version 13.00 Register Select Menu

## VSI-PRO VERSION 13.00 REGISTER SELECT MENU (CONTINUED)

MODEL	REGISTER	SPECIAL CABLE	SPECIAL MODE
POLE DISPLAY	X	X	X
SHARP	2590		
	3100,3110	X	X
	3220,3221,3250	X	X
	3310,3311,3550		
	A-460,A-470	X	X
	A-550,A-570	X	X
	A-610,A-650	X	X
	A-750	X	X
	A-770		
SICOM	X	CABLE SICOM	MOD485
SUNTRONIC	890,891,960	X	X
	2000	X	X
SWEDA	54XX	X	X
SWINTEC	2250	X	X
TCI	X	X	X
TOLEDO			
UNITOUCH	DSP800	X	X
UNIWELL	UN4025	X	X
VERIFONE	X	X	X
VSI-DRS	X	X	X

Table 11: VSI-Pro Version 13.00 Register Select Menu (Continued)

VSI-PRO VERSION 13.24 REGISTER SELECT MENU

MODEL	REGISTER	SPECIAL CABLE	SPECIAL MODE
GENERIC	X	X	X
BEETLE /50 PRINTERS			
CASIO TK -T500			
CLARITY EPOS			
CASIO QT2K			
DRESSER WAYNE			
EDACOM			
HTEC			
HUTH T 400/T500			
KOPPENS GASPUMP			
NIXDROF BEETLE			
ODOMETER			
OMEGA 2000			
Q-MATIC			
SAMSUNG SRP 350			
SCHLUMBERGER			
SHARP 750 ER -OLPU			
SIEMENS			
UNIPAR			
UP3000			

Table 2I: VSI-Pro Version 13.24 Register Select Menu



**WARNING!**

**DOING A MASTER RESET CLEARS ALL PROGRAMMING AND  
THE VSI-PRO DEFAULTS TO THE FACTORY SETTINGS.**

If you have difficulty entering the main-menu or you changed EPROMS in your VSI-Pro, do the following procedure exactly: Lightly press and hold in the 3 buttons to the left ("Up", "Down" & "Set"). While holding down these buttons, press and release the "Reset" button. Then release the other buttons. Wait a few seconds and the copyright notice will appear on-screen along with the version of software installed in your VSI-Pro.

Upon powering up the VSI-Pro for the first time, if the battery is depleted the master reset should be done. However in some cases the Time/Date display may not have the correct or legible characters. If this occurs, go to the Clock programming section of the menu and reset the clock and program the correct time. The Time/Date display will then function properly and any subsequent master resets will not affect the time.

**NOTES**

**LIMITED WARRANTY*****(Terms and Conditions)***

For **2 Years** from the date of shipment, Seller warrants to Buyer that the Product is free from defects in material or workmanship **under normal use and service**. Equipment manufactured by other than Seller but furnished by Seller carries the same warranty to Buyer as Seller receives from the other manufacturer, notwithstanding any provision to the contrary. If Buyer has specified a particular manufacturer's product which is not the brand standardly supplied by Seller, Buyer shall look only to the other manufacturer's warranty and Seller shall not warrant such item.

***EXCLUSIONS. Seller's warranty does not cover the following :***

1. In-transit damage claims, improper handling by carrier or post office.

***(Only the consignee of the shipment can file a claim with the common carrier.)***

2. Damages caused by incorrect use, modification, carelessness, improper storage, hostile operating conditions, or unauthorized service, installation or repairs without proper training from the Seller.
3. Damages caused by fire, flood, lightning, collision, acts of God or other events beyond the control of Seller.
4. Products or parts thereof that have had serial numbers removed, altered or defaced.
5. Products returned without an RMA number and sales or delivery receipt showing the date of original purchase.
6. Use of components that do not meet Seller's specifications.
7. External parts such as cabinets or keypads.
8. Periodic maintenance and adjustments resulting from normal use.

***WARRANTIES EXCLUDED, SELLER EXPRESSLY DISCLAIMS AND EXCLUDES ANY EXPRESS OR IMPLIED WARRANTY OR MERCHANTABILITY OR FITNESS FOR A PARTICULAR PURPOSE WHICH EXCEEDS OR IS INCONSISTENT WITH THE WARRANTY HEREIN EXPRESSLY SET FORTH.***

***NON-WARRANTY CLAIMS***

In the event Buyer makes a warranty claim and Seller's warranty does not apply, Buyer shall reimburse Seller for all reasonable expenses incurred by Seller in diagnosing the installation/repair problem.

***BUYER'S EXCLUSIVE REMEDIES***

If the Product supplied shall fail to conform to the contract or any applicable warranty, Buyer shall immediately notify Seller of such condition and afford Seller a reasonable opportunity to inspect said Product. Seller shall, at its option, either repair or replace such nonconforming Product. Seller shall not be responsible for labor charges for removal or installation of such equipment or material or charges for transportation, handling and shipping except as provided in Seller's written service policy. No Product shall be returned without Seller's prior written consent.

**SELLER SHALL NOT BE LIABLE FOR ANY SPECIAL, DIRECT INCIDENTAL OR CONSEQUENTIAL DAMAGES OF A COMMERCIAL NATURE ARISING OUT THE USE OF OR INABILITY TO USE SELLER'S PRODUCT BY REASON OF THE FACT THAT SUCH PRODUCT DOES NOT CONFORM TO THE CONTRACT OR TO ANY EXPRESS OR IMPLIED WARRANTY. SELLER'S MAXIMUM LIABILITY SHALL BE LIMITED TO THE COST OF REPAIR AND/OR REPLACEMENT OF THE PRODUCT CLAIMED TO BE DEFECTIVE OR NONCONFORMING, SUBJECT TO SELLER'S RIGHT OF REMOVAL AND RETURN OF PRODUCT.**

All of the foregoing constitute Buyer's sole and exclusive remedy and Seller's sole and exclusive liability for supplying nonconforming or defective Product.

### **RETURNS**

AVE products are fully inspected and carefully packed to ensure you are delivered a quality product in good condition. If you are not fully satisfied with our product, returns of standard stocking items with no restocking fee can be made within thirty (30) days of invoice to Buyer. All such returns must have prior consent of Seller by obtaining an RMA number and must include the sales or delivery receipt showing the date of original purchase and be in an unused condition contained in its original packaging. Any other returns must have prior written consent of Seller and are subject to a restocking fee of fifteen percent (15%) and freight charges.

### **RMA NUMBER**

The RMA (Return Material Authorization) number must be obtained by contacting Seller prior to the shipment of the product for return. The RMA number is valid only for 15 days from the date of issue. The RMA number must be clearly displayed on all shipping labels.

### **NOTES**

---



#### **ASIA**

##### **AVE Thailand Co., Ltd.**

147 Soi On-Nut 44  
Sukhumvit 77 Rd., Suan Luang  
Bangkok, 10250 Thailand  
Tel: 662-331-9364, 331-9285  
Fax: 662-331-9365  
Email: [ave@avethailand.com](mailto:ave@avethailand.com)  
[www.avethailand.com](http://www.avethailand.com) (English)  
[www.ave.co.th](http://www.ave.co.th) (Thai)

#### **NORTH AMERICA**

##### **American Video Equipment (AVE)**

2000 West Governors Circle, Suite E  
Houston, Texas 77092  
Tel: 281-443-2300  
Fax: 281- 443-8915  
Email: [aveus@ave-us.com](mailto:aveus@ave-us.com)  
[www.americanvideoequipment.com](http://www.americanvideoequipment.com)

#### **WESTERN EUROPE**

##### **AVE Multiview**

Unit 1C, The Potteries,  
Woodgreen Road, Waltham Abbey  
Essex, EN9 3SA, UK  
Tel: 440-870-770-9323  
Fax: 440-870-770-9363  
Email: [ave-uk@multiview.net](mailto:ave-uk@multiview.net)  
[www.multiview.net](http://www.multiview.net)

## Free Manuals Download Website

<http://myh66.com>

<http://usermanuals.us>

<http://www.somanuals.com>

<http://www.4manuals.cc>

<http://www.manual-lib.com>

<http://www.404manual.com>

<http://www.luxmanual.com>

<http://aubethermostatmanual.com>

Golf course search by state

<http://golfingnear.com>

Email search by domain

<http://emailbydomain.com>

Auto manuals search

<http://auto.somanuals.com>

TV manuals search

<http://tv.somanuals.com>