

AVERATEC™

mobility without boundaries

7100 Series User Manual



Preface

Chapter 1

General Introductions

Chapter 2

Getting Started

Chapter 3

Customizing this Notebook

Chapter 4

BIOS Setup



Regulations Information

FCC-B Radio Frequency Interference Statement

This equipment has been tested and found to comply with the limits for a Class B digital device, pursuant to part 15 of the FCC rules. These limits are designed to provide reasonable protection against harmful interference in a residential installation. This equipment generates, uses and can radiate radio frequency energy and, if not installed and used in accordance with the instructions, may cause harmful interference to radio communications. However, there is no guarantee that interference will not occur in a particular installation. If this equipment does cause harmful interference to radio or television reception, which can be determined by turning the equipment off and on, the user is encouraged to try to correct the interference by one or more of the following measures:

- ♦ Reorient or relocate the receiving antenna.
- ♦ Increase the separation between the equipment and receiver.
- ♦ Connect the equipment into an outlet on a circuit different from that to which the receiver is connected.
- ♦ Consult the dealer or an experienced radio TV technician for help.

NOTE

1. *The changes or modifications not expressly approved by the party responsible for compliance could void the user's authority to operate the equipment.*
2. *Shield interface cables and AC power cord, if any must be used in order to comply with the emission limits.*

FCC Conditions

This device complies with part 15 of the FCC Rules. Operation is subject to the following two conditions:

1. This device may not cause harmful interference.
2. This device must accept any interference received, including interference that may cause undesired operation.

* For better environmental protection, waste batteries should be collected separately for recycling or special disposal.

Safety Guideline for Using Lithium Battery

(Danish) ADVARSEL! Lithiumbatteri --- Eksplosionsfare ved fejlagtig håndtering. Udskiftning må kun ske med batteri af same fabrikat og type. Levé det brugte batteri tilbage til leverandøren.

(Deutsch) VORSICHT: Explosionsgefahr bei unsachgemäßem Austausch der Batterie. Ersatz nur durch denselben oder einen vom Hersteller empfohlenen gleich-wertigen Typ. Entsorgung gebrauchter Batterien nach Angaben des Herstellers.

(English) CAUTION: Danger of explosion if battery is incorrectly replaced. Replace only with the same or equivalent type recommended by the equipment manufacturer. Discard used batteries according to manufacturer's instructions.

(Finnish) VAROITUS: Paristo voi räjähtää, jos se on virheellisesti asennettu. Vaihda paristo ainoastaan valmistajan suosittelemaan tyyppiin. Hävitä käytetty paristo valmistajan ohjeiden mukaisesti.

(French) ATTENTION: Il y a danger d'ex;losion s'il y a remplacement incorrect de la batterie. Remplacer uniquement avec une batterie du meme type ou d'un type équivalent recommandé par le constructeur. Mettre au rebut les batteries usages conformément aux instructions du fabricant.

(Norwegian) ADVARSEL: Eksplosjonsfare ved feilaktig skifte av batteri. Benytt same batteritype eller en tilsvarende type anbefalt av apparatfabrikanten. Brukte batterier kasseres i henhold til fabrikantens instruksjoner.

(Swedish) VARNING: Explosionsfara vid felaktigt batteribyte. Använd samma batterityp eller en ekvivalent typ som rekommenderas av apparatillverkaren. Kassera använt batteri enligt fabrikantens instruction.

Caution on Using Modem

1. Never install telephone cables during a lightning storm.
2. Never install telephone jacks in wet locations unless the jack is specifically designed for wet locations.
3. Never touch uninsulated telephone wires or terminals unless the telephone line has been disconnected at the network interface.
4. Use caution when installing or modifying telephone lines.
5. Avoid using the telephone function (other than a cordless type) during an electrical storm. There may be a remote risk of electric shock from lightning.
6. Do not use the telephone function to report a gas leak in the vicinity of the leak.

Optical Disc Drive Notice

CAUTION: This appliance contains a laser system and is classified as a "CLASS 1 LASER PRODUCT." To use this model properly, read the instruction manual carefully and keep this manual for your future reference. In case of any trouble with this model, please contact your nearest "AUTHORIZED Service Center." To prevent direct exposure to the laser beam, do not try to open the enclosure.

Macrovision Notice

This product incorporates copyright protection technology that is protected by U.S. patents and other intellectual property rights. Use of this copyright protection technology must be authorized by Macrovision, and is intended for home and other limited viewing uses only unless otherwise authorized by Macrovision. Reverse engineering or disassembly is prohibited.

Safety Instructions

1. Read the safety instructions carefully and thoroughly.
2. Save this User Guide for possible use later.
3. Keep this equipment away from humidity and high temperature.
4. Lay this equipment on a stable surface before setting it up.
5. The openings on the enclosure are used for air convection and to prevent the equipment from overheating. Do not cover the openings.
6. Make sure that the power voltage is within its safety range and has been adjusted properly to the value of 100~240V before connecting the equipment to the power inlet.
7. Place the power cord in a way that people are unlikely to step on it. Do not place anything on the power cord.
8. Always unplug the power cord before inserting any add-on card or module.
9. All cautions and warnings on the equipment should be noted.
10. If any of the following situations arises, get the equipment checked by a service personnel:

- ♦ The power cord or plug is damaged.
 - ♦ Liquid has penetrated into the equipment.
 - ♦ The equipment has been exposed to moisture.
 - ♦ The equipment has not worked well or you can not get it work according to User's Manual.
 - ♦ The equipment was dropped and damaged.
 - ♦ The equipment has obvious signs of breakage.
11. Never pour any liquid into the opening that could damage the equipment or cause an electrical shock.
 12. Do not leave the equipment in an unconditioned environment with a storage temperature of 60°C (140°F) or above, which may damage the equipment.
 13. To prevent explosion caused by improper battery replacement, use the same or equivalent type of battery recommended by the manufacturer only.



WEEE Statement

(English) Under the European Union ("EU") Directive on Waste Electrical and Electronic Equipment, Directive 2002/96/EC, which takes effect on August 13, 2005, products of "electrical and electronic equipment" cannot be discarded as municipal waste anymore and manufacturers of covered electronic equipment will be obligated to take back such products at the end of their useful life.

(Deutsch) Gemäß der Richtlinie 2002/96/EG über Elektro- und Elektronik-Altgeräte dürfen Elektro- und Elektronik-Altgeräte nicht mehr als kommunale Abfälle entsorgt werden, die sich auf 13. August, 2005 wirken. Und der Hersteller von bedeckt Elektronik-Altgeräte gesetzlich zur gebrachten Produkte am Ende seines Baruchbarkeitsdauer zurückzunehmen.

(Français) Au sujet de la directive européenne (EU) relative aux déchets des équipement électriques et électroniques, directive 2002/96/EC, prenant effet le 13 août 2005, que les produits électriques et électroniques ne peuvent être déposés dans les décharges ou tout simplement mis à la poubelle. Les fabricants de ces équipements seront obligés de récupérer certains produits en fin de vie.

(Русский) В соответствии с директивой Европейского Союза (ЕС) по предотвращению загрязнения окружающей среды использованным электрическим и электронным оборудованием (директива WEEE 2002/96/EC), вступающей в силу 13 августа 2005 года, изделия, относящиеся к электрическому и электронному оборудованию, не могут

расматриваться как бытовой мусор, поэтому производители вышеперечисленного электронного оборудования обязаны принимать его для переработки по окончании срока службы.

(Español) Bajo la directiva 2002/96/EC de la Unión Europea en materia de desechos y/o equipos electrónicos, con fecha de rigor desde el 13 de agosto de 2005, los productos clasificados como "eléctricos y equipos electrónicos" no pueden ser depositados en los contenedores habituales de su municipio, los fabricantes de equipos electrónicos, están obligados a hacerse cargo de dichos productos al termino de su período de vida.

(Nederlands) De richtlijn van de Europese Unie (EU) met betrekking tot Vervuiling van Elektrische en Electronische producten (2002/96/EC), die op 13 Augustus 2005 in zal gaan kunnen niet meer beschouwd worden als vervuiling. Fabrikanten van dit soort producten worden verplicht om producten retour te nemen aan het eind van hun levenscyclus..

(Srpski) Po Direktivi Evropske unije ("EU") o odbačenoj eelektronskoj i električnoj opremi, Direktiva 2002/96/EC, koja stupa na snagu od 13. Avgusta 2005, proizvodi koji spadaju pod "elektronsku i električnu opremu" ne mogu više biti odbačeni kao običan otpad i proizvođači ove opreme biće prinuđeni da uzmu natrag ove proizvode na kraju njihovog uobičajenog veka trajanja.

(Polski) Zgodnie z Dyrektywą Unii Europejskiej ("UE") dotyczącą odpadów produktów elektrycznych i elektronicznych (Dyrektywa 2002/96/EC), która wchodzi w życie 13 sierpnia 2005, tzw. "produkty oraz wyposażenie elektryczne i elektroniczne " nie mogą być traktowane jako śmieci komunalne, tak więc producenci tych produktów będą zobowiązani do odbierania ich w

momencie gdy produkt jest wycofywany z użycia.

(TÜRKÇE) Avrupa Birliği (AB) Kararnamesi Elektrik ve Elektronik Malzeme Atığı, 2002/96/EC Kararnamesi altında 13 Ağustos 2005 tarihinden itibaren geçerli olmak üzere, elektrikli ve elektronik malzemeler diğer atıklar gibi çöpe atılmayacak ve bu elektronik cihazların üreticileri, cihazların kullanım süreleri bittikten sonra ürünleri geri toplamakla yükümlü olacaktır.

(ČESKY) Podle směrnice Evropské unie ("EU") o likvidaci elektrických a elektronických výrobků 2002/96/EC platné od 13. srpna 2005 je zakázáno likvidovat "elektrické a elektronické výrobky" v běžném komunálním odpadu a výrobci elektronických výrobků, na které se tato směrnice vztahuje, budou povinni odebírat takové výrobky zpět po skončení jejich životnosti.

(MAGYAR) Az Európai Unió („EU”) 2005. augusztus 13-án hatályba lépő, az elektromos és elektronikus berendezések hulladékairól szóló 2002/96/EK irányelve szerint az elektromos és elektronikus berendezések többé nem kezelhetők lakossági hulladékként, és az ilyen elektronikus berendezések gyártói köteleessé válnak az ilyen termékek visszavételére azok hasznos élettartama végén.

(Italiano) In base alla Direttiva dell'Unione Europea (EU) sullo Smaltimento dei Materiali Elettrici ed Elettronici, Direttiva 2002/96/EC in vigore dal 13 Agosto 2005, prodotti appartenenti alla categoria dei Materiali Elettrici ed Elettronici non possono più essere eliminati come rifiuti municipali: i produttori di detti materiali saranno obbligati a ritirare ogni prodotto alla fine del suo ciclo di vita..

Trademarks

All trademarks are the properties of their respective owners.

- Microsoft is a registered trademark of Microsoft Corporation. Windows®98/ME, 2000/XP are registered trademarks of Microsoft Corporation.
- Sempron™ and Turion™ are registered trademarks of AMD in the United States and other countries.
- AMI® is a registered trademark of American Megatrends Inc.
- PCMCIA and CardBus are registered trademarks of the Personal Notebook Memory Card International Association.

Release History

Version	Revision Note	Date
1.0	Initial Release	December, 2005
1.2	Production Release	February, 2006

Table of Contents

Preface

Regulations Information	II
FCC-B Radio Frequency Interference Statement	II
FCC Conditions	III
Safety Guideline for Using Lithium Battery.....	IV
Caution on Using Modem	V
Optical Disc Drive Notice	V
Macrovision Notice	VI
Safety Instructions.....	VI
WEEE Statement	VIII
Trademarks	XI
Release History.....	XI

Introductions

How to Use This Manual	1-2
Unpacking	1-4

Getting Started

Specification	2-2
Product View	2-6
Top-open View	2-6
Front View	2-9
Right-side View	2-11
Left-side View	2-13
Rear View	2-14
Bottom View	2-15
Power Management	2-16
AC Adapter	2-16
Battery Pack	2-18
Using the Battery Pack	2-21
Memory Module Installation	2-23
Installing Memory Module Process	2-23
Basic Operations	2-27
Safety and Comfort Tips	2-27
Have a Good Work Habit	2-28
Knowing the Keyboard	2-29
Knowing the Touchpad	2-34
About Hard Disk Drive	2-38
Using the Optical Disc Drive	2-39

Customizing this Notebook

Connecting the External Devices	3-2
Connecting the Peripheral Devices	3-3
Connecting the Communication Devices	3-6
PC Card Installation	3-7
Installing the PC card	3-7
Removing the PC card	3-8
Express Card Installation	3-9
Installing the Express card	3-9
Removing the Express card	3-9
Safely Remove Hardware	3-10

BIOS Setup

About BIOS Setup	4-2
When to Use BIOS Setup	4-2
How to Run BIOS Setup	4-2
Control Keys	4-3
BIOS Setup Menu	4-4
Main menu	4-5
Advanced menu	4-7
Boot menu	4-9
Security menu	4-10
Exit menu	4-12

Preface

Chapter 1

General Introductions

Chapter 2

Getting Started

Chapter 3

Customizing this Notebook

Chapter 4

BIOS Setup



Congratulations on your purchase of an Averatec notebook. We are proud to tell our customers that this notebook has been thoroughly tested and certified for unsurpassed dependability, quality and customer satisfaction.

How to Use This Manual

This User's Manual provides instructions and illustrations on how to operate your notebook. It is recommended to read this manual carefully before using the notebook.

Chapter 1. General Introductions. includes the descriptions of all accessories included with the notebook. It is recommended to check that you have received all of the accessories when you first open the packing box. If any item is damaged or missing, please contact the store or reseller where you purchased this notebook.

Chapter 2. Getting Started. provides the specifications of the notebook, and introduces the function buttons, quick launch buttons, connectors, LEDs and the basic operations of using this notebook. This chapter also includes the correct procedure of installing and uninstalling the battery pack.

Chapter 3. Customizing your Notebook, includes instructions on connecting accessories external to the notebook, including: mice, keyboard, webcam, printer, external monitor, IEEE 1394 (FireWire) devices, and communication devices. Also included are installation and removal instructions for third-party PC card devices.

Chapter 4. BIOS setup, provides information on the BIOS Setup program that allows you to configure your notebook for optimum use.

Unpacking

Unpack the shipping carton and check all items carefully. If any item is damaged or missing, please contact the store or reseller that you bought the notebook from immediately. Keep the box and all packing materials in case you need to ship the unit in the future.

The shipping carton should contain the following items:

- ◆ Notebook computer
- ◆ Quick Start Guide
- ◆ Phoenix Recovery Brochure
- ◆ High-capacity Li-ion battery pack
- ◆ AC adapter and power cord

These accessories listed above may change without notice.

Preface

Chapter 1

General Introductions

Chapter 2

Getting Started

Chapter 3

Customizing this Notebook

Chapter 4

BIOS Setup



Specifications

Physical Characteristic	
Dimension	15.5"(L) x 10.9"(D) x 1" ~ 1.37"(H)
Weight	approx. 7.2 lbs.
CPU	
Processor Type	754-pin (uPGA)
Support Processor	Mobile Turion 64 25/35W series, Sempron 25W series model dependent
L1 Cache	128K (Turion); 64K (Sempron)
L2 Cache	Turion: 512KB/1MB Sempron: 128/256KB model dependent
FSB Speed	800MHz Double Clock
Socket	Socket N (754-pin)
Smart Power Management	AMD Power Now
Core Chips	
North Bridge	ATI RS482M
South Bridge	ATI SB450 (ATI RADEON Xpress 200M)
Memory	
Technology	DDR 333/400
Memory	DDR SO-DIMM X 2 slot, supports 128/256/512/1024MB DDR333 SO-DIMM PC2700
Maximum	2GB (1G DDR SO-DIMM X 2)
Power	

AC Adapter	90W, 19 Volt
Battery Pack	6 cells standard - 4400MAH
RTC Battery	Yes, 3 years
Storage	
HDD form factor	2.5mm(H), 80/100GB UDMA 100 [4200 & 5400 rpm - model dependent]
Optical Device	Dual Layer DVD Burner
I/O Port	
Monitor	DB 15-PIN External VGA CRT/LCD
USB	x 3 (USB version 2.0)
Line-in	x 1
Mic-in	x 1
Headphone/SPDIF Out	x 1 (SPDIF-Out supported)
RJ11	x 1
RJ45	x 1
IEEE FIREWIRE	1394 Firewire x 1
TV-Out	x 1 (S-Video)
Communication Port	
56K Fax/MODEM	MD560LMI-2 (AZALIA I/F)
LAN	10/100/1000 Gigabit
Wireless LAN	IEEE 802.11b/g MSI 6833(B)
CARD SLOTS	
PC Express	x 1
PCMCIA	Type II x 1

Memory Cards	5-in-1 Card Reader (xD/MS/MS PRO/MMC/SD)
Display	
LCD Type	17" WXGA +/- WSXGA+ with <i>AveraBrite™</i>
Video	
Controller	ATI RS482M
VRAM	128MB shared video memory
LCD Support	1800 x 1440, 32 bit color 1600 x 1200, 32 bit color 1440 x 900, 32 bit color – native resolution 1400 x 1050, 32 bit color 1280 x 1024, 32 bit color 1152 x 1768, 32 bit color 1024 x 768, 32 bit color 800 x 600, 32 bit color 640 x 480, 32 bit color
Audio	
Sound Controller	ATI SB450 (AZALIA)
Sound Codec chip	Realtek ALC882H
Internal Speaker	2 Speakers
SoundBlaster	SoundBlaster compatible (No DOS support)
Software & BIOS	
Support OS	Win XP Home, Professional and Media Center Editions

BIOS	Fast Boot Support --- Yes (Win XP)
Security	
Kensington Lock Hole	x 1

Product Overview

This section provides you with the description of all the basic aspects of your Notebook. It will help you to know more about your Notebook before using it.

Top-open View

Press the Cover Latch to open the top cover (LCD Panel). The top-open view and descriptions follow below.

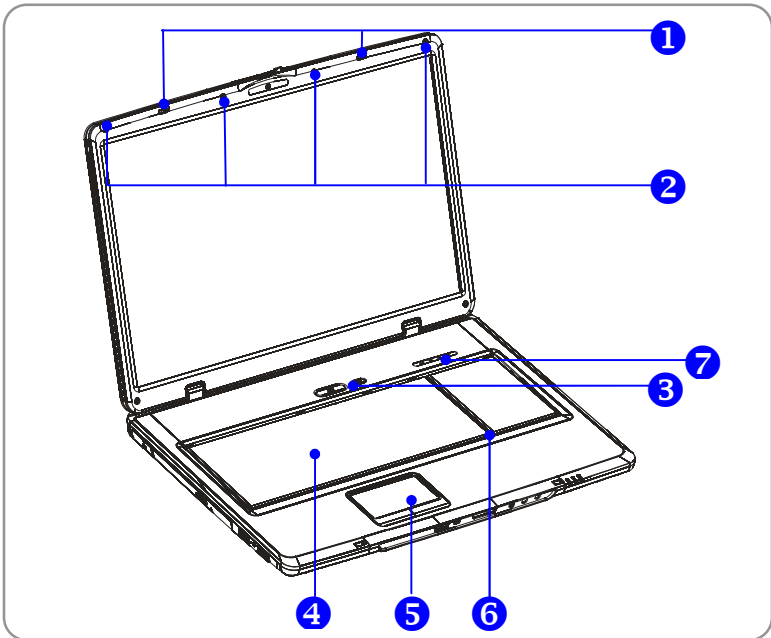

- 1. Cover Latch**

This latch will lock the LCD cover with the main system when closing your Notebook PC.

- 2. Rubber Pads**

Protects your Notebook PC when closing the LCD cover.

- 3. Power Button**



Power Button: To turn your Notebook power ON and OFF.

- 4. Keyboard**

The built-in keyboard provides all the functions of a full-sized 103-key (US-defined) keyboard.





- 5. Touchpad**

It is the pointing device of the computer.

- 6. Internal Microphone**

This is the built-in microphone.

7. Status LED's

	Num Lock: Glowing Blue when the Num Lock function is activated.
	Caps Lock: Glowing Blue when the Caps Lock function is activated.
	Scroll Lock: Glowing Blue when the Scroll Lock function is activated.
	Hard Disk In-use: Glowing Blue when the Notebook PC is accessing the hard disk drive.

Front View

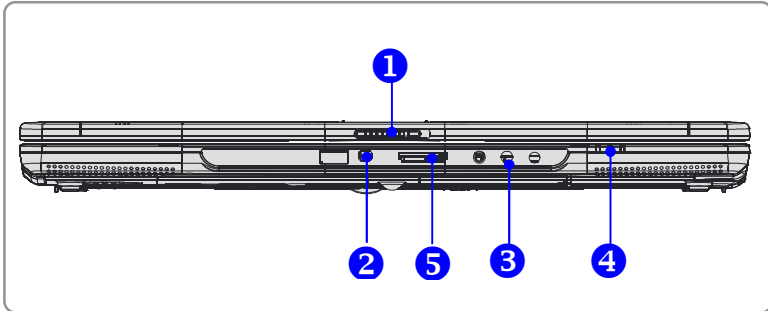

1. Cover Latch (External View)

Press Cover Latch to the right and lift the cover.

2. IEEE 1394 FIREWIRE



The IEEE 1394 FireWire port is a high-speed bus that allows you to connect high-end digital devices such as digital video cameras, camcorders, etc. for high speed file transfer.

3. Audio Port Connectors

Supports high quality stereo Hi-Fi sound

		Headphones: A connector for external speakers or headphones.
		Line In: Used for an external audio device.
		Microphone: Used to connect an external microphone.

4. Status LED

	<p>Battery: Glowing Green when recharging.</p> <p>Battery LED goes out when recharging is complete or when the AC adapter is disconnected.</p> <p>Glowing Orange when the battery is in low battery status.</p> <p>Blinking Orange if the battery is no longer operating correctly and needs to be replaced.</p>
	<p>Power On/ Off/ Suspend: Blinking Red when the system is in suspend mode; LED goes off when the system is activated and in the On mode, and turned off.</p>
	<p>1. Wireless LAN: 1.Glowing Green when the wireless LAN function is enabled. LED goes out when wireless LAN function is disabled.</p>

5. 5 in 1 Memory Card Reader

The built-in card reader supports MMC (multi-media card), MS (memory stick) , MS Pro, SD and xD memory cards.

Right-side View

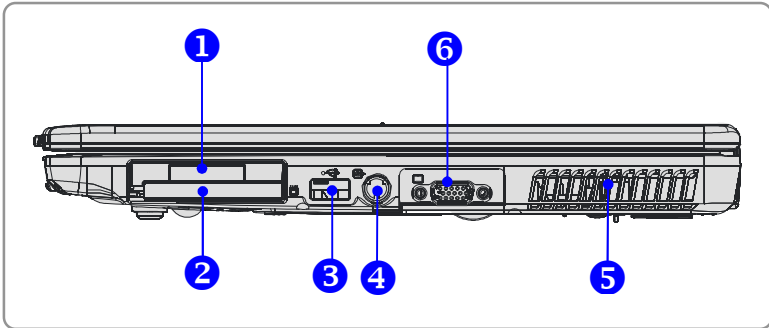

1. Express Card Slot

The computer provides an Express Card slot. The new Express Card interface is smaller and faster than the PC Card (PCMCIA) interface. The Express Card technology takes advantage of the scalable, high-bandwidth serial PCI Express and USB 2.0 interfaces.

2. PC Card Slot (PCMCIA)

The computer provides a PC card slot to support one Type-II PC card for expansion functions, such as LAN/WLAN, WWAN/WMAX, EVDO/Edge, memory card, etc.

3. USB Port

The USB 2.0 port allows you to connect USB-interface peripheral devices, such as external mouse, keyboard, portable hard disk drive, printer and more.

4. S-Video Connector

By using a Super VHS (S-Video) cable, this connector allows you to connect a television (NTSC/PAL system) to use as a computer display.

5. System Vents

The system vents are designed to cool the system. DO NOT block the ventilator as this blocks air circulation.

6. External CRT/VGA Port

The 15-pin D sub VGA port allows you to connect an external CRT monitor, or LCD other standard VGA-compatible device (such as a projector).

Left-side View

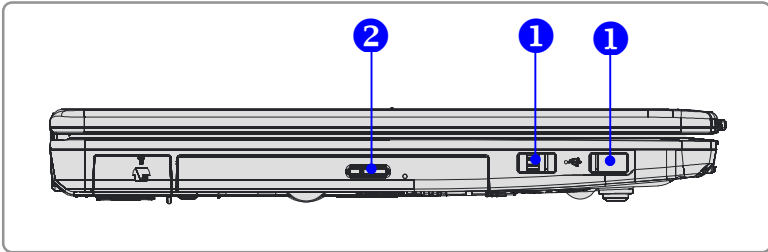

1. USB Ports

The USB 2.0 port allows you to connect USB-interface peripheral devices, such as external mouse, keyboard, portable hard disk drives, printer and more.

2. Optical Disc Drive

This notebook supports a CD/DVD+/-RW with Dual Layer burning. The optical device allows you to use a CD/DVD disc for installing software, accessing data and playing music and movies on the computer.

Rear View

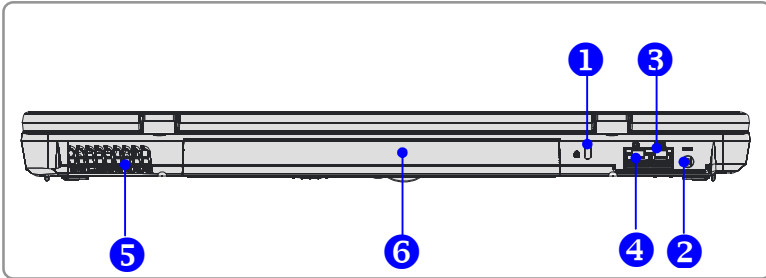

1. Kensington Lock

This port is used to lock the computer to a specific location with a cable that supports the Kensington lock.

2. Power Connector

Connects the AC adapter and external power to the computer.

3. RJ-11 Connector

The computer provides a built-in modem that allows you to connect a telephone line through this connector. Use the RJ-11 connector and the 56K V.90 modem to make a dial-up connection.

4. RJ-45 Connector

The 10/100/1000 Ethernet Gigabit connector is used to connect a LAN cable for network connection.

5. Vent Ports

The vent ports are designed to cool the system. DO NOT block these.

6. Battery Pack (Rear View)

To supply power to computer when the AC adapter is not connected.

Bottom View

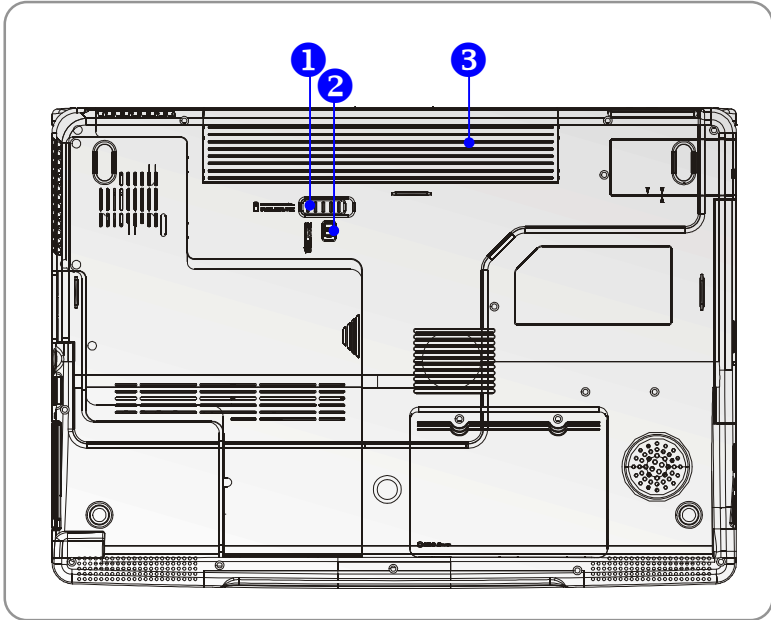

1. Battery Release Lever

The battery release lever is used to remove the battery pack from the system. Press the lever with one hand and pull the battery pack out carefully with the other hand.

2. Battery Lock/Unlock Switch

The battery cannot be removed when the switch is positioned in the locked position. Once the switch is moved to the unlocked position, the battery is removable.

3. Battery Pack

Supplies power to your computer when the AC adapter is not connected.

Power Management

AC Adapter

Please note that it is strongly recommended to connect the AC adapter and use the AC power while using your Notebook for the first time. When the AC adapter is connected, the battery will be charging immediately.

Note that the AC adapter included in the package is approved for your Notebook; using a different AC adapter may damage the Notebook or other devices connected to the notebook.

Connecting the AC Power

1. Unpack the package to find the AC adapter and power cord.
2. Attach the power cord to the connector of the AC adapter.
3. Plug the DC end of the adapter to the Notebook, and the male end of the power cord to the electrical outlet.

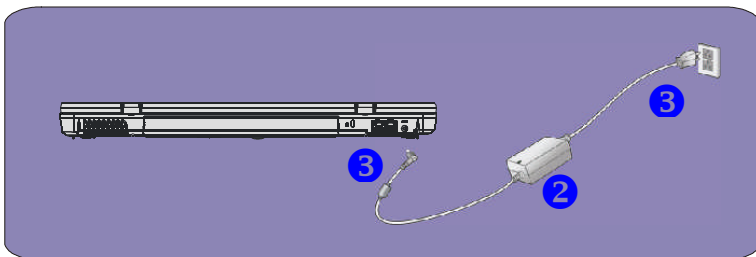

Disconnecting the AC Power

When you disconnect the AC adapter, you should:

1. Unplug the power cord from the electrical outlet first.
2. Unplug the connector from the Notebook.
3. Disconnect the power cord and the connector of AC adapter.
4. When unplugging the power cord, always hold the connector part of the cord. Never pull the cord directly!

Battery Pack

This Notebook is equipped with a high-capacity Li-ion Battery pack. The rechargeable Li-ion battery pack provides internal power source of the Notebook. A fully charged battery pack can supply power to the Notebook approximately up to 2 hours. Battery life will vary depending on your usage.

Removing the Battery Pack

1. Make sure the computer is turned off.
2. Check that the Lock/Unlock Lever is in the Unlocked position.
3. Locate the Battery Release Switch on the bottom side.
4. Push the Release Switch in the direction of arrow the showing below the button.
5. Slide the left side of the battery pack first out of the compartment and then pull out the right side of the battery pack.

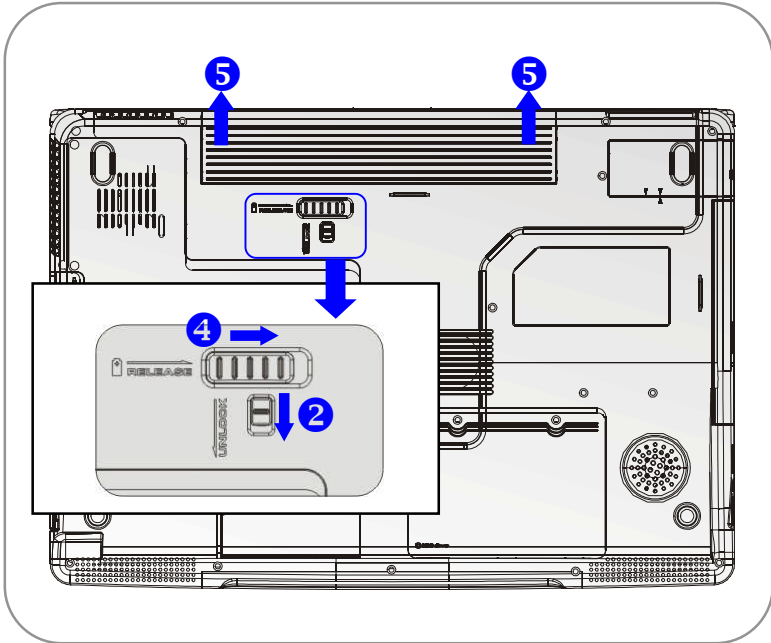

Replacing the Battery Pack

1. Insert the right side of battery pack into the compartment.
2. Slightly slide and press the battery pack into place.
3. After the right side of the battery pack fits into the right track, then slightly press the left side of battery pack into the battery chamber.
4. Make sure the Lock/Unlock Switch is in the Locked position.

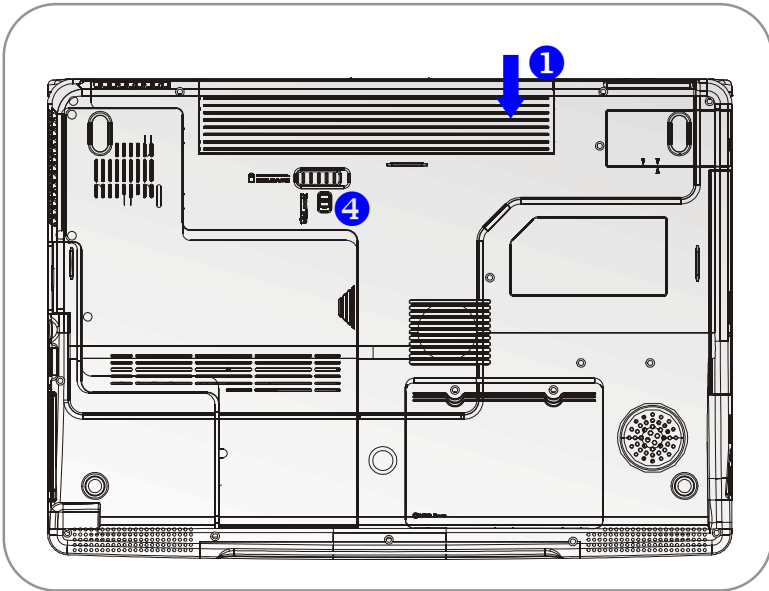

info

Warning

1. Do not try to disassemble THE BATTERY PACK.
2. Please follow your local laws and regulations to recycle the battery pack.

Using the Battery Pack

Battery Safety Tips

Replacing or handling the battery incorrectly may present a risk of fire or explosion, which could cause serious injury.

- ◆ Only replace the main battery pack with the same or equivalent type of battery.
- ◆ Do not disassemble, short-circuit or incinerate batteries or store them to temperatures above +60° C (+140° F).
- ◆ Do not tamper with batteries. Keep them away from children.
- ◆ Do not use rusty or damaged batteries.
- ◆ Dispose of batteries according to local regulations. Check with your local solid waste officials for details about recycling options or for proper disposal in your area.

Conserving Battery Power

Efficient battery power is critical to maintain a normal operation. If the battery power is not managed well, the saved data and customized settings may be lost.

Follow these tips to help optimize battery life and avoid a sudden power loss:

- ◆ Suspend system operation if the system will be idle for a while or shorten the Suspend Timer's time to activate period.
- ◆ Turn off the system if you won't be using it for a period of time.
- ◆ Disable unneeded settings or remove idle peripherals to conserve power.
- ◆ Connect an AC adapter to the system whenever possible.

Charging the Battery Pack

The battery pack can be recharged while it is installed in the Notebook. Please pay attention to the following tips before recharging the battery:

- ◆ If a charged battery pack is not available, save your work and close all running programs and shut down the system or Save-to-Disk.
- ◆ Plug in the external AC power adapter.
- ◆ You can use the system, suspend system operation or shut down and turn off the system without interrupting the charging process.
- ◆ The battery pack uses Lithium-ion battery cells that have no “memory effect.” You do not need to discharge the battery pack before you begin charging. However, to optimize the life of battery, we suggest that consuming the battery power completely once a month is necessary.
- ◆ If you do not use the Notebook for a long time, it is suggested to remove the battery pack from your Notebook. This may be helpful to extend your batteries life.
- ◆ The actual charging time will be determined by the applications in use.

Memory Module Installation

1. Memory Module Compartment

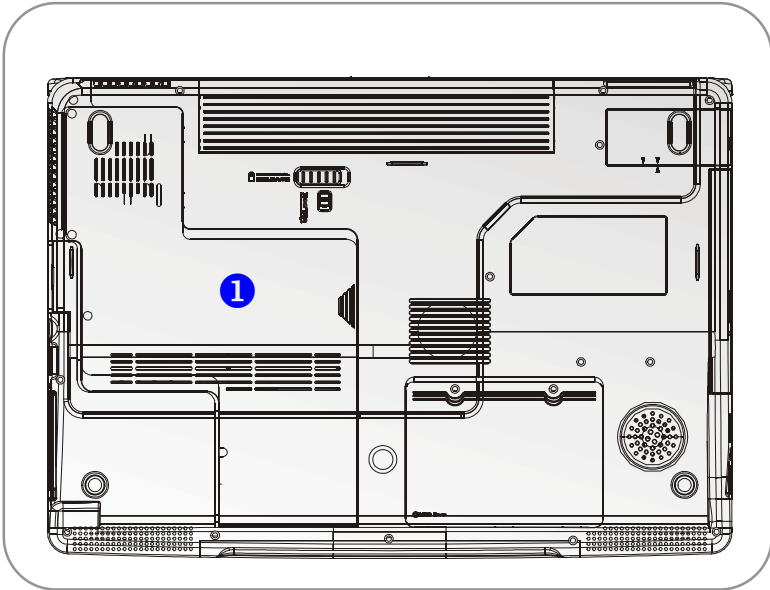

Installing Memory module process

1. Align the memory module in the DIMM socket. There are 2 DIMM sockets on the system motherboard.

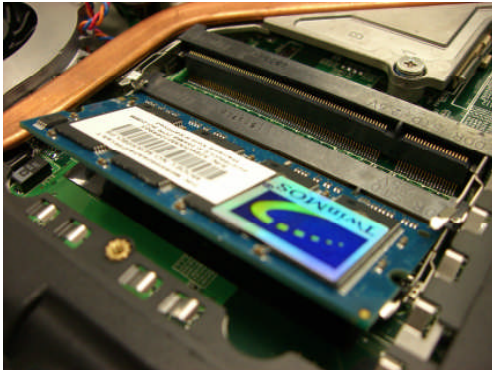

info

Warning

The memory module can only fit in one direction due to the keyed notch. Wrong orientation will cause improper installation and may damage the memory module or DIMM socket.

-
2. Gently push down on the memory module until the metal-locking levers on each side of the DIMM socket is fastened.



3. If you have more than one memory module, align the 2nd memory module to the empty DIMM socket.



4. Gently push down on the memory module until the metal-locking levers on each side of the DIMM socket is fastened.

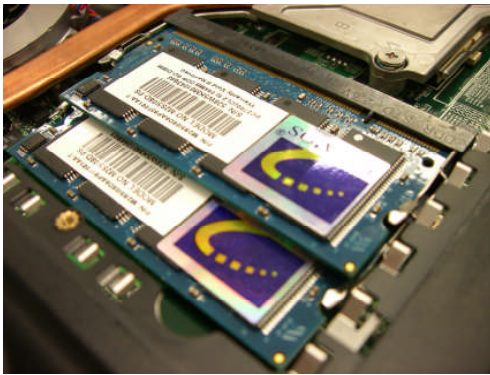

Basic Operations

If you are a beginner to Notebooks, please read the following tips to make yourself safe and comfortable during the operations.

Safety and Comfort Tips

The Notebook is a portable computing platform that allows you to work anywhere. However, choosing a good workspace is important if you have to work with your Notebook for long periods of time.

- ◆ Your work area should have enough illumination.
- ◆ Choose the proper desk and chair and adjust their height to fit your posture when operating.
- ◆ When sitting on a chair, adjust the chair's back (if available) to support your back comfortably.
- ◆ Place your feet flat and naturally on the floor, so that your knees and elbows have the proper position (about 90-degree) when operating.
- ◆ Put your hands on the desk naturally to support your wrists.
- ◆ Adjust the angle/position of the LCD panel, so that you have the optimal view.
- ◆ Avoid using your Notebook in a space where it may cause you discomfort.
- ◆ The Notebook is an electrical device, please treat it with great care to avoid personal injury.

Please keep the following tips in mind when operating.

- ◆ Change your posture frequently.
- ◆ Stretch and exercise you body regularly.
- ◆ Remember to take breaks after working for a period of time.

Knowing the Keyboard

The Notebook's keyboard provides all the functions of a full-sized 103-key keyboard and the additional **Fn** keys for specific functions on the Notebook.

The keyboard can be divided into four categories: **Typewriter keys**, **Cursor keys**, **Numeric keys** and **Function keys**.

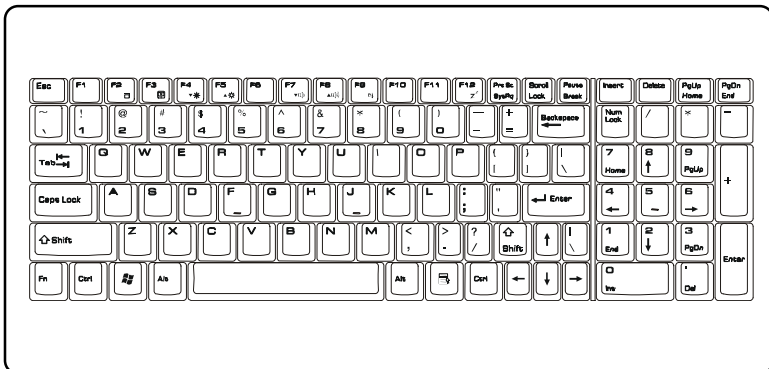

Typewriter Keys

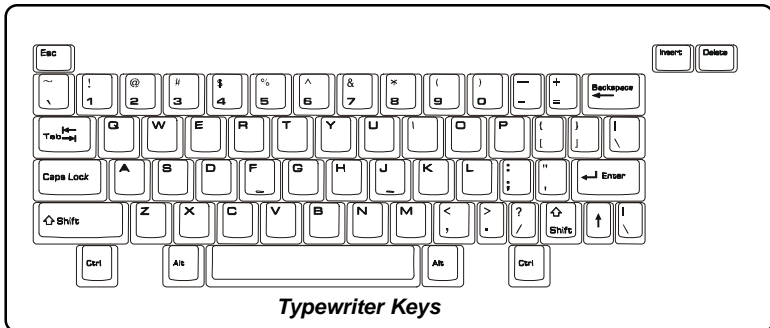

The function of the Typewriter keys is the major function of the keyboard, which is similar to the keys on a typewriter. It also provides several keys for special purposes, such as the [Ctrl], [Alt] and [Esc] key.







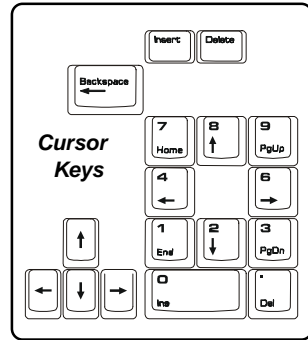

When the “lock keys” are pressed, the corresponding LED’s will light up to indicate their status:

- **Num Lock:** Press and hold the [Fn] key and press the Num Lock key to toggle the Num Lock on and off. When this function is activated, you can use the numeric keys that are included in the numeric keypad.
- **Caps Lock:** Press this key to toggle the Caps Lock on and off. When this function is activated, the letters you type are kept in uppercase.
- **Scroll Lock:** Press and hold the [Fn] key and press the Scroll Lock key to toggle the Scroll Lock on and off. This function is defined by individual programs, and it is usually used under DOS.



Cursor Keys

The keyboard provides four cursor (arrow) keys and [Home], [PgUp], [PgDn], [End] keys at the lower right corner, which are used to control the cursor movement.



	Move the cursor left for one space.
	Move the cursor right for one space.
	Move the cursor up for one line.
	Move the cursor down for one line.
	Move to the previous page.
	Move to the next page.
	Move to the beginning of the line (or document).
	Move to the end of the line (or document).

The Backspace key, [Ins] and [Del] keys at upper right corner are typically used for editing purposes.

	This key is used to switch the typing mode between “insert” and “overwrite” modes.
	Press this key to delete one character to the right of the cursor and move the following text left for one space.
	Press this key to delete one character to the left of the cursor and move the following text left for one space.

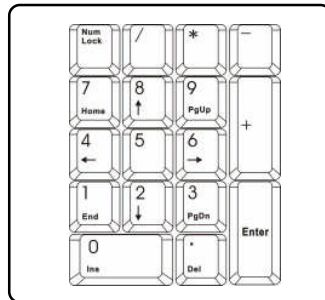

Numeric Keys

The keyboard provides a dedicated numeric keypad. When the Num Lock is activated, you can use these numeric keys to enter numbers and calculations. Otherwise, they are used to control cursor movement.







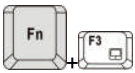

Function Keys

■ Windows Keys

You can find the Windows Logo key () and Application Logo key () on the keyboard, which are used to perform Windows-specific functions, such as launching the Start and shortcut menus. For more information on these two keys, please refer to your Windows manual or online help.

■ [Fn] Key

	Switch the display output mode between the LCD, external monitor or Both.
	Disable/enable Touchpad.
	Decrease the LCD brightness.
	Increase the LCD brightness.
	Decrease the built-in speaker's volume.
	Increase the built-in speaker's volume.
	Disable the Notebook's audio function.
	Force the Notebook into suspend mode (depending on the system configuration).

Knowing the Touchpad

The integrated touchpad in your Notebook is a pointing device that is compatible with standard mouse, allowing you to control the Notebook by pointing the location of the cursor on the screen and making selections with its two buttons.

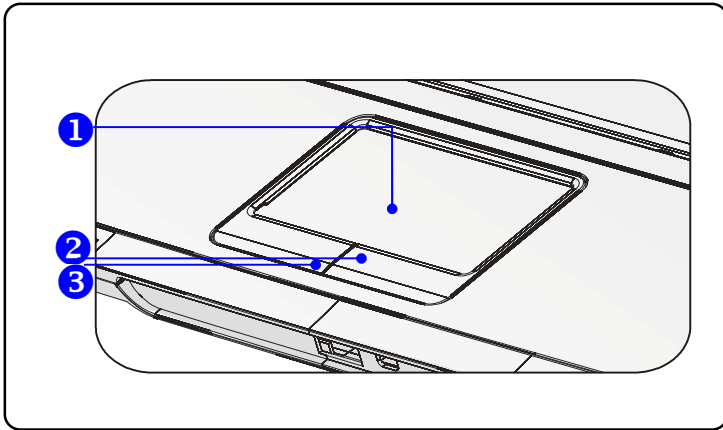

1. Cursor Movement Area

This pressure-sensitive area of the touchpad, allows you to place your finger on it and control the cursor on the screen by moving your finger.

2. Right Button

Acts as the mouse's right button.

3. Left Button

Acts as the mouse's left button.

Using the Touchpad

Read the following description to learn how to use the touchpad:

■ **Positioning and Moving**

Place your finger on the touchpad (usually using the forefinger), and the rectangular pad will act as a miniature duplicate of your display. When you move your fingertip across the pad, the cursor on the screen will move simultaneously in the same direction. When your finger reaches the edge of the pad, lift your finger and replace it on a proper location of the touchpad.

■ **Point and Click**

When you have moved and placed the cursor over an icon, a menu item or a command that you want to execute, simply tap slightly on the touchpad or press the left button to select. This procedure, called point and click, is the basics of operating your Notebook. Unlike the traditional pointing device such as the mouse, the whole touchpad can act as a left button, so that each tap on the touchpad is equivalent to pressing the left button. Tapping twice more rapidly on the touchpad is to execute a double-click.

■ **Drag and Drop**

You can move files or objects in your Notebook by using drag-and-drop. To do so, place the cursor on the desired item and slightly tap twice on the touchpad, and then keep your fingertip in contact with the touchpad on the second tap. Now, you can drag the selected item to the desired location by moving your finger on the touchpad, and then lift your finger from the touchpad to drop the item into place. Alternately, you can press and hold the left button when you select an item, and then move your finger to the

desired location; finally, release the left button to finish the drag-and-drop operation.

■ Configuring the Touchpad

You can customize the pointing device to meet your personal needs. For example, if you are a left-hand user, you may want to swap the functions of the two buttons. In addition, you can change the size, shape, moving speed and other advanced features of the cursor on the screen.

To configure the touchpad, you can use the standard Microsoft or IBM PS/2 driver in your Windows operating system. The **Mouse Properties** in **Control Panel** allow you to change the configuration. If you prefer to use an external mouse, Use the [Fn] + F2 keys to disable the cursor.



About The Hard Disk Drive

Your Notebook is equipped with a high-speed 2.5-inch IDE (Integrated Drive Electronics) hard disk drive. The hard disk drive is a storage device with much higher speed and larger capacity than other storage devices, such as a floppy disk drive and optical storage devices. It is used to install the operating system and software applications.



info

1. To avoid unexpected data loss in your system, please backup your critical files regularly.
2. Do not turn off the Notebook when the Hard Disk In-use LED is on.
3. Do not remove or install the hard disk drive when the Notebook is turned on. The replacement of the hard disk drive should only be done by an authorized retailer or service representative.

Using the Optical Disc Drive

Your Notebook is equipped with an optical storage device, which is known as the DVD Dual Layer drive.

- **DVD Dual Drive:** A dual format recorder, allows you to record both the +R DL, -R/RW and +R/RW formats. It also supports: CD-RW, CD-R, CD, DVD formats.



info

1. The optical storage device is classified as a Class 1 Laser product. Use of controls or adjustments or performance of procedures other than those specified here in may result in hazardous radiation exposure.
2. Do not touch the lens inside the drive.

Inserting a CD/DVD

The following describes the general procedure when operating the optical disc drive.

1. Confirm that the Notebook is turned on.
2. Press the Eject Button on the drive's panel and the CD tray will slide out partially. Then, gently pull the tray out until fully extended.
3. Place your CD in the tray with its label facing up. Slightly press the center of the CD to secure it into place.
4. Push the tray back into the drive.

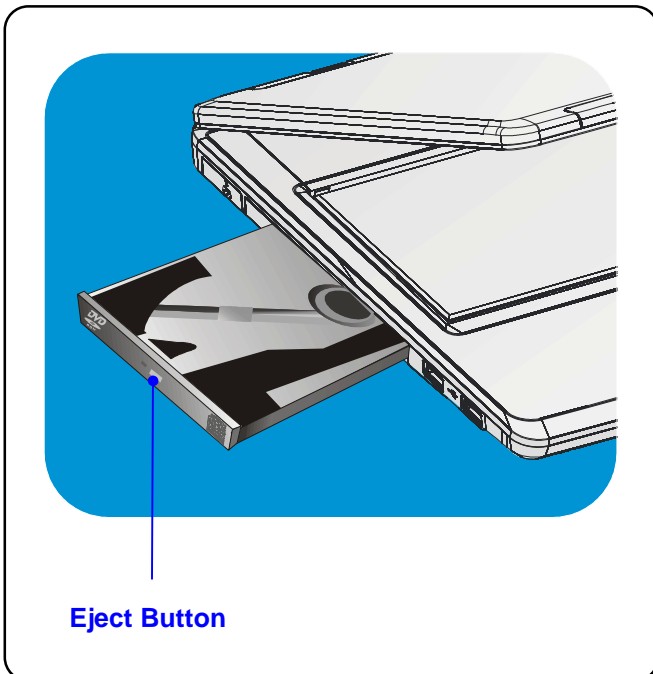

Removing the CD

1. Press the Eject Button on the drive's panel and the CD tray will slide out partially. Then, gently pull the tray out until fully extended.
2. Hold the CD by its edge with your fingers and lift it up from the tray.
3. Push the tray back into the drive.



info

1. Confirm that the CD is placed correctly and securely in the tray before closing the tray.
2. Do not leave the CD tray open.

Preface

Chapter 1

General Introductions

Chapter 2

Getting Started

Chapter 3

Customizing this Notebook

Chapter 4

BIOS Setup



Connecting External Devices

The I/O (input/output) ports on the Notebook allow you to connect peripheral devices.

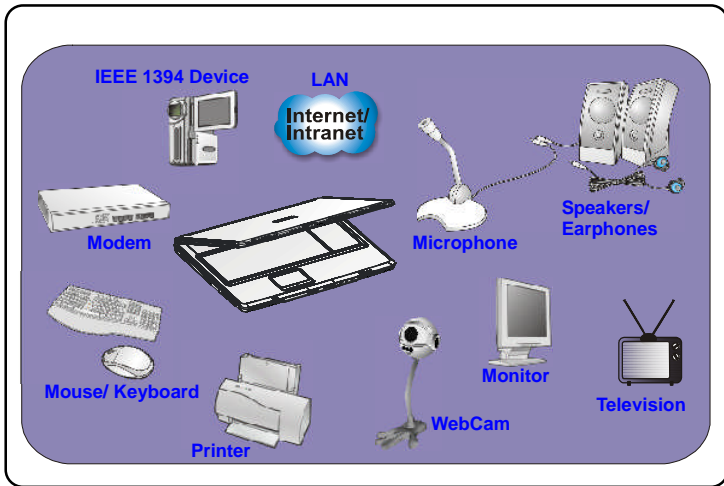

Connecting Peripheral Devices

Connecting an External Mouse

You can connect an external mouse to your Notebook through the USB port. Since there is no PS/2 port available on your Notebook, and you only have a mouse with a PS/2 connector, please purchase a PS/2-USB connector first. To connect the mouse:

8. Turn on the Notebook and install the mouse driver.
9. Connect your mouse to the Notebook.
10. The Notebook may auto detect your mouse driver and enable the mouse function. If there is no detection of you mouse you can manually enable the mouse by going to **Start Menu → Control Panel → Add Hardware** to add the new device.

Connecting an External Keyboard

You can connect an external keyboard to your Notebook through the USB port. Since there is no PS/2 port available on your Notebook, and you only have a keyboard with a PS/2 connector, please purchase a PS/2-USB connector first. To connect the keyboard:

1. Turn on the Notebook and install the keyboard driver.
2. Connect your keyboard to the Notebook.
3. The Notebook may auto detect your keyboard driver and enable the keyboard function. If there is no detection of you keyboard you can manually enable the keyboard by going to **Start Menu → Control Panel → Add Hardware** to add the new device.

Connecting a WebCam

You can connect a WebCam to your Notebook through the USB port:

1. Turn on the Notebook and install the WebCam driver.
2. Connect your WebCam to the Notebook.
3. The Notebook may auto detect your WebCam driver and enable the WebCam function. If there is no detection of your WebCam you can manually enable the WebCam by going to **Start Menu → Control Panel → Add Hardware** to add the new device.

Connecting a Printer

If your printer has a USB interface, you can then use the USB port on the Notebook to connect the printer. The following instruction describes the general procedure to connect a printer:

1. Turn off the Notebook.
2. Connect one end of the printer cable to the Notebook's USB port and the other end to the printer.
3. Connect the power cord and turn on the printer.
4. Turn on the Notebook and the system will detect the new device. Install the required driver.

For further instructions, please refer to your printer's manual.

Connecting an External Monitor or TV

You can connect an external monitor to your Notebook through the external VGA port for a larger view with higher resolution. To connect the monitor:

1. Make sure that the Notebook is turned off.
2. Plug the monitor's D-type connector into the Notebook's VGA port.
3. Connect the monitor's power cord and turn on the monitor.
4. Turn on the Notebook and the monitor should respond by default. If not, you can switch the display mode by pressing **[Fn]+[F2]**. Alternately, you can change the display mode by configuring the settings in **Display Properties** of Windows operating system.

Connecting IEEE 1394 Firewire devices

The IEEE 1394 port of your Notebook is a next-generation serial bus that features a high-speed transfer rate and the connection of up to 63 devices, allowing you to connect many high-end peripheral devices and consumer electronic appliances, such as digital video cameras and digital camcorders.

The IEEE 1394 standard interface supports "**plug-and-play**" technology, so that you can connect and remove the IEEE 1394 devices without turning off the Notebook. To connect the IEEE 1394 device, simply connect the cable of the device to the IEEE 1394 port of your Notebook.

Connecting Communication Devices

Using a LAN

The RJ-45 connector of the Notebook allows you to connect LAN (local area network) devices, such as a hub, switch and gateway, to build a network connection. The built-in 10/100/1000 Gigabit LAN module supports data transfer rate up to 1000Mbps.

For more instructions or detailed steps on connecting to the LAN, please ask your MIS staff or network manager for help.

Using the Built-in Modem

The built-in 56Kbps fax/data modem allows you to use a telephone line to communicate with others or to connect the Internet.

For more instructions or detailed steps on dialing-up through the modem, please consult your MIS staff or Internet service provider (ISP) for help.



info

1. To reduce the risk of fire, use only No. 26 AWG or larger telecommunication cable.

PC (PCMCIA) Card Installation

The PC card slot of your Notebook allows you to install comprehensive Type-II PC cards that support various functions including: LAN/WLAN /WWAN, memory cards, etc.

The following instruction provides you with a basic installation for the PC card, including how to install and remove it. For more information, please refer to the manual of your PC card.

Installing the PC card

1. Locate the PC card slot on your Notebook. If there is a dummy card in the slot, remove it first.
2. Insert the PC card into the slot (usually with its label facing up) and push it until it is firmly in place.

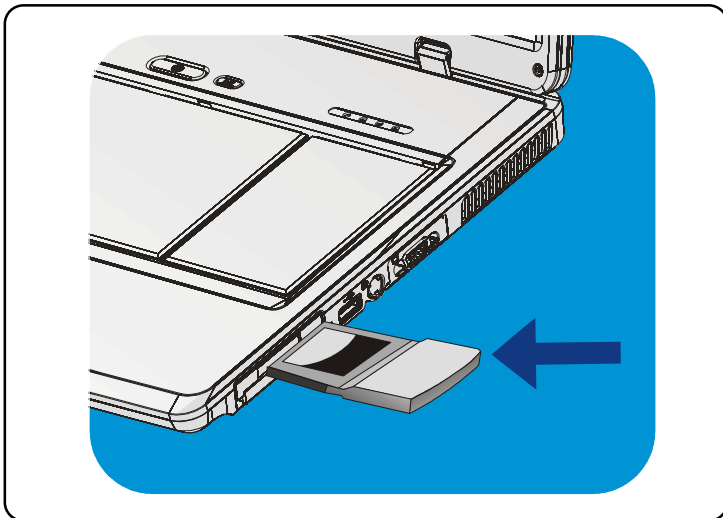

Removing the PCMCIA Card

1. Press the Eject Button to make it stretch out.
2. Push the Eject Button and the PC card will slide out. Pull it out of the slot.

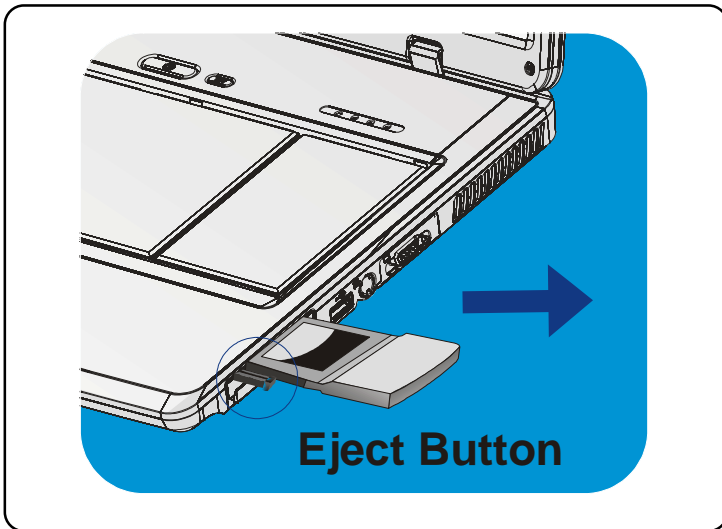

info

1. Before removing the PC card, you should stop the device in the Windows operating system.

PC Express Card Installation

This computer provides a PC Express Card slot. The new PC Express Card interface is smaller and faster than the PC (PCMCIA) Card interface. The PC Express Card technology takes advantage of the scalable, high-bandwidth serial PCI Express and USB 2.0 interfaces.

The following instructions provide you with a basic installation for the PC Express Card, including how to install and remove it. For more information, please refer to the manual of your PC Express Card.

Installing the PC Express Card

1. Locate the PC Express Card slot on your Notebook. If there is a dummy card in the slot, remove it first.
2. Insert the PC Express Card into the slot (usually with its label facing up) and push it until it is firmly in place.

Removing the PC Express Card

1. Press the Eject Button to make it stretch out.
2. Pull the Express card out of the slot.

Safely Remove Hardware

If you connect any peripheral device to your system, the **Safely Remove Hardware** icon () will appear on the taskbar. Double-click the icon to bring up the Safely Remove Hardware dialog box. You can see all connected peripheral devices here. If you want to remove any of the devices, move the cursor to the device, select on that device and click **Stop**.

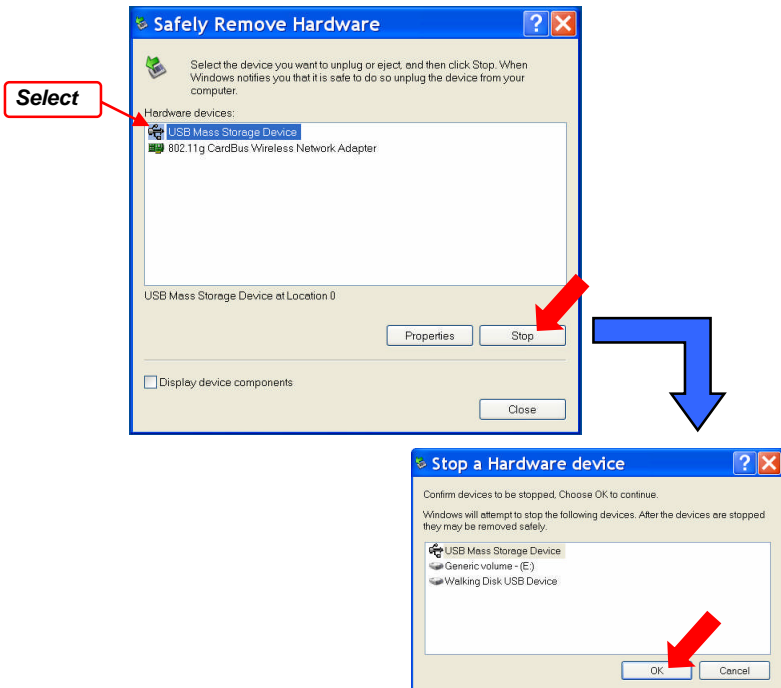

	Preface
Chapter 1	General Introductions
Chapter 2	Getting Started
Chapter 3	Customizing this Notebook
Chapter 4	BIOS Setup



About BIOS Setup

When to Use BIOS Setup?

You may need to run the BIOS Setup when:

- ♦ An error message appears on the screen during the system boot up and requests you to run SETUP.
- ♦ You want to change the default settings for customized features.
- ♦ You want to reload the default BIOS settings.

How to Run BIOS Setup?











To run the BIOS Setup Utility, turn on the Notebook and press the [Del] key during the POST procedure. If the message disappears before you respond and you still wish to enter Setup, restart the system by turning it OFF and ON, or simultaneously pressing [Ctrl]+[Alt]+[Delete] keys to restart.

info

The screen snapshots and setting options in this chapter are for your reference only. The actual screen settings and options on your Notebook may be different because of a BIOS update.

Control Keys

You can use only the keyboard to control the cursor in the BIOS Setup Utility.

	Press left arrow to select one menu title.
	Press right arrow to select one menu title.
	Press up arrow to select one item under the menu title.
	Press down arrow to select one item under the menu title.
	Increase the setting value or make changes.
	Decrease the setting value or make changes.
	<ol style="list-style-type: none"> 1) Open the selected item to change setting options. 2) Bring up a sub-menu when available.
	In some items, press this key to change setting field.
	Brings up help screen that provides information on the control keys.
	<ol style="list-style-type: none"> 1) Exit the BIOS Setup Utility. 2) Return to the previous screen in a sub-menu.

BIOS Setup Menu

Once you enter the BIOS Setup Utility, the Main menu will appear on the screen. The Main menu displays the system information, including the basic configuration.

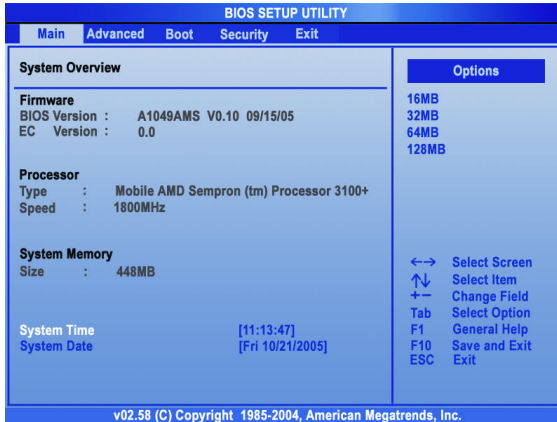

Main menu

Shows System Overview information about the BIOS version, CPU features, Memory size and setting of System Time and Date.

Advanced menu

Configure IDE and USB settings.

Boot menu

Set up Boot Type and Boot Sequence.

Security menu

Install or clear Supervisor's and User's Password settings.

Exit menu

Choose decided status before leaving the BIOS menu.

Main menu

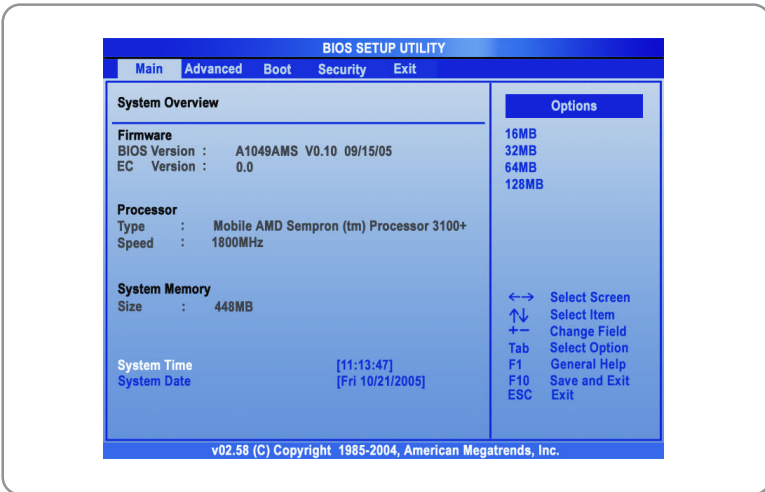

System Overview

System Overview will show you the BIOS version and other information about its build date and update notes. Following this is CPU information about its Type and Speed.

System Time

This item allows you to set the system time. The system clock will go on no matter if you shut down the PC or go into sleep mode. The set format is [hour:minute:second].

System Date

This item allows you to set the system date. The date format is [day:month:date:year].

- Day** Day of the week, from Sun to Sat, which is determined by BIOS (read-only).
- Month** The month from 01 (January) to 12 (December).
- Date** The date from 01 to 31.
- Year** The year can be adjusted by users.

Advanced menu

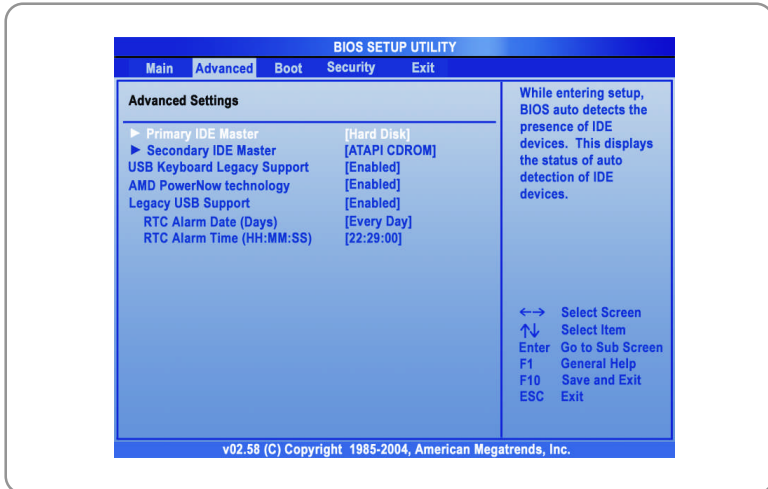

Advanced Settings

Primary/Secondary IDE Master

These items display the types of the primary/secondary master IDE devices installed in the Notebook. Press [Enter] to bring up a window showing the detailed information of the device, including the device name, vendor, LBA mode, PIO mode and more.

AMD PowerNow Technology

This item allows you to enable or disable AMD PowerNow technology. When set to Enabled, the system always operates in a conserve power mode. If you want to optimize the processor, set this item to Disabled, so that the processor's speed will vary depending on the use of your operating system and applications. Default setting is set to **Enabled**.

Legacy USB Support

If you want to use an external USB device, like a mouse, keyboard or portable disk, in a Non-Windows environment, or boot your system with an external USB device, you should enable this function by selecting **Enabled**.

Boot menu

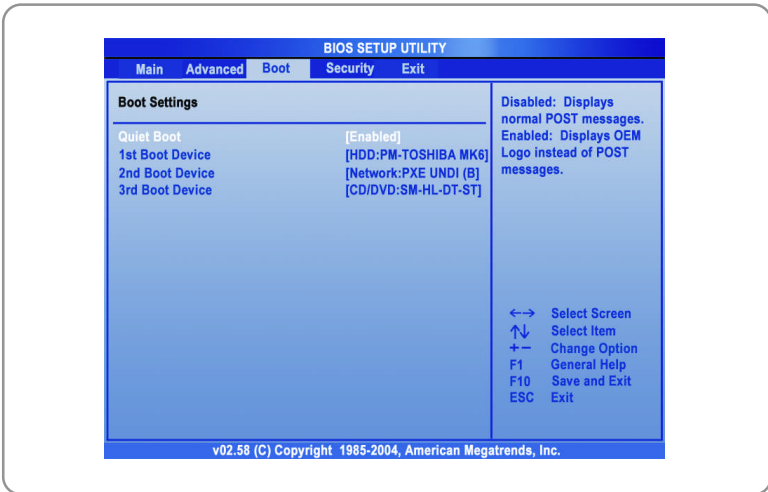

Quiet Boot

This item enables you to show the Averatec logo on the boot-up screen. Settings options: **Disabled** and **Enabled**. The default setting is **Enabled**.

1st, 2nd and 3rd Boot Device

The three items allow you to set the sequence of boot devices where BIOS attempts to load the disk operating system.

Security menu

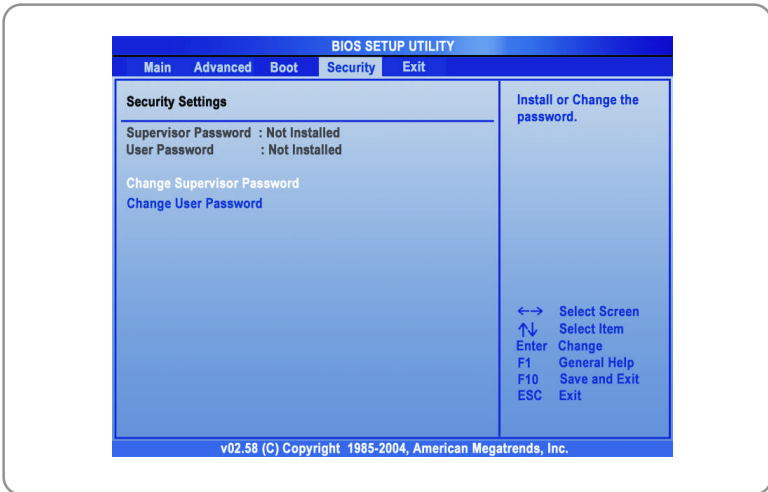

Security Settings

Change Supervisor/User Password

When you select this function, a message box will appear on the screen as below:

Enter New Password

Type the password *you* want, up to six characters in length and press [Enter]. The password typed now will replace any previously set password from CMOS memory. You may also press [ESC] to abort the selection and not enter a password.

When the Supervisor Password is set, the new items **User Access Level** and **Password Check** will be added in the menu. You can define further access settings rights in the **User Access Level** item. Setting options: **No Access**, **View Only**, **Limited** and **Full Access**. The Password Check item is used to specify the type of BIOS password protection that is implemented. Settings are described below:

Setup	The password prompt appears only when end users try to run Setup.
Always	A password prompt appears every time when the Notebook is powered on or when end users try to run Setup.

To clear a set password, just press **[Enter]** when you are prompted to enter the password. A message box will show up confirming the password will be disabled. Once the password is disabled, the system will boot and you can enter Setup without entering any password.

info

About Supervisor Password and User Password

Supervisor Password allows the user to enter and change the settings of the setup menu; User Password only allows the user to enter the setup menu, but doesn't have the right to make changes.

Exit menu

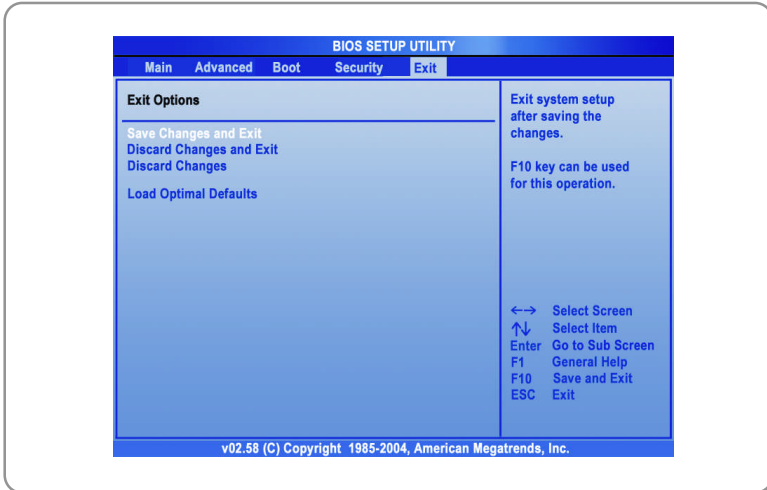

Save Changes and Exit

Save the changes you have made and exit the utility.

Discard Changes and Exit

Exit the utility without saving the changes you have made.

Discard Changes

Abandon your changes and reload the previous configuration before running the utility.

Load Optimal Defaults

Select this item to load the default settings for optimal system performance.

Free Manuals Download Website

<http://myh66.com>

<http://usermanuals.us>

<http://www.somanuals.com>

<http://www.4manuals.cc>

<http://www.manual-lib.com>

<http://www.404manual.com>

<http://www.luxmanual.com>

<http://aubethermostatmanual.com>

Golf course search by state

<http://golfingnear.com>

Email search by domain

<http://emailbydomain.com>

Auto manuals search

<http://auto.somanuals.com>

TV manuals search

<http://tv.somanuals.com>